

## STUDIO MONITOR

# RSM-90

## Owner's Manual

Before using this unit, carefully read the sections entitled: "USING THE UNIT SAFELY" and "IMPORTANT NOTES" (Owner's Manual p. 2, p. 3). These sections provide important information concerning the proper operation of the unit. Additionally, in order to feel assured that you have gained a good grasp of every feature provided by your new unit, Owner's Manual should be read in its entirety. The manual should be saved and kept on hand as a convenient reference.

## Features

The Roland Studio Monitor RSM-90 speaker system was designed, developed, and manufactured in the United States. The high-quality sound these studio monitors deliver make them perfect for mixing duties in digital recording studios.

### 2-Way Speakers with Superior Sound Quality

To achieve such high-quality sound, the low-frequency driver uses a 160-mm polypropylene foam cone, and the high-frequency driver features a dome tweeter with a high-precision face plate.

### 3/4" MDF Cabinets with 1" MDF Baffles

Cabinet construction prevents excess vibration, which greatly improves sound quality.

\* MDF = Middle Density Fiberboard

### Bi-Wiring Connections

Bi-wiring reduces problems (intermodulation distortion) caused by the effect the high-frequency and low-frequency drivers have on each other.

### Gold-Plated Post Connectors

Gold plating provides long-lasting protection for the connectors, preventing degradation of sound quality over time. Additionally, the binding post connectors are compatible with heavy-gauge speaker cables.

### Magnetically Shielded Low- and High-Frequency Drivers

This allows you to use the speakers next to CRT displays.

### Front-Facing Bass Reflex Ports



These ports ensure consistent low-end sound regardless of placement.



Copyright © 2000 ROLAND CORPORATION

All rights reserved. No part of this publication may be reproduced in any form without the written permission of ROLAND CORPORATION.







# USING THE UNIT SAFELY

## INSTRUCTIONS FOR THE PREVENTION OF FIRE, ELECTRIC SHOCK, OR INJURY TO PERSONS

About  WARNING and  CAUTION Notices







 <b>WARNING</b>	Used for instructions intended to alert the user to the risk of death or severe injury should the unit be used improperly.
 <b>CAUTION</b>	Used for instructions intended to alert the user to the risk of injury or material damage should the unit be used improperly. * Material damage refers to damage or other adverse effects caused with respect to the home and all its furnishings, as well to domestic animals or pets.







About the Symbols

	The  symbol alerts the user to important instructions or warnings. The specific meaning of the symbol is determined by the design contained within the triangle. In the case of the symbol at left, it is used for general cautions, warnings, or alerts to danger.
	The  symbol alerts the user to items that must never be carried out (are forbidden). The specific thing that must not be done is indicated by the design contained within the circle. In the case of the symbol at left, it means that the unit must never be disassembled.
	The  symbol alerts the user to things that must be carried out. The specific thing that must be done is indicated by the design contained within the circle. In the case of the symbol at left, it means that the power-cord plug must be unplugged from the outlet.



### ALWAYS OBSERVE THE FOLLOWING



#### WARNING

- Before using this unit, make sure to read the instructions below, and the Owner's Manual. 
- Do not open or perform any internal modifications on the unit. 
- Do not attempt to repair the unit, or replace parts within it (except when this manual provides specific instructions directing you to do so). Refer all servicing to your retailer, the nearest Roland Service Center, or an authorized Roland distributor, as listed on the "Information" page. 
- Never use or store the unit in places that are:
  - Subject to temperature extremes (e.g., direct sunlight in an enclosed vehicle, near a heating duct, on top of heat-generating equipment); or are 
  - Damp (e.g., baths, washrooms, on wet floors); or are 
  - Humid; or are
  - Exposed to rain; or are
  - Dusty; or are
  - Subject to high levels of vibration.
- Make sure you always have the unit placed so it is level and sure to remain stable. Never place it on stands that could wobble, or on inclined surfaces. 

- This unit combined with an amplifier may be capable of producing sound levels that could cause permanent hearing loss. Do not operate for a long period of time at a high volume level, or at a level that is uncomfortable. If you experience any hearing loss or ringing in the ears, you should immediately stop using the unit, and consult an audiologist. 
- Do not allow any objects (e.g., flammable material, coins, pins); or liquids of any kind (water, soft drinks, etc.) to penetrate the unit.   

- Immediately turn off the power of the device connected to this unit, and request servicing by your retailer, the nearest Roland Service Center, or an authorized Roland distributor, as listed on the "Information" page when:
  - Objects have fallen into, or liquid has been spilled onto the unit; or
  - The unit has been exposed to rain (or otherwise has become wet); or
  - The unit does not appear to operate normally or exhibits a marked change in performance.
- In households with small children, an adult should provide supervision until the child is capable of following all the rules essential for the safe operation of the unit. 
- Protect the unit from strong impact. (Do not drop it!) 

**CAUTION**

- Try to prevent cords and cables from becoming entangled. Also, all cords and cables should be placed so they are out of the reach of children. 
- Never climb on top of, nor place heavy objects on the unit. 

- Disconnect all cords coming from external devices before moving the unit. 
- Should you remove screws of input jacks and the short bar, make sure to put them in a safe place out of children's reach, so there is no chance of them being swallowed accidentally. 

# Important Notes

In addition to the items listed under "USING THE UNIT SAFELY" on page 2,3 please read and observe the following:

## Placement

- Do not expose the unit to direct sunlight, place it near devices that radiate heat, leave it inside an enclosed vehicle, or otherwise subject it to temperature extremes. Also, do not allow lighting devices that normally are used while their light source is very close to the unit (such as a piano light), or powerful spotlights to shine upon the same area of the unit for extended periods of time. Excessive heat can deform or discolor the unit.
- To avoid possible breakdown, do not use the unit in a wet area, such as an area exposed to rain or other moisture.
- Do not allow rubber, vinyl, or similar materials to remain on the unit for long periods of time. Such objects can discolor or otherwise harmfully affect the finish.
- Do not put anything that contains water (e.g., flower vases) on the unit. Also, avoid the use of insecticides, perfumes, alcohol, nail polish, spray cans, etc., near the unit. Swiftly wipe away any liquid that spills on the unit using a dry, soft cloth.

## Maintenance

- For everyday cleaning wipe the unit with a soft, dry cloth or one that has been slightly dampened with water. To remove stubborn dirt, use a cloth impregnated with a mild, non-abrasive detergent. Afterwards, be sure to wipe the unit thoroughly with a soft, dry cloth.
- Never use benzine, thinners, alcohol or solvents of any kind, to avoid the possibility of discoloration and/or deformation.

## Additional Precautions

- To avoid disturbing your neighbors, try to keep the unit's volume at reasonable levels (especially when it is late at night).
- When you need to transport the unit, package it in the box (including padding) that it came in, if possible. Otherwise, you will need to use equivalent packaging materials.

# Making the Connections

Connect the output connectors of your power amp to the RSM-90 input connectors with speaker cable.



Before connecting the speakers, confirm that the power is off on all connected devices. Also check to make sure that the power amp and mixer volume levels are turned down completely.

## Cautions

- Make sure to match the polarity (+, -) of the connectors.
- Avoid causing shorts when connecting the speaker cables. Also take care not to connect the cables incorrectly. Failure to follow these precautions may result in damage to your equipment.
- The screws and short bar on the input connectors are made to be removable. When you do remove these, be sure to store them in a secure place out of the reach of small children. Consult a physician or get other appropriate medical help immediately if any of these pieces is swallowed accidentally.
- With high-output power amps (100 W or above), touching the amp's input connectors may cause electric shock. Take care not to come into contact with the input connectors.
- These speakers have a rated impedance of 4 ohms. Confirm that the recommended load impedance of the power amp you are using is compatible.
- Do not connect any power amp with output higher than the maximum allowable input for these speakers. Failure to follow this precaution may result in damage to the equipment.
- Don't touch the diaphragm of the HF driver or the cone of the LF driver.

## Connections on the Speakers

Use the short bar on each speaker to bridge the speaker's high- and low-frequency "+" connectors (or "-" connectors), then connect the speakers to the power amp with speaker cable.

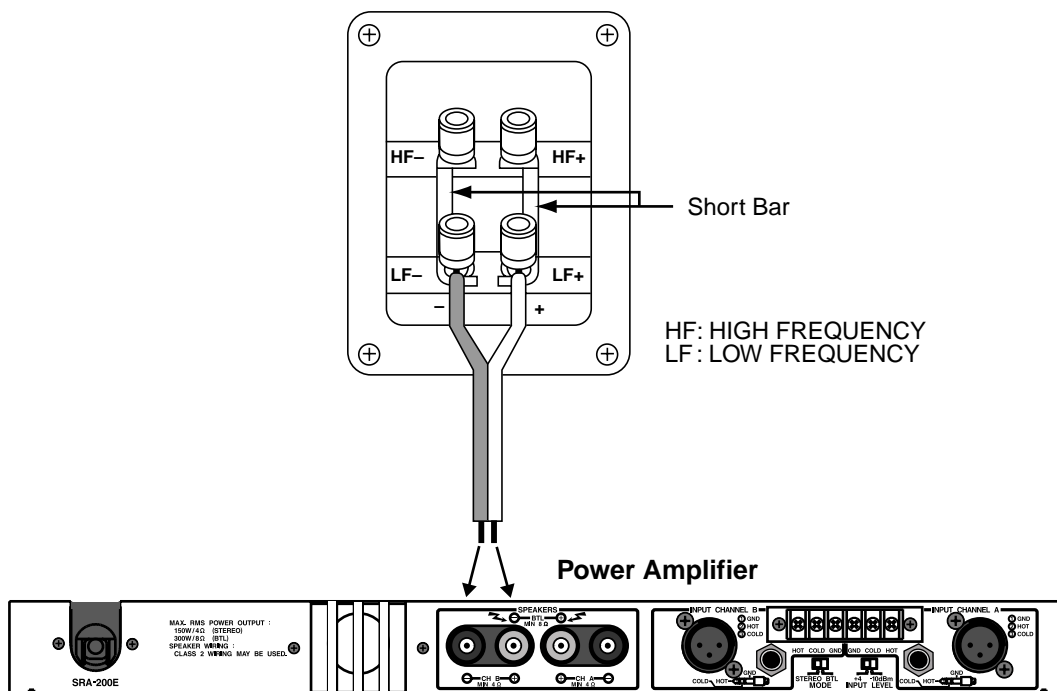

# Bi-Wiring Connections

Remove the short bar horizontally, then connect the power amp to each speaker using two sets of cables.

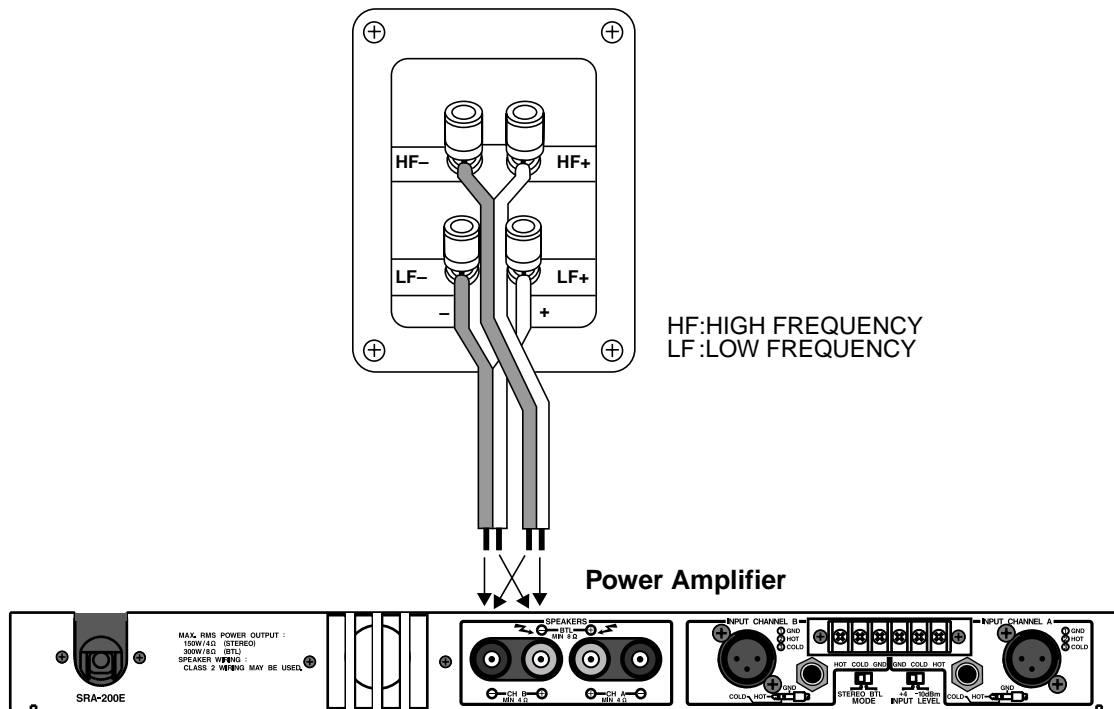

Bi-wiring is a method of connecting the power amp to the speakers using separate sets of speaker cables for the low- and high-frequency portions. Using separate cables for the low- and high-frequencies reduces intermodulation distortion, thus improving the high-end sonic quality.

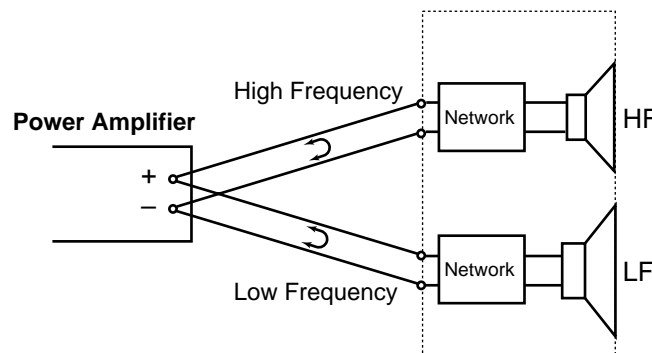

## Tips for High Quality Playback

- Think carefully beforehand to determine the optimum location for the speakers. To fully realize the speakers' excellent low-end reproduction capabilities, place the speakers on stands that will provide firm, stable support.
- Use bi-wiring connections to bring out the speakers' superior high-end response.
- To help ensure great sound, use high-quality, heavy-gauge speaker cables.

## Specification

### System

2 Way Monitor Speaker

### Enclosure

Bass-reflex type

### Cabinet

3/4" MDF, Baffle: 1" MDF

### LF Driver

160 mm (6-1/2") Foamed polypropylene cone type, magnetically shielded

### HF Driver

25 mm (1") Soft dome type, magnetically shielded

### Power Handling

rated: 90 W \*1

max: 270 W

\*1 EIA RS426A

### Frequency Response

62 Hz to 20 kHz (+/-3dB)

### Nominal Impedance

4 ohms

### Sensitivity(1W/1m)

88 dB

### Crossover Frequency

2.6 kHz

### Crossover Network

Advanced second order filter

### Connectors

Binding posts x 4 (LF input, HF input)

### Dimensions

228.6(W) x 322.3(D) x 371.5(H) mm

9(W) x 12-11/16(D) x 14-5/8(H) inches

### Weight

11 kg/24 lbs. 5 oz.

### Accessory

Owner's Manual

\* In the interest of product improvement, the specifications and/or appearance of this unit are subject to change without prior notice.

## Dimensions

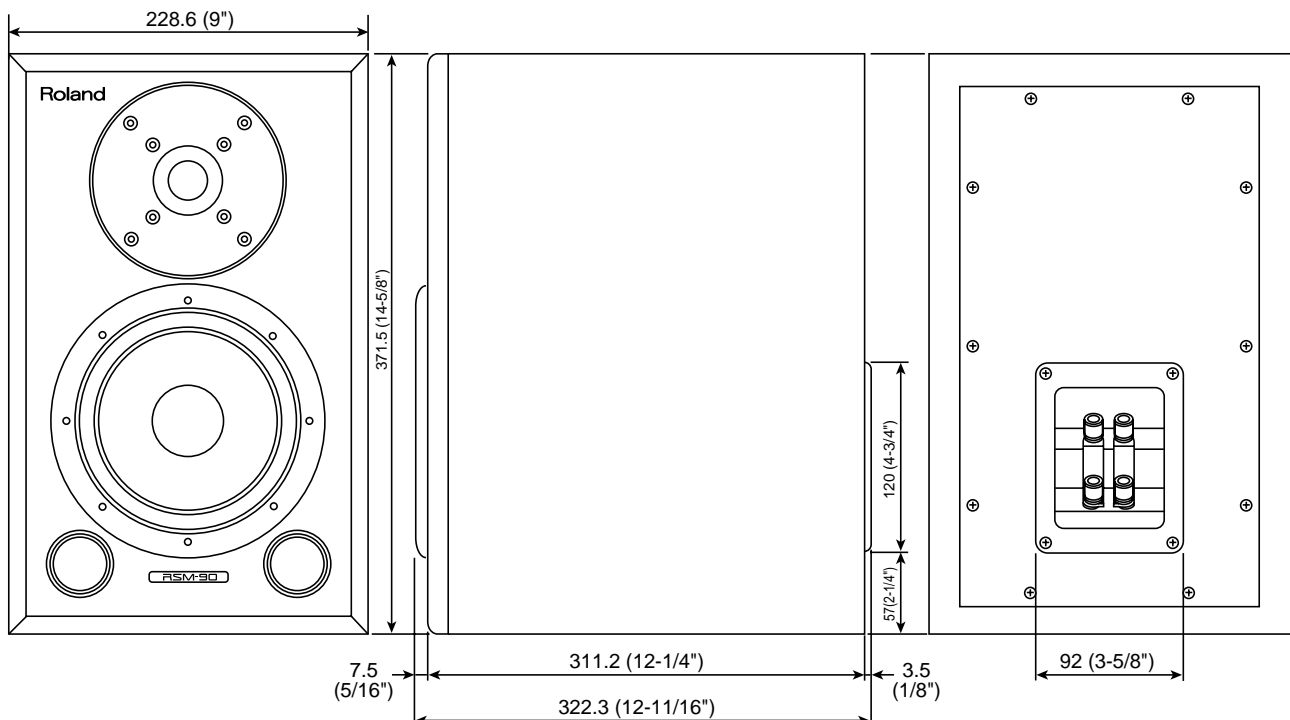

# Frequency Response

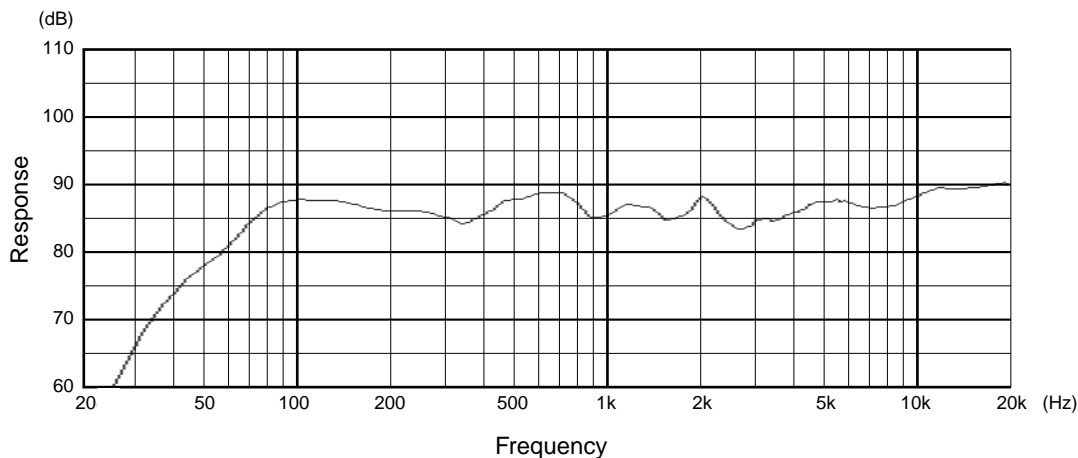

# Impedance

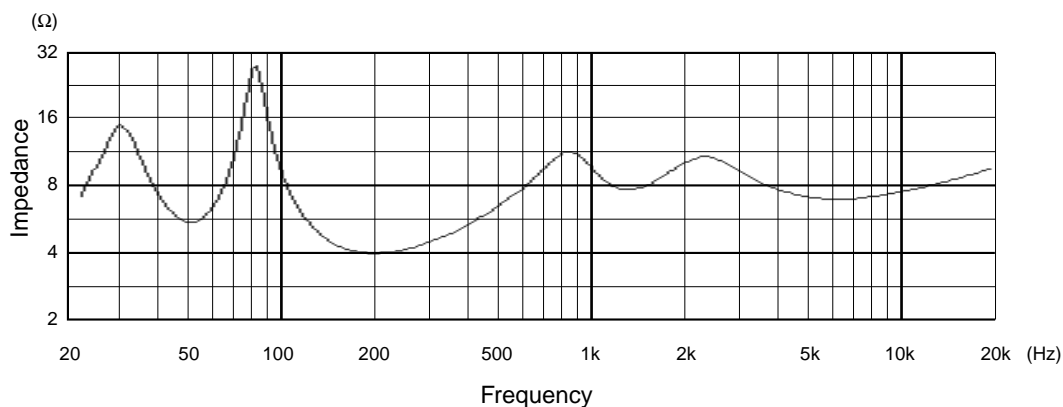

# Polar Response (Horizontal)

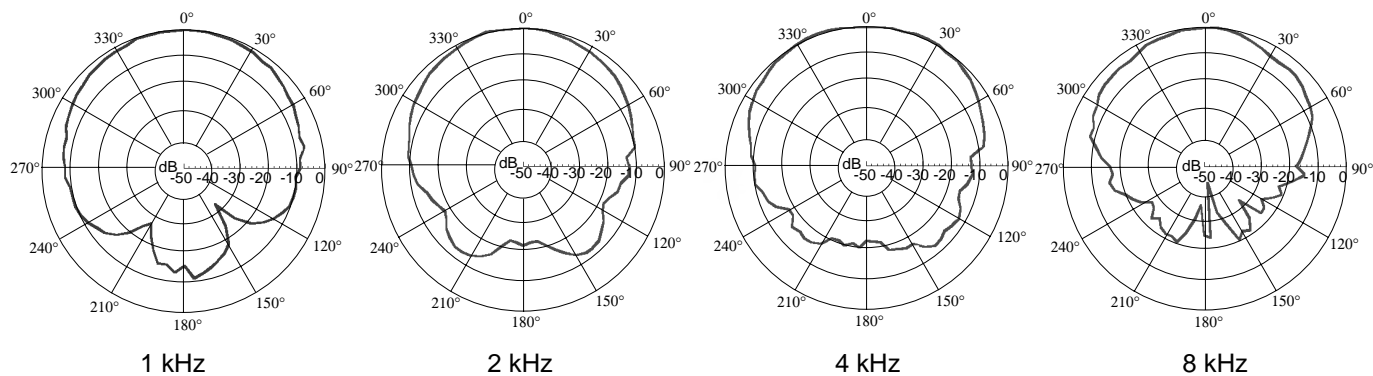

## Information

When you need repair service, call your nearest Roland Service Center or authorized Roland distributor in your country as shown below.

### AFRICA

#### EGYPT

**Al Fanny Trading Office**  
P.O. Box 2904,  
El Horrieh Heliopolos, Cairo,  
EGYPT  
TEL: (02) 4185531

#### REUNION

**Maison FO - YAM Marcel**  
25 Rue Jules Merman, ZL  
Chaudron - BP79 97491  
Ste Clotilde REUNION  
TEL: 28 29 16

#### SOUTH AFRICA

**That Other Music Shop (PTY) Ltd.**  
11 Melle Street (Cnr Melle and  
Juta Street)  
Braamfontein, 2001,  
Republic of SOUTH AFRICA  
TEL: (011) 403 4105

**Paul Bothner (PTY) Ltd.**  
17 Werdmuller Centre Claremont  
7700  
Republic of SOUTH AFRICA

P.O. Box 23032  
Claremont, Cape Town  
SOUTH AFRICA, 7735  
TEL: (021) 64 4030

### ASIA

#### CHINA

**Beijing Xinghai Musical  
Instruments Co., Ltd.**  
6 Huangmunchang Chao Yang  
District, Beijing, CHINA  
TEL: (010) 6774 7491

#### HONG KONG

**Tom Lee Music Co., Ltd.  
Service Division**  
22-32 Pun Shan Street, Tsuen  
Wan, New Territories,  
HONG KONG  
TEL: 2415 0911

#### INDIA

**Rivera Digitec (India) Pvt. Ltd.**  
409, Nirman Kendra Mahalaxmi  
Flats Compound Off. Dr. Edwin  
Moses Road, Mumbai-400011,  
INDIA  
TEL: (022) 498 3079

#### INDONESIA

**PT Citra IntiRama**  
Jl. Cideng Timur No. 15J-150  
Jakarta Pusat  
INDONESIA  
TEL: (021) 6324170

#### KOREA

**Cosmos Corporation**  
1461-9, Seocho-Dong,  
Seocho Ku, Seoul, KOREA  
TEL: (02) 3486-8855

#### MALAYSIA

**Bentley Music SDN BHD**  
140 & 142, Jalan Bukit Bintang  
55100 Kuala Lumpur, MALAYSIA  
TEL: (03) 2443333

#### PHILIPPINES

**G.A. Yupangco & Co. Inc.**  
339 Gil J. Puyat Avenue  
Makati, Metro Manila 1200,  
PHILIPPINES  
TEL: (02) 899 9801

#### SINGAPORE

**Swee Lee Company**  
150 Sims Drive,  
SINGAPORE 387381  
TEL: 748-1669

#### CRISTOFORI MUSIC PTE LTD

Blk 3014, Bedok Industrial Park E,  
#02-2148, SINGAPORE 489980  
TEL: 243 9555

#### TAIWAN

**ROLAND TAIWAN  
ENTERPRISE CO., LTD.**  
Room 5, 9fl. No. 112 Chung Shan  
N.Road Sec.2, Taipei, TAIWAN,  
R.O.C.  
TEL: (02) 2561 3339

#### THAILAND

**Theera Music Co., Ltd.**  
330 Vergn NakornKasem, Soi 2,  
Bangkok 10100, THAILAND  
TEL: (02) 2248821

#### VIETNAM

**Saigon Music**  
138 Tran Quang Khai St.,  
District 1  
Ho Chi Minh City  
VIETNAM  
TEL: (08) 844-4068

### AUSTRALIA/ NEW ZEALAND

#### AUSTRALIA

**Roland Corporation  
Australia Pty., Ltd.**  
38 Campbell Avenue  
Dee Why West. NSW 2099  
AUSTRALIA  
TEL: (02) 9982 8266

#### NEW ZEALAND

**Roland Corporation (NZ) Ltd.**  
97 Mt. Eden Road, Mt. Eden,  
Auckland 3, NEW ZEALAND  
TEL: (09) 3098 715

### CENTRAL/LATIN AMERICA

#### ARGENTINA

**Instrumentos Musicales S.A.**  
Florida 656 2nd Floor  
Office Number 206A  
Buenos Aires  
ARGENTINA, CP1005  
TEL: (54-11) 4- 393-6057

#### BRAZIL

**Roland Brasil Ltda.**  
R. Coronel Octaviano da Silveira  
203 05522-010  
Sao Paulo BRAZIL  
TEL: (011) 3743 9377

#### COSTA RICA

**JUAN Bansbach  
Instrumentos Musicales**  
Ave.1, Calle 11, Apartado 10237,  
San Jose, COSTA RICA  
TEL: (506)258-0211

#### CHILE

**Comercial Fancy S.A.**  
Avenida Rancagua #0330  
Providencia Santiago, CHILE  
TEL: 56-2-373-9100

#### EL SALVADOR

**OMNI MUSIC**  
75 Avenida Notre YY Alameda,  
Juan Pablo 2, No. 4010  
San Salvador, EL SALVADOR  
TEL: (503) 262-0788

#### MEXICO

**Casa Veerkamp, s.a. de c.v.**  
Av. Toluca No. 323, Col. Olivar  
de los Padres 01780 Mexico D.F.  
MEXICO  
TEL: (525) 668 04 80

**La Casa Wagner de  
Guadalajara s.a. de c.v.**  
Av. Corona No. 202 S.J.  
Guadalajara, Jalisco Mexico  
C.P.44100 MEXICO  
TEL: (3) 613 1414

#### PANAMA

**SUPRO MUNDIAL, S.A.**  
Boulevard Andrews, Albrook,  
Panama City,  
REP. DE PANAMA  
TEL: (507) 315-0101

#### PARAGUAY

**Distribuidora De  
Instrumentos Musicales**  
J.E. Oleary y ESQ. Manduvira  
Edeficio, El Dorado Planta Baja  
Asuncion PARAGUAY  
TEL: 595-21-492147

#### PERU

**VIDEO Broadcast S.A.**  
Portinari 199 (ESQ. HALS),  
San Borja, Lima 41,  
REP. OF PERU  
TEL: 51-14-758226

#### URUGUAY

**Todo Musica S.A.**  
Cuareim 1844, Montevideo,  
URUGUAY  
TEL: 5982-924-2335

#### VENEZUELA

**Musicaland Digital C.A.**  
Av. Francisco de Miranda,  
Centro Parque de Cristal, Nivel  
C2 Local 20 Caracas  
VENEZUELA  
TEL: (02) 285 9218

### EUROPE

#### AUSTRIA

**Roland Austria GES.M.B.H.**  
Siemensstrasse 4, P.O. Box 74,  
A-6063 RUM, AUSTRIA  
TEL: (0512) 26 44 260

#### BELGIUM/HOLLAND/ LUXEMBOURG

**Roland Benelux N. V.**  
Houtstraat 3, B-2260, Oevel  
(Westerlo) BELGIUM  
TEL: (039)16 57811

#### DENMARK

**Roland Scandinavia A/S**  
Nordhavnsvej 7, Postbox 880,  
DK-2100 Copenhagen  
DENMARK  
TEL: (039)16 6200

#### FRANCE

**Roland France SA**  
4, Rue Paul Henri SPAAK,  
Parc de l'Esplanade, F 77 462 St.  
Thibault, Lagny Cedex FRANCE  
TEL: 01 600 73 500

#### FINLAND

**Roland Scandinavia As,  
Filial Finland**  
Lauttasareentie 54 B  
Fin-00201 Helsinki, FINLAND  
TEL: (9) 682 4020

#### GERMANY

**Roland Elektronische  
Musikinstrumente HmbH.**  
Oststrasse 96, 22844 Norderstedt,  
GERMANY  
TEL: (040) 52 60090

#### GREECE

**STOLLAS S.A.**  
**Music Sound Light**  
155, New National Road  
26422 Patras, GREECE  
TEL: 061-435400

#### HUNGARY

**Intermusica Ltd.**  
Warehouse Area 'DEPO' Pf.83  
H-2046 Torokbalint, HUNGARY  
TEL: (23) 511011

#### IRELAND

**Roland Ireland**  
Audio House, Belmont Court,  
Donnybrook, Dublin 4,  
Republic of IRELAND  
TEL: (01) 2603501

#### ITALY

**Roland Italy S. p. A.**  
Viale delle Industrie 8,  
20020 Arese, Milano, ITALY  
TEL: (02) 937-78300

#### NORWAY

**Roland Scandinavia Avd.  
Kontor Norge**  
Lilleakerveien 2 Postboks 95  
Lilleaker N-0216 Oslo  
NORWAY  
TEL: 273 0074

#### POLAND

**P. P. H. Brzostowicz**  
UL. Gibraltarska 4,  
PL-03664 Warszawa POLAND  
TEL: (022) 679 44 19

#### PORTUGAL

**Tecnologias Musica e Audio,  
Roland Portugal, S.A.**  
RUA DE SANTA CARARINA  
131/133, 4000-450 PORTO  
PORTUGAL  
TEL: (022) 208 4456

#### ROMANIA

**FBS LINES**  
Plata Libertatii 1,  
RO-4200 Cheorgheni  
TEL: (066) 164-609

#### RUSSIA

**Slami Music Company**  
Sadjojava-Triumfalnaja st., 16  
103006 Moscow, RUSSIA  
TEL: 095 209 2193

#### SPAIN

**Roland Electronics  
de España, S. A.**  
Calle Bolivia 239, 08020  
Barcelona, SPAIN  
TEL: (93) 308 1000

#### SWEDEN

**Roland Scandinavia A/S  
SWEDISH SALES OFFICE**  
Danvik Center 28, 2 tr.  
S-131 30 Nacka SWEDEN  
TEL: (08) 702 0020

#### SWITZERLAND

**Roland (Switzerland) AG  
Musitronic AG**  
Gerberstrasse 5, CH-4410 Liestal,  
SWITZERLAND  
TEL: (061) 921 1615

#### UKRAINE

**TIC-TAC**  
Mira Str. 19/108  
P.O. Box 180  
295400 Munkachevo, UKRAINE  
TEL: (03131) 414-40

#### UNITED KINGDOM

**Roland (U.K.) Ltd.**  
Atlantic Close, Swansea  
Enterprise Park, SWANSEA  
SA7 9FL,  
UNITED KINGDOM  
TEL: (01792) 700139

### MIDDLE EAST

#### BAHRAIN

**Moon Stores**  
Bab Al Bahrain Road,  
P.O. Box 20077  
State of BAHRAIN  
TEL: 211 005

#### CYPRUS

**Radex Sound Equipment Ltd.**  
17 Diagorou St., P.O. Box 2046,  
Nicosia CYPRUS  
TEL: (02) 453 426

#### ISRAEL

**Halilit P. Greenspoon &  
Sons Ltd.**  
8 Retzif Fa'aliya Hashniya St.  
Tel-Aviv-Yaho ISRAEL  
TEL: (03) 6823666

#### JORDAN

**AMMAN Trading Agency**  
Prince Mohammed St. P.O. Box  
825 Amman 11118 JORDAN  
TEL: (06) 4641200

#### KUWAIT

**Easa Husain Al-Yousifi**  
Abdullah Salem Street,  
Safat KUWAIT  
TEL: 5719499

#### LEBANON

**A. Chahine & Fils**  
P.O. Box 16-5857 Gergi Zeidan St.  
Chahine Building, Achrafieh  
Beirut, LEBANON  
TEL: (01) 335799

#### QATAR

**Badie Studio & Stores**  
P.O. Box 62,  
DOHA QATAR  
TEL: 423554

#### SAUDI ARABIA

**aDawlah Universal  
Electronics APL**  
P.O. Box 2154 ALKHOBAR 31952,  
SAUDI ARABIA  
TEL: (03) 898 2081

#### SYRIA

**Technical Light & Sound  
Center**  
Khaled Ibn Al Walid St.  
P.O. Box 13520  
Damascus - SYRIA  
TEL: (011) 2235 384

#### TURKEY

**Barkat muzik aletleri ithalat  
ve ihracat Ltd Sti**  
Siraselvilcer cad.Guney is hani 84-  
86/6, Taksim. Istanbul, TURKEY  
TEL: (0212) 2499324

#### U.A.E.

**Zak Electronics & Musical  
Instruments Co. L.L.C.**  
Zabeel Road, Al Sherooq Bldg.,  
No. 14, Grand Floor DUBAI  
U.A.E.  
TEL: (04) 3360715

### NORTH AMERICA

#### CANADA

**Roland Canada Music Ltd.  
(Head Office)**  
5480 Parkwood Way Richmond  
B. C., V6V 2M4 CANADA  
TEL: (0604) 270 6626

#### Roland Canada Music Ltd. (Toronto Office)

Unit 2, 109 Woodbine Downs  
Blvd, Etobicoke, ON  
M9W 6Y1 CANADA  
TEL: (0416) 213 9707

#### U. S. A.

**Roland Corporation U.S.**  
5100 S. Eastern Avenue  
Los Angeles, CA 90040-2938,  
U. S. A.  
TEL: (323) 890 3700

As of June 1, 2000 (Roland)



## Free Manuals Download Website

<http://myh66.com>

<http://usermanuals.us>

<http://www.somanuals.com>

<http://www.4manuals.cc>

<http://www.manual-lib.com>

<http://www.404manual.com>

<http://www.luxmanual.com>

<http://aubethermostatmanual.com>

Golf course search by state

<http://golfingnear.com>

Email search by domain

<http://emailbydomain.com>

Auto manuals search

<http://auto.somanuals.com>

TV manuals search

<http://tv.somanuals.com>