

CUBE-100 BASS

Owner's Manual

Thank you, and congratulations on your choice of the Roland CUBE-100 BASS Amplifier. These sections provide important information concerning the proper operation of the unit. Additionally, in order to feel assured that you have gained a good grasp of every feature provided by your new unit, Owner's manual should be read in its entirety. The manual should be saved and kept on hand as a convenient reference.

Before using this unit, carefully read the sections entitled

- **IMPORTANT SAFETY INSTRUCTIONS** (p. 2)
- **USING THE UNIT SAFELY** (p. 3–p. 4)
- **IMPORTANT NOTES** (p. 4).

This unit is equipped with a protection circuit.

The protection circuit helps ensure safety by operating when excessive input continues for a long time while the device is at a location with a high ambient temperature. Sound drop-out may occur when the protection circuit is actuated during use.

Please read through the documentation carefully to ensure correct use.

Main Features

- Adopting Roland's original FFP technology, this highly functional DSP bass amp features 100-watt sound output through the newly developed 30 cm (12-inch) coaxial 2-way wide-range speaker.
- The amp is equipped with a total of eight COSM amp model types, including seven of the most popular bass amps along with a newly developed SUPER FLAT.

SUPER FLAT is an original amp type that features a wide-range frequency and faithful response suitable for use with upright basses.
- In addition to an easy-to-use 4-band equalizer, this amp features a SHAPE function for even greater flexibility in creating sounds and rich sound variation.
- The amp is equipped with a total of three bass effect systems, including COMPRESSION, an EFX system with CHORUS, FLANGER, and T-WAH, and basic DELAY/REVERB.
- In addition to RECORDING OUT/PHONES jack with high-quality sound modeling, the CUBE-100 BASS is also equipped with professional quality BALANCED OUT, LINE OUT, and TUNER OUT, and EXTERNAL SPEAKER jacks. With such expandability, this amp can be used for a wide variety of applications, from home recording to live performances.

FFP (Feed Forward Processing) is system control technology that optimizes the performance of the amp, speakers, and cabinet characteristics according to the signals being input, based on the results of analyses of the operation and behavior of each section of existing amp systems.



COSM (Composite Object Sound Modeling) is Roland's innovative and powerful sound modeling technology. COSM analyzes the many factors that make up the original sound, such as the electrical and physical characteristics of the original, and then produces a digital model that can reproduce the same sound.

* All product names mentioned in this document are trademarks or registered trademarks of their respective owners.

Copyright © 2004 ROLAND CORPORATION

All rights reserved. No part of this publication may be reproduced in any form without the written permission of ROLAND CORPORATION.

WARNING: To reduce the risk of fire or electric shock, do not expose this apparatus to rain or moisture.

  
ATTENTION: RISQUE DE CHOC ELECTRIQUE NE PAS OUVRIR
CAUTION: TO REDUCE THE RISK OF ELECTRIC SHOCK, DO NOT REMOVE COVER (OR BACK). NO USER-SERVICEABLE PARTS INSIDE. REFER SERVICING TO QUALIFIED SERVICE PERSONNEL.



The lightning flash with arrowhead symbol, within an equilateral triangle, is intended to alert the user to the presence of uninsulated "dangerous voltage" within the product's enclosure that may be of sufficient magnitude to constitute a risk of electric shock to persons.



The exclamation point within an equilateral triangle is intended to alert the user to the presence of important operating and maintenance (servicing) instructions in the literature accompanying the product.

INSTRUCTIONS PERTAINING TO A RISK OF FIRE, ELECTRIC SHOCK, OR INJURY TO PERSONS.

IMPORTANT SAFETY INSTRUCTIONS SAVE THESE INSTRUCTIONS

WARNING - When using electric products, basic precautions should always be followed, including the following:

1. Read these instructions.
2. Keep these instructions.
3. Heed all warnings.
4. Follow all instructions.
5. Do not use this apparatus near water.
6. Clean only with a dry cloth.
7. Do not block any of the ventilation openings. Install in accordance with the manufacturers instructions.
8. Do not install near any heat sources such as radiators, heat registers, stoves, or other apparatus (including amplifiers) that produce heat.
9. Do not defeat the safety purpose of the polarized or grounding-type plug. A polarized plug has two blades with one wider than the other. A grounding type plug has two blades and a third grounding prong. The wide blade or the third prong are provided for your safety. If the provided plug does not fit into your outlet, consult an electrician for replacement of the obsolete outlet.
10. Protect the power cord from being walked on or pinched particularly at plugs, convenience receptacles, and the point where they exit from the apparatus.
11. Only use attachments/accessories specified by the manufacturer.
13. Unplug this apparatus during lightning storms or when unused for long periods of time.
14. Refer all servicing to qualified service personnel. Servicing is required when the apparatus has been damaged in any way, such as power-supply cord or plug is damaged, liquid has been spilled or objects have fallen into the apparatus, the apparatus has been exposed to rain or moisture, does not operate normally, or has been dropped.

For the U.K.

WARNING: THIS APPARATUS MUST BE EARTHED

IMPORTANT: THE WIRES IN THIS MAINS LEAD ARE COLOURED IN ACCORDANCE WITH THE FOLLOWING CODE.
GREEN-AND-YELLOW: EARTH, BLUE: NEUTRAL, BROWN: LIVE

As the colours of the wires in the mains lead of this apparatus may not correspond with the coloured markings identifying the terminals in your plug, proceed as follows:

The wire which is coloured GREEN-AND-YELLOW must be connected to the terminal in the plug which is marked by the letter E or by the safety earth symbol  or coloured GREEN or GREEN-AND-YELLOW.

The wire which is coloured BLUE must be connected to the terminal which is marked with the letter N or coloured BLACK.

The wire which is coloured BROWN must be connected to the terminal which is marked with the letter L or coloured RED.

USING THE UNIT SAFELY

INSTRUCTIONS FOR THE PREVENTION OF FIRE, ELECTRIC SHOCK, OR INJURY TO PERSONS

About ⚠ WARNING and ⚠ CAUTION Notices

⚠ WARNING	Used for instructions intended to alert the user to the risk of death or severe injury should the unit be used improperly.
⚠ CAUTION	Used for instructions intended to alert the user to the risk of injury or material damage should the unit be used improperly. * Material damage refers to damage or other adverse effects caused with respect to the home and all its furnishings, as well to domestic animals or pets.

About the Symbols

	The ⚠ symbol alerts the user to important instructions or warnings. The specific meaning of the symbol is determined by the design contained within the triangle. In the case of the symbol at left, it is used for general cautions, warnings, or alerts to danger.
	The ⚡ symbol alerts the user to items that must never be carried out (are forbidden). The specific thing that must not be done is indicated by the design contained within the circle. In the case of the symbol at left, it means that the unit must never be disassembled.
	The Ⓜ symbol alerts the user to things that must be carried out. The specific thing that must be done is indicated by the design contained within the circle. In the case of the symbol at left, it means that the power-cord plug must be unplugged from the outlet.

ALWAYS OBSERVE THE FOLLOWING





⚠ WARNING

- Before using this unit, make sure to read the instructions below, and the Owner's Manual.
- Connect mains plug of this model to a mains socket outlet with a protective earthing connection.
- Do not open or perform any internal modifications on the unit.
- Do not attempt to repair the unit, or replace parts within it (except when this manual provides specific instructions directing you to do so). Refer all servicing to your retailer, the nearest Roland Service Center, or an authorized Roland distributor, as listed on the "Information" page.
- Never use or store the unit in places that are:
 - Subject to temperature extremes (e.g., direct sunlight in an enclosed vehicle, near a heating duct, on top of heat-generating equipment); or are
 - Damp (e.g., baths, washrooms, on wet floors); or are
 - Humid; or are
 - Exposed to rain; or are
 - Dusty; or are
 - Subject to high levels of vibration.
- Make sure you always have the unit placed so it is level and sure to remain stable. Never place it on stands that could wobble, or on inclined surfaces.
- The unit should be connected to a power supply only of the type described in the operating instructions, or as marked on the rear side of unit.
- Do not excessively twist or bend the power cord, nor place heavy objects on it. Doing so can damage the cord, producing severed elements and short circuits. Damaged cords are fire and shock hazards!
- This unit, either alone or in combination with an amplifier and headphones or speakers, may be capable of producing sound levels that could cause permanent hearing loss. Do not operate for a long period of time at a high volume level, or at a level that is uncomfortable. If you experience any hearing loss or ringing in the ears, you should immediately stop using the unit, and consult an audiologist.





⚠ WARNING

- Do not allow any objects (e.g., flammable material, coins, pins); or liquids of any kind (water, soft drinks, etc.) to penetrate the unit.
- Immediately turn the power off, remove the power cord from the outlet, and request servicing by your retailer, the nearest Roland Service Center, or an authorized Roland distributor, as listed on the "Information" page when:
 - The power-supply cord, or the plug has been damaged; or
 - If smoke or unusual odor occurs
 - Objects have fallen into, or liquid has been spilled onto the unit; or
 - The unit has been exposed to rain (or otherwise has become wet); or
 - The unit does not appear to operate normally or exhibits a marked change in performance.
- In households with small children, an adult should provide supervision until the child is capable of following all the rules essential for the safe operation of the unit.
- Protect the unit from strong impact. (Do not drop it!)
- Do not force the unit's power-supply cord to share an outlet with an unreasonable number of other devices. Be especially careful when using extension cords—the total power used by all devices you have connected to the extension cord's outlet must never exceed the power rating (watts/amperes) for the extension cord. Excessive loads can cause the insulation on the cord to heat up and eventually melt through.
- Before using the unit in a foreign country, consult with your retailer, the nearest Roland Service Center, or an authorized Roland distributor, as listed on the "Information" page.
- Do not put anything that contains water (e.g., flower vases) on this unit. Also, avoid the use of insecticides, perfumes, alcohol, nail polish, spray cans, etc., near the unit. Swiftly wipe away any liquid that spills on the unit using a dry, soft cloth.

⚠ CAUTION

- The unit should be located so that its location or position does not interfere with its proper ventilation. 
- Always grasp only the plug on the power-supply cord when plugging into, or unplugging from an outlet. 
- At regular intervals, you should unplug the power plug and clean it by using a dry cloth to wipe all dust and other accumulations away from its prongs. Also, disconnect the power plug from the power outlet whenever the unit is to remain unused for an extended period of time. Any accumulation of dust between the power plug and the power outlet can result in poor insulation and lead to fire. 
- Try to prevent cords and cables from becoming entangled. Also, all cords and cables should be placed so they are out of the reach of children. 

⚠ CAUTION

- Never climb on top of, nor place heavy objects on the unit. 
- Never handle the power cord or its plug with wet hands when plugging into, or unplugging from, an outlet. 
- Before moving the unit, disconnect the power plug from the outlet, and pull out all cords from external devices. 
- Before cleaning the unit, turn off the power and unplug the power cord from the outlet (p. 4). 
- Whenever you suspect the possibility of lightning in your area, pull the plug on the power cord out of the outlet. 

IMPORTANT NOTES

In addition to the items listed under “IMPORTANT SAFETY INSTRUCTIONS” and “USING THE UNIT SAFELY” on pages 2, 3 and 4, please read and observe the following:

Power Supply

- Do not connect this unit to same electrical outlet that is being used by an electrical appliance that is controlled by an inverter (such as a refrigerator, washing machine, microwave oven, or air conditioner), or that contains a motor. Depending on the way in which the electrical appliance is used, power supply noise may cause this unit to malfunction or may produce audible noise. If it is not practical to use a separate electrical outlet, connect a power supply noise filter between this unit and the electrical outlet.
- Before connecting this unit to other devices, turn off the power to all units. This will help prevent malfunctions and/or damage to speakers or other devices.
- Although the LEDs are switched off when the POWER switch is switched off, this does not mean that the unit has been completely disconnected from the source of power. If you need to turn off the power completely, first turn off the POWER switch, then unplug the power cord from the power outlet. For this reason, the outlet into which you choose to connect the power cord's plug should be one that is within easy reach.

Placement

- Using the unit near power amplifiers (or other equipment containing large power transformers) may induce hum. To alleviate the problem, change the orientation of this unit; or move it farther away from the source of interference.
- This device may interfere with radio and television reception. Do not use this device in the vicinity of such receivers.
- Noise may be produced if wireless communications devices, such as cell phones, are operated in the vicinity of this unit. Such noise could occur when receiving or initiating a call, or while conversing. Should you experience such problems, you should relocate such wireless devices so they are at a greater distance from this unit, or switch them off.
- Do not expose the unit to direct sunlight, place it near devices that radiate heat, leave it inside an enclosed vehicle, or otherwise subject it to temperature extremes. Also, do not allow lighting devices that normally are used while their light source is very close to the unit (such as a piano light), or powerful spotlights to shine upon the same area of the unit for extended periods of time. Excessive heat can deform or discolor the unit.
- When moved from one location to another where the temperature and/or humidity is very different, water droplets (condensation) may form inside the unit. Damage or malfunction may result if you attempt to use the unit in this condition. Therefore, before using the unit, you must allow it to stand for several hours, until the condensation has completely evaporated.
- Do not allow rubber, vinyl, or similar materials to remain on the unit for long periods of time. Such objects can discolor or otherwise harmfully affect the finish.
- Do not paste stickers, decals, or the like to this instrument. Peeling such matter off the instrument may damage the exterior finish.

Maintenance

- For everyday cleaning wipe the unit with a soft, dry cloth or one that has been slightly dampened with water. To remove stubborn dirt, use a cloth impregnated with a mild, non-abrasive detergent. Afterwards, be sure to wipe the unit thoroughly with a soft, dry cloth.
- Never use benzene, thinners, alcohol or solvents of any kind, to avoid the possibility of discoloration and/or deformation.

Additional Precautions

- Use a reasonable amount of care when using the unit's buttons, sliders, or other controls; and when using its jacks and connectors. Rough handling can lead to malfunctions.
- When connecting / disconnecting all cables, grasp the connector itself—never pull on the cable. This way you will avoid causing shorts, or damage to the cable's internal elements.
- A small amount of heat will radiate from the unit during normal operation.
- To avoid disturbing your neighbors, try to keep the unit's volume at reasonable levels. You may prefer to use headphones, so you do not need to be concerned about those around you (especially when it is late at night).
- When you need to transport the unit, package it in the box (including padding) that it came in, if possible. Otherwise, you will need to use equivalent packaging materials.
- To prevent malfunction and/or damage to speakers or other devices, always turn down the volume, and turn off the power on all devices before making any connections.
- Once the connections have been completed, turn on power to your various devices in the order specified. By turning on devices in the wrong order, you risk causing malfunction and/or damage to speakers and other devices.
 1. Turn on the device connected to the CUBE's input jack.
 2. Turn on the CUBE.
 3. Switch on any equipment connected to the CUBE's LINE OUT, RECORDING OUT/PHONES and BALANCED OUT jacks.Turn off the devices in the reverse order to which they were switched on.
- Wrap the power cord around the cord hook when transporting or storing the unit.
- Do not insert hands, fingers, etc. into the openings in the unit. In particular, if the unit is to be used in households with small children, always provide adult supervision to ensure that children keep their hands and feet out of these openings.

Panel Descriptions

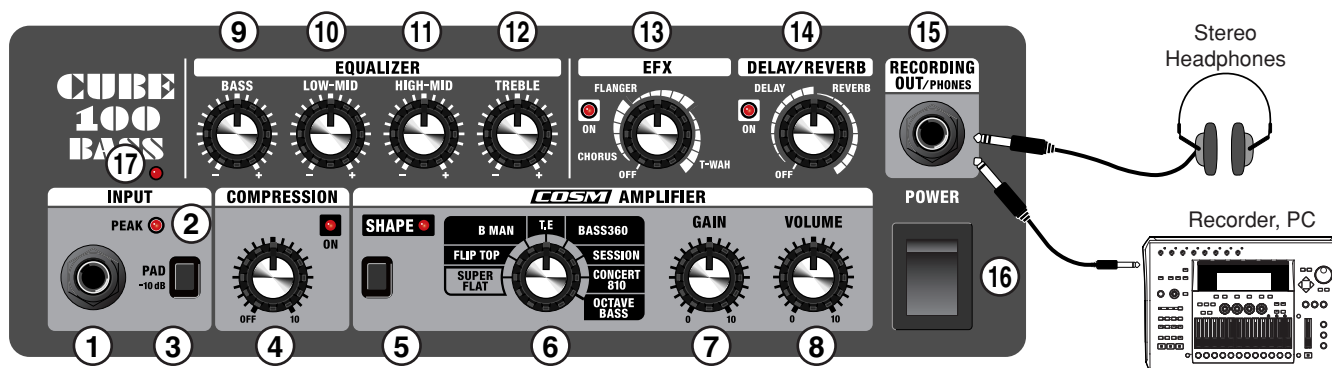

1. INPUT Jack

Connect your bass guitar here.

2. PEAK Indicator

This lights up when the signals are distorted in the input section. If this lights frequently, it indicates that the input signal is in excess of the optimal level.

Press the PAD switch (3) to reduce the sensitivity.

If this still lights up even with the PAD switch pressed, reduce the output level on the device being input to the amp.

* *Inputting in excess of the optimal level can cause unintended distortion and may prevent the COMPRESSION and T-WAH effects from functioning properly.*

HINT Be sure to check the input level each time you connect a different bass or have an effects device connected between the bass and the amp.

3. PAD Switch

This adjusts the degree of amplification in the INPUT circuitry (the input sensitivity).

Switching this on lowers the input sensitivity (-10 dB).

Switch this on if distortion occurs in this device's input section (PEAK indicator lights) as the result of using basses with high output signal levels or using connected devices.

HINT We recommend that this be switched off for ordinary use in order to prevent degradation of the signal-to-noise ratio.

4. COMPRESSION Knob

This is an effect that compresses overly high signals while boosting lower-level input.

Turning the knob to the right increases the compression effect.

When compression is on, the ON indicator lights up; the indicator is unlit when the effect is turned off.

COSM AMPLIFIER

5. SHAPE Switch

This effect alters the COSM amps' tonal qualities. The particular effect obtained varies according to the amp selected with the Type switch (6).

6. Type Switch

You can select from the eight COSM amp types. For details on each type, refer to p. 7.

7. GAIN Knob

This adjusts the preamp section's input level.

Turning the knob to the right increases the gain.

HINT Using a high gain setting allows you to get an overdrive sound.

HINT Set the knob to as high a value as possible before the sound distorts to get the best signal-to-noise ratio.

8. VOLUME Knob

Adjusts the overall volume.

* *The VOLUME knob do not affect the LINE OUT and the BALANCED OUT (p. 8).*

EQUALIZER

9. BASS Knob

Adjusts the tone quality of the lower range.

10. LOW-MID Knob

Adjusts the tone quality of the lower midrange.

11. HIGH-MID Knob

Adjusts the tone quality of the upper midrange.

12. TREBLE Knob

Adjusts the tone quality of the upper range.

13. EFX (Effects) Knob

Turn this knob to chorus, flanger, or T-wah to select the corresponding effect. Turn the knob to adjust the amount of effect applied.

The ON indicator lights up when EFX is turned on, and goes out when EFX is turned off. You can also turn EFX on and off using an optional foot switch (the BOSS FS-5U).

* *Graduations for CHORUS, FLANGER and T-WAH on a panel are for reference. Be sure to check the sound as you adjust the effects.*

CHORUS

In this effect, a slightly detuned sound is added to the original sound, giving the sound greater breadth and fullness.

Turning the knob to the right increases the rate and deepens the chorus effect.

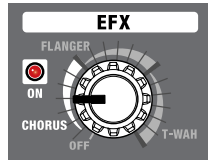

FLANGER

This creates a flanging effect that creates a sort of spinning sensation with the sound.

Turning the knob to the right increases the rate and deepens the flanging effect.

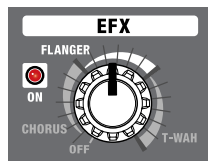

T-WAH

The frequency response of the filter changes according to the input level, producing unique changes in the timbre. Turning the knob to the right increases the sensitivity to the input level.

Adjust this to obtain the optimal effect, which is matched with the output level of your bass.

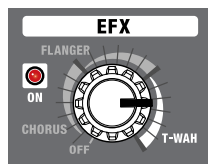

14. DELAY/REVERB Knob

Turn this knob to DELAY or REVERB to switch to that effect. Turn the knob to adjust the amount of effect applied.

* *Graduations for DELAY, REVERB on a panel are for reference. Be sure to check the sound as you adjust the effects.*

DELAY

Turn the knob to change the delay time.



REVERB

Turn the knob to adjust the reverb level.



15. RECORDING OUT/PHONES Jack

When Using RECORDING OUT

Connect to a recorder or other recording device.

Features COSM speaker modeling, allowing you to use the CUBE as a high-performance amp simulator.

When Using PHONES

Connect headphones to this jack.

The COSM speaker modeling allows the bass amp to produce sounds with real punch.

- * *No sound is output from the CUBE's speaker or any external speaker when the RECORDING OUT/PHONES jack is in use.*
- * *As a feature designed to protect the unit's circuitry, sound is prevented from being output from the speakers for a few moments whenever a plug is disconnected from the RECORDING OUT/PHONES jack. This does not indicate the unit is damaged.*

16. POWER Switch

Turns the power on and off.

- * *This unit is equipped with a protection circuit. A brief interval (a few seconds) after power up is required before the unit will operate normally.*
- * *Always make sure to have the volume level turned down before switching on power. Even with the volume all the way down, you may still hear some sound when the power is switched on, but this is normal, and does not indicate a malfunction.*

17. Power Indicator

This indicator lights when the unit is turned on.

TYPE switch (Ⓒ) COSM amp type list

SUPER FLAT	<p>An original amp featuring a wide-range frequency response.</p> <p>This amp type provides faithful reproduction of the connected bass's own sound.</p> <p>This is a great type for all kinds of connected instrument.</p> <p>SHAPE This produces a mild tone with a fat midrange, providing a sound that is perfect for fretless basses, including fretless electric and wood acoustic basses.</p>
FLIP TOP	<p>Models the Ampeg B-15 (1 x 15"). This amp provided the underpinning for many of the most famous Motown hits.</p> <p>It features a fat sound, while the amp's compact cabinet produces a distinct contour.</p> <p>SHAPE Offers more nuances of your picking expression.</p>
B MAN	<p>Models the Fender Bassman 100 (4 x 12").</p> <p>This amp has been a favorite since the inception of electric basses. It features the sonic characteristics of tube amps, whereby increasing the distortion slightly yields a fatter sound.</p> <p>SHAPE Offers a tone with boosted midrange fatness.</p>
T.E	<p>Models the Trace Elliot AH600SMX + 1048 (4 x 10") + 1518 (1 x 15"). This amp was used widely by rock bands in the 1980s. Its wide range, clear attack, and other features make it a great amp for all kinds of performance situations.</p> <p>SHAPE Offers more attack.</p>
BASS 360	<p>Models the acoustic 360 (1 x 18").</p> <p>This amp was used in the '70s not only by jazz bassists, but by funk and hard rock players as well. The tone features a warm low end with a midrange that maintains a clear contour, even with finger picking.</p> <p>SHAPE Offers more nuances of your picking expression.</p>
SESSION	<p>Models the SWR SM-400 + Goliath (4 x 10") + Big Ben (1 x 18"). This tweeter-equipped amp is representative of the "L.A. Sound" of the '80s. It features a wide-range tone that balances presence in the low end with a clear, open sound.</p> <p>SHAPE Offers a tight tone with a cut midrange.</p>
CONCERT 810	<p>Models the Ampeg SVT + 810E (8 x 10").</p> <p>This amp typifies the rock sound that relied heavily on combinations of high-output tube amp sections and large-sized cabinets.</p> <p>The characteristic sound is one of overwhelming low-frequency sound pressure.</p> <p>SHAPE Offers extra heavy bottom sound.</p>
OCTAVE BASS	<p>This original amp type creates sounds one octave below the input sounds and layers them together to create a fatter bass sound.</p> <p>* <i>This function may not work properly when inputting chords; for example, sounds may not play, or they may be played at incorrect pitches. Always input a single note.</i></p> <p>SHAPE This produces a more powerful, edgy octave sound.</p>

* All product names mentioned in this document are trademarks or registered trademarks of their respective owners, and are not related to Roland Corporation.

In this manual, these names are used as appropriate ways to indicate sounds that are simulated using COSM technology.

Rear Panel

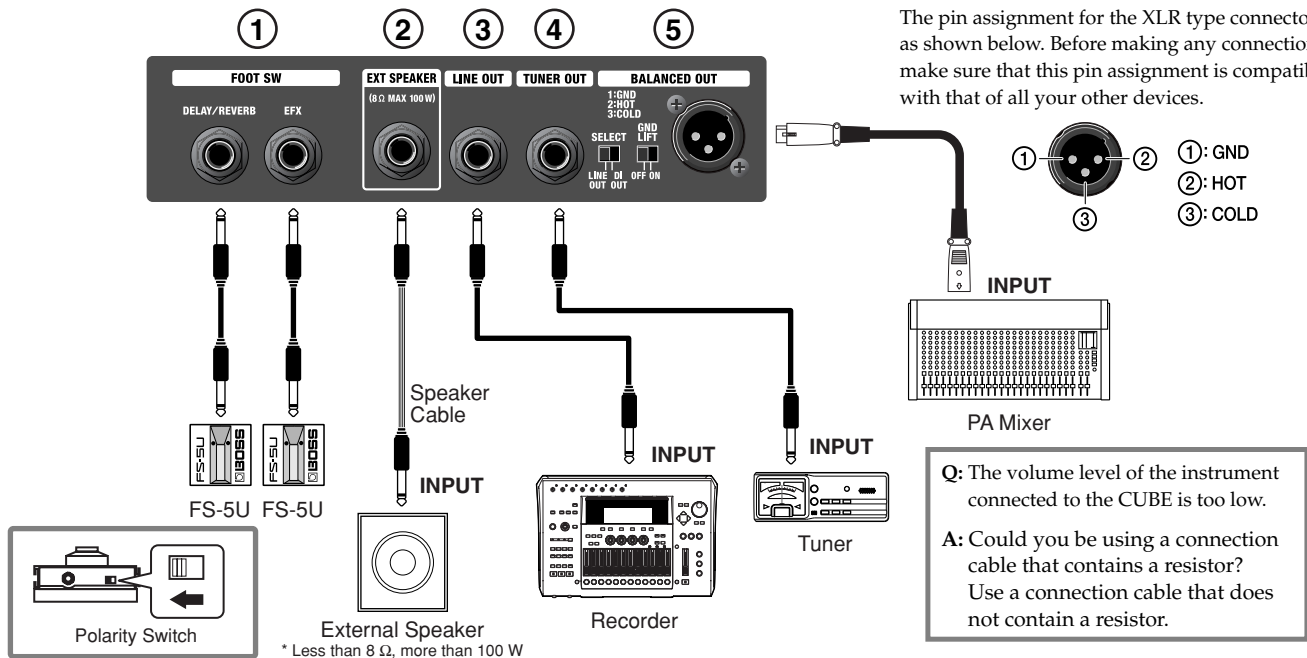

1. FOOT SW (Foot Switch) Jack

Foot switches (the optional BOSS FS-5U) are connected here.

* Set the polarity switch as shown in figure.

EFX: Switches on and off of EFX.

DELAY/REVERB: Switches on and off of DELAY/REVERB.

2. EXT SPEAKER (External Speaker) Jack

You can connect external speaker here.

When connected, sounds are played from both the CUBE and the external speakers.

* When connecting to an external speaker, make sure the speaker conforms to the following specifications.

Impedance: 8 Ω maximum

Allowable power input: 100 watts minimum

* Only use speaker cable to connect the speaker. Do not use any shielded cable designed for use with basses.

* No sound is output from the CUBE's speaker or any external speaker when the RECORDING OUT/PHONES jack is in use.

3. LINE OUT Jack

Connects to a recorder, external amplifier system or other external system.

The COSM speaker modeling allows the bass amp to produce sounds with real punch.

* The VOLUME knob has no effect on the signal from LINE OUT. To adjust the output level, use the CUBE's GAIN knob or adjust the level of the connected device.

HINT Use this when line-recording performances while listening to the sound from the CUBE's speaker.

4. TUNER OUT Jack

Connect tuner to this jack.

* Other than the PAD switch, none of the CUBE's knobs affect the TUNER OUT output.

5. BALANCED OUT Jack

Use this to connect to external PAs and other such systems.

You can switch the sound that is output to suit the particular application.

This professional-grade feature includes a tough, reliable XLR-type connector and ground lift switch.

SELECT Switch

DI OUT: Signals input to the INPUT jack are output as is.

Other than the PAD switch, none of the CUBE's knobs affect the BALANCED OUT output.

LINE OUT: Outputs the same signal as that from LINE OUT. The sound is changed by the settings of the CUBE's knobs, except for the VOLUME knob.

* The VOLUME knob has no effect on the signal from LINE OUT. To adjust the output level, use the CUBE's GAIN knob or adjust the level of the connected device.

HINT This is optimal for maximizing the performance of the CUBE's features, including the COSM amp modeling and effects, when playing live.

GND LIFT Switch

ON: Pin 1 is disconnected from the CUBE's ground.

OFF: Pin 1 connects to the CUBE's ground.

Loop hum noise may occur when other external devices are connected to the CUBE. In such instances, you may be able to mitigate the problem by switching the position of the GND LIFT switch.

The GND LIFT switch should be normally set to OFF.

Main Specifications

Rated Power Output

100 W

Nominal Input Level (1kHz)

INPUT: -10 dBu / 1 MΩ

Speaker

30 cm (12 inches) + Tweeter (Coaxial, 2-way)

Controls

POWER Switch

<INPUT>

PAD Switch

<COMPRESSION>

COMPRESSION Knob

<COSM AMPLIFIER>

SHAPE Switch, TYPE Knob (SUPER FLAT, FLIP TOP, B MAN, T.E, BASS 360, SESSION, CONCERT 810, OCTAVE BASS), GAIN Knob, VOLUME Knob

<EQUALIZER>

BASS Knob, LOW-MID Knob, HIGH-MID Knob, TREBLE Knob

<EFX>

EFX Knob (CHORUS, FLANGER, T-WAH)

<DELAY/REVERB>

DELAY/REVERB Knob

<BALANCED OUT>

SELECT Switch (DI OUT / LINE OUT), GND LIFT Switch (ON / OFF)

Indicators

Power, PEAK, COMPRESSION, SHAPE, EFX, DELAY/REVERB

Connectors

INPUT Jack (1/4" phone type)

RECORDING OUT/PHONES Jack (Stereo 1/4" phone type)

FOOT Switch Jack (EFX, DELAY/REVERB) (1/4" phone type)

EXT SPEAKER Jack (1/4" phone type)

LINE OUT Jack (1/4" phone type)

TUNER OUT Jack (1/4" phone type)

BALANCED OUT Jack (XLR type)

Power Supply

AC 117 V, 230 V or 240 V

Power Consumption

28 W

Dimension

407 (W) x 310 (D) x 469 (H) mm

16-1/16 (W) X 12-1/4 (D) X 18-1/2 (H) inches

Weights

17 kg / 37 lbs 8 oz

Accessories

Owner's Manual, Roland Service Information sheet

Options

Foot switch FS-5U (BOSS)

* 0 dBu = 0.775 Vrms

* In the interest of product improvement, the specifications and/or appearance of this unit are subject to change without prior notice.

Block Diagram

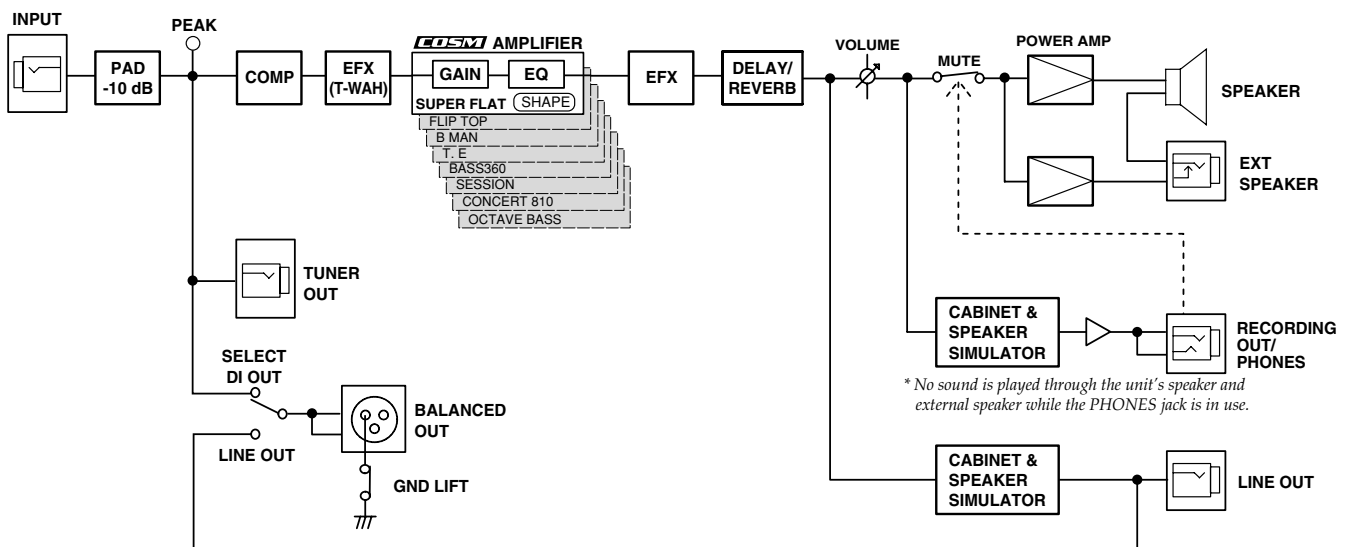

Sample Settings

ALL ROUND (SUPER FLAT)

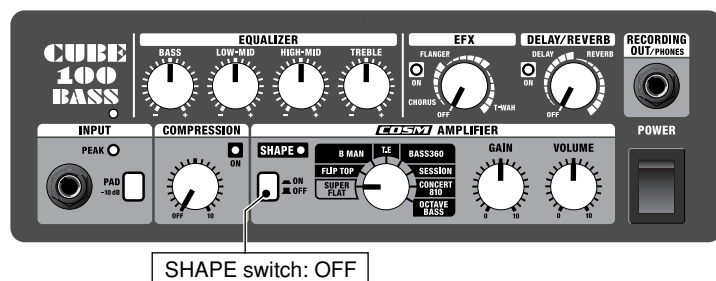

SHAPE switch: OFF

An original amp featuring a wide-range frequency response. This amp type enables clear reproduction of your instrument's sound. This also makes it perfect when connecting bass modeling processors or using sound modules like bass synth. In addition, you can exploit the equalizer's capabilities to create the perfect bass sound for any musical genre from rock to jazz.

FINGER & FRETLESS (BASS 360)

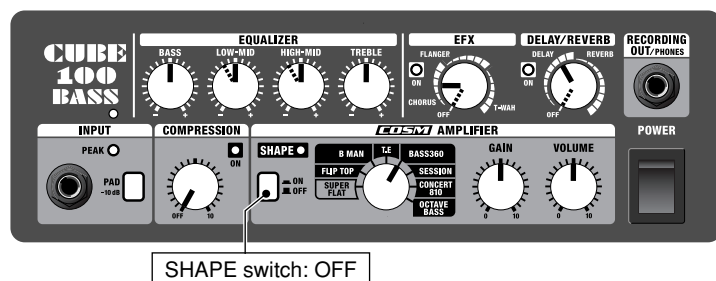

SHAPE switch: OFF

This bass sound made its appearance in the '70s. This is suited for a Jazz Bass with a rear pickup used. This produces a warm, contoured sound when the bass is fingered near the rear pickup. In addition, using this setting while playing harmonics in combination with a chorus and a delay enables sounds featuring exquisite reverberation.

SLAP BASS (SESSION)

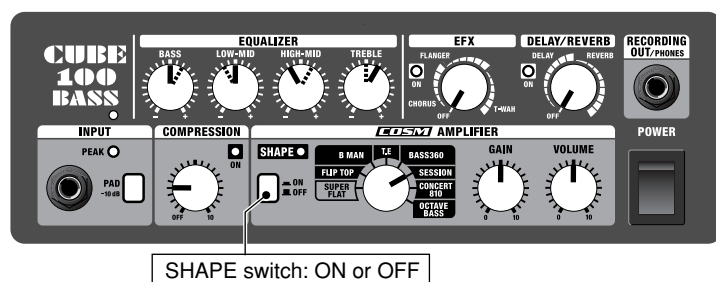

SHAPE switch: ON or OFF

This setting cuts the midrange for a great slap bass sound. Setting the SHAPE switch to ON further boosts the low and high ends. To get a crisp slap sound, lower the HIGH-MID setting and raise the TREBLE. This emphasizes the brightness of the string sound, resulting in a slap sound with a lighter pull sound. To get that attacking sound used in Rock music, raise the BASS and HIGH-MID settings to produce a sound with greater power. You can turn the LOW-MID knob to reduce the middle and get a heavy sound with superb clarity and distinction.

JAZZ WOOD (SUPER FLAT)

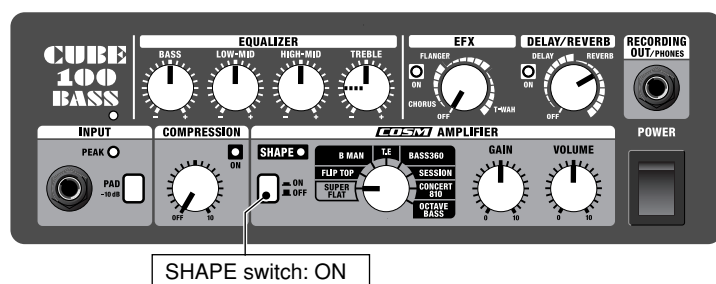

SHAPE switch: ON

This produces a warm bass sound that is perfect for jazz. The tonal quality is perfectly suited for fretless-type basses. Slightly raising the BASS and HIGH-MID settings is an effective way to fatten the core sound of the fretless bass. When using an electric upright bass, turning down the TREBLE to adjust the sound creates a sound approximating that of a wooden acoustic upright. This also produces a natural sound with acoustic upright basses.

SMOOTH JAZZ (FLIP TOP)

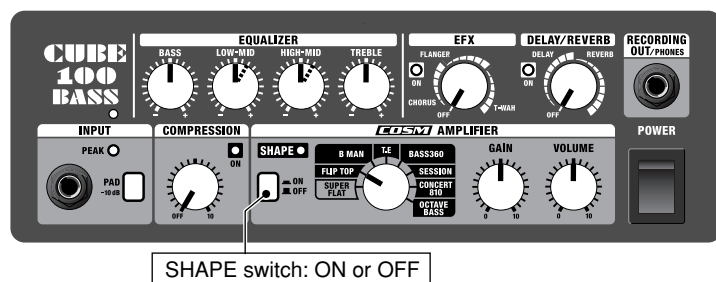

SHAPE switch: ON or OFF

This is a smooth bass sound, just right for jazz and soul. For a thicker, bouncier sound, raise the LOW-MID setting. When playing in bigger bands, switching the SHAPE switch to ON or turning up the HIGH-MID knob slightly is effective in preventing the bass sound from getting buried in the overall sound. When used with wood basses, setting the SHAPE switch to OFF results in a sound resembling that of 60s-style miked recordings. Setting SHAPE to ON produces the sound of basses recorded with piezo pickups in the '70s.

FUNK WAH (T.E)

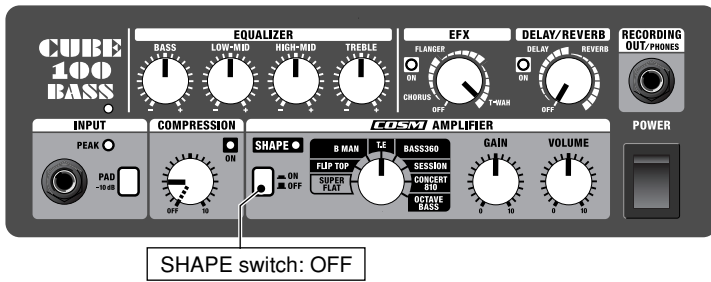

This setting employs the T-WAH feature for a funky sound that responds to the bass touch.

The wah effect becomes even more prominent with the T.E or SESSION amp types, which feature response up to the high-frequency range. Use the T-WAH knob to adjust the sensitivity. Adjust the T-WAH effect with the knob settings according to the output of the connected bass.

ROCK RIFF (CONCERT 810)

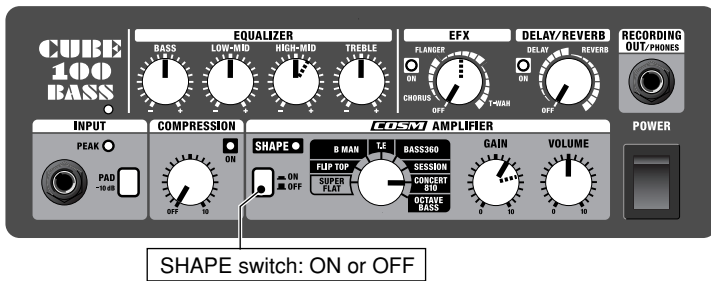

This is a fat, powerful standard bass sound.

Raise the HIGH-MID setting to produce a clear picking sound when the bass is picked.

If you want a fatter low end, set the SHAPE switch to ON.

Raising the GAIN slightly results in an even fatter sound.

Applying the FLANGER produces a driving sound that goes well with rock music.

OVER DRIVE (B MAN)

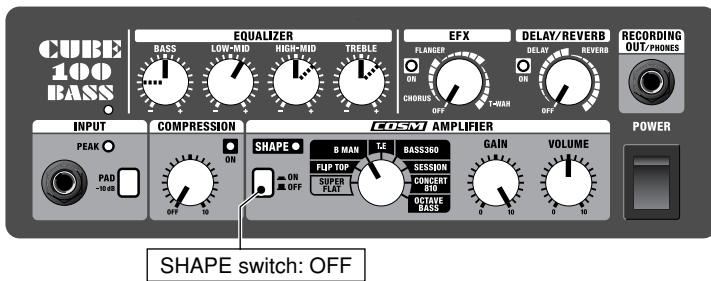

This setting gives the distorted sound produced by cranking a tube amp up all the way.

You can set the GAIN position to create a huge range of sounds, from light-distortion to deep-distortion overdrive.

You can then use the equalizer to create a wide range of different tones.

You can get distortion with a fat, undulating sound by raising the LOW-MID setting, while turning up the TREBLE and HIGH-MID and turning down the BASS works to produce a bright distortion sound.

Setting Name:

Use this for keeping notes regarding your settings.

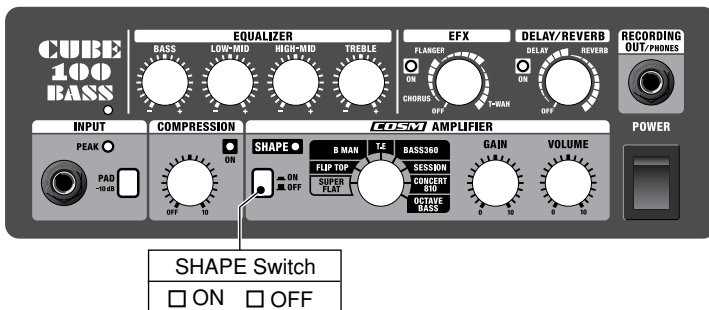

.....

.....

.....

.....

.....

.....

.....

.....

.....

.....

For EU Countries



This product complies with the requirements of European Directives EMC 89/336/EEC and LVD 73/23/EEC.

For the USA

FEDERAL COMMUNICATIONS COMMISSION RADIO FREQUENCY INTERFERENCE STATEMENT

This equipment has been tested and found to comply with the limits for a Class B digital device, pursuant to Part 15 of the FCC Rules. These limits are designed to provide reasonable protection against harmful interference in a residential installation. This equipment generates, uses, and can radiate radio frequency energy and, if not installed and used in accordance with the instructions, may cause harmful interference to radio communications. However, there is no guarantee that interference will not occur in a particular installation. If this equipment does cause harmful interference to radio or television reception, which can be determined by turning the equipment off and on, the user is encouraged to try to correct the interference by one or more of the following measures:

- Reorient or relocate the receiving antenna.
- Increase the separation between the equipment and receiver.
- Connect the equipment into an outlet on a circuit different from that to which the receiver is connected.
- Consult the dealer or an experienced radio/TV technician for help.

This device complies with Part 15 of the FCC Rules. Operation is subject to the following two conditions:

- (1) This device may not cause harmful interference, and
- (2) This device must accept any interference received, including interference that may cause undesired operation.

Unauthorized changes or modification to this system can void the users authority to operate this equipment.
This equipment requires shielded interface cables in order to meet FCC class B Limit.

For Canada

NOTICE

This Class B digital apparatus meets all requirements of the Canadian Interference-Causing Equipment Regulations.

AVIS

Cet appareil numérique de la classe B respecte toutes les exigences du Règlement sur le matériel brouilleur du Canada.

Free Manuals Download Website

<http://myh66.com>

<http://usermanuals.us>

<http://www.somanuals.com>

<http://www.4manuals.cc>

<http://www.manual-lib.com>

<http://www.404manual.com>

<http://www.luxmanual.com>

<http://aubethermostatmanual.com>

Golf course search by state

<http://golfingnear.com>

Email search by domain

<http://emailbydomain.com>

Auto manuals search

<http://auto.somanuals.com>

TV manuals search

<http://tv.somanuals.com>