

STAGE AMPLIFIER SA-300

Owner's Manual

Thank you, and congratulations on your choice of the Roland SA-300 Stage Amplifier.

Before using this unit, carefully read the sections entitled

- **IMPORTANT SAFETY INSTRUCTIONS** (page 2)
- **USING THE UNIT SAFELY** (page 3–5)
- **IMPORTANT NOTES** (page 6)

Additionally, in order to feel assured that you have gained a good grasp of every feature provided by your new unit, Owner's manual should be read in its entirety. The manual should be saved and kept on hand as a convenient reference.



Contents

IMPORTANT SAFETY INSTRUCTIONS	2
USING THE UNIT SAFELY	3
IMPORTANT NOTES	6
Main Features	7
Names of Things and What They Do	8
Control Panel.....	8
Jack Panel.....	10
Making the Connections	13
Switching the Power On and Off	14
About Setting the Volume.....	14
About Stereo Link.....	15
About the Anti-Feedback Function	16
Features of SA-300 ANTI-FEEDBACK.....	16
How to Use Anti-Feedback	17
About the Use of Stacks	18
About the Protection Circuit	18
Using a Speaker Stand	19
Block Diagram	20
Main Specifications	21

Copyright © 2005 ROLAND CORPORATION

All rights reserved. No part of this publication may be reproduced in any form without the written permission of ROLAND CORPORATION.

WARNING: To reduce the risk of fire or electric shock, do not expose this apparatus to rain or moisture.

  
ATTENTION: RISQUE DE CHOC ELECTRIQUE NE PAS OUVRIR
CAUTION: TO REDUCE THE RISK OF ELECTRIC SHOCK, DO NOT REMOVE COVER (OR BACK). NO USER-SERVICEABLE PARTS INSIDE. REFER SERVICING TO QUALIFIED SERVICE PERSONNEL.



The lightning flash with arrowhead symbol, within an equilateral triangle, is intended to alert the user to the presence of uninsulated "dangerous voltage" within the product's enclosure that may be of sufficient magnitude to constitute a risk of electric shock to persons.



The exclamation point within an equilateral triangle is intended to alert the user to the presence of important operating and maintenance (servicing) instructions in the literature accompanying the product.

INSTRUCTIONS PERTAINING TO A RISK OF FIRE, ELECTRIC SHOCK, OR INJURY TO PERSONS.

IMPORTANT SAFETY INSTRUCTIONS SAVE THESE INSTRUCTIONS

WARNING - When using electric products, basic precautions should always be followed, including the following:

1. Read these instructions.
2. Keep these instructions.
3. Heed all warnings.
4. Follow all instructions.
5. Do not use this apparatus near water.
6. Clean only with a dry cloth.
7. Do not block any of the ventilation openings. Install in accordance with the manufacturers instructions.
8. Do not install near any heat sources such as radiators, heat registers, stoves, or other apparatus (including amplifiers) that produce heat.
9. Do not defeat the safety purpose of the polarized or grounding-type plug. A polarized plug has two blades with one wider than the other. A grounding type plug has two blades and a third grounding prong. The wide blade or the third prong are provided for your safety. If the provided plug does not fit into your outlet, consult an electrician for replacement of the obsolete outlet.
10. Protect the power cord from being walked on or pinched particularly at plugs, convenience receptacles, and the point where they exit from the apparatus.
11. Only use attachments/accessories specified by the manufacturer.
12. Unplug this apparatus during lightning storms or when unused for long periods of time.
13. Refer all servicing to qualified service personnel. Servicing is required when the apparatus has been damaged in any way, such as power-supply cord or plug is damaged, liquid has been spilled or objects have fallen into the apparatus, the apparatus has been exposed to rain or moisture, does not operate normally, or has been dropped.

For the U.K.

WARNING: THIS APPARATUS MUST BE EARTHED

IMPORTANT: THE WIRES IN THIS MAINS LEAD ARE COLOURED IN ACCORDANCE WITH THE FOLLOWING CODE.
GREEN-AND-YELLOW: EARTH, BLUE: NEUTRAL, BROWN: LIVE

As the colours of the wires in the mains lead of this apparatus may not correspond with the coloured markings identifying the terminals in your plug, proceed as follows:

The wire which is coloured GREEN-AND-YELLOW must be connected to the terminal in the plug which is marked by the letter E or by the safety earth symbol  or coloured GREEN or GREEN-AND-YELLOW.

The wire which is coloured BLUE must be connected to the terminal which is marked with the letter N or coloured BLACK.

The wire which is coloured BROWN must be connected to the terminal which is marked with the letter L or coloured RED.

USING THE UNIT SAFELY

INSTRUCTIONS FOR THE PREVENTION OF FIRE, ELECTRIC SHOCK, OR INJURY TO PERSONS

About ⚠ WARNING and ⚠ CAUTION Notices

⚠ WARNING	Used for instructions intended to alert the user to the risk of death or severe injury should the unit be used improperly.
⚠ CAUTION	Used for instructions intended to alert the user to the risk of injury or material damage should the unit be used improperly. * Material damage refers to damage or other adverse effects caused with respect to the home and all its furnishings, as well to domestic animals or pets.

About the Symbols

	The ⚠ symbol alerts the user to important instructions or warnings. The specific meaning of the symbol is determined by the design contained within the triangle. In the case of the symbol at left, it is used for general cautions, warnings, or alerts to danger.
	The ⓧ symbol alerts the user to items that must never be carried out (are forbidden). The specific thing that must not be done is indicated by the design contained within the circle. In the case of the symbol at left, it means that the unit must never be disassembled.
	The ⚡ symbol alerts the user to things that must be carried out. The specific thing that must be done is indicated by the design contained within the circle. In the case of the symbol at left, it means that the power-cord plug must be unplugged from the outlet.

ALWAYS OBSERVE THE FOLLOWING

⚠ WARNING

- Before using this unit, make sure to read the instructions below, and the Owner's Manual.
- Connect mains plug of this model to a mains socket outlet with a protective earthing connection.
- Do not open or perform any internal modifications on the unit.
- Do not attempt to repair the unit, or replace parts within it (except when this manual provides specific instructions directing you to do so). Refer all servicing to your retailer, the nearest Roland Service Center, or an authorized Roland distributor, as listed on the "Information" sheet.
- Never use or store the unit in places that are:
 - Subject to temperature extremes (e.g., direct sunlight in an enclosed vehicle, near a heating duct, on top of heat-generating equipment); or are
 - Damp (e.g., baths, washrooms, on wet floors); or are
 - Humid; or are
 - Exposed to rain; or are
 - Dusty; or are
 - Subject to high levels of vibration.
- Make sure you always have the unit placed so it is level and sure to remain stable. Never place it on stands that could wobble, or on inclined surfaces.

⚠ WARNING

- The unit should be connected to a power supply only of the type described in the operating instructions, or as marked on the rear side of unit.
- Do not excessively twist or bend the power cord, nor place heavy objects on it. Doing so can damage the cord, producing severed elements and short circuits. Damaged cords are fire and shock hazards!
- This unit, either alone or in combination with an amplifier and headphones or speakers, may be capable of producing sound levels that could cause permanent hearing loss. Do not operate for a long period of time at a high volume level, or at a level that is uncomfortable. If you experience any hearing loss or ringing in the ears, you should immediately stop using the unit, and consult an audiologist.
- Do not allow any objects (e.g., flammable material, coins, pins); or liquids of any kind (water, soft drinks, etc.) to penetrate the unit.

WA

- Immediately turn the power off, remove the power cord from the outlet, and request servicing by your retailer, the nearest Roland Service Center, or an authorized Roland distributor, as listed on the "Information" sheet when:
 - The power-supply cord, or the plug has been damaged; or
 - If smoke or unusual odor occurs
 - Objects have fallen into, or liquid has been spilled onto the unit; or
 - The unit has been exposed to rain (or otherwise has become wet); or
 - The unit does not appear to operate normally or exhibits a marked change in performance.

- In households with small children, an adult should provide supervision until the child is capable of following all the rules essential for the safe operation of the unit.

- Protect the unit from strong impact. (Do not drop it!)

- Do not force the unit's power-supply cord to share an outlet with an unreasonable number of other devices. Be especially careful when using extension cords—the total power used by all devices you have connected to the extension cord's outlet must never exceed the power rating (watts/amperes) for the extension cord. Excessive loads can cause the insulation on the cord to heat up and eventually melt through.

- Before using the unit in a foreign country, consult with your retailer, the nearest Roland Service Center, or an authorized Roland distributor, as listed on the "Information" sheet.

- Do not put anything that contains water (e.g., flower vases) on this unit. Also, avoid the use of insecticides, perfumes, alcohol, nail polish, spray cans, etc., near the unit. Swiftly wipe away any liquid that spills on the unit using a dry, soft cloth.

- When using the SA-300 in combination with the SA-300W, they can be used in a stacked configuration. However, when units are stacked, due caution must be observed to prevent any unit from falling. For details, see page 18.

- Do not insert hands, fingers, etc, into the openings in the unit. In particular, if the unit is to be used in households with small children, always provide adult supervision to ensure that children keep their hands and feet out of these openings.

- Do not insert hands, fingers, etc, into the openings in the unit. In particular, if the unit is to be used in households with small children, always provide adult supervision to ensure that children keep their hands and feet out of these openings.



observed toetm11 h, l0. eetc, into . T8un0u w l2 e.. 775.679 l h 1sntw

⚠ WARNING









Placement

- Using the unit near power amplifiers (or other equipment containing large power transformers) may induce hum. To alleviate the problem, change the orientation of this unit; or move it farther away from the source of interference.
- This device may interfere with radio and television reception. Do not use this device in the vicinity of such receivers.
- Noise may be produced if wireless communications devices, such as cell phones, are operated in the vicinity of this unit. Such noise could occur when receiving or initiating a call, or while conversing. Should you experience such problems, you should relocate such wireless devices so they are at a greater distance from this unit, or switch them off.
- Do not expose the unit to direct sunlight, place it near devices that radiate heat, leave it inside an enclosed vehicle, or otherwise subject it to temperature extremes. Also, do not allow lighting devices that normally are used while their light source is very close to the unit (such as a piano light), or powerful spotlights to shine upon the same area of the unit for extended periods of time. Excessive heat can deform or discolor the unit.
- When moved from one location to another where the temperature and/or humidity is very different, water droplets (condensation) may form inside the unit. Damage or malfunction may result if you attempt to use the unit in this condition. Therefore, before using the unit, you must allow it to stand for several hours, until the condensation has completely evaporated.
- Do not allow rubber, vinyl, or similar materials to remain on the unit for long periods of time. Such objects can discolor or otherwise harmfully affect the finish.
- Do not paste stickers, decals, or the like to this instrument. Peeling such matter off the instrument may damage the exterior finish.
- During operation, this device must be placed at a distance of no less than 20 cm from any walls.

⚠ CAUTION

- The unit should be located so that its location or position does not interfere with its proper ventilation. 
- Always grasp only the plug on the power-supply cord when plugging into, or unplugging from an outlet. 

⚠ CAUTION

- At regular intervals, you should unplug the power plug and clean it by using a dry cloth to wipe all dust and other accumulations away from its prongs. Also, disconnect the power plug from the power outlet whenever the unit is to remain unused for an extended period of time. Any accumulation of dust between the power plug and the power outlet can result in poor insulation and lead to fire. 
- Try to prevent cords and cables from becoming entangled. Also, all cords and cables should be placed so they are out of the reach of children. 
- Never climb on top of, nor place heavy objects on the unit. 
- Never handle the power cord or its plug with wet hands when plugging into, or unplugging from, an outlet. 
- Before moving the unit, disconnect the power plug from the outlet, and pull out all cords from external devices. 
- Before cleaning the unit, turn off the power and unplug the power cord from the outlet. 
- Whenever you suspect the possibility of lightning in your area, pull the plug on the power cord out of the outlet. 
- The cooling vents on either side of the unit may become hot, so take care to avoid burns. 
- Always turn the phantom power off when connecting any device other than condenser microphones that require phantom power. You risk causing damage if you mistakenly supply phantom power to dynamic microphones, audio playback devices, or other devices that don't require such power. Be sure to check the specifications of any microphone you intend to use by referring to the manual that came with it. 

(This instrument's phantom power: 48 V DC, 10 mA Max)

- Do not remove the speaker grille and speaker by any means. Speaker not user replaceable. Shock hazardous voltages and currents are present inside the enclosure. 

Main Features

The SA-300 is a lightweight yet powerful stage amp, which functions as a combo amp while featuring full 2.1-channel stereo compatibility.

High Power

This combo amp has an output of 350 W (75 W + 75 W stereo, 200 W subwoofer).

4-Channel/Full Stereo Input Compatibility

The SA-300 features four input channels, all of which handle stereo input. Additionally, all are compatible with microphones as well as line-level equipment. The SA-300 also provides phantom power for two mic inputs.

Simple Setup

The mixer, amp, and speakers are integrated into a single unit, eliminating the need for complicated and bothersome cable connections.

Light, Compact, and Extremely Portable

All speakers are newly developed custom speakers built from new materials. Midrange and high-frequency sounds are played through a 6.5" coaxial 2-way speaker, with a 12" woofer handling the low end. Both speakers succeed in reducing weight to half that of previous models (as compared with previous Roland products). Development of improved, more powerful magnets than in previous products has resulted in greater efficiency and quick response. Additionally, use of Class-D power amps for high energy conversion efficiency and switching power supplies reduces generation of unnecessary heat, thus permitting use of smaller, lighter power transformers and heat sinks.

Plus, the cabinet separates into compact upper and lower units for easy carrying.

Newly Developed Anti-Feedback Function (Pre-Detection)

Conventional monitor amps have always presented the risk of feedback when the amp is placed directly behind the performer, so these amps are not set up directly behind vocalists (or MCs). The SA-300's newly developed pre-detecting anti-feedback function resolves this problem.

Wide Variety of Effects

The SA-300 features great effects such as a voice enhancer, reverb, and an easy-to-operate delay for use with microphones. You also get 3-band EQ, a "Wide" function, which provides expanded presence; and a low boost function, which emphasizes the extreme low end.

Foot Control Function

You can connect an expression pedal and use the pedal to control the volume. You can also connect a foot switch to switch the muting and effects on and off.

New Stereo Link Function

The Stereo Link function allows you to connect two SA-300s together and use them as independent left and right stereo speakers. What's more, you can use the input channels on both SA-300s, giving up to eight inputs.

Names of Things and What They Do

Control Panel

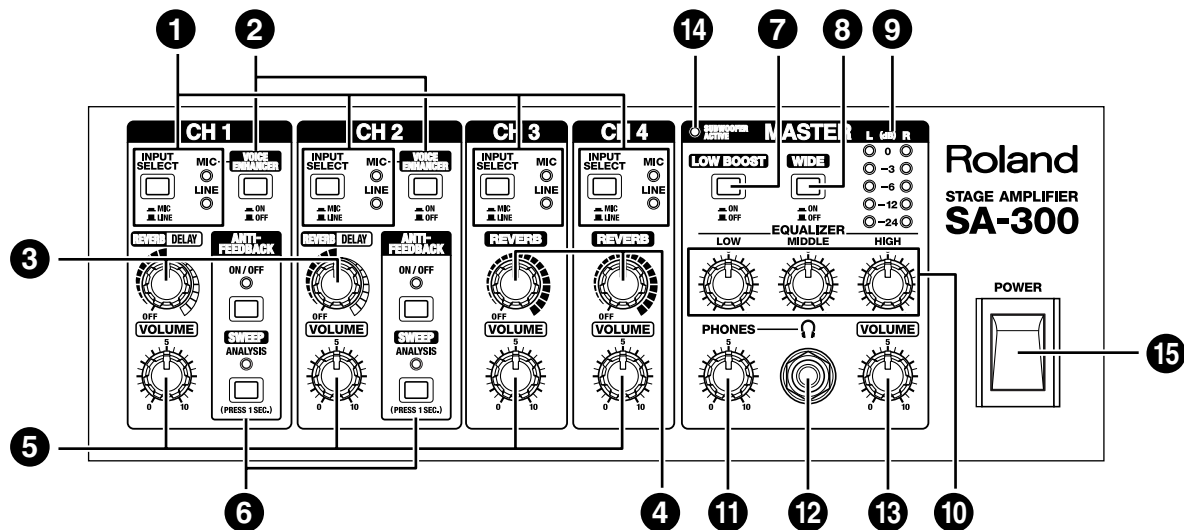

Channel Controls (CH 1-4)

1. INPUT SELECT Button

Use this button to select MIC or LINE input.

This switches the input to match the connected device (mic or line-level device).

The MIC indicator lights when MIC is selected; when LINE is selected, the LINE indicator lights.

2. VOICE ENHANCER Button (CH 1, CH 2)

This switches the Voice Enhancer effect on and off when the input is set to MIC.

Switching this on enables you to give the sound a clearer contour and make vocals more prominent.

3. REVERB/DELAY Knob (CH 1, CH 2)

You can switch between reverb and delay by adjusting the knob position.

When not using reverb or delay, set the knob to "OFF." The reverb and delay position on the scale shown on the panel is approximate. Listen to confirm the effect as you adjust the amount of effect applied.

4. REVERB Knob (CH 3, CH 4)

This adjusts the amount of reverb.

When not using reverb, set the knob to "OFF."

5. VOLUME Knobs

These adjust the volume levels of the channels.

- * To minimize noise as much as possible, we recommend turning the VOLUME knob for any channel not being used to 0 and setting INPUT SELECT to LINE.

6. ANTI-FEEDBACK (CH 1, CH 2)

This automatically detects and eliminates acoustic feedback.

cf. →

For further instructions on how to use anti-feedback, refer to "About the Anti-Feedback Function" (p. 16)

ON/OFF Button

Press this button to turn the function on.

When switched on, the indicator lights, and the system automatically works to prevent sudden feedback, as well as feedback that occurs during quiet stretches.

SWEEP Button

When the ON/OFF button is set to ON, holding down this button for one second or longer generates a calibration signal from the speakers. The microphone picks up the sound and the SA-300 analyzes the characteristics of the microphone and the surroundings. Based on the results of this analysis, the microphone and environmental characteristics are compensated for automatically, making it difficult for feedback to crop up.

The indicator flashes while this automatic correction is in progress. When the process is completed, the indicator remains lit, signifying that the feedback prevention function is in effect.

MASTER

7. LOW BOOST Button

This switches the low boost effect on and off.
When this is switched on, the low-frequency range is boosted.

8. WIDE Button

This switches the wide effect on and off.
When this is switched on, the sonic image extends beyond the SA-300's speakers, providing an effect that seems to envelop the listener in sound.

9. LEVEL Indicator

This indicates the MASTER output level.

10. EQUALIZER

The SA-300 includes a 3-band equalizer.

LOW Knob

This adjusts the tone in the low-frequency range.

MIDDLE Knob

This adjusts the tone in the middle-frequency range.

HIGH Knob

This adjusts the tone in the high-frequency range.

11. PHONES Knob

This adjusts the headphone volume level.

12. Headphone Jack

Connect headphones here.

- * Be sure to turn the PHONES knob setting to 0 before connecting or disconnecting headphones.
- * The sound from the SA-300's speakers is not muted when headphones are connected.

13. VOLUME Knob

This adjusts the overall volume output from the SA-300's speakers.

14. SUBWOOFER ACTIVE Indicator

This lights when the subwoofer is connected to the SPEAKER jack.

While the indicator is lit, the low-frequency response with the subwoofer (SA-300W) connected is modified accordingly.

15. POWER Switch

This switches the power on and off.

- * Be sure to turn the MASTER VOLUME knob down to 0 whenever turning the power on or off.
- * This unit is equipped with a protection circuit. A brief interval (a few seconds) after power up is required before the unit will operate normally.

Jack Panel

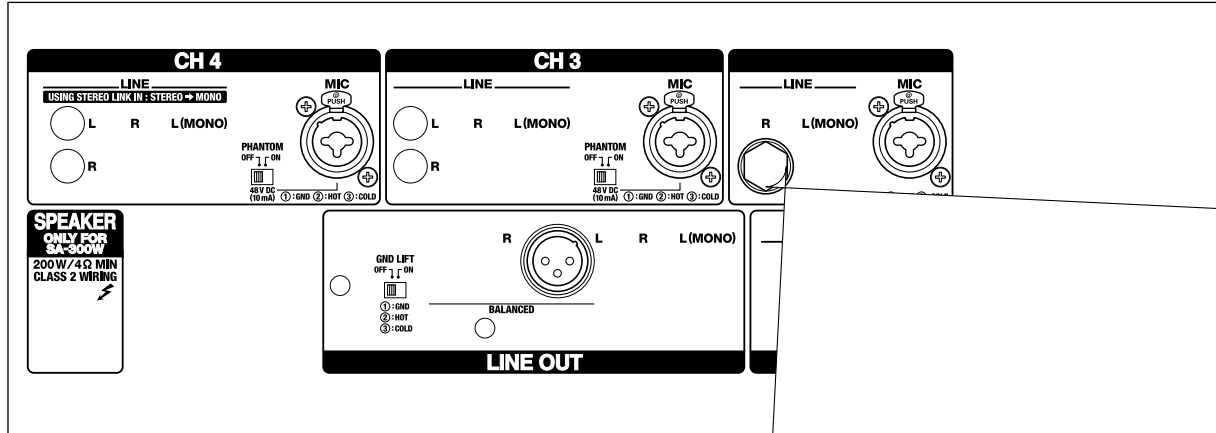

1. MIC Jack

Connect a microphone here. For balanced input, you can connect to the TRS 1/4-inch phone jacks and XLR type connector.

2. PHANTOM Switch (CH 3, CH 4)

This switches the phantom power on and off. When connecting a microphone that requires phantom power (such as condenser microphones), switch this to "ON."

- Set this to "OFF" when connecting mics that do not require phantom power or other devices.
- Use the following sequence when connecting mics that require phantom power:
 1. Turn the PHANTOM switch off.
 2. Connect the mic.
 3. Turn the PHANTOM switch on.

- Supply or supply equipment switch
- To provide momentary off.
- Phantom connection Channel
- Do not phantom

3. LINE

Connect devices. The connection. The 20 channels. Channels 3 and 4 also feature RCA phono type inputs. In addition, you can input to both the RCA phono type and 1/4-inch phone jacks simultaneously.

- * All Channel 4 LINE jacks function as mono inputs when the STEREO LINK IN jack is in use.

...ch, set the *MODE* and *POLARITY*
...n below.

...to
...tly.

...oot switches
...you can then use the
...atch the mute on and off,
...ary type) switch to turn on
... or delay).

...indicator is lit, the mute function is
...and the output from the speakers and
..., as well as from *LINE OUT* and *STEREO*
...OT is muted.

Set On/Off

...the effect is alternately switched on and off each time
...you press the FS-5U.

STEREO LINK

After connecting two SA-300s together with one or two audio cables (1/4-inch phone type), you can easily play back high power sounds (350 W + 350 W) in stereo.

6. STEREO LINK IN Jack

When using Stereo Link, the audio output by the STEREO LINK OUT L or STEREO LINK OUT R jack on the other SA-300 is input here.

You can use it as an external input jack also.

Input level is 0 dBu.

- * All Channel 4 LINE jacks function as mono inputs when the STEREO LINK IN jack is in use.

7. STEREO LINK OUT Jacks (L/R)

Connect this jack to the STEREO LINK IN jack on the other SA-300 when using Stereo Link.

If you are not using the SA-300's speakers, but using external amp speakers instead, the output from the left or right channel is taken here.

When the STEREO LINK OUT L jack is used, the left channel audio is not played through the SA-300's speakers. In the same manner, when the STEREO LINK OUT R jack is used, the right channel audio is not played through the SA-300's speakers.

Output level is 0 dBu.

- * Signals output from these jacks are not routed through the MASTER section (EQUALIZER, LOW BOOST, WIDE, VOLUME).

cf. ➔

For further instructions on connecting with Stereo Link, refer to "About Stereo Link" (p. 15).

LINE OUT

8. LINE OUT Connectors/Jacks

Mixers, recording equipment, and other such devices are connected here. Nominal output level is +4 dBu.

This section includes balanced output compatible XLR type connectors (left and right stereo output) and 1/4-inch phone jacks (stereo output). You can use the XLR type connectors and the 1/4-inch phone jacks simultaneously.

Output is in mono when only the left 1/4-inch phone jack is connected.

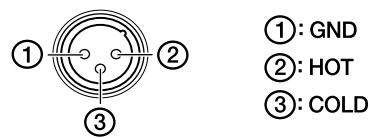

9. GND LIFT Switch

Using external equipment connected to the LINE OUT connectors may result in generation of the "hum" of loop ground noise. If this occurs, you may be able to mitigate the problem by sliding this switch. Normally, this is set to "OFF."

ON: Pin 1 is disconnected from the SA-300's ground.

OFF: Pin 1 is connected to the SA-300's ground.

SPEAKER

10. SPEAKER Jack

Use this jack to output sounds to the SA-300W subwoofer.

Use the special connection cable included with the unit to connect to the SA-300W's INPUT jack. This provides an even more powerful low end to the sound.

- * Turn off the power on the SA-300 before connecting or disconnecting cable.

NOTE

- Connect only the SA-300W. Never connect any other equipment.
- Be sure to use only the connection cable included with the unit to connect the subwoofer. Do not use ordinary audio cables.

Making the Connections

Refer to the figure shown below to connect the SA-300 and the other equipment.

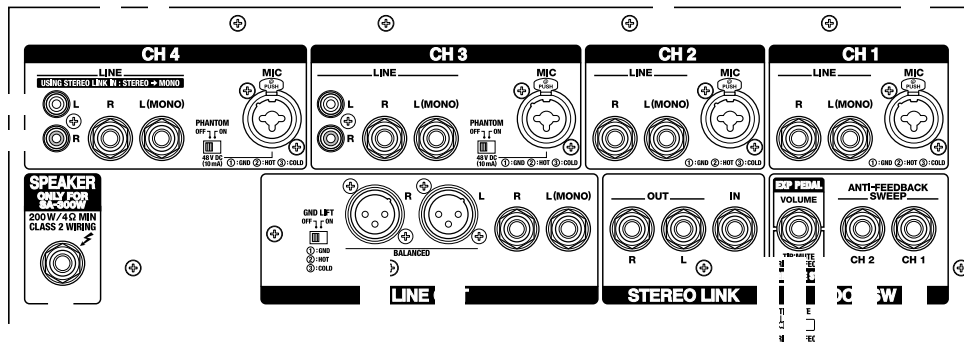

- * To prevent malfunction and/or damage to speakers or other devices, always turn down the volume, and turn off the power on all devices before making any connections.
- * Before making any connections, set the SA-300's MASTER VOLUME knob to "0."
- * Use only the specified expression pedal (EV-5, etc.; optional). By connecting any other expression pedals, you risk causing malfunction and/or damage to the unit.

- * When connection cables with resistors are used, the volume level of equipment connected to the inputs may be low. If this happens, use connection cables that do not contain resistors, such as those from the Roland PCS series.

Switching the Power On and Off

Once the connections have been completed, turn on power to your various devices in the order specified. By turning on devices in the wrong order, you risk causing malfunction and/or damage to speakers and other devices.

1. Make sure that all volume controls on the SA-300 and connected devices are set to 0.
2. Turn on all the devices connected to the SA-300's input jacks (CH 1 through CH 4).
3. Turn on the SA-300.
4. Switch on any equipment connected to the SA-300's LINE OUT jacks.
5. Adjust the volume levels for the devices.
6. Before switching off the power, lower the volume on each of the devices in your system and then Turn Off the devices in the reverse order to which they were switched on.
 - * If you need to turn off the power completely, first turn off the POWER switch, then unplug the power cord from the power outlet. Refer to "Power Supply" (p. 6).
 - * This unit is equipped with a protection circuit. A brief interval (a few seconds) after power up is required before the unit will operate normally. For protection from sudden big sound, always make sure to have the volume level turned down before switching on power.
 - * Even with the volume all the way down, you may still hear some sound when the power is switched on, but this is normal, and does not indicate a malfunction.

About Setting the Volume

To obtain the best sound from the SA-300, set the volume level using the following procedure.

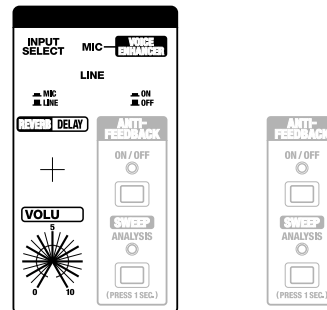

1. Use the INPUT SELECT buttons for CH 1 through CH 4 to switch the input sensitivity in accordance with the connected devices (microphones or line-level equipment).
2. Use the CH 1 through CH 2 VOICE ENHANCER buttons, REVERB/DELAY knobs and the CH 3 through CH 4 REBERB knobs to adjust the tone to your liking.
3. Operate the CH 1 through CH 4 volume knobs to adjust the volume level for CH 1 through CH 4.
 - * If the sound is distorted (when level indicator 0 dB is lit), adjust the volume either with the VOLUME knobs (Channels 1-4) or the volume knobs on devices connected to the inputs (Channels 1-4).

At this point, balance the volume levels of Channels 1-4.

4. Use the EQUALIZER knobs (LOW/MIDDLE/HIGH), LOW BOOST button, and WIDE button to adjust the tone to your liking.
5. Use the MASTER VOLUME knob to adjust the overall volume level.
6. Set up the ANTI-FEEDBACK if necessary. (p. 16)

About Stereo Link

You can easily play back high power sounds (350 W + 350 W) in stereo by connecting two SA-300s together with one or two audio cables (1/4-inch phone type). This function is called "Stereo Link."

The SA-300 features a stereo mixer function, which enables you to output either left or right channel signals from the STEREO LINK OUT jack.

Connecting the SA-300s according to the instructions below allows you to play sounds in stereo.

Example 1

Up to four input devices can be connected.

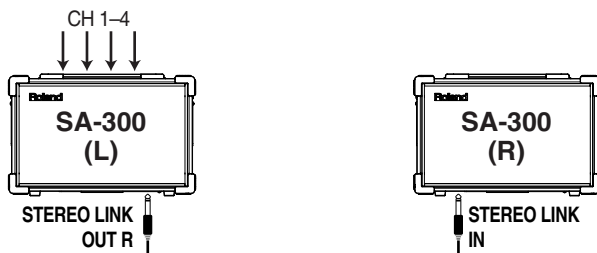

Operation

1. Connect the devices to the SA-300 (L).
2. Connect the STEREO LINK OUT R jack on the SA-300 (L) and the STEREO LINK IN jack on the SA-300 (R).
3. Turn on both SA-300 (L) and SA-300 (R).
4. Adjust the volume levels on all devices.
5. Adjust the SA-300 (L) and SA-300 (R) volume levels separately using their MASTER VOLUME knobs.

If you want to connect input sources to the SA-300 (R)

As described in step 1 of example 1, connect the R side's STEREO LINK OUT L jack to the L side's STEREO LINK IN jack.

Example 2

This arrangement lets you play in stereo, making maximum use of the two SA-300s' mixer functions (with eight inputs). All Channel 4 LINE jacks function as mono inputs.

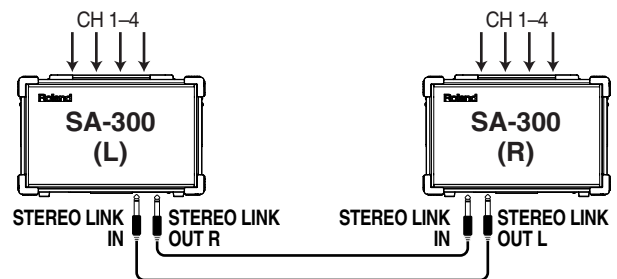

Operation

1. Connect the devices to the SA-300 (L) and SA-300 (R).
2. Connect the STEREO LINK OUT R jack on the SA-300 (L) and the STEREO LINK IN jack on the SA-300 (R).
3. Connect the STEREO LINK OUT L jack on the SA-300 (R) and the STEREO LINK IN jack on the SA-300 (L).
4. Turn on both SA-300 (L) and SA-300 (R).
5. Adjust the volume levels on all devices.
6. Adjust the SA-300 (L) and SA-300 (R) volume levels separately using their MASTER VOLUME knobs.

About the Volume and Tone Settings

Adjust the R and L volume levels separately using their MASTER VOLUME knobs.

You can adjust the EQUALIZER (LOW/MIDDLE/HIGH knobs), LOW BOOST, and WIDE independently for the L and R sides. Basically, they should be set to the same positions, but you can adjust each one as necessary to suit the needs of a particular setup. The EXP PEDAL/REMOTE SW jack affects only the input signals to the SA-300 to which the expression pedal or the foot switch is connected.

About the Anti-Feedback Function

Features of SA-300 ANTI-FEEDBACK

Many previous anti-feedback systems use methods of determining feedback that actually generate feedback in order to detect the feedback point, resulting in a system that is extremely unpleasant to use.

On the other hand, the SA-300 employs a newly developed method that does not require generation of feedback, but instead uses a microphone to capture a calibration signal output from the SA-300's own speakers, then performs a feedback analysis to estimate the feedback point.

■ What is Acoustic Feedback

When sounds output by speakers reenter a microphone, they end up being output from the speakers at even greater volume, and as this cycle is repeated, an unpleasant and uncomfortable oscillating sound is created.

Pointing microphones towards speakers or placing them near the speakers allows the amplified sounds from the speakers to enter the microphones again, thus making it even easier for feedback to arise.

■ To Avoid Feedback

In general, avoiding feedback requires the following measures:

- Setting output levels so they're appropriate for the particular site or room
- Setting connected devices to suitable levels
- Keeping microphones and speakers as distant from each other as possible, and avoiding placing microphones such that they are pointed directly at the speakers.

These methods will allow you to suppress the most serious types of feedback.

In actuality, however, feedback can still occur as you attempt to achieve necessary output levels, while on the other hand, moving speakers away to avoid causing feedback can end up making the sound difficult to hear.

■ Reducing Acoustic Feedback with the SA-300 (Anti-Feedback)

The SA-300 includes the following three built-in functions, which allow you to achieve an acoustically stable system that automatically controls the occurrence of feedback and makes it more difficult for feedback to arise.

Dynamic Function

- 1 Suppresses feedback that occurs at times when there is no sound from the microphone.**

For feedback generated when no audio is being input via the microphone (for example, at times when the performer is not at the microphone), the feedback point is automatically detected and the feedback is cut with a dedicated filter.

- 2 Prevents sudden feedback that occurs when the microphone is in use.**

This system automatically cuts out feedback that crops up suddenly due to changes in the surroundings or movement of the microphone, using an extremely narrow filter to minimize alterations in the sound quality.

Safety Margin Function

- 3 Conditions are calibrated automatically to help prevent feedback.**

Frequencies prone to feedback will change depending on the microphones used, the placement of the SA-300 (speakers), and the SA-300's output level settings.

The SA-300 measures conditions first to detect these frequencies and secure a sufficient safety margin (i.e., an ample margin of gain before feedback starts to occur).

The entire process, from measurement to securing of the safety margin, takes only a few seconds.

The dedicated filter is optimally processed for each feedback point, resulting in an acoustically stable system that minimizes tonal changes.

Relationship Between Anti-Feedback Functions and Buttons

ON/OFF Button: Switches Dynamic function on and off

SWEEP Button: Activates the Safety Margin function

■ About Speaker and Mic Placement

Conventional PA systems generally require performers using mics to stand behind speakers to avoid feedback. This makes it difficult to hear the sound from the speakers, making comfortable monitoring impossible.

The SA-300's internal anti-feedback system suppresses feedback, allowing performers to monitor the sound in comfort, even when standing in front of the speakers.

How to Use Anti-Feedback

Anti-feedback is enabled only for Channels 1 and 2. In addition, the function can be used only when INPUT SELECT is set to MIC.

When Using a Mic Stand

Both the mic characteristics and the characteristics of the surrounding environment can be compensated for.

- 1. Set up and connect the SA-300 and the mic.**
 - Set up the SA-300 and the mic in the positions they will be used.
 - Adjust the height of the mic stand and the angle of the mic.
 - Set the SA-300's VOLUME knob to the level actually to be used in performance.
- 2. Press the ANTI-FEEDBACK ON/OFF button so its indicator is lit.**
- 3. Hold down the ANTI-FEEDBACK SWEEP button for at least one second.**

The indicator flashes, and the sound of the calibration signal is output from the speaker.

The calibration signal is set automatically in accordance with the mic position and volume setting.

* *Be aware that the sound output is relatively loud.*

When measurement and analysis are finished and the feedback prevention processing is completed, the indicator stops flashing and remains lit.

When Using a Handheld Mic

Only the mic conditions can be corrected.

- 1. Press the ANTI-FEEDBACK ON/OFF button so its indicator is lit.**
- 2. Set up and connect the SA-300 and the mic.**
 - Set the SA-300's VOLUME knob to the level actually to be used in performance.
 - To accurately measure the mic characteristics, keep the mic, whether held by hand or mounted on a stand, fixed in the position shown below. To setting up the mic position, please be careful of feedback.

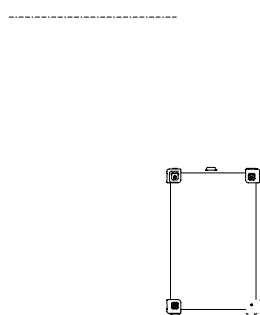

- (1) Angle: Directly facing the front of the SA-300
- (2) Distance: Approx. 50 cm (19-11/16")
- (3) Height: 120 cm (47-1/4") or more (Height during actual use)
- (4) Mic Direction: Level and directed at the SA-300

- 3. Hold down the ANTI-FEEDBACK SWEEP button for at least one second.**

The indicator flashes, and the sound of the calibration signal is output from the speaker.

The calibration signal is set automatically in accordance with the position of the mic and the volume setting.

- * *Take care not to stand between or leave any object obstructing the space between the mic and the SA-300.*
- * *To increase measurement accuracy, keep the surroundings as quiet as possible.*

When measurement and analysis are finished and the feedback prevention processing is completed, the indicator stops flashing and remains lit.

When automatic measurement is not completed

- If you press the SWEEP button to start the calibration without a microphone connected or with the volume level turned down too low, SA-300 outputs an error sound from the speaker and stops analysis. If this occurs, check your connections and settings.
- If the surrounding noise level is too loud or the microphone position is too far, SA-300 outputs an error sound from the speaker and stops analysis. If this occurs, the SWEEP indicator light goes off.
- If you press the ON/OFF button while the SWEEP indicator is lit, the indicator light goes off, and the anti-feedback function is switched off. The results of the correction process are stored in memory, though, so turning the function on again returns the function to its previous status. However, turning off the power clears the results of the correction.
- SA-300 does not respond to panel operations while in SWEEP calibration. It responds after the calibration is completed.
- The anti-feedback function does not work on LINE jack input.
- The sound quality is altered somewhat while the anti-feedback is operational.
- With some settings, feedback may not be suppressed, even after you have run the anti-feedback process with the SWEEP button.

About the Use of Stacks



When stacking, be sure to follow the instructions below.

- Be sure to set up and use these units in stable, level locations.
- Be careful not to get your fingers pinched.

- **Stack so that the speaker side of both the top cabinet and the bottom cabinet face the same direction.**



- **Adjust the horizontal position of the top cabinet so that the corner protectors are properly engaged and locked at all four corners between the top and bottom cabinets.**

Do not use the amplifiers without proper corner protector engagement. Otherwise, you risk having the top cabinet tumble down.

Always make sure that the corners are properly engaged before you use the amplifiers.

Using a Speaker Stand

By using a speaker stand, you can mount the SA-300 at the optimal height for use as a monitor speaker or simple PA device.

⚠ WARNING

- The SA-300 is designed to be used only with speaker stands whose dimensions meet the specifications described below.
Do not use it with a speaker stand that does not meet the following specifications.

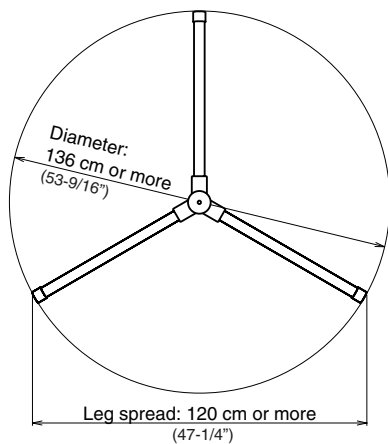
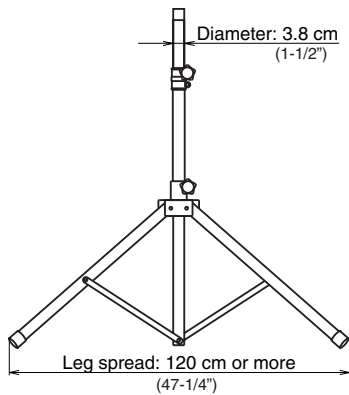

- Before use, adjust the speaker stand to a height of 140 cm (55-1/8") or less and a leg spread of 120 cm (47-1/4") or more, as shown in the figure below.

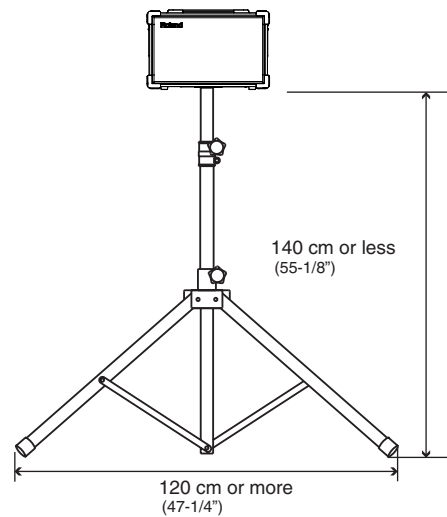

- Using a speaker stand that does not meet the specifications at left or that is adjusted to a height over 140 cm (55-1/8"), or a leg spread of less than 120 cm (47-1/4") may result in damage to equipment or injury due to the stand tipping over.
- When using SA-300 with a speaker stand, the speaker stand must be carefully placed so it is level and sure to remain stable.
- Cables connected to SA-300 should be given enough slack to prevent accidents that might result from someone tripping over them.
- To prevent accidents due to falls, do not place any object on the SA-300 when it's mounted on a speaker stand.
- Always have at least one other person assist you when mounting the SA-300 on a speaker stand, or when adjusting the height of the stand while the SA-300 remains mounted on it.

Block Diagram

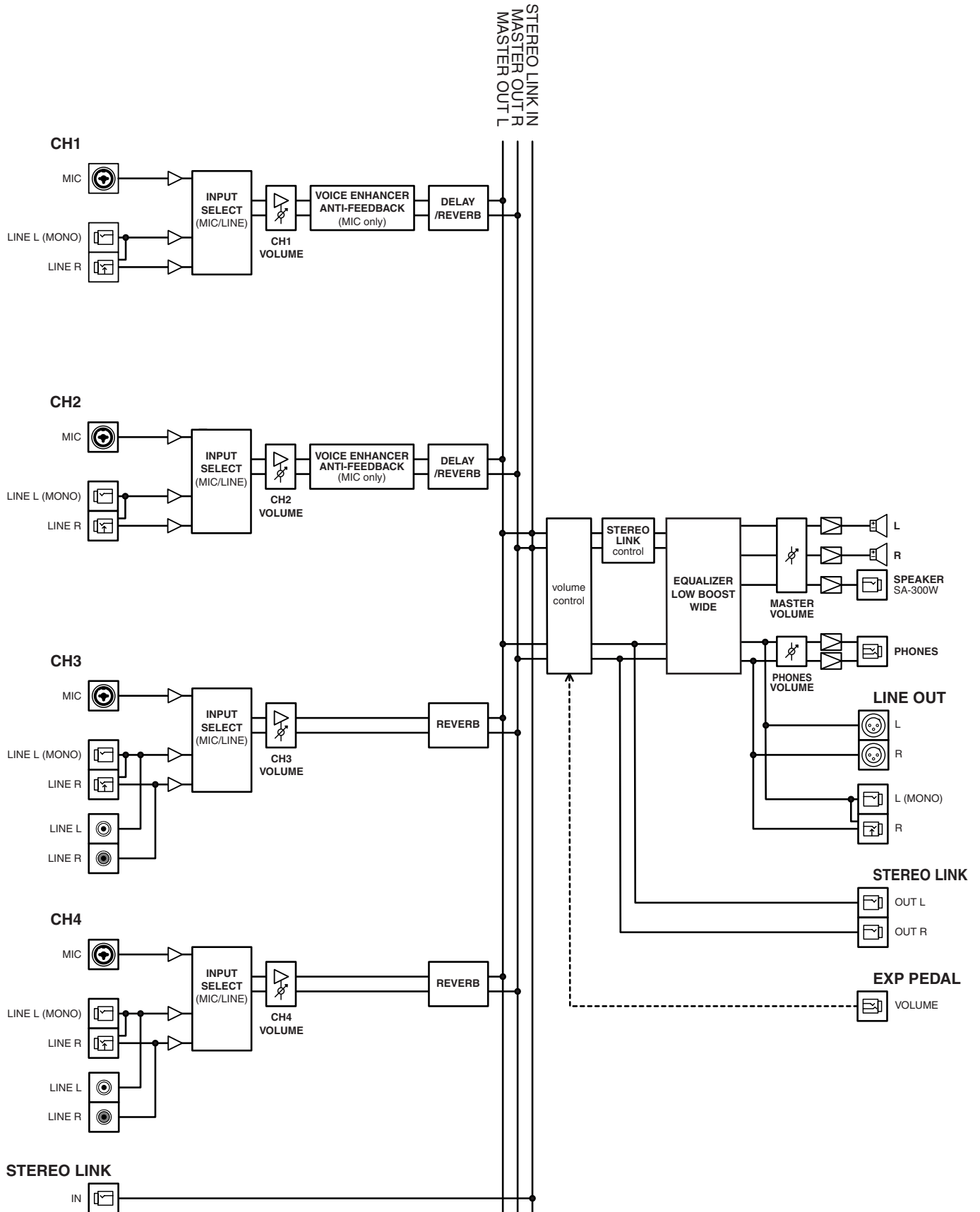

Main Specifications

SA-300

● Rated Power Output

350 W (75 W x 2 + SUBWOOFER 200 W)

● Nominal Input Level (1 kHz)

INPUT (MIC): -50 dBu
INPUT (PHONE): -20 dBu
INPUT (RCA): -20 dBu
STEREO LINK INPUT: 0 dBu

● Nominal Output Level (1 kHz)

LINE OUT: +4 dBu
BALANCED OUT: +4 dBu
STEREO LINK OUTPUT: 0 dBu

* 0 dBu = 0.775 Vrms

● Speakers

16 cm + Tweeter (Coaxial, 2-way) x 2
6.5 inches + Tweeter (Coaxial, 2-way) x 2

● Controls

[Channel Controls]

CH 1, CH 2

INPUT SELECT Button (MIC/LINE)
VOICE ENHANCER Button
Channel VOLUME Knob
REVERB/DELAY Knob
ANTI-FEEDBACK Button (ON/OFF)
ANTI-FEEDBACK SWEEP Button

CH 3, CH 4

INPUT SELECT Button (MIC/LINE)
Channel VOLUME Knob
REVERB Knob
PHANTOM Switch

[Master Controls]

Equalizer

LOW Knob
MIDDLE Knob
HIGH Knob
LOW BOOST Button
WIDE Button
MASTER VOLUME Knob
PHONES VOLUME Knob

POWER Switch
GND LIFT Switch

● Indicators

MIC, LINE (CH 1-CH 4)
ANTI-FEEDBACK ON/OFF (CH 1, CH 2)
ANTI-FEEDBACK SWEEP (CH 1, CH 2)
LEVEL METER
SUBWOOFER ACTIVE

● Connectors

CH 1, CH 2

MIC INPUT Jacks (XLR type, 1/4" TRS phone type)
LINE INPUT Jacks (L/MONO, R) (1/4" phone type)

CH 3, CH 4

MIC INPUT Jacks (XLR type, 1/4" TRS phone type, PHANTOM Power)
LINE INPUT Jacks (L/MONO, R) (1/4" phone type)
LINE INPUT Jacks L, R (RCA phono type)

Output

LINE OUTPUT Jacks (L/MONO, R) (1/4" phone type)
LINE OUTPUT Connectors L, R (XLR type)

Stereo Link

STEREO LINK IN Jack (1/4" phone type)
STEREO LINK OUT Jacks L, R (1/4" phone type)

Others

PHONES Jack (Stereo 1/4" phone type)
SUBWOOFER OUT Jack (1/4" phone type)
Foot SW Jacks (ANTI-FEEDBACK SWEEP) (1/4" phone type)
Foot SW Jack (EXP PEDAL/ REMOTE SW) (1/4" TRS phone type)

● Power Supply

AC 117 V, AC 220 V, AC 230 V, AC 240 V (50/60 Hz)

● Power Consumption

94 W

● Dimensions

456 (W) x 343 (D) x 297 (H) mm
18 (W) x 13-9/16 (D) x 11-3/4 (H) inches

● Weight

11.5 kg / 25 lbs 6 oz

SA-300W (SUBWOOFER)

- **Speaker**

30 cm / 12 inches

- **Nominal Impedance**

4 Ω

- **Connection**

INPUT Jack (1/4" phone type)

- **Dimensions**

456 (W) x 325 (D) x 510 (H) mm

18 (W) x 12-13/16 (D) x 20-1/8 (H) inches

- **Weight**

10.5 kg / 23 lbs 3 oz

- **Accessories**

Owner's Manual

Speaker connection cable

- **Options**

Foot Switch:

FS-5L (Mute) (BOSS)

FS-5U (ANTI-FEEDBACK / Effect) (BOSS)

FS-6 (BOSS)

Expression Pedal:

EV-5

FV-300L (BOSS)

FV-500L (BOSS)

FV-500H (BOSS)

Connection Cable: PCS-31

NOTE

In the interest of product improvement, the specifications and/or appearance of this unit are subject to change without prior notice.



This product complies with the requirements of European Directives EMC 89/336/EEC and LVD 73/23/EEC.

For EU Countries

FEDERAL COMMUNICATIONS COMMISSION RADIO FREQUENCY INTERFERENCE STATEMENT

For the USA

This equipment has been tested and found to comply with the limits for a Class B digital device, pursuant to Part 15 of the FCC Rules. These limits are designed to provide reasonable protection against harmful interference in a residential installation. This equipment generates, uses, and can radiate radio frequency energy and, if not installed and used in accordance with the instructions, may cause harmful interference to radio communications. However, there is no guarantee that interference will not occur in a particular installation. If this equipment does cause harmful interference to radio or television reception, which can be determined by turning the equipment off and on, the user is encouraged to try to correct the interference by one or more of the following measures:

- Reorient or relocate the receiving antenna.
- Increase the separation between the equipment and receiver.
- Connect the equipment into an outlet on a circuit different from that to which the receiver is connected.
- Consult the dealer or an experienced radio/TV technician for help.

This device complies with Part 15 of the FCC Rules. Operation is subject to the following two conditions:

- (1) This device may not cause harmful interference, and
- (2) This device must accept any interference received, including interference that may cause undesired operation.

Unauthorized changes or modification to this system can void the users authority to operate this equipment.
This equipment requires shielded interface cables in order to meet FCC class B Limit.

For Canada

NOTICE

This Class B digital apparatus meets all requirements of the Canadian Interference-Causing Equipment Regulations.

AVIS

Cet appareil numérique de la classe B respecte toutes les exigences du Règlement sur le matériel brouilleur du Canada.



Free Manuals Download Website

<http://myh66.com>

<http://usermanuals.us>

<http://www.somanuals.com>

<http://www.4manuals.cc>

<http://www.manual-lib.com>

<http://www.404manual.com>

<http://www.luxmanual.com>

<http://aubethermostatmanual.com>

Golf course search by state

<http://golfingnear.com>

Email search by domain

<http://emailbydomain.com>

Auto manuals search

<http://auto.somanuals.com>

TV manuals search

<http://tv.somanuals.com>