

BY WHIRLPOOL CORPORATION

ELECTRIC RANGE

Use & Care Guide

For questions about features, operation/performance, parts, accessories or service, call: **1-800-253-1301**.

or visit our website at...
www.roperappliances.com

Table of Contents	2
-------------------------	---

To the installer: Please leave this instruction book with the unit.

To the consumer: Please read and keep this book for future reference.

TABLE OF CONTENTS

RANGE SAFETY	3
The Anti-Tip Bracket	3
PARTS AND FEATURES	5
COOKTOP USE	6
Cooktop Controls.....	6
Ceramic Glass	6
Coil Elements and Burner Bowls	7
Lift-up Cooktop	7
Home Canning	8
Cookware	8
ELECTRONIC OVEN CONTROL	9
Oven Indicator Lights.....	9
Display	9
Start/Enter	9
Off/Cancel	9
Clock	9
Tones.....	9
Fahrenheit and Celsius.....	9
Timer.....	9
Control Lock.....	10
Oven Temperature Control	10
OVEN USE	11
Aluminum Foil.....	11
Positioning Racks and Bakeware	11
Bakeware.....	11
Meat Thermometer.....	12
Oven Vent.....	12
Baking and Roasting	12
Broiling and Custom Broiling	12
Timed Cooking.....	13
RANGE CARE	14
Self-Cleaning Cycle (on some models).....	14
General Cleaning.....	15
Oven Light	17
Oven Door	17
Storage Drawer	17
TROUBLESHOOTING	18
ASSISTANCE OR SERVICE	19
WARRANTY	20

RANGE SAFETY

Your safety and the safety of others are very important.

We have provided many important safety messages in this manual and on your appliance. Always read and obey all safety messages.



This is the safety alert symbol.

This symbol alerts you to potential hazards that can kill or hurt you and others.

All safety messages will follow the safety alert symbol and either the word "DANGER" or "WARNING."

These words mean:

⚠ DANGER

You can be killed or seriously injured if you don't immediately follow instructions.

⚠ WARNING

You can be killed or seriously injured if you don't follow instructions.

All safety messages will tell you what the potential hazard is, tell you how to reduce the chance of injury, and tell you what can happen if the instructions are not followed.

The Anti-Tip Bracket

The range will not tip during normal use. However, the range can tip if you apply too much force or weight to the open door without having the anti-tip bracket fastened down properly.

⚠ WARNING

Tip Over Hazard

A child or adult can tip the range and be killed.

Connect anti-tip bracket to rear range foot.

Reconnect the anti-tip bracket, if the range is moved.

See the installation instructions for details.

Failure to follow these instructions can result in death or serious burns to children and adults.

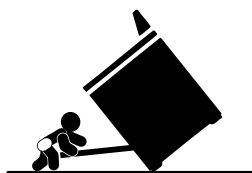

Anti-Tip Bracket

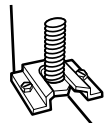

Range Foot

Making sure the anti-tip bracket is installed:

- Slide range forward.
- Look for the anti-tip bracket securely attached to floor.
- Slide range back so rear range foot is under anti-tip bracket.

The California Safe Drinking Water and Toxic Enforcement Act requires the Governor of California to publish a list of substances known to the State of California to cause cancer, birth defects, or other reproductive harm, and requires businesses to warn of potential exposure to such substances.

WARNING: This product contains a chemical known to the State of California to cause cancer, birth defects, or other reproductive harm.

This appliance can cause low-level exposure to some of the substances listed, including benzene, formaldehyde, carbon monoxide, and toluene.

IMPORTANT SAFETY INSTRUCTIONS

WARNING: To reduce the risk of fire, electrical shock, injury to persons, or damage when using the range, follow basic precautions, including the following:

- **WARNING:** TO REDUCE THE RISK OF TIPPING OF THE RANGE, THE RANGE MUST BE SECURED BY PROPERLY INSTALLED ANTI-TIP DEVICES. TO CHECK IF THE DEVICES ARE INSTALLED PROPERLY, SLIDE RANGE FORWARD, LOOK FOR ANTI-TIP BRACKET SECURELY ATTACHED TO FLOOR, AND SLIDE RANGE BACK SO REAR RANGE FOOT IS UNDER ANTI-TIP BRACKET.
 - **CAUTION:** Do not store items of interest to children in cabinets above a range or on the backguard of a range – children climbing on the range to reach items could be seriously injured.
 - Proper Installation – Be sure the range is properly installed and grounded by a qualified technician.
 - Never Use the Range for Warming or Heating the Room.
 - Do Not Leave Children Alone – Children should not be left alone or unattended in area where the range is in use. They should never be allowed to sit or stand on any part of the range.
 - Wear Proper Apparel – Loose-fitting or hanging garments should never be worn while using the range.
 - User Servicing – Do not repair or replace any part of the range unless specifically recommended in the manual. All other servicing should be referred to a qualified technician.
 - Storage in or on the Range – Flammable materials should not be stored in an oven or near surface units.
 - Do Not Use Water on Grease Fires – Smother fire or flame or use dry chemical or foam-type extinguisher.
 - Use Only Dry Potholders – Moist or damp potholders on hot surfaces may result in burns from steam. Do not let potholder touch hot heating elements. Do not use a towel or other bulky cloth.
 - DO NOT TOUCH SURFACE UNITS OR AREAS NEAR UNITS – Surface units may be hot even though they are dark in color. Areas near surface units may become hot enough to cause burns. During and after use, do not touch, or let clothing or other flammable materials contact surface units or areas near units until they have had sufficient time to cool. Among those areas are the cooktop and surfaces facing the cooktop.
 - Use Proper Pan Size – The range is equipped with one or more surface units of different size. Select utensils having flat bottoms large enough to cover the surface unit heating element. The use of undersized utensils will expose a portion of the heating element to direct contact and may result in ignition of clothing. Proper relationship of utensil to burner will also improve efficiency.
 - Never Leave Surface Units Unattended at High Heat Settings – Boilover causes smoking and greasy spillovers that may ignite.
 - Make Sure Reflector Pans or Drip Bowls Are in Place – Absence of these pans or bowls during cooking may subject wiring or components underneath to damage.
 - Protective Liners – Do not use aluminum foil to line surface unit drip bowls or oven bottoms, except as suggested in the manual. Improper installation of these liners may result in a risk of electric shock, or fire.
 - Glazed Cooking Utensils – Only certain types of glass, glass/ceramic, ceramic, earthenware, or other glazed utensils are suitable for range-top service without breaking due to the sudden change in temperature.
 - Utensil Handles Should Be Turned Inward and Not Extend Over Adjacent Surface Units – To reduce the risk of burns, ignition of flammable materials, and spillage due to unintentional contact with the utensil, the handle of a utensil should be positioned so that it is turned inward, and does not extend over adjacent surface units.
 - Do Not Soak Removable Heating Elements – Heating elements should never be immersed in water.
 - Do Not Cook on Broken Cooktop – If cooktop should break, cleaning solutions and spillovers may penetrate the broken cooktop and create a risk of electric shock. Contact a qualified technician immediately.
 - Clean Cooktop With Caution – If a wet sponge or cloth is used to wipe spills on a hot cooking area, be careful to avoid steam burn. Some cleaners can produce noxious fumes if applied to a hot surface.
 - Use Care When Opening Door – Let hot air or steam escape before removing or replacing food.
 - Do Not Heat Unopened Food Containers – Build-up of pressure may cause container to burst and result in injury.
 - Keep Oven Vent Ducts Unobstructed.
 - Placement of Oven Racks – Always place oven racks in desired location while oven is cool. If rack must be moved while oven is hot, do not let potholder contact hot heating element in oven.
 - DO NOT TOUCH HEATING ELEMENTS OR INTERIOR SURFACES OF OVEN – Heating elements may be hot even though they are dark in color. Interior surfaces of an oven become hot enough to cause burns. During and after use, do not touch, or let clothing or other flammable materials contact heating elements or interior surfaces of oven until they have had sufficient time to cool. Other surfaces of the appliance may become hot enough to cause burns – among these surfaces are oven vent openings and surfaces near these openings, oven doors, and windows of oven doors.
- For self-cleaning ranges –**
- Do Not Clean Door Gasket – The door gasket is essential for a good seal. Care should be taken not to rub, damage, or move the gasket.
 - Do Not Use Oven Cleaners – No commercial oven cleaner or oven liner protective coating of any kind should be used in or around any part of the oven.
 - Clean Only Parts Listed in Manual.
 - Before Self-Cleaning the Oven – Remove broiler pan and other utensils.
- For units with ventilating hood –**
- Clean Ventilating Hoods Frequently – Grease should not be allowed to accumulate on hood or filter.
 - When flaming foods under the hood, turn the fan on.

SAVE THESE INSTRUCTIONS

PARTS AND FEATURES

This manual covers several different models. The range you have purchased may have some or all of the parts and features listed. The location and appearance of the features shown here may not match those of your model.

Control Panel

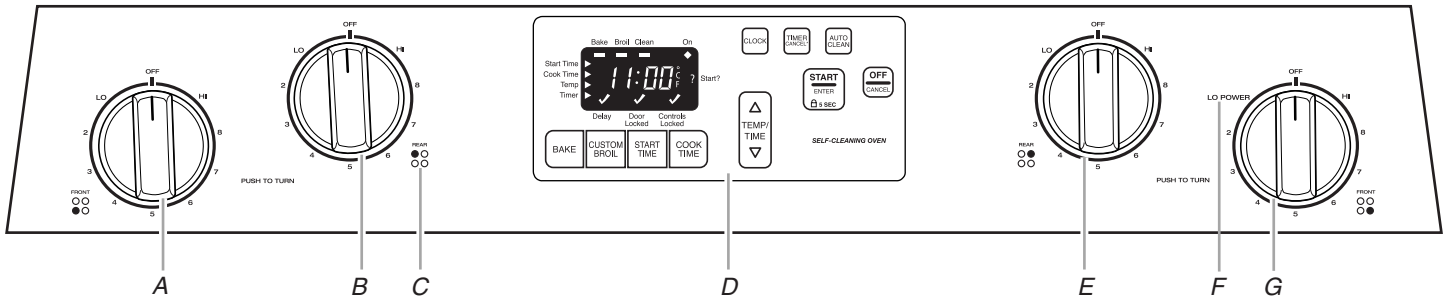

- A. Left front control knob
- B. Left rear control knob
- C. Surface cooking locator indicator

- D. Electronic oven control
- E. Right rear control knob

- F. Lo power indicator (on some models)
- G. Right front control knob

Range

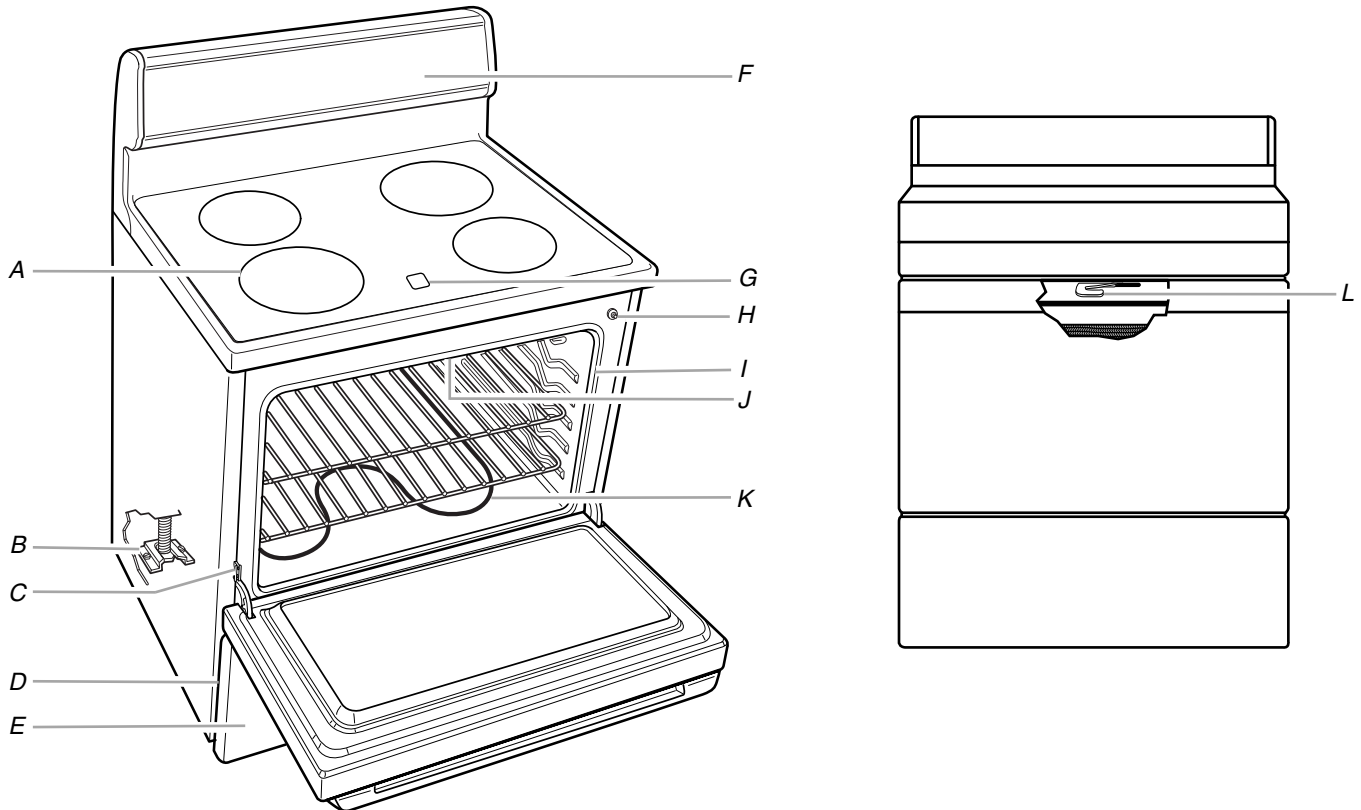

- A. Surface cooking area or element
- B. Anti-tip bracket
- C. Door stop clip
- D. Model and serial number plate (behind left side of storage drawer)
- E. Storage drawer
- F. Control panel

- G. Hot surface indicator light (on ceramic glass models)
- H. Automatic oven light switch (on some models)
- I. Gasket
- J. Broil element (not shown)
- K. Bake element
- L. Self-clean latch (on some models)

Parts and Features not shown (on some models)

- Coil elements
- Oven door window
- Oven light
- Manual oven light switch

COOKTOP USE

Cooktop Controls

! WARNING



Fire Hazard

Turn off all controls when done cooking.
Failure to do so can result in death or fire.

The control knobs can be set anywhere between HI and LO. Push in and turn to setting. On some models, the surface cooking area locator shows which element is turned on. Use the following chart as a guide when setting heat levels.

SETTING	RECOMMENDED USE
HI	<ul style="list-style-type: none"> Start food cooking. Bring liquid to a boil.
Medium High 6-8	<ul style="list-style-type: none"> Hold a rapid boil. Quickly brown or sear food.
Medium 5	<ul style="list-style-type: none"> Maintain a slow boil. Fry or sauté foods.
Medium Low 2-4	<ul style="list-style-type: none"> Cook soups, sauces and gravies. Stew or steam food.
LO	<ul style="list-style-type: none"> Simmer. Keep food warm. Melt chocolate or butter.

REMEMBER: When range is in use or (on some models) during the Self-Cleaning cycle, the entire cooktop area may become hot.

NOTE: On self-cleaning models, the cooktop will not operate when the range is in a self-cleaning mode.

Ceramic Glass (on some models)

The surface cooking area will glow red when an element is on. It will cycle on and off, at all settings, to maintain the selected heat level.

It is normal for the surface of white ceramic glass to appear to change color when surface cooking areas are hot. As the glass cools, it will return to its original color.

Wiping off the cooktop before and after each use will help keep it free from stains and provide the most even heating. On cooktops with white ceramic glass, soils and stains may be more visible, and may require more cleaning and care. For more information, see "General Cleaning" section.

- Do not store jars or cans above the cooktop. Dropping a heavy or hard object onto the cooktop could crack the cooktop.
- Do not leave a hot lid on the cooktop. As the cooktop cools, air can become trapped between the lid and the cooktop, and the ceramic glass could break when the lid is removed.
- For foods containing sugar in any form, clean up all spills and soils as soon as possible. Allow the cooktop to cool down slightly. Then, while wearing oven mitts, remove the spills while the surface is still warm. If sugary spills are allowed to cool down, they can adhere to the cooktop and can cause pitting and permanent marks.
- Do not slide cookware or bakeware across the cooktop. Aluminum or copper bottoms and rough finishes on cookware or bakeware could leave scratches or marks on the cooktop.
- Do not cook popcorn in prepackaged aluminum containers on the cooktop. They could leave aluminum marks that cannot be removed completely.
- Do not allow objects that could melt, such as plastic or aluminum foil, to touch any part of the entire cooktop.
- Do not use the cooktop as a cutting board.
- Use cookware about the same size as the surface cooking area. Cookware should not extend more than ½" (1.3 cm) outside the area.

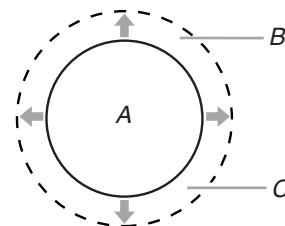

A. Surface cooking area
 B. Cookware/canner
 C. ½" (1.3 cm) Maximum overhang

- Use flat-bottomed cookware for best heat conduction and energy efficiency. Cookware with rounded, warped, ribbed or dented bottoms could cause uneven heating and poor cooking results.
- Determine flatness by placing the straight edge of a ruler across the bottom of the cookware. While you rotate the ruler, no space or light should be visible between it and the cookware.
- Cookware designed with slightly indented bottoms or small expansion channels can be used.
- Make sure the bottoms of pots and pans are clean and dry before using them. Residue and water can leave deposits when heated.
- Do not cook foods directly on the cooktop.

Hot Surface Indicator Light (under ceramic glass)

The hot surface indicator light will glow as long as any surface cooking area is too hot to touch, even after the surface cooking area(s) is turned off.

Coil Elements and Burner Bowls
(on some models)

Coil elements should be level for optimal cooking results. Burner bowls, when clean, reflect heat back to the cookware. They also help catch spills.

Cookware should not extend more than 1/2" (1.3 cm) over the coil element. If cookware is uneven or too large, it can produce excess heat causing the burner bowl to change color. For more information, see the "General Cleaning" section.

NOTE: Before removing or replacing coil elements and burner bowls, make sure they are cool and the control knobs are in the Off position.

To Remove:

1. Push in the edge of coil element toward the receptacle. Then lift it just enough to clear the burner bowl.

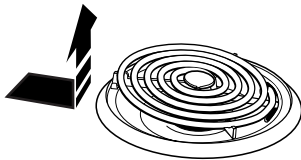

2. Pull the coil element straight away from the receptacle.

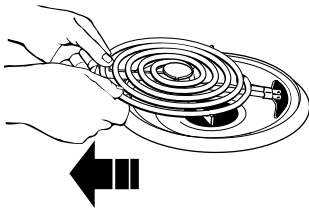

3. Lift out the burner bowl.

To Replace:

1. Line up openings in the burner bowl with the coil element receptacle.



2. Holding the coil element as level as possible, slowly push coil element terminal into the receptacle.
3. When the terminal is pushed into the receptacle as far as it will go, push down the edge of the coil element opposite the receptacle.

Lift-up Cooktop
(on some models)

The lift-up cooktop provides easy access for cleaning beneath. Do not drop the cooktop. Damage could occur to the finish and the cooktop frame. For more information, see the "General Cleaning" section.

To Lift:

Lift the cooktop by both front corners until the supports lock into place.

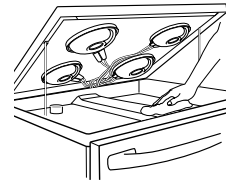

To Replace:

1. Lift the cooktop from both sides while pressing the support rods back to unlock them.
2. Slowly lower the cooktop into place.

Home Canning

When canning for long periods, alternate the use of surface cooking areas, elements or surface burners between batches. This allows time for the most recently used areas to cool.

- Center the canner on the grate or largest surface cooking area or element. Canners should not extend more than ½" (1.3 cm) outside the cooking area.
 - Do not place canner on two surface cooking areas, elements or surface burners at the same time.
 - On ceramic glass models, use only flat-bottomed canners.
 - On coil element models, the installation of a Canning Unit Kit is recommended. If a kit is not installed, the life of the coil element will be shortened. See "Assistance or Service" for ordering instructions.
 - For more information, contact your local U.S. Government Agricultural Department Extension Office. Companies that manufacture home canning products can also offer assistance.
-

Cookware

IMPORTANT: Do not leave empty cookware on a hot surface cooking area, element or surface burner.

Ideal cookware should have a flat bottom, straight sides and a well-fitting lid, and the material should be of medium-to-heavy thickness.

Rough finishes may scratch the cooktop. Aluminum and copper may be used as a core or base in cookware. However, when used as a base they can leave permanent marks on the cooktop or grates.

Cookware material is a factor in how quickly and evenly heat is transferred, which affects cooking results. A nonstick finish has the same characteristics as its base material. For example, aluminum cookware with a nonstick finish will take on the properties of aluminum.

Cookware with nonstick surfaces should not be used under the broiler.

Use the following chart as a guide for cookware material characteristics.

COOKWARE	CHARACTERISTICS
Aluminum	<ul style="list-style-type: none">■ Heats quickly and evenly.■ Suitable for all types of cooking.■ Medium or heavy thickness is best for most cooking tasks.
Cast iron	<ul style="list-style-type: none">■ Heats slowly and evenly.■ Good for browning and frying.■ Maintains heat for slow cooking.
Ceramic or Ceramic glass	<ul style="list-style-type: none">■ Follow manufacturer's instructions.■ Heats slowly, but unevenly.■ Ideal results on low to medium heat settings.
Copper	<ul style="list-style-type: none">■ Heats very quickly and evenly.
Earthenware	<ul style="list-style-type: none">■ Follow manufacturer's instructions.■ Use on low heat settings.
Porcelain enamel-on-steel or cast iron	<ul style="list-style-type: none">■ See stainless steel or cast iron.
Stainless steel	<ul style="list-style-type: none">■ Heats quickly, but unevenly.■ A core or base of aluminum or copper on stainless steel provides even heating.

ELECTRONIC OVEN CONTROL

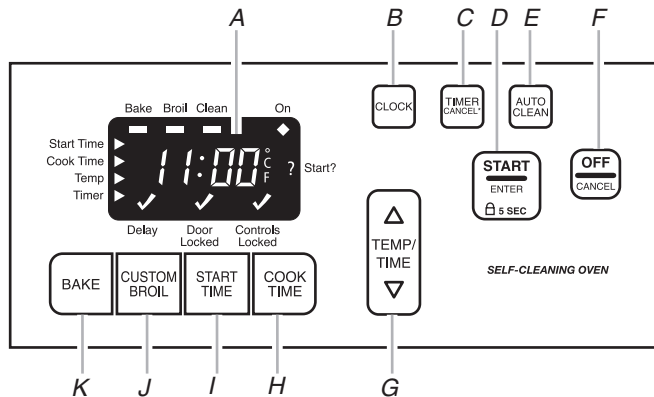

- A. Oven display
B. Clock
C. Timer/cancel
D. Start/enter (control lock)
E. Auto clean
F. Off/cancel
G. Temperature/time
H. Cook time
I. Start time
J. Custom broil
K. Bake

Oven Indicator Lights

The indicator lights are located along all 4 sides of the display. The indicator lights light up or flash when the oven is in one of the following modes: Bake, Broil, Clean (on some models), On, Start?, Controls Locked, Door Locked (on some models), Delay, Timer, Temp, Cook Time, or Start Time.

Display

When power is first supplied to the appliance, "PF" or a flashing time will appear on the display. Press OFF/CANCEL to clear.

If "PF" or a flashing time appears at any other time, a power failure has occurred. Press OFF/CANCEL and reset the clock if needed.

When the oven is in use, the display shows preheat time or oven temperature setting.

When the oven is not in use, the display shows the time of day.

When using Start Time/Cook Time, the display will show either hours and minutes, or minutes and seconds.

If Start/Enter is not pressed after setting a function, the "Start?" oven indicator light will begin flashing after 5 seconds.

Start/Enter

The Start/Enter pad begins any oven function. If the Start/Enter pad is not pressed within 5 seconds after pressing a function pad, the "Start?" indicator light will flash as a reminder.

If Start/Enter is not pressed within 1 minute after pressing a function pad, the oven display will return to the time of day mode and the programmed function will be canceled.

Off/Cancel

The Off/Cancel pad stops any function except the Clock, Timer and Control Lock.

The cooling fan may continue to operate after an oven function has been canceled, depending on oven temperature.

Clock

This is a 12-hour clock and does not show a.m. or p.m.

To Set:

Before setting, make sure the oven and Timer are off.

1. Press CLOCK.
2. Press the TEMP/TIME "up" or "down" arrow pad to set the time of day.
3. Press START/ENTER or CLOCK.

Tones

Tones are audible signals, indicating the following:

One tone

- Valid pad press
- Oven is preheated (long tone)
- Function has been entered
- Reminder, repeating each minute after the end-of-cycle tones

Three tones

- Invalid pad press

Four tones

- End of cycle

Fahrenheit and Celsius

The temperature is preset at Fahrenheit, but can be changed to Celsius on some models.

To Change: Press and hold CUSTOM BROIL for 5 seconds. A tone will sound, and "°C" will appear on the display. Repeat to change back to Fahrenheit. To exit mode, press OFF/CANCEL.

Timer

The Timer can be set in hours or minutes up to 12 hours and 59 minutes and counts down the set time.

NOTE: The Timer does not start or stop the oven.

To Set:

1. Press TIMER CANCEL*.
The timer oven indicator light will light up. If no action is taken after 1 minute, the display will return to the time of day mode.
2. Press the TEMP/TIME "up" or "down" arrow pad to set the length of time.
3. Press START/ENTER.
When the set time ends, four 1-second tones will sound.
4. Press TIMER CANCEL* anytime to cancel the timer and/or stop reminder tones. To cancel the timer during the countdown, press TIMER CANCEL* twice.

The time can be reset during the countdown by repeating the above steps. To display the time of day when the timer is counting down, press CLOCK.

Control Lock

The Control Lock shuts down the control panel pads to prevent unintended use of the oven.

When the control is locked, only the Clock and Timer pads will function.

To Lock/Unlock Control: Before locking, make sure the oven and Timer are off. Touch and hold START/ENTER for 5 seconds. A single tone will sound, and "LOC" and "LOCK'D" (on some models) will appear on the display. "LOC" will also appear whenever any command pad is pressed while the control is locked.

Repeat to unlock. "LOC" and "LOCK'D" (on some models) will disappear from the display.

Oven Temperature Control

IMPORTANT: Do not use a thermometer to measure oven temperature because opening the oven door and element or burner cycling may give incorrect readings.

The oven provides accurate temperatures; however, it may cook faster or slower than your previous oven, so the temperature calibration can be adjusted.

A minus sign means the oven will be cooler by the displayed amount. The absence of a sign means the oven will be warmer by the displayed amount. Use the following chart as a guide.

ADJUSTMENT °F	COOKS FOOD
10°F (5°C)	...a little more
20°F (10°C)	...moderately more
30°F (15°C)	...much more
-10°F (-5°C)	...a little less
-20°F (-10°C)	...moderately less
-30°F (-15°C)	...much less

To Adjust Oven Temperature Calibration:

1. Press and hold BAKE for 5 seconds until the oven display shows the current calibration, for example "00."
2. Press the TEMP/TIME "up" or "down" arrow pad to increase or to decrease the temperature in 10°F amounts. The adjustment can be set between 30°F and -30°F.

NOTE: All temperature adjustments will be displayed in Fahrenheit.

3. Press START/ENTER.

To Adjust Oven Temperature Calibration (on models with manual oven control):

1. Make sure the oven temperature control knob is in the OFF position. Pull oven temperature control knob straight off and turn it over.

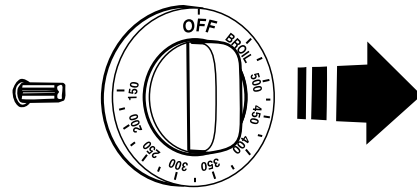

2. Loosen the locking screws inside the oven temperature control knob.

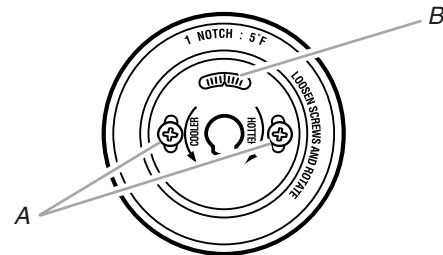

3. Adjust temperature.

To lower the temperature, hold the knob handle firmly and turn skirt counterclockwise to move the tooth a notch to the left.

To raise the temperature, hold the knob handle firmly and turn the skirt clockwise to move the tooth a notch to the right.

Each notch equals about 5°F (3°C).

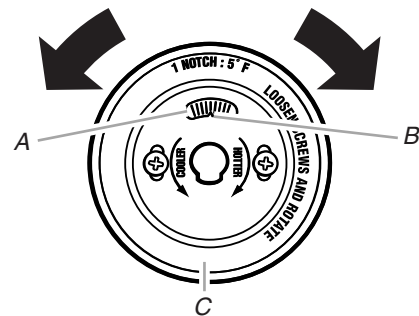

- A. Notches
- B. Tooth
- C. Skirt

4. Tighten the locking screws and replace knob.

OVEN USE

Odors and smoke are normal when the oven is used the first few times, or when it is heavily soiled.

IMPORTANT: The health of some birds is extremely sensitive to the fumes given off. Exposure to the fumes may result in death to certain birds. Always move birds to another closed and well-ventilated room.

Aluminum Foil

IMPORTANT: Do not line the oven bottom with any type of foil, liners or cookware because permanent damage will occur to the oven bottom finish.

- Do not cover entire rack with foil because air must be able to move freely for best cooking results.
- To catch spills, place foil on rack below dish. Make sure foil is at least 1" (2.5 cm) larger than the dish and that it is turned up at the edges.

Positioning Racks and Bakeware

IMPORTANT: Do not place food or bakeware directly on the oven door or bottom. Permanent damage will occur to the porcelain finish.

RACKS

NOTES:

- Position racks before turning the oven on.
- Do not move racks with bakeware on them.
- Make sure racks are level.

To move a rack, pull it out to the stop position, raise the front edge, then lift out. Use the following illustration and chart as a guide.

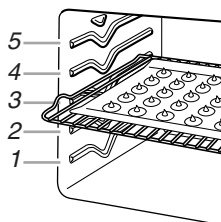

FOOD	RACK POSITION(S)
Frozen pies, large roasts, turkeys, angel food cakes	1 or 2
Bundt cakes, most quick breads, yeast breads, casseroles, meats	2
Cookies, biscuits, muffins, cakes, nonfrozen pies	2 or 3

BAKEWARE

Hot air must be able to circulate around food to cook evenly, so allow 2" (5 cm) of space around bakeware and oven walls. Use the following chart as a guide.

NUMBER OF PAN(S)	POSITION ON RACK
1	Center of rack.
2	Side by side or slightly staggered.
3 or 4	Opposite corners on each rack. Make sure that no bakeware piece is directly over another.

Bakeware

The bakeware material affects cooking results. Follow manufacturer's recommendations and use the bakeware size recommended in the recipe. Use the following chart as a guide.

BAKEWARE/ RESULTS	RECOMMENDATIONS
Light colored aluminum <ul style="list-style-type: none"> ■ Light golden crusts ■ Even browning 	<ul style="list-style-type: none"> ■ Use temperature and time recommended in recipe.
Dark aluminum and other bakeware with dark, dull and/or nonstick finish <ul style="list-style-type: none"> ■ Brown, crisp crusts 	<ul style="list-style-type: none"> ■ May need to reduce baking temperatures 25°F (15°C). ■ Use suggested baking time. ■ For pies, breads and casseroles, use temperature recommended in recipe. ■ Place rack in center of oven.
Insulated cookie sheets or baking pans <ul style="list-style-type: none"> ■ Little or no bottom browning 	<ul style="list-style-type: none"> ■ Place in the bottom third of oven. ■ May need to increase baking time.
Stainless steel <ul style="list-style-type: none"> ■ Light, golden crusts ■ Uneven browning 	<ul style="list-style-type: none"> ■ May need to increase baking time.
Stoneware <ul style="list-style-type: none"> ■ Crisp crusts 	<ul style="list-style-type: none"> ■ Follow manufacturer's instructions.
Ovenproof glassware, ceramic glass or ceramic <ul style="list-style-type: none"> ■ Brown, crisp crusts 	<ul style="list-style-type: none"> ■ May need to reduce baking temperatures 25°F (15°C).

Meat Thermometer

On models without a temperature probe, always rely on a meat thermometer to determine doneness of meat and poultry. The internal temperature, not appearance, is what counts. A meat thermometer is not supplied with this appliance.

- Insert the thermometer into the center of the thickest portion of the meat or inner thigh or breast of poultry. The tip of the thermometer should not touch fat, bone or gristle.
- After reading the thermometer once, push it into the meat ½" (1.25 cm) more and read again. If the temperature drops, cook the meat or poultry longer.
- Check all meat in 2 or 3 places.

Oven Vent

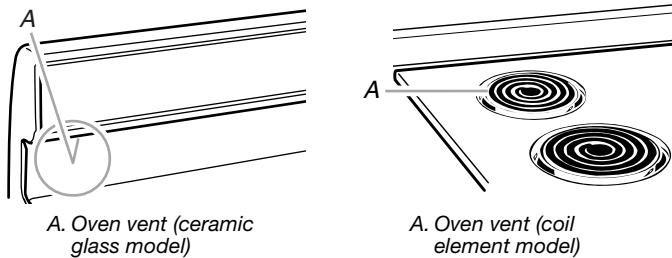

The oven vent releases hot air and moisture from the oven, and should not be blocked or covered. Blocking or covering the vent will cause poor air circulation, affecting cooking and cleaning results. Do not set plastics, paper or other items that could melt or burn near the oven vent.

On coil element models, the element can be used when the oven is in use as long as the cookware does not extend more than ½" (1.3 cm) over the element.

Baking and Roasting

Before baking and roasting, position racks according to the "Positioning Racks and Bakeware" section. When roasting, it is not necessary to wait for the oven preheat conditioning time to end before putting food in unless recommended in the recipe.

To Bake or Roast:

1. Press **BAKE**. The bake oven indicator light will light up.
2. Set the temperature (optional).
Press **TEMP/TIME** "up" or "down" arrow pad to set a temperature other than 350°F (177°C) in 5°F (3°C) amounts. The bake range can be set between 170°F (77°C) and 500°F (260°C).

When the oven temperature is greater than 170°F (77°C), no preheat conditioning time will be shown in the display.

The preheat conditioning time will not change if the temperature is reset before the countdown time ends.

If baking and roasting while the minute timer is counting down, the set temperature can be seen for 5 seconds by pressing **BAKE**.

3. Press **START/ENTER**.

The oven control automatically sets preheating times based on the oven temperature selected.

The temperature can be changed after this step. **START/ENTER** does not need to be pressed again.

After the oven is preheated and the countdown time is finished, a 1-second tone will sound, the **ON** indicator light will go off and the set temperature will appear on the display.

4. Press **OFF/CANCEL** when finished.

Preheating

After **START/ENTER** is pressed, the oven will enter a timed preheat conditioning. "PrE" and the time countdown will appear on the display. When the preheat conditioning time ends, a tone will sound and the selected temperature will appear on the display.

Preheat temperatures are affected by varying factors such as room temperature and peak energy usage times. It is normal for the temperature showing on the display and the actual oven temperature to differ.

Waiting an additional 10 minutes after the preheat conditioning time ends to put food in the oven is suggested when baking foods with leavening ingredients, such as yeast, baking powder, baking soda and eggs.

Broiling and Custom Broiling

Broiling uses direct radiant heat to cook food. Changing the temperature when Custom Broiling allows more precise control when cooking. The lower the temperature, the slower the cooking. Thicker cuts and unevenly shaped pieces of meat, fish and poultry may cook better at lower broiling temperatures.

If your model does not have a broiler pan, one may be ordered. Ask for Part Number 4396923.

- For best results, use a broiler pan and grid (provided on some models). They are designed to drain juices and help prevent spatter and smoke.
- For proper draining, do not cover the grid with foil. The bottom of the pan may be lined with aluminum foil for easier cleaning.
- Trim excess fat to reduce spattering. Slit the remaining fat on the edges to prevent curling.
- Pull out oven rack to stop position before turning or removing food. Use tongs to turn food to avoid the loss of juices. Very thin cuts of fish, poultry or meat may not need to be turned.
- After broiling, remove the pan from the oven when removing the food. Drippings will bake on the pan if left in the heated oven, making cleaning more difficult.

Before broiling, position rack according to Broiling Chart. It is not necessary to preheat the oven before putting food in unless recommended in the recipe. Position food on grid in the broiler pan, then place it in the center of the oven rack. Close the door to the broil stop position to ensure proper broiling temperature.

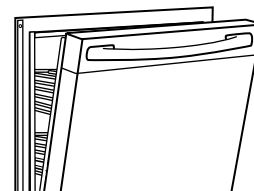

To Broil:

1. Press CUSTOM BROIL. The broil oven indicator light will light up.
2. Press START/ENTER. The On and Heat oven indicator lights will light up.
The temperature setting can be changed any time before or after pressing START/ENTER. See "Custom Broiling" section.
If broiling while the time is counting down, the set broiling temperature can be seen for 5 seconds by pressing CUSTOM BROIL.
3. Press OFF/CANCEL when finished.

Custom Broiling

If foods are cooking too fast, press the TEMP/TIME "up" or "down" arrow pad until 325°F (163°C) shows on the display.

1. Press CUSTOM BROIL to broil foods slower from the start of cooking.
2. Press the TEMP/TIME "up" or "down" arrow pad to enter a temperature between 300°F and 500°F (149°C and 260°C).
3. Press START/ENTER.
4. Press OFF/CANCEL when finished.

BROILING CHART

For best results, place food 3" (7 cm) or more from the broil element. Times are guidelines only and may need to be adjusted for individual foods and tastes. Recommended rack positions are numbered from the bottom (1) to the top (5). For diagram, see the "Positioning Racks and Bakeware" section.

FOOD	RACK POSITION	COOK TIME (in minutes)	
		Side 1	Side 2
Steak 1" (2.5 cm) thick			
medium rare	4	14-15	7-8
medium	4	15-16	8-9
well-done	4	18-19	9-10
Ground meat patties* ¾" (2 cm) thick			
well-done	4	13-14	7-8
Pork chops 1" (2.5 cm) thick	4	20-22	10-11
Ham slice, precooked ½" (1.25 cm) thick	4	8-10	4-5
Frankfurters	4	5-7	3-4
Lamb chops 1" (2.5 cm) thick	4	14-17	8-9
Chicken bone-in pieces	3	17-20	17-20
boneless breasts	4	11-16	11-16
Fish Fillets ¼-½" (0.6-1.25 cm) thick	4	8-10	4-5
Steaks 1" (2.5 cm) thick	4	16-18	8-9

*Place up to 9 patties, equally spaced, on broiler grid.

Timed Cooking

⚠ WARNING

Food Poisoning Hazard

Do not let food sit in oven more than one hour before or after cooking.

Doing so can result in food poisoning or sickness.

Timed Cooking allows the oven to be set to turn on at a certain time of day, cook for a set length of time, and/or shut off automatically. Delay start should not be used for foods such as breads and cakes because they may not bake properly.

To Set a Cook Time:

1. Press BAKE. The bake oven indicator light will light up.
2. Set the temperature (optional).
Press the TEMP/TIME "up" or "down" arrow pads to enter a temperature other than the one displayed.
3. Press COOK TIME. The cook time oven indicator light will light up.
4. Press TEMP/TIME "up" or "down" arrow pads to enter the length of time to cook.
5. Press START/ENTER.
The display will count down the time.

When the time ends, the oven will shut off automatically and "End" will appear on the display.

6. Press OFF/CANCEL or open the oven door to clear the display.

To Set a Delayed Cook Time:

Before setting, make sure the clock is set to the correct time of day. See "Clock" section.

1. Press BAKE.
2. Set the temperature (optional).
Press the TEMP/TIME "up" or "down" arrow pads to enter a temperature other than the one displayed.
3. Press COOK TIME.
The cook time oven indicator light will light up.
4. Press the TEMP/TIME "up" or "down" arrow pads to enter the length of time to cook.
5. Press START TIME.
The start time/delay oven indicator light will light up.
6. Press the TEMP/TIME "up" or "down" arrow pads to enter the time of day to start.
7. Press START/ENTER.

When the start time is reached, the oven will automatically turn on.

The temperature and/or time settings can be changed any time after pressing START/ENTER by repeating steps 2-7.

When the set cook time ends, the oven will shut off automatically and "End" will appear on the display.

8. Press OFF/CANCEL or open the oven door to clear the display.

RANGE CARE

Self-Cleaning Cycle (on some models)

⚠ WARNING



Burn Hazard

Do not touch the oven during the Self-Cleaning cycle.

Keep children away from oven during Self-Cleaning cycle.

Failure to follow these instructions can result in burns.

IMPORTANT: The health of some birds is extremely sensitive to the fumes given off during the Self-Cleaning cycle. Exposure to the fumes may result in death to certain birds. Always move birds to another closed and well-ventilated room.

Self-clean the oven before it becomes heavily soiled. Heavy soil results in longer cleaning and more smoke.

Keep the kitchen well-ventilated during the Self-Cleaning cycle to help get rid of heat, odors, and smoke.

Do not block the oven vent(s) during the Self-Cleaning cycle. Air must be able to move freely. Depending on your model, see "Oven Vent" or "Oven Vents" section.

Do not clean, rub, damage or move the oven door gasket. The door gasket is essential for a good seal.

Prepare Oven:

- Remove the broiler pan, grid, cookware and bakeware and, on some models, the temperature probe from the oven.
- Remove any foil from the oven because it may burn or melt, damaging the oven.
- Remove oven racks to keep them shiny and easy to slide. See "General Cleaning" section for more information.
- Hand clean inside door edge and the 1½" (3.8 cm) area around the inside oven cavity frame, being certain not to move or bend the gasket. This area does not get hot enough during self-cleaning to remove soil. Do not let water, cleaner, etc. enter slots on door frame. Use a damp cloth to clean this area.
- Wipe out any loose soil to reduce smoke and avoid damage. At high temperatures, foods react with porcelain. Staining, etching, pitting or faint white spots can result. This will not affect cooking performance.

Prepare Cooktop and Storage Drawer:

- Remove plastic items from the cooktop because they may melt.
- Remove all items from the storage drawer.

How the Cycle Works

IMPORTANT: The heating and cooling of porcelain on steel in the oven may result in discoloring, loss of gloss, hairline cracks and popping sounds.

The Self-Cleaning cycle uses very high temperatures, burning soil to a powdery ash.

The oven is preset for a 3 hour 30 minute clean cycle, but the time can be changed. Suggested clean times are 2 hours 30 minutes for light soil and between 3 hours 30 minutes and 4 hours 30 minutes for average to heavy soil.

Once the oven has completely cooled, remove ash with a damp cloth. Do not wipe down any of the inside surfaces until the oven has completely cooled down. Applying a cool, damp cloth to the inner door glass before it has cooled completely could result in the glass breaking.

The oven light will not work during the Self-Cleaning cycle.

To Self-Clean:

Before self-cleaning, make sure the door is closed completely or it will not lock and the cycle will not begin.

1. Press AUTO CLEAN.
2. Press the TEMP/TIME "up" or "down" arrow pad to set a clean time other than 3 hours 30 minutes. The clean time can be set between 2 hours 30 minutes and 4 hours 30 minutes.
3. Press START/ENTER.

The oven door will automatically lock. The ON and DOOR LOCKED oven indicator lights will light up. The door will not unlock until the oven cools.

When the cycle is complete and the oven cools, "End" will appear on the oven display and the oven indicator lights will go off.

4. Press OFF/CANCEL to clear the oven display.

To Stop Self-Clean anytime:

Press OFF/CANCEL. If the oven temperature is too high, the door will remain locked. It will not unlock until the oven cools.

General Cleaning

IMPORTANT: Before cleaning, make sure all controls are off and the oven and cooktop are cool. Always follow label instructions on cleaning products.

Soap, water and a soft cloth or sponge are suggested first unless otherwise noted.

EXTERIOR PORCELAIN ENAMEL SURFACES (on some models)

Food spills containing acids, such as vinegar and tomato, should be cleaned as soon as the entire appliance is cool. These spills may affect the finish.

- Glass cleaner, mild liquid cleaner or nonabrasive scrubbing pad: Gently clean around the model and serial number plate because scrubbing may remove numbers.
- All-Purpose Appliance Cleaner Part Number 31662 (not included): See "Assistance or Service" section to order.

STAINLESS STEEL (on some models)

Do not use soap-filled scouring pads, abrasive cleaners, Cooktop Polishing Creme, steel-wool pads, gritty washcloths or some paper towels. Damage may occur.

Rub in direction of grain to avoid damaging.

- Stainless Steel Cleaner & Polish Part Number 31464 (not included): See "Assistance or Service" section to order.
- Liquid detergent or all-purpose cleaner: Rinse with clean water and dry with soft, lint-free cloth.
- Vinegar for hard water spots

METALLIC PAINT (on some models)

- Do not use abrasive cleaners, cleaners with bleach, rust removers, ammonia or sodium hydroxide (lye) because paint surface may stain.

CERAMIC GLASS (on some models)

Do not use steel wool, abrasive powder cleansers, chlorine bleach, rust remover or ammonia because damage may occur.

Always wipe with a clean, wet cloth or sponge and dry thoroughly to prevent streaking and staining.

Cooktop Cleaner Part Number 31464 is recommended regularly to help prevent scratches, pitting and abrasions and to condition the cooktop, and can be ordered as an accessory. See "Assistance or Service" section to order.

Cooktop Scraper Part Number 3183488 is also recommended for stubborn soils, and can be ordered as an accessory. See "Assistance or Service" section to order. The Cooktop Scraper uses razor blades. **Store razor blades out of the reach of children.**

Light to moderate soil

- Paper towels or clean damp sponge:
Clean while the cooktop is still warm. You may want to wear oven mitts while cleaning the cooktop.

Sugary spills (jellies, candy, syrup)

- Cooktop Scraper: Clean while the cooktop is still warm. You may want to wear oven mitts while cleaning the cooktop.
- Cooktop Polishing Creme and clean damp paper towel: Clean as soon as cooktop has cooled down. Rub creme into surface with a damp paper towel or soft cloth. Continue rubbing until white film disappears.

Heavy soil, dark streaks, specks and discoloration

- Cooktop Polishing Creme or nonabrasive cleanser: Rub product into soil with a damp paper towel or soft cloth. Continue rubbing until white film disappears.

Burned-on soil

- Cooktop Polishing Creme and Cooktop Scraper: Rub creme into soil with damp paper towel. Hold scraper as flat as possible on surface and scrape. Repeat for stubborn spots. Polish entire cooktop with creme and paper towel.

Metal marks from aluminum and copper

- Cooktop Polishing Creme: Clean as soon as cooktop has cooled down. Rub creme into surface with a damp paper towel or soft cloth. Continue rubbing until white film disappears. The marks will not totally disappear, but after many cleanings they will become less noticeable.

Tiny scratches and abrasions

- Cooktop Polishing Creme: Rub creme into surface with a damp paper towel or soft cloth. Continue rubbing until white film disappears. Scratches and abrasions do not affect cooking performance, and after many cleanings they will become less noticeable.

COOKTOP CONTROLS

Do not use steel wool, abrasive cleansers or oven cleaner.

Do not soak knobs.

When replacing knobs, make sure knobs are in the Off position.

On some models, do not remove seals under knobs.

- Soap and water or dishwasher: Pull knobs straight away from control panel to remove.

CONTROL PANEL

Do not use abrasive cleaners, steel-wool pads, gritty washcloths or some paper towels. Damage may occur.

- Glass cleaner and soft cloth or sponge: Apply glass cleaner to soft cloth or sponge, not directly on panel.
- All-Purpose Appliance Cleaner Part Number 31662 (not included): See "Assistance or Service" section to order.

COIL ELEMENTS (on some models)

Do not clean or immerse in water. Soil will burn off when hot.
For more information, see “Coil Elements and Burner Bowls.”

- Damp cloth: Make sure control knobs are off and elements are cool.

BURNER BOWLS (on some models)

- Solution of ½ cup (125 mL) ammonia to 1 gal. (3.75 L) water:
Soak for 20 minutes, then scrub with stainless steel-wool pad.
- Oven cleaner: Follow product label instructions.
- Mildly abrasive cleanser: Scrub with wet scouring pad.

Porcelain enamel only, not chrome

- Dishwasher
Gas Grate and Drip Pan Cleaner Part Number 31617 (not included):
See “Assistance or Service” section to order.

SURFACE UNDER COOKTOP (on some models)

Do not remove the cooktop to avoid product damage.
For more information, see “Lift-up Cooktop” section.

- Steel-wool pad

OVEN DOOR EXTERIOR

- Glass cleaner and paper towels or nonabrasive plastic scrubbing pad: Apply glass cleaner to soft cloth or sponge, not directly on panel.
- All-Purpose Appliance Cleaner Part Number 31662 (not included):
See “Assistance or Service” section to order.

OVEN CAVITY

Do not use oven cleaners.

Food spills should be cleaned when oven cools. At high temperatures, foods react with porcelain and staining, etching, pitting or faint white spots can result.

- Self-Cleaning cycle: See “Self-Cleaning Cycle” first.

OVEN RACKS AND ROASTING RACKS

- Self-Cleaning cycle: See “Self-Cleaning Cycle” first. Remove racks or they will discolor and become harder to slide. If this happens, a light coating of vegetable oil applied to the rack guides will help them slide.
- Steel-wool pad

BROILER PAN AND GRID (on some models)

Do not clean in the Self-Cleaning cycle.

- Mildly abrasive cleanser:
Scrub with wet scouring pad.
- Solution of ½ cup (125 mL) ammonia to 1 gal. (3.75 L) water:
Soak for 20 minutes, then scrub with scouring or steel-wool pad.
- Oven cleaner: Follow product label instructions.

Porcelain enamel only, not chrome

- Dishwasher

STORAGE DRAWER (on some models)

Make sure drawer is cool and empty before cleaning.

For more information, see “Storage Drawer” section.

- Mild detergent

Drawer Liner (on some models)

Remove all stored items from drawer and lift out drawer liner.

- Clean with mild detergent.
- All-Purpose Appliance Cleaner Part Number 31662 (not included):
See “Assistance or Service” section to order.

WARMING DRAWER and TRAY (on some models)

Make sure drawer is cool and remove tray.

- Mild detergent (for both)
- All-Purpose Appliance Cleaner Part Number 31662 (not included):
See “Assistance or Service” section to order.

Oven Light

(on some models)

The oven light is a standard 40-watt appliance bulb. It will come on when the oven door is open. The oven light will not work during the Self-Cleaning cycle. On some models, when the oven door is closed, press the manual oven light switch on the backguard to turn on and off.

Before replacing, make sure the oven and cooktop are cool and the control knobs are in the off position.

To Replace:

1. Unplug range or disconnect power.
2. Turn the glass bulb cover in the back of the oven counterclockwise to remove.

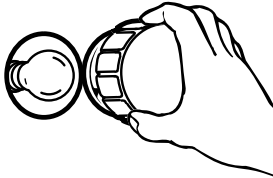

3. Turn bulb counterclockwise to remove from socket.
4. Replace bulb, then bulb cover by turning clockwise.
5. Plug in range or reconnect power.

Oven Door

For normal range use, it is not suggested to remove the oven door. However, if removal is necessary, make sure the oven is off and cool. Then, follow these instructions. The oven door is heavy.

Before Removing:

1. Use a putty knife or screwdriver and insert it at the bottom corner of the door stop clip.

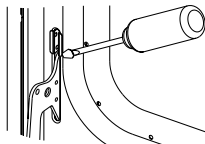

2. Pry door stop clip free and remove from front frame hinge slot. Be certain not to scratch finish.
3. Repeat procedure for other door stop clip.

To Remove:

1. Open the oven door. Insert door removal pins, included with your range, into both hinge hangers. Do not remove the pins while the door is removed from the range.

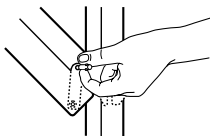

2. Slowly close the door until it rests against the door removal pins.
3. Grasp the door on the sides with your fingers on the front of the door and your thumbs on the inside surface.

4. Pull door straight up, then toward you. Hinge hangers will slide out of front frame hinge slot. Do not remove door removal pins until the door is replaced on the range.

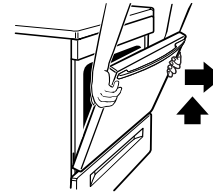

To Replace:

1. Grasp the door on the sides with your fingers on the front of the door and your thumbs on the inside surface.
2. Hold oven door so that the top edge of each hinge hanger is horizontal. Insert hinge hangers into the front frame hinge slots.
3. Tilt top of door toward range. Slide hinge hangers down onto front frame support pins. Make sure the hinge hangers are fully seated and engaged on the support pins.

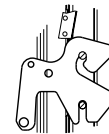

4. Insert the door stop clip with the angular surface at the top of the frame hinge slot, then push in the bottom of the clip until flanges are flush with the front frame.

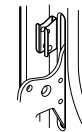

5. Open the door completely and remove the door removal pins. Save door removal pins for future use.
6. Close the door.

Storage Drawer

The storage drawer can be removed. Before removing, make sure drawer is cool and empty.

To Remove:

1. Pull drawer straight out to the first stop.
2. Lift up the back of the drawer and pull out.

To Replace:

1. Fit the ends of the drawer rails into the guides in the cavity.
2. Slide the drawer closed.

TROUBLESHOOTING

Try the solutions suggested here first in order to avoid the cost of an unnecessary service call.

Nothing will operate

- **Is the power supply cord unplugged?**
Plug into a grounded outlet.
 - **Has a household fuse blown, or has a circuit breaker tripped?**
Replace the fuse or reset the circuit breaker. If the problem continues, call an electrician.
-

Cooktop will not operate

- **Is the control knob set correctly?**
Push in knob before turning to a setting.
 - **On ceramic glass models, is the "Control Lock" set?**
See "Control Lock" section.
-

Excessive heat around cookware on cooktop

- **Is the cookware the proper size?**
Use cookware about the same size as the surface cooking area, element or surface burner. Cookware should not extend more than 1" (2.5 cm) outside the cooking area.
-

Hot Surface indicator light stays on

- **Does the Hot Surface indicator light stay on after control knob(s) have been turned off?**
See "Cooktop Controls" section.
-

Cooktop cooking results not what expected

- **Is the proper cookware being used?**
See "Cookware" section.
 - **Is the control knob set to the proper heat level?**
See "Cooktop Controls" section.
 - **Is the appliance level?**
Level the appliance. See the Installation Instructions.
-

Oven will not operate

- **Is the electronic oven control set correctly?**
See "Electronic Oven Control" section.
 - **Has a delay start been set?**
See "Timed Cooking" section.
 - **On some models, is the Control Lock set?**
See "Control Lock" section.
-

Oven temperature too high or too low

- **Does the oven temperature calibration need adjustment?**
See "Oven Temperature Control" section.
 - **On some models, does the cooling fan run during BAKE, BROIL or CLEAN?**
It is normal for the fan to automatically run when the oven is in use. This helps cool the electronic control.
-

Oven indicator lights flash

- **Do the oven indicator lights flash?**
See the "Oven Indicator Lights" section. If the indicator light(s) keeps flashing, call for service. See "Assistance or Service" section.
-

Display shows messages

- **Is the display showing "PF" or a flashing time?**
There has been a power failure. Clear the display. See "Display(s)" section. On some models, reset the clock, if needed. See "Clock" section.
 - **Is the display showing a letter followed by a number?**
Depending on your model, press OFF/CANCEL, OFF or CANCEL/OFF to clear the display. See "Display(s)" section. If it reappears, call for service. See "Assistance or Service" section.
-

Self-Cleaning cycle will not operate

- **Is the oven door open?**
Close the oven door all the way.
 - **Has the function been entered?**
See "Self-Cleaning Cycle" section.
 - **On some models, has a delay start Self-Clean cycle been set?**
See "Self-Cleaning Cycle" section.
 - **Has a delay start been set?**
See "Timed Cooking" section.
-

Oven cooking results not what expected

- **Is the appliance level?**
Level the appliance. See the Installation Instructions.
- **Is the proper temperature set?**
Double-check the recipe in a reliable cookbook.
- **Is the proper oven temperature calibration set?**
See "Oven Temperature Control" section.
- **Was the oven preheated?**
See "Baking and Roasting" section.
- **Is the proper bakeware being used?**
See "Bakeware" section.
- **Are the racks positioned properly?**
See "Positioning Racks and Bakeware" section.
- **Is there proper air circulation around bakeware?**
See "Positioning Racks and Bakeware" section.
- **Is the batter evenly distributed in the pan?**
Check to make sure batter is level in the pan.
- **Is the proper length of time being used?**
Adjust cooking time.
- **Has the oven door been opened while cooking?**
Oven peeking releases oven heat and can result in longer cooking times.
- **Are baked items too brown on the bottom?**
Move rack to higher position in the oven.
- **Are pie crust edges browning early?**
Use aluminum foil to cover the edge of the crust and/or reduce baking temperature.

ASSISTANCE OR SERVICE

Before calling for assistance or service, please check "Troubleshooting." It may save you the cost of a service call. If you still need help, follow the instructions below.

When calling, please know the purchase date and the complete model and serial number of your appliance. This information will help us to better respond to your request.

If you need replacement parts

If you need to order replacement parts, we recommend that you use only FSP® replacement parts. FSP® replacement parts will fit right and work right because they are made with the same precision used to build every new ROPER® appliance.

To locate FSP® replacement parts in your area, call our Customer eXperience Center telephone number or your nearest Whirlpool designated service center.

Call the Customer eXperience Center toll free at:

1-800-44-ROPER (1-800-447-6737).

Our consultants provide assistance with:

- Features and specifications on our full line of appliances.
- Installation information.
- Use and maintenance procedures.
- Accessory and repair parts sales.
- Specialized customer assistance (Spanish speaking, hearing impaired, limited vision, etc.).
- Referrals to local dealers, repair parts distributors, and service companies. Whirlpool designated service technicians are trained to fulfill the product warranty and provide after-warranty service, anywhere in the United States.

To locate the Whirlpool designated service company in your area, you can also look in your telephone directory Yellow Pages.

For further assistance

If you need further assistance, you can write to Whirlpool Corporation with any questions or concerns at:

Roper Brand Home Appliances
Customer eXperience Center
553 Benson Road
Benton Harbor, MI 49022-2692

Please include a daytime phone number in your correspondence.

Accessories U.S.A.

To order accessories, call the Whirlpool Customer eXperience Center toll free at **1-800-442-9991** and follow the menu prompts. Or visit our website at **www.whirlpool.com** and click on "Buy Accessories Online."

Canning Unit Kit

(coil element models)
Order Part Number 242905

Cooktop Cleaner

(ceramic glass models)
Order Part Number 31464

Cooktop Protectant

Order Part Number 31463

Cooktop Care Kit

(includes cleaner, protectant, and applicator pads)
Order Part Number 31605

Cooktop Scraper

(ceramic glass models)
Order Part Number 3183488

Stainless Steel Cleaner & Polish

(stainless steel models)
Order Part Number 31462

All-Purpose Appliance Cleaner

Order Part Number 31662

ROPER® RANGE WARRANTY

ONE-YEAR FULL WARRANTY

For one year from the date of purchase, when this appliance is operated and maintained according to instructions attached to or furnished with the product, Whirlpool Corporation will pay for FSP® replacement parts and repair labor costs to correct defects in materials or workmanship. Service must be provided by a Whirlpool designated service company.

Whirlpool Corporation will not pay for:

1. Service calls to correct the installation of your appliance, to instruct you how to use your appliance, to replace house fuses or correct house wiring or plumbing, or to replace light bulbs.
2. Repairs when your appliance is used in other than normal, single-family household use.
3. Pickup and delivery. Your appliance is designed to be repaired in the home.
4. Damage resulting from accident, alteration, misuse, abuse, fire, flood, improper installation, acts of God or use of products not approved by Whirlpool Corporation.
5. Repairs to parts or systems resulting from unauthorized modifications made to the appliance.
6. Replacement parts or repair labor cost for units operated outside the United States.

WHIRLPOOL CORPORATION SHALL NOT BE LIABLE FOR INCIDENTAL OR CONSEQUENTIAL DAMAGES.

Some states do not allow the exclusion or limitation of incidental or consequential damages, so this exclusion or limitation may not apply to you. This warranty gives you specific legal rights, and you may also have other rights which vary from state to state.

Outside the 50 United States, this warranty does not apply. Contact your authorized Roper dealer to determine if another warranty applies.

If you need service, first see the "Troubleshooting" section of this book. After checking "Troubleshooting," additional help can be found by checking the "Assistance or Service" section or by calling the Customer Interaction Center toll free at **1-800-44-ROPER (1-800-447-6737)** from anywhere in the U.S.A. Outside the U.S., contact your authorized Roper dealer. 12/04

Keep this book and your sales slip together for future reference. You must provide proof of purchase or installation date for in-warranty service.

Write down the following information about your appliance to better help you obtain assistance or service if you ever need it. You will need to know your complete model number and serial number. You can find this information on the model and serial number label/plate, located on your appliance as shown in the "Parts and Features" section.

Dealer name _____
Address _____
Phone number _____
Model number _____
Serial number _____
Purchase date _____

Free Manuals Download Website

<http://myh66.com>

<http://usermanuals.us>

<http://www.somanuals.com>

<http://www.4manuals.cc>

<http://www.manual-lib.com>

<http://www.404manual.com>

<http://www.luxmanual.com>

<http://aubethermostatmanual.com>

Golf course search by state

<http://golfingnear.com>

Email search by domain

<http://emailbydomain.com>

Auto manuals search

<http://auto.somanuals.com>

TV manuals search

<http://tv.somanuals.com>