

Gas Range Use and Care Guide

ROPER™

Home Appliances

SGS395X

Thank you for choosing a Roper appliance.

This Use and Care Guide will help you operate and maintain your new, quality-built Roper range. Keep this Use and Care Guide in a safe place for future reference.

Complete and mail the Product Registration Card.

This card enters your warranty into our warranty system that ensures efficient claim processing, can be used as a proof of purchase for insurance claims and helps Roper to contact you immediately in the unlikely event of a product-safety recall.

You are responsible for

It is your responsibility to be sure that your range:

- Has been properly installed where it is protected from the elements, and on a floor strong enough to support its weight. (See the Installation Instructions.)
- Is not used by anyone unable to operate it properly.
- Is properly maintained.
- Is used only for jobs expected of a home range.
- Is secured by properly installed anti-tip bracket(s), with rear leveling leg(s) positioned under bracket(s).

Contents

	Page
Important Safety Instructions	2
Parts And Features	3
Using Your Range	4
Using the surface burners	4
Setting the electronic clock	4
Using the electronic Minute Timer	4
Using the oven	5
Using the Cook Timer	6
The oven vent	6
The storage drawer	7
Caring For Your Range	8
The control knobs	8
The control panel	8
The surface burner grates and reflector pans	8
The removable cooktop	8
The surface burners	8
Using the Self-Cleaning cycle	9
Cleaning chart	11
The oven light	12
Before You Call For Service	13
Warranty	16
How to get service or assistance	16

TO THE INSTALLER: PLEASE LEAVE THIS INSTRUCTION BOOK WITH THE UNIT.

TO THE CONSUMER: PLEASE READ AND KEEP THIS BOOK FOR FUTURE REFERENCE.

Important Safety Instructions

Gas ranges have been thoroughly tested for safe and efficient operation. However, as with any appliance, there are specific installation and safety precautions which must be followed to ensure safe and satisfactory operation.

WARNING

To reduce the risk of fire, electrical shock, injury to persons, or damage when using the range, follow basic precautions, including the following:

■ FOR YOUR SAFETY ■

DO NOT STORE OR USE GASOLINE OR OTHER FLAMMABLE VAPORS AND LIQUIDS IN THE VICINITY OF THIS OR ANY OTHER APPLIANCE. THE FUMES CAN CREATE A FIRE HAZARD OR EXPLOSION.

■ FOR YOUR SAFETY ■

IF YOU SMELL GAS:

1. OPEN WINDOWS.
2. DON'T TOUCH ELECTRICAL SWITCHES.
3. EXTINGUISH ANY OPEN FLAMES.
4. IMMEDIATELY CALL YOUR GAS SUPPLIER.

IMPROPER INSTALLATION, ADJUSTMENT, ALTERATION, SERVICE OR MAINTENANCE CAN CAUSE INJURY OR PROPERTY DAMAGE. REFER TO THIS MANUAL. FOR ASSISTANCE OR ADDITIONAL INFORMATION CONSULT A QUALIFIED INSTALLER, SERVICE AGENCY, MANUFACTURER (DEALER) OR THE GAS SUPPLIER.

1. Install or locate the range only in accordance with the provided Installation Instructions. It is recommended that the range be installed by a qualified installer. The range must be properly connected to the proper gas supply and checked for leaks. If needed, the range must also be properly connected to electrical supply and grounded.

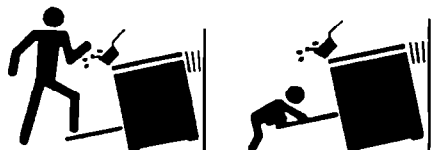

2. To reduce the risk of tipping of the appliance, the appliance must be secured by properly installed anti-tip bracket(s). To check if the bracket(s) is installed properly, remove the storage drawer (see page 7) and verify that the anti-tip bracket(s) is engaged.
3. Gas fuels and combustion can result in potential exposure to chemicals known to cause cancer or reproductive harm. For example, benzene is a chemical which is a part of the gas supplied to the range. It is consumed in the flame during combustion. However, exposure to a small amount of benzene is possible if a gas leak occurs. Formaldehyde, carbon monoxide and soot are by-

products of incomplete combustion. Properly adjusted burners with a bluish rather than a yellow flame will minimize incomplete combustion.

4. DO NOT operate the range if it is not working properly, or if it has been damaged.
5. DO NOT use the range for warming or heating the room. Persons could be burned or injured, or a fire could start.
6. DO NOT attempt to light the oven burner during a power failure. Personal injury could result.
7. Use the range only for its intended use as described in this manual.
8. DO NOT wear loose or hanging garments when using the range. They could ignite if they touch a surface burner and you could be burned.
9. DO NOT touch surface burners, areas near burners or interior surfaces of oven. Areas near surface burners and interior surfaces of an oven become hot enough to cause burns. During use, DO NOT touch, or let clothing or other flammable materials contact surface burners, areas near surface burners or interior surfaces of oven. Other surfaces of the range may become hot enough to cause burns; such as, the oven vent opening, the surface near the vent opening, the cooktop, the oven door and window.

10. Make sure the utensils you use are large enough to contain food and avoid boil-overs and spill-overs. Heavy splattering or spill-overs left on a range can ignite and burn you. Pan size is especially important in deep fat frying.
11. Turn pan handles inward, but not over other surface burners. This will help reduce the chance of burns, igniting of flammable materials, and spills due to bumping of the pan.
12. Use only dry potholders. Moist or damp potholders on surface burners may result in burns from steam. DO NOT let potholder touch surface burners. DO NOT use a towel or bulky cloth for a potholder. They could catch on fire.
13. Check to be sure glass cooking utensils are safe for use on the cooktop. Only certain types of glass, glass-ceramic, ceramic, earthenware or other glazed utensils are suitable for cooktops without breaking due to the sudden change in temperature.
14. DO NOT use decorative covers or trivets over the surface burners.
15. DO NOT heat unopened containers. They could explode. The hot contents could cause burns and container particles could cause injury.

16. **Grease** is flammable and should be handled carefully. Let fat cool before attempting to handle it. **DO NOT allow grease to collect around cooktop or in vents.** Wipe spill-overs immediately.
17. **DO NOT** use water on grease fires. Never pick up a flaming pan. Smother flaming pan on range by covering with a well-fitted lid, cookie sheet or flat tray. Flaming grease outside of pan can be extinguished with baking soda or, if available, a multipurpose dry chemical or foam-type extinguisher.
18. Never leave surface burners unattended at high heat settings. A boil-over could result and cause smoking and greasy spill-overs that may ignite.
19. Make sure surface burners are off when you are finished, and when you are not watching.
20. Use care when opening oven door. Let hot air or steam escape before removing or replacing food.
21. Always position oven rack(s) in desired location while oven is cool.
22. **DO NOT** store flammable materials on or near the range. They could explode or burn.
23. **DO NOT** store things children might want above the range. Children could be burned or injured while climbing on it.
24. **DO NOT** leave children alone or unattended in area where the range is in use. They should never be allowed to sit or stand on any part of the range. They could be burned or injured.
25. **NEVER** use a match or other flame to look for a gas leak. Explosion and injury could result.
26. Know where your main gas shut off valve is located.
27. Keep range vents unobstructed.
28. Clean your range regularly. See care and cleaning instructions in this manual.
29. Be sure all range parts are cool before cleaning.
30. **DO NOT** clean door seal. It is essential for a good seal. Care should be taken not to rub, damage, or move the seal. Clean only parts recommended in this Use and Care Guide.
31. **DO NOT** use oven cleaners. No commercial oven cleaner or oven liner protective coating of any kind should be used in or around any part of the oven.
32. Before self-cleaning the oven, remove broiler pan, broiler grid, oven racks and other utensils. Do not use your oven to clean miscellaneous parts.
33. **DO NOT** repair or replace any part of the range unless specifically recommended in this manual. All other servicing should be referred to a qualified technician.
34. Disconnect the electrical supply before servicing the range.

▪ **SAVE THESE INSTRUCTIONS** ▪

Parts & Features

Model SGS395X

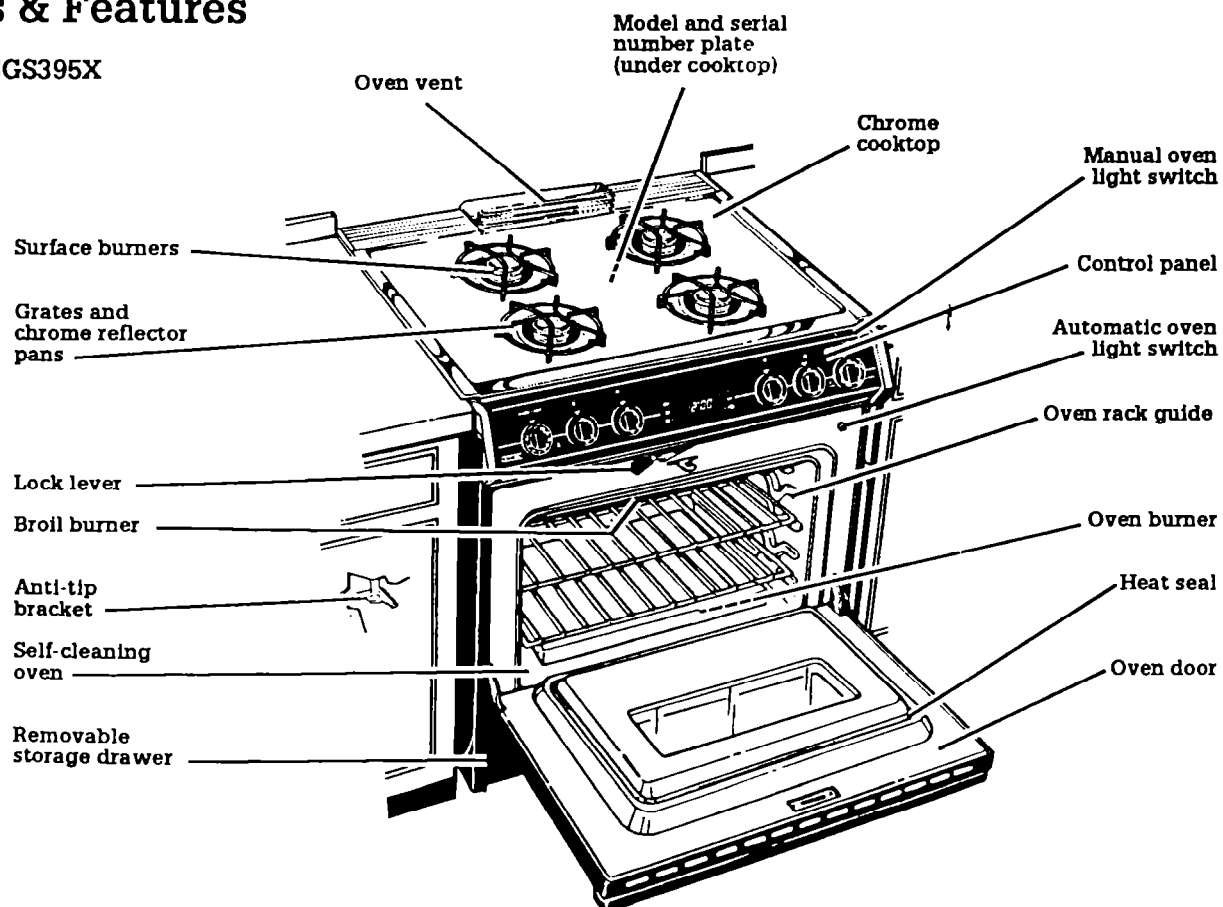

Using Your Range

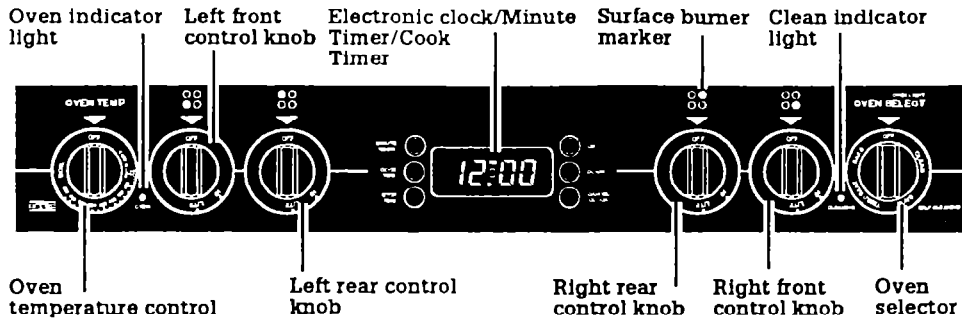

Using the surface burners

Push in and turn

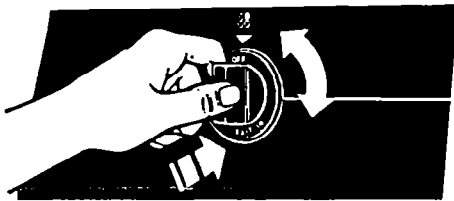

Control knobs must be pushed in, then turned to the LITE position. The clicking sound is the ignition sparking.

To stop the clicking sound after the burner lights, turn the control knob back to a desired setting. The control knob can be set anywhere between HI and OFF.

Surface burner markers

The solid dot in the surface burner marker shows which surface burner is turned on by that knob.

Until you get used to the settings, use the following as a guide. For best results, start cooking at the high settings, then turn the control knob down to continue cooking.

Use LITE to light the burner. After the burner lights, turn control back to a desired setting to stop the clicking of the ignition.

Use a high setting to start food cooking; to bring liquids to a boil.

Use a medium setting to continue cooking or to fry chicken or pancakes; for gravy, puddings and icing; to cook large amounts of vegetables.

Use a low setting to keep food warm until ready to serve.

NOTE: Do not cook with the control in the LITE position.

In case of a prolonged power failure

Surface burners can be manually lighted. Hold a lit match near a burner and slowly turn the control knob on until the burner lights. After the burner lights, turn the control knob to the desired setting.

WARNING

Burn, Fire And Explosion Hazard

- Burner flame should not extend beyond the edge of the cooking utensil. The flame can burn you and cause poor cooking results.
- Be sure all control knobs are turned to OFF when you are not cooking. Someone could be burned or a fire could start if a burner is accidentally left ON.
- If the flame should go out while cooking, or if there is a strong gas odor, turn the burners OFF. Wait five minutes for the gas odor to disappear, before relighting burner. If gas odor is still present, see safety note on page 2. Failure to follow these precautions could result in explosion or fire.
- Do not attempt to light the oven burner during a power failure. Personal injury could result.

Setting the electronic clock

The electronic clock is a digital clock with a Minute Timer and automatic control cooking cycle. Time-of-day, Minute Timer times and cook times are set by pushing command buttons on either side of the display.



1. When the range is connected to power, or a power failure longer than three seconds occurs, "12:00" will flash on the display.
2. Push the Cancel/Clock button.
3. Set the desired time by pushing the Up and Down buttons. The time will increase or decrease on the display, depending upon which button you push. "PM" will appear on the display for a PM time setting.

Setting the electronic Minute Timer

The Minute Timer does not start or stop the oven. It works like a kitchen timer. It can be set in hours and minutes up to 9 hours 59 minutes. When the set time is up, you will hear a 1/2-second on and 1/2-second off tone and the lower dot in the middle of the display will flash. Press the Minute Timer button to cancel the tone and flashing dot.

1. Push the Minute Timer button.
2. Set the desired time by pushing the Up and Down buttons. The time will increase or decrease on the display, depending upon which button you push. The lower dot in the middle of the display will light up, indicating that the Minute Timer is on.
3. The display will show the set time, then return to time-of-day.
4. To see the remaining set time before the set time is up, press the Minute Timer button.

To cancel the Minute Timer:

Push the Minute Timer button, followed by the Up or Down buttons until "0:00" shows on the display.

Using the oven

Baking

1. Position the rack(s) properly before turning on the oven. To change rack position, pull rack out to stop, raise front edge and lift out.

The racks should be placed so the top of the food will be centered in the oven. Always leave at least 1 1/2 to 2 inches (4-5 cm) between the sides of the pan and the oven walls and other pans.

2. Set the Oven Selector to BAKE. The Oven Indicator Light will come on.
3. Set the Oven Temperature Control to the baking temperature you want.

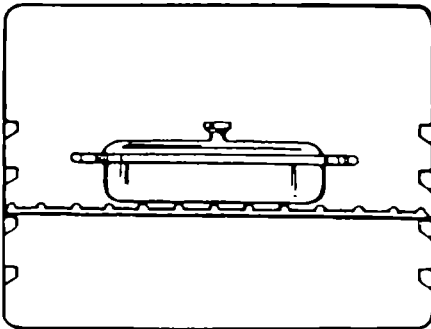

4. Put food in the oven. During baking, the oven burner will turn on and off to keep the temperature at the setting. The Oven Indicator Light will turn on and off with the elements.
5. When baking is done, turn both the Oven Selector and Oven Temperature Control to OFF.

Broiling

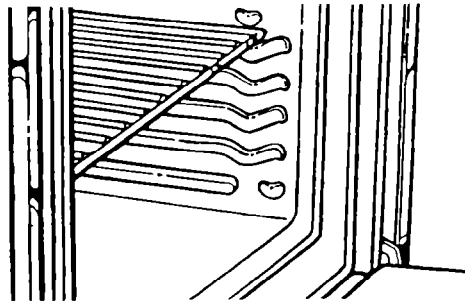

1. Position the rack before turning the oven on. See chart below for recommended rack positions.
2. Preheat in BROIL for 5 minutes with oven door closed. Do not preheat with broiler pan in place.
3. To preheat, set the Oven Selector and Oven Temperature Control to BROIL. The Oven Indicator Light will come on.
4. After preheating, put the broiler pan and food on the rack.
5. Completely close the oven door to assure proper broiling temperatures.
6. When broiling is done, turn both the Oven Selector and Oven Temperature Control to OFF. The Oven Indicator Light will go off.

Broiling tips

- Use the broiler pan and grid for broiling. They are designed to drain excess liquid and fat away from the cooking surface to help prevent spatter, smoke or fire.
- If you broil small quantities, you may want to use a small broiler pan. They are available in the housewares section of many department stores.
- For best broiling results, preheat in BROIL for 5 minutes. Do not preheat with broiler pan in place.
- Rack position determines how infrared rays cook your food. The lower the position, the more broiler grid area covered by the rays. See "Rack position chart" below for more information.
- To sear meat, place broiler pan at one of the higher rack positions so that meat is very near the flame.
- Small steaks, hamburger patties, etc., may be broiled in the higher rack positions.

- To cook large steaks and other thick cuts of meat well done, move them to a lower rack position after searing.
- Refer to a broiling chart in a reliable cookbook for correct broiling times.
- After broiling, remove the broiler pan from the oven when you remove the food. Drippings will bake on the pan if it is left in the heated oven.

⚠ WARNING

Fire Hazard

- Place meat the correct distance from the burner. Meat placed too close to the burner may spatter, smoke, burn or catch fire during broiling.
- To ensure adequate grease drainage, do not use cookie sheets or similar pans for broiling. Also, covering the broiler grid with foil is not recommended. Poor drainage of grease may result in fire. If foil is used, cut slits in foil to correspond with all openings in broiler grid. Grease can then drain away and cool in pan.

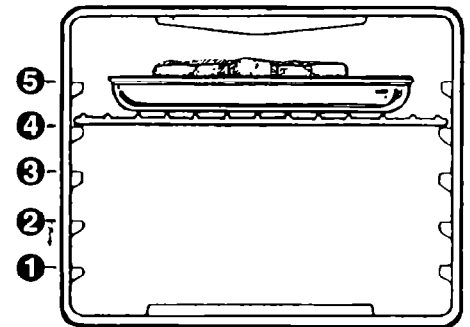

Rack position chart

RACK POSITION FROM BOTTOM	FOOD
5	Rare steaks and hamburgers
4	Medium steaks and fish
3	Well-done foods such as chicken, lobster, ham slices and pork chops

Using the Cook Timer

The automatic Cook Timer is designed to turn the oven on and off at times you set, even when you are not around.

Automatic baking is ideal for foods which do not require a preheated oven such as meats and casseroles. **Do not use the automatic cycle for cakes, cookies, etc...undercooking will result.**

To start baking now and stop automatically:

1. Position rack(s) properly, and place the food in the oven.
2. **Make sure the clock is set to the correct time-of-day.** (See "Setting the electronic clock" on page 4.)
3. Set the Oven Selector to TIMED BAKE.
4. Set the Oven Temperature Control to the baking temperature you want.
5. Push the Stop Time button.
6. Push the Up button to set the desired stop time. AUTO will appear on the display and the Oven Indicator Light will come on to signal the start of the cooking cycle. When the desired stop time is reached the Oven Indicator Light will go off, a 10-second tone will sound and the display will return to the current time-of-day. The AUTO light will flash on and off until the Cancel/Clock button is pushed. The oven will shut off automatically.
7. **After baking is done or to stop the oven before preset time,** push the Cancel/Clock button and turn both the Oven Selector and the Oven Temperature Control to OFF.

To delay start and stop automatically:

1. Position the oven rack(s) properly, and place the food in the oven.
2. **Make sure the clock is set to the correct time-of-day.** (See "Setting the electronic clock" on page 4.)
3. Set the Oven Selector to TIMED BAKE.
4. Set the Oven Temperature Control to the baking temperature you want.
5. Push the Cook Time button. "0:00" will appear on the display.

6. Push the Up button to set the desired length of baking time. For example, to delay time bake for 3 hours press and hold the Up button until "3:00" appears on the display.
7. Push the Stop Time button. The time-of-day plus the set baking time will appear.
8. Push the Up button to set the desired stop time. AUTO will appear on the display and the clock will automatically calculate the start time. When the desired start time is reached, the Oven Indicator Light will come on indicating that the timed bake cycle has begun.
9. When the desired stop time is reached the Oven Indicator Light will go off, a 10-second tone will sound and the display will return to the current time-of-day. The AUTO light will flash on and off until the Cancel/Clock button is pushed. The oven will shut off automatically.
10. **After baking is done or to stop the oven before preset time,** push the Cancel/Clock button and turn both the Oven Selector and the Oven Temperature Control to OFF.

The oven vent

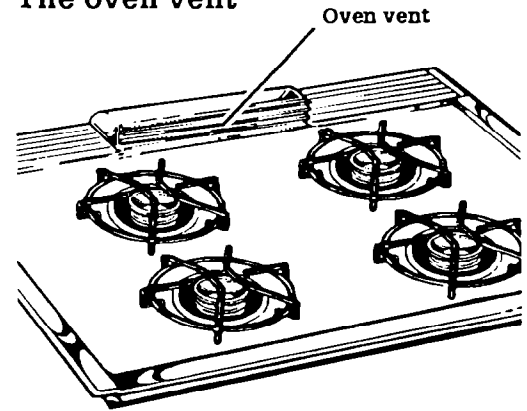

Hot air and moisture escape from the oven through a vent located at the back of the cooktop. **Do not block the vent.** Poor baking can result.

⚠ WARNING

Burn Hazard

When the oven is ON, pans and pan handles left near the oven vent can become hot enough to burn the user and to melt plastics. Use potholders to move pans. Never store plastics, paper or other items that could melt or burn near the oven vent, or any of the surface burners.

⚠ WARNING

To avoid sickness and food waste when using delay start:

- Do not use foods that will spoil while waiting for cooking to start, such as dishes with milk or eggs, cream soups, and cooked meats or fish. Any food that has to wait for cooking to start should be very cold or frozen before it is put in the oven. **MOST UNFROZEN FOODS SHOULD NEVER STAND MORE THAN TWO HOURS BEFORE COOKING STARTS.**
- Do not use foods containing baking powder or yeast when using delay start. They will not rise properly.
- Do not allow food to remain in oven for more than two hours after end of cooking cycle.

The storage drawer

The storage drawer is for storing pots and pans. The drawer can be removed to make it easier to clean under the range, and to check for installation of the anti-tip bracket(s). Use care when handling the drawer.

Removing the storage drawer:

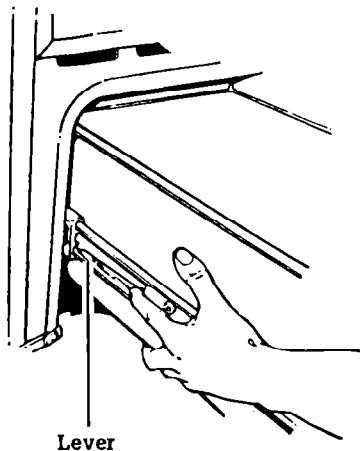

1. Empty drawer of any pots and pans before removing drawer. Pull drawer straight out to the stop.
2. Push up black plastic lever on both sides of drawer.

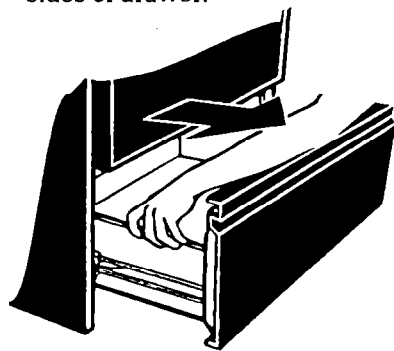

3. Pull drawer out a little farther until levers stay in "up" position. Pull drawer the rest of the way out.

Replacing the storage drawer:

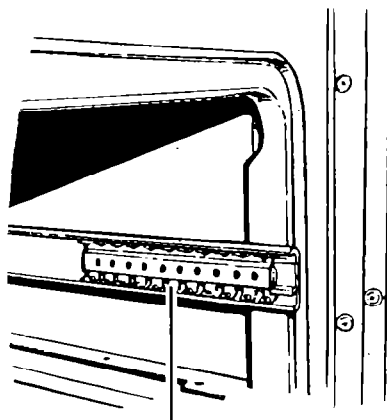

Ball bearings

1. Make sure ball bearings on oven slide rail are positioned toward the front of the opening.
2. Fit ends of drawer slide rails into the oven slide rails on both sides of opening.
3. Slide drawer closed.

To verify that the anti-tip bracket(s) is engaged:

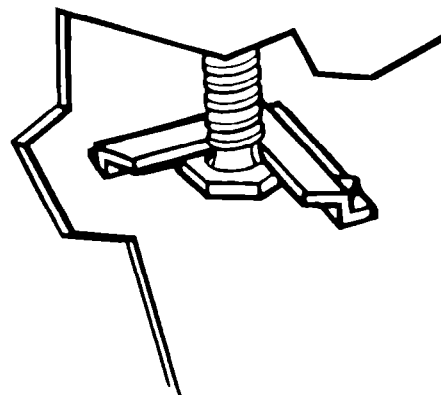

- Remove storage drawer.
- Look to see if the anti-tip bracket(s) is attached to floor with screws.
- Make sure rear leveling leg(s) is positioned under bracket(s).
- See "Important Safety Instructions" on page 2 and Installation Instructions for further details.

NOTE: The range will not tip during normal use. Tipping can occur if excessive force or weight is applied to open door without anti-tip bracket(s) properly secured.

Caring For Your Range

⚠ WARNING

Burn, Electrical Shock, Fire And Explosion Hazard

- Make sure all controls are OFF and the range is cool before cleaning.
- Do not use oven cleaners, bleach or rust removers.
- Do not use gasoline or other flammable liquids or vapors to clean this or any other appliance.
- Keep the appliance area clear and free from combustible materials, gasoline and other flammable vapors and liquids.
- Do not obstruct the flow of combustion and ventilation air. Failure to follow these guidelines could result in burns, electrical shock, fire or explosion.

The control knobs

1. Turn control knobs to the OFF position.
2. Pull control knobs straight off.
3. Wash in warm, soapy water.
4. Rinse well and dry completely. Do not soak.

The control panel

1. Wipe with warm, soapy water or spray glass cleaner, and a soft cloth.
2. Rinse well.
3. Dry with soft cloth.
4. Replace control knobs by pushing them firmly into place.

NOTE: When cleaning, never use steel wool, abrasives, or commercial oven cleaners which may damage the finish. After cleaning, make sure all control knobs point to the OFF position.

The surface burner grates and reflector pans

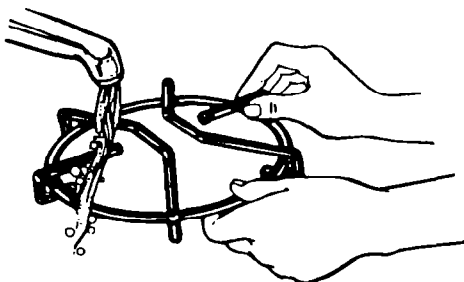

1. Make sure all surface burners are off and the surrounding parts are cool.
2. Lift off the burner grates and remove reflector pans.
3. Wash the grates and reflector pans with warm, soapy water or in a dishwasher. Use a non-abrasive plastic scouring pad for heavily-soiled areas. Rinse and dry well.
4. Replace reflector pans and burner grates.

The removable cooktop

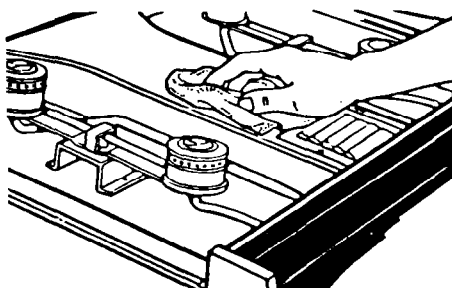

1. Remove surface burner grates and reflector pans.
2. Lift front of cooktop enough to clear front of range. Grasp cool burner openings. Lift and pull forward.
3. Wipe surface under cooktop with warm, soapy water. Use a soap-filled plastic scouring pad on heavily-soiled areas.
4. To replace cooktop, lower front of cooktop while placing into rear support brackets. Avoid hitting the control panel.

The surface burners

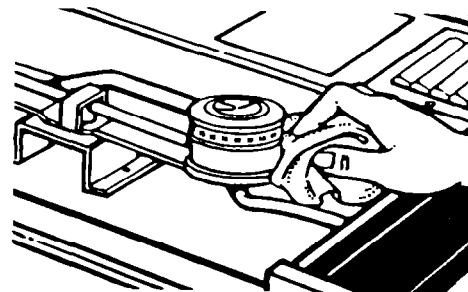

1. Remove the cooktop, following the instructions above.
2. Wipe off surface burners with warm, soapy water and a soft cloth after each use. Use a plastic scouring pad for cooked-on foods.
3. If ports are clogged, clean with a straight pin. DO NOT enlarge or distort the ports. DO NOT use a toothpick to clean the ports.

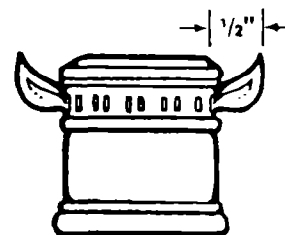

Typical surface burner flame

4. Occasionally check the burner flames for proper size and shape as shown above. If flames lift off ports, are yellow, or are noisy when turned off, you may need to clean the burners (see above), or call a qualified technician for adjustment.
5. Replace cooktop.

⚠ WARNING

Personal Injury And Product Damage Hazard

- Do not try to clean under the cooktop without removing the cooktop first. The cooktop could accidentally fall and injure you.
- Do not drop the cooktop. Damage can result to the porcelain and the cooktop frame.

Using the Self-Cleaning cycle

The Self-Cleaning cycle uses **very high heat** to burn away soil. Before you start, make sure you understand exactly how to use the Self-Cleaning cycle safely.

Before you start

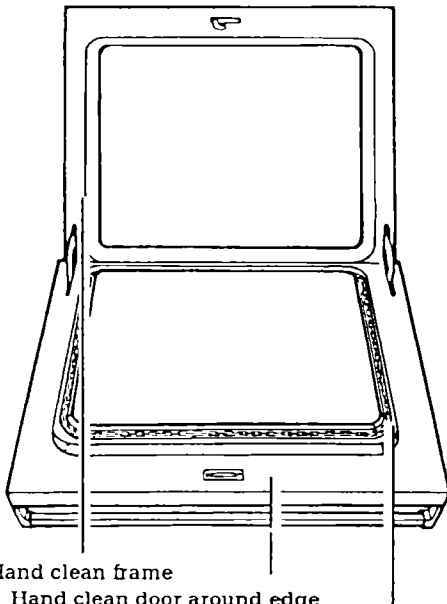

Hand clean frame

Hand clean door around edge

Do not hand clean seal

1. **Clean the areas shown by hand.**
They do not get hot enough during the Self-Cleaning cycle for soil to burn away. Use hot water and detergent or a soapy steel wool pad on...
 - The inside of the door. (The center area of the door does not need to be hand cleaned.)
 - The frame around the oven.**Do not clean, move or bend the fiberglass seal.** Poor cleaning and poor baking will result.
2. **Remove the broiler pan and any pots and pans** you may have stored in the oven.
NOTE: The broiler pan can be cleaned in the oven only if most of the soil has been removed by hand-cleaning or a dishwasher.
3. **Wipe out any loose soil or grease.**
This will help reduce smoke during the Self-Cleaning cycle.

4. **If you want the oven racks to remain shiny, remove from the oven and clean them by hand.** Otherwise, put oven racks on second and fourth guides (guides are counted from bottom to top). After racks are cleaned in the Self-Cleaning cycle, they become harder to slide. See page 11.
Heat and odors are normal during the cycle. If needed, remove them by opening a window or by turning on a vent hood or other kitchen vent during the Self-Cleaning cycle.

⚠ WARNING

Personal Injury And Product Damage Hazard

- **Do not touch the oven during the Self-Cleaning cycle.** It could burn you.
- **Do not use commercial oven cleaners in your oven.** Cleaners may produce hazardous fumes or damage the porcelain finish.
- **Do not force the Lock Lever.** You could bend or break it. The lever is designed to stay locked until the oven is cool enough to safely open. Wait until it moves freely.
- **Do not use foil or other liners in the oven.** During the Self-Cleaning cycle foil can burn or melt and damage the oven surface.
- **Do not block the vent during the Self-Cleaning cycle.** Air must move freely for best cleaning results.
- **Do not leave plastic utensils near the vent.** They may melt.

Setting the controls

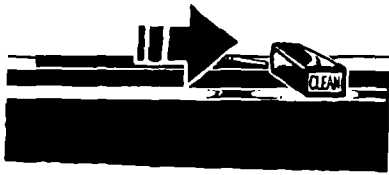

To start the Self-Cleaning cycle immediately:

1. Set the Oven Selector to CLEAN.
2. **Make sure the clock has the correct time-of-day.** (See "Setting the electronic clock" on page 4.)
3. Move the Lock Lever **all the way to the right** - the Clean position.
4. Push the Stop Time button.
5. Push the Up button to set the desired stop time. AUTO will appear on the display. The Oven Indicator Light will come on immediately. The Clean Indicator Light will come on when the oven temperature exceeds normal baking temperatures. The door cannot be opened when the Clean Indicator Light is on.

To start the Self-Cleaning cycle later:

1. Set the Oven Selector to CLEAN.
2. **Make sure the clock has the correct time-of-day.** (See "Setting the electronic clock" on page 4.)
3. Move the Lock Lever **all the way to the right** - the Clean position.
4. Push the Cook Time button. "0:00" will appear on the display.
5. Push the Up button to set the length of time you want the oven to self-clean.
 - Use 2 hours for light soil.
 - Use 3 hours for moderate soil.
 - Use 3-4 hours for heavy soil.
6. Push the Stop Time button. The time-of-day will appear.
7. Push the Up button to set the desired stop time. AUTO will appear on the display. The clock will automatically calculate the start time of the Self-Cleaning cycle. When the desired start time of the Self-Cleaning cycle is reached the Oven Indicator Light will come on. The Clean Indicator Light will come on when the oven temperature exceeds normal baking temperatures. The door cannot be opened when the Clean Indicator Light is on.

At the end of the Self-Cleaning cycle:

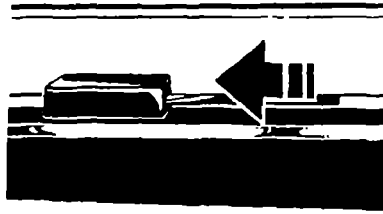

1. **After the Self-Cleaning cycle is completed**, both indicator lights will go off, a 10-second tone will sound and the display will return to the current time-of-day. The AUTO light will flash on and off until the Cancel/Clock button is pushed. Wait until the oven reaches normal baking temperatures (about 30 minutes) before attempting to move the Lock Lever back to the left. **Do not force it.** Wait until it moves easily.
2. Turn the Oven Selector to OFF.
3. **After the oven is cool**, wipe off any residue or ash with a damp cloth. If needed, touch up spots with a soapy steel wool pad.

How it works

During the Self-Cleaning cycle, the oven gets much hotter than it does for baking or broiling...approximately 875°F (468°C). This heat breaks up grease and soil and burns it off.

This graph shows approximate temperatures and times during a Self-Cleaning cycle for 3 hours.

Self-Cleaning cycle 3-hour setting

(Approximate temperatures and times)

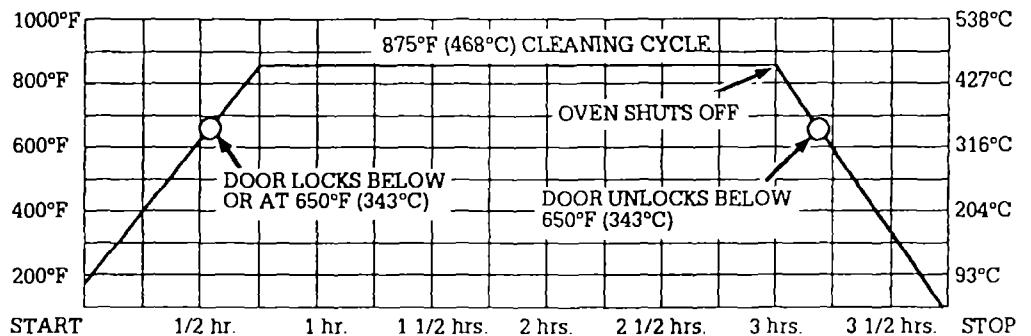

Notice that the heating stops when the 3-hour setting is up, but that it takes longer for the oven to cool down enough to unlock.

Special tips

- Keep the kitchen well-ventilated during the Self-Cleaning cycle to help get rid of heat, odors and smoke.
- Clean the oven before it gets heavily soiled. Cleaning a very soiled oven takes longer and results in more smoke than usual.
- If the Self-Cleaning cycle doesn't get the oven as clean as you expected, the cycle may not have been set long enough or you may not have prepared the oven properly. Set the Self-Cleaning cycle longer the next time and hand clean areas noted on page 9.

To stop the Self-Cleaning cycle at any time:

Push the Cancel/Clock button.

Cleaning chart

⚠ WARNING

Burn And Electrical Shock Hazard

Make sure all controls are OFF and the range is cool before cleaning. Failure to do so can result in burns or electrical shock.

PART	WHAT TO USE	HOW TO CLEAN
Exterior surfaces	Warm, soapy water and a soft cloth. Non-abrasive plastic scouring pad for heavily-soiled areas.	<ul style="list-style-type: none"> Wipe off regularly when range is cool. Do not allow food containing acids (such as vinegar, tomato or lemon juice) to remain on surface. Acids may remove the glossy finish. Also, wipe up milk or egg spills when cooktop is cool. Do not use abrasive or harsh cleansers.
Surface burner grates and chrome reflector pans	Warm, soapy water and a non-abrasive plastic scouring pad.	<ul style="list-style-type: none"> Wash with other cooking utensils. Dry completely. Do not place in Self-Cleaning Oven.
Surface burners	Warm, soapy water and a soft cloth. Warm, soapy water and a non-abrasive plastic scouring pad.	<ul style="list-style-type: none"> Remove the cooktop (see page 8). Wipe off spills immediately after burner has cooled. <p>For cooked-on food:</p> <ul style="list-style-type: none"> Remove burner from manifold with phillips screw-driver. Wash with warm, soapy water and a plastic scouring pad. Rinse and dry well. If ports are clogged, clean with a straight pin. Do not enlarge or distort ports. Do not use a wooden toothpick. Do not clean surface burner in dishwasher.
Control knobs	Warm, soapy water and soft cloth.	<ul style="list-style-type: none"> Wash, rinse and dry well. Do not soak.
Control panel and trim	Warm, soapy water or spray glass cleaner, and a soft cloth.	<ul style="list-style-type: none"> Wash, rinse and dry well. Follow directions provided with cleaner.
Broiler pan and grid	Warm, soapy water or a soapy steel wool pad.	<ul style="list-style-type: none"> Clean after each use. Wash, rinse and dry well. Do not clean in the Self-Cleaning Oven. (See note on page 9.)
Oven racks	Use Self-Cleaning cycle. Warm, soapy water or soapy steel wool pads.	<ul style="list-style-type: none"> Leave in oven during Self-Cleaning cycle. Wash, rinse and dry well. Use soapy steel wool pads for heavily-soiled areas. <p>NOTE: The oven racks will discolor and be harder to slide when left in the oven during the Self-Cleaning cycle. If you want them to stay shiny, remove from the oven and clean by hand. If racks are left in the oven during the Self-Cleaning cycle, apply a small amount of vegetable oil to the sides of the racks to make them easier to slide.</p>
Oven door glass	Spray glass cleaner or warm, soapy water and a non-abrasive plastic scouring pad.	<ul style="list-style-type: none"> Make sure oven is cool. Follow directions provided with the cleaner. Wash, rinse and dry well.
Self-Cleaning oven	For areas outside the Self-Cleaning area use warm soapy water or soapy steel wool pads.	<ul style="list-style-type: none"> Follow directions starting on page 9, "Using the Self-Cleaning cycle." Do not use commercial oven cleaners. Do not use foil to line the bottom of your Self-Cleaning Oven.

The oven light

The oven light will come on when you open the oven door. To turn the light on when the oven door is closed, push the Oven Light Switch on the control panel. Push the switch again to turn off the light.

⚠ WARNING

Electrical Shock And Personal Injury Hazard

- Make sure oven and light bulb are cool and power to the oven has been turned off before replacing the light bulb. Failure to do so could result in electrical shock or burns.
- The bulb cover must be in place when using the oven. The cover protects the bulb from breaking, and from high oven temperatures. Since bulb cover is made of glass, be careful not to drop it. Broken glass could cause injury.

To replace the oven light:

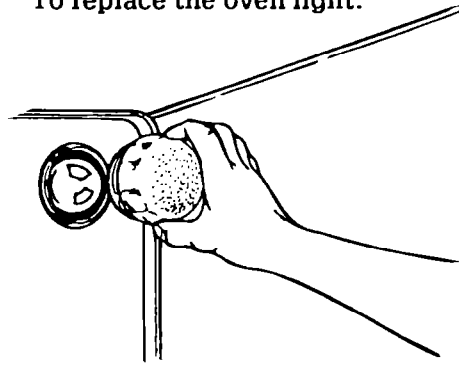

1. Turn off power at the main power supply.
2. Remove the glass bulb cover in the back of the oven by screwing it out counterclockwise.
3. Remove the light bulb from its socket. Replace with a 40-watt appliance bulb.

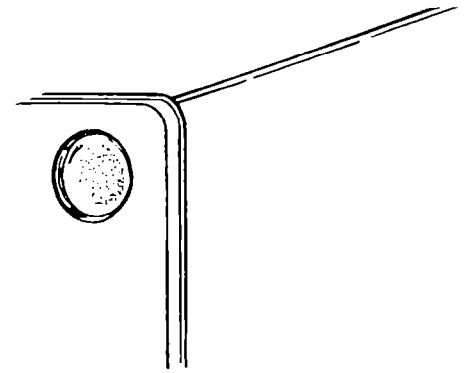

4. Replace the bulb cover by screwing it in clockwise. Turn on power at the main power supply.

NOTE: Make sure oven light is off during the Self-Cleaning cycle. Keeping oven light on will shorten bulb life.

Before You Call For Service

If you are having an operating problem, check the chart to see what the cause might be before you call for assistance.

OPERATING PROBLEM	CHECK IF	WHAT TO DO
Nothing operates.	<ul style="list-style-type: none"> ▪ Range is properly connected to gas and electrical supplies. ▪ Fuse has blown or circuit breaker has tripped. ▪ Control knob is set in the correct position. ▪ The flow of combustion and/or ventilation air to the range is blocked. 	<ul style="list-style-type: none"> ▪ Contact an authorized RoperSM service technician to reconnect range to gas and/or electrical supply. (See Installation Instructions.) ▪ Replace fuse or reset circuit breaker. In case of prolonged power failure, manually light burners (see page 4). ▪ Set control knob correctly, if needed. ▪ Remove blockage to air flow to and around range.
Oven will not operate.	<ul style="list-style-type: none"> ▪ The Oven Selector is turned to BAKE or BROIL. ▪ The Oven Temperature Control is turned to a temperature setting. ▪ The Cook Timer is set correctly. 	<ul style="list-style-type: none"> ▪ If needed, set Oven Selector to BAKE or BROIL. If Oven Selector is turned to TIMED BAKE, wait until the start time is reached. ▪ If needed, turn the Oven Temperature Control to a temperature setting. ▪ See page 6 for instructions on how to set the Cook Timer.
Burner fails to light.	<ul style="list-style-type: none"> ▪ Range is connected to electrical power. ▪ Fuse has blown or circuit breaker has tripped. ▪ Burner ports are clogged. 	<ul style="list-style-type: none"> ▪ Contact an authorized RoperSM service technician to reconnect range to electrical supply. (See Installation Instructions.) ▪ Replace fuse or reset circuit breaker. In case of prolonged power failure, manually light burners (see page 4). ▪ Clean with a straight pin (see pages 8 and 11).
Burner flames are uneven.	<ul style="list-style-type: none"> ▪ Burner ports are clogged. 	<ul style="list-style-type: none"> ▪ Clean with a straight pin (see pages 8 and 11). If this fails, call an authorized RoperSM service technician for service.
Burner flames lift off ports, are yellow, or are noisy when turned off.		<ul style="list-style-type: none"> ▪ Contact an authorized RoperSM service technician to check air/gas mixture.
Burner makes popping noise when on.	<ul style="list-style-type: none"> ▪ Burner is wet from washing. 	<ul style="list-style-type: none"> ▪ Let dry.

Continued on next page

OPERATING PROBLEM	CHECK IF	WHAT TO DO
Control knob(s) will not turn.	<ul style="list-style-type: none"> ▪ You pushed in knob(s) before trying to turn. 	<ul style="list-style-type: none"> ▪ Push in knob(s) before turning.
If the Self-Cleaning cycle will not operate.	<ul style="list-style-type: none"> ▪ The Oven Selector is set to CLEAN. ▪ A delay start time is set. ▪ A stop time is set. 	<ul style="list-style-type: none"> ▪ If needed, set the Oven Selector to CLEAN. ▪ Wait until the delay start time has been reached. ▪ See page 10 for instructions on how to set the Self-Cleaning cycle.
Cooking results are not what you expected.	<ul style="list-style-type: none"> ▪ The range is level. ▪ Flame size fits the cooking utensil being used. ▪ Pans are the size called for in the recipe. ▪ You are following a tested recipe from a reliable source. ▪ The cooking utensils have smooth, flat bottoms and fit the surface burners. ▪ When baking, you have preheated the oven as the recipe calls for. ▪ When baking, you have allowed 1 1/2 to 2 inches (4-5 cm) on all sides of the pans for air circulation. ▪ When broiling, you have completely closed the oven door. The broiler provides best cooking results with the oven door closed. 	<ul style="list-style-type: none"> ▪ Adjust leveling legs. ▪ Adjust flame size to fit cooking utensil. ▪ Use correct-size pans. ▪ Modify recipe or find a new recipe. ▪ Use cooking utensils with smooth, flat bottoms. ▪ Preheat the oven according to recipe's specifications. ▪ Reposition pans for best air circulation. ▪ Completely close oven door.
The oven temperature seems too low or too high.	<ul style="list-style-type: none"> ▪ Your old oven was accurate. Your old oven may have shifted gradually while your new oven may be more exact. 	<ul style="list-style-type: none"> ▪ If, after using the oven, you are not satisfied with the temperature settings, they can be adjusted by an authorized RoperSM service technician. (See "How to get service or assistance" on page 16.)
If there has been a power interruption, the display will flash "12:00".		<ul style="list-style-type: none"> ▪ Reset the clock, (page 4).

**THIS PAGE
INTENTIONALLY LEFT BLANK**

LIMITED WARRANTY



Home Appliances

LENGTH OF WARRANTY (From date of purchase)	PRODUCTS COVERED	WHAT WE WILL PAY FOR
FULL ONE YEAR WARRANTY	All Roper Appliances	Replacement parts and repair labor to correct defects in materials or workmanship.
FULL FIVE YEAR WARRANTY	Refrigerators Freezers Air Conditioners Dehumidifiers	Replacement parts and repair labor for the sealed refrigeration system (compressor, evaporator, condenser, drier or connecting tubing) which we find to be defective in materials or workmanship.
LIMITED 2ND-5TH YEAR WARRANTY	Microwave Ovens	Repair or replacement of magnetron tube which we find to be defective in materials or workmanship.
LIMITED 2ND-5TH YEAR WARRANTY	Automatic Washers	Repair or replacement of any part of the gear case assembly which we find to be defective in materials or workmanship.

WHAT WE WILL NOT PAY FOR

A. SERVICE CALLS TO:

1. Correct the installation of your appliance.
2. Instruct you how to use your appliance.
3. Replace house fuses or correct house wiring or plumbing.
4. Replace owner accessible light bulbs.

B. Repairs when appliance is used in other than normal, single-family household use.

C. Pick up and delivery. Your appliance is designed to be repaired in the home.

D. Damage to appliance caused by accident, misuse, fire, flood, acts of God, or use of product not approved by us.

E. Any labor costs during the limited warranties.

This Roper appliance is warranted by Whirlpool Corporation. Under no circumstances shall it be liable under this warranty for incidental or consequential damages and all implied warranties are limited to the same time periods stated in the express warranties for Roper Brand Appliances. Some states do not allow the exclusion or limitation of incidental or consequential damages or limitations of how long an implied warranty may last, so the above limitations or exclusions may not apply to you.

This warranty gives you specific legal rights, and you may also have other rights which vary from state to state.

Outside the United States, a different warranty may apply. For details, please contact your franchised Roper distributor or military exchange.

HOW TO GET SERVICE OR ASSISTANCE

If you need service, first see the "Before You Call For Service" section of this book. If you still need service after checking this section, additional help can be found if you:

- Contact your selling dealer for the authorized servicer in your area*
OR
 - Phone 1-800-44-ROPER (1-800-447-6737) between 8:00 a.m. and 4:30 p.m. Eastern Time, Monday through Friday*
OR
 - For further information, write to: Consumer Relations Dept., Roper Brand Appliances, 2000 M-63 North, Benton Harbor, MI 49022*
- *When requesting assistance, please provide the model and serial numbers, date of purchase, and a complete description of the problem. The model and serial numbers are located beneath the removable cooktop (see illustration on page 3).

If you are not satisfied with the service received, contact the Major Appliance Consumer Action Panel (MACAP). MACAP is a group of independent consumer experts that voices consumer views at the highest levels of the major appliance industry.

Contact MACAP only when the dealer, authorized servicer or Roper Brand Appliance warrantor have failed to resolve your problem:

Major Appliance Consumer Action Panel
20 North Wacker Drive
Chicago, IL 60606

MACAP will in turn inform us of your action.

Part No. 36-303799-03-0/4320750

©1991 Whirlpool Corporation

TM Trademark/SM Service Mark of Whirlpool Corporation

Printed in U.S.A.

Free Manuals Download Website

<http://myh66.com>

<http://usermanuals.us>

<http://www.somanuals.com>

<http://www.4manuals.cc>

<http://www.manual-lib.com>

<http://www.404manual.com>

<http://www.luxmanual.com>

<http://aubethermostatmanual.com>

Golf course search by state

<http://golfingnear.com>

Email search by domain

<http://emailbydomain.com>

Auto manuals search

<http://auto.somanuals.com>

TV manuals search

<http://tv.somanuals.com>