

VISTA MINI

DESKTOP KVM SWITCH WITH AUDIO

Installation and Operation Manual



10707 Stancliff Road ■ Houston, Texas 77099
Phone: (281) 933-7673 ■ Internet: www.rosel.com

LIMITED WARRANTY

Rose Electronics warrants the Vista Mini™ to be in good working order for one year from the date of purchase from Rose Electronics or an authorized dealer. Should this product fail to be in good working order at any time during this one year warranty period, Rose Electronics will, at its option, repair or replace the Unit as set forth below. Repair parts and replacement units will be either reconditioned or new. All replaced parts become the property of Rose Electronics. This limited warranty does not include service to repair damage to the Unit resulting from accident, disaster, abuse, or unauthorized modification of the Unit, including static discharge and power surges.

Limited Warranty service may be obtained by delivering this unit during the one year warranty period to Rose Electronics or an authorized repair center providing a proof of purchase date. If this Unit is delivered by mail, you agree to insure the Unit or assume the risk of loss or damage in transit, to prepay shipping charges to the warranty service location, and to use the original shipping container or its equivalent. You must call for a return authorization number first. Under no circumstances will a unit be accepted without a return authorization number. Contact an authorized repair center or Rose Electronics for further information.

ALL EXPRESS AND IMPLIED WARRANTIES FOR THIS PRODUCT INCLUDING THE WARRANTIES OF MERCHANTABILITY AND FITNESS FOR A PARTICULAR PURPOSE, ARE LIMITED IN DURATION TO A PERIOD OF ONE YEAR FROM THE DATE OF PURCHASE, AND NO WARRANTIES, WHETHER EXPRESS OR IMPLIED, WILL APPLY AFTER THIS PERIOD. SOME STATES DO NOT ALLOW LIMITATIONS ON HOW LONG AN IMPLIED WARRANTY LASTS, SO THE ABOVE LIMITATION MAY NOT APPLY TO YOU.

IF THIS PRODUCT IS NOT IN GOOD WORKING ORDER AS WARRANTED ABOVE, YOUR SOLE REMEDY SHALL BE REPLACEMENT OR REPAIR AS PROVIDED ABOVE. IN NO EVENT WILL ROSE ELECTRONICS BE LIABLE TO YOU FOR ANY DAMAGES INCLUDING ANY LOST PROFITS, LOST SAVINGS OR OTHER INCIDENTAL OR CONSEQUENTIAL DAMAGES ARISING OUT OF THE USE OF OR THE INABILITY TO USE SUCH PRODUCT, EVEN IF ROSE ELECTRONICS OR AN AUTHORIZED DEALER HAS BEEN ADVISED OF THE POSSIBILITY OF SUCH DAMAGES, OR FOR ANY CLAIM BY ANY OTHER PARTY.

SOME STATES DO NOT ALLOW THE EXCLUSION OR LIMITATION OF INCIDENTAL OR CONSEQUENTIAL DAMAGES FOR CONSUMER PRODUCTS, SO THE ABOVE MAY NOT APPLY TO YOU. THIS WARRANTY GIVES YOU SPECIFIC LEGAL RIGHTS AND YOU MAY ALSO HAVE OTHER RIGHTS WHICH MAY VARY FROM STATE TO STATE.

NOTE: This equipment has been tested and found to comply with the limits for a Class A digital device, pursuant to Part 15 of the FCC Rules. These limits are designed to provide reasonable protection against harmful interference when the equipment is operated in a commercial environment. This equipment generates, uses, and can radiate radio frequency energy and, if not installed and used in accordance with the instruction manual, may cause harmful interference to radio communications. Operation of this equipment in a residential area is likely to cause harmful interference in which case the user will be required to correct the interference at his own expense.

© Copyright Rose Electronics 1991-2000. All rights reserved.

No part of this manual may be reproduced, stored in a retrieval system, or transcribed in any form or any means, electronic or mechanical, including photocopying and recording, without the prior written permission of Rose Electronics.

IBM ®, AT, and PS/2 are trademarks of International Business Machines Corp.

Microsoft ® and Microsoft Windows™ are registered trademarks of Microsoft Corp.

Rose Electronics Part # MAN-KVT1.1

Printed in the United States of America ■ Revision 1

TABLE OF CONTENTS

INTRODUCTION	1
FEATURES	1
GETTING STARTED	2
Package contents	2
Vista Mini models	2
Locating the unit	2
Cable requirements	2
VISTa MINI HARDWARE	4
The front panel	4
The connectors	5
INSTALLATION	6
Step 1. Connecting monitor, keyboard, mouse, and speakers	6
Step 2. Connecting the computers	6
Step 3. Powering up the system	7
Step 4. Switching from the keyboard	7
OPERATION	8
Keyboard computer selection	8
Going to the next or previous computer	8
Scan mode commands	8
Scan time interval command	9
Mode command	9
Typematic value command	10
PS/2 to serial mouse translation, wheel mouse	11
Keep command	11
Null command	11
ROM Identification command	12
Reset command	12
Reset computer mouse command	12
Reset to factory default	13
KEYBOARD COMMAND SUMMARY	14
TROUBLESHOOTING	16
SERVICE INFORMATION	16

Appendix A.	Factory default settings	18
Appendix B.	General specifications	18
Appendix C.	Cables and accessories	19

INTRODUCTION

Thank you for choosing Vista Mini™. Designed for *plug-and-play* operation, your new Vista Mini switch simplifies your job by helping you organize your multiple computer applications. Because Vista Mini lets you use a single keyboard, monitor, mouse, and speakers to access two computers, you can significantly reduce your equipment overhead and end keyboard and monitor clutter.

FEATURES

- Access 2 computers with one keyboard, monitor, mouse, and speakers
- Low cost and easy to use
- Small size (.8" high by 3.2" wide by 4.2" deep)
- Saves physical space, equipment and power costs, reduces clutter
- Select computer from keyboard command or front panel
- Simple to use keystrokes switch computers for fast and easy control
- Front panel has reset switch, status and power LEDs, select LEDs and select switch
- Uses computer's power — no external power required
- Monitor, keyboard, and mouse plug directly into unit
- Supports all brands of wheel mice
- Available in two models - computers use DB25 connectors or PC connectors
- Scan mode automatically sequences through CPUs at adjustable rate
- Non-volatile memory stores configuration settings
- Heavy-duty steel, fully shielded chassis
- Comes with a one-year warranty and unlimited technical support
- Made in USA

KEYBOARD AND MOUSE

- Full emulation of keyboard and mouse, computers can be booted at any time
- Computers can be PS/2 mouse or serial mouse
- Keyboard Num Lock, Caps Lock, and Scroll Lock states automatically saved and restored when switching among CPUs
- Keyboard mode automatically detected

FRONT PANEL

- Switch to any computer from front panel with select switch
- Select LEDs show which computer is selected
- Power LEDs show which computers are powered on
- Status LED flashes to show keyboard and mouse activity
- Reset switch reinitializes all devices

VIDEO

- Video resolution supports up to 1600 x 1280 non-interlaced video
- Uses amplifiers for crystal clear video and increased distance

GETTING STARTED

To acquaint you with your Vista Mini unit, this manual first describes Vista Mini's front and rear panels. Then follow the installation on page 6, which is simply a description of how to plug in the connectors.

Package contents

Your Vista Mini package includes the Vista Mini unit, your warranty registration card, and this manual.

Vista Mini models

This manual describes two different models of Vista Mini, see Table 1 below. The features and commands are the same, the only difference is the connector type for the computers. Please disregard the diagrams and text that do not apply to your model. The models available are:

<i>Table 1. Vista Mini models</i>		
Model	Computers	Computer connector
KVT-2U	2 PCs	DB25 female
KVT-2PC	2 PCs	PC (HD15F, MD6F, MD6F, 3.5mm)

Locating the unit

The Vista Mini unit is best located as close to the CPUs as possible. This will reduce the length of the CPU cables and provide a more cost-effective and neater installation. While usage of the Vista Mini is trouble-free and transparent and need not be in an accessible location, you may wish to access the front panel to observe the LEDs, switch to a computer, or reset the unit.

Cable requirements

Vista Mini connects to each computer with various cables, depending on which model and computer type, see the next page for the different cable types. You plug the keyboard, monitor, mouse, and speakers directly into Vista Mini. The cables are most commonly purchased with Vista Mini and will provide quick and trouble-free operation.

Most installations use cable no longer than 20 feet in length. Cable length will affect the quality of the video, depending upon which resolution you will be using. You can improve the video resolution and distance by ordering coax cables, see *Appendix C* for the part number of the cable.

Cables for use with models that have DB25 connectors

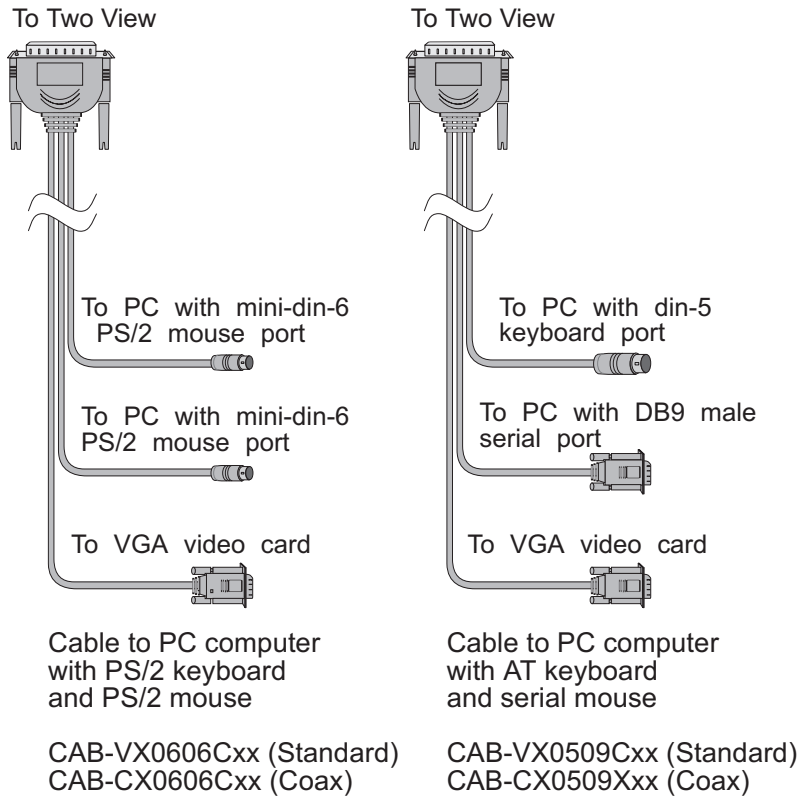

Cables for use with models that have PC connectors

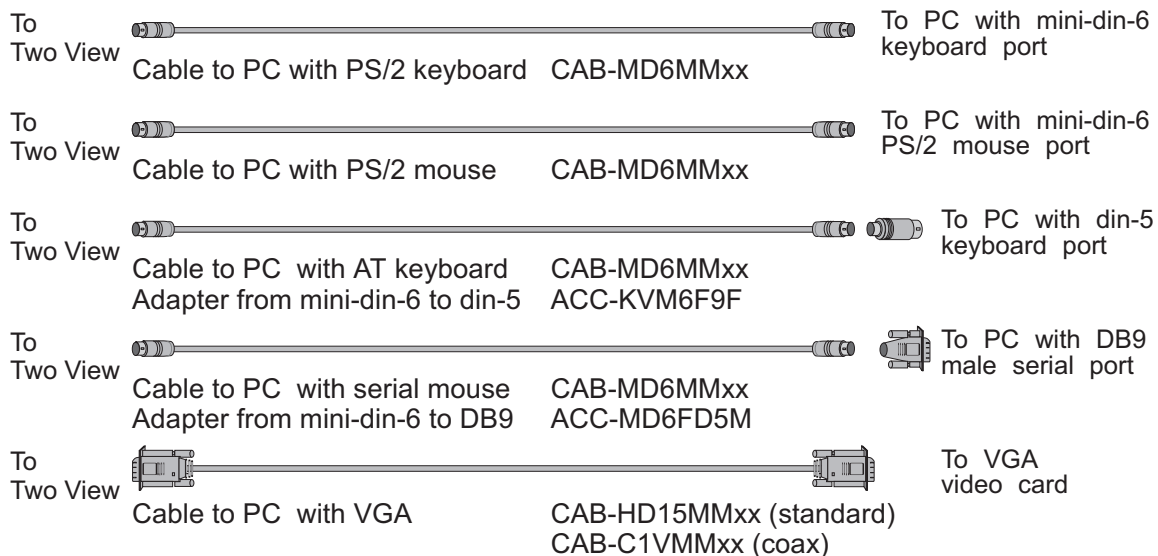

VISTA MINI HARDWARE

The front panel

The Vista Mini front panel features five LEDs and two switches. To familiarize yourself with Vista Mini's controls and indicators, review the illustration and descriptions given below.

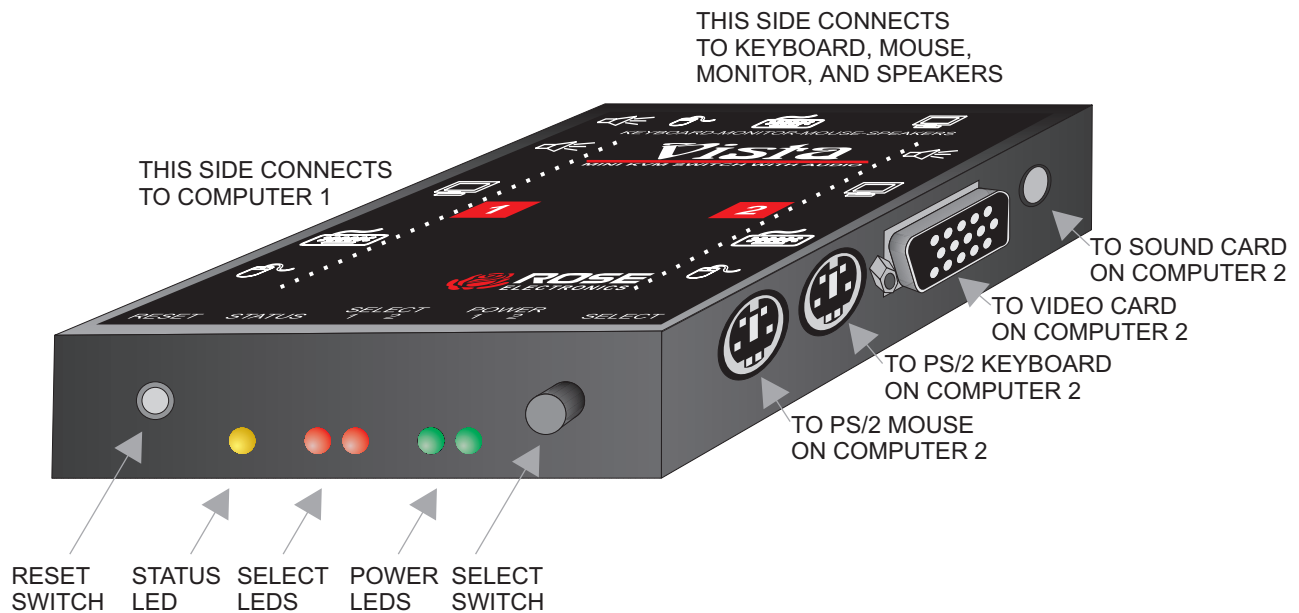





Table 2. The front panel

RESET SWITCH	Resets the unit and initializes the keyboard and mouse, also used to reset the unit to factory default settings
STATUS LED	The yellow status LED lights as data is received from the keyboard and mouse. It is off when the keyboard and mouse are idle.
SELECT LEDS 1-2	The red LEDs indicate which computer is currently selected and connected to the keyboard, monitor, mouse, and speakers.
POWER LEDS 1-2	The green LEDs show if the computers are powered on.
SELECT SWITCH	Selects the computer to connect to the keyboard, mouse, and monitor.

The connectors

All cables are connected at the Vista Mini's side and rear panels. The side panels are used to connect to the computers. The rear panel is to connect the keyboard, monitor, mouse, and speakers. For these you do not need an adapter cable, since these should plug in directly.

Panel Label	Connector	Description
1,2	DB25 female or HD15 / mini-din6 /mini-din 6 / 3.5 mm stereo jack	Computers are connected at these ports using CPU adapter cables. You must have an adapter cable for each CPU you plan to connect.
 VGA MONITOR	HD15 female	Connect the VGA monitor directly to this connector.
 PS/2 MOUSE	Mini-din 6 female	Connect the PS/2 mouse directly to this connector.
 PS/2 KEYBOARD	Mini-din 6 female	Connect the keyboard directly to this connector.
 SPEAKERS	3.5mm stereo jack	Connect the speakers, either powered or unpowered to this jack.

INSTALLATION

Step 1. Connecting monitor, keyboard, and mouse

- 1.1 Plug the monitor, keyboard, mouse, and speaker cables directly into the rear panel of the unit.

Step 2. Connecting the computers

CPU cables connect your computers to Vista Mini. Each computer requires its own cables, with appropriate connectors for your particular CPU. CPU cables are available from Rose Electronics. Refer to page 3 for using the proper cable.

For Vista Mini models with DB 25 connectors:

- 2.1 Plug the DB25 male connector of the CPU adapter cable into one of the numbered CPU ports on the Vista Mini side panel.
- 2.2 Plug the CPU adapter cable's monitor, keyboard, and mouse connectors into the CPU's corresponding ports.

For Vista Mini models with PC connectors:

- 2.1 Plug the HD15 male-male cable from the video card into one of the numbered HD15 female connectors on the Vista Mini rear panel.
- 2.2 Plug the mini-din-6 male-male cable from the computer keyboard port into one of one of the numbered mini-din-6 female connectors with a keyboard symbol on the Vista Mini rear panel. If your computer has a din-5 keyboard port use the mini-din-6 female to din-5 male adapter.
- 2.3 Plug the mini-din-6 male-male cable from the computer mouse port into one of one of the numbered mini-din-6 female connectors with a mouse symbol on the Vista Mini rear panel. If your computer has a serial port for the mouse use the mini-din-6 female to DB9 female adapter.
Warning do not substitute with a non-Rose adapter, there is a difference, damage may occur if you use a third-party adapter!!!
- 2.4 Plug the 3.5mm stereo cable into the stereo jack.

WARNING: Avoid routing cable near fluorescent lights, air conditioning compressors, or machines that may create electrical noise. For best quality video, when exceeding 20 feet use coax cable. *Appendix A, B, and E* for further cable information.

Step 3. Powering up the system

- 3.1 Boot up each of the connected CPUs. Vista Mini emulates all keyboard and mouse functions for automatic boot-up. You do not have to re-boot the CPU, if it is inconvenient. In this case you may need to issue the mode command, see page 9, to have proper keyboard communication.

Step 4. Switching from the keyboard

Your Vista Mini is now ready for operation using its default settings. Pressing the numbered switch on the front panel will switch to that computer. To take full advantage of the Vista Mini features, refer to the *Operation* section beginning on page 8. The *Operation* section gives detailed information about each of the Vista Mini commands, describing its application and giving the keyboard command sequence. For your convenience, this information is summarized in the *Keyboard command summary* on page 14. To begin switching immediately from the keyboard follow the instructions below.

- 4.1 Press and release your keyboard's **left** Control Key (<Ctrl>), then type in the computer number 1-2.

NOTE: Before entering any Vista Mini keyboard command, you must press and release the **left** Control Key. This activates Vista Mini to look for commands from the keyboard. You then have two seconds in which to start entering a valid command.

NOTE: When entering numeric commands, use only the numeral keys located at the top of your alpha-numeric keyboard. Numbers entered from the numeric keypad to the right will **not** be recognized as valid commands.

OPERATION

Vista Mini is simple to operate. Computer selection and function commands are entered from the keyboard. You can also select computers manually from the Vista Mini's front panel by using switches 1-4. This section details each Vista Mini function.

IMPORTANT OPERATION NOTE: To send Vista Mini keyboard commands, you must first press and release the **left** Control Key (<Ctrl>). Pressing and releasing <Ctrl> activates Vista Mini to look for commands from the keyboard. You have two seconds between each keystroke to enter a valid command, otherwise Vista Mini aborts the command.

NOTE: When entering numeric commands, use only the numeric keys located at the top of your keyboard. Numbers entered from the numeric keypad to the right will **not** be recognized as valid commands.

NOTE: Vista Mini commands ignore case. All command letters are shown capitalized for clarity only.

Keyboard computer selection

To select a computer from your keyboard, press and release your keyboard's **left** Control Key (<Ctrl>), then type in the computer number. Remember to use the numbers located at the top of your keyboard. **Do not** use the numeric keypad.

Going to the other computer

From the keyboard you can switch to the other computer by selecting either the Next or Previous computer. To go to the Next computer, press and release the **left** Control Key <Ctrl>, then press the "+/= " (plus) key. To go to the Previous computer, press and release <Ctrl>, then press the "-/_ " (minus) key. The command is not case-sensitive. Use the keys at the top of your keyboard, **not** those on the numeric pad.

Scan mode commands

To enable scanning from the keyboard, press and release the **left** Control Key (<Ctrl>), then type "S". Vista Mini will begin scanning sequentially from its current computer to the next computer, then begin again. The time between switching to the next computer is the scan time interval (see below) and is pro-

grammable from 1-15 seconds. To stop scanning, press and release **<Ctrl>**, then type "X". Scanning is also disabled by entering a computer selection command. The power-on state of scanning can be saved in non-volatile memory. To do this set the scan state and follow with the Keep command.

Scan time interval command

The scan time interval command sets the time, in seconds, that Vista Mini will pause at each of the computers when scanning. The default setting is 5 seconds. To set another interval, press and release the **left** Control Key, type "T", enter the new scan time interval (in seconds), and press **<Enter>**. Remember to use the upper numeric keys, **not** the numeric keypad to the right. Follow with the Keep command to save the setting.

Mode command

Vista Mini supports keyboard modes 1, 2, and 3. The keyboard mode is set by commands from the CPU. Mode 2 is the most common mode used by the vast majority of PCs. It is also the power-up state of all PC and PS/2 keyboards. Mode 1 is used primarily by older IBM PS/2 models. Mode 3 is used by many Unix workstations, such as SGI, HP, DEC, RS 6000, and others.

Vista Mini automatically detects each CPU's keyboard mode upon CPU boot-up, and thus learns which CPU uses which mode. If the CPU has already booted and is then connected, Vista Mini cannot detect the CPU's keyboard mode and uses the setting stored in the Vista Mini's non-volatile memory. The mode command can be issued to change the keyboard mode for each computer and can be saved in non-volatile memory with the Keep command.

To issue the Mode command, press and release the **left** Control Key, type "M", and enter the mode number "1", "2", or "3" followed by **<Enter>**. Remember to use the alpha-numeric keys, **not** the numeric keypad, to enter the mode number. Follow with the Keep command. The mode is changed on your currently selected computer. To change the mode on another computer, you must first switch to that computer and then issue the mode command.

Typematic value command

Vista Mini can be configured to control the keyboard typematic rate and delay. This setting is used to adjust the user preference of the way the keyboard acts

when holding a key down to repeat the key, such as when moving a cursor across a line. The rate is the speed at which the keys are sent in keys/second. The delay is the wait time in milliseconds after the key is initially pressed, before additional keystrokes are sent. To issue the command press and release the **left** Control key, then type “**A**”, then enter the 1-3 digit decimal *typematic value* followed by **<Enter>**. The *typematic value* is defined as shown below. Use the keep command to save the value.

The *typematic value* to be used is determined from the following tables using the equation: **Typematic Value = Rate value + Delay Value**. Pick the desired rate in keys/sec. (32 choices) and delay in milliseconds (4 choices) from the tables below. Add the values to the right of the desired settings. For example to use a Rate of 16.0 keys/sec. and a 500 millisecond delay, the typematic value = 7 + 32 = 39, so to set this value, type **<Ctrl> A 39 <Enter>**.

Table 4. Typematic rate							
Rate Keys/sec	Rate Value	Rate Keys/sec	Rate Value	Rate Keys/sec	Rate Value	Rate Keys/sec	Rate Value
30.0	0	15.0	8	7.5	16	3.7	24
26.7	1	13.3	9	6.7	17	3.3	25
24.0	2	12.0	10	6.0	18	3.0	26
21.8	3	10.9	11	5.5	19	2.7	27
20.0	4	10.0	12	5.0	20	2.5	28
18.5	5	9.2	13	4.6	21	2.3	29
17.1	6	8.6	14	4.3	22	2.1	30
16.0	7	8.0	15	4.0	23	2.0	31

Table 5. Typematic delay							
Delay in millisecc.	Delay value	Delay in millisecc.	Delay value	Delay in millisecc.	Delay value	Delay in millisecc.	Delay value
250	0	500	32	750	64	1000	96

PS/2 to serial mouse translation, wheel mouse

You can use some computers with PS/2 mouse interfaces and some computers with serial interfaces. You must issue this command on each computer which is serial. You must switch to each computer and issue the command.

To configure a computer for a serial mouse, press and release the **left** Control Key, type “**Q1**”, and press **<Enter>**. Follow with the Keep command to save the new setting in the unit’s non-volatile memory. To restore a computer which was previously set to serial to regular PS/2 use Q0 instead of Q1.

Whether a computer uses a PS/2 wheel mouse or a regular PS/2 mouse is learned by Vista when the computer loads its mouse driver. This will override any previous setting. You can tell Vista to change its PS/2 communication to regular or wheel with the Q command. You can also save it to non-volatile memory.

To configure a computer for a wheel mouse, press and release the **left** Control Key, type “**Q2**”, and press **<Enter>**. Follow with the Keep command to save the new setting in the unit’s non-volatile memory. To restore a computer which was previously set to wheel mouse to regular PS/2 use Q0 instead of Q2.

Keep command

The Keep command saves the current state of the Vista Mini’s custom settings. These settings are scan enable, scan interval, each CPU’s mode and keyboard LED state, maximum computers, the keyboard typematic value, and the mouse translation for each CPU. These settings are saved in non-volatile memory and become the power-up settings. To enter the command, press and release the **left** Control Key, then type “**K**”.

Null command

This command is used to re-synchronize an out-of-sync PS/2 mouse. Such a condition can result due to transients, spurious power-up effects, or plugging and unplugging of cables with live equipment. The command may need to be entered once or twice, depending if the mouse is out-of-sync by one or two bytes. Microsoft mouse driver version 9.01 or later corrects this inadequacy of previous drivers and renders this command unnecessary. To issue the command, press and release the **left** Control Key, then type “**N**”.

ROM Identification command

This command is used to identify the revision level of Vista Mini firmware currently installed. Before entering this command, your currently selected CPU should be at a command prompt, word processor, or editor, so that when the Vista Mini sends the ROM revision level that the result will be displayed. To issue the command, press and release the **left** Control Key, then type “I”. Vista Mini will send back its current firmware revision level, in the format *majorlevel.minorlevel*.

Reset command

This command is used to re-boot the mouse and keyboard without removing power from the Vista Mini. This is most useful to reset a PS/2 mouse which has been unplugged and plugged back in. This command is also useful to enable mouse data to be sent to a CPU which has not enabled the mouse. This may be the case if the Vista Mini was not connected or powered off after a CPU was booted up. To issue the command, press and release the **left** Control Key, then type “R”. This command should not be issued to a CPU which has a PS/2 mouse connected, but no mouse driver is loaded, since many CPUs will crash if you send them unexpected mouse data.

Immediately upon issuing the command, you will see the keyboard LEDs all go on and then resume their previous state.

Reset computer mouse command

This command sends a mouse reset command to the currently selected computer. Don't confuse this command with the reset command which resets the mouse itself. This command can be used to recover a stuck mouse on NT. To issue the command, press and release the **left** Control Key, then type “O”.

Do not use this on older computers which can not recover the mouse by plugging a mouse in directly as it will make the mouse go out of sync.

Reset to factory default

The settings that have been previously set and saved in non-volatile memory can be returned to their factory default settings. This can be useful when the unit is being moved to a new installation or to put the settings into a known condi-

tion. To perform this operation, hold in the "1" switch on the front panel and press and release the "reset" switch. At least one CPU must be connected to the unit, so that the unit can be powered. The status LED will flash three times to signify that the non-volatile memory has been returned to the original factory default settings listed in Appendix A.

KEYBOARD COMMAND SUMMARY

To enter any keyboard command, first press and release the **left** Control Key, represented by **<Ctrl>**. Then enter the command followed by any parameters you wish to specify, for example the computer number.

Letter commands are not case sensitive, and are shown in upper case for clarity only.

Do not use the numeric keypad to enter any commands.

All Vista Mini commands use a two second time-out between characters, to abort the command. This is a feature that restores the keyboard to normal operation, so the keyboard is not put it into a command mode which might lock it up from normal operation.

The **<Ctrl>** character is always passed through to the CPU. The command characters and command operands, however, are absorbed by the Vista Mini and not sent to the CPU.

Table 6. Keyboard command summary

Command	Key Sequence	Description
Connect to computer	<Ctrl> x where x is 1, or 2	Connects your common keyboard, monitor, and mouse to the selected computer.
Connect to next computer	<Ctrl> +	Selects the other computer.
Connect to previous computer	<Ctrl> -	Selects the other computer
Scan On	<Ctrl> S	Turns Scan mode on, causing Vista Mini to start scanning sequentially from the current port through the remaining ports and beginning again at Port 1.
Scan Off	<Ctrl> X	Turns Scan mode off. Note: Scan can also be stopped by entering a port selection command.

Reset command	<Ctrl> R	Resets and enables mouse and keyboard, enables PS/2 mouse on currently selected port.
Send null to mouse	<Ctrl> N	Used to re-synchronize PS/2 mouse which has gotten out-of-sync.
Reset computer mouse	<Ctrl> O (alpha not zero)	Used to reset computer's mouse
Identify ROM version	<Ctrl> I	Identifies ROM version, CPU must be at some sort of command prompt to receive value.
Keep settings	<Ctrl> K	Tells Vista Mini to save current scan state and custom settings of commands shown below.
Scan time interval	<Ctrl> T xx <Enter> where xx is time in seconds from 1-15 seconds	Sets the time, in seconds, that Vista Mini will pause at each port when scanning. Note: Follow with Keep command.
Set keyboard mode	Select port, then enter command: <Ctrl> M x <Enter> where x is 1, 2, or 3	Sets Vista Mini CPU's keyboard mode. Used when CPU is booted before being connected to Vista Mini. Note: Follow with Keep command.
Set typematic value	<Ctrl> A xxx <Enter> where xxx is a 1-3 digit number from 0 to 127 indicating KB typematic value	Sets power-on keyboard typematic action which is controlled by the Vista Mini. This can be used to adjust the key stroke rate and delay to the user preferred setting. See <i>Tables 4 and 5</i> for how the typematic value is determined. Note: Follow with Keep command.
Set mouse type	Select port, then enter command <Ctrl> Q x <Enter> where x is a 0 for a regular PS/2 mouse, 1 for a serial mouse, and 2 for a PS/2 wheel mouse.	Enable/disable PS/2 to serial mouse translation. Must be done for each computer where translation is desired by switching to it and issuing the command. Also enables/disables wheel mouse communication. Issue the command for each computer which has a wheel mouse. Requires a PS/2 mouse. Note: Follow with Keep command.

TROUBLESHOOTING

1. CPU does not boot, keyboard error received

- a. Cable is loose, reseal cable and hit F1 to continue or reboot computer.
- b. Wrong cable plugged in, keyboard and mouse cables reversed.
- c. Cable is defective, try using cable from another CPU. If problem goes away cable is defective.
- d. Port on Vista Mini is defective, try using another port on Vista Mini. If problem goes away port is defective.
- e. Port on CPU is defective, try plugging in keyboard or mouse directly if problem remains CPU port is defective. If power LED not lit when switched to computer which is power on, fuse on computer's motherboard may be blown.

2. Mouse driver does not load.

- a. If PS/2 type mouse, CPU must be connected to Vista Mini or mouse at boot-up time in order for mouse to be recognized by CPU. Reboot computer with Vista Mini powered on and cable attached.
- b. If RS-232 type mouse, make sure right COM port is being used and syntax of mouse driver is correct to search for the correct port.
- c. Incompatible or old mouse driver being used, try latest driver. At time of this publishing Microsoft 9.01 or later driver is best one available.
- d. Mouse translation set incorrectly, see page 11.

3. Can't switch ports from keyboard

- a. You must press and release the left control key before you press the key which specifies the port number. You must also use the numeric keys above the alphabetic keys, not those on the numeric keypad.

4. Wrong or missing characters from those typed

- a. The mode of the keyboard does not match that of the CPU. Issue the mode command, usually 1 for IBM PS/2s and 2 for all others. The default setting of the Vista Mini is mode 2. Sometimes an incorrect mode will confuse the CPU or keyboard and require re-booting the CPU or resetting the keyboard by unplugging and plugging it back in.

5. Mouse does not move

- a. Vista Mini turned off after or not connected when CPU was booted or the application using the mouse was run. Exit and re-enter application or operating system using mouse or issue reset command.

- b. PS/2 mouse was not connected when Vista Mini powered up or has been disconnected and reconnected. Issue the reset command.
 - c. Mouse translation set incorrectly, see page 11.
- 6. PS/2 mouse gets out of sync**
- a. Cabling was disturbed during mouse movement. Issue the null command once or twice to re-sync the mouse. Get a later mouse driver which does not exhibit this problem, such as Microsoft rev 9.01 or later.
- 7. Video fuzzy**
- a. Cable too long or wrong type. Use coax cable for high resolution.
- 8. Video not synchronized or wrong color**
- a. Cable is loose, reseal cable.
 - b. Wrong CPU cable used. If you have a 9515, 9517, 9518, XGA mono or similar monitor you must use special cables or adapters.
 - c. Cable is defective, try using cable from another CPU if problem goes away cable is defective.
 - d. Port on Vista Mini is defective, try using another port on Vista Mini. If problem goes away port is defective.
- 9. Lower resolution video OK, but can't enter high resolution mode**
- a. Wrong CPU cable used.
 - b. Driver has not been setup. Windows, OS/2, or other driver has not been configured for this resolution. Configure the driver.

SERVICE INFORMATION

Maintenance and repair

The unit does not contain any user-serviceable parts inside. Any malfunction of the unit should be reported to a factory-authorized repair center for service. Any discrepancies in the operation of the unit according to this manual should be reported to the Technical Support Department of Rose Electronics.

APPENDIX A. FACTORY DEFAULT SETTINGS

Setting	Default
Scan enable	Off
Scan Time Interval	5 seconds
Caps/Numlock/Scroll	Numlock On
Keyboard Mode	2
Typematic Value	43 (Rate=10.9 chars/sec, delay = 500 millisec.)
Mouse translation	0 (PS/2 mouse input to PS/2 mouse output)

APPENDIX B. GENERAL SPECIFICATIONS

SIZE	.8" high by 3.2" wide by 4.2" deep
WEIGHT	1 lb.
ENVIRONMENT	0 to 55°C., 0% to 80% non-condensing relative humidity
INPUT POWER	Supplied by computers
CPU CONNECTORS	KVT-2U DB25 Female KVT-2PC HD15F/MD6F/MD6F/3.5 mm jack
VIDEO CONNECTOR	HD15 female VGA video
PS/2 MOUSE CONNECTOR	Mini-din 6 female
KEYBOARD CONNECTOR	Mini-din 6 female
AUDIO CONNECTOR	3.5 mm stereo jack
CHASSIS	Fully shielded, black painted steel

CONTROLS	Reset switch, computer select switch
INDICATORS	Status LED, computer select LEDs 1-2, computer power LEDs 1-2

APPENDIX C. CABLES

Description	Part Number
CPU adapter cables for models with DB25 connectors	
VGA-PS/2 keyboard-PS/2 mouse to DB25M	CAB-VX0606Cxx*
VGA-AT keyboard-Serial (9) mouse to DB25M	CAB-VX0509Cxx*
Coax VGA-PS/2 keyboard-PS/2 mouse to DB25M	CAB-CX0606Cxx**
Coax VGA-AT keyboard-Serial (9) mouse to DB25M	CAB-CX0509Cxx**
CPU cables for models with PC connectors	
VGA male-male cable	CAB-HD15MMxx*
Coax VGA male-male cable	CAB-C1VMMxx*
Mini-din-6 male-male cable	CAB-MD6MMxx*
Mini-din-6 female to din-5 male adapter	ACC-MD6FD5M
Mini-din-6 female to DB9 female adapter	ACC-KVM6F9F
*Available in standard lengths of 1, 5, 10, and 20 feet Replace xx with desired length.	
**Available in 1, 5, 10, 20, 35, 50, 75, and 100 foot lengths. Replace xx with desired length.	



10707 Stancliff Road ■ Houston, Texas 77099
Phone: (281) 933-7673 ■ Internet: www.rosel.com

Free Manuals Download Website

<http://myh66.com>

<http://usermanuals.us>

<http://www.somanuals.com>

<http://www.4manuals.cc>

<http://www.manual-lib.com>

<http://www.404manual.com>

<http://www.luxmanual.com>

<http://aubethermostatmanual.com>

Golf course search by state

<http://golfingnear.com>

Email search by domain

<http://emailbydomain.com>

Auto manuals search

<http://auto.somanuals.com>

TV manuals search

<http://tv.somanuals.com>