

ROSEN®

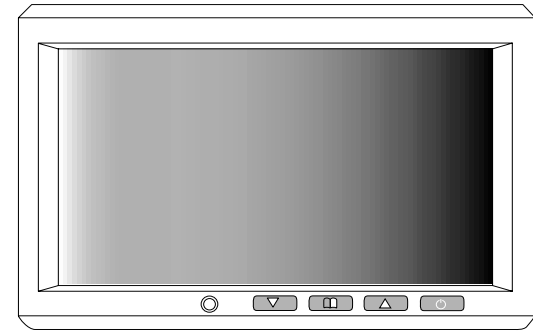

UN7000 7" Universal Headrest Monitor

***Owner's Manual
and Installation Guide***

ROSEN®

Rosen Entertainment Systems
1120 California Avenue Corona CA 92881
(909) 898-9808
www.rosenentertainment.com
9000514

Table of Contents

Flush Mounting

The kit includes a protective trim ring and an optional spacer ring for use when the mounting surface is uneven.

1. Select appropriate locations in your vehicle for the monitor and for the power supply module.
2. Be sure there is sufficient depth for the trim ring. Add the spacer ring for shallow locations with uneven curved surfaces such as upholstery. Be sure there is enough space for both the trim ring and for any excess interconnect cable.
3. Ensure that the interconnect cable will reach from the monitor location to the power supply module.
4. Create the required opening for the monitor and trim ring. Be sure it is not too large, and that there is enough space behind the trim ring to store any excess interconnect cable. Excess cable does not fit within the trim ring.
5. Route the cable through the opening in the trim ring:

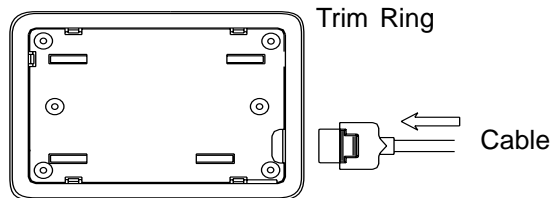

6. Mount the trim ring with the screws provided.
7. Connect the cable to the monitor.
8. Securely snap the monitor into place.

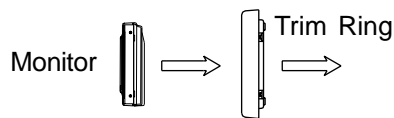

If you need to remove the monitor from the trim ring, insert the tool provided between the monitor and the trim ring to release the monitor from the flexible locking retainer tabs. Gently pull the monitor from the trim ring. Very gentle pressure can be applied using the tool provided or a credit card.

Introduction and System Overview	4
Operating Guide	5
Remote Control	5
Front Panel Controls	6
Turning On and Off the Monitor	7
Changing Video Inputs	7
Dimming the Backlight	8
Adjusting the Color, Brightness, and Tint	8
Image Formats	9
Reset All Settings	10
Installation	11
Box Contents	11
Electrical Installation	12
Physical Mounting	13
<i>Pedestal Mounting</i>	13
<i>Flush Mounting</i>	14

Introduction and System Overview

Congratulations on your purchase of a Rosen Widescreen Universal Monitor! This widescreen flat panel LCD monitor features advanced display technology and versatile installation options.

Your Rosen Widescreen Universal Monitor includes the following features:

- 16:9 aspect ratio. Sometimes called “widescreen,” this is the same aspect ratio used by next generation digital televisions.
- 7" screen (measured diagonally).
- Adjustable backlight to compensate for ambient lighting conditions.
- Normal, Zoom, and Full screen formats.
- Front panel and remote controls. These controls allow adjustment of the video settings, control of the backlighting, format, and video source. (For more information, see “Remote Control” on page 4).
- RCA video inputs.
- RCA auxiliary video output.

Important Notices

- NEVER install this monitor where it can be viewed from the driving position; this is a violation of many state and local vehicle codes.
- Use this monitor only after proper installation by a qualified installer.
- Avoid mounting locations where there is a risk of impact with a passenger in the event of an accident.
- Always mount the monitor securely using the mounting hardware that is provided. Do not use the monitor unless it is properly secured to the vehicle.
- Avoid touching the LCD screen except when cleaning it with a soft dry cloth.

Physical Mounting

Two mounting options are available - pedestal mounting or flush mounting.

Pedestal Mounting

To install the pedestal mount:

1. Select appropriate locations in your vehicle for the pedestal and for the power supply module.
2. Test fit the mounting pedestal foot in the desired location:
 - Be sure that the monitor will be able to slide onto the pedestal without interference.
 - Be sure that the mounting location can accommodate screws safely. Never screw into any surface without first inspecting behind and below it.
3. Ensure that the interconnect cable will reach from the monitor location to the power supply module location.
4. If the mounting surface is not perfectly flat, bend the flanges on the mounting foot for the best fit without yet removing the backing from the flange’s double-sided tape.
5. Remove the tape backing and press the pedestal into place.
6. Screw the pedestal into place with the mounting screws provided.
7. Slide the monitor onto the pedestal as shown, and tighten the adjustment knob. Adjust viewing angle as needed.

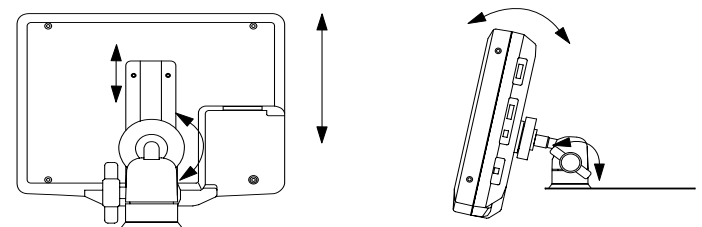

Electrical Installation

Begin installation of the Widescreen Universal Monitor by installing the power supply module and routing cables, as shown.

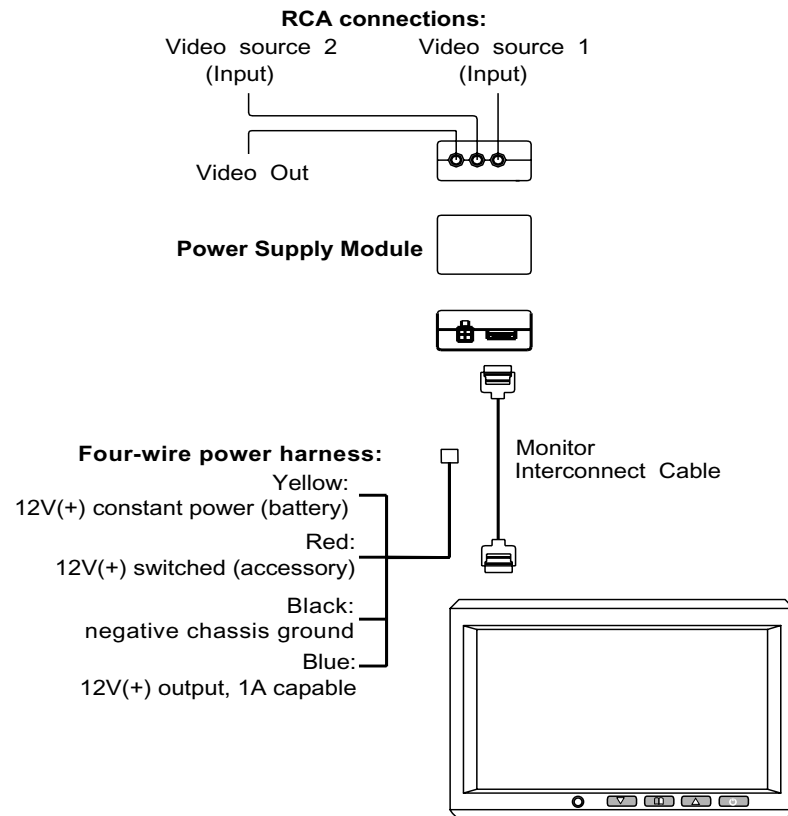

Note: This system is intended for 12-volt negative-ground systems only.

Note: To avoid damage to the power supply module, never leave the blue wire bare when unused or when it is shorted to the chassis ground.

Operating Guide

Remote Control

The remote control includes the following buttons for use with this monitor: Monitor Menu, Mode, Up, Down, and Power. Other buttons on the remote do not control the monitor.

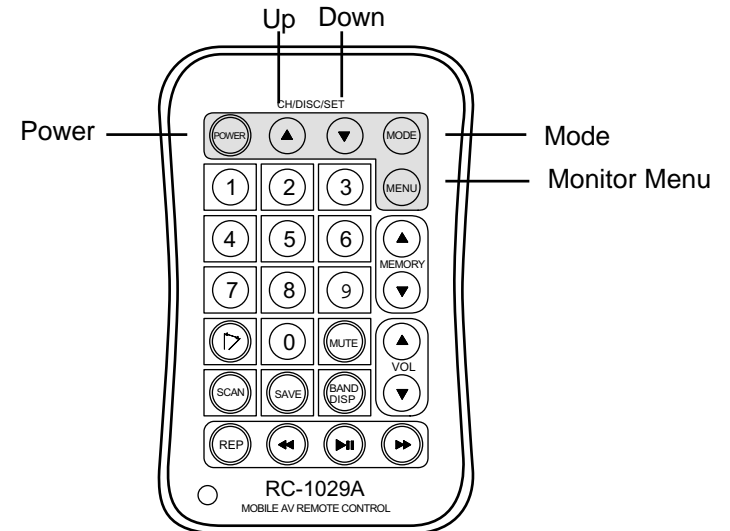

Front Panel Controls

The front panel controls are located on the lower edge of the monitor.

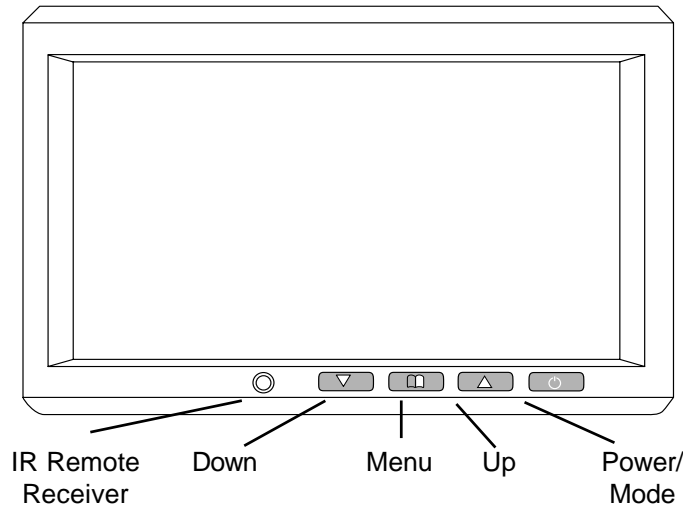

UN7000 7" Monitor

Installation

The Widescreen Universal Monitor includes mounting options described in the following sections. Before you install the monitor, consider the following important notices:

- NEVER install this monitor where it can be viewed from the driving position; this is a violation of many state and local vehicle codes.
- Avoid mounting locations where there is a risk of impact with a passenger in the event of an accident.
- Always mount the monitor securely using the mounting hardware that is provided. Do not use the monitor unless it is properly secured to the vehicle.
- The Installer accepts all responsibility for the suitability of this product installation. Rosen Entertainment Systems is not liable for any damages, incidental or otherwise, which may occur from the installation of this product.

Box Contents

The Rosen Widescreen Universal Monitor includes the following parts and equipment:

- monitor
- remote control
- power supply module
- mounting pedestal
- flush mounting trim ring
- spacer ring for the flush mount trim ring
- monitor interconnect cable
- four-wire power supply harness
- mounting screws
- removal key to release the monitor from flush mount trim ring

Reset All Settings

The Reset menu option enables you to restore all settings to their original factory values.

To reset all settings:

1. Press Menu on the monitor or Monitor Menu on the remote control. The OSD menu appears.
2. Press Menu on the monitor or Monitor Menu on the remote control until the arrow points to "Reset."
3. Press ▲ or ▼ to return all settings to factory defaults.
4. Press Menu on the monitor or Monitor Menu on the remote control again to exit the menu. The menu disappears after 5 seconds if no buttons are pressed.

Turning On and Off the Monitor

To turn on the monitor:

- Press and release the POWER button on the monitor or the remote control.

To turn off the monitor:

- Press and hold the POWER button on the monitor or the remote control.

Changing Video Inputs

The monitor can be used with either NTSC or PAL video signals. NTSC is the North American video standard and is compatible with all Rosen video sources.

To change the active video input:

1. Press the POWER button to turn on the monitor.
2. Press MENU on the monitor or MENU on the remote control. The following screen appears in the monitor.

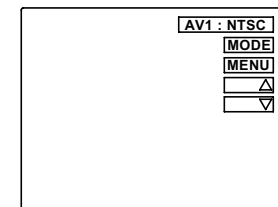

"AV1" appears briefly when AV1 is the active input.

"AV2" appears briefly when AV2 is the active input.

3. Press ▲ or ▼ to toggle between NTSC or PAL.
4. Press POWER on the monitor, or MODE on the remote control to toggle between "AV1" and "AV2."
5. Press MENU on the monitor, or MENU on the remote control again, to exit the menu.

Dimming the Backlight

The Widescreen Universal Monitor features an adjustable backlight that dims or brightens the monitor to enhance viewing in varying lighting conditions.

To adjust the backlight:

1. Press the Menu button on the monitor or Monitor Menu on the remote control. The OSD menu appears.

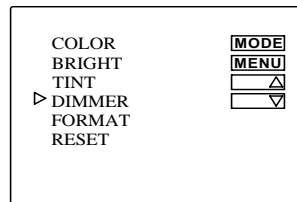

2. Press Menu on the monitor or Monitor Menu on the remote control until the arrow points to "Dimmer."
3. Press ▲ or ▼ to turn the dimmer on or off.
4. Press Menu on the monitor or Monitor Menu on the remote control three times to exit the menu. The menu disappears after 5 seconds if no buttons are pressed.

Adjusting the Color, Brightness, and Tint

If necessary, you can adjust the color, brightness, and tint of the monitor.

To adjust color, brightness, or tint settings:

1. Press the MENU button on the monitor or Monitor Menu on the remote control. The OSD menu appears.
2. Press MENU on the monitor or on the remote control until the arrow points to "Color," "Brightness," or "Tint."
3. Press the ▲ and ▼ buttons to adjust the setting. The setting will be displayed on the screen, as shown. There are 64 steps of adjustment. The default setting is 32 on a 64-step scale.

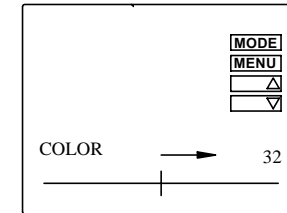

4. Press Menu on the monitor or Monitor Menu on the remote control again to exit the menu. The menu disappears after 5 seconds if no buttons are pressed.

Image Formats

The Widescreen Universal Monitor includes three image formats: "Normal," "Full," and "Zoom." "Normal" is used in most VHS applications. "Full" can use the widescreen image produced by DVDs. In order to use the DVD's "enhanced for 16:9 television," (sometimes known as anamorphic video or widescreen) set the monitor's image format to "Full."

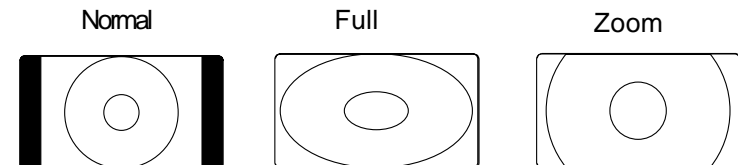

To change the image format:

1. Press Menu on the monitor or Monitor Menu on the remote control. The OSD menu appears.
2. Press Menu on the monitor or Monitor Menu on the remote control until the arrow points to "Format."
3. Press ▲ or ▼ to select a format.
4. Press Menu on the monitor or Monitor Menu on the remote control again to exit the menu. The menu disappears after 5 seconds if no buttons are pressed.

Free Manuals Download Website

<http://myh66.com>

<http://usermanuals.us>

<http://www.somanuals.com>

<http://www.4manuals.cc>

<http://www.manual-lib.com>

<http://www.404manual.com>

<http://www.luxmanual.com>

<http://aubethermostatmanual.com>

Golf course search by state

<http://golfingnear.com>

Email search by domain

<http://emailbydomain.com>

Auto manuals search

<http://auto.somanuals.com>

TV manuals search

<http://tv.somanuals.com>