

R910E

19" LCD Monitor

User's Manual

www.rosewill.com

Before operating the monitor, please read this manual thoroughly. This manual should be retained for future reference.

FCC Class B Radio Frequency Interference Statement **WARNING: (FOR FCC CERTIFIED MODELS)**

NOTE: This equipment has been tested and found to comply with the limits for a Class B digital device, pursuant to Part 15 of the FCC Rules. These limits are designed to provide reasonable protection against harmful interference in a residential installation. This equipment generates, uses and can radiate radio frequency energy, and if not installed and used in accordance with the instructions, may cause harmful interference to radio communications. However, there is no guarantee that interference will not occur in a particular installation. If this equipment does cause harmful interference to radio or television reception, which can be determined by turning the equipment off and on, the user is encouraged to try to correct the interference by one or more of the following measures:

1. Reorient or relocate the receiving antenna.
2. Increase the separation between the equipment and receiver.
3. Connect the equipment into an outlet on a circuit different from that to which the receiver is connected.
4. Consult the dealer or an experienced radio/TV technician for help.

NOTICE

1. The changes or modifications not expressly approved by the party responsible for compliance could void the user's authority to operate the equipment.
2. Shielded interface cables and AC power cord, if any, must be used in order to comply with the emission limits.
3. The manufacturer is not responsible for any radio or TV interference caused by unauthorized modification to this equipment. It is the responsibilities of the user to correct such interference.

As an ENERGY STAR® Partner Envision Peripherals Inc. has determined that this product meets the ENERGY STAR® guidelines for energy efficiency.

WARNING:

To prevent fire or shock hazard, do not expose the monitor to rain or moisture. Dangerously high voltages are present inside the monitor. Do not open the cabinet. Refer servicing to qualified personnel only.

PRECAUTIONS

- Do not use the monitor near water, e.g. near a bathtub, washbowl, kitchen sink, laundry tub, swimming pool or in a wet basement.
- Do not place the monitor on an unstable cart, stand, or table. If the monitor falls, it can injure a person and cause serious damage to the appliance. Use only a cart or stand recommended by the manufacturer or sold with the monitor. If you mount the monitor on a wall or shelf, use a mounting kit approved by the manufacturer and follow the kit instructions.
- Slots and openings in the back and bottom of the cabinet are provided for ventilation. To ensure reliable operation of the monitor and to protect it from overheating, be sure these openings are not blocked or covered. Do not place the monitor on a bed, sofa, rug, or similar surface. Do not place the monitor near or over a radiator or heat register. Do not place the monitor in a bookcase or cabinet unless proper ventilation is provided.
- The monitor should be operated only from the type of power source indicated on the label. If you are not sure of the type of power supplied to your home, consult your dealer or local power company.
- The monitor is equipped with a three-pronged grounded plug, a plug with a third (grounding) pin. This plug will fit only into a grounded power outlet as a safety feature. If your outlet does not accommodate the three-wire plug, have an electrician install the correct outlet, or use an adapter to ground the appliance safely. Do not defeat the safety purpose of the grounded plug.
- Unplug the unit during a lightening storm or when it will not be used for long period of time. This will protect the monitor from damage due to power surges.
- Do not overload power strips and extension cords. Overloading can result in fire or electric shock.
- Never push any object into the slot on the monitor cabinet. It could short circuit parts causing a fire or electric shock. Never spill liquids on the monitor.
- Do not attempt to service the monitor by yourself; opening or removing covers can expose you to dangerous voltages and other hazards. Please refer all servicing to qualified service personnel.
- To ensure satisfactory operation, use the monitor only with UL listed computers which have appropriate configured receptacles marked between 100 - 240V AC, Min. 5A.
- The wall socket shall be installed near the equipment and shall be easily accessible.
- For use only with power adaptor manufacturer by **CHI SAM ELECTRONIC** , model **CH-1205**.
- Do not install the monitor in a location near heat sources such as radiators or air ducts, or in a place subject to direct sunlight, or excessive dust or mechanical vibration or shock.

PRECAUTIONS (cont)

- Save the original shipping carton and packing materials, as they will come in handy if you ever have to ship your monitor.
- For maximum protection, repackage your monitor as it was originally packed at the factory.
- To keep the monitor looking new, periodically clean it with a soft cloth. Stubborn stains may be removed with a cloth lightly dampened with a mild detergent solution. Never use strong solvents such as thinner, benzene, or abrasive cleaners, since these will damage the cabinet. As a safety precaution, always unplug the monitor before cleaning it.

SPECIAL NOTES ON LCD MONITORS

The following symptoms are normal with LCD monitor and do not indicate a problem.

NOTES

- Due to the nature of the fluorescent light, the screen may flicker during initial use. Turn off the Power Switch and then turn it on again to make sure the flicker disappears.
- You may find slightly uneven brightness on the screen depending on the desktop pattern you use.
- The LCD screen has effective pixels of 99.99% or more. It may include blemishes of 0.01% or less such as a missing pixel or a pixel lit all of the time.
- Due to the nature of the LCD screen, an afterimage of the previous screen may remain after switching the image, when the same image is displayed for hours. In this case, the screen is recovered slowly by changing the image or turning off the Power Switch for hours.

BEFORE YOU OPERATE THE MONITOR

FEATURES

- 48cm(19") TFT Color LCD Monitor
- Crisp, Clear Display for Windows
- Recommended Resolutions: 1280 X 1024 @ 60Hz
- EPA ENERGY STAR®
- Dual Input (DVI + Analog)
- 2W+2W Stereo Speakers
- Space Saving, Compact Case Design

CHECKING THE CONTENTS OF THE PACKAGE

The product package should include the following items:

1. LCD Monitor
2. 15-pin D-Sub Cable
3. DVI Cable
4. Power Cord
5. PC Stereo Cable
6. External Power Adapter
7. Driver Disk
8. Quick Start Guide (QSG)
9. Warranty, Notices, Warnings & Precautions Booklet
9. Input Not Supported Solution Sheet

INSTALLATION INSTRUCTIONS

SWIVEL BASE

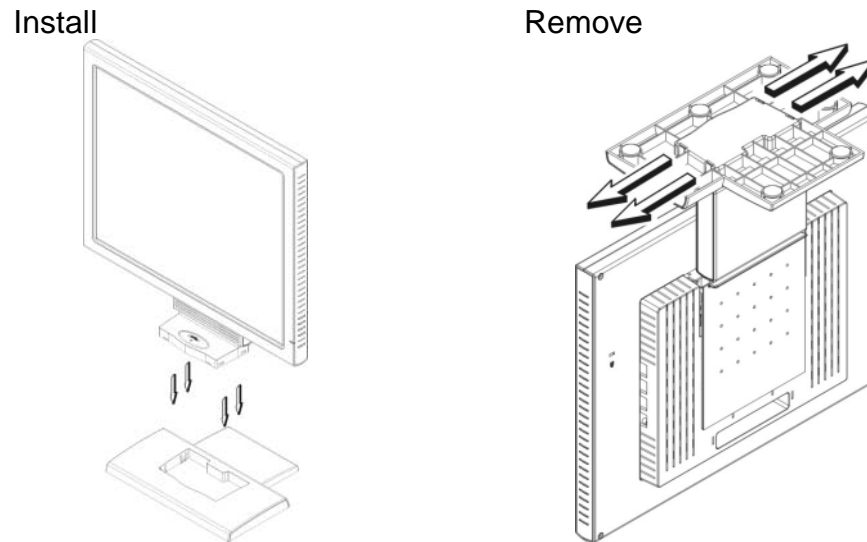

Figure 1 Installing and Removing the Swivel Base

POWERCORD

Power Source:

1. Make sure that the power cord is the correct type required in your area.
2. This LCD monitor has an External universal power supply that allows operation in either 100/120V AC or 220/240V AC voltage area (No user adjustment is required.)
3. Connect the AC-power cord into your LCD monitor's External Adapter input socket, and then plug the other end of External adapter to LCD monitor's DC-power-input. The AC-power cord may be connected to either a wall power outlet or the power outlet socket on your PC, depending on the type of power cord supplied with your LCD monitor.

NOTES

A certified power supply cord has to be used with this equipment. The relevant national installation and/or equipment regulations shall be considered. A certified power supply cord not lighter than ordinary polyvinyl chloride flexible cord according to IEC 60227 (designation H05VV-F 3G 0.75mm or H05VVH2-F2 3G 0.75mm) shall be used. Alternative a flexible cord be of synthetic rubber according to IEC 60245 (designation H05RR-F 3G 0.75mm) shall be used.

INSTALLATIONS INSTRUCTIONS (cont)

PREPARING TO INSTALL THE CABLES

1. Remove the wall mounting hole cover.
2. Remove the cable cover.

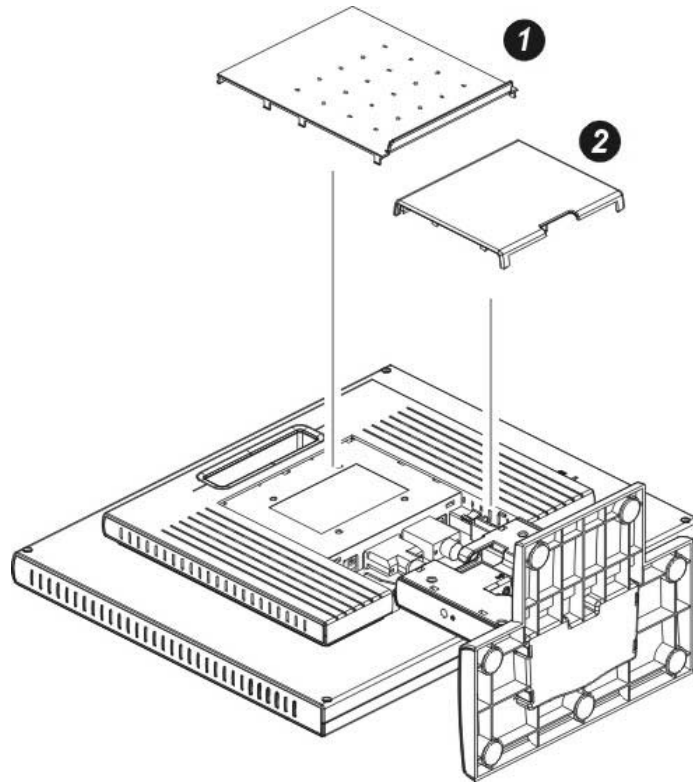

INSTALLATIONS INSTRUCTIONS (cont)

CABLE CONNECTIONS

- 1 – Connect the DC-jack power cable into DC-IN connector on the back of the monitor.
 2. Connect one end of the 15-pin D-Sub cable to the back of the monitor and connect the other end to the computer's D-Sub port.
 3. (Optional – Requires a video card with DVI port) Connect one end of the 24-pin DVI cable to the back of the monitor and connect the other end to the computer's DVI port. be tightened.
 4. (Optional) - Connect the audio cable between the monitor's audio input & the computer sound card's audio output (green port).
 5. Connect the female end of the power cord to the monitor's power adapter and connect the male end of the power cord to the AC outlet.
- Caution:** If the AC outlet is not grounded (with three holes), install the proper grounding adapter (not supplied).
6. (Optional – Headphone not included) – Connect a headphone to the monitor's headphone jack.

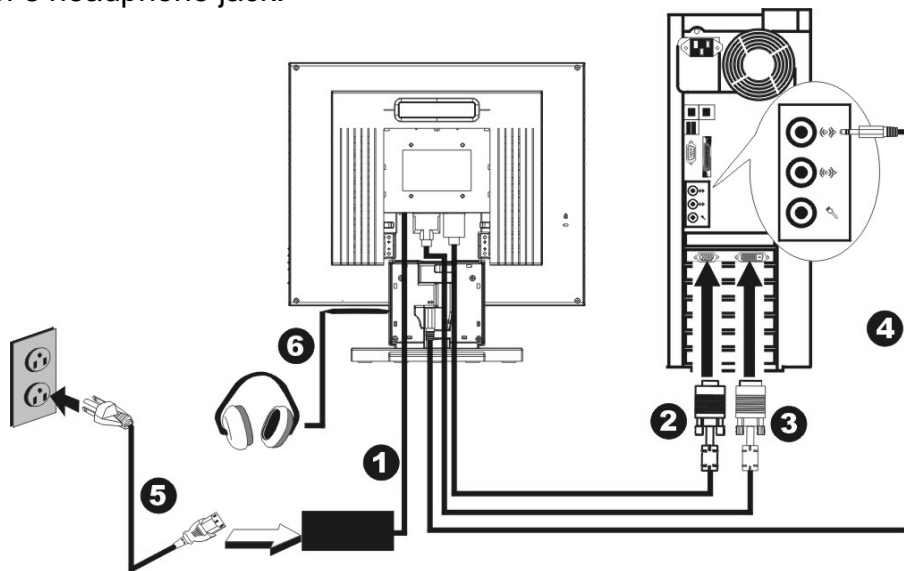
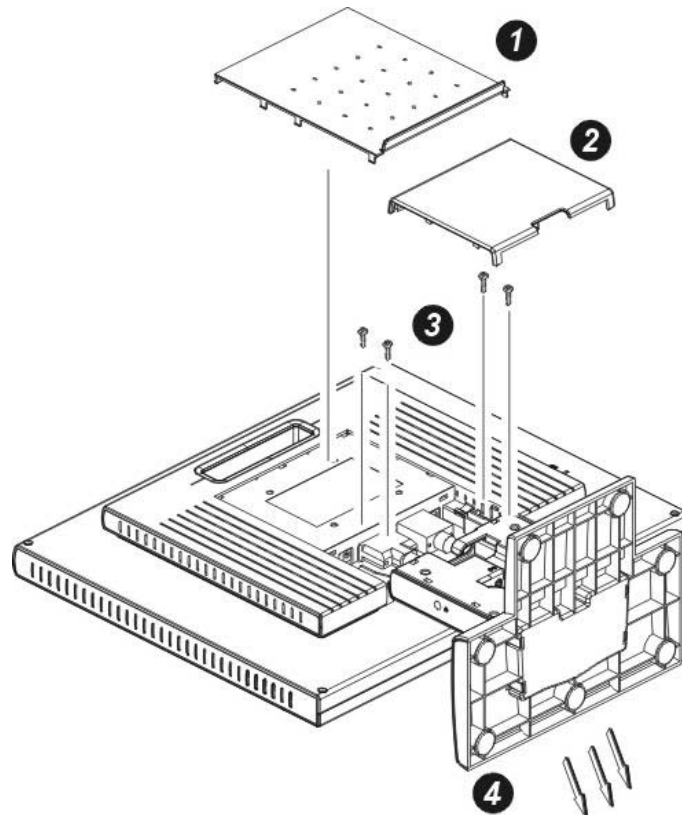

Figure 2 - Connecting Cables

- | | |
|-----------------------|-----------------------------|
| 1. External Adapter | 5. Power Cord |
| 2. 15-pin D-Sub Cable | 6. Headphone (Not Included) |
| 3. DVI Cable | |
| 4. Audio Cable | |

INSTALLATION INSTRUCTIONS (cont)

Preparing To Install The Optional Wall Mount Arm (Not Included)



This monitor can be attached to a wall mounting arm or bracket you can purchase separately from Ergotron (www.ergotron.com). Turn the power OFF then dis-connect the cables from the monitor before performing the procedure below. Lay the monitor face down on a soft surface.

1. Remove wall mounting hole cover.
2. Remove the cable cover.
3. Remove the 4 screws holding the base to the back of the monitor.
4. Remove the base.

Attaching The Optional Wall Mount Arm (not supplied)

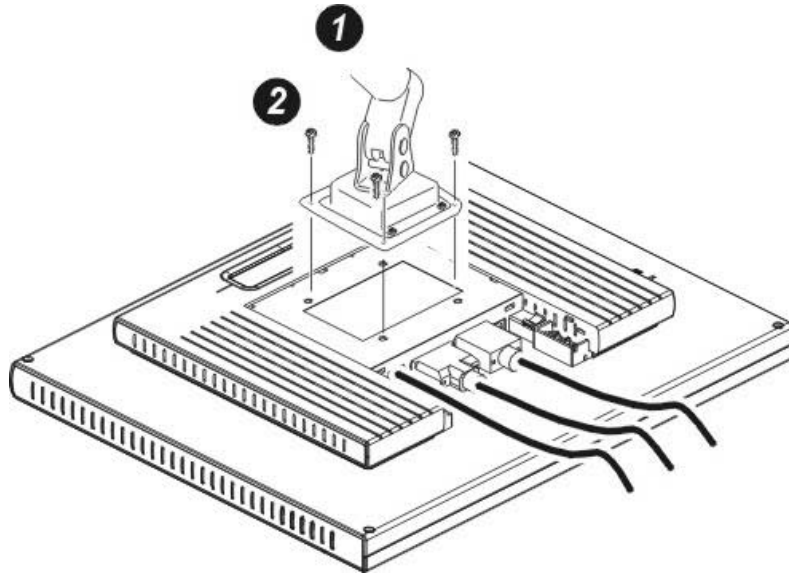

Follow these steps to finish installing the wall mounting arm:

1. Place the wall mounting arm onto the back of the monitor. Line up the holes of the arm with the holes in the back of the monitor.
2. Insert the 4 screws into the holes and tighten.
3. Reconnect the cables. Refer to the user's manual that came with the optional wall mounting arm for instructions on attaching it to the wall.

- For optimal viewing it is recommended to look at the full face of the monitor, then adjust the monitor's angle to your own preference.
- Hold the stand so you do not topple the monitor when you change the monitor's angle.
- You are able to adjust the monitor's angle from -5° to 20° .

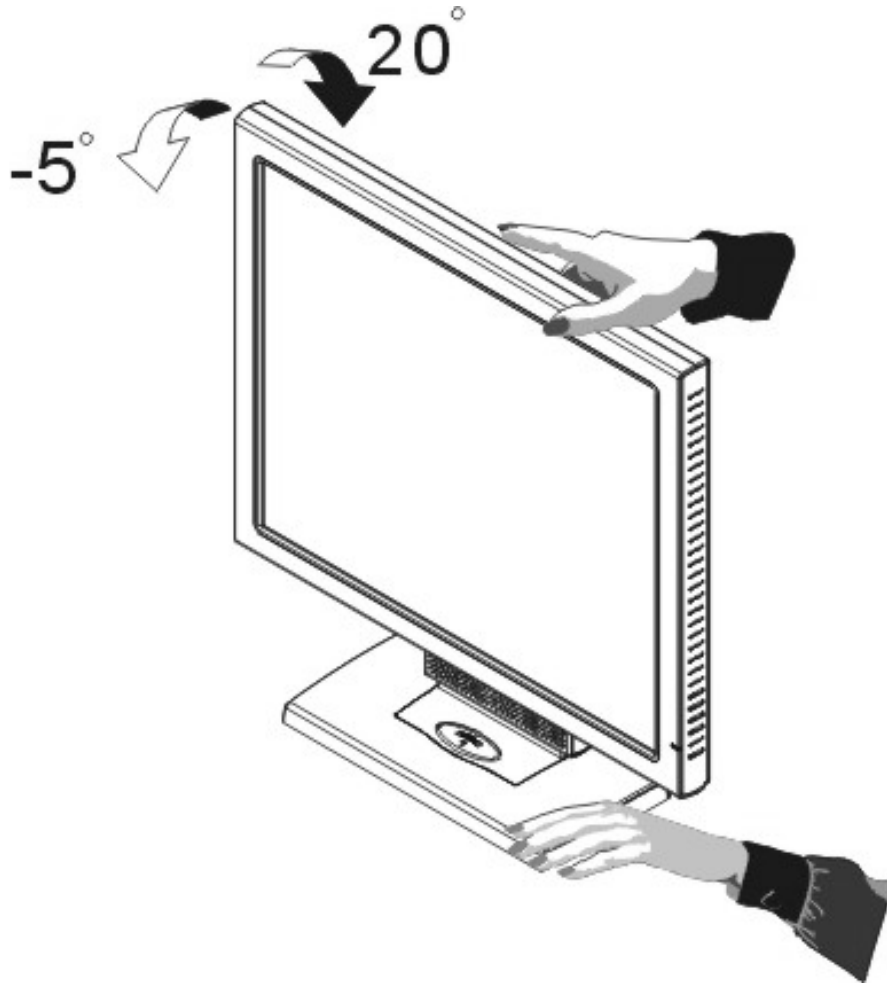

Figure 3

NOTES

- Do not touch the LCD screen when you change the angle. It may cause damage or break the LCD screen.
- Careful attention is required not to catch your fingers or hands when you change the angle.

OPERATING INSTRUCTIONS

GENERAL INSTRUCTIONS

Press the power button to turn the monitor on or off. The other control buttons are located on the side of the monitor (See Figure 4). By changing these settings, the picture can be adjusted to your personal preferences.

- The power cord should be connected.
- Connect the video cable from the monitor to the video card.
- Press the power button to turn on the monitor. The power indicator will light up.

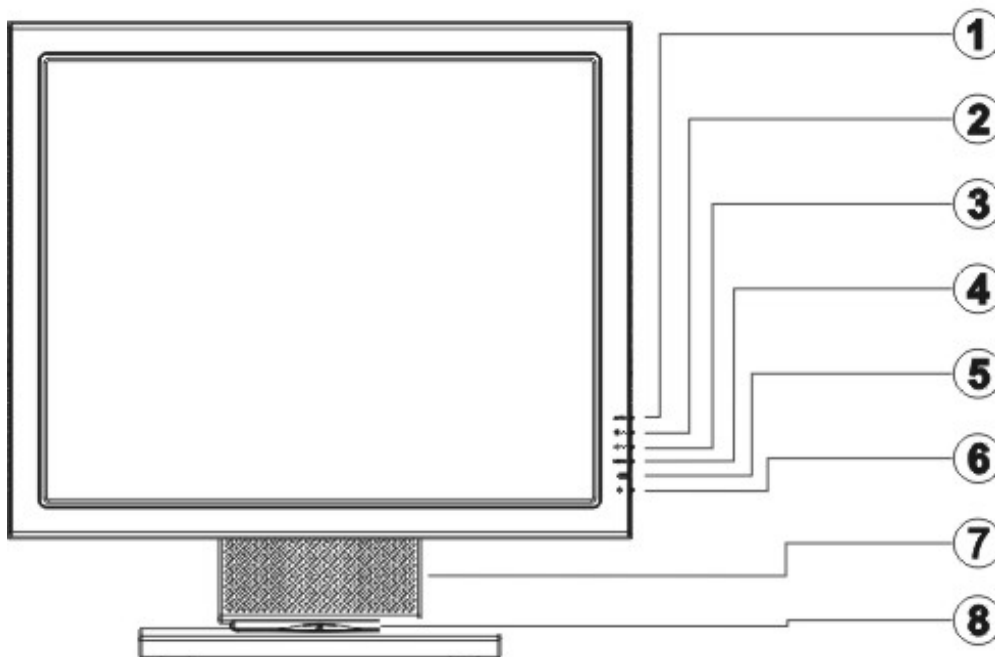

Figure 4 - External Control Button

EXTERNAL CONTROLS

1.	Auto Config / Exit	5.	Power Indicator
2.	▲ / Brightness	6.	Power Button
3.	▼ / Contrast	7.	Headphone Jack
4.	MENU / ENTER	8.	Volume Control

FRONT PANEL CONTROL

- **Power Button:**
Press this button to switch the monitor's power ON or OFF.
- **MENU / ENTER :**
Activate OSD menu when OSD is OFF or activate/de-activate adjustment function when OSD is ON or Exit OSD menu when in Brightness/Contrast OSD status.
- **Brightness ☀ / ▲ :**
Adjust brightness or function adjust.
- **Contrast ● / ▼ :**
Adjust contrast or function adjust.
- **Auto Adjust button / Exit:**
 1. When OSD menu is in active status, this button will act as EXIT-KEY (EXIT OSD menu)
 2. When OSD menu is in OFF, press this button for 2 seconds to activate the Auto Adjustment function.
The Auto Adjustment function is used to set the HPos, VPos, Clock and Focus.
- **Power Indicator:**
Green — Power On mode.
Orange — Off mode.
- **Headphone Jack:**
A headphone can be connected to this jack for private audio listening.
- **Volume Control:**
Adjusts the monitor's built-in speakers volume.

HOW TO ADJUST A SETTING

1. Press the MENU-button to activate the OSD window. See figure 5.
2. Press ▲ or ▼ to select the desired function. See figure 5.
3. Press the MENU-button again to activate the highlighted function.
4. Press ▲ or ▼ to adjust the selected function.
Note: ▲ is used to adjust the function down & ▼ is used to adjust the function up. This is due to the orientation of the adjustment level bar.
5. When the OSD window is active, it shows the input signal timing. The "H" stands for the horizontal frequency and "V" for the vertical frequency.
6. To exit and save, select the exit function, or leave the monitor alone for 10 seconds. If you want to adjust another function press MENU again and repeat steps 2-4.

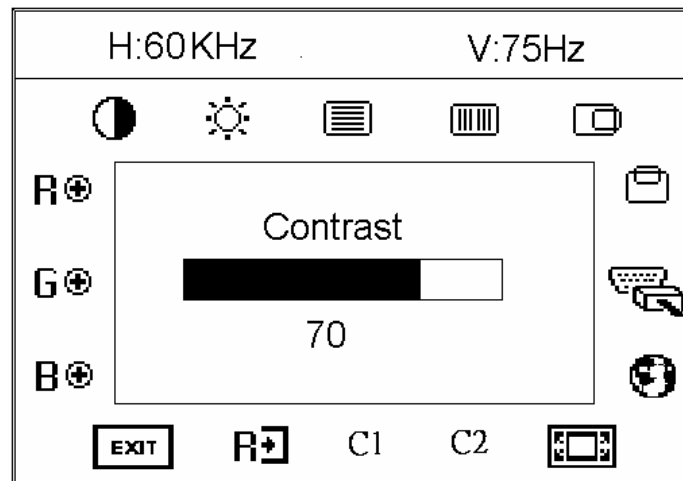

















Figure 5 The OSD Message

ADJUSTING THE PICTURE

Below describes the function of each OSD icon.

1.		Contrast	Adjust the picture contrast.
2.		Brightness	Adjust the picture brightness.
3.		Input Selected	Input Signal source selected (select Analog or Digital input source)
4.		Focus	Adjust picture Focus (available in Analog mode only).
5.		Clock	Adjust picture Clock (available in Analog mode only).
6.		H- Position	Adjust the horizontal position of the picture (availab in Analog mode only).
7.		V- Position	Adjust the vertical position of the picture (available in Analog mode only).
8.		Language	Multi-Language selection
9.		Scaling Mode	Stretch the picture to fit full screen, screen size ratio or native size (this function only works when the resolution setting is lower than the native resolution of 1280x1024).
10.		Red	Adjusts Red intensity.
11.		Green	Adjusts Green intensity.
12.		Blue	Adjusts Blue intensity.
13.		(6500K)Color	The color temperature for 6500°K is x=0.313, y=0.329.
14.		(7800K)Color	The color temperature for 7800°K is x=0.296, y=0.311.
15.		Reset	Clear old settings of Auto-configuration, re-activates auto-configuration and set the color temperature to 7800°K.
16.		Exit	Save user adjustment and exit OSD menu.

PLUG AND PLAY

Plug & Play DDC1/2B Feature

This monitor is equipped with VESA DDC1/2B capabilities according to the VESA DDC STANDARD. It allows the monitor to inform the host system of its identity and, depending on the level of DDC used, communicate additional information about its display capabilities. The communication channel is defined in two levels, DDC1 and DDC2B.

The DDC1 is a unidirectional data channel from the display to the host that continuously transmits EDID information. The DDC2B is a bidirectional data channel based on the I²C protocol. The host can request EDID information over the DDC2B channel.

THIS MONITOR WILL APPEAR TO BE NON-FUNCTIONAL IF THERE IS NO VIDEO INPUT SIGNAL. IN ORDER FOR THIS MONITOR TO OPERATE PROPERLY, THERE MUST BE A VIDEO INPUT SIGNAL.

This monitor meets the Green monitor standards as set by the Video Electronics Standards Association (VESA) and/or the United States Environmental Protection Agency (EPA) and The Swedish Confederation Employees (NUTEK). This feature is designed to conserve electrical energy by reducing power consumption when there is no video-input signal present. When there is no video input signal this monitor, following a time-out period, will automatically switch to an OFF mode. This reduces the monitor's internal power supply consumption. After the video input signal is restored, full power is restored and the display is automatically redrawn. The appearance is similar to a "Screen Saver" feature except the display is completely off. The display is restored by pressing a key on the keyboard, or clicking the mouse.

USING THE RIGHT POWER CORD :

The accessory power cord for the Northern American region is the wallet plug with NEMA 5-15 style and is UL listed and CSA labeled. The voltage rating for the power cord shall be 125 volts AC.

Supplied with units intended for connection to power outlet of personal computer: Please use a cord set consisting of a minimum No. 18 AWG, type SJT or SVT three conductors flexible cord. One end terminates with a grounding type attachment plug, rated 10A, 250V, CEE-22 male configuration. The other end terminates with a molded-on type connector body, rated 10A, 250V, having standard CEE-22 female configuration.

Please note that power supply cord needs to use VDE 0602, 0625, 0821 approval power cord in European counties.

TECHNICAL SUPPORT (FAQ)

Problem & Question	Possible Solution
Power LED is not on	<ul style="list-style-type: none"> *Check if the Power Switch is in the ON position *Power Cord should be connected
No Plug & Play	<ul style="list-style-type: none"> *Check if the PC system is Plug & Play compatible *Check if the Video Card is Plug & Play compatible *Check if the D-15 plug pin of Video Cable is bent *Make sure the AOC Monitor Drivers are installed (AOC Monitor Drivers are available at: www.aocmonitor.com)
Picture is fuzzy	<ul style="list-style-type: none"> *Adjust the Contrast and Brightness Controls.
Picture bounces or a wave pattern is present in the picture	<ul style="list-style-type: none"> *Move electrical devices that may cause electrical interference.
The power LED is ON (orange) but there's no video or no picture.	<ul style="list-style-type: none"> *Computer Power Switch should be in the ON position. *Computer Video Card should be snugly seated in its slot *Make sure monitor's video cable is properly connected to the computer. *Inspect monitor's video cable and make sure none of the pins are bent. *Make sure computer is operational by hitting the CAPS LOCK key on the keyboard while observing the CAPS LOCK LED. The LED should either turn ON or OFF after hitting the CAPS LOCK key.
Missing one of the primary colors (RED, GREEN, or BLUE)	<ul style="list-style-type: none"> *Inspect the monitor's video cable and make sure that none of the pins are bent.

Screen image is not centered or sized properly.	*Adjust pixel frequency (CLOCK) and FOCUS or press hot-key (AUTO)
Picture has color defects (white does not look white)	*Adjust RGB color or select a pre-set color temperature from OSD.
Horizontal or vertical disturbances on the screen	*Use win 95/98 shut-down mode Adjust CLOCK and FOCUS or perform hot- key (AUTO-key).

CLOCK (pixel frequency) controls the number of pixels scanned by one horizontal sweep. If the frequency is not correct, the screen shows vertical stripes and the picture has not correct width.

FOCUS adjusts the phase of the pixel clock signal. With a wrong phase adjustment the picture has horizontal disturbances in light picture.

For FOCUS and CLOCK adjustment use “dot-pattern” or Win 95/98 shut-down mode pattern .

ERROR MESSAGE & POSSIBLE SOLUTION

NO SIGNAL

1. Check that the signal-cable is properly connected , If the connector is loose, tighten the connector's screws.
2. Check the signal-cable's connection pins for damage.

INPUT NOT SUPPORT

Your computer has been set to unsuitable display mode ,set the computer to display mode given in the following table.

UNSUPPORTED MODE TRY DIFFERENT VIDEO CARD SETTING

Your computer resolution is out of VESA-SPEC

RESOLUTION

RESOLUTION	VERTICAL FREQUENCY
640 × 400	70Hz
640 × 350	70Hz
720 × 400	70Hz
720 × 400	85Hz
640 × 480	60Hz
640 × 480	72Hz
640 × 480	75Hz
640 × 480	85Hz
800 × 600	56Hz
800 × 600	60Hz
800 × 600	72Hz
800 × 600	75Hz
800 × 600	85Hz
1024 × 768	60Hz

1024 × 768	70Hz
1024 × 768	75Hz
1024 × 768	85Hz
1280 × 1024	60Hz
1280 × 1024	75Hz
1280 × 1024	85Hz
1152 × 864	75Hz
1280 × 960	60Hz
1280 × 960	85Hz
640 × 480	67Hz
832 × 624	75Hz
640 × 400	56Hz

NOTE: For digital input, the resolution 1280 x 1024 @ 85Hz and 1280 x 960 @ 85Hz are not supported

HOW TO INSTALL THE DRIVER-DISK (INF & ICM FILE)

FOR FIRST TIME INSTALL :

This is a Plug & Play LCD monitor. Turn off the PC then connect the cables. Power on the PC and it will automatically detect your new monitor. The Windows Operating system will automatically install a plug & play driver for it.

APPENDIX

SPECIFICATIONS

LCD Panel	Driving system	TFT Color LCD
	Size	48cm(19.0")
	Pixel pitch	0.294mm(H)x 0.294mm(V)
	Viewable angle	170° (H) 170° (V)
	Response time	25 ms (Typical)
Input	Video	R,G,B Analog Interface
	Separate Sync.	H/V TTL
	H-Frequency	31KHz – 92KHz
	V-Frequency	55-85Hz
Display Colors		16.7M Colors
Dot Clock		135MHz
Max. Resolution		1280 x 1024 @85Hz
Plug & Play		VESA DDC1/2B™
EPA ENERGY STAR®	ON Mode	≤60W
	OFF Mode	≤5W
Input Connector		D-Sub 15pin
Input Video Signal		Analog:0.7Vp-p(standard), 75 OHM, Positive
Input Connector		DVI 24pin
Input Video Signal		Digital sigal
Maximum Screen Size		Horizontal : 376.32mm Vertical : 301.056mm
Power Source		12VDC/5.0A 60W Max
Environmental Considerations		Operating Temp: 0° to 40°C Storage Temp.: -10° to 50°C Operating Humidity : 20% to 90%
Weight (N. W.)		6.9Kgs Unit (net)

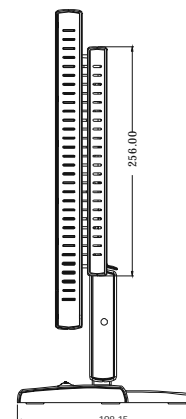
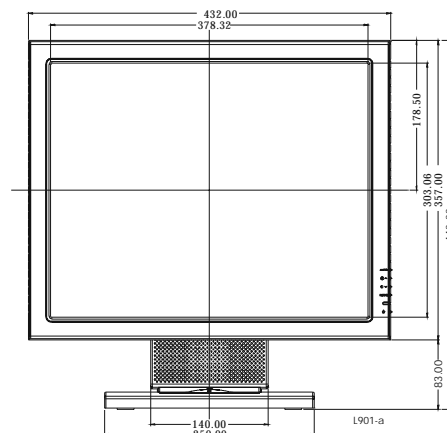

External Controls:	Switch	<ul style="list-style-type: none"> • Auto Adjust Key • ◀ / Brightness • ▶ / Contrast • Power Button • MENU/ Exit • Volume
	Functions	<ul style="list-style-type: none"> • Contrast • Brightness • Input Selected • Focus • Clock • H-Position • V-Position • Auto-center • Language • Scaling Mode • C1 (6500°K) • C2 (7800°K) • RGB Color temperature • Recall • Exit
Power Consumption (Maximum)		60 Watts
Audio Regulatory Compliance		2W + 2W rms (Stereo) UL, CSA, FCC, TÜV/GS, CE, ISO13406-2, Windows XP Logo

FACTORY PRESET TIMING TABLE

STANDARD	RESOLUTION	HORIZONTAL FREQUENCY	VERTICAL FREQUENCY
Dos-mode	640 × 400	31.47kHz	70.0Hz
Dos-mode	720 × 400	31.47kHz	70.0Hz
Dos-mode	720 × 400	31.47kHz	70.0Hz
VGA	640 × 480	31.47kHz	60.0Hz
	640 × 480	35.00kHz	66.6Hz
	640 × 480	37.50kHz	75.0Hz
	640 × 480	37.86kHz	72.0Hz
SVGA	800 × 600	37.879kHz	60.0Hz
	800 × 600	46.875kHz	75.0Hz
	800 × 600	35.16kHz	56.0Hz
	800 × 600	48.01kHz	72.0Hz
	832 × 624	49.725kHz	75.0Hz
XGA	1024 × 768	48.363kHz	60.0Hz
	1024 × 768	56.476kHz	70.0Hz
	1024 × 768	60.021kHz	75.0Hz
	1280 × 1024	64.000kHz	60.0Hz
	1280 × 1024	80.000kHz	75.0Hz
SXGA	1280 × 1024	91.146kHz	85.0Hz
	1152 × 864	79.976kHz	75.0Hz
	1280 × 960	60.000kHz	60.0Hz
	1280 × 960	80.000kHz	85.0Hz

Note: The factory preset mode for DOS is 720x400 @70Hz.

CONNECTOR PIN ASSIGNMENT

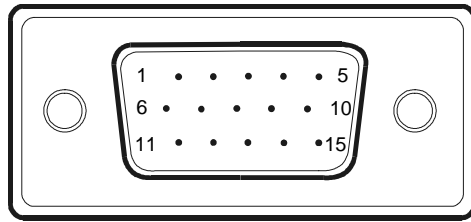

15 - Pin Color Display Signal Cable

PIN NO.	DESCRIPTION	PIN NO.	DESCRIPTION
1.	Red	9.	+5V
2.	Green	10.	Detect Cable
3.	Blue	11.	NC
4.	Ground	12.	DDC-Serial Data
5.	Ground	13.	H-Sync
6.	R-Ground	14.	V-Sync
7.	G-Ground	15.	DDC-Serial Clock
8.	B-Ground		

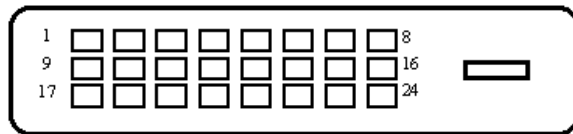

24 - Pin Color Display Signal Cable

PIN NO.	DESCRIPTION	PIN NO.	DESCRIPTION
1.	TMDS Data 2-	13.	TMDS Data 3+
2.	TMDS Data 2+	14.	+5V Power
3.	TMDS Data 2/4 Shield	15.	Ground(for+5V)
4.	TMDS Data 4-	16.	Hot Plug Detect
5.	TMDS Data 4+	17.	TMDS Data 0-
6.	DDC Clock	18.	TMDS Data 0+
7.	DDC Data	19.	TMDS Data 0/5 Shield

8.	N.C.	20.	TMDS Data 5-
9.	TMDS Data 1-	21.	TMDS Data 5+
10.	TMDS Data 1+	22.	TMDS Clock Shield
11.	TMDS Data 1/3 Shield	23.	TMDS Clock +
12.	TMDS Data 3-	24.	TMDS Clock -

Free Manuals Download Website

<http://myh66.com>

<http://usermanuals.us>

<http://www.somanuals.com>

<http://www.4manuals.cc>

<http://www.manual-lib.com>

<http://www.404manual.com>

<http://www.luxmanual.com>

<http://aubethermostatmanual.com>

Golf course search by state

<http://golfingnear.com>

Email search by domain

<http://emailbydomain.com>

Auto manuals search

<http://auto.somanuals.com>

TV manuals search

<http://tv.somanuals.com>