

*Rosewill*<sup>®</sup>

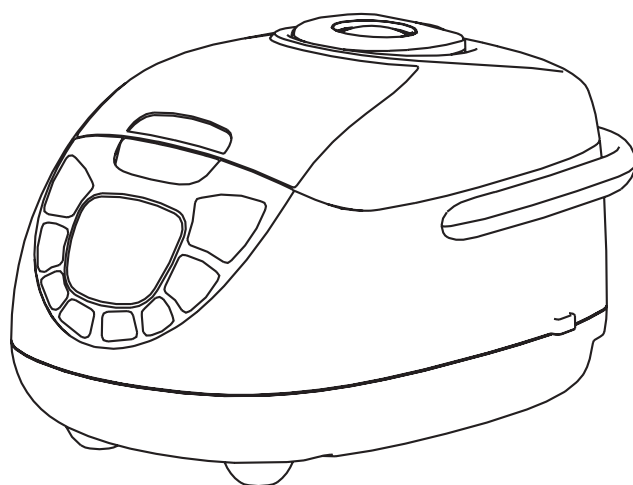

# **Fuzzy Logic Rice Cooker**

User manual

RHRC-13001

RHRC-13002

# Content

---

Specifications .....	1
Components .....	2
Control panel and components.....	3
Adjust clock .....	4
Operation .....	5
Timing .....	10
Dealing with power cut .....	10
Warning .....	11
Steam valve .....	12
Cleaning methods .....	12
Keep warm cautions .....	13
Clean and maintenance.....	13
Malfunction and solution .....	14
Circuit diagram .....	15

# Specifications

---

Model	RHRC-13001	RHRC-13002
Rated voltage	120V~60Hz	
Rated power	700W	900W
Control method	Micro-computer	
weight	7.3 lb (3.3 kg)	8.6 lb (3.9 kg)
Inner pot capacity	1.0L	1.8L
Power cord	3.3" (1.0 m)	
Cup capacity	1~5.5	2~10
Outer dimension	9.1" x 9.7" x 8.3" (231 x 246 x 212 mm)	10" x 10.7" x 10" (255 x 271 x 256 mm)

# Components

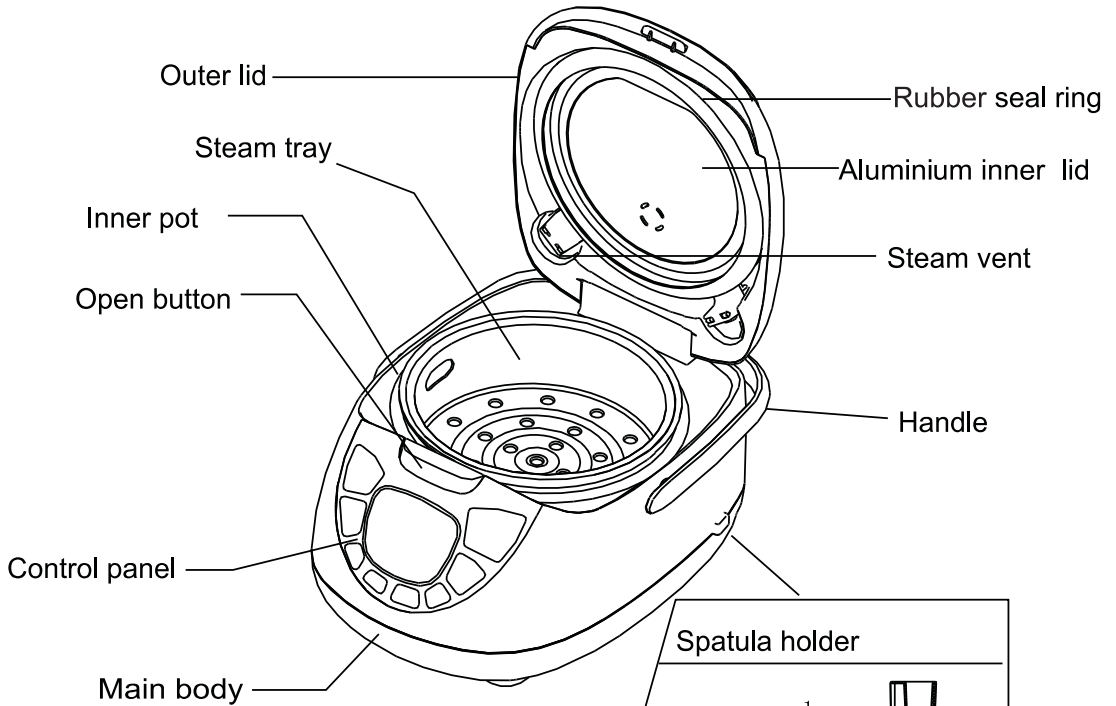

**Spatula holder**

Groove

1

2

Spatula holder

To install and detach the spatula holder, please follow the brief illustration.

2

1

**Accessories**

Spatula holder

Spoon

Measuring cup

Spatula

Mains cord

## Control panel and components

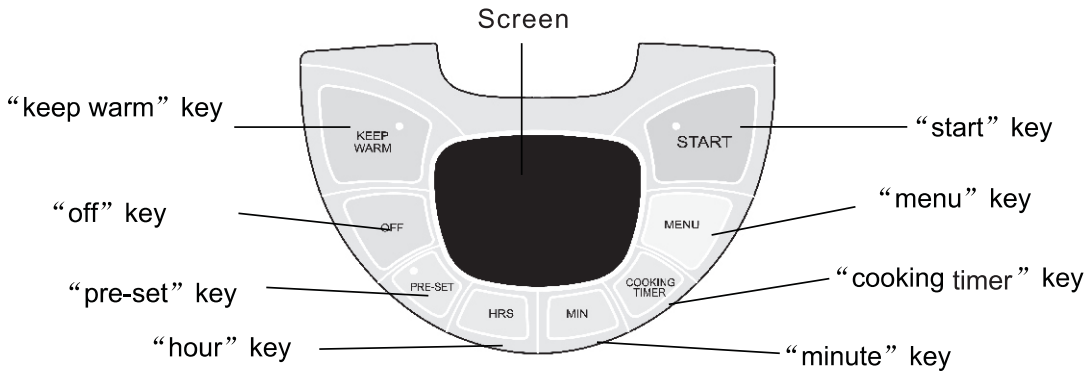

**👉 Screen**

1. When plug off, the screen only displays the present time .
2. Plug in , there will be present time and menu.



**👉 “menu” key:**

1. Plug in ,press menu key and then select various functions ;
  2. The “▲” Signal Points to function. The function circulates as follows
- ```

Regular → Quick → Cake → porridge
      ↑           ↓
      Reheat ← Brown ← Steam ← Soup
    
```

**👉 “Start ” key :**

After plug in , select one of functions and press “start” key, then “start” indicator light up automatically. The cooker enters the process of function.

**👉 “pre-set” key**

1. Only Brown function can not choose “pre-set” key.
2. Setting time is end time.
3. After selecting “pre-set” key ,press hour and minute key to adjust time.

**👉 “cooking timer” key**

1. Select Porridge, soup and steam functions by pressing cooking time key to select time. Other functions can not use this function.

2.porridge and soup function: The user can set time from 1 to 4 hours for their special requirement. The operations are as follows:

1.press “ cooking timer” key ,the screen displays cooking time.

2.setting time by pressing “hour” and “ minute” key;

1) press hour key , the timer increases progressively one hour 1 → 2 → 3 → 4 → 0

2) press minute key , the timer increases progressively one minute

00 → 01 → — — — → 59 → 00

 “hour” and “minute” key:

1.adjust clock: No need to press hour or minute key within 5 seconds after setting the time ,The time will be confirmed automatically, the screen does not flash and display the set time is affirmed .

2.pre-set: choose timing function, setting end time by pressing “hour” and “minute” key.

3. cooking timer: choose cooking timer, setting cooking timer by pressing “hour” and “minute” key.

 “keep warm” key

1.Enter process of function by pressing this key during the wait mode ;

2.After finishing porridge , soup ,brown, steam, cake, reheat, regular and quick , the “keep warm” indicator lights up.

 “off” key

Cancel all settings by pressing “off” key.

## Adjust clock

For example :set the present time 9:40

1.Press hour or minute key to adjust time parameter, when the screen flashes.

2.press hour key , the timer increases progressively one hour: 0 → 1 → 2 — — — → 23 → 0,until the number displays 9 .

3. Press minute key , the timer increases progressively one minute

00 → 01 → 02 → 03 → — — — → 59 → 00; until the number displays 40.

4. No need to press any key and the time will be confirmed automatically in 5 seconds.

Note : 1) After plugging in , the time can be set.

2) Press “start” to confirm time setting; press “off” to cancel and turn back to original time.

Rosewill micro-computer cubic rice cooker adopts the most advanced Fuzzy Logic Control for optimize cooking. Supervise temperature and water level automatically and heat by fuzzy logic control to make the rice taste soft and tasty. This cooker combines multi-function including regular, quick, cake, porridge, reheat, Brown, steam and soup. It is an easy and ideal appliance for modern kitchen.

## Operation

### 1. Measure rice with measuring cup

- \* One measuring cup is 0.18L (about 150g).
- \* Rinse rice with other container never use inner pot to avoid risk of damage of non-stick coating or deformation.



### 2. Pour rice into inner pot, and add water to appropriate scale on the inner side.

Adjust water level for your preference and never exceed the maximum scale.

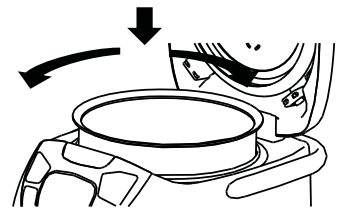
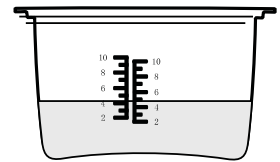

### 3. Clean and dry the inner pot, and then put it back into the main body, gently turn it to left and right to ensure its proper contact with the heat plate.

- no foreign matter exists between inner pot and heating plate.
- put rice in the inner pot evenly, not pile it up.

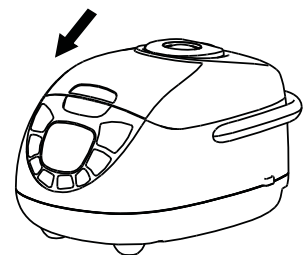

### 4. Install the aluminum lid and cover the outer lid

- Make sure the aluminum lid closed. Please click shut upper lid.
- make sure the upper lid is completely closed, lest it affects cooking.

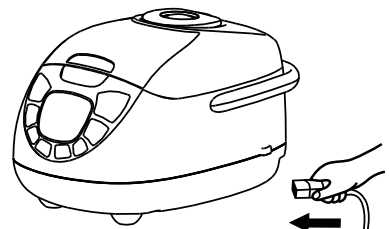

5. Correctly plug power cord to cooker outlet and plug the other end .

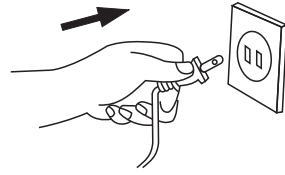

- Connect to power source , and the screen displays the present time and function. Enter waiting mode.

✦ cooking

1) Press menu key to choose cooking function

Difference between twocooking mode Cook Regular

It is suitable for different amount of rice, the Effects are ideal all the same. Large amount rice Recommended.

Quick

It is designed to meet speedy cooking needs. Small or medium amount of rice recommended After cooking ,it will go into “ keep warm ” . This is also suitable for stewing and steaming.

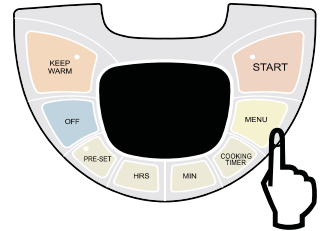

2) Press start key , enter working process.

Start indicator lights up, and the screen displays the present time.

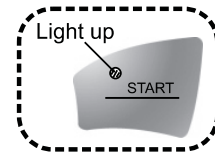

3) After finishing, enter “keep warm” process.

To prevent rice become lumpy, or taste bad, after 30 minutes “keep warm” ,loosen the rice.

4) After finishing , press off key . Plug off the power plug after use.

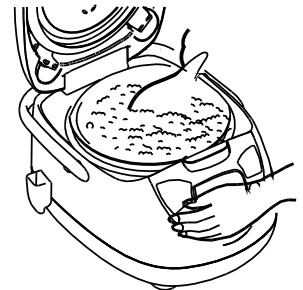

| Function      | Regular | Quick |
|---------------|---------|-------|
| Time (minute) | 40–50   | 30–40 |

Press off to stop keeping warm. The cooker will be in the state of waiting mode and unplug. Cooking time table above. This just give you a reference . The time will alternate slightly for many factors.

**Caution :** when in waiting mode ,the cooker has memory and remembers last operation and will continue to do so the next time.

porridge, soup



1.Preparation gets ready

Add water to corresponding scale.

2.Connect to power ,press menu key to choose porridge or soup function.

3.Porridge and soup finished , enter “off” mode.

Caution : Press cooking time key “hour” and “minute” to adjust time(30 minutes —4 hours)

example: cook four hours porridge

1.Pour the cleaned rice into inner pot

2. Add water to corresponding level.

3.Press menu key to choose porridge function

4) Press cooking timer key , the cooking time is “1:00”  
press hour key thrice , the cooking time is “4:00” .

| Function    | porridge | soup   |
|-------------|----------|--------|
| Tacitly set | 1: 00    | 1: 00  |
| Tacitly set | 1 hour   | 1 hour |

5) Press start key , start indicator lights up, and enter porridge process. Press cooking timer key during porridge, the screen displays surplus working time. When release it, the screen displays the present time.

6) After porridge finished , stir it up with the spatula adequately.

Note: porridge/soup finished, keep warm indicator flashes indicating no “keep warm” function here . Please eat as soon as possible to lest porridge pastes.



★ Cake

| Material<br>Weight<br>Serial | Flour | Egg | Water | Sugar | Oil        |
|------------------------------|-------|-----|-------|-------|------------|
| 1                            | 250 g | 2   | 100 g | 50 g  | About 5 g  |
| 2                            | 500 g | 4   | 200 g | 100 g | About 10 g |

**Remark :**

1. The flour can't exceed 500 g.
2. Sugar not too much , otherwise the cake bottom will be black.

**Operation:**

1. Beat the eggs into container and add the sugar into the egg to mix.
2. Add water and flour to the container. Mix well the material of cake.
3. The inner pot bottom is smeared oil, and then put the mixed material into the inner pot .
4. Connect to power source, press “menu” key to choose cake function.
5. Press start key , start indicator lights up. Enter the cake process and the screen displays the present time.
6. After finished ,enter keeping warm process.

★ Steaming

1. Put 3 cups of water into the pan.  
The amount of water varies according to the food amount.
2. Install the steaming tray into the pan and place food on the tray.
3. Install the pan into the cooker.
4. Connect to power source, press “menu” key to choose steam function.
5. Press start key , start indicator lights up. Enter steam process.
6. After finished ,enter keeping warm process.

★ Brown Rice

1. Preparation ready.
2. Connect to power source , press menu key to choose "Brown" function.
3. Press start key ,indicator lights up ,enter brown rice process.
4. When buzzer sound, put vegetable into inner pot and close upper lid.
5. After finished ,enter the process of “ keep warm” . “ keep warm” indicator lights up at the same time.

Note: This function is suitable for small or medium amount of rice .

Please check the following chart for reference.

| Model      | Amount of rice                            |
|------------|-------------------------------------------|
| RHRC-13001 | the amount of rice below 3 Measuring cups |
| RHRC-13002 | the amount of rice below 5 Measuring cups |

### ✦ Cold rice heating up

- 1.Place cold rice in inner pot, and stir it up;
- 2.Connect to power source, press menu key to choose reheat function.
- 3.After pressing start key, start indicator lights up automatically and enter the process of reheat function.
- 4.After finished ,enter the process of keeping warm.

#### Note:

- 1).Before heating up, add some water onto the rice, to make the rice less dry.
- 2).Make sure the rice is loosened up. If lumpy, it may cause rice burned or agglomerated.
- 3).After heating finished, loosen up the rice again to make it less likely to harden.
- 4).If repeatedly use cold rice reheating, it may lead to rice burned or stuck together.

If too much rice, heating may not be thoroughly. Please check the following chart for reference

| Model      | Amount of rice                         |
|------------|----------------------------------------|
| RHRC-13001 | the amount of rice below 3 water level |
| RHRC-13002 | the amount of rice below 5 water level |

### ✦ Keep warm

- 1.Preparation ready
- 2.Connect to power source, press “keep warm” key once, “keep warm” indicator lights up and enter the process of warm
- 3.The time of keep- warming displays by sequence hours  
0 → 1 → 2 → 3 → — — — → 24hours.

#### Note:

The cooker can keep warm for 24 hours, but longer time will make the effect a bit bad.

About inner pot

- 1.To avoid damaging inner coating, using attached scoop rather than other accessory .
- 2.Don't clean with vinegar lest corrosion.
- 3.When long time using, some coating may fall off. And it' s no harm for your health and safe use.

## Timing

▲ Only Brown function can not choose “pre-set” key.

▲ For example : to finish cooking at 11:30.

- 1.Preparation is done.
  - 2.Connect to power source, press menu key to choose quick function.
  - 3.Press “pre-set” key, the screen displays ending time.
  - 4.Set time to 11:30 by pressing “hour” and “minute” key . Press hour key once the screen displays one hour. So does the minute.
  5. Press “start” key, “pre-set” indicator lights up and “start” light flashes. The screen displays the present time . After entering the work process, “pre-set” indicator lights off, and “start” indicator lights up.
- Press “pre-set” key during setting time process , the screen displays ending time. If release it , the screen will display the present time .

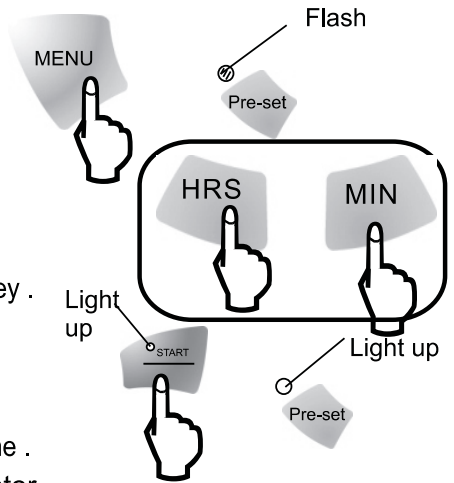

## Dealing with power cut

| Power off | Power off in 2 hours                                          | More than 2 hours                           |
|-----------|---------------------------------------------------------------|---------------------------------------------|
| Pre-set   | Press timing key to continue                                  | Back to waiting mode.<br><br>Need to reset. |
|           | The cooker continue working and timing function is effective. |                                             |
| Cooking   | Continue cooking                                              |                                             |
| Warm      | Continue keeping warm                                         |                                             |

- ✦ Long time power off will affect cooking effect
- ✦ When battery is out of power ,it needs to reset the time after power recovery.

# Warning

1. Do not share with other electric appliance with one socket at one time.
2. Do not put the cooker in damp or unsteady place.  
Keep away from fire or heat source.
3. Do not heat inner pot on open flame.
4. Put cooker out of the reach of children otherwise may cause hazard by wrong operation.
5. Keep face and hand away from hot steam outlet on upper lid.
6. Do not immerse cooker in water or other liquid for safety consideration.
7. Do not cover steam outlet with cloth lest upper lid deformation or color change.
8. Electric cord should not be subjected to twisting and knitting. When plug off , take hold of plug instead of cord.  
If the supply cord is damaged , please replace it with specialized cord rather than other cord.
9. Do not cook acid alkaline food or alike substance lest corrode inner pot.
10. Clean with damp sponge or soft scouring pad with mild detergent.  
※ Long time use will make non-stick coating fall off a little but no harm for cooking and safety.
11. Turn off when not in use.
12. Whenever "5E" shown on the screen, press "off" button to be in waiting mode and then reset again.
13. This appliance is not intended for use by persons (including children) with reduced physical, sensory or mental capabilities, or lack of experience and knowledge, unless they have been given supervision or instruction concerning use of the appliance by a person responsible for their safety.
14. Children should be supervised to ensure that they do not play with the appliance.
15. This appliance is intended to be used in household and similar applications such as:
  - staff kitchen areas in shops, offices and other working environments;
  - farm houses;
  - by clients in hotels, motels and other residential type environments;
  - bed and breakfast type environments

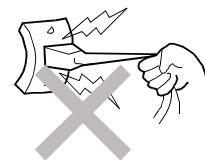
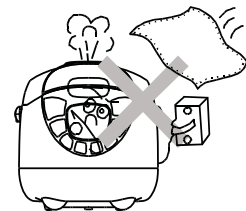
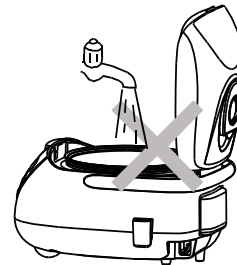
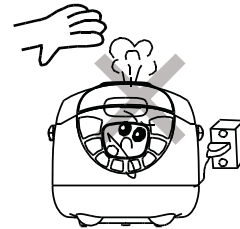
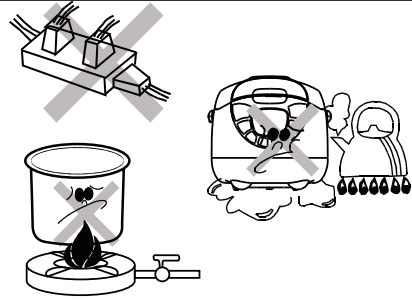

## Steam valve

### Clean steam valve

1. Remove the steam valve from outer lid
2. Turn the slip buckle of the steam valve by the arrow "open" so that the slip buckle turns on the buckle, then open upwards the steam valve.  
The above lid is on the top when opening the steam valve.
3. Remove the steam seal from groove and clean it.  
Don't twist and pull.

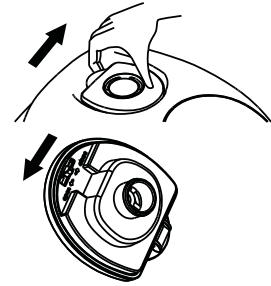

### Mount steam valve

1. Put the steam seal into groove and make it get to suitable. Put the groove downward on the place. It is embedded in the steam lid.
2. The steam lid is installed on the base bracket.  
Turn the slip bucket by the arrow "close" so that the slip buckle turns off the buckle.  
The steam lid is buckled until click sound
- 3 correctly insert valve into valve hole on the upper lid.

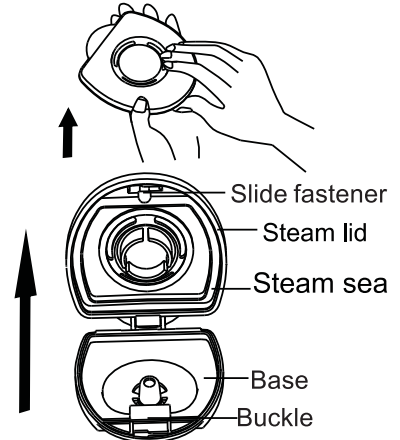

## cleaning methods

### 1. lower aluminum lid

- 1). Take apart: press the buckle with "1" arrow place, take down the lid toward "2" arrow direction and clean it.
- 2) Mount : Insert the "1" arrow direction of buckle into hole on the button lid and press the "2" arrow direction of buckle.

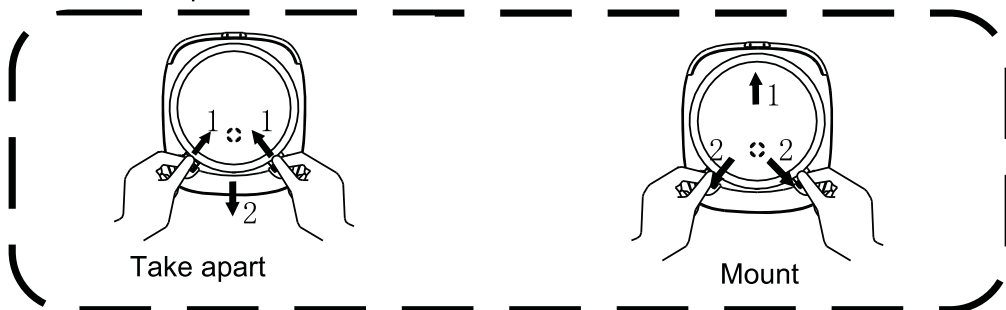

### 2、 inner pot, steamer

Take out inner pot, wash it with clean water and detergent, then dry it with soft cloth.

\*Never wash with metal brush or abrasive scouring pad as it may damage Interior coating.

\*Grains of rice and other foreign matters may cling to heat plate, wipe them off with sand paper and clean with cloth.

## Keep warm cautions

- 1.Connect source power , press “keep warm” key, the “keep warm” indicator light up, enter into the process of warm.
- 2.To prevent rice become lump, loosen up the rice.
- 3.Keep warm never exceed 24 hours. Never keep warm the cold rice longer time.
- 4.Plug off the power plug after use.

## Clean and maintenance

Unplug from cooker outlet and power socket before cleaning.

Must clean the cooker with the home washing detergent when finished cooking .  
If not ,it can emanate peculiar smell.

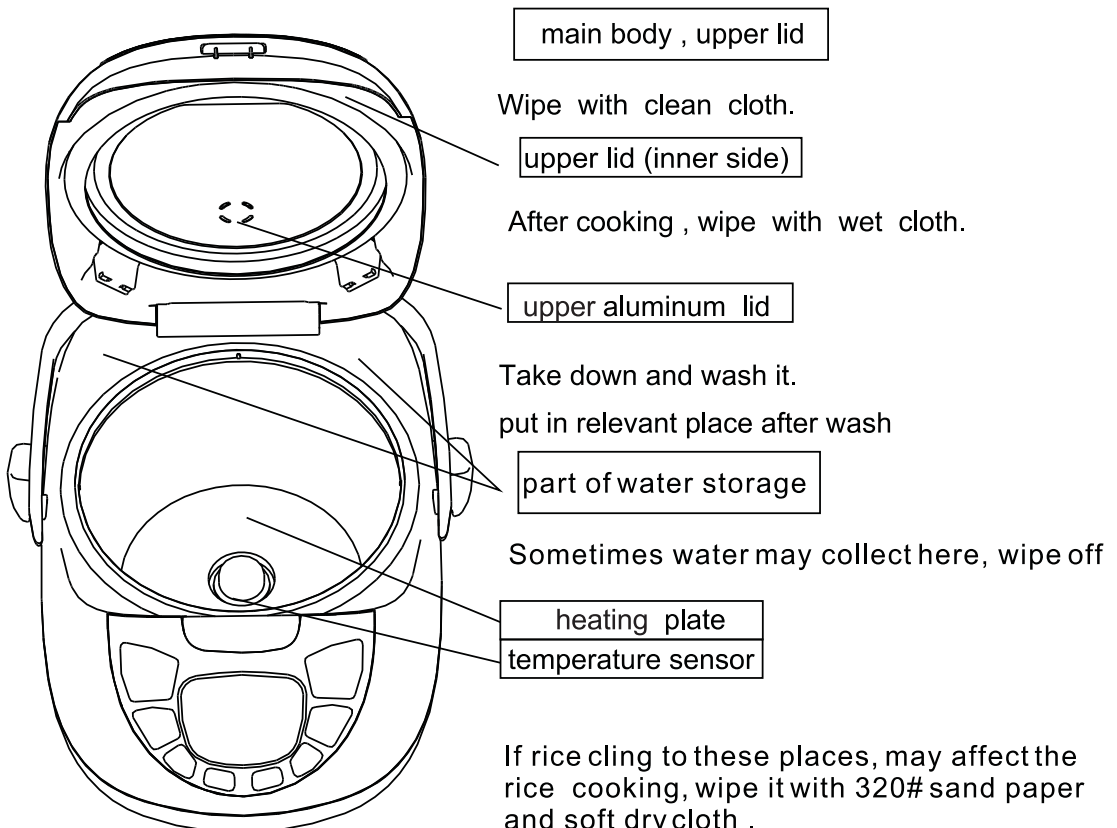

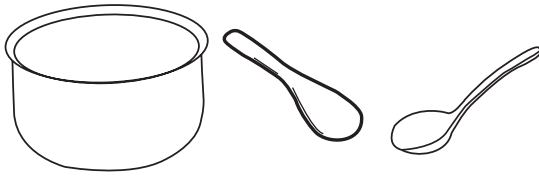

Inner pot ,spatula, spoon

Use home washing detergent and clean water to clean up and wipe dry with dry soft cloth.

## Malfunction and solution

| Malfunction                                                              |                       | Cause                                                                                                                                                                                                                                                             | Solution                                                                                                                                                                                                                                                                                                                                        |
|--------------------------------------------------------------------------|-----------------------|-------------------------------------------------------------------------------------------------------------------------------------------------------------------------------------------------------------------------------------------------------------------|-------------------------------------------------------------------------------------------------------------------------------------------------------------------------------------------------------------------------------------------------------------------------------------------------------------------------------------------------|
| Indicator failure                                                        | Plate dosen't heat up | 1.circuit power disconnect<br>2. circuit board failure<br>3.circuit board conductor broke<br>4.main circuit board failure                                                                                                                                         | 1. check switch, socket, fuse, power conductor no failure, plug in place.<br>2 .send to designated service center                                                                                                                                                                                                                               |
|                                                                          | Plate heat up         | main circuit board failure                                                                                                                                                                                                                                        | send to designated service center                                                                                                                                                                                                                                                                                                               |
| Indicator work                                                           | Plate dosen't heat up | 1.main temperature control failure<br>2.heating plate components bumed up.<br>3.circuit conductor partly broken.<br>4.circuit board failure.                                                                                                                      | send to designated service center                                                                                                                                                                                                                                                                                                               |
| Rice not done well or cooking time too long                              |                       | 1. keeping warm time is not long enough<br>2.heating plate deformation<br>3.inner pot tittle to one side.<br>4.foreign matter between heat plate and inner pot.<br>5.inner pot deformation<br>6.main circuit board failure<br>7.main temperature control abnormal | 1.keep warm according to requirement.<br>2.clean with sand paper serious. deformation send to after service center.<br>3.turn inner pot to make it normal.<br>4.wipe clean with 320# sand paper.<br>5.send to designated service center to exchange inner pot.<br>6.Send to designated service center.<br>7. Send to designated service center. |
| Rice burned or can not keep warm automatically                           |                       | 1.main temperature control abnormal.<br>2.main circuit board failure.                                                                                                                                                                                             | Send to designated service center.                                                                                                                                                                                                                                                                                                              |
| Porridge spilled profusely                                               |                       | 1.main circuit board failure<br>2.upper lid temperature control abnormal<br>3.steam valve has foreign matter.<br>4.water exceed the Max scale or don't add water according to scale.<br>5.never close upper lid.<br>6.choosing function is error.                 | 1. send to designated service center.<br>2.clean steam valve<br>3.add water according to scale<br>4.close upper lid<br>5.ensure that choosing function is correct.                                                                                                                                                                              |
| Rice and porridge cooking do not arrive at boiling point for a long time |                       | 1. main circuit board failure.<br>2. upper lid temperature control abnormal                                                                                                                                                                                       | send to designated service center.                                                                                                                                                                                                                                                                                                              |

\* Don't repair cooker by yourself.  
If any problem,please send it to service center

# Circuit diagram

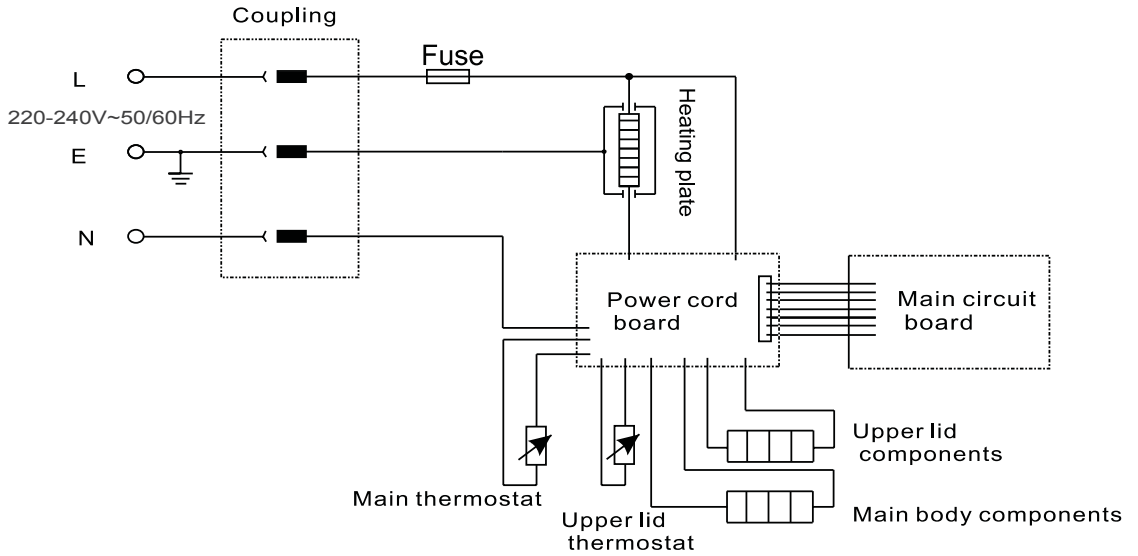



## Free Manuals Download Website

<http://myh66.com>

<http://usermanuals.us>

<http://www.somanuals.com>

<http://www.4manuals.cc>

<http://www.manual-lib.com>

<http://www.404manual.com>

<http://www.luxmanual.com>

<http://aubethermostatmanual.com>

Golf course search by state

<http://golfingnear.com>

Email search by domain

<http://emailbydomain.com>

Auto manuals search

<http://auto.somanuals.com>

TV manuals search

<http://tv.somanuals.com>