



**USB 2.0 DVI KVM Switch**  
**RKV-2DVI**  
User Manual

## Overview

The RKV-2DVI takes a giant step forward from prior cable KVM models in the Petite series, by offering DVI functionality, USB 2.0 peripheral sharing (via a USB hub attached to the USB mouse port), a rich bass experience for 2.1 surround systems.

Another new feature of the RKV-2DVI is the implementation of a remote port selector. This means that you can now control port switching from the desktop while the switch itself can be placed in a convenient, out-of-the-way, location. Also, in addition to new hotkeys, the RKV-2DVI offers the latest mouse port-switching function – simply double-click on the scroll wheel of a USB mouse to change ports.

Furthermore, the RKV-2DVI features enhanced Video DynaSync technology, which eliminates boot-up display problems and optimizes resolution when switching between ports.

Finally, the RKV-2DVI's new Power on detection feature means that if one of the computers is powered off, switch will automatically switch to the other powered-on computer.

Featuring an unbeatable combination of DVI functionality, USB 2.0 peripheral sharing convenience, and enhanced user-friendly operations, the RKV-2DVI allows users to keep up with the latest innovations in desktop multimedia applications.

## Features

- ◆ One DVI video console controls two USB computers
- ◆ Fully DVI-Digital specification compliant
- ◆ Computer selection via remote port selector, hotkeys, and USB mouse
- ◆ Audio-enabled – full bass response provides a rich experience for 2.1 channel surround sound systems
- ◆ Multiplatform support – Windows 2000 / XP / Vista / 7, Mac, Sun, Linux
- ◆ Compact design, built-in all-in-one cables (2 x 0.9 m)
- ◆ Superior video quality – up to 1920 x 1200
- ◆ Compatible with widescreen LCD monitors
- ◆ Video DynaSync –Which eliminates boot-up display problems and optimizes resolution when switching between ports
- ◆ Power on detection – if either of the computers is powered off, the RKV-2DVI will automatically switch to the other computer
- ◆ Supports multimedia keyboards
- ◆ Supports wireless keyboards and mice
- ◆ Console mouse port emulation/bypass feature supports most mouse drivers and multifunction mice
- ◆ Mac/Sun keyboard support and emulation\*

- ◆ USB 2.0 mouse port can be used for USB hub and USB peripheral sharing
- ◆ HDCP Compatible
- ◆ Non-Powered

**Note:**

1. PC keyboard combinations emulate Mac/Sun keyboards.
2. Mac/Sun keyboards work only with their own computers.

## System Requirements

**Console**

- ◆ A DVI monitor capable of the highest resolution that you will be using on any computer in the installation
- ◆ A USB Keyboard and a USB Mouse
- ◆ Speakers and microphone (optional)

**Computers**

The following equipment must be installed on each computer that is to be connected to the system:

- ◆ A DVI video port
- ◆ USB Type A port
- ◆ Speaker and microphone ports (optional)

**Cables**

The RKV-2DVI's innovative design features built-in KVM and audio cables for extra convenience. No further cables are necessary.

## Package Contents

The RKV-2DVI USB 2.0 DVI KVM Switch package contains the following items:

- ◆ 1 RKV-2DVI 2-Port USB 2.0 DVI KVM Switch
- ◆ 1 Remote Port Selector
- ◆ 1 User Manual\*

## Operating Systems

Supported operating systems are shown in the table, below:

OS		Version
Windows		2000 / XP / Vista / 7
Linux	RedHat	6.0 and higher
	SuSE	8.2 and higher
	Mandriva (Mandrake)	9.0 and higher
UNIX	AIX	4.3 and higher
	FreeBSD	3.51 and higher
	Sun	Solaris 9 and higher
Novell	Netware	5.0 and higher
Mac		OS 9 and higher
DOS		6.2 and higher

## Components

RKV-2DVI

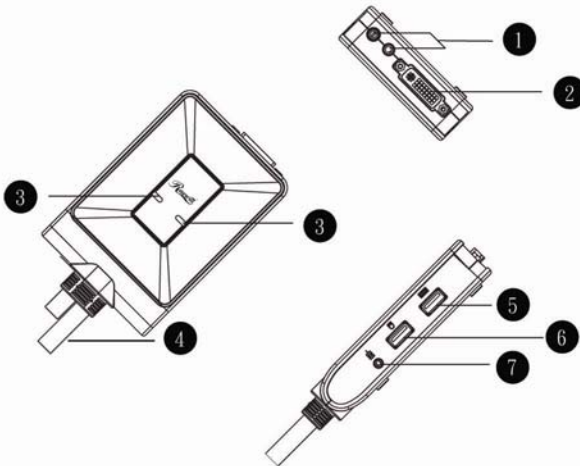

Remote Port Selector

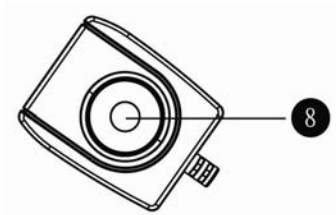

No.	Component	Description
1	Console Audio Ports	Your console speakers and microphone plug in here.
2	Console Monitor Port	Your console DVI monitor plugs in here.
3	Port LEDs	The Port LEDs indicate status. The LED lights <b>on</b> to indicate that the computer attached to the corresponding port is selected and has the KVM focus. The LED <b>flashes</b> to indicate that the computer attached to its corresponding port is being scanned by the Auto Scan function. The LED is <b>off</b> to indicate the port is not selected.
4	KVM Cable	The connectors on the built-in KVM cables attach to the two computers in your RKV-2DVI installation.
5	Console Keyboard Port	Your console USB keyboard plugs in here.
6	Console Mouse Port	Your console USB mouse plugs in here.
7	Remote Port Selector Jack	The Remote Port Selector plugs in here.
8	Port Selection Pushbutton	Press the Port Selection Pushbutton to toggle the KVM and Audio focus between the two computers.

## Installation



1. Make sure that the power to any device that you connect to the installation has been turned off. You must unplug the power cords of any computers that have the *Keyboard Power On* function.
2. Make sure that all devices you will be installing are properly grounded.

1. Plug your keyboard and mouse into their USB ports, located on the side of the RKV-2DVI. The ports are color coded and labeled with an appropriate icon.  
  
**Note:** The mouse connector is actually a USB 2.0 port, and can accept any USB compatible peripheral. You can even connect a hub to install multiple USB devices (This may require an extra power adapter).
2. Plug your monitor into the DVI port, located on the front of the RKV-2DVI. Power on the monitor.
3. Plug your speakers and microphone into the console audio ports, located on the front of the RKV-2DVI (Optional).
4. Plug the USB, video, and audio connectors of the KVM cables into their respective ports on the computers you are installing.
5. If you choose to use the remote port selector, plug its cable into the remote port selector jack, located on the side of the unit.
6. Power on the computers.

**Note:** By default the switch links to the first computer that is powered on.

### Installation Diagram

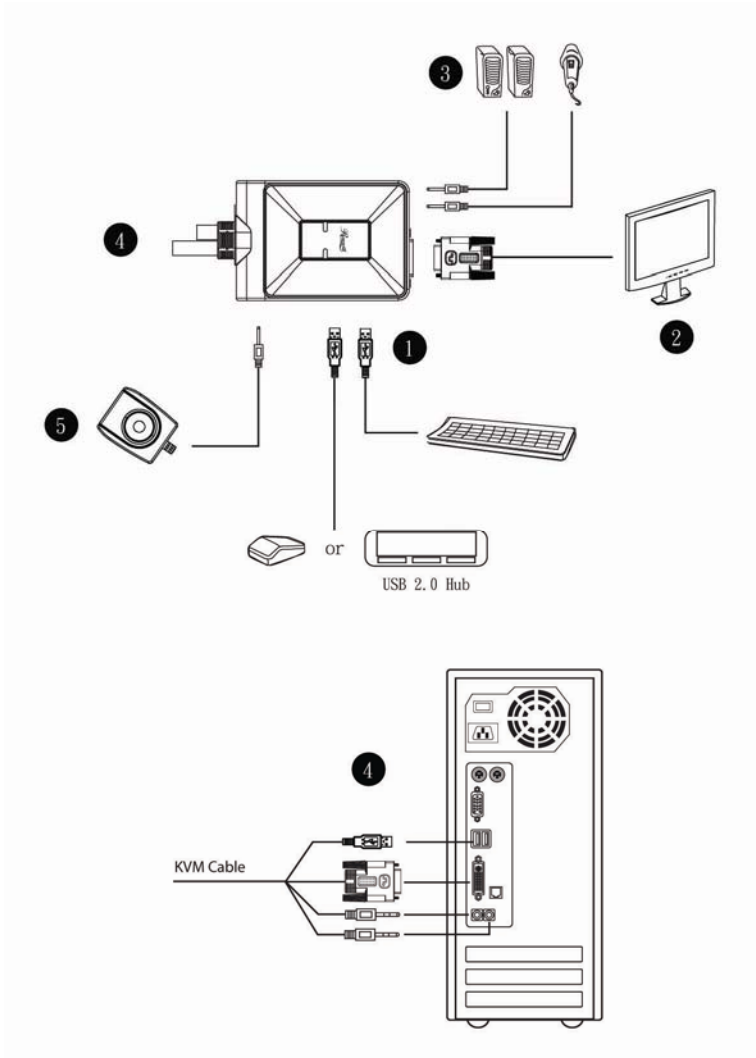

## Operation

The RKV-2DVI provides three convenient methods of selecting computers: Manual – click the pushbutton on the Remote Port Selector; Mouse – click the mouse’s scroll wheel; and Hotkey – enter combinations from the keyboard.

### Manual Port Selection

Press the port selection pushbutton on the Remote Port Selector to toggle the KVM and Audio focus between the two computers. The Port LED lights to indicate that the computer attached to its corresponding port has the focus.

**Note:** Do not switch ports while a USB device is in operation. For independent USB switching, please see the USB KVMP switches on our website.

### Mouse Port Selection

Simply double-click the scroll wheel on your USB mouse to switch between ports. The mouse port-switching function allows you to toggle back and forth between the ports.

- Note:**
1. This feature is only supported by USB 3-key scroll wheel mice.
  2. The default setting is OFF.
  3. This feature is only supported when mouse emulation is also enabled.
- See *Hotkey Summary Table*, page 8 for further details.

## Hotkey Port Selection

All hotkey operations begin by tapping the **Scroll Lock** key twice. See the *Hotkey Summary Table* for full details.

**Note:** If using [Scroll Lock] conflicts with other programs, [Ctrl] can be used instead.

### Alternate Entering Hotkey Mode

- ◆ Press [Scroll Lock] [Scroll Lock] [x] [Enter]. The entering hotkey mode hotkey is now [Ctrl].
- or
- ◆ Press and hold the remote port selector switch for three seconds. The entering hotkey mode hotkey is now [Ctrl].

**Note:** These procedures toggle between the two methods.





















## Hotkey Summary Table

Combination		Function
[Scroll Lock] [Scroll Lock] +	[Enter]	Toggles the KVM and Audio focus between the two ports. <b>Note:</b> If the KVM and Audio focus are on different ports, only the KVM focus switches.
	[k] [Enter]	Only toggles the KVM focus.
	[s] [Enter]	Only toggles the Audio focus.
	[a] [Enter] [n]	Starts Auto Scan. The KVM focus cycles from port to port at <b>n</b> second intervals. <b>Note:</b> Replace <b>n</b> with a number between 1 and 4 (see <i>Scan Interval Table</i> below). To exit Auto Scan, press [Esc] or [Spacebar]. Auto Scanning stops when you exit Auto Scan mode.
	[x] [Enter]	Toggles the hotkey invocation key between [Scroll Lock] and [Ctrl].
	[m] [Enter]	Enables/disables mouse emulation function.
	[w] [Enter]	Enables/disables mouse port-switching function.
	[F2] [Enter]	Activates Mac keyboard mapping.
	[F3] [Enter]	Activates Sun keyboard mapping.
	[F10] [Enter]	Auto detects keyboard operating platform.
	[F4] [Enter]	Lists current switch settings.
	[F5] [Enter]	Performs a USB keyboard and mouse reset.
	[d] [Enter]	Invokes the Video DynaSync function, which eliminates boot-up display problems and optimizes resolution when switching between ports.
	[r] [Enter]	Resets hotkeys to the default setting.

## Scan Interval Table

n	Secs.
1	3 secs.
2	5 secs. (default)
3	10 secs.
4	20 secs.

## Keyboard Emulation

PC Keyboard	Mac Keyboard	PC Keyboard	Sun Keyboard
[Shift]	Shift	[Ctrl] [T]	Stop
[Ctrl]	Ctrl	[Ctrl] [F2]	Again
		[Ctrl] [F3]	Props
[Ctrl] [1]		[Ctrl] [F4]	Undo
[Ctrl] [2]		[Ctrl] [F5]	Front
[Ctrl] [3]		[Ctrl] [F6]	Copy
[Ctrl] [4]		[Ctrl] [F7]	Open
[Alt]	Alt	[Ctrl] [F8]	Paste
[Print Screen]	F13	[Ctrl] [F9]	Find
[Scroll Lock]	F14	[Ctrl] [F10]	Cut
	=	[Ctrl] [1]	 
[Enter]	Return	[Ctrl] [2]	 - 
[Backspace]	Delete	[Ctrl] [3]	 + 
[Insert]	Help	[Ctrl] [4]	
[Ctrl] 	F15	[Ctrl] [H]	Help
			Compose
			

**Note:** When using key combinations, press and release the first key (Ctrl), then press and release the activation key.

## Troubleshooting

Symptom	Possible Cause	Action
Monitor does not display after the KVM cable set is hot-plugged.	DVI graphics card is not compatible with cable set hot-plugging.	Power off all devices on the installation; power off the RKV-2DVI; confirm all KVM cables are properly connected; power on the RKV-2DVI; power on the computers.
	Graphics card driver is not up-to-date.	Upgrade to the latest graphics card driver.
Mouse and/or keyboard is not responding.	Switch needs to be reset.	Power off all devices on the installation; power off the RKV-2DVI; wait five seconds; power on the RKV-2DVI again.
Mouse port-switching function is not responding.	Mouse does not support this function.	This feature is only supported by USB 3-key scroll wheel mice.
	Mouse emulation is disabled.	Enable mouse emulation. See <i>Hotkey Summary Table</i> , page 8, for details.
Cannot switch ports by pressing [Scroll Lock] twice.	Keyboard is incompatible with [Scroll Lock] invocation.	Switch to the alternate HSM invocation keys. See <i>Alternate Entering Hotkey Mode</i> , page 7, for details.

## Factory Default Hotkey Settings

Setting	Default
Port Switching	[Scroll Lock] [Scroll Lock]
Auto Scan Interval	5 seconds
Keyboard Operating Platform	PC Compatible
Mouse Emulation	On
Mouse Port-Switching	Off

## Specifications

Function		RKV-2DVI	
Computer Connections		2	
Console Connections		1	
Port Selection		Remote Port Selector, Mouse, Hotkeys	
Connectors	Console Ports	KB	1 x USB Type A Female (Silver)
		Video	1 x DVI-D Female (White)
		Mouse	1 x USB Type A Female (Silver)
		Speakers	1 x Mini Stereo Jack Female (Green)
		Mic.	1 x Mini Stereo Jack Female (Pink)
	KVM Ports	KB	2 x USB Type A Male (Purple)
		Video	2 x DVI-D Male (Black)
		Mouse	2 x USB Type A Male (Black)
		Speakers	2 x Mini Stereo Jack Female (Green)
		Mic.	2 x Mini Stereo Jack Female (Pink)
Remote Port Selector		1 x Mini Stereo Jack	
LEDs	KVM	2 (Green)	
	Remote Port Selector	2 (Green)	
Cable Length	KVM	2 x 0.9 m	
	Remote Port Selector	1.8 m	
Emulation	KB / Mouse	USB	
Video		1920 x 1200	
Scan Interval		3, 5, 10, 20 secs. (default 5 secs.)	
Power Consumption		5V, 3.05W	
Environment	Operating Temp.	0–50°C	
	Storage Temp.	-20–60°C	
	Humidity	0–80% RH, Non-condensing	
Physical Properties	Housing	Plastic	
	Weight	0.50 kg	
	Dimensions (L x W x H)	11.10 x 7.80 x 2.50 cm	

Thank you for purchasing a quality Rosewill Product.

Please register your product at : [www.rosewill.com](http://www.rosewill.com) for complete warranty information and future support for your product.

## Free Manuals Download Website

<http://myh66.com>

<http://usermanuals.us>

<http://www.somanuals.com>

<http://www.4manuals.cc>

<http://www.manual-lib.com>

<http://www.404manual.com>

<http://www.luxmanual.com>

<http://aubethermostatmanual.com>

Golf course search by state

<http://golfingnear.com>

Email search by domain

<http://emailbydomain.com>

Auto manuals search

<http://auto.somanuals.com>

TV manuals search

<http://tv.somanuals.com>