



















## Tools Required

- Phillips Head Screwdriver
- Ratchet or Driver with 1/2" (13 mm) Socket
- Portable or Electric Drill
- 1/4" (6 mm) Drill Bit and Stud Finder for Drywall Installation
- 7/16" (11 mm) Masonry Bit for Concrete Installation

## Warnings

1. Make sure these instructions are read and completely understood before attempting installation. If you are unsure of any part of this installation, contact a professional installer for assistance.
2. The wall or mounting surface must be capable of supporting the combined weight of the mount and the display; otherwise the structure must be reinforced.
3. Safety gear and proper tools must be used. A minimum of two people are required for this installation. Failure to use safety gear and/or attempting this installation alone can result in property damage, serious injury, or death.
4. Follow all instructions and recommendations regarding adequate ventilation and suitable locations for mounting your display. Consult the owner's manual for your display for more information.

## Hardware Kit

Bag #	(Ref) Item (Qty)		
<b>1</b>	 (A) M4x12 Bolt (x4)	 (B) M4x30 Bolt (x4)	 (C) M4 Lock Washer (x4)
<b>2</b>	 (D) M5x12 Bolt (x4)	 (E) M5x30 Bolt (x4)	 (F) M5 Lock Washer (x4)
<b>3</b>	 (G) M6x12 Bolt (x4)	 (H) M6x35 Bolt (x4)	 (I) M6 Lock Washer (x4)
<b>4</b>	 (J) M8x16 Bolt (x4)	 (K) M8x40 Bolt (x4)	 (L) M8 Lock Washer (x4)
<b>5</b>	 (M) Small Spacer (x4)	 (N) Large Spacer (x4)	 (O) M6 Washer (x4)
<b>6</b>	 (P) Concrete Anchor (x6)	 (Q) M8x63 Lag Bolt (x6)	 (R) Lag Bolt Washer (x6)

## Part 1a – Mounting the Wall Plate (Drywall)

Important! For safety, this mount must be secured to two adjacent wood studs at least 16" apart.

1. Using a stud finder, locate and mark two adjacent studs for securing the mount.
2. Place the wall plate against the wall and level it using the bubble guide.
3. Mark four locations (two per stud) on the wall where the mount will be secured. Be sure to use the center of each stud.
4. Remove the wall plate and drill a 1/4" (6 mm) pilot hole at each location using an electric drill.
5. With the help of another person, replace the wall plate and fix it to the wall using the Lag Bolts (Q) and Lag Bolt Washers (R) provided (Fig. 1).
6. Do not over-tighten the bolts and do not release the wall plate until all screws are secure.
7. Attach the cable manager to the middle of the top crossbar (Fig. 2).

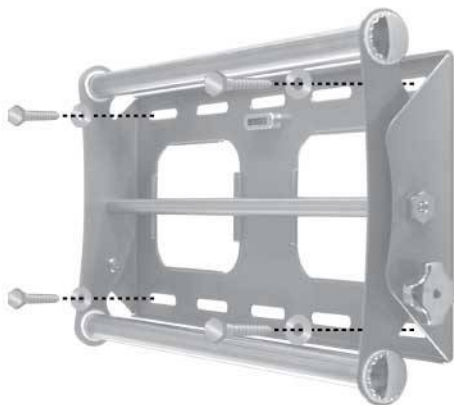

Fig. 1 - Attach the wall plate to the wall.

## Part 1b – Mounting the Wall Plate (Concrete)

1. Place the wall plate against the wall and level it using the bubble guide.
2. With the help of another person, mark off six (6) locations for fixing the mount to the wall.
3. Place the wall plate aside and drill a hole at each location using a 7/16" (11 mm) masonry bit. Remove any excess dust from the holes.
4. Insert one Concrete Anchor (P) into each hole. A hammer can be used to lightly tap the anchors into place if necessary.
5. With the help of another person, replace the wall plate and fix it to the wall using the Lag Bolts (Q) and Lag Bolt Washers (R) provided (Fig. 1).
6. Do not over-tighten the screws and do not release the wall plate until all screws are secure.
7. Attach the cable manager to the middle of the top crossbar (Fig. 2).



Fig. 2 - Attach the cable manager to the top crossbar.

## Part 2 – Attaching the Arms to the Display

Important! Use extra care during this part of the installation. Avoid laying your display face down if possible as it may damage the viewing surface.

1. Examine the back of your television. If the back of your display is flat, you will be using one of the shorter bolts from the hardware kit. If the back of your display is curved or recessed, you will be using one of the longer bolts and a spacer (Fig. 4).
2. Determine the correct diameter bolt to use by trying one bolt each from Bags 1 - 4 of the hardware kit. Do not force any of the bolts – if you feel resistance stop immediately to avoid damaging your display.
3. Attach the arms to the back of your display using the bolts identified in Steps 1 and 2 and the corresponding Lock Washer (C, F, I, or L) (Fig. 4). You will need to use the M6 Washers (O) if you are using the M4, M5, or M6 bolts. If your display has a curved or recessed back, you may also need to use a Spacer (M or N).
4. Make sure the screws are snug, but do not over-tighten.

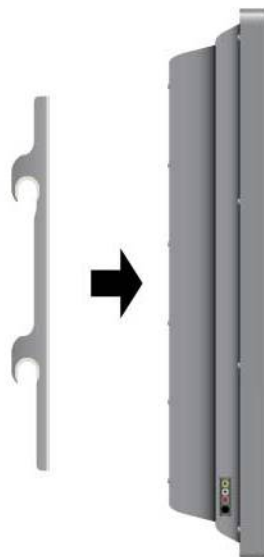

Fig. 3 - Attach the arms to the back of your display.

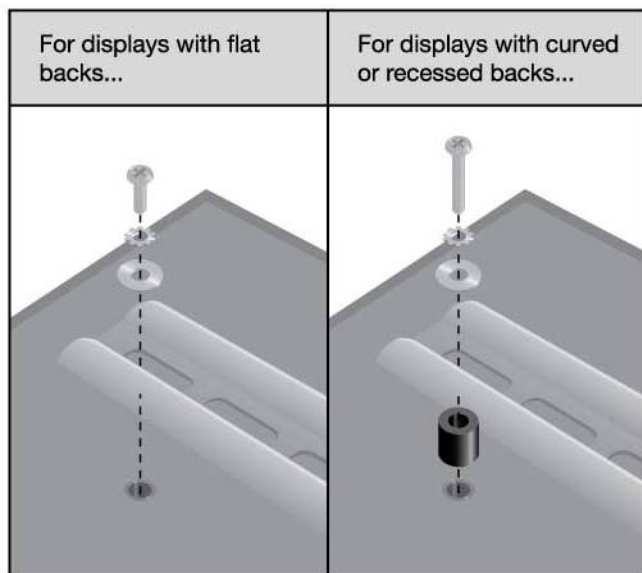

Fig. 4 - Use a longer bolt and spacer for displays with curved or recessed backs. Do not use the M6 Washer (O) if you are using the M8 Bolts (J or K).

## Part 3 – Final Installation and Adjustment

1. With the help of another person, carefully lift your display and place it on the wall plate (Fig. 5). Do not release the display until the mounting arms have securely hooked onto the crossbars!
2. Move the safety tab located on each arm into position to avoid having the display accidentally lifted from the mount. A padlock can be inserted into one of the tabs to help prevent theft of your display (Fig. 6).
3. The cable manager can be used to keep your power cord and other A/V cables in order.
4. To adjust the tilt position, have one person hold the display in position while another person loosens the two tilt adjustment knobs located on either side of the wall plate (Fig. 7). Once the knobs are loose, move the display to the desired angle. Re-tighten the knobs before releasing the angle.

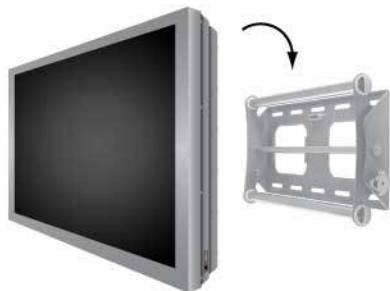

Fig. 5 - Carefully hook the display onto the wall plate.



Fig. 6 - A small padlock can be used to help prevent theft of your display.

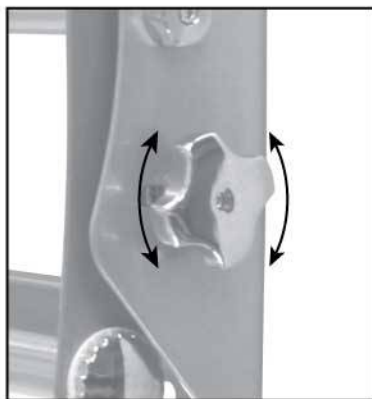

Fig. 7 - Loosen the adjustment knobs to change the tilt angle. There is one knob on each side of the mount.

Thank you for purchasing a quality Rosewill Product. Please register your product at : [www.rosewill.com](http://www.rosewill.com) for complete warranty information and future support for your product.

## Free Manuals Download Website

<http://myh66.com>

<http://usermanuals.us>

<http://www.somanuals.com>

<http://www.4manuals.cc>

<http://www.manual-lib.com>

<http://www.404manual.com>

<http://www.luxmanual.com>

<http://aubethermostatmanual.com>

Golf course search by state

<http://golfingnear.com>

Email search by domain

<http://emailbydomain.com>

Auto manuals search

<http://auto.somanuals.com>

TV manuals search

<http://tv.somanuals.com>