



ROTEL

Owner's Manual

RSP-1098 Surround Sound Processor



	CAUTION RISK OF ELECTRIC SHOCK DO NOT OPEN	
CAUTION: TO REDUCE THE RISK OF ELECTRIC SHOCK, DO NOT REMOVE COVER. NO USER-SERVICEABLE PARTS INSIDE. REFER SERVICING TO QUALIFIED SERVICE PERSONNEL.		

	This symbol is to alert the user to the presence of uninsulated dangerous voltages inside the product's enclosure that may constitute a risk of electric shock.
	This symbol is to alert the user to important operating and maintenance (service) instructions in this manual and literature accompanying the product.

APPLICABLE FOR USA, CANADA OR WHERE APPROVED FOR THE USAGE
CAUTION: TO PREVENT ELECTRIC SHOCK, MATCH WIDE BLADE OF PLUG TO WIDE SLOT. INSERT FULLY.
ATTENTION: POUR EVITER LES CHOCS ELECTRIQUES, INTRODUIRE LA LAME LA PLUS LARGE DE LA FICHE DANS LA BORNE CORRESPONDANTE DE LA PRISE ET POUSSER JUSQU'AU FOND.

This Class B digital apparatus complies with Canadian ICES-003.
Cet appareil numérique de la classe B est conforme à la norme NMB-003 du Canada.

CE



Notice

The **COMPUTER I/O connection** should be handled by authorized person only.

FCC Information

This equipment has been tested and found to comply with the limits for a Class B digital device, pursuant to Part 15 of the FCC Rules. These limits are designed to provide reasonable protection against harmful interference in a residential installation. This equipment generates, uses and can radiate radio frequency energy and, if not installed and used in accordance with the instruction, may cause harmful interference to radio communications.

However, there is no guarantee that interference will not occur in a particular installation. If this equipment does cause harmful interference to radio or television reception, which can be determined by turning the equipment off and on, the user is encouraged to try to correct the interference by one or more of the following measures:

- Reorient or relocate the receiving antenna.(TV, radio, etc.)
- Increase the separation between the equipment and receiver
- Connect the equipment to an outlet on circuit different from that to which the receiver is connected.
- Consult the dealer or an experienced radio/TV technician for additional help.

Caution

This device complies with part 15 of the FCC Rules operation is subject to the following to conditions: (1) This device may not cause harmful interference, and (2) this device must accept any interference received, including interference that may cause undesired operation.

Important Safety Instructions

WARNING: There are no user serviceable parts inside. Refer all servicing to qualified service personnel.

WARNING: To reduce the risk of fire or electric shock, do not expose the unit to moisture or water. Do not allow foreign objects to get into the enclosure. If the unit is exposed to moisture, or a foreign object gets into the enclosure, immediately disconnect the power cord from the wall. Take the unit to a qualified service person for inspection and necessary repairs.

Read all the instructions before connecting or operating the component. Keep this manual so you can refer to these safety instructions.

Heed all warnings and safety information in these instructions and on the product itself. Follow all operating instructions.

Clean the enclosure only with a dry cloth or a vacuum cleaner.

You must allow 10 cm or 4 inches of unobstructed clearance around the unit. Do not place the unit on a bed, sofa, rug, or similar surface that could block the ventilation openings. If the unit is placed in a bookcase or cabinet, there must be ventilation of the cabinet to allow proper cooling.

Keep the component away from radiators, heat registers, stoves, or any other appliance that produces heat.

The unit must be connected to a power supply only of the type and voltage specified on the rear panel. (USA: 115 V/60Hz, EC: 230V/50Hz)

Connect the component to the power outlet only with the supplied power supply cable or an exact equivalent. Do not modify the supplied cable. Do not defeat grounding and/or polarization provisions. The cable should be connected to a 2-pin polarized wall outlet, matching the wide blade of the plug to the wide slot of the receptacle. Do not use extension cords.

Do not route the power cord where it will be crushed, pinched, bent, exposed to heat, or damaged in any way. Pay particular attention to the power cord at the plug and where it exits the back of the unit.

The power cord should be unplugged from the wall outlet if the unit is to be left unused for a long period of time.

Immediately stop using the component and have it inspected and/or serviced by a qualified service agency if:

- The power supply cord or plug has been damaged.
- Objects have fallen or liquid has been spilled into the unit.
- The unit has been exposed to rain.
- The unit shows signs of improper operation
- The unit has been dropped or damaged in any way

1: Front and Rear Panels

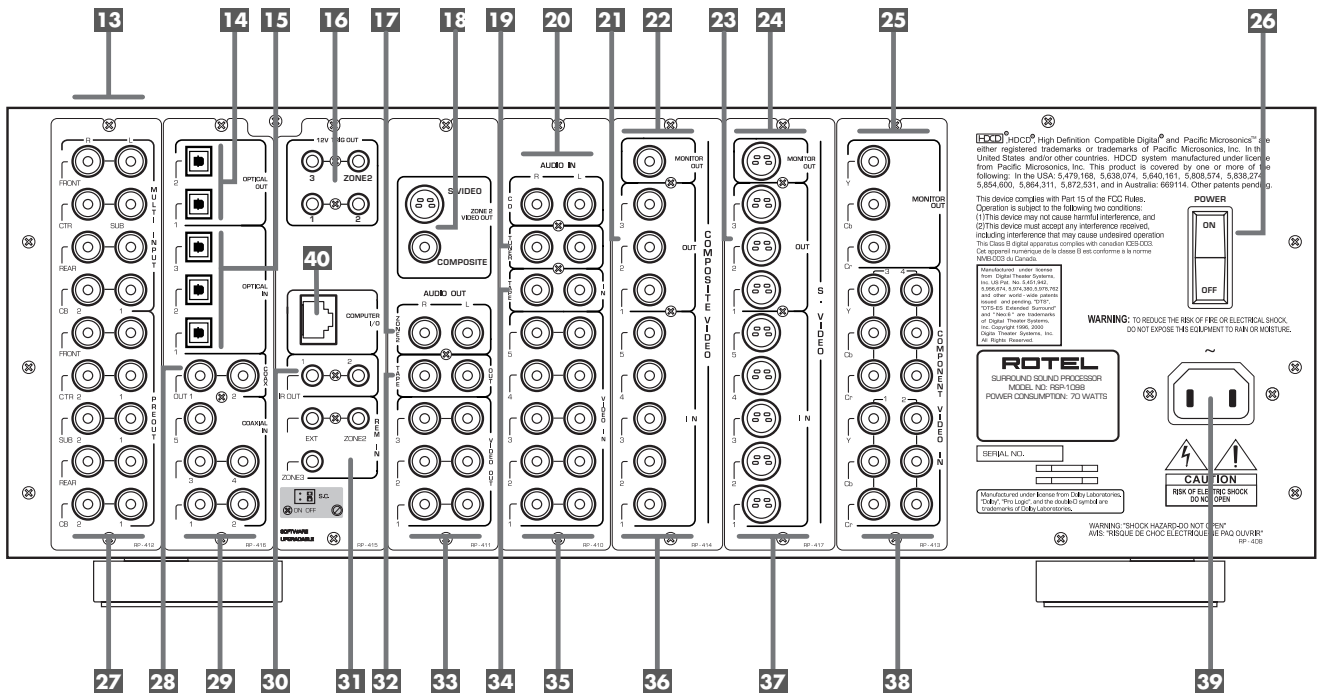
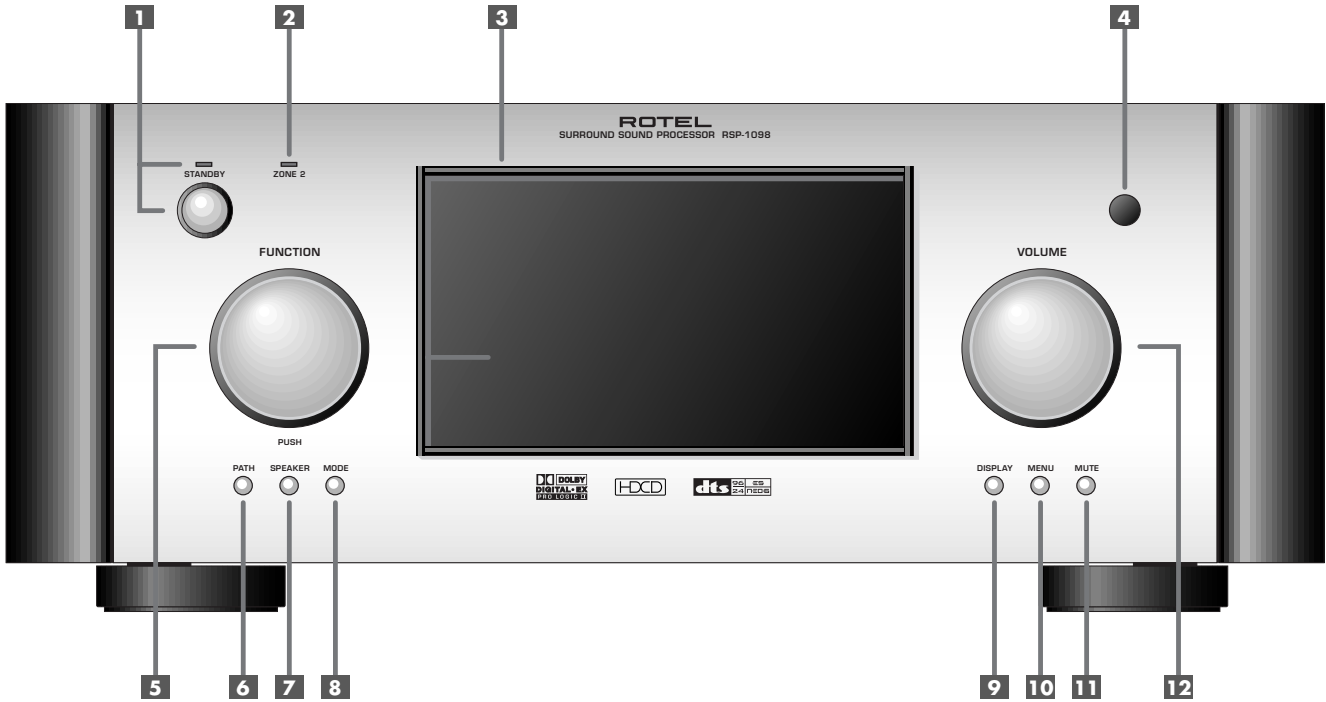

2: RR-1050 Remote

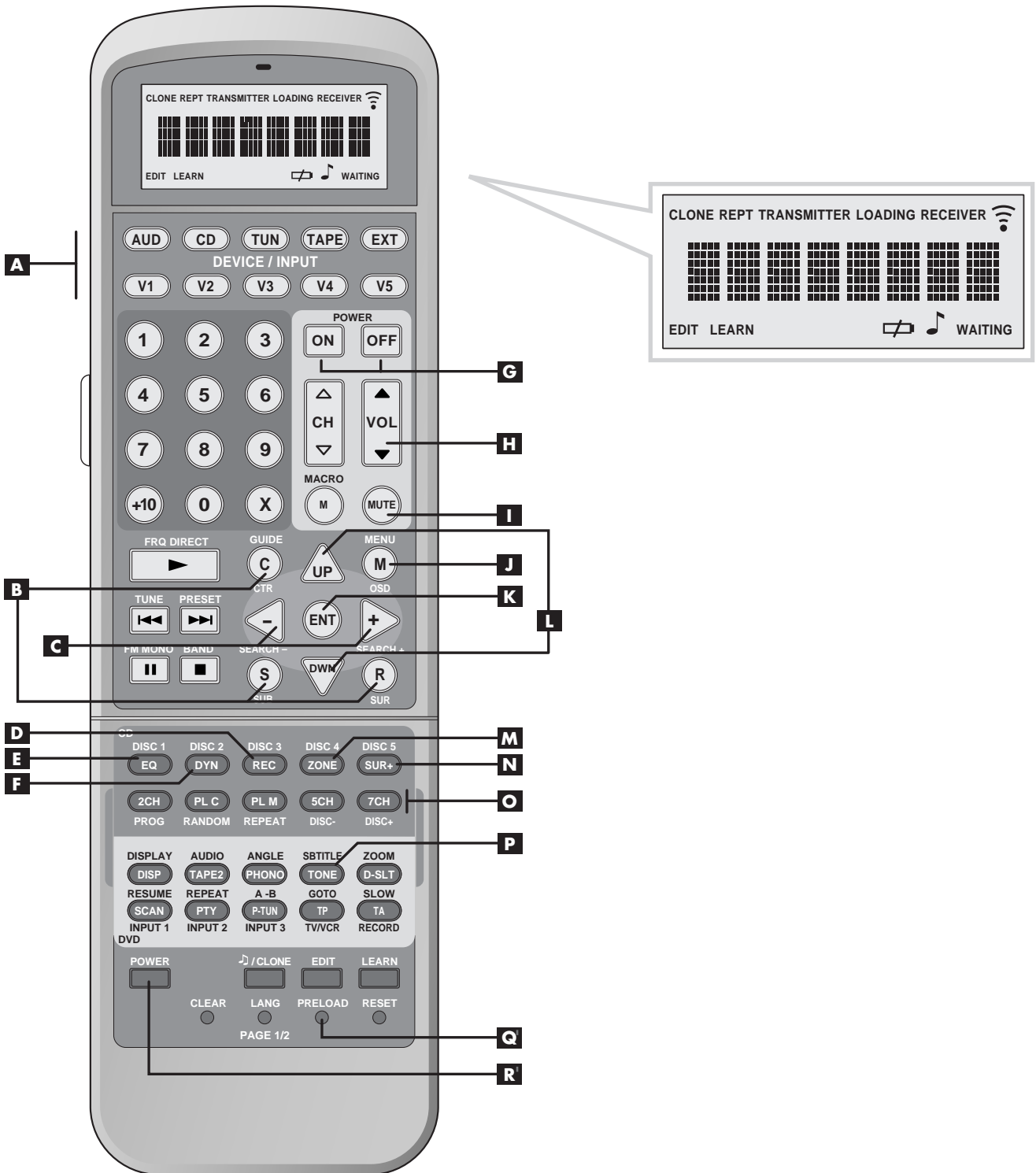

3: On-Screen Display/TFT Screen Menus

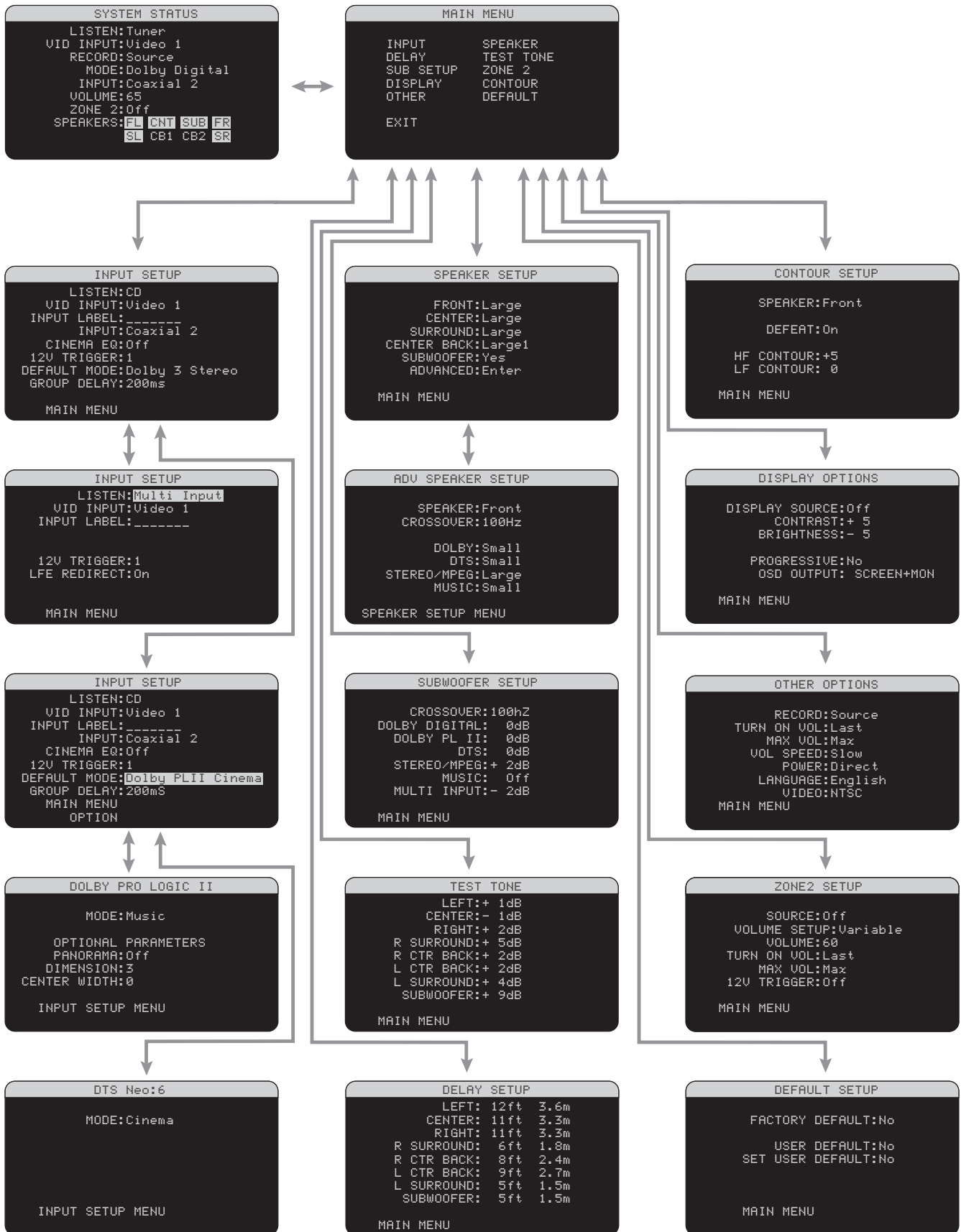

4: Outputs

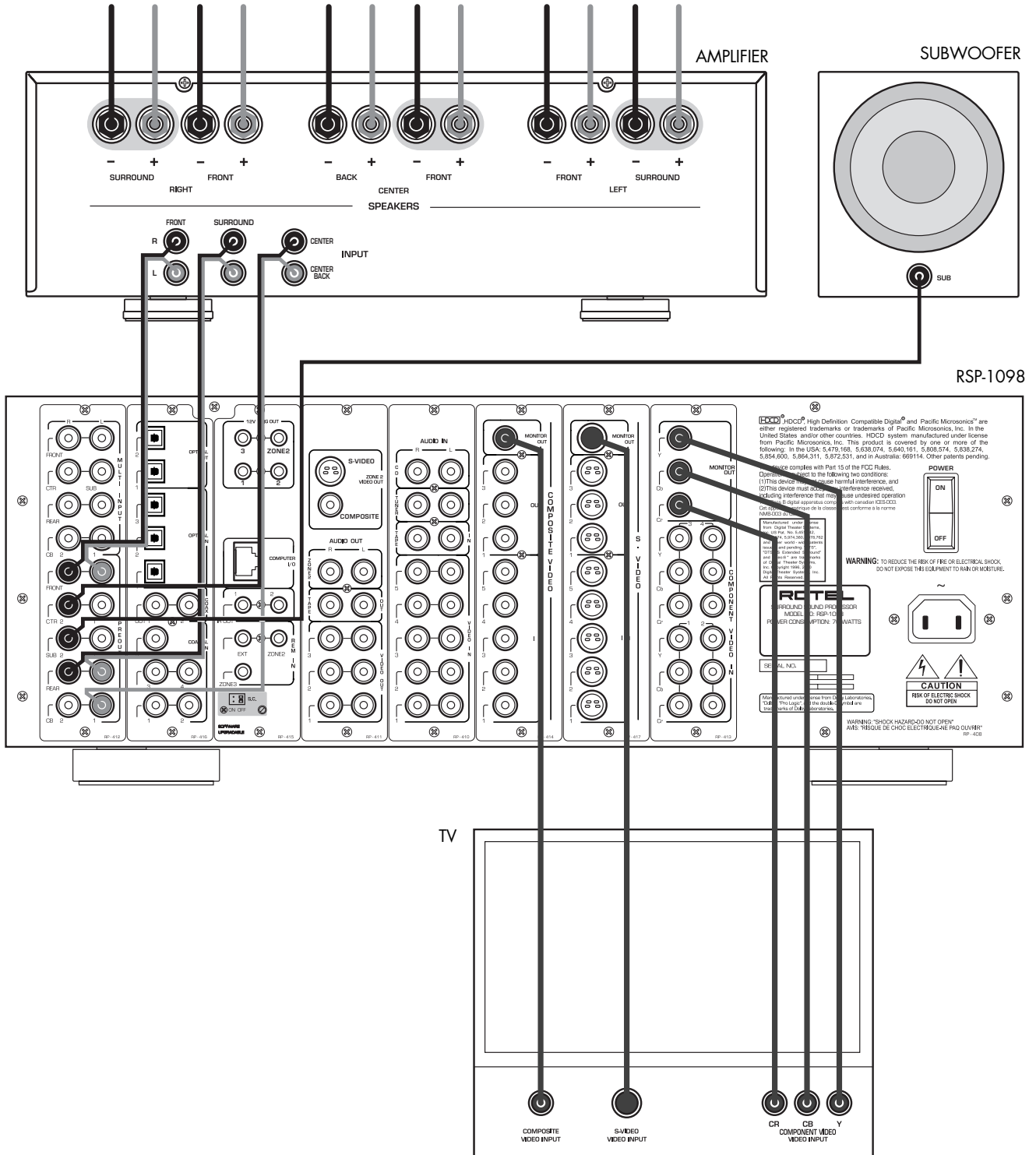

5: Source Connections

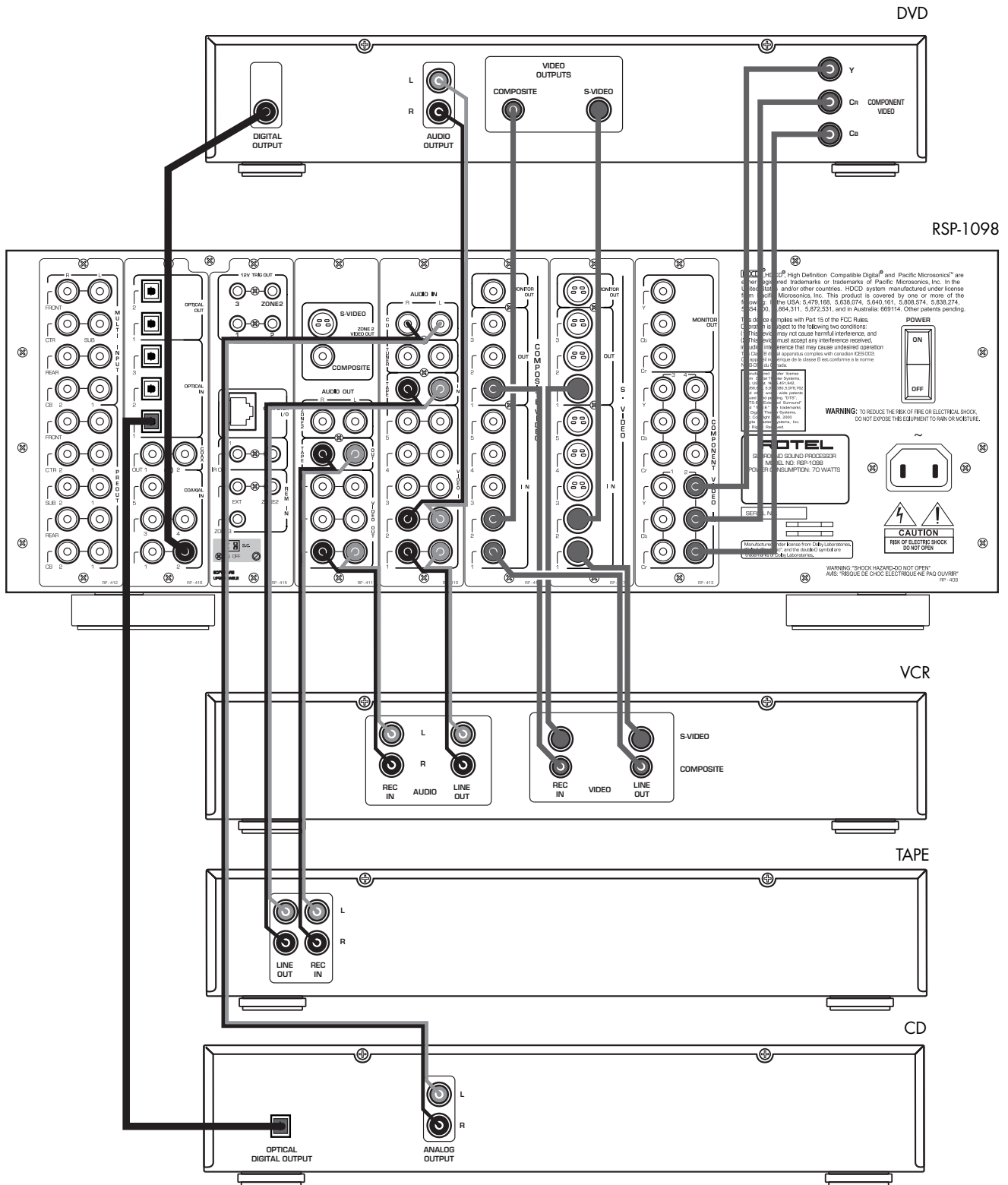

6: Zone 2 Connections

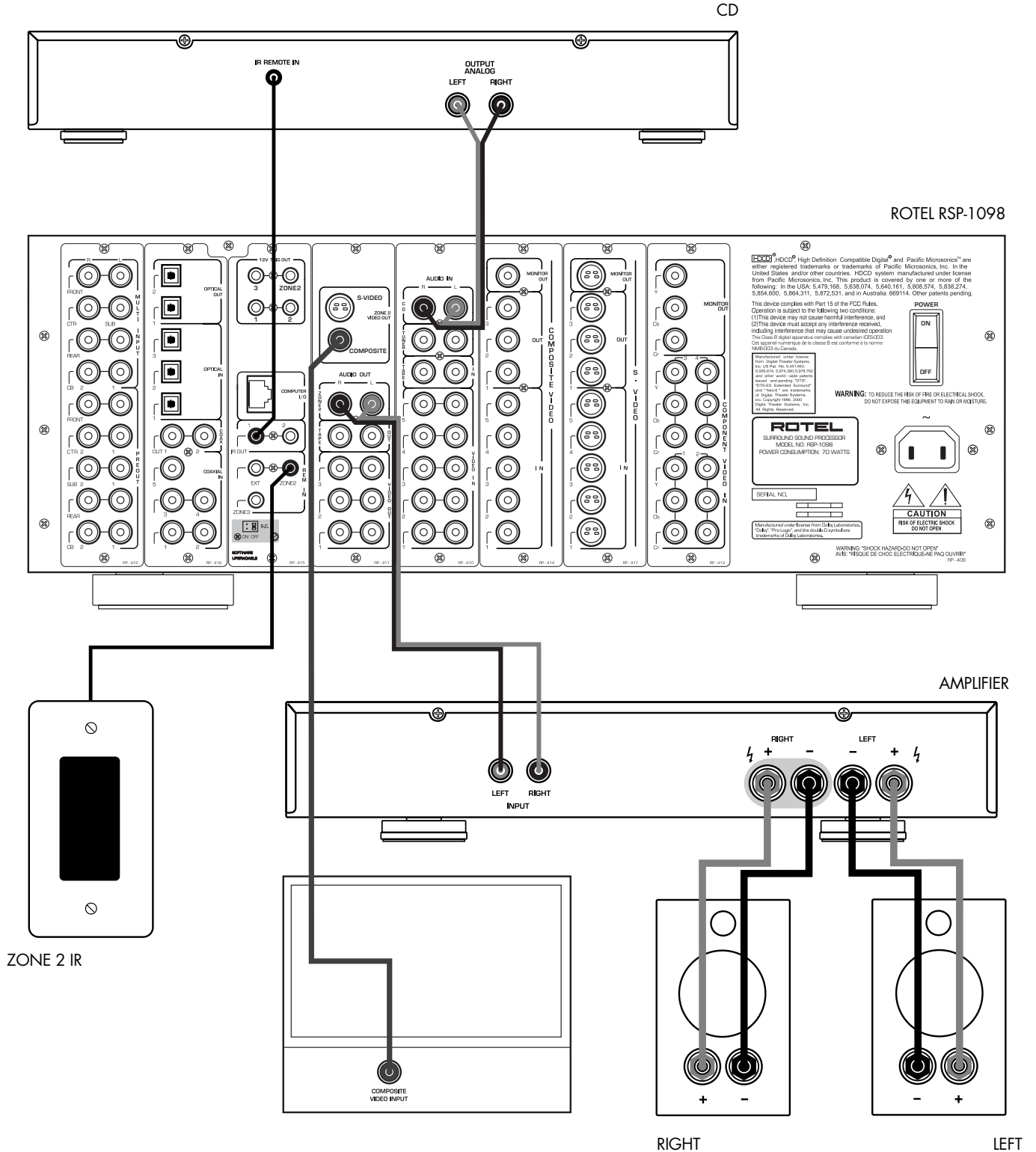

Contents

Boxed numbers refer to RSP-1098 illustration.
Boxed letters refer to RR-1050 illustration.

Important Safety Instructions	3
1: Front and Rear Panels	4
2: RR-1050 Remote	5
3: On-Screen Display/TFT Screen Menus	6
4: Outputs	7
5: Source Connections	8
6: Zone 2 Connections	9
About Rotel	12
Getting Started	12
Video features	12
Audio features	12
Surround features	12
Other features	12
Unpacking	13
Placement	13
CONNECTIONS	13
Analog Audio Inputs & Outputs	13
CD Inputs 20	13
Tuner Inputs 19	13
TAPE Inputs 34	13
TAPE Outputs 32	13
VIDEO 1–5 Audio Inputs 35	14
VIDEO 1–3 Audio Outputs 33	14
MULTI Inputs 13	14
Preamp Outputs 27	14
ZONE 2 Audio Outputs 17	14
Video Inputs & Outputs	14
VIDEO 1–5 Composite Video Inputs 36	15
VIDEO 1–3 Composite Video Outputs 21	15
VIDEO 1–5 S-Video Inputs 37	15
VIDEO 1–3 S-Video Outputs 23	15
VIDEO 1–4 Component Video Inputs 38	15
TV Monitor Outputs 22 24 25	15
ZONE 2 Video Outputs 18	15
Digital Audio Input & Outputs	15
Digital Inputs 15 29	15
Digital Outputs 14 28	16
Other Connections	16
AC Input 39	16
Master Power Switch 26	16
12V TRIGGER Connections 16	16
REM IN Jacks 31	16
IR OUT Jacks 30	16
Computer I/O 40	16
Making Connections	17
CD Player	17
DVD Player	17
Cable, Satellite, or HDTV Tuner	17
AM/FM Tuner	17
Audio Tape Recorder	17
VCR or Digital Video Recorder	17
DVD-A or SACD Player	17
TV Monitor	18
Amplifiers and Powered Subwoofers	18
OPERATING THE RSP-1098	18
Front Panel Overview	18
Color TFT Display 3	18
MENU button 10 J	18
DISPLAY Button 9	18
STANDBY Button 1	18
VOLUME Knob 12	18
MUTE Button 11 I	19
FUNCTION Knob 5	19
PATH Button 6	19
SPEAKER Button 7	19
MODE Button 8	19
Remote Sensor 4	19
ZONE 2 LED 2	19

Remote Control Overview	19	Overview of Surround Formats	22	SETUP	29
Using the RR-1050		Dolby Surround		Menu Basics	29
AUDIO Button A	19	Dolby Pro Logic II	22	Navigation Buttons C J K L	29
Programming the RR-1050		Dolby Digital	22	System Status	29
PRELOAD Button Q	19	DTS 5.1		Main Menu	30
MENU/OSD button IO J	19	DTS 96/24	22	Display Options	30
ENTER Button K	19	DTS Neo:6	23	Configuring Inputs	30
ON/OFF Buttons G	19	6.1 and 7.1 Surround	23	Input Setup	30
POWER Button R	19	DSP Music Modes	23	Multi Input Setup	31
VOLUME Button H	20	2Ch/5Ch/7Ch Stereo Formats	23	Dolby Pro Logic II	32
MUTE Button 11 I	20	Other Digital Formats	24	DTS Neo:6	32
DEVICE/INPUT Buttons A	20	Automatic Surround Modes	24	Configuring Speakers and Audio	32
REC Button D	20	Manually Selecting Surround Modes	24	Understanding Speaker Configuration	32
ZONE Button M	20	Dolby Digital 5.1		Speaker Setup	33
UP/DOWN Buttons L	20	Dolby Digital Surround EX	25	Advance Speaker Setup	34
+/- Buttons C	20	Dolby Digital 2.0	25	Subwoofer Setup	34
Speaker Selection Buttons B	20	DTS 5.1		Test Tone	35
EQ Button E	20	DTS 96/24		Delay Setup	36
TONE Button P	20	DTS-ES 6.1	25	Contour Setup	36
Surround Mode Buttons O	20	MPEG Multichannel	26	Miscellaneous Settings	36
SUR+ Button N	20	Digital Stereo		Other Options	36
DYN Button F	20	(PCM, MP3, and HDCD)	26	Zone 2 Setup	37
Basic Operations	20	Analog Stereo	26	Default Setup	37
Power and Standby On/Off 1 G R	20	Other Settings	27	MORE INFORMATION	38
Volume Adjustments 12 H	21	Temporary Speaker Level B L S 7	27	Troubleshooting	38
Muting the Sound 11 I	21	Temporary Group Delay B L S 7	27	Specifications	39
Display Options 3 9	21	Dynamic Range F S 8	27	Audio	39
Selecting Inputs	21	Contour/Tone Settings P L	27	Video	39
Selecting a Source Input		Cinema EQ E	28	General	39
from the Front Panel 6 5	21	Zone 2 Operation	28		
Selecting a Source		Zone 2 Power On/Off Operation 6	28		
from the Remote A D M	22	Controlling Zone 2			
		from the Front Panel	28		
		Controlling Zone 2			
		from the Remote Location G H A	28		

About Rotel

A family whose passionate interest in music led them to manufacture high fidelity components of uncompromising quality founded Rotel 40 years ago. Through the years that passion has remained undiminished and the family goal of providing exceptional value for audiophiles and music lovers regardless of their budget, is shared by all Rotel employees.

The engineers work as a close team, listening to, and fine tuning each new product until it reaches their exacting musical standards. They are free to choose components from around the world in order to make that product the best they can. You are likely to find capacitors from the United Kingdom and Germany, semi conductors from Japan or the United States, while toroidal power transformers are manufactured in Rotel's own factory.

Rotel's reputation for excellence has been earned through hundreds of good reviews and awards from the most respected reviewers in the industry, who listen to music every day. Their comments keep the company true to its goal - the pursuit of equipment that is musical, reliable and affordable.

All of us at Rotel, thank you for buying this product and hope it will bring you many years of enjoyment.

"DTS", "DTS-ES Extended Surround", "DTS ES® Matrix 6.1", and "DTS ES® Discrete 6.1", and "DTS Neo:6®" are trademarks of Digital Theater Systems, Inc.

Manufactured under license from Dolby Laboratories. "Dolby", "Pro Logic", "Surround EX", and the double-D symbol are trademarks of Dolby Laboratories.

HDCCD®, HDCCD®, High Definition Compatible Digital® and Pacific Microsonics™ are either registered trademarks or trademarks of Pacific Microsonics, Inc. in the United States and/or other countries. HDCCD system manufactured under license from Pacific Microsonics, Inc. This product is covered by one or more of the following: In the USA: 5,479,168, 5,638,074, 5,640,161, 5,808,574, 5,838,274, 5,854,600, 5,864,311, 5,872,531, and in Australia: 669114. Other patents pending.

Getting Started

Thank you for purchasing the Rotel RSP-1098 Surround Sound Processor. The RSP-1098 is full-featured audio/video control center for analog and digital source components. It features digital processing for a wide range of formats including Dolby Surround®, Dolby Digital®, DTS® and HDCD® source material.

Video features

- Front panel widescreen color TFT screen for video or operating menus.
- Wideband 100 MHz video processing for HDTV signals.
- Full complement of composite, S-Video, and Component Video inputs and outputs
- Conversion of composite and S-Video signals to Component Video for output to TV monitor.

Audio features

- Rotel's Balanced Design Concept combines advanced circuit board layout, comprehensive parts evaluation, and extensive listening tests for superior sound and reliability.
- Individual circuit boards grouped by function for maximum signal isolation.
- 24-bit/128x oversampling analog-to-digital converters from AKM and Crystal Semiconductor 24-bit/192 kHz digital-to-analog converters
- Analog bypass mode for pure 2-speaker stereo with no digital processing.
- Optical and coax digital inputs and outputs.
- MULTI Input for 7.1 channel analog signals from DVD-A and SACD players. Subwoofer options include .1 channel pass through or bass redirect feature with an analog low-pass filter for a summed subwoofer output from seven channels.
- Automatic HDCCD® decoding for signals from High Definition Compatible Digital® compact discs.
- Automatic decoding of digital signals from MP3 (MPEG-1 Audio Layer 3) players.

Surround features

- Automatic Dolby Digital® decoding for Dolby Digital® 2.0, Dolby Digital® 5.1, and Dolby Digital Surround EX® recordings.
- Dolby® Pro Logic II® decoding for Dolby Surround® matrix encoded recordings. Can be optimized for Music or Cinema sources plus an emulation mode for the original Dolby Pro Logic decoding.
- Automatic decoding for DTS® 5.1 channel, DTS-ES® Matrix 6.1 channel, DTS-ES® Discrete 6.1 channel, and DTS 96/24 digital recordings.
- DTS® Neo:6® Surround modes for deriving surround channels for 5.1, 6.1 or 7.1 channel systems from 2-channel stereo or matrix surround recordings. Can be optimized for Music or Cinema sources.
- Automatic decoding for MPEG Multichannel digital recordings.
- Rotel XS (eXtra Surround) automatically ensures proper decoding and optimum performance from any multichannel digital signal on 6.1 and 7.1 channel systems. Always active in any system with center back speaker(s), Rotel XS even works with signals that would not otherwise activate the proper decoding (such as non-flagged DTS-ES and Dolby Surround EX discs) or for which there is no extended surround decoder (such as DTS 5.1, Dolby Digital 5.1, and even Dolby Pro Logic II decoded Dolby Digital 2.0 recordings).
- Surround modes for playback of surround sound material on 2 channel and 3 channel systems for total compatibility.
- Four DSP Music modes.

Other features

- Multi-zone, multi-source capability with independent input selection and volume.
- User friendly ON-SCREEN DISPLAY (OSD) menu system with programmable labels for all inputs. Choice of languages.
- Learning remote control to operate the RSP-1098 and nine other components.
- Upgradeable microprocessor software to accommodate future upgrades.
- Four assignable 12V trigger outputs for remote turn-on of power amplifiers and other components.

Unpacking

Remove the unit carefully from its packing. Find the remote control and other accessories. Save the box as it will protect the RSP-1098 if you move or need to return it for maintenance.

Placement

Place the RSP-1098 on a solid, level surface away from sunlight, heat, moisture, or vibration. Make sure that the shelf can support the weight of the unit.

Place the RSP-1098 close to the other components in your system and, if possible, on its own shelf. This will make initial hookup, and subsequent system changes easier.

The RSP-1098 can generate heat during normal operation. Do not block ventilation openings. Allow a minimum of 10 cm (4 inches) of unobstructed space around the unit. If installed in a cabinet, make sure that there is adequate ventilation.

Don't stack other components or objects on top of the RSP-1098. Don't let any liquid fall into the unit.

CONNECTIONS

Although, the RSP-1098's rear panel looks daunting, connecting the unit to your system is straightforward. Each of the source components in the system are connected to the RSP-1098 inputs with a pair of standard RCA cables for analog audio, a video connection (composite, S-Video, or Component Video), and an optional digital audio cable (coax or optical).

NOTE: Surround formats like Dolby Digital and DTS are digital formats and the RSP-1098 can only decode them when a digital input signal is available. For this reason, you should always connect your DVD player's digital outputs to the RSP-1098, using either the optical or coax inputs.

The outputs of RSP-1098 are sent to the power amplifier(s) with standard RCA cables from preamp audio outputs. The video signal from the RSP-1098 is sent to the TV monitor using composite video, S-Video, or Component Video connections.

In addition, the RSP-1098 has MULTI input connections for a source component that does its own surround decoding, remote IR sensor inputs, and 12V trigger connections for remote turn-on of other Rotel components.

NOTE: Do **not** plug any system component into an AC source until all connections have been properly made.

Video cables should have a 75 ohm impedance. The S/PDIF digital audio interface standard also specifies a 75 ohm impedance and all good digital cables adhere to this requirement. Do NOT substitute conventional audio interconnect cables for digital or video signals. Standard audio interconnects will pass these signals, but their limited bandwidth reduce performance.

When making signal connections, connect LEFT channels to LEFT channel jacks and RIGHT channels to RIGHT channel jacks. All RCA-type connections on the RSP-1098 follow these standard color codes:

Left channel audio: white RCA jack

Right channel audio: red RCA jack

Composite video: yellow RCA jack

NOTE: Each source input must be properly configured using the INPUT SETUP menu of the OSD menu system. We recommend going to this menu after connecting each source to configure it as desired. See Input Setup of the Setup section for information.

Analog Audio Inputs & Outputs

The following connections are used for connecting analog audio signals to and from the RSP-1098. See the Making Connections topic for specific instructions on connecting each type of component.

NOTE: Normally, the RSP-1098 converts analog inputs to digital signals. All of the digital processing is available including bass management, digital crossovers, speaker level and delay settings and a number surround mode options including 2-ch stereo, Dolby Pro Logic II, etc. Alternatively, there is an analog bypass surround mode that routes 2-ch analog inputs directly to the Volume control and preamp outputs, bypassing the digital processing entirely for pure analog stereo.

CD Inputs 20

A left/right pair of RCA analog audio inputs for connecting a CD player.

Tuner Inputs 19

A left/right pair of RCA analog audio inputs for connecting an AM/FM tuner.

TAPE Inputs 34

A pair of RCA inputs, labeled TAPE IN, for connecting the left/right analog audio signals from an audio tape deck or recording device.

TAPE Outputs 32

A pair of RCA inputs, labeled TAPE OUT, for sending left/right line level analog audio signals for recording on a tape deck or recording device.

NOTE: These outputs should be connected to the inputs of the same tape deck connected to the TAPE IN inputs.

VIDEO 1-5 Audio Inputs 35

Five pair of RCA inputs, labeled AUDIO IN (VIDEO IN 1 – 5), provide connections for left/right analog audio signals from five additional source components. These inputs have corresponding video inputs and are used for VCRs, satellite TV tuners, DVD players, etc. However, they may also be used for additional audio only components, simply omitting the corresponding video connections.

VIDEO 1-3 Audio Outputs 33

Three pair of RCA jacks, labeled AUDIO OUT (VIDEO OUT 1 – 3), provide connections for sending line level left/right line level analog audio signals for recording to a VCR.

These connections correspond to the VIDEO IN 1-3 connections. Make sure that you are consistent. If you hook up a particular VCR to the VIDEO 1 inputs, hook up the VIDEO 1 outputs to the same VCR.

NOTE: There are no analog audio outputs for VIDEO 4 & 5. Therefore, in an elaborate system, hook up all of the VCRs and recording devices to VIDEO 1-3 and use VIDEO 4 & 5 for playback only components.

NOTE: Video 1-3 can be used for audio-only tape decks, simply omitting the corresponding video connections.

MULTI Inputs 13

A set of RCA inputs accept up to 7.1 channels of analog signals from a DVDA or SACD player. There are inputs for FRONT L & R, CENTER, SUB, REAR L & R, and CENTER BACK 1 & 2.

These inputs bypass all digital processing in the RSP-1098 and are routed directly to the Volume control and preamp outputs

There are two subwoofer options for the MULTI input. Normally, the .1 channel input is passed through directly to the subwoofer output. An optional bass redirect feature duplicates the 7 main channels, sums them, and sends this mono signal through a 100 Hz analog low filter to the subwoofer output. This provides an unaltered analog bypass for the seven main channels along with a subwoofer signal derived from those channels.

Preamp Outputs 27

A group of ten RCA analog audio outputs sends the RSP-1098's line level output signals to external amplifiers and powered subwoofers. These outputs are variable level, adjusted by the RSP-1098 volume control. The eight connectors provide output for: FRONT L & R, CENTER 1 & 2, SURROUND L & R, CENTER BACK CB1 & CB2, and SUBWOOFER 1 & 2.

NOTE: Depending on your system configuration, you may use some or all of these connections. For example, if you only have one center channel, connect it to the CENTER 1 output. If you only have one center back channel, connect it to the CB1 output.

ZONE 2 Audio Outputs 17

A pair of RCA inputs, labeled AUDIO OUT/ZONE 2, sending analog audio signals to an external amplifier for a remote zone. These outputs can be configured as either fixed or variable level using the ZONE 2 SETUP menu.

NOTE: Only analog input signals are available at the Zone 2 outputs. Source components connected to only the digital inputs are not available in Zone 2.

To configure your system for Zone 2 operation, connect the left and right Zone 2 outputs on the RSP-1098 to the left and right channel inputs of the amplifier powering the remote speakers, using standard RCA audio cables.

Video Inputs & Outputs

These connections are used for connecting video signals to and from the RSP-1098. See the *Making Connections* section for specific instructions for each type of component.

The RSP-1098 provides Composite, S-Video, and Component Video connections. Composite video connections simplify system configuration; however, S-Video connections typically provide better picture quality. Component Video connections are required for HDTV or progressive scanned DVD video. Be aware of the following implications for the configuration of your system:

On Screen Display: The RSP-1098 OSD system is available on the TV monitor, regardless of what type of connection is made from the TV MONITOR outputs to the TV set. The OSD system is also available in the TFT screen.

NOTE: When using a progressive scan or 1080i video signal from the Component Video inputs, the TV monitor cannot display the video signal and the OSD menus at the same time. A "progressive" setting in the Display Options setup menu allows the use of the main OSD setup menus, even with progressive or HDTV signals. When the main OSD setup menus are activated, the progressive scan video input is interrupted and restored when the OSD menus are cancelled. The temporary OSD information displays (such as volume setting, etc.) are not displayed. All of the OSD displays are available on the front-panel TFT screen.

Output Conversion: The RSP-1098 converts composite and S-Video signals to Component Video signals for output to an NTSC or PAL standard TV monitor. For maximum convenience, connect the RSP-1098 to the TV monitor with Component Video connections. S-Video signals cannot be converted to composite outputs and vice versa.

NOTE: When the progressive mode is set to YES in the DISPLAY OPTIONS setup menu, the conversion from composite or S-Video to Component Video output is only available for the VIDEO 5 input, not for the VIDEO 1-4 inputs.

Many digital HDTV monitors adjust scan rates and other video parameters depending on the type of input connection. You may wish to make multiple connections between the RSP-1098 and the TV monitor, switching inputs on the TV to take advantage of these features.

TFT Display: If you choose to display video signals on the front panel display, keep in mind that it can only display signals from sources connected with composite video connections.

Even if you use Component Video connections, it is recommended that you also make composite video connections from each source component to the RSP-1098 so that the signal from each source component can be displayed on the front panel TFT display.

NOTE: The TFT display cannot properly display progressive scan (480p) signals. When a DVD player is outputting a progressive scan signal on Component Video outputs, its composite video outputs may not provide a usable signal. In this case, the TFT screen will not be able to display video from the DVD player or may display distorted video, even with a composite video connection.

VIDEO 1-5 Composite Video Inputs 36

Five inputs accept standard composite video signals from source components using standard 75 ohm RCA video cables.

VIDEO 1-3 Composite Video Outputs 21

Three RCA jacks, labeled COMPOSITE VIDEO OUT 1-3, provide connections for sending composite video signals for recording on a VCR or other recording device.

These connections correspond to the VIDEO IN 1-3 connections. Make sure that you are consistent. If you hook up a particular VCR to the VIDEO 1 inputs, hook up the VIDEO 1 output to the same VCR.

NOTE: The RSP-1098 cannot convert S-Video or Component Video signals to composite video. Therefore, only signals received at the composite video inputs are available at these outputs.

VIDEO 1-5 S-Video Inputs 37

Five inputs, labeled S-VIDEO IN 1-5 accept S-Video signals from source components.

VIDEO 1-3 S-Video Outputs 23

Three S-VIDEO jacks, labeled S-VIDEO OUT 1-3, provide connections for sending S-Video signals for recording on a VCR or other recording device.

These connections correspond to the VIDEO IN 1-3 connections. Make sure that you are consistent. If you hook up a particular VCR to the VIDEO 1 inputs, hook up the VIDEO 1 output to the same VCR.

NOTE: The RSP-1098 cannot convert composite video or Component Video signals to S-Video. Only signals received at the S-Video inputs are available at these outputs.

VIDEO 1-4 Component Video Inputs 38

Component Video connections split the video into three signals – luminance (Y) and separate chrominance (CB and CR) signals, allowing delivery of a reference-quality picture with high definition signals. Component Video connections should be used for progressive scan DVD players and high-definition digital television

receivers. Each of these signals is carried by a separate 75 ohm video cable with RCA connectors.

NOTE: In progressive scan mode, a DVD player may not be able to output a usable video signal on its composite video outputs. In this case, the TFT screen will not be able to display video from the DVD player, even with a composite video input.

Four sets of inputs, labeled COMPONENT VIDEO IN 1-4 accept Component video signals from source components.

NOTE: When using a progressive scan or 1080i HDTV video signal from the Component Video inputs, the TV monitor cannot display the video signal and the OSD menus at the same time. A "progressive" setting in the Display Options setup menu allows the use of the main OSD setup menus, even with progressive or HDTV signals. When the main OSD setup menus are displayed, the progressive video signal is interrupted and restored when the OSD menus are cancelled. The temporary OSD information displays (such as volume setting, etc.) are not displayed.

TV Monitor Outputs 22 24 25

The TV MONITOR outputs of the RSP-1098 send the video signal to your TV monitor. Three types of video output connections are provided – RCA composite video, S-Video, and Component Video.

The composite video output only sends signals from composite video inputs to the TV monitor. The S-Video output only sends signals from S-Video video inputs to the TV. The Component Video output converts signals from ANY type of source input to the TV. If you have connected all of your source components with the same type of connection, then you only need to make one connection from the RSP-1098 to the TV monitor. If you connect the RSP-1098 to the TV monitor with Component Video connections, you also only need to make one type of connection because composite and S-Video signals are converted to Component Video.

NOTE: When the progressive mode is set to YES in the DISPLAY OPTIONS setup menu, the conversion from composite or S-Video to Component Video output is only available for the VIDEO 5 input, not for the VIDEO 1-4 inputs.

ZONE 2 Video Outputs 18

The ZONE 2 Video outputs of the RSP-1098 send the video signal to a TV monitor in the remote zone. Two types of video output connections are provided – RCA composite video and S-Video.

NOTE: Only composite video input signals are available at the Zone 2 composite video outputs. Only S-Video input signals are available at the Zone 2 S-Video video outputs.

Digital Audio Input & Outputs

The RSP-1098 provides digital connections which may be used in place of, or in addition to, the analog audio input and output connections described in the previous sections. These connections include eight digital inputs and four digital outputs for recording.

These digital connections can be used with any source component that supplies a digital signal, such as a DVD player, CD player, or satellite TV tuner.

NOTE: With a digital connection, the RSP-1098 will be used to decode the signal, rather than the source component's internal decoders. In general, you must use digital connections for a DVD player or other component that supplies a Dolby Digital or DTS signal; otherwise the RSP-1098 will not be able to decode these formats.

Digital Inputs 15 29

The RSP-1098 accepts digital inputs from source components such as CD players, satellite TV tuners, and DVD players. The built-in digital processor senses and adjusts to the correct sampling rates.

There are eight digital inputs on the rear panel, five coaxial and three optical. These digital inputs can be assigned to any of the input sources using the INPUT SETUP screen during the setup process. For example, you can assign the COAXIAL 1 digital input connector to the VIDEO 1 source and the OPTICAL 2 digital input to the VIDEO 3 source.

NOTE: When using digital connections, you should also make the analog audio input connections described previously. The analog connection is necessary to record to an analog recorder in some circumstances or for ZONE 2 operation

Digital Outputs 14 28

The RSP-1098 has four digital outputs (two coaxial and two optical) to send the digital signal from any of the digital inputs to a digital recorder or outboard digital processor. When a digital input source signal is selected for listening, that signal is automatically sent to both digital outputs for recording.

NOTE: Only digital signals from source components are available at these outputs. Analog signals cannot be converted and are not available at the digital outputs.

Other Connections

AC Input 39

Your RSP-1098 is configured at the factory for the proper AC line voltage in the country where you purchased it (USA: 115 volts/60Hz AC or CE: 230 volts /50 Hz AC). The AC line configuration is noted on a decal on the back of your unit.

Plug the supplied cord into the AC INPUT receptacle on the back of the unit.

NOTE: Memorized settings and video labels are preserved indefinitely, even if the RSP-1098 is disconnected from AC power.

Master Power Switch 26

The large rocker switch on the rear panel is a master power switch. When it is in the OFF position, power to the unit is completely off. When it is in the ON position, the front panel STANDBY and remote control ON/OFF buttons can be used to activate the unit or put it standby mode.

NOTE: After all connections are completed, the rear panel master power switch should be put in the ON position and usually left in that position.

12V TRIGGER Connections 16

Many Rotel amplifiers offer the option of turning them on and off using a 12 volt trigger. These four connections provide this 12 volt trigger signal from the RSP-1098. When the RSP-1098 is activated, a 12 volt DC signal is sent to the amplifiers to turn them on. When the RSP-1098 is put in STANDBY mode, the trigger signal is interrupted and the amplifiers turn off.

To use the remote turn on feature, connect one of the RSP-1098's 12V TRIG OUT jacks to the 12 volt trigger input of a Rotel amplifier, using a cable with mono 3.5 mm mini-plugs on both ends. The +12 V DC signal appears at the "tip" connector.

NOTE: The 12V Trigger outputs can be configured to turn on only when specific input sources are activated. See the Input Setup and Zone 2 Setup menus in the Setup section of this manual for details.

REM IN Jacks 31

Three 3.5 mm mini-jacks (labeled REM IN, ZONE 2, and ZONE 3) receive command codes from an industry-standard infrared receivers (Xantech, etc.), used when the IR signals from a hand held remote control cannot reach the front panel IR sensor.

EXT: The EXT jack is used with an outboard IR receiver to duplicate the front panel IR sensor. This feature is useful when the unit is installed in a cabinet and the front panel sensor is blocked or when IR signals need to be relayed to other components.

ZONE 2 and ZONE 3: These two jacks are used with IR repeater systems to receiver signals from IR control systems in remote locations. For example, remote control signals sent to the ZONE 2 REM IN control the ZONE 2 features of the RSP-1098 and can be relayed to other components. Remote control signals sent to the ZONE 3 REM IN can be used to select the RECORDING source (the signal available at the TAPE OUT connections).

Consult your authorized Rotel dealer for information on external receivers and the proper wiring of a 3.5 mm mini-plugs to fit the REM IN jacks.

NOTE: The IR signals from the EXT REMOTE IN jack (as well as those from the ZONE 2/ZONE 3 REMOTE IN jacks) can be relayed to source components using external IR emitters or hard-wired connections from the IR OUT jacks. See the following section for additional information.

IR OUT Jacks 30

The IR OUT 1 & 2 jacks send IR signals received at the ZONE REM IN jacks or the EXT REM IN jack to an infrared blaster or emitter placed in front of a source component's IR sensor. In addition, the IR OUT can be hard-wired to Rotel CD players, DVD players, or tuners with a compatible connector.

These outputs are used to allow IR signals from Zone 2 to be sent to the source components, or to pass along IR signals from a remote in the main room when the sensors on the source components are blocked by installation in a cabinet.

See your authorized Rotel dealer for information on IR emitters and repeater systems.

Computer I/O 40

The RSP-1098 can be operated from a computer with audio system control software from third-party developers. This control is accomplished by sending operating codes from the computer via a hard-wired RS-232 serial connection. In addition, the RSP-1098 can be updated using special software from Rotel.

The COMPUTER I/O input provides the necessary network connections on the rear panel. It accepts standard RJ-45 8-pin modular plugs, such as those commonly used in 10-BaseT UTP Ethernet cabling.

For additional information on the connections, cabling, software, and operating codes for computer control or updating of the RSP-1098, contact your authorized Rotel dealer.

Making Connections

CD Player

Connect the left and right analog outputs from the CD player to the AUDIO IN jacks labeled CD (left and right).

Optional: Connect the digital output of the CD player to any of the Optical or Coax digital inputs on the RSP-1098. Use the INPUT SETUP screen to assign that digital input to the CD source.

There are no video connections for a CD Player.

DVD Player

DVD connections can be made to the VIDEO 1, 2, 3, 4, or 5 inputs. In elaborate systems, you may wish to use VIDEO 4 or VIDEO 5 for DVD players, since these inputs do not have corresponding OUTPUT connections. If you choose VIDEO 1, make sure that you use VIDEO 1 inputs and outputs for all analog audio and video connections.

Connect a video cable (Composite Video, S-Video, and/or Component Video) from the output of the DVD player to the appropriate VIDEO IN 1–5 input. If you intend to use the progressive scan feature with an HDTV monitor, you should use Component Video connections. If you choose S-Video or Component Video connections, you should also make a standard Composite Video connection so that the DVD menus can be displayed on the RSP-1098 front panel display.

Connect the digital output of the DVD player to any one of the OPTICAL IN or COAXIAL IN digital inputs on the RSP-1098. Use the INPUT SETUP screen to assign that digital input to the same video input source used above. For example, if you use the Video 4 inputs above, assign the digital input to the VIDEO 4 input.

If you want to record the audio signal from the DVD player, connect the left and right analog outputs from the DVD player to the left and right AUDIO IN jacks corresponding to the VIDEO IN input selected above.

Cable, Satellite, or HDTV Tuner

TV tuner connections can be made to the VIDEO 1, 2, 3, 4, or 5 inputs. In elaborate systems, you may wish to use VIDEO 4 or VIDEO 5 for TV tuners, since these inputs do not have

corresponding OUTPUT connections. If you choose VIDEO 1, make sure that you use VIDEO 1 inputs and outputs for all analog audio and video connections.

Connect a video cable (Composite Video, S-Video, and/or Component Video) from the output of the TV tuner to the appropriate VIDEO IN 1–5 input. For HDTV signals, you should use Component Video connections. If you choose S-Video or Component Video connections, you should also make a standard Composite Video connection so that the TV signals can be displayed on the RSP-1098 front panel display.

Connect the left and right analog outputs from the TV tuner to the left and right AUDIO IN jacks corresponding to the VIDEO IN input selected above.

OPTIONAL: Connect the digital output of the TV tuner to any one of the OPTICAL IN or COAXIAL IN digital inputs on the RSP-1098. Use the INPUT SETUP screen to assign that digital input to the same video input source used above. For example, if you use the Video 4 inputs above, assign the digital input to the VIDEO 4 input.

AM/FM Tuner

Connect the left and right analog outputs from the tuner to the AUDIO IN jacks labeled TUNER (left and right).

There are no digital connections or video connections for an AM/FM tuner.

Audio Tape Recorder

Connect the left and right analog outputs from an audio tape deck to the AUDIO IN jacks labeled TAPE IN (left and right).

Connect the left/right AUDIO OUT/TAPE OUT jacks to the inputs on the audio tape deck.

Optional: For a digital recording device, connect the digital output of the recorder to one of the OPTICAL IN or COAXIAL IN digital inputs on the RSP-1098. Use the INPUT SETUP screen to assign that digital input to the TAPE source. If the recording device accepts a digital recording input, connect one of the OPTICAL OUT or COAXIAL OUT connections to the digital input of the recorder.

No video connections are required for an audio recording device.

VCR or Digital Video Recorder

VCR connections can be made to the VIDEO 1, VIDEO 2, or VIDEO 3 inputs and outputs. If you choose VIDEO 1, make sure that you use VIDEO 1 inputs and outputs for all analog audio and video connections.

Connect video cables (Composite Video, S-Video, and/or Component Video) from the output of the VCR to the appropriate VIDEO IN 1–3 input. If you choose S-Video or Component Video connections, you should also make a standard Composite Video connection so that the TV signals can be displayed on the RSP-1098 front panel display.

Connect a video cables (Composite Video, S-Video, and/or Component Video) from the VIDEO OUT jacks to the VCR inputs.

Connect the left and right analog outputs from VCR to one pair of the AUDIO IN jacks labeled VIDEO 1–3.

Connect the left and right AUDIO OUT jacks for VIDEO 1–3 to the analog inputs on the VCR.

Optional: For a digital recording device, connect the digital output of the recorder to one of the OPTICAL IN or COAXIAL IN digital inputs on the RSP-1098. Use the INPUT SETUP screen to assign that digital input to the VIDEO source (VIDEO 1, 2, or 3) used for the previous connections. If the recording device accepts a digital recording input, connect one of the OPTICAL OUT or COAXIAL OUT connections to the digital input of the recorder.

DVD-A or SACD Player

To hook up a DVD-A, an SACD player (or any external surround decoder), use audio RCA cables to connect the outputs of the player to the RCA jacks labeled MULTI INPUT, making sure that you observe proper channel consistency, i.e. connect the right front channel to the R FRONT input, etc. Depending on your system configuration, make six connections (FRONT L & R, SURROUND L & R, CENTER, and SUBWOOFER), seven connections (adding a CENTER BACK connection), or eight connections (adding two CENTER BACK connections).

The MULTI inputs are analog bypass inputs, passing signals directly through to the Volume Control and preamp outputs, bypassing all of the digital processing. The RSP-1098 provides an optional bass redirect feature that duplicates the seven main channels and passes them

through an analog 100 Hz low pass filter, creating a summed mono subwoofer output derived from the main channels. See the *INPUT SETUP* menu in the *Setup* section of this manual for details on bass redirect feature.

TV Monitor

Connect the TV MONITOR *output* to the corresponding *input* on your television monitor, using composite video, S-Video, and/or Component Video cables.

NOTE: *The RCA composite video output only sends signals from RCA composite video source inputs to the TV monitor. The S-Video output only sends signals from S-Video video source inputs to the TV. The RSP-1098 upconverts composite and S-Video signals to Component Video signals. Therefore, the Component Video output sends signals from any source input to the TV.*

When configuring the unit, you must specify either an NTSC or a PAL standard TV monitor. See the *Other Options* menu in the *Setup* section of this manual.

Amplifiers and Powered Subwoofers

To hook up a powered subwoofer, connect a standard RCA audio cable from either the two PREOUT jacks labeled SUB to the input on the subwoofer's power amp. Both SUB outputs provide the same signal.

To hook up amplifiers, connect an audio cable from each PREOUT jack to the input of the amplifier channel that will power the corresponding speaker. In a full home theater system, you will need to make five different connections in addition to the subwoofer. These connections are labeled FRONT L & R, CENTER, and REAR L & R. There are two CENTER jacks, use either jack for a single center channel or both if you have two center channels

In six or seven channel systems, you will make one or two additional connections for center back speaker(s). These jacks are labeled CB1 and CB2. Use CB1 for a single center back channel.

Make sure that you have each output connected to the correct amplifier channel (front right, left rear, etc.).

OPERATING THE RSP-1098

Considering its large number of features, settings, and options, the RSP-1098 is remarkably easy to operate. The key to operating the RSP-1098 is its system of On-Screen Displays (OSD) which guide you through various choices. These OSD menus can appear on the television monitor and/or on the front panel TFT color LCD screen.

The RSP-1098 can be operated from the front panel or the remote control. Front panel controls are unusually simple to use, with just a few knobs and buttons to guide you through OSD menu options. The remote control provides more complete control options.

To guide you through the operation of the RSP-1098, this section of the manual starts with explaining the basic layout and function of the front panel and the remote control. Then, we explain the basic operations such as turning the unit on and off, adjusting volume, selecting a source for listening, etc. Following that is a detailed explanation of surround sound modes and how to configure the RSP-1098 for various types of recordings. Finally, there are instructions for additional features and Zone 2 operations. All of these are features that may be used in normal use. The last section of the manual (Configuration) details options that may be selected during initial setup and configuration of the unit, many of which will be set once and left untouched.

Throughout this manual, numbers in gray boxes refer to the RSP-1098 illustration at the front of this manual. Letters refer to the RR-1050 remote illustration. When both appear, the function is found on both the RSP-1098 and the remote. When only one appears, that function is found only on the RSP-1098 or the remote.

Front Panel Overview

The following is a brief overview of the control and features on the front panel of the RSP-1098. Details concerning the use of these controls are provided in subsequent sections of this manual describing various tasks.

Color TFT Display **3**

In the center of the front panel is a large widescreen format TFT color LCD display. The display is used for two purposes: displaying OSD menus and as a built-in TV monitor for any composite video signal coming into the RSP-1098, making it ideal for navigating DVD menus, monitoring a remote camera, or just watching TV.

MENU button **10 J**

The MENU button toggles on or off the SYSTEM STATUS menu showing the current settings of the RSP-1098. Pressing the ENTER button on the remote (or the FUNCTION knob on the front panel) from the SYSTEM STATUS menu takes you to additional menus for configuring the RSP-1098's many options. See the *Setup* section of the manual for more detail on the OSD menus.

NOTE: *Turn off power to the front panel display by pressing and holding the MENU button.*

DISPLAY Button **9**

The DISPLAY button provides access to two settings for the front panel TFT screen and OSD menu displays: selecting a video source for display on the TFT screen and selecting whether OSD menus are displayed on the front panel TFT, the TV monitor, or both.

STANDBY Button **1**

The front panel STANDBY button activates or deactivates the unit. The rear panel master STANDBY button must be in the ON position for the remote standby function to operate.

VOLUME Knob **12**

The large knob at the right side of the front panel is the master VOLUME control, adjusting the output level of all channels simultaneously. In addition, it can be used to adjust the ZONE 2 volume.

MUTE Button **11** **I**

Push the MUTE button once to turn the sound off. An indication appears in the front panel and on-screen displays. Press the button again to restore previous volume levels.

NOTE: Rotating the volume knob also cancels the muting function.

FUNCTION Knob **5**

The large knob at the left side of the front panel is dual action control for navigating OSD menus. Rotate the control to the left or right to change settings on the menus. Push the knob to enter the new setting.

PATH Button **6**

The RSP-1098 can independently select sources for listening, recording, and use in a remote Zone 2 location. The PATH button toggles among listening, recording, and Zone 2 selection modes. In listening mode, input selection and volume adjustments change the main listening room. In Zone 2 mode, these adjustments change the remote zone. In recording (or Zone 3) mode, a source is selected for output to VCRs or other recorders.

SPEAKER Button **7**

During the setup of the RSP-1098, precise volume levels adjustments for each speaker are memorized for the proper playback of Dolby Digital and other surround sound formats. These default settings will be used each time you turn on the RSP-1098. The SPEAKER button on the front panel selects a speaker for temporary adjustments that remain in effect only until you change to a different input source or turn the RSP-1098 off. The actual adjustment is made with the FUNCTION knob.

The SPEAKER button can also be used to make a temporary adjustment to the group delay or "lip-synch" delay. Like the speaker settings, this is a temporary adjustment that overrides the permanent default setting for a video source until a different input source is selected or the unit is turned off.

MODE Button **8**

Although surround mode selection is generally automatic, the MODE button on the front panel can be used (with the FUNCTION knob) to temporarily override the default surround mode for a particular input. The available options depend on the type of source input (digital or analog) and the type of recording (Dolby Digital, DTS, PCM stereo, etc.)

Remote Sensor **4**

This sensor receives IR signals from the remote control. Do not block this sensor.

ZONE 2 LED **2**

A small LED in the upper left portion of the front panel lights when the remote ZONE 2 feature of the RSP-1098 is in use.

Remote Control Overview

The RSP-1098 includes a full-function learning remote control that can operate the RSP-1098 plus nine other audio/video components.

A separate manual gives detailed instructions on programming and using the RR-1050 to replace all of the remote controls in your system. The RR-1050 manual covers many extra features (such as custom labeling of remote buttons that appear in its LCD display). To avoid duplication, we provide only basic information about using the RR-1050 to operate the RSP-1098 in this manual.

Many of the RR-1050 functions duplicate the front panel controls. For that reason, we cover the controls on the remote under appropriate topics throughout this manual. Letters in gray boxes next to the name of a function refers to the labeled illustration of the remote at the front of this manual.

Using the RR-1050 AUDIO Button **A**

To operate the RSP-1098 with the remote, make sure that the AUDIO mode is active by pressing the AUD button on the remote before you start. If one of the other buttons (CD, TAPE, etc.) is pressed, the remote will control another component, not the RSP-1098. The AUDIO mode will stay active until another DEVICE/INPUT button is pressed.

Programming the RR-1050 PRELOAD Button **Q**

The RR-1050 is programmed at the factory to operate the RSP-1098. Should the AUDIO command set on your RR-1050 not operate the RSP-1098, the programming may have been inadvertently changed. To restore the RSP-1098 programming, press the recessed PRELOAD button on the remote with the tip of a ballpoint pen.

NOTE: Pushing the PRELOAD button will erase all custom programming and learned commands, restoring the RR-1050 to its factory condition.

MENU/OSD button **10** **J**

Push this button on the remote to turn on the OSD menu system. If the menu system is already visible, push this button to cancel the display.

The front panel TFT display can be turned off by pressing and holding the MENU/OSD button on the remote for three seconds. Briefly press the MENU/OSD button again to turn the display back on. The display also turns back on whenever the STANDBY button on the front panel or remote is pressed.

ENTER Button **K**

The ENTER button is used to confirm and memorize various settings in the setup and operation of the RSP-1098. Its use is described in detail in the relevant sections.

ON/OFF Buttons **G**

The power ON and OFF buttons on the remote provide discrete ON and OFF commands to activate the unit or put it in standby mode. The rear panel master POWER switch must be in the ON position for the remote standby function to operate.

POWER Button **R**

The POWER button on the remote provides the same basic function as the ON/OFF buttons, except in a conventional toggle format. Press the button once to activate the unit; press again to put the unit into standby mode.

VOLUME Button **H**

The large rocker button is the master VOLUME control, adjusting the output level of all channels simultaneously.

MUTE Button **I1 I2**

Push the MUTE button once to turn the sound off. An indication appears in the front panel and on-screen displays. Press the button again to restore previous volume levels.

NOTE: Pressing the volume buttons on the remote also cancels the muting function.

DEVICE/INPUT Buttons **A**

The ten buttons at the top of the remote have two functions:

Short press: A short press of any button changes the device that the remote operates, but does not change the RSP-1098's input selection.

Long press: A longer press changes the remote control device and changes the RSP-1098 source input for listening/viewing in the main room.

NOTE: A long press of the EXT button changes the input to the 7.1 channel analog MULTI INPUT. Pressing the AUD button only changes the remote device; there is no input source associated with this button.

REC Button **D**

Press this button before a long press of an DEVICE/INPUT button to select a source for recording. The signal from the selected source appears the TAPE OUT connectors.

ZONE Button **M**

Press this button before a long press of an DEVICE/INPUT button to select a source for ZONE 2.

UP/DOWN Buttons **L**

This pair of buttons is used to move the cursor up or down to select lines in the OSD menus. These buttons are also used in conjunction with the TONE button to make CONTOUR/TONE adjustments.

+/- Buttons **C**

This pair of buttons is used to change settings on a selected line in the OSD menus. Also used for selecting options in some surround modes.

Speaker Selection Buttons **B**

These three buttons are used to select a speaker or group of speakers for temporary level adjustments.

EQ Button **E**

This button is used to turn on and off the Cinema EQ feature, a high-cut filter useful for older movie soundtracks.

TONE Button **P**

This button is used in setting the Contour adjustments. It toggles between high frequency (HF) and low frequency (LF) modes. Once a mode is selected, the UP/DOWN buttons are used to make the adjustments.

Surround Mode Buttons **O**

Five buttons on the remote (2CH, PLC, PLM, 5CH, 7CH) allow direct selection of certain surround modes: 2-channel stereo, Pro Logic II Cinema, Pro Logic II Music, 5-channel stereo, or 7-channel stereo. The function of these buttons varies depending on the type of recording being played. See the *Manually Selecting Surround Modes* section for detailed information.

SUR+ Button **N**

This button is used in conjunction with the +/- buttons for manual selection of surround modes and features. See the *Manually Selecting Surround Modes* section for information.

DYN Button **F**

Used for selecting the dynamic range control setting in Dolby Digital surround mode.

Basic Operations

This section covers the basic operating controls of the RSP-1098 and the remote.

Power and Standby On/Off

I G R

The rear panel POWER switch on the RSP-1098 is a master power switch. The button must be pressed IN for the unit to operate. When it is in the OUT position, the unit is fully off and cannot be activated from the front panel or remote control.

The STANDBY button on the front panel, the discrete ON/OFF buttons on the remote, and the POWER button on the remote function as a standby switches, activating or deactivating the unit. In standby mode, minimal power is supplied to the microprocessor. When the unit has AC power applied and the rear panel POWER switch is on, the front panel STANDBY LED lights, regardless of whether the unit is in standby mode or activated in the main room.

In normal operation, the rear panel POWER switch is always left in the ON position and the RSP-1098 is activated and deactivated using the front panel STANDBY button or the remote ON/OFF buttons or the remote POWER button. The ON/OFF buttons and the POWER button on the remote provide essentially the same function with the ON/OFF buttons providing discrete ON and OFF commands while the POWER button provides a standard toggle on/off function.

When using the Zone 2 capability of the RSP-1098, the standby activation is completely independent for the main room and Zone 2. ON/OFF commands sent from the remote in the main room will not effect Zone 2. Pressing the ON/OFF buttons on a remote located in Zone 2 will only effect that zone and not the main room. When the unit is activated in ZONE 2, the ZONE 2 LED on the front panel is lit.

There are three available power mode options, which may be useful in configuring the RSP-1098 for special system configurations. See the *Other Options* menu in the *Setup* section of this manual for additional details on changing the default standby behavior.

Volume Adjustments **12** **H**

The listening volume of the RSP-1098 can be adjusted from the front panel or the remote.

Front Panel: Rotate the front panel VOLUME knob clockwise to increase the volume, counterclockwise to decrease.

Remote: Press the VOL UP button to increase the volume; press the VOL DOWN button to decrease.

When you adjust the volume, the setting is shown on the TV monitor and/or the front panel TFT display. The current volume setting is also shown on the SYSTEM STATUS OSD screen.

NOTE: The front panel VOLUME control can be used to change the volume in Zone 2. Press the front panel PATH button three times to change from the LISTENING to the ZONE 2 control mode as shown by the OSD and/or TFT display. Turning the VOLUME knob will then adjust the volume setting for ZONE 2. After 5 seconds, the PATH setting and VOLUME control revert to normal LISTENING mode operation.

Muting the Sound **11** **I**

The volume of the RSP-1098 can be turned off or muted. Push the MUTE button on the front panel or the remote once to turn the sound off. A MUTE indication appears in the OSD and/or TFT displays. Press the MUTE button again to restore previous volume levels.

NOTE: If the TFT screen and TV monitor are turned off, muting the sound gives no visual indication, creating a false impression that the RSP-1098 is not working correctly.

Display Options **3** **9**

The front panel DISPLAY button provides access to two settings of the front panel TFT screen and OSD menu displays: selecting a video source for display on the TFT screen and selecting whether OSD menus are displayed on the front panel TFT screen, the TV monitor, or both.

- **To view a video source on the TFT screen:** press the DISPLAY button once. Then, rotate the FUNCTION knob to select a source. Available display options are VIDEO 1–5, SOURCE (the same source selected for listening), or no video display.
- **To change the OSD setting:** press the DISPLAY button two times. Then, rotate the FUNCTION knob to select an OSD option. Available options are to view OSD menus on the TFT/LCD screen, the TV monitor, or both.
- **To shut off power to the TFT screen:** press and hold the MENU/OSD button on the remote or the MENU button on the front panel for 3 seconds.

Selecting Inputs

Up to three audio sources and five audio/video sources (Tuner, CD, DVD, VCR, etc.) can be connected to the RSP-1098. Any of these sources can be independently selected for listening/viewing in the main room, for recording, or for listening/viewing in a remote Zone 2 location.

The OSD and/or TFT displays show the name of the current source selection as it is made. The labels for all input sources can be customized to match your components.

All of the source inputs can be customized using the OSD configuration menus to accept either analog signals or digital signals from one of the eight assignable digital inputs. When a digital input is assigned, the RSP-1098 checks for the presence of a digital signal at that input. If a digital signal is present when the source is selected, it is automatically activated and the proper surround mode enabled. If no digital signal is present, the analog inputs for that source are selected. This auto-sensing is the preferred configuration for digital source inputs such as DVD players. When an ANALOG

input is assigned, the unit will not access a digital signal, even though one may be available at the digital input.

By default, the source DEVICE/INPUT buttons are factory configured to select the following inputs:

CD:	Analog input
Tuner:	Analog input
Tape:	Analog input
Video 1:	Digital Coaxial 1
Video 2:	Digital Coaxial 2
Video 3:	Digital Coaxial 3
Video 4:	Digital Optical 1
Video 5:	Digital Optical 2

Each source input should be configured using the INPUT SETUP menu system to use the desired input type (analog or digital auto-sensing).

NOTE: In addition to selecting analog or digital signals, the configuration options also permit custom labeling and selection of a default surround mode for each of the eight inputs.

Selecting a Source Input from the Front Panel **6** **5**

Selecting a source input from the front panel is a two-step process. First choose whether you are changing the source for LISTENING in the main room, for RECORDING, or for ZONE 2. Then, select the desired source.

To select a source for LISTENING:

1. Press the PATH button one time for LISTENING selection.
2. Rotate the FUNCTION knob to cycle through the list of sources until you reach the desired source.

To select a source for RECORDING:

1. Press the PATH button two times for RECORDING selection.
2. Rotate the FUNCTION knob to cycle through the list of sources until you reach the desired source.

Selecting the "SOURCE" option links the listening source to the record outputs, recording whatever listening source is selected now or in the future for recording.

NOTE: See the section on Zone 2 operations for details of selecting a source for the remote zone.

Selecting a Source from the Remote **A D M**

To select a source for LISTENING in the main room: press and hold one of the DEVICE/INPUT buttons for more than one second. To select the MULTI INPUT, press the EXT button.

NOTE: A short press of a DEVICE/INPUT button changes the remote control device only, but does not change the source input.

To select a source for RECORDING: Press the REC button and then press one of the DEVICE/INPUT buttons within 5 seconds.

Alternatively, you can press the REC button and then use the +/- buttons to scroll through the available source options. Select any input (CD, TUNER, TAPE, or VIDEO 1–5). Selecting the SOURCE option links the recording source to the input selected for main room listening. Whatever input is selected for listening is also sent to the record outputs.

To select a source for Zone 2: Press the ZONE button and then press one of the DEVICE/INPUT buttons within 5 seconds.

Alternatively, you can press the ZONE button and then use the +/- buttons to scroll through the available source options. Select any input (CD, TUNER, TAPE, or VIDEO 1–5). Selecting the SOURCE option links the Zone 2 source to the input selected for main room listening. Whatever input is selected for the main room is also sent to the Zone 2 outputs.

Overview of Surround Formats

To get the best performance from your RSP-1098, it helps to understand the many surround sound formats available today, to know which decoding process to use for a particular recording, and how to select it. This section provides basic background information about surround sound formats. The following sections provide detailed operating instructions for automatic and manual selection of surround modes.

Dolby Surround Dolby Pro Logic II

The most widely available surround sound format for consumer audio/video is Dolby Surround®, available on nearly all commercial VHS tapes, many television broadcasts, and most DVDs. Dolby Surround is the consumer version of the analog Dolby Stereo system first introduced in the film industry in 1972. It is a matrix-encoding system that records front left, front center, front right, and a mono surround channel into a 2-channel stereo recording. During playback, a Dolby Pro Logic® or Pro Logic II decoder extracts each channel and distributes it to the appropriate speakers.

The original Dolby Pro Logic decoder delivered a mono signal with reduced high-frequency content to the surround speakers. A more advanced decoder in the RSP-1098, Dolby Pro Logic II, increases the separation and frequency response of the surround channels for significantly improved performance with Dolby Surround encoded recordings.

Dolby Pro Logic II decoding should be used for any analog recording labeled “Dolby Surround” or any Dolby Digital 2.0 soundtrack. Dolby Pro Logic II does a superb job deriving surround sound from conventional 2-channel stereo recordings, using phase relationships to extract front, right, center, and surround channels. A “music mode” makes Pro Logic II an excellent choice for audio CDs.

Dolby Digital

In 1992, a digital recording system, called Dolby Digital, was first used in the film industry. Dolby Digital is a recording/playback system that uses compression techniques to store large amounts of audio data efficiently, much like the JPEG format stores large photographs in small files on a computer. Because it is capable of performance beyond that of audio CDs and can tailor its output for a wide range of system configurations, Dolby Digital is the standard audio format for DVDs and for digital television broadcasting in the United States.

The Dolby Digital system can be used to record up to six discrete audio channels, but can also be used for fewer. For example, a Dolby Digital 2.0 soundtrack is a digital 2-channel recording of a matrix encoded Dolby Surround soundtrack. To play a Dolby Digital 2.0 recording, use Dolby Pro Logic II decoding as previously described.

The most common use of Dolby Digital in newer films, in both the film industry and in home theater, is Dolby Digital 5.1. Instead of encoding multiple surround channels on a two-channel recording, Dolby Digital 5.1 records six discrete channels: front left, front center, front right, surround left, surround right, and a Low Frequency Effects (LFE) channel containing ultra-low bass signals intended for a subwoofer. A Dolby Digital decoder extracts the channels from the digital bitstream, converts them to analog signals and routes them to the appropriate amplifiers and speakers. All channels provide full frequency response with total separation between all channels and large dynamic range capability. A Dolby Digital 5.1 soundtrack can provide more impressive surround sound than matrix Dolby Surround.

Decoding of Dolby Digital 5.1 soundtracks is automatic. When the RSP-1098 detects a Dolby 5.1 signal on one of its digital inputs, it activates the proper processing. Keep in mind that Dolby Digital is only available from digital sources (a DVD, a LaserDisc, or a Digital TV/Cable/SAT tuner). Also, you must connect the source with a digital cable (coax or optical) to an active digital input on the RSP-1098.

NOTE: Many DVDs have a Dolby Digital 2.0 matrix soundtrack as the default, which should be decoded with Pro Logic II. The Dolby Digital 5.1 soundtrack may have to be selected as an option from the setup menus at the beginning of the DVD. Look for a Dolby Digital 5.1 selection under “Audio” or “Languages” or “Setup Options” when you insert the disc.

DTS 5.1 DTS 96/24

DTS® (Digital Theater Systems) is an alternative digital format competing with Dolby Digital in both movie theaters and home theater markets. The basic functions of the DTS system are similar to those of Dolby Digital (for example, 5.1 discrete channels), however the technical details of the compression and decoding processes differ somewhat and a DTS decoder is required.

A recent extension of the DTS encoding system is DTS 96/24. These recordings provide the performance of a 96kHz sampling rate while still using actual 48kHz sampling rate of standard DTS discs.

Like Dolby Digital, DTS can only be used on a digital recording and, therefore, is only available for home use on LaserDiscs, DVDs, or other digital formats. To use the RSP-1098's DTS decoder, you must connect your DVD player to the RSP-1098's digital inputs.

As with Dolby Digital 5.1, detection and proper decoding of DTS 5.1 signals is automatic.

NOTE: DVDs with a DTS soundtrack almost always have it configured as an option to the standard matrix Dolby Surround format. To use DTS, you may have to go to the setup menus at the beginning of the DVD and select "DTS 5.1" instead of "Dolby Surround" or "Dolby Digital 5.1". In addition, many DVD players have the DTS digital bitstream turned off by default and cannot output a DTS soundtrack (even if selected on the disc's menu) until you activate the player's DTS output. If you hear no sound the first time you attempt to play a DTS disc, go to the DVD player's configuration menus and turn on the DTS bitstream. This is a one-time setting and need only be done once.

DTS Neo:6

The RSP-1098 features a second type of DTS surround sound decoding: DTS Neo:6. This decoding system is similar to Dolby Pro Logic II and is designed for playback of any 2-channel stereo recording, either matrix-encoded or not. The Neo:6 decoder can be used with any conventional 2-channel source such as a stereo TV or FM broadcast or a CD. It can also be used as an alternative method of decoding matrix-encoded Dolby Surround recordings or TV broadcasts. Activate the DTS Neo:6 decoding with the DTS Neo:6 button as detailed later in this section. DTS Neo:6 is not used with DTS 5.1 digital sources and the button need not be pressed for those recordings.

6.1 and 7.1 Surround

In 1999, the first Dolby Digital soundtrack was released to theaters with an additional center back surround channel, intended to increase the directional effects from behind the audience. This additional surround channel is encoded into the two existing surround channels in Dolby Digital 5.1, using a matrix encoding process similar to that used previously in Dolby Surround. This new extended surround capability is called Dolby Digital Surround EX.

DTS has added a similar capability for recording this extended surround information called DTS-ES® 6.1 Matrix. They have also taken it one step further and developed the capability to record this extended surround information as a discrete channel in a system called DTS-ES® 6.1 Discrete.

All of these systems are extensions of the existing Dolby Digital 5.1 and DTS 5.1 digital surround sound formats. Users with one center back speaker (a 6.1 configuration) or two center back speakers (a 7.1 configuration) can take advantage of this extended surround information. On traditional 5.1 channel systems, Dolby Digital Surround EX or DTS-ES 6.1 discs sound exactly the same as 5.1 channel discs in each respective format.

If you have configured your system with one or two center back speakers, decoding of DTS-ES discs is automatic, just as it is with standard DTS soundtracks. Likewise, decoding of Dolby Digital Surround EX discs is automatic with one exception. Some Surround EX titles do not have the detection "flag" encoded on the disc. To activate the Dolby Digital Surround EX features for these discs (or for standard 5.1 channel Dolby Digital discs), you must manually activate Dolby Surround EX processing.

The RSP-1098 also features Rotel XS (eXtra Surround) processing that automatically ensures optimum extended surround performance on 6.1 and 7.1 channel systems. The key benefit of Rotel XS is that it works at **all** times with **all** multichannel digital signals, even those that might not otherwise activate Dolby Digital EX or DTS-ES surround decoding for the center back channel(s). Always available when center back speaker(s) are configured in the system setup, Rotel XS decodes the surround channels and distributes the extended surround channels to the center back speaker(s) in a way that tends to create a diffuse surround effect. Rotel XS works with matrix-encoded surround signals (such as non-flagged DTS-ES and Dolby Surround EX discs) as well as digital source material that is not Dolby Surround EX encoded (such as DTS 5.1, Dolby Digital 5.1, and even Dolby Pro Logic II decoded Dolby Digital 2.0 recordings).

DSP Music Modes

Unlike all of the formats mentioned above, the RSP-1098 offers four surround modes that not part of a specific recording/playback system. These modes (MUSIC 1–4) use digital signal processing that adds special acoustic effects to any signal. DSP processing can be used with Dolby Surround recordings, Dolby Digital recordings, CDs, radio broadcasts, or any other source material; however, typically DSP settings would be used with source material for which there is no specific surround decoder.

The four MUSIC MODES in the RSP-1098 use digital delay and reverberation effects to simulate progressively larger acoustic environments with MUSIC 1 being the smallest type of venue (such as a jazz club) and MUSIC 4 being a large venue (such as a stadium). Typically used to add ambience and a sense of space when listening to music sources or other sources that lack surround sound encoding.

2Ch/5Ch/7Ch Stereo Formats

The RSP-1098 also provides four modes that disable all surround processing and deliver stereo signals to amplifiers and speakers. There are three options:

2CH Stereo: Turns off the center channel and all surround channels in the system and delivers a conventional 2-channel signal to the front speakers. If the system is configured to route bass signals from the front speakers to the subwoofer, this capability remains in effect.

Analog Bypass: For 2-channel analog inputs, there is a special stereo mode that bypasses ALL of the RSP-1098's digital processing. The two front speaker receive pure analog stereo full-range signals with no subwoofer crossover, no delay, no level adjustments, and no contour adjustment.

5CH Stereo: Distributes a stereo signal to 5.1 channel systems. The left channel signal is sent, unchanged, the front left and surround left speakers. The right channel is sent to the front right and surround right speakers. A mono sum of the two channels is sent to the center channel speaker.

7CH Stereo: This mode is the same as 5CH Stereo described above except that it also distributes stereo signals to center back speaker(s) installed in the system.

Other Digital Formats

Several other digital formats are not surround sound formats at all, but rather systems for digital 2-channel recordings.

PCM 2-channel: This is an uncompressed 2-channel digital signal such as that used for standard CD recordings and some DVD recordings, particularly of older films.

HDCD®: This system uses higher bit rates a variety of enhancements to improve the sonic performance compared to standard audio CDs. These discs, labeled HDCD, can be played on standard CD players. However, when the digital signal is decoded using an HDCD decoder like that in the RSP-1098, they will provide exceptional musical reproduction.

DTS Music 5.1 Discs: These discs are a variation of audio CDs that include a DTS 5.1 channel recording. The RSP-1098 decodes these discs just like a DTS movie soundtrack when played on a CD player or DVD player with a digital output connection.

DVD-A music discs: Taking advantage of the increased storage capacity of the DVD disc, new high bit rate multichannel audio recordings are available on DVD-A discs. DVD-A discs may include multiple versions of the recording including standard PCM stereo, Dolby Digital 5.1, DTS 5.1, and 96kHz/24 bit (or higher) multichannel recordings using MLP compression. Several of these formats (standard PCM, Dolby Digital, and DTS 5.1) can be decoded by the RSP-1098 when the DVD player is connected with a digital cable. However, the existing optical and coax digital connection standard does not provide sufficient bandwidth for multichannel high sampling rate MLP recordings. Therefore, DVD-A discs with these high-resolution audio soundtracks must be decoded by a the DVD player and the resulting analog signals sent to the RSP-1098's MULTI INPUT.

SACD®: This is a proprietary high-resolution audio standard for use on SACD compatible disc players. As with high-resolution DVD-A discs, the bandwidth is too high for today's digital connection. Thus, these discs must be decoded by SACD compatible player, with the output sent to the RPS-1098's MULTI INPUTS.

MP3: The RSP-1098 also features a decoder for the digital MP3 (MPEG1- Audio Layer 3) compression format. MP3 format recordings are available on the Internet and can be played on portable MP3 players or some disc players that can read CD-ROM discs connected to the RSP-1098's digital inputs.

MPEG Multichannel: The RSP-1098 can decode MPEG Multichannel digital recordings. Widely used in Europe, this format uses MPEG data compression to record up to 5.1 channels of discrete digital audio, similar in function to the Dolby Digital and DTS formats.

Automatic Surround Modes

Decoding of digital sources connected to the digital inputs is generally automatic, with detection triggered by a "flag" embedded in the digital recording telling the RSP-1098 what decoding format is required. For example, when Dolby Digital 5.1 or DTS 5.1 channel surround is detected, the RSP-1098 activates the proper decoding.

The unit will also detect DTS-ES Matrix 6.1 or DTS-ES Discrete 6.1 discs and activate DTS-ES® Extended Surround decoding. Dolby Digital Surround EX recordings also trigger automatic decoding (although not all Surround EX DVDs have the necessary flag and may require manually activating Surround EX decoding). Likewise, a digital input from an HDCD® encoded compact disc, a standard CD, a DTS 96/24 disc, or MP3 player will be auto-detected and properly decoded to 2CH stereo operation.

Rotel XS processing is automatically active in all systems configured with center back speaker(s) and will ensure proper extended surround decoding of all multichannel digital signals, even those that might not otherwise trigger the proper extended surround mode.

In many cases, the RSP-1098 will also recognize a digital signal with Dolby Surround encoding (such as the default soundtrack on many DVDs) and activate Dolby® Pro Logic II® decoding.

NOTE: A digital signal coming into the RSP-1098 will be recognized and properly decoded. However, on a DVD with multiple soundtracks, you must tell the DVD player which one to send to the RSP-1098. For example, you may need to use the DVD's menu system to select the Dolby Digital 5.1 or DTS 5.1 soundtrack rather than the default Dolby Digital 2.0 Dolby Surround soundtrack.

Additionally, you can configure a default surround mode for each input using the INPUT SETUP menu (see the *Setup* section of this manual). Combined with the auto-detection of Dolby Digital 5.1 and DTS, this default surround setting makes operation of the RSP-1098 surround modes totally automatic. For example, if you set Dolby Pro Logic II movie mode as the default for all of your video inputs, the RSP-1098 will automatically decode Dolby Digital 5.1 and DTS soundtracks when they are played and use Pro Logic II matrix decoding for all other recordings. For stereo inputs such as CD and Tuner, you could select STEREO mode as the default for 2-channel playback or Dolby Pro Logic II music mode if you prefer to hear music sources in surround sound.

Manually Selecting Surround Modes

As described in the previous section, the combination of auto-detection of Dolby Digital and DTS recordings and setting default surround modes for each input during the setup of the RSP-1098 makes operation of surround modes totally automatic. For many users, this automatic surround mode selection will meet all of their listening needs.

For users who prefer a more active role in setting surround modes, buttons on the remote and the front panel provide manual selection of surround mode that are not automatically detected or, in some cases, to override an automatic setting.

Manual settings available from the front panel and/or the remote might be used when you want to play:

- Standard 2-channel stereo (left/right speakers only) with no surround processing
- Downmixed 2-channel playback of Dolby Digital 5.1 or DTS recordings
- Dolby 3-channel stereo (left/right/center) of 2-channel recordings.
- 5-channel or 7-channel stereo from 2-channel recordings
- One of four MUSIC modes for DSP concert hall simulation from 2-channel recordings
- Dolby Pro Logic II cinema or music mode matrix decoding of 2-channel recordings
- DTS Neo:6 cinema or music mode matrix decoding of 2-channel recordings
- Dolby Digital Surround EX decoding of Dolby Digital 5.1 channel recordings or Dolby Digital Surround EX discs that do not trigger automatic decoding.

NOTE: DTS, DTS-ES Matrix 6.1, DTS-ES Discrete 6.1, DTS 96/24, Dolby Digital, MP3, MPEG Multichannel, HDCD (96kHz), and PCM 2-channel (96kHz) digital signals are auto-detected and cannot be overridden. However, you can choose to use Dolby Digital Surround EX decoding for any Dolby Digital 5.1 source material. You can also downmix Dolby Digital 5.1 or DTS 5.1 recordings for 2-channel playback.

- HDCD (non 96kHz) and PCM 2-channel (non 96kHz) digital signals can be overridden to Dolby Pro Logic II, Dolby 3-Stereo, DTS Neo:6, Music 1 – 4, 5CH Stereo, 7CH Stereo, and Stereo.
- Dolby Digital 2-channel Stereo can be overridden to Dolby Pro Logic II, Dolby 3-Stereo, and Stereo.

The following topics describe in detail the manual surround mode options available for each type of recording

Dolby Digital 5.1 Dolby Digital Surround EX

Dolby Digital decoding is auto-detected and cannot be overridden. You may, however, select a 2 channel downmix of 5.1 channel recordings. If the system is configured with center back speaker(s), you can also force Dolby Surround EX processing on or off.

NOTE: In addition to the options that follow, you can press the 2CH button on the remote to toggle between 2-channel downmix and multichannel playback.

- **On a 5.1 system.** Press the SUR+ button on the remote, then press the +/- buttons to change between DD 5.1 channel or DD 2.0 channel downmix playback. On the front panel, press the MODE button once, then rotate the FUNCTION knob to select 2.0 or 5.1 channel playback.
- **On a 6.1/7.1 system with a Dolby Digital 5.1 disc.** Press the SUR+ button on the remote, then use the +/- buttons to step through four options: DD 5.1 channel, DD 2.0 channel downmix, DD Surround EX center back processing, or DD with Rotel XS center back processing. On the front panel, press the MODE button while playing a Dolby Digital source. Then, rotate the FUNCTION knob to step through the same options. You should force Surround EX on for non-flagged discs that are labeled Dolby Digital Surround EX. Rotel XS processing of standard 5.1 channel discs will provide a more diffuse surround effect than the more highly localized Dolby EX decoding and will probably be the best 6.1 channel option for non-Surround EX discs.
- **On a 6.1/7.1 system with a Dolby Digital Surround EX disc.** Press the SUR+ button on the remote, then use the +/- buttons to step through three options: DD 5.1 channel, DD 2.0 channel downmix, or Surround EX center back processing. On the front panel, press the MODE button while playing a Dolby Digital source. Then, rotate the FUNCTION knob to step through the same options. Select the Surround EX option for 6.1 channel playback. Select the DD 5.1 option to force Surround EX off for standard 5.1 channel playback.

NOTE: When playing any Dolby Digital source, you can select one of three dynamic range control settings. See the Dynamic Range topic in the Other Settings section of this manual.

Dolby Digital 2.0

Dolby Digital decoding is auto-detected and cannot be overridden. You may, however, select a 2-channel playback, Pro Logic II matrix surround, or Dolby 3-Stereo playback.

- **To select 2-channel stereo, Pro Logic II, or 3-Stereo.** Repeatedly press the SUR+ button on the remote until the desired mode is displayed. On the front panel, press the MODE button once, then rotate the FUNCTION knob to select the desired mode.

NOTE: You can also direct select 2-channel stereo or Pro Logic II Cinema modes by pressing the 2CH or PLC buttons on the remote.

- **To select Cinema, Music, or Emulation option in Pro Logic II mode.** Press the +/- buttons on the remote to select the desired option. On the front panel, press the MODE button twice while in Pro Logic II mode. Then, rotate the FUNCTION knob to select the option.

NOTE: When playing any Dolby Digital source, you can select one of three dynamic range control settings. See the Dynamic Range topic in the Other Settings section of this manual.

DTS 5.1 DTS 96/24 DTS-ES 6.1

DTS decoding is auto-detected and cannot be overridden. You may, however, select a 2 channel downmix of 5.1 channel recordings or add Rotel XS center back processing for 5.1 channel discs.

NOTE: In addition to the options that follow, you can press the 2CH button on the remote to toggle between 2-channel downmix and multichannel playback.

- **On a 5.1 system.** Press the SUR+ button on the remote, then press the +/- buttons to change between DTS 5.1 channel or DTS 2.0 channel downmix playback. On the front panel, press the MODE button once, then rotate the FUNCTION knob to select 2.0 or 5.1 channel playback.
- **On a 6.1/7.1 system with a DTS 5.1 or DTS 96/24 disc.** Press the SUR+ button on the remote, then use the +/- buttons to step through three options: DTS 5.1 channel, DTS 2.0 channel downmix, or DTS with

Rotel XS center back processing. On the front panel, press the MODE button while playing a DTS or DTS 96/24 source. Then, rotate the FUNCTION knob to step through the same options.

- **On a 6.1/7.1 system with a DTS-ES disc.** Press the SUR+ button on the remote, then use the +/- buttons to step through two options: DTS 2.0 channel downmix or DTS-ES 6.1ch/7.1ch playback. On the front panel, press the MODE button while playing a DTS source. Then, rotate the FUNCTION knob to step through the same options.

MPEG Multichannel

MPEG decoding is auto-detected and cannot be overridden. You may, however, select a 2 channel downmix of 5.1 channel recordings. If the system is configured with center back speaker(s), you can also force Rotel XS processing on or off.

NOTE: In addition to the options that follow, you can press the 2CH button on the remote to toggle between 2-channel downmix and multichannel playback.

- **On a 5.1 system.** Press the SUR+ button on the remote, then press the +/- buttons to change between MPEG 5.1 channel or MPEG 2.0 channel downmix playback. On the front panel, press the MODE button once, then rotate the FUNCTION knob to select 2.0 or 5.1 channel playback.
- **On a 6.1/7.1 system with an MPEG 5.1 disc.** Press the SUR+ button on the remote, then use the +/- buttons to step through three options: MPEG 5.1 channel, MPEG 2.0 channel downmix, or MPEG with Rotel XS center back processing. On the front panel, press the MODE button while playing an MPEG Multichannel source. Then, rotate the FUNCTION knob to step through the same options.

Digital Stereo (PCM, MP3, and HDCD)

This group of recordings includes any non-Dolby Digital 2-channel signal from the RSP-1098's digital inputs. You can play these recordings in 2-CH Stereo, Dolby 3-Stereo, 5-CH Stereo, 7-CH Stereo modes. You can also use Dolby Pro Logic II surround, DTS Neo:6 surround, or one of the MUSIC 1-4 DSP modes.

All of the bass management settings (speaker size, subwoofer, and crossover) are in effect with digital stereo inputs.

NOTE: In addition to the options that follow, you can select 2-channel, Pro Logic II Cinema, Pro Logic II Music, 5-channel stereo, or 7-channel stereo by pressing one of the surround mode buttons on the remote (2CH, PLC, PLM, 5CH, 7CH).

- **To select STEREO mode for 2-channel digital recordings.** Press the 2CH button on the remote.
- **To select any other mode for 2-channel digital recordings.** Repeatedly press SUR+ button on the remote until the desired mode is displayed. On the front panel, press the MODE button once, then rotate the FUNCTION knob to select the desired mode (including STEREO).
- **Select the Cinema, Music, or Emulation option in Pro Logic II mode.** Press the +/- buttons on the remote to toggle select the desired option. On the front panel, press the MODE button twice while in Pro Logic II mode. Then, rotate the FUNCTION knob to select the option.
- **Select the Cinema or Music option in Neo:6 mode.** Press the +/- buttons on the remote to toggle select the desired option. On the front panel, press the MODE button twice while in Neo:6 mode. Then, rotate the FUNCTION knob to select the option.

Analog Stereo

This type of recording includes any conventional stereo signal from the RSP-1098's analog inputs, including analog audio from CD players, FM tuners, VCRs, tape decks, etc.

Analog stereo inputs require a fundamental choice about how the signal is routed through the RSP-1098. One option is the analog bypass mode. In this mode, the stereo signal is

routed directly to the volume control and the outputs. It is pure 2-channel stereo, bypassing all of the digital circuitry. None of the bass management features, speaker level settings, contour settings, or delay settings are active. There is no subwoofer output. A full-range signal is sent directly to two speakers.

The other option converts the analog inputs to digital signals, passing them through the digital processors in the RSP-1098. This option allows all of the features to be active including bass management settings, crossovers, subwoofer outputs, contour settings, etc. In this mode, you can select several surround modes including 2-CH Stereo, Dolby 3-Stereo, 5-CH Stereo, 7-CH Stereo modes. You can also use Dolby Pro Logic II surround, DTS Neo:6 surround, or one of the MUSIC 1-4 DSP modes.

NOTE: In addition to the options that follow, you can select Pro Logic II Cinema, Pro Logic II Music, 5-channel stereo, or 7-channel stereo by pressing one of the surround mode buttons on the remote (PLC, PLM, 5CH, 7CH).

- **To select Stereo or Analog bypass mode for 2-channel analog recordings.** Press the 2CH button on the remote to toggle between Stereo (with digital processing) or Analog Bypass (no digital processing) modes.
- **To select other modes for 2-channel analog recordings.** Repeatedly press SUR+ button on the remote until the desired mode is displayed. On the front panel, press the MODE button once, then rotate the FUNCTION knob to select the desired mode (including Stereo and Analog Bypass).
- **Select the Cinema, Music, or Emulation option in Pro Logic II mode.** Press the +/- buttons on the remote to toggle select the desired option. On the front panel, press the MODE button twice while in Pro Logic II mode. Then, rotate the FUNCTION knob to select the option.
- **Select the Cinema or Music option in Neo:6 mode:** Press the +/- buttons on the remote to toggle select the desired option. On the front panel, press the MODE button twice while in Neo:6 mode. Then, rotate the FUNCTION knob to select the option.

Other Settings

Temporary Speaker Level

B L 5 7

The levels of all channels should be calibrated using the TEST TONE procedure during the initial setup of the RSP-1098. You can make a temporary change in the relative volume of the center, surround, center back, or subwoofer channels using buttons on the remote control or the front panel controls. These temporary adjustments only remain in effect until a different input is selected or until the RSP-1098 is turned off.

To adjust speaker levels using the remote:

1. Press a selection button on the remote to select a channel (or pair of channels) for adjustment. Press the C button to adjust the CENTER channel. Press the S button to adjust the SUBWOOFER channel. Press the R button to adjust the rear SURROUND or CENTER BACK channels (each press of the R button toggles between the SURROUND channels and the CENTER BACK channels). The selected speaker and its current setting appear briefly in the display.
2. Use the UP or DOWN buttons on the remote to adjust the output level of the selected channel(s).

To adjust speaker levels from the front panel.

1. Press the SPEAKER button repeatedly until the desired speaker or group of speakers is displayed.
2. Rotate the FUNCTION knob to change the level of the selected speaker.

NOTE: If no level adjustment is made for 5 seconds, the levels revert to the default calibrated settings.

As you select a speaker in the above adjustments, you may notice an addition choice, "group delay". See the following for an explanation of this feature.

Temporary Group Delay

B L 5 7

The SPEAKER adjustments (described above) can also be used to make a temporary adjustment to the group delay or "lip-synch" delay. Group delay delays the overall audio signal (to all speakers) by a specified amount to correct for situations where the video and audio signals are out of synch. This can occur with upconverted digital TV signals or when trying to match a radio broadcast with the video from a sports event. The settings range from 0 to 500 milliseconds in 5 ms increments.

Like the speaker settings, this is a temporary adjustment that overrides the permanent default setting for a video source until a different input source is selected or the unit is turned off.

To adjust group delay using the remote:

1. Press the C button on the remote twice.
2. Use the UP or DOWN buttons on the remote to adjust the amount of delay applied to all channels.

To adjust the group delay from the front panel:

1. Press the SPEAKER button repeatedly until you reach the GROUP DELAY option.
2. Rotate the FUNCTION control to adjust the amount of delay applied to all channels.

Dynamic Range **F 5 8**

Dolby Digital recordings are capable of wide dynamic range (the difference between the softest and loudest sounds). In some cases, this may tax amplifiers and/or speakers. In other cases, you may want to reduce the dynamic range when listening at low volume levels. This is particularly useful in order to keep dialog loud enough to be intelligible while avoiding excessively loud sound effects. Dolby Digital dynamic compensation is a sophisticated feature that allows you to adjust the dynamic range while still preserving fidelity. The actual amount of compression relies on instructions embedded in the Dolby Digital recording and varies to best suit the specific program content.

There are three dynamic range settings available for Dolby Digital recordings:

MAX: full dynamic range

MID: slightly reduced dynamic range, roughly comparable to the signal from a compact disc

MIN: more heavily reduced dynamic range, but still comparable to the signal from a typical VHS Hi-Fi recording.

To adjust dynamic range using the remote:

Press the DYN button repeatedly until the desired setting appears in the OSD/TFT screen. This setting remains in effect for all Dolby Digital program material until it is changed.

To adjust dynamic range from the front panel:

1. While playing a Dolby Digital source, press the MODE button twice
2. Rotate the FUNCTION control to select the dynamic range setting.

NOTE: The dynamic range compensation feature is only available in Dolby Digital mode. The setting is ignored with all other types of recordings.

Contour/Tone Settings **P L**

The contour adjustment (available only the remote control) changes the high or low frequency content at the frequency extremes. The settings can be adjusted up or down by a maximum of 6dB. Adjustments to the contour settings are permanent; they remain in effect until they are readjusted.

Changing the high frequency contour (HF) increases or decreases the treble. Changing the low frequency contour (LF) increases or decreases the bass content. The settings are shown on the OSD and/or TFT displays as you adjust them.

To adjust the contour settings:

1. Press the TONE button on the remote. Either LF or HF appears in the OSD/TFT displays, depending on which adjustment is currently active. Press the TONE button again to toggle to the other adjustment.
2. Press the UP/DOWN buttons on the remote to increase or decrease the setting. The display will revert to normal operation following several seconds of inactivity.

More extensive contour adjustments for all speakers or for any group of speakers (front, center, surround, etc.) can also be made from the *Contour Settings* OSD menu in the *Setup* section of this manual.

NOTE: The tone adjustments are available for all surround modes and inputs, except the *MULTI* input and analog bypass mode.

Cinema EQ **E**

The EQ button (remote only) activates or deactivates a special CINEMA EQ setting. This equalization may be desirable for playback of movie source material to compensate for the acoustic differences between a commercial cinema and a home theater environment by reducing the high-frequency content.

The EQ setting is independent for each source input. Using the button only changes the setting for the currently active source input.

Zone 2 Operation

The RSP-1098 provides Zone 2 multi-room capability, allowing you to enjoy music and operate the system from a second room. From the remote location, you can select a source component (independent from the source playing in the main room), adjust the volume level in the remote zone, and operate the source components.

To use the Zone 2 capability, you need additional components: a pair of speakers installed in the remote zone, an amplifier to drive them, an optional TV monitor for video signals, and a third-party IR repeater system.

Zone 2 can be controlled from the main room using RSP-1098's front panel PATH button. Operation from the remote zone requires the installation of an infrared repeater system (Xantech, Niles, etc.) which relays infrared remote control commands from Zone 2 to the ZONE REM IN connector on the back of the RSP-1098.

Several points to keep in mind about the Zone 2 function:

- There are two options for the Zone 2 output level, selectable from the OSD configuration menu. VARIABLE output provides full adjustment of the volume level. FIXED output disables the Zone 2 volume control with the output permanently set to a specified level.

This might be useful for sending a line level signal to a preamp or integrated amp with its own volume control or to a distribution amplifier with multiple volume controls.

- The RR-1050 remote control supplied with the RSP-1098 will operate Zone 2 if used with a repeater system from the remote zone. It can also be programmed to operate Rotel source components via the RSP-1098's IR OUT jack.
- Any source component connected to the RSP-1098's analog inputs can be sent to the Zone 2 outputs. ZONE 2 operates independently of the main room. You can select a different source or adjust Zone 2 volume without affecting the MAIN outputs in any way.
- Avoid sending the same infrared command to the RSP-1098 front panel sensor and a Zone 2 repeater at the **same** time. This means that Zone 2 **must** be in a different room from the RSP-1098.

Zone 2 Power On/Off Operation **G**

Once master power is applied to the unit by pressing the rear panel POWER switch button, the RSP-1098 provides independent power on/off operation for both zones. Pressing the remote control ON/OFF buttons in the main room activates or deactivates the RSP-1098 in the main room only and has no effect on Zone 2. Conversely, activating or deactivating Zone 2 has no effect on the main listening room. However, placing the rear panel master POWER switch in the OFF position completely shuts off the unit, for both zones.

NOTE: For proper power on and off operation with Zone 2, the RSP-1098's power mode should be set to the factory default *DIRECT* setting or to the *STANDBY* setting using the *Other Options* menu described in the *Setup* section of this manual.

Controlling Zone 2 from the Front Panel

You can control Zone 2 from the front panel of the RSP-1098 – activate or deactivate Zone 2, change input sources, and adjust the volume. Controlling Zone 2 from the front panel is accomplished by pressing the PATH repeatedly until ZONE 2 status information is displayed on the OSD and/or TFT screens. This temporarily puts the RSP-1098 in Zone 2 control

mode. When the Zone 2 status is displayed, the OSD and/or TFT screens show the current source selection and volume in Zone 2 for five seconds, during which time you can use the front panel VOLUME control and FUNCTION knob to change the ZONE 2 settings.

To change the Zone 2 input source:

1. Press the front panel PATH button repeatedly until the Zone 2 status appears in the OSD and/or TFT screen.
2. Within 5 seconds, rotate the FUNCTION knob to select a new source for Zone 2. The name of the selected source appears in the display. Selecting OFF instead of an input deactivates Zone 2.
3. Following 5 seconds with no commands, the RSP-1098 reverts to normal operation.

To change the Zone 2 volume:

1. Press the front panel PATH button repeatedly until the Zone 2 status appears in the OSD and/or TFT screen. Make sure that Zone 2 is ON.
2. Within 5 seconds, adjust the volume control to change the Zone 2 output level. The new setting appears in the display.
3. Following 5 seconds with no commands, the RSP-1098 reverts to normal operation.

Controlling Zone 2 from the Remote Location **G H A**

With a properly configured IR repeater system, you have full control of Zone 2 using an RR-1050 remote from the Zone 2 location. You can select and operate a source, adjust the volume, and turn Zone 2 on or off. Whatever commands you send from the RR-1050 will change Zone 2 and only Zone 2, just as if you were controlling a totally independent audio system in that room. These changes will have no effect on the main listening room.

To turn Zone 2 on or off, press the ON/OFF buttons on the remote. To adjust the volume in Zone 2, press the VOLUME buttons on the remote. To select a different analog input source, press one of the DEVICE/INPUT buttons on the remote.

NOTE: The volume adjustment is only available if the Zone 2 outputs are configured to use VARIABLE levels. With FIXED levels, the volume control for Zone 2 is disabled.

SETUP

The RSP-1098 features two types of information displays to help operate the system. The first consists of simple status displays that appear on the TV screen and/or front panel TFT screen whenever primary settings (Volume, Input, etc.) are changed. These status displays are self-explanatory.

A more comprehensive ON-SCREEN DISPLAY (OSD) menu system is available at any time by pressing the MENU/OSD button on the remote or the front panel MENU button. These OSD menu guide you through the configuration and setup of the RSP-1098. In general, the settings made in the configuration process are memorized as default settings and need not be made again for normal operation of the unit.

The OSD menus can be displayed on the TV monitor, the front panel TFT screen, or both. This selection can be changed using the DISPLAY OPTIONS menu later in this section.

NOTE: We recommend displaying the OSD menus on the TFT screen for system setup. The OSD menus will be available for display on the TFT screen, regardless of source input and video output connections and whether or not a source is actually playing.

The OSD menus can be configured to display several different languages. The default English version of all the menus is shown at the front of this manual. If your language is available, those menus will be shown in the following instructions. If you would like to change from the default English language before proceeding, go to the instructions for the OTHER OPTIONS menu later in this manual. From this menu, you can change the language display.

Menu Basics

Navigation Buttons

C J K L

The following remote control buttons are used to navigate the OSD menu system:

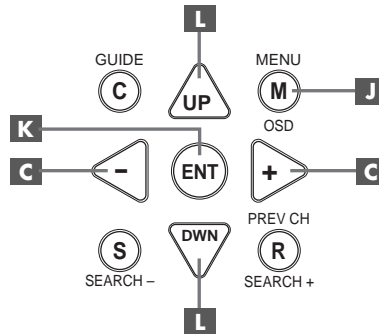

MENU/OSD button J : Press to display the SYSTEM STATUS screen. From the SYSTEM STATUS screen, press the ENTER button to display the MAIN MENU screen which has links to all other menus. If a menu is already visible, push this button to cancel the display. The MENU button on the front panel provides the same function.

DOWN/UP Buttons L : Press to move up and down in the lists of menu items that appear on the OSD screens.

+/- Buttons C : Press to change the current settings for a selected menu item on OSD screens.

ENTER Button K : From the SYSTEM STATUS screen, press ENTER to display the MAIN MENU screen. From any other OSD screen, press ENTER to confirm a setting and return to the MAIN menu.

System Status

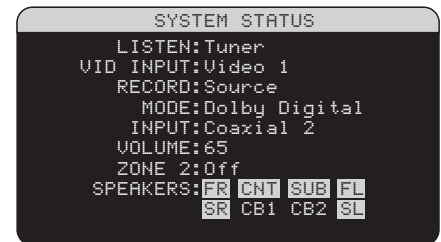

The SYSTEM STATUS menu provides a snapshot of the current system settings and a starting point for reaching all other screens and menus. This screen appears when you press the remote MENU/OSD or front panel MENU button and displays the following information:

LISTEN: the input source selected for listening.

VID INPUT: the video source selected for viewing. Can be VIDEO 1–5 or OFF (no video) as selected on the INPUT SETUP menu. Typically, the video source matches the audio from listening source; however a different video input can be selected.

RECORD: the source selected for recording from the VIDEO and AUDIO outputs.

MODE: the current surround sound mode.

INPUT: the input selected for the current source: Optical Digital, Coaxial Digital, Analog, etc.

VOLUME: the current volume setting.

ZONE: the current status of ZONE 2, ON or OFF.

SPEAKERS: highlights the speakers that are currently configured for the system (front right, center, subwoofer, front left, surround left, center back 1, center back 2, and surround right)

No changes can be made using this screen; it only provides information. To go to the rest of the menus, press the ENTER button to go to the MAIN menu. Press the MENU/OSD button on the remote to cancel the display and return to normal operation.

NOTE: The SYSTEM STATUS screen appears for five seconds when the unit is turned on and automatically turns off.

Main Menu

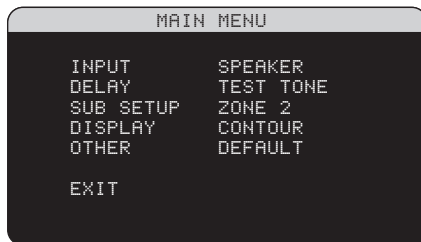

The MAIN MENU provides access to ten OSD screens for various configuration options. MAIN MENU is reached by pressing the ENTER button from the SYSTEM STATUS menu described above or from most other menus. To go to the desired menu, move the highlight using the UP/DOWN and +/- buttons on the remote and press the ENTER button. Press the MENU/OSD button on the remote to cancel the display and return to normal operation.

Display Options

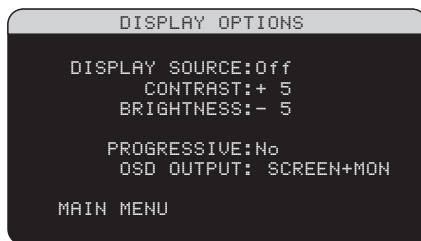

The DISPLAY OPTIONS menu provides access to settings for the front panel TFT screen: selecting a video source for display, picture quality adjustments, setting the progressive scan mode, and selecting whether OSD menus are displayed on the front panel TFT, the TV monitor, or both.

DISPLAY SOURCE: Select a video source (composite video only) for display on the TFT screen. Available display options are VIDEO 1–5, SOURCE (the same source selected for listening), or OFF no video display.

CONTRAST: Adjust the contrast (white level) of the TFT screen up or down.

BRIGHTNESS: Adjust the brightness (black level) of the TFT screen up or down.

PROGRESSIVE: The OSD menus cannot be displayed on the TV monitor when progressive scan or 1080i HDTV video signals are being used at the Component Video inputs. This setting enables a feature that allows the display of the main OSD setup menus (but not the information displays such as volume, etc)

on the TV monitor by interrupting the progressive scan video signal and restoring it after the OSD menus are cancelled. Choose the YES option for progressive scan or HDTV video signals (480p, 720p, 1080i) at the component video inputs. Choose the NO option if you are using standard interlaced video signals (480i).

NOTE: When the progressive mode is set to YES, the conversion from composite or S-Video to Component Video output is only available for the VIDEO 5 input, not for the VIDEO 1–4 inputs.

OSD OUTPUT: Select where the OSD menus are displayed: on the TFT screen only, the TV monitor only, or both. Available options are SCREEN+MON, SCREEN, and MONITOR.

Configuring Inputs

A key step in setting up the RSP-1098 is to configure each source input using the INPUT SETUP screens. Configuring the inputs allows you to set defaults for a number of settings including the type of input connector, the desired surround mode, custom labels that appear in the displays when a source is selected, and many more. The following OSD menus are used to configure the inputs.

Input Setup

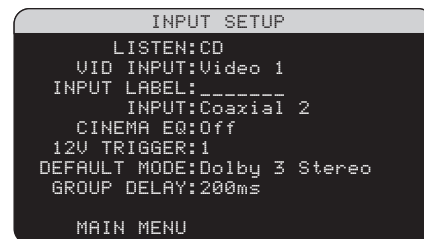

The INPUT SETUP menu configures the source inputs and is reached from the MAIN menu. The screen provides the following options, selected by placing the highlight on the desired line using the UP/DOWN buttons:

LISTEN: changes the current listening input source (CD, TUNER, TAPE, VIDEO1–5, & EXT). Changing this input also allows you to select a specific input for configuring.

VID INPUT: select the video source to be displayed on the TV monitor with the listening source specified on the first line. Can be VIDEO 1–5 or OFF (no video). Typically, the video source matches the audio from listen-

ing source; however a different video input can be selected. For audio only sources (such as a CD player), you would typically specify OFF so that no video is displayed.

INPUT LABEL: The seven-character labels for the all eight inputs can be customized. Place the highlight on this line to begin labelling. The first character in the label will be flashing.

1. Press the +/- buttons on the remote or rotate the FUNCTION knob on the front panel to change the first letter, scrolling through the list of available characters.
2. Press the ENT button on the remote or press the FUNCTION knob on the front panel to confirm that letter and move to the next position.
3. Repeat steps 1 and 2 until all seven characters (including blank spaces) have been completed. The final press of the ENT button saves the new label.

INPUT: assigns a physical input connection to use as the default for the source displayed in the first line of the menu. The options are ANALOG input, three OPTICAL digital inputs (OPTICAL 1–3), and five COAXIAL digital inputs (COAXIAL 1–5).

When a digital input is the default, the unit will check for a digital signal when the INPUT SOURCE is selected. If no digital signal is present, the unit will automatically revert to the analog input.

When an ANALOG input is the default, the unit will not access a digital signal, even though one may be present at the digital input; thus, the ANALOG setting forces the unit to use an analog signal. Assigning a digital input (with its auto-sensing) is generally the preferred configuration for any source with a digital output.

NOTE: If a source connected to a digital input is selected, that signal will automatically be sent to both digital outputs for recording.

CINEMA EQ: The RSP-1098 includes a CINEMA EQ feature which reduces the high-frequency content of movie soundtracks to simulate the frequency response of a large movie theater and/or eliminate sibilance. You can turn the CINEMA EQ on or off as the default setting for the selected input using this menu choice. In general, this setting should be OFF for most source inputs, unless you are consistently bothered by excessively bright sound from movie soundtracks.

12V TRIGGER: The RSP-1098 has four 12V trigger outputs (labeled 1, 2, 3, and ZONE2) that supply a 12V DC signal to turn on Rotel components and other components as needed. This menu item turns on specific 12V trigger outputs whenever the indicated source is selected. For example, you set up the VIDEO 1 input to turn on the 12V trigger for your DVD player. The options for this menu item are: 1/2/3/1+2/1+3/2+3/ALL/NO.

DEFAULT MODE: The DEFAULT MODE setting allows you to set a default surround sound mode for each source input. The default setting will be used unless the source material triggers automatic decoding of a particular type or unless the default setting is temporarily overridden by the front panel or remote surround mode buttons.

NOTE: Default surround modes are stored independently for the analog and digital inputs for each source.

Options for the default surround modes are: Dolby Pro Logic II, Dolby 3 Stereo, Music 1, Music 2, Music 3, Music 4, 5ch Stereo, 7ch Stereo, PCM 2 Channel, DTS Neo:6, Bypass (for analog input only), and Stereo.

NOTE: The following types of digital discs or source material are generally detected automatically and the proper decoding activated with no action or setting required: DTS, DTS-ES Matrix 6.1, DTS-ES Discrete 6.1, Dolby Digital, Dolby Digital Surround EX, Dolby Digital 2-channel, MPEG Multichannel, PCM 2-Channel, PCM 96kHz, MP3, HDCD, and HDCD 96kHz.

Since Dolby Digital 5.1 and DTS sources are detected and decoded automatically, the default setting typically tells the RSP-1098 how to process a 2-channel stereo signal. For example, you might have your CD input default to 2-channel stereo, DVD and VCR inputs default to Dolby Pro Logic II processing for matrix-encoded Dolby surround material, and TUNER input default to one of the MUSIC modes.

In some cases, the default setting can be manually overridden by the front panel MODE button or the SUR+ button on the remote. See the *Manually Selecting Surround Modes* section of this manual for more information on which settings can be overridden.

Two of the default surround mode settings available on this menu offer additional choices. Dolby Pro Logic II decoding offers a choice of CINEMA, MUSIC, or EMULATION settings. DTS Neo:6 decoding offers a choice of CINEMA or MUSIC settings. When either Dolby Pro Logic II or DTS Neo:6 is selected with this menu item, the current setting choice will also be displayed. In addition, the function of the ENTER button changes, taking you to a submenu where you can change the settings and/or additional parameters for Dolby Pro Logic II or DTS Neo:6 decoding. See the following section for details.

GROUP DELAY: Also known as "lip-sync" delay, this setting delays the audio signal for an input by the specified amount to match the video input. This feature can be useful when the video signal is delayed more than the audio signal as sometimes happens with upconverted digital TV processors or when trying to match a radio broadcast with the video from a sports event.

The range of available settings is from 0ms to 500ms, in 5ms increments. The setting is individually stored for each input and is the default group delay each time that input is selected. The setting can be temporarily overridden from the front panel or the remote.

OPTIONS: This selection is only visible when Pro Logic II or Neo:6 surround mode is selected. Highlight this line and press ENTER to go to submenus with additional options for these surround modes. See below.

To return to the MAIN menu from the INPUT SETUP menu (except when Dolby Pro Logic II or DTS Neo:6 is selected in the SURR MODE field), press the ENTER button. Press the MENU/OSD button on the remote to cancel the menu display and return to normal operation.

Multi Input Setup

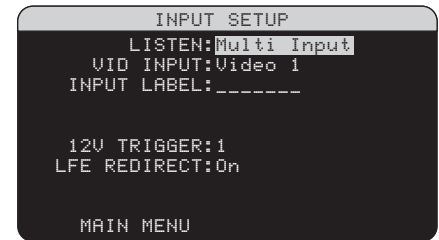

When the MULTI INPUT source is selected on the INPUT SETUP menu, the available options change to reflect the fact that these inputs are direct analog inputs and bypass the RSP-1098's digital processing. The INPUT, CINEMA EQ, and DEFAULT MODE options are not available since these are all digitally implemented features.

The VID INPUT, INPUT LABEL, and 12V TRIGGER options are still available and work as described on the previous menu.

One additional option, LFE REDIRECT, provides an alternative bass management configuration. Typically, the eight channels of the MULTI INPUT are configured as pure analog bypass signals, going straight from the inputs to the volume control and the preamp outputs, bypassing all of the digital processing. There are no crossovers and no bass management; therefore, whatever signal goes into the subwoofer channel will be sent to the subwoofer preamp output.

This configuration may not be ideal for multi-channel systems configured with high-pass speakers, redirecting bass to a powered subwoofer. An option, called LFE REDIRECT, sends the seven main channels directly to the outputs as usual. In addition, it takes a duplicate copy of these seven channels, combines them into mono, and routes them through a 100 Hz analog low-pass crossover to the subwoofer preamp output. This creates a summed mono subwoofer signal, derived from the seven main channels of the MULTI INPUT.

Use the LFE REDIRECT off for the pure analog bypass configuration. Use the LFE REDIRECT on setting to derive the mono summed subwoofer output.

Dolby Pro Logic II

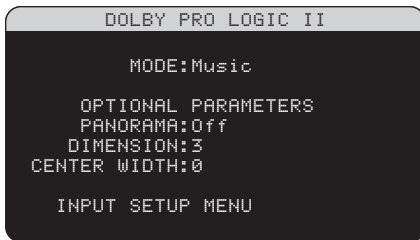

When Dolby Pro Logic II is selected as the default surround mode on the INPUT SETUP menu, there are additional settings and parameters to optimize the surround decoding for music or movie soundtracks. Dolby Pro Logic II uses matrix decoding algorithms to derive a center channel and surround channels from 2-channel source material.

The first line of the Dolby Pro Logic II sub-menu selects one of three types of matrix decoding: CINEMA, MUSIC, or EMULATION modes. Use the +/– buttons on the remote to select a mode.

Select **CINEMA** to optimize for Dolby Surround encoded movie soundtracks including increased surround separation and full-bandwidth surround channel frequency response.

Select **EMULATION** for decoding that emulates the original Dolby Pro Logic system. You may prefer this option for older soundtracks that are not of optimum audio quality. EMULATION mode reduces the high-frequency response and separation of the surround channels and may increase the delay setting.

Select **MUSIC** to optimize for musical recordings. When the MUSIC mode is selected, three additional parameters will be available on the OSD screen. Use the UP/DOWN buttons on the remote to select a parameter. Use the +/– buttons to change the selected parameter as follows:

- **PANORAMA:** The Panorama option extends the front stereo image to include the surround speakers for a dramatic “wrap-around” effect. The options are OFF or ON.
- **DIMENSION:** The Dimension option allows you to gradually adjust the soundfield towards the front or towards the rear. There are seven incremental settings from 0 to 6. A setting of 0 shifts the soundfield towards the rear for maximum surround effect. A setting of 6 shifts the soundfield to the front for minimum surround effect. The default setting of 3 provides a “neutral” balance between the two extremes.

- **CENTER WIDTH:** The Center Width option allows you to spread the signal intended for the center speaker to the left and right front speakers, widening the perceived soundfield. There are eight incremental settings from 0 to 7. With the default setting of 0, there is no center width spreading and all of the center channel information is sent to the center speaker. The maximum setting of 7 shifts all of the center channel signal to the left and right speakers, essentially muting the center speaker and maximizing the soundfield width. Other settings provide incremental steps between the two extremes.

When you have completed all the desired adjustments, highlight the INPUT SETUP MENU line at the bottom of the screen and press the ENTER button to return to the INPUT SETUP menu (or just press the ENTER button).

DTS Neo:6



When DTS Neo:6 is selected as the default surround mode on the INPUT SETUP menu, there are additional option settings and parameters available to optimize the surround decoding for various types of recordings, music or movie soundtracks. DTS Neo:6 uses matrix decoding algorithms to derive a center channel and surround channels from 2-channel source material.

In DTS Neo:6 surround mode, there will only be one choice available on the sub-menu: selecting CINEMA or MUSIC modes. Use the +/– buttons on the remote to change the settings.

- Select CINEMA to optimize the DTS Neo:6 decoding for movie soundtracks.
- Select MUSIC to optimize the DTS Neo:6 decoding for musical recordings.

When you have completed the setting, highlight the INPUT SETUP MENU line at the bottom of the screen and press the ENTER button to return to the INPUT SETUP menu (or just press the ENTER button).

Configuring Speakers and Audio

This section of the setup process covers items concerning audio reproduction such as the number of speakers, bass management including subwoofer crossovers, establishing equal output levels for all channels, delay settings, and tone contour settings.

Understanding Speaker Configuration

Home theater systems vary in the number of speakers and the bass capabilities of those speakers. The RSP-1098 offers surround modes tailored to systems with various numbers of speakers and bass management features which send bass information to the speaker(s) best able to handle it – subwoofers and/or large speakers. For optimum performance, you must tell the RSP-1098 the number of speakers in your system and how bass should be distributed among them.

NOTE: There are two types of bass in a surround system. The first is bass recorded in each of the main channels (front, center, and surround). This bass is present in all recordings and soundtracks. In addition, Dolby Digital 5.1 and DTS 5.1 recordings may have a Low Frequency Effects (LFE) channel – the .1 channel. This LFE channel, typically played by a subwoofer, is used for effects such as explosions or rumble. The use of the LFE channel will vary from soundtrack to soundtrack. Recordings that are not encoded in Dolby Digital or DTS do not have the LFE channel.

The following configuration instructions refer to LARGE and SMALL speakers, referring more to their desired bass configuration than their physical size. Specifically, use the LARGE setting for speakers that you want to play deep bass signals. Use the SMALL designation for speakers that would benefit from having their bass sent to more capable speakers. The bass management system redirects bass information away from all SMALL speakers and sends it to the LARGE speakers and/or the SUBWOOFER. It may be useful to think of LARGE as “full-range” and SMALL as “high-pass filtered.”

Four typical examples of the many possible system configurations illustrate the principles behind bass management:

- **Five LARGE speakers and subwoofer:** This system requires no bass redirection. All five speakers play the normal bass recorded in their respective channels. The subwoofer plays **only** the LFE channel bass. Depending on the soundtrack, there may be minimal use of the LFE channel, so the subwoofer would be under utilized. Meanwhile the normal bass places higher demands on the capabilities of the other speakers and the amplifiers driving them.

- **LARGE front, center, surround speakers, no subwoofer.** The normal bass from the front, center, and surround channels is played in its respective speakers. With no subwoofer, the LFE bass is redirected to all five LARGE speakers. This places significant demands on these speakers and their amplifiers, as they must play their own normal bass plus the very demanding LFE bass.

- **All SMALL speakers and subwoofer.** The normal bass from all channels is redirected to the subwoofer, which also plays the LFE channel. The subwoofer handles ALL of the bass in the system. This configuration provides several benefits: deep bass is played by the speaker most suited to do so, the main speakers may play louder with less distortion, and the need for amplifier power is reduced. This configuration should be used with bookshelf-size or smaller main speakers. It should also be considered in some cases with floorstanding front speakers. This configuration is advantageous when driving the system with moderate power amplifiers.

- **LARGE front speakers, SMALL center and surround speakers, and a subwoofer.** The normal bass from the SMALL center and surround speakers is redirected to the LARGE front speakers and the subwoofer. The LARGE front speakers play their own normal bass plus the redirected bass from the SMALL speakers and LFE bass. The subwoofer plays the LFE bass plus the redirected bass from all of the other channels. This might be an appropriate configuration with a pair of very capable front speakers driven by a large power amplifier. A potential disadvantage with mixed

LARGE and SMALL configurations is that the bass response may not be as consistent from channel to channel as it might be with the all SMALL configuration.

NOTE: As an alternative configuration with a satellite/subwoofer package as the front speakers, follow the speaker manufacturer's instructions, connecting the high-level inputs of the powered subwoofer directly to the front speaker outputs of the RSP-1098 and connecting the satellites to the subwoofer's own crossover. In this arrangement, the speakers would be classified as LARGE and the subwoofer setting would be OFF for all surround modes. No information is lost during playback because the system redirects bass information to the front LARGE speakers. While this configuration ensures proper satellite speaker operation by using the speaker's own crossovers, it has some disadvantages in terms of system calibration and would generally not be the preferred configuration.

Speaker Setup

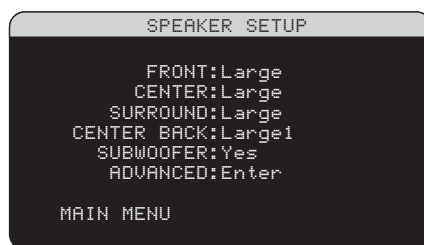

The SPEAKER SETUP menu is used to configure the RSP-1098 for use with your specific loudspeakers and to determine the bass management configuration as described in the previous overview. The menu is accessed from the MAIN menu.

The following speaker options are available:

FRONT SPEAKERS (small/large): Use the LARGE setting to have the front speakers play low bass (full-range). Use the SMALL setting to redirect normal bass away from these speakers to a subwoofer (high-pass filtered).

CENTER SPEAKER(S) (large/small/none): Use the LARGE position (not available with SMALL front speakers) to have the center speaker play low bass (full-range). Use the SMALL position if your center channel speaker has limited low frequency capability, or if you prefer that the bass be sent to the subwoofer (high-pass). Select the NONE setting if your system does not have a center channel speaker

(the surround modes will automatically divide all center channel information equally between the two front speakers, creating a phantom center channel).

SURROUND SPEAKERS (large/small/none): Select the LARGE setting (not available with SMALL front speakers) to have the surround speakers play low bass (full-range). If your rear speakers have limited bass capability or if you would prefer that the bass go to a subwoofer, use the SMALL setting (high-pass). If your system has no rear surround speakers, select the NONE setting (surround channels are added to the front speakers so none of the recording is lost).

CENTER BACK SPEAKER(S) (large1/large2/small1/small2/none): Some systems have one or two additional center back surround speakers. Select the LARGE settings (not available with SMALL front speakers) to have your center back speaker(s) play low bass. Use LARGE 1 if you have one center back speaker (6.1) or LARGE 2 (7.1) if you have two center back speakers (7.1). If your center back speakers have limited bass capability or if you would prefer that the bass go to a subwoofer, use the SMALL setting (SMALL1 for one speaker, SMALL2 for two speakers). If your system has no center back speakers, select the NONE setting. With center back speakers, the Rotel XS eXtra surround, Dolby Digital EX, DTS-ES, Dolby Pro Logic II, DTS Neo:6 or other decoders will provide center back signals for any surround mode.

SUBWOOFER (yes/no/max): The YES setting is the standard setting if your system has a subwoofer. If your system does not have a subwoofer, select NO. Select the MAX setting for maximum bass output with normal bass being duplicated by both the subwoofer and any LARGE speakers in the system.

ADVANCED: Speaker configuration is generally a global setting for all surround modes and need only be done once. However, for special circumstances, the RSP-1098 provides the option of setting the speaker configuration independently for each of four surround modes. Select the ADVANCED line on the menu and press ENTER to go to the ADVANCED SPEAKER SETUP menu described in the following section.

To change a setting on the SPEAKER SETUP menu, place the highlight on the desired line using the UP/DOWN buttons and use the +/- buttons to toggle through the available settings. To return to the MAIN menu, press the ENTER button. Press the MENU/OSD button on the remote to cancel the display and return to normal operation.

Advance Speaker Setup



In most cases, the standard speaker configuration described above is a global setting and can be used for all surround modes. However, the RSP-1098 provides the capability to customize these settings for four different surround modes: Dolby, DTS, Stereo, and Music. For example, you could set up the Dolby and DTS modes for 5.1 channel sound, while the Stereo mode changes to a 2-speaker setup with or without a subwoofer. In addition, the ADVANCED SPEAKER SETUP allows you to select a customized high-pass crossover frequency for the front, center, surround, and surround back speakers.

NOTE: In most systems, the default settings on this menu will provide the most predictable results and most users will not need to change any settings. You should fully understand bass management and have a specific reason for needing a custom configuration before changing these settings. Otherwise, skip to the following topic, SUBWOOFER SETUP.

The available settings on the ADVANCED SPEAKER SETUP menu are as follows:

SPEAKER (front/center/surround/center back/subwoofer): Select the set of speakers to be configured with custom settings.

CROSSOVER (40Hz/60Hz/80Hz/100Hz/120Hz/150Hz/200Hz): Typically, the RSP-1098 uses a single master setting for the high-pass and low-pass crossover point between all SMALL speakers and the subwoofer. This master crossover point is set on the SUBWOOFER SETUP menu described in the following section. When you first ac-

cess the ADVANCED SPEAKER SETUP menu, the current master crossover point will be shown on this line. Change the value of this line only if you want the current speaker to have a different crossover point. For example, if your master crossover is set to 80Hz, but you want your front speakers to crossover to the subwoofer at 60 Hz, you would select 60Hz for the front speakers on this line. This setting ONLY affects redirected bass and does not affect the LFE channel in any way. The OFF setting (available only for the subwoofer) sends a full-range signal to your subwoofer so that you can use its built-in low-pass filter.

NOTE: When a speaker is set to LARGE on the SPEAKER SETUP menu or on this MENU, the crossover setting is not available since, by definition, a LARGE speaker plays full-range with no bass redirection to the subwoofer and no crossover. Likewise, the OFF setting for the subwoofer crossover is not available for SMALL speakers, since SMALL means that the speaker will redirect its bass below a given crossover point to the subwoofer. In addition, the CROSSOVER setting is not available for the MULTI INPUT.

DOLBY (large/small/none): Sets the current speaker (shown in the first line) to LARGE, SMALL, or NONE, overriding the master setting from the SPEAKER SETUP menu. This setting will ONLY take effect with Dolby Digital or Dolby Pro Logic II decoding.

DTS (large/small/none): The same options described for Dolby above, except these settings ONLY take effect with DTS and DTS Neo:6 decoding.

STEREO/MPEG (large/small/none): The same options described for Dolby above, except these settings ONLY take effect in STEREO surround mode.

MUSIC (large/small/none): The same options described for Dolby above, except these settings ONLY take effect with any of the DSP MUSIC surround modes.

NOTE: When the front speakers are set to use the master crossover frequency on the ADVANCED SPEAKER SETUP menu, the surround mode specific "large/small/none" settings are not available for the other speakers. These speakers will use the setting determined in the basic SPEAKER SETUP menu.

Subwoofer Setup

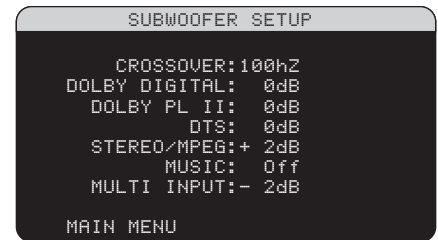

The SUBWOOFER SETUP menu allows selection of the master subwoofer crossover frequency and independent adjustment of subwoofer level for each surround mode.

CROSSOVER (40Hz/60Hz/80Hz/100Hz/120Hz/150Hz/200Hz/OFF):

This setting specifies a master low-pass filter for the subwoofer and a corresponding high-pass filter for all SMALL speakers in the system at the selected frequency. To adjust the crossover frequency, highlight the CROSSOVER line using the UP/DOWN buttons. Then, use the +/- buttons to choose the master crossover point. The 80Hz or 100Hz crossover points are the most common in home theater systems and should be used unless you have a specific reason to choose a different crossover point based on your specific speakers.

The OFF setting sends a full-range signal to your subwoofer so that you can use its built-in low-pass filter. With the OFF setting, a 100 Hz high-pass filter is activated for all SMALL speakers in the system.

NOTE: The master crossover point can be overridden with a custom crossover frequency for the front, center, surround, or surround back speakers in the ADVANCED SPEAKER SETUP menu; however, in most systems the single master crossover point should work well

DOLBY DIGITAL:

DOLBY PLII:

DTS:

STEREO/MPEG:

MUSIC:

MULTI INPUT:

These six lines allow you override the master subwoofer level setting as determined on the TEST TONE menu (see below) for each specific surround mode. When going to the SUBWOOFER SETUP menu from the MAIN menu, the current surround mode is automatically highlighted. Use the +/- buttons to adjust the subwoofer level for the current surround mode. The options are OFF (which turns off the sub-

woofer for that mode) and a range of adjustments from -9dB to +9dB and MAX (+10dB). A setting of 0dB means that the specified surround mode will use the master subwoofer level. Any other setting is an offset to the master setting. For example, an adjustment of -2dB for a particular surround mode means that the subwoofer level will be 2 dB quieter than the master subwoofer level when that surround mode is selected. Use these subwoofer level settings to adjust the relative bass output of various surround modes. Changing the master subwoofer level will increase or decrease the level for all surround modes.

NOTE: Only the current surround mode can be adjusted on this menu. You will need to change surround modes using the front panel or remote buttons to adjust a different mode.

We recommend starting with the settings for all surround modes at the default 0 dB setting during the test tone calibration of the system and for a period of familiarization after that. As you listen to a variety of source material over time, you may notice that certain surround modes consistently produce too much or too little bass from the subwoofer. If so, then use these menu settings to customize each surround mode. In general, if the master subwoofer level is set properly (i.e. not too loud), individual settings for each surround mode should not be necessary.

NOTE: In Dolby Digital and DTS recordings, the LFE channel is used to produce spectacular low bass effects, placing considerable demands on your subwoofer system. If you hear distortion or other signs of distress from your subwoofer at loud listening levels, you may consider reducing the subwoofer level for the Dolby Digital and/or DTS surround modes. In other surround modes, there is no LFE channel and the subwoofer will only reproduce redirected bass from the other channels, which is not as likely to tax the subwoofer.

To return to the MAIN menu, press the ENTER button. Press the MENU/OSD button on the remote to cancel the display and return to normal operation.

Test Tone

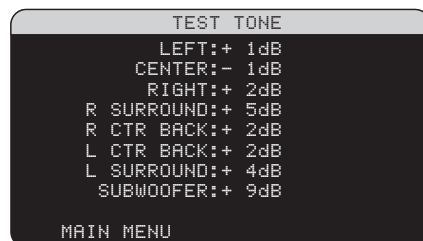

This menu uses filtered pink noise test tones to set equal volume levels for all speakers (left front, center, right front, right surround, center back, left surround, and subwoofer) to ensure proper surround sound reproduction. Setting the output levels using the test procedure provides the most accurate adjustment so that digital surround sound material will be reproduced as it was intended and is a critical step in calibrating the system.

NOTE: If you have configured your system to use two center back speakers, there will be an additional line in the menu, giving you the ability to independently adjust the CENTER BACK 1 and CENTER BACK 2 speakers.

To access this menu and perform the test tone calibration, you can be in any surround mode except BYPASS with any input except the MULTI INPUT. Enter the OSD menu system and select TEST TONE from the MAIN MENU to reach this screen.

When you enter the TEST TONE menu, you will hear a test tone coming from the highlighted speaker. Highlight different speakers by moving the cursor to the desired line using the UP/DOWN buttons. The test tone will shift accordingly to the selected speaker.

Seated in the normal listening location, shift the test tone to the various speakers. Using the one speaker as a reference, listen for any speakers that are noticeably louder or quieter. If so, adjust that speaker's levels up or down (in 1dB increments) using the +/- buttons. Continue switching among the speakers and adjusting until all speakers are the same volume.

To return to the MAIN menu, press the ENTER button. Press the MENU/OSD button on the remote to cancel the menu display and return to normal operation.

Calibration with an SPL meter:

Calibrating the system with an SPL meter, rather than by ear, provides more precise results and improves the system's performance significantly. Inexpensive SPL meters are widely available and the procedure is quick and easy.

Both Dolby and DTS specify a standard calibration level for all theaters to ensure that soundtracks can be played at the volume level intended by the director of the film. This reference level should result in spoken dialog played at a realistic level for normal speech with the loudest peaks in any single channel at about 105 dB. The RSP-1098's test tones are generated at a precise level (-30dBFs) relative to the loudest possible digitally recorded sound. At the Dolby or DTS reference level, these test tones should produce a 75dB reading on an SPL meter.

Set the meter to its 70dB dial setting with SLOW response and C-weighting, held away from your body at your listening position (mounting the SPL meter on a camera tripod makes this easier). You can point the SPL meter at each speaker as it is being measured; however, positioning the meter in a fixed position pointing at the ceiling is easier and probably produces more consistent results.

Increase the master volume control on the RSP-1098 until the meter reads 75dB (+5dB on the meter scale) when playing the test tone through one of the front speakers. Then, use the individual channel adjustments on the TEST TONE menu to adjust each of the individual speakers, including the subwoofer, to the same 75dB on the SPL meter.

NOTE: Due to meter weighting curves and room effects, the actual level of the subwoofer may be slightly higher than you measure. To compensate, Dolby suggests setting the subwoofer several dB lower when calibrating with an SPL meter (i.e. set the subwoofer to read 72 dB on the meter instead of 75 dB). Avoid setting the subwoofer level too high (above 75dB). Exaggerated bass effects come at the expense of proper blending with the main speakers and place tremendous stress on the subwoofer and its amplifier. If you can localize bass from the subwoofer, the subwoofer level is almost certainly too high. Music can be useful for fine-tuning the subwoofer level as excessive bass is readily apparent. The proper setting will generally work well for music and movie soundtracks.

Remember the setting of the master volume control used during this calibration. To play a Dolby Digital or DTS soundtrack at the reference volume level, simply return to that volume setting. Note that most home theater listeners find this setting to be excessively loud. Let your own ears be the judge for deciding how loud to playback movie soundtracks and adjust the master volume control accordingly. Regardless of your listening levels, using an SPL meter to calibrate equal levels for all speakers in the system is strongly recommended.

Delay Setup

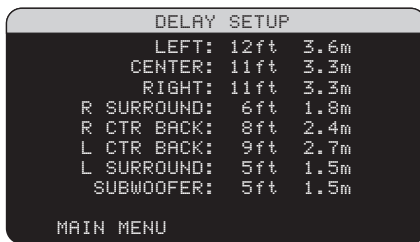

The DELAY SETUP menu, which is reached from the MAIN menu, allows you to set the delay for individual speakers. This ensures that the sound from each speaker arrives simultaneously at the listening position, even when the speakers are not all placed at equal distances from the listener. Increase the delay to speakers located closer to the seating area and decrease the delay to speakers located farther from the seating area.

The RSP-1098 makes setting the delay time for each speaker very easy. Simply measure the distance (in feet or meters) from your seating position to each speaker in your system. Set the measured distance in the line for each speaker. The menu provides a line for each speaker configured in your system and provides a range of settings up to 99 feet (30 meters) in 1 foot (0.3 m) increments with each increment equivalent to an additional delay of 1 ms.

To change a setting, place the highlight on the desired line using the UP/DOWN buttons and use the +/- buttons to increase or decrease the delay setting. To return to the MAIN menu, press the ENTER button. Press the MENU/OSD button on the remote to cancel the display and return to normal operation.

Contour Setup

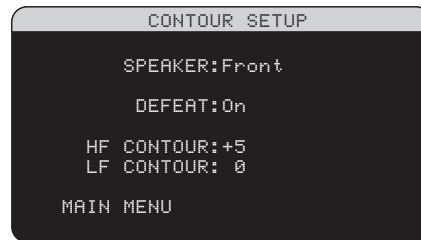

The CONTOUR SETUP menu allows digital adjustment of the bass and treble response of each group of speakers in the system. For example, if your center channel speaker sounds too bright, you could roll off the extreme high frequencies.

SPEAKER (front/center/surround/center back/all): Select which speaker or group of speakers to adjust. Selecting ALL permits adjustment of the entire system as a whole.

DEFEAT (on/off): Selecting the ON setting defeats the contour adjustment, bypassing the contour processing entirely for that speaker or group of speakers.

HF CONTOUR: Adjusts the extreme high frequency slope over a range of -6dB (MIN) to +6dB (MAX). Negative number settings reduce the high frequency output; positive number settings increase it.

LF CONTOUR: Adjusts the extreme low frequency slope over a range of -6dB (MIN) to +6dB (MAX). Negative number settings reduce the low frequency output; positive number settings increase it.

The contour adjustments are designed to work at the frequency extremes and be relatively subtle so that they do not have a negative impact on midrange sounds. We recommend acclimating to the sound of the system with the contour adjustments defeated and then making adjustments, if necessary, to address specific speaker response issues or personal taste.

NOTE: You can also make permanent contour adjustments using the TONE and UP/DOWN buttons on the remote. These adjustments are global, changing the contour settings for **all** speakers in the system, regardless of the settings on this menu. See the Contour/Tone Settings section of this manual for details.

Miscellaneous Settings

Other Options

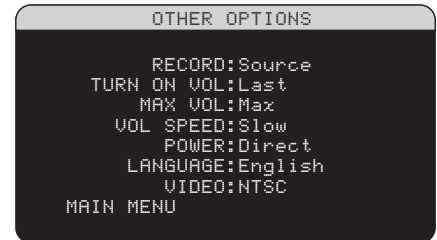

This OTHER OPTIONS menu, accessed from the MAIN menu, provides access to a several miscellaneous settings as follows:

RECORD: Select which source signal to be sent to the recording outputs by choosing one of the input sources. The options are: CD, TAPE, TUNER, VIDEO 1-5, and SOURCE. You can either select a specific component or select SOURCE which will send the signal to the record outputs from whatever source is selected for listening.

TURN ON VOL: Specifies a default volume level to be used each time the RSP-1098 is activated. You can select LAST to have the RSP-1098 power up with the last previously used volume setting. Or, you specify a volume from MIN (full mute) to MAX, in 1 dB increments. Note that this setting cannot exceed the MAX VOL established in the next line of the menu.

MAX VOL: Specifies a maximum volume level for the RSP-1098. The volume cannot be adjusted above this level. Settings range from MIN to MAX, in 1dB increments.

VOL SPEED: Provides three options for how rapidly the volume control responds to inputs. The SLOW setting adjusts the volume 1dB with each control input. The MID setting adjusts in 2dB increments. The FAST setting adjusts in 3dB increments.

POWER: This setting determines how the RSP-1098 powers up. With the default **DIRECT** setting, the unit is fully activated when AC power is applied and the rear panel POWER button is ON; however, it may be put in standby mode using the front panel STANDBY button or the remote ON/OFF buttons. This would be the normal setting for most systems.

With the **STANDBY** setting, the unit powers up in standby mode when AC is applied and the rear panel POWER button is ON. The unit must be activated using the front panel STANDBY button or the remote ON/OFF buttons.

In **ALWAYS-ON** mode, the unit remains fully active whenever AC is present and the rear panel POWER button is ON; the front panel STANDBY button and the remote ON/OFF buttons are disabled and the unit cannot be put in standby mode.

LANGUAGE: Selects a language for the OSD/TFT displays.

VIDEO: Specifies whether an NTSC or PAL television monitor is connected to the TV MONITOR outputs of the RSP-1098. This setting must be correct for the upconversion and OSD menus to work properly.

Change settings on the OTHER OPTIONS menu by highlighting the desired line using the UP/DOWN buttons and using the +/- buttons to step through the available settings. To return to the MAIN menu, press the ENTER button. Press the MENU/OSD button on the remote to cancel the display and return to normal operation.

Zone 2 Setup

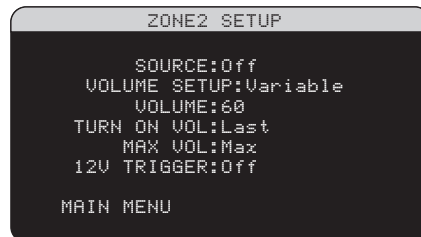

The ZONE 2 SETUP menu provides settings and configuration options related to the operation of Zone 2. This menu is reached by highlighting the ZONE 2 line on the MAIN menu and pressing ENTER.

SOURCE: Specifies a source for listening in Zone 2. Options are CD, TUNER, TAPE, VIDEO 1-5, SOURCE, and OFF. Selecting the SOURCE option links the Zone 2 source to the source selected for the main zone so that Zone 2 will hear the same source as the main zone. Selecting the OFF option turns Zone 2 off.

VOLUME SETUP: configures the Zone 2 outputs for VARIABLE or FIXED volume levels. VARIABLE allows control of the volume settings in Zone 2 from the RSP-1098 front panel or from a remote control/IR repeater in Zone 2. FIXED output disables the Zone 2 volume control. In this mode, the Zone 2 level can be fixed at the level specified on the next line, thus optimizing system performance when sending a fixed level signal to a preamp or amplifier with its own volume adjustment.

VOLUME: In VARIABLE output mode, this line shows the current volume setting for Zone 2. In FIXED output mode, this volume setting establishes a permanent fixed output level for Zone 2.

Move the highlight to the desired line using the UP/DOWN buttons and use the +/- buttons to adjust the volume level. To return to the MAIN menu, press the ENTER button. Press the MENU/OSD button on the remote to cancel the display and return to normal operation.

TURN ON VOL: Specifies a default volume level to be used each time Zone 2 is activated. You can select LAST to have Zone 2 activate with the last previously used volume setting. Or, you specify a volume from MIN (full mute) to MAX, in 1 dB increments. Note that this setting cannot exceed the MAX VOL established in the next line of the menu.

MAX VOL: Specifies a maximum volume level for Zone 2. The volume cannot be adjusted above this level. Settings range from MIN to MAX, in 1 dB increments.

12V TRIGGER: The RSP-1098 has four 12V trigger outputs that supply a 12V DC signal to turn on Rotel components and other components as needed. The 12V Trigger labeled ZONE2 is assigned to Zone 2 and can send a turn-on signal to remote components whenever Zone 2 is activated. Select the ON setting to have the ZONE2 trigger output send the turn-on signal. Select the OFF setting to disable the 12V trigger function for Zone 2.

Default Setup

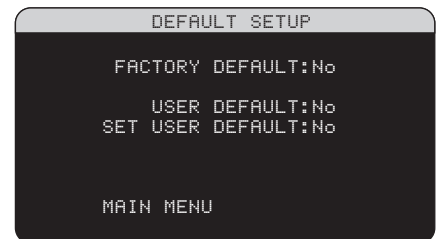

The DEFAULT SETUP menu provides access to three functions:

- Restore all features and settings to the original FACTORY DEFAULT settings.
- Memorize a custom group of settings as a USER DEFAULT.
- Activate the memorized USER DEFAULT settings.

To restore the FACTORY DEFAULT settings: Place the highlight on the FACTORY DEFAULT line using the UP/DOWN buttons and use the +/- buttons to change the setting to YES. Press the ENTER button to proceed with resetting the FACTORY DEFAULT settings. The unit will power off and then on, with the factory settings restored. To return to the MAIN menu without resetting the FACTORY DEFAULT settings, change the entry to NO and press the ENTER button.

NOTE: *Resetting to factory default settings will erase all stored settings including delay settings, speaker settings, balance settings, input settings and more. You will lose ALL system configuration settings. Be certain that you wish to do so before resetting the factory defaults.*

To memorize USER DEFAULT settings:

Many of the current configuration settings can be stored as a USER DEFAULT, which can be activated at any time from this menu screen. To save the current settings as a USER DEFAULT, place the highlight on the SET USER DEFAULT line using the UP/DOWN buttons and use the +/- buttons to change the setting to YES. Press the ENTER button to store the new USER DEFAULT settings. To return to the MAIN menu without saving any changes, change all entries on the screen to NO and press the ENTER button.

NOTE: *If there is insufficient memory to store a USER DEFAULT configuration file, the SET USER DEFAULT option will not be available.*

To activate memorized USER DEFAULT settings:

After you have stored a USER DEFAULT configuration file, you can activate those settings at any time by placing the highlight on the USER DEFAULT line using the UP/DOWN buttons. Use the +/- buttons to change the setting to YES. Press the ENTER button to proceed with activating the USER DEFAULT settings. To return to the MAIN menu without activating the USER DEFAULT settings, change the entry to NO and press the ENTER button.

MORE INFORMATION

Troubleshooting

The unit does not turn on.

- Make sure the power cord is plugged into the rear panel and a live AC wall outlet.
- Make sure the rear panel POWER switch is in the ON position

No sound from any input.

- Make sure that MUTING is off and VOLUME is turned up. If the TFT screen and the TV monitor are turned off, the MUTING can be on with no visual indication.
- Make sure that preamp outputs are connected to a power amplifier and that the amplifier is turned on.
- Make sure source inputs are connected and configured correctly.

No sound from digital sources.

- Make sure that digital input connector is assigned to the proper source input and that the source input is configured to use the digital input rather than an analog input.
- Check the configuration of the DVD player to ensure that the bitstream and/or DTS digital output is activated.

No sound from some speakers.

- Check all power amp and speaker connections.
- Check *Speaker Configuration* settings in the *Setup* menus.

No video output on TV monitor.

- Make sure that the TV monitor is connected properly. Component video outputs can send any type of signal to the TV. Composite video connections can only send video from composite sources and S-Video connections can only send video from S-Video sources.
- Make sure the NTSC/PAL switch is set properly.

No video or distorted video on TFT screen.

- Make sure that a composite video source is selected for display on the TFT screen. The TFT screen cannot display S-Video or Component Video signals.
- When progressive scan video from a DVD player is being received at the Component Video inputs, the composite video signal from the DVD player may be corrupted.

OSD menus are not displayed on TV Monitor or TFT screen.

- Go to Setup menus and configure OSD menus to be displayed on the TV monitor and/or the TFT screen.
- In some PAL systems, the menus may not be displayed unless there is an active video signal. Use the TFT screen for menu operation.
- When using progressive scan video signals, make sure that the progressive mode is set to YES in the Display Options setup menu. This allows the display of the main setup OSD menus on the TV monitor by interrupting the progressive scan video signal and restoring it after the OSD menus are cancelled. The temporary information screens (such as volume, etc.) cannot be displayed on the TV monitor when progressive scan signals are being used.

Video and Audio do not match.

- Check that the proper video source is selected for each input.
- Check that the group delay (lip-synch) setting is not misadjusted.

Clicking or popping sounds when switching inputs.

- The unit uses relay switching to preserve maximum sound quality. The mechanical clicking of the relays is normal.
- During switching, it may take a split second for digital signals to be recognized and properly decoded. Rapid repeated switching between inputs or settings can result in clicks or pops from the speakers as the unit attempts to lock on to the rapidly changing signals. This causes no harm.

Controls do not operate.

- Make sure that fresh batteries are installed in the remote.
- Make sure that the IR sensor on the front panel is not blocked. Aim the remote at the sensor.
- Make sure the sensor is not receiving strong IR light (sunlight, halogen lighting, etc.)
- Unplug the unit from the AC outlet, wait 30 seconds, and plug it back in to reset.

Specifications

Audio

Total Harmonic Distortion
<0.05%

Intermodulation Distortion (60 Hz:7 kHz)
<0.05%

Frequency Response
10 Hz – 120 kHz, ± 3 dB (analog bypass)
10 Hz – 95 kHz, ± 3 dB (digital input)

Signal to Noise Ratio (IHF A-weighted)
95 dB (analog bypass)
92 dB (Dolby Digital, dts) 0dBFS

Input Sensitivity/Impedance
Line Level: 200 mV/100K ohms

Preamp Output Level/Output Impedance
1.0 V / 250 ohms

Contour (LF/HF)
 ± 6 dB at 50 Hz/15 kHz

Decodable Digital Input Signals

Dolby Digital, Dolby Digital EX, DTS, DTS-ES, DTS 96/24, LPCM (up to 192K), HDCD, MP3, MPEG Multichannel

Video

Frequency Response
3 Hz – 10 MHz, ± 3 dB (Composite, S-Video)
3 Hz – 100 MHz, ± 3 dB (Component Video)

note: TFT screen displays Composite Video signals only.

Signal to Noise Ratio
45 dB

Input Impedance
75 ohms

Output Impedance
75 ohms

Output Level
1.0 volt

General

Power Consumption:
70 watts (normal)
60 watts (TFT screen off)
7.5 watts (standby)

Power Requirements (AC)
115 volts, 60Hz (USA version)
230 volts, 50Hz (CE version)

Weight
15.7 Kg/34.6 lb.

Dimensions (W x H x D)
432 x 164 x 435 mm
17.01" x 6.46" x 17.13"

Front Panel Height
(feet removed for rack mount)
150 mm / 5.91"

When sizing openings in custom cabinets, measure the unit to be installed and/or allow at least 1 mm clearance on all sides for unit to unit tolerances.

All specifications are accurate at the time of printing. Rotel reserves the right to make improvements without notice.

Rotel and the Rotel HiFi logo are registered trademarks of The Rotel Co, Ltd., Tokyo, Japan.



ROTEL

The Rotel Co. Ltd.

10-10 Shinsen-Cho
Shibuya-Ku
Tokyo 150-0045
Japan
Phone: +81 3-5458-5325
Fax: +81 3-5458-5310

Rotel of America

54 Concord Street
North Reading, MA 01864-2699
USA
Phone: +1 978-664-3820
Fax: +1 978-664-4109

Rotel Europe

Dale Road
Worthing, West Sussex BN11 2BH
England
Phone: +44 (0)1903 221600
Fax: +44 (0)1903 221525

Rotel Deutschland

Kleine Heide 12
D-33790 Halle/Westf.
Germany
Phone: +49 05201-87170
Fax: +49 05201-73370

www.rotel.com

Free Manuals Download Website

<http://myh66.com>

<http://usermanuals.us>

<http://www.somanuals.com>

<http://www.4manuals.cc>

<http://www.manual-lib.com>

<http://www.404manual.com>

<http://www.luxmanual.com>

<http://aubethermostatmanual.com>

Golf course search by state

<http://golfingnear.com>

Email search by domain

<http://emailbydomain.com>

Auto manuals search

<http://auto.somanuals.com>

TV manuals search

<http://tv.somanuals.com>