

ROTEL

Owner's Manual

RT-1082

DAB/AM/FM Stereo Tuner



Register your product at
www.Rotel.com/register



APPLICABLE FOR USA, CANADA OR WHERE APPROVED FOR THE USAGE

CAUTION: TO PREVENT ELECTRIC SHOCK, MATCH WIDE BLADE OF PLUG TO WIDE SLOT. INSERT FULLY.

ATTENTION: POUR EVITER LES CHOCS ELECTRIQUES, INTRODUIRE LA LAME LA PLUS LARGE DE LA FICHE DANS LA BORNE CORRESPONDANTE DE LA PRISE ET POUSSER JUSQU'AU FOND.

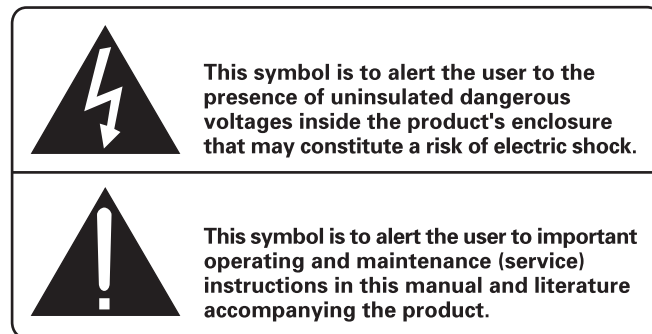

Rotel products are designed to comply with international directives on the Restriction of Hazardous Substances (RoHS) in electrical and electronic equipment and the disposal of Waste Electrical and Electronic Equipment (WEEE). The crossed wheeled bin symbol indicates compliance and that the products must be appropriately recycled or processed in accordance with these directives.



This symbol means that this unit is double insulated. An earth connection is not required.

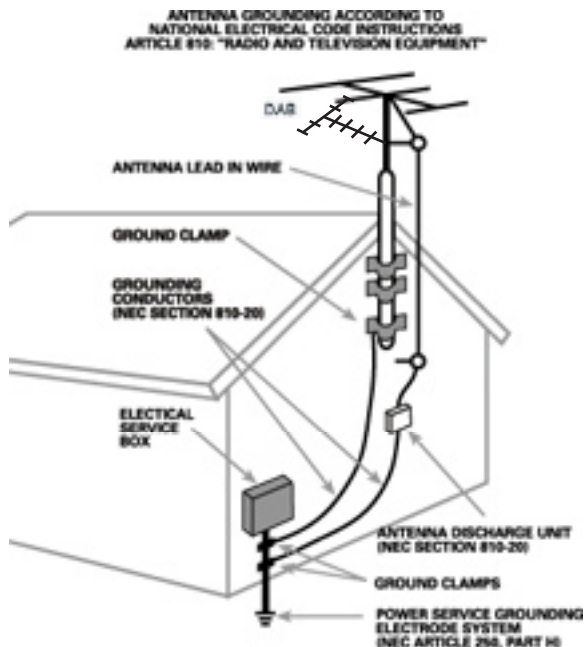

Important Safety Information

WARNING: There are no user serviceable parts inside. Refer all servicing to qualified service personnel.

WARNING: To reduce the risk of fire or electric shock, be sure that the apparatus shall not be exposed to dripping or splashing and that no objects filled with liquids, such as vases, shall be placed on the apparatus.

Do not allow foreign objects to get into the enclosure. If the unit is exposed to moisture, or a foreign object gets into the enclosure, immediately disconnect the power cord from the wall. Take the unit to a qualified service person for inspection and necessary repairs.

Read all the instructions before connecting or operating the component. Keep this manual so you can refer to these safety instructions.

Heed all warnings and safety information in these instructions and on the product itself. Follow all operating instructions.

Clean the enclosure only with a dry cloth or a vacuum cleaner.

You must allow 10 cm or 4 inches of unobstructed clearance around the unit. Do not place the unit on a bed, sofa, rug, or similar surface that could block the ventilation slots. If the component is placed in a bookcase or cabinet, there must be ventilation of the cabinet to allow proper cooling.

Keep the component away from radiators, heat registers, stoves, or any other appliance that produces heat.

The unit must be connected to a power supply only of the type and voltage specified on the rear panel of the unit.

Connect the component to the power outlet only with the supplied power supply cable or an exact equivalent. Do not modify the supplied cable in any way. Do not attempt to defeat grounding and/or polarization provisions. Do not use extension cords.

Do not route the power cord where it will be crushed, pinched, bent at severe angles, exposed to heat, or damaged in any way. Pay particular attention to the power cord at the plug and where it exits the back of the unit.

Main plug is used as the mains disconnect device and shall remain ready accessible.

The power cord should be unplugged from the wall outlet if the unit is to be left unused for a long period of time.

The apparatus shall be connected to a mains socket outlet with a protective earthing connection.

Immediately stop using the component and have it inspected and/or serviced by a qualified service agency if:

- The power supply cord or plug has been damaged.
- Objects have fallen or liquid has been spilled into the unit.
- The unit has been exposed to rain.
- The unit shows signs of improper operation
- The unit has been dropped or damaged in any way

Please use Class 2 Wiring when connecting the speaker terminals of the unit to ensure proper insulation and minimize the risk of electrical shock.

Place the unit on a fixed, level surface strong enough to support its weight. Do not place it on a moveable cart that could tip over.



Figure 1: Front Panel Controls

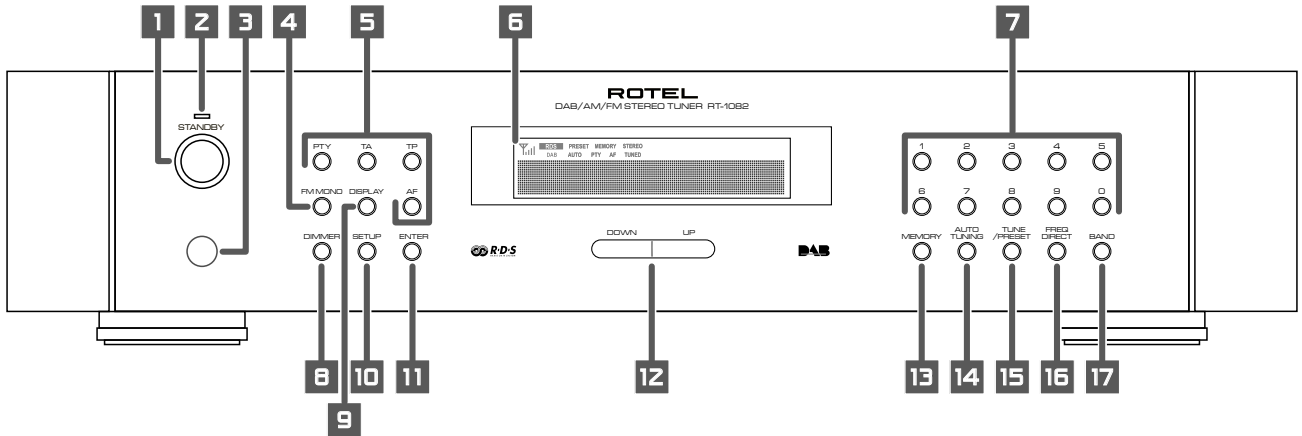

Figure 2: RR-T95 Remote Control

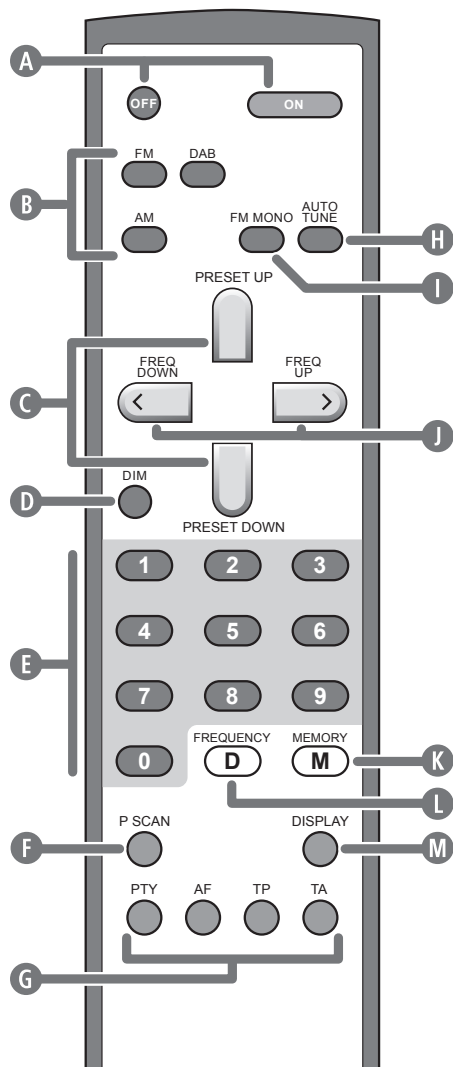

Figure 3: Rear Panel Connections

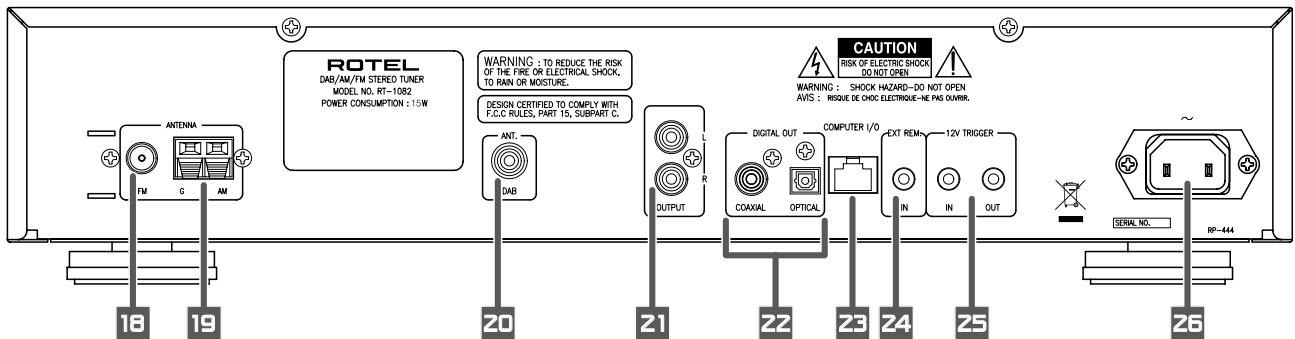
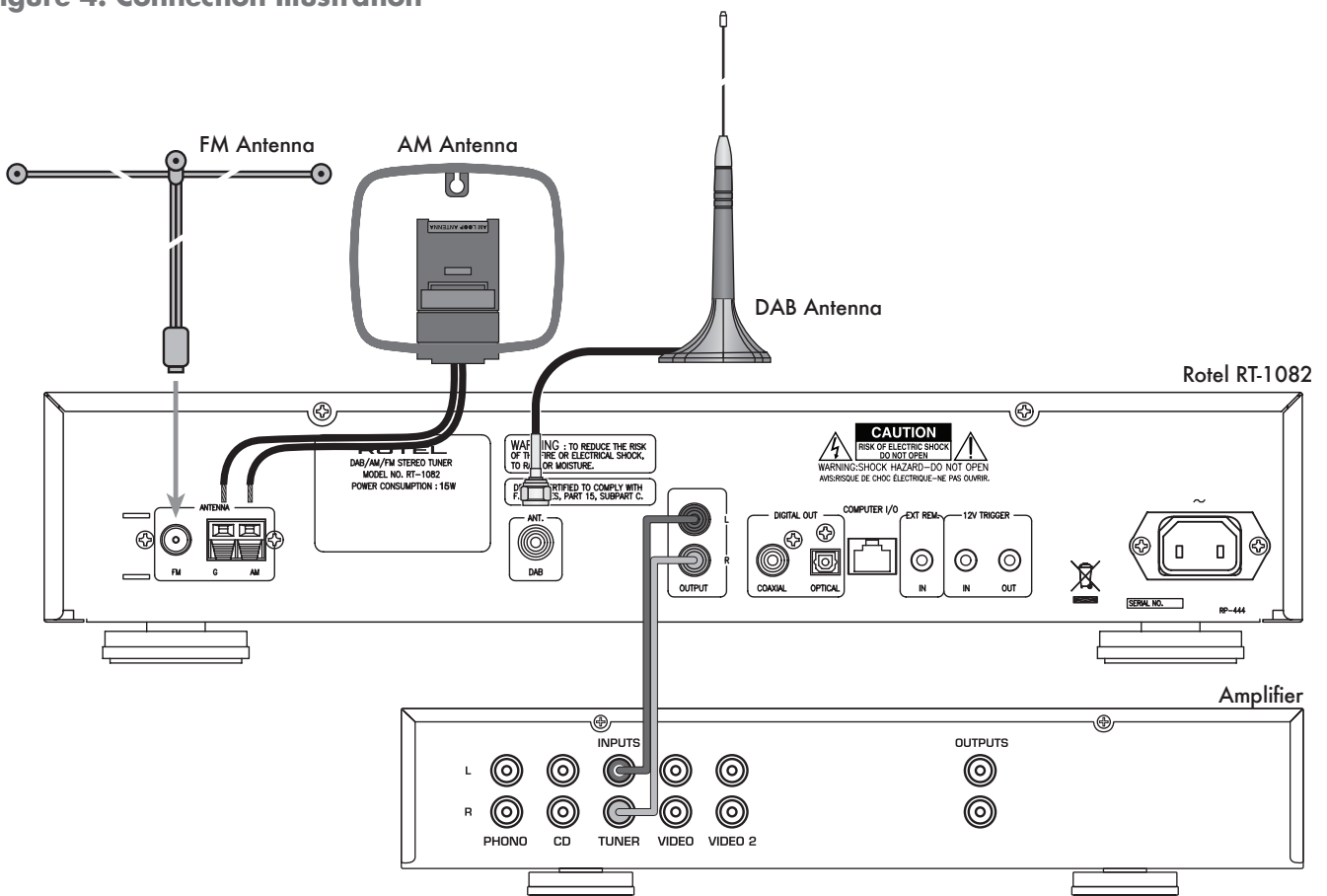

Figure 4: Connection Illustration



Important Notes

When making connections be sure to:

- ✓ Turn off **all** the components in the system **before** hooking up **any** components, including loudspeakers.
- ✓ Turn off **all** components in the system **before** changing **any** of the connections to the system.

It is also recommended that you:

- ✓ Turn the volume control of the amplifier all the way down **before** the amplifier is turned **on** or **off**.

Contents

Important Safety Information	2
Figure 1: Front Panel Controls	3
Figure 2: RR-T95 Remote Control	3
Figure 3: Rear Panel Connections	4
Figure 4: Connection Illustration	4
Important Notes	4
About Rotel	5
Getting Started	5
A Few Precautions	6
Key Features	6
Unpacking	6
Placement	6
Rear Panel Connections	6
FM Antenna 16	6
AM Loop Antenna 19	6
DAB Antenna 20	6
RCA Outputs 21	6
DAB Digital Outputs 22	6
Computer I/O 23	7
EXT REMOTE IN Jack 24	7
12V TRIGGER Connection 25	7
AC Input 26	7
Basic Operating Controls	7
Standby Button 1 and Standby LED 2	7
ON and OFF Buttons A	7
Remote Sensor 3	7
Front Panel Display 5	7
MEMORY Button 13 K	7
ENTER Button 11	7
SETUP Button 10	7
DIMMER Button 8 D	7
Basic Tuning Controls	8
TUNING Controls 12 C J	8
BAND Buttons 17 B	8
FREQUENCY TUNING Mode	8
PRESET TUNING Mode	8
RDS PTY search mode	8
Numeric Buttons	8
Station Presets 7 E	8
Direct Access Tuning 16 L	9
Auto Tuning Button 14 H	9
TUNE/PRESET Button 15	9
PRESET SCAN Button F	9
FM MONO 4 I	9
RDS and RBDS Broadcast Reception	10
DISPLAY Button 9 M	10
PTY Button 5 G	10
TP Button 5 G	10
TA Button 5 G	10
AF Button 5 G	11

Digital Audio Broadcast (DAB)	11
DAB Basic Information	11
BAND, DAB Buttons 17 B	11
UP / DOWN Buttons 12 C	11
ENTER Button 11	11
DISPLAY Button 9 M	11
MEMORY Button 13 K	11
NUMERIC Buttons 7 E	11
TUNE/PRESET Button 15	11
Setup Operation	11
SETUP Button 10	11
SETUP Menu	11
Searching for a DAB station	12
AUTO TUNE button 14 H	12
How to store DAB stations	12
How to call a PRESET	12
Specifications	13

About Rotel

A family whose passionate interest in music led them to manufacture high fidelity components of uncompromising quality founded Rotel 45 years ago. Over the years that passion has remained undiminished and the goal of providing exceptional value for audiophiles and music lovers regardless of their budget, is shared by all Rotel employees.

The engineers work as a close team, listening to, and fine tuning each new product until it reaches their exacting musical standards. They are free to choose components from around the world in order to make that product the best they can. You are likely to find capacitors from the United Kingdom and Germany, semi-conductors from Japan or the United States, and toroidal power transformers manufactured in Rotel's own factory.

Rotel's reputation for excellence has been earned through hundreds of good reviews and awards from the most respected reviewers in the industry, who listen to music every day. Their comments keep the company true to its goal – the pursuit of equipment that is musical, reliable and affordable.

All of us at Rotel thank you for buying this product and hope it will bring you many hours of enjoyment.

Getting Started

Thank you for purchasing the Rotel RT-1082 DAB/AM/FM Stereo Tuner. Rotel's Balanced Design Concept combines advanced circuit board layout, comprehensive parts evaluation and extensive listening tests for superior sound and long term reliability. The Rotel RT-1082 will provide years of listening enjoyment.

A Few Precautions

Please read this manual carefully. In addition to installation and operating instructions, it provides valuable information on various RT-1082 system configurations as well as general information that will help you get optimum performance for your system. Please contact your authorized Rotel dealer for answers to any questions you might have. In addition, all of us at Rotel welcome your questions and comments.

Save the RT-1082 packaging material for future use. Shipping or moving the RT-1082 in anything other than the original packaging material may result in severe damage that is not covered by the warranty.

Register online at www.rotel.com/register and keep your original sales receipt. It is your proof of purchase in the event that warranty service is required.

Key Features

- AM, FM and DAB tuning capabilities.
- User-friendly Fluorescent Display.
- 30 Station Presets for memorizing your favorite AM/FM stations; 99 presets for DAB stations.
- Manual frequency and preset tuning, auto-search tuning, preset scanning and frequency direct tuning.
- RDS (Radio Data System) capability for Europe and RBDS (Radio Broadcast Data Service) capability for the USA.
- DAB (Digital Audio Broadcast); a digital transmission available throughout Europe and Canada as well as many other supported regions.
- Stereo/mono switching.
- 12-volt trigger connections for remote turn on/off by Rotel preamplifiers and surround processors.
- Full-function wireless remote control.

Unpacking

Remove the unit from its packing. Look for the handheld remote control and other accessories. Install the supplied batteries in the remote control. Save the packing and box as it will protect the RT-1082 if you move or need to return it for maintenance.

Placement

Place the RT-1082 on a solid, dry, level surface away from direct sunlight, excessive heat, high humidity or strong vibrations. The RT-1082 can generate some heat during normal operation. If installed in a cabinet, make sure that there is adequate ventilation. Make sure there is enough room behind the RT-1082 for easy hookup. Place the unit close to the other components in your audio/video system and, if possible, place it on its own shelf. This will make initial cable routing, hookup, and any subsequent system changes easier. It also minimizes potential interference or heat buildup from other components.

Don't stack heavy objects on top of the RT-1082. Do not expose the unit to moisture; this could damage the circuitry and cause a safety hazard.

Rear Panel Connections

The RT-1082 provides rear panel connections for audio line level output, an FM antenna, an AM antenna, a DAB antenna, a 12V Trigger, a remote IR sensor, DAB digital outputs and AC power input.

NOTE: Do not plug any system component into an AC source until system hookup is complete and you are confident that all component-to-component connections have been properly made.

FM Antenna 1B

The RT-1082 is supplied with a T-shaped indoor FM antenna. Remove this antenna from the box and connect its attached coax F-type plug to the FM antenna connector on the RT-1082. For best reception, unfold the T-shaped antenna. Eyelets at both ends of the T allow tacking the antenna to a wall if desired. Experiment with positioning for best reception.

NOTE: To use an outdoor antenna, connect its 75 ohm coax lead wire to the FM connector in place of the indoor wire antenna, only after a professional contractor has installed the antenna system in accordance with local electrical codes. In the USA, you will need to use the supplied F-type converter to connect the 75 ohm coax cable to the antenna input.

AM Loop Antenna 19

The RT-1082 includes a loop antenna to receive AM radio signals. Remove this antenna from the box and locate it near the RT-1082.

Connect the 300 ohm twin-conductor wire from the loop antenna to the pair of screw terminals labeled AM LOOP, attaching one wire to each terminal. It does not matter which wire attaches to which terminal, but make sure that the connections are solid and that the two wires do not touch.

You may need to rotate or otherwise reorient the antenna to find the best position.

NOTE: To use an outdoor antenna, connect its 300 ohm twin-conductor wire to the G and AM terminals in place of the loop antenna, only after a professional contractor has installed the antenna system in accordance with local electrical codes.

DAB Antenna 20

Included is a DAB indoor antenna. If you cannot obtain good reception using this supplied antenna, it is recommended to use an outdoor DAB antenna. The outdoor antenna can be connected with a F-Type connector (male) then to the "Antenna DAB" connection on the rear panel.

RCA Outputs 21

Line level RCA audio outputs send a fixed-level stereo signal from the RT-1082 to your pre-amplifier, system controller, or integrated amplifier.

Use a standard RCA audio cable to connect the LEFT OUTPUT jack to the left channel tuner input on your system controller and the RIGHT OUTPUT jack to the right channel tuner input on your system controller.

DAB Digital Outputs 22

One coaxial and one S/PDIF output capable of outputting available DAB (Digital Audio Broadcast) stations. DAB provides interference free, near CD quality audio as well as any corresponding broadcast data.

Computer I/O ²³

The RT-1082 can be operated from a computer with audio system control software from third-party developers. This control is accomplished by sending operating codes from the computer via a hard wired RS-232 serial connection

In addition, the RT-1082 can be updated using special software from Rotel.

The COMPUTER I/O input provides the necessary network connections on the rear panel. It accepts standard RJ-45 8-pin modular plugs, such as those commonly used in 10-BaseT UTP Ethernet cabling. For additional information on the connections, cabling, software, and operating codes for computer control or updating of the RT-1082, contact your authorized Rotel dealer or Rotel Tech Support.

EXT REMOTE IN Jack ²⁴

This 3.5mm mini-jack receives command codes from industry standard infrared receivers (Xantech, etc.) via hard-wired connections. This feature could prove useful when the unit is installed in a cabinet and the front panel sensor is blocked. Consult your authorized Rotel dealer for information on these external repeaters and the proper wiring of a jack to fit the mini-jack receptacle.

12V TRIGGER Connection ²⁵

The RT-1082 can be activated by a 12 volt trigger signal from a Rotel preamplifier.

The trigger input accepts any control signal (AC or DC) ranging from 3 volts to 30 volts. When a cable is connected to the input and a trigger signal is present, the tuner is activated.

When the trigger signal is interrupted, the tuner goes into standby mode. The front panel indicator light remains lit, but the display goes dark and the unit will not operate.

The RT-1082 will also pass a 12V trigger signal to associated equipment using a trigger. The signal will remain 12V in normal operation.

AC Input ²⁶

Your RT-1082 is configured at the factory for the proper AC line voltage in the country where you purchased it (120 volts AC at 60Hz in the USA and 230 volts AC at 50Hz in Europe). The AC line configuration is noted on a decal on the back of your unit. Make sure that your unit is configured properly for your AC line voltage.

Plug the supplied cord into the AC INPUT receptacle on the back of the unit. Once all other rear panel connections are completed, plug the power cord into an AC wall outlet or switched AC outlet on another system component.

Basic Operating Controls

The following explanations will help you get familiar with the features and controls. When a function is available on both the front panel and the remote, a number (see front panel illustration) and a letter (see remote control illustration) are shown in the instructions. For example, to change from the AM to FM band, you can either press the front panel button or use the button on the remote. When only one identifier appears, that control is available only on the front panel or the remote, but not both.

NOTE: Controls used for tuning the DAB/AM/FM receiver are described in the next sections of this manual.

Standby Button ¹ and Standby LED ²

The STANDBY button is located on the front panel of the RT-1082 and is not duplicated on the remote control.

The STANDBY LED will be lit when the AC input line is connected.

ON and OFF Buttons ^A

Remote only

Pressing the ON button deactivates the standby mode and places the RT-1082 into normal operation. Pressing the OFF button places the RT-1082 into standby mode. Power is still supplied to the unit, but functions are disabled

Remote Sensor ³

This front panel sensor receives infrared signals from the remote control. Make sure you do not accidentally block this sensor with cables or accessories.

Front Panel Display ⁶

The large fluorescent display in the center portion of the RT-1082 provides status information used in operating the DAB/AM/FM receiver (such as station frequency display, band preset memory, RDS information, etc.).

MEMORY Button ¹³ ^K

The MEMORY button is used to confirm and memorize various settings in the setup and operation of the RT-1082, including tuner station presets. Its use is described in detail in the relevant sections below.

ENTER Button ¹¹

Pressing the ENTER button selects the highlighted parameter in the SETUP display.

SETUP Button ¹⁰

Opens and closes the RT-1082 setup menu. This provides the RT-1082 setup menus as well as the ability to change country modes by using the front panel ENTER, UP/DOWN BUTTONS.

DIMMER Button ⁸ ^D

Available on the front panel and remote control, this button selects four display brightness settings. Press the button to cycle through the four settings.

NOTE: When the tuner is turned off then back on, the display reverts to its normal setting. The dimmer setting is also available in the SETUP menu for memory setup until the AC line is disconnected.

Basic Tuning Controls

The RT-1082 features a digital synthesized AM/FM tuner with RDS or RBDS capability, 30 station presets and a DAB tuner with a maximum of 99 station presets.

- Manual frequency tuning lets you tune up or down to the next station frequency. Set the TUNE/PRESET mode to TUNE. Turn off AUTO TUNING. Use the TUNING controls to tune up or down.
- Direct frequency tuning lets you enter the desired station frequency digits. Press the FREQUENCY DIRECT button on the remote or front panel and enter the digits using the NUMERIC buttons.
- Automatic frequency search tuning lets you search up or down to find the next available broadcast signal. Set the TUNE/PRESET mode to TUNE. Turn on AUTO TUNING. Use the TUNING controls to search up or down.
- Memory station preset tuning lets you directly enter the number of a memorized station preset number. Enter the number of the memorized preset using the NUMERIC buttons for the AM/FM or DAB band.
- Preset scan tuning lets you scan up/down through the memorized station presets. Press the PRESET SCAN button to begin scanning the AM/FM bands.
- RDS (Europe) or RBDS (USA) tuning provides a range of special tuning and search features based on data codes encoded with the broadcast signal. See the RDS section of this manual for detailed information.

TUNING Controls **I2 C J**

A pair of buttons, labeled UP/DOWN on the front panel and the FREQ UP/DOWN and PRESET UP/DOWN buttons on the remote, serve as the main tuning controls for the RT-1082. You can use either the front panel or remote buttons; their function is identical. These controls provide different tuning functions, depending on the mode of operation.

BAND Buttons **I7 B**

The BAND button selects whether the tuner will receive DAB, AM or FM broadcast signals. Press the button to toggle back and forth between DAB, AM and FM. A corresponding indicator will light at the left portion of the front panel DISPLAY to confirm your choice. The currently tuned station frequency will be shown.

FREQUENCY TUNING Mode

- With AUTO TUNING off, press a TUNING button to manually jump to the next frequency, regardless of whether or not a station is broadcasting on that frequency. [See the TUNE/PRESET button and AUTO TUNING button sections for details on changing the tuning modes.]
- With AUTO TUNING on, press a TUNING button to start auto tuning. The tuner begins automatically scanning up or down through the frequencies until the next receivable signal is detected. If this is not the desired station, repeat the automatic tuning procedure to find the next station. Weak stations will be skipped during auto tuning. If no receivable signal is detected, the tuner will revert to the last previously tuned station. (See the TUNE/PRESET button and AUTO TUNING button sections for details on changing the tuning modes.)

PRESET TUNING Mode

Press a TUNING button to advance to the next memorized station preset. [See the TUNE/PRESET button section for details on changing the tuning modes.]

RDS PTY search mode

Press a TUNING button to select the desired program type from the scrolling list in the display. See the section on RDS tuning for more details. [See the RDS PTY button section for details.]

NOTE: Several indicators in the front panel display assist tuning. A large display shows the tuned frequency and increases or decreases during tuning. A signal strength indicator shows the strength of an incoming signal. A TUNED indicator lights when a sufficiently strong signal is received. An "ST" indicator lights when a stereo FM signal is received. In addition, indicators show the currently selected tuning mode.

Numeric Buttons

Station Presets **7 E**

The RT-1082 can store up to 30 station presets for recall at any time using the NUMERIC keypad. These station presets can be used for any combination of AM stations and FM stations as well as 99 station presets for DAB.

The RT-1082 is delivered from the factory with a set of generic station presets that may or may not match any available stations in your area.

To memorize a new station preset:

1. Tune to the desired station, AM or FM.
2. Press the MEMORY button on the front panel. A MEMORY indicator will flash in the front panel display.
3. While the MEMORY indicator is flashing, press the number of the preset where you wish to store the station frequency. For example, to memorize the station as preset 3, press the 3 button. To memorize preset 15, press the 1 button followed by the 5 button.
4. A previously stored frequency is erased from memory when a new frequency is memorized for the same preset number.

To tune to a previously memorized station preset, press the preset number using the NUMERIC buttons. For example, to tune to preset 3, press the 3 button. To tune to preset 30, press the 3 button and then press the 0 button within 5 seconds.

NOTE: The NUMERIC buttons can also be used for FREQUENCY DIRECT tuning with the AM/FM band.

Direct Access Tuning

If you know the exact frequency of the desired station, you may tune it directly using the FREQUENCY DIRECT button and the NUMERIC buttons.

1. Press the FREQUENCY DIRECT button to change the NUMERIC buttons from station preset to direct access mode. The station frequency in the front panel display will change to a series of bars, representing the digits of a station frequency, with the first bar blinking.
2. Enter the first digit of the station frequency using the NUMERIC buttons. The digit will appear in the frequency display and the next bar will flash. Enter the remaining digits of the frequency. When all of the digits have been entered, the tuner will automatically tune to the displayed station frequency.

NOTE: On the USA version only, pressing 1 in the FM mode will enter 10 as the digit in the frequency display. On the European version, it is necessary to press 1 and then 0 to enter 10. For US FM stations, press only one digit following the decimal point as shown in the first example following. For European FM stations, press two digits after the decimal point as shown in the second example.

EXAMPLES:

- (USA FM) 87.50MHz Press 8>7>5
- (Europe FM) 87.50MHz Press 8>7>5>0
- (USA AM) 1610kHz Press 1>6>1
- (Europe AM) 1611kHz Press 1>6>1>1

If no frequency is entered within 5 seconds, the tuner will cancel FREQUENCY DIRECT tuning mode and revert to the last previously tuned station.

Auto Tuning Button

The AUTO TUNING button toggles between the frequency search tuning feature and manual frequency tuning. When using the TUNING controls on the front panel or remote in AUTO TUNING mode, the tuner will begin automatically scanning up or down through the frequencies until the next receivable broadcast signal is detected. If this is not the desired station, use the TUNING controls again to find the next station. Weak stations will be skipped during auto tuning. If no receivable signal is detected, the tuner will revert to the previously tuned station. To toggle between FREQUENCY TUNING mode and AUTO TUNING mode, press the AUTO TUNING button. An AUTO indicator will appear in the display.

NOTE: AUTO TUNING mode is disengaged when the TUNE/PRESET button is set to PRESET tuning mode. See the following section.

TUNE/PRESET Button

The TUNE/PRESET button toggles between FREQUENCY TUNING mode (the TUNING controls advance to the next station frequency) and PRESET TUNING mode (the TUNING controls advance to the next memorized station preset). To toggle between the two modes, press the TUNE/PRESET button. A PRESET indicator in the front panel DISPLAY will light when the PRESET mode is active.

NOTE: AUTO TUNING mode is disengaged when the TUNE/PRESET button is set to PRESET tuning mode.

PRESET SCAN Button

This button activates a preset scanning feature. When you press the button, the tuner will automatically scan through all memorized station presets, playing each for five seconds before moving to the desired station preset, press the button again.

NOTE: If a PRESET station is currently tuned when the PRESET SCAN button is pressed, scanning will start with the next higher preset number and continue through all preset stations, stopping on the initial preset. If a PRESET station is not currently tuned when the button is pressed, scanning will start from PRESET 1 and continue to PRESET 30.

FM MONO

The FM MONO button changes the FM mode from stereo reception to mono reception. In stereo mode, a stereo signal will be heard if the station is broadcasting a stereo signal and there is sufficient signal strength. A stereo indicator will light in the front panel display. In mono mode, a mono signal will be heard even if the station is broadcasting a stereo signal.

NOTE: Switching to mono mode can be a useful way to improve the reception of weak or distant FM signals. Less signal strength is required for clean mono reception than for stereo reception.

RDS and RBDS Broadcast Reception

The Rotel RT-1082 is equipped with RDS (Radio Data Systems) reception capabilities for Europe and RBDS (Radio Broadcast Data Service) capabilities for the United States. These broadcast systems provide additional functionality to FM radio reception by transmitting encoded information along with the radio signal. This signal is decoded by an RDS or RBDS receiver and can provide a range of informational features including:

1. A display of the station's identifying name (e.g. BBC1).
2. A display of the station's program content (e.g. ROCK or NEWS).
3. Traffic information broadcasts.
4. A scrolling text display for announcements or information.

In addition, RDS provides several advanced search features including

1. The ability to search for a station with the desired program content (PTY).
2. The ability to search for traffic information (TP).
3. The ability to automatically search stations broadcasting special traffic announcements (TA).

RDS broadcasting has been widely available in many European markets for years. There are a large number of RDS stations and most users will be familiar with the features and operation. In the USA, implementation of the RBDS system is more recent. Fewer stations are currently broadcasting RBDS signals and the features may be less familiar to many users. Consult your authorized Rotel dealer for more information on RDS or RBDS broadcasting in your market.

NOTE: The RDS and RBDS features are entirely dependent on the broadcaster sending properly encoded signals. Thus, they will only be available in markets where RDS or RBDS is currently implemented and where stations are broadcasting these data signals. If there are no RDS or RBDS stations, the RT-1082 will function as a standard radio receiver.

NOTE: RDS and RBDS services are only available on FM broadcasts. The features and buttons described below are only operational in FM mode.

DISPLAY Button

There are five display options when the currently tuned station is broadcasting RDS information and the RDS indicator in the front panel display is lit. Press the DISPLAY button to step sequentially through the five available display options:

1. Standard FREQUENCY display.
2. PROGRAM SERVICE name. This is typically the station's call letters, such as BBC1). If the current station is not broadcasting an RDS signal, the display will show a blinking PS indication.
3. PROGRAM TYPE. This is a description of the station's content from a standardized list of program types in each market (for example: NEWS, CURRENT AFFAIRS, INFO, SPORT, EDUCATION, DRAMA, CULTURE, SCIENCE, VARIED, POP, ROCK, EASY LISTENING, LIGHT CLASSICAL, SERIOUS CLASSICAL, OTHER MUSIC, WEATHER, FINANCE, CHILDREN, SOCIAL AFFAIRS, RELIGION, PHONE IN, TRAVEL, LEISURE, JAZZ, COUNTRY, NATIONAL MUSIC, OLDIES, FOLK, and DOCUMENTARY). If the current station is not broadcasting an RDS signal, the display will show a blinking PT indication.
4. CLOCK TIME. A time and date display broadcast by the station. If the current station is not broadcasting an RDS signal, the display will show a blinking CT indication.
5. RADIO TEXT. Additional scrolling text messages broadcast by the station. If the current station is not broadcasting an RDS signal, the display will show a blinking RT indication.

PTY Button

The PTY search function permits you to scan available signals for RDS stations broadcasting a particular type of program content.

1. Press the PTY button. The current RDS program content type will appear in the display.
2. If desired, change to a different PROGRAM TYPE using the TUNING controls to scroll through the list.
3. Press the PTY button a second time within 5 seconds. The tuner will attempt to find an RDS station broadcasting the selected type of program. If the button is not pressed within 5 seconds after selecting a program type, the PTY function will be cancelled.
4. If no station is located for the desired content type, the tuner will return to the last previously tuned station.
5. Cancel the PTY function by pressing any button (except DIMMER or FM MONO).

TP Button

Searches for an RDS station broadcasting traffic information programming:

1. Press the TP button. The tuner will attempt to find an RDS station broadcasting the traffic programming.
2. If no station is located, the tuner will return to the last previously tuned station.
3. Cancel the TP function by pressing any button (except DIMMER or FM MONO).

TA Button

Searches for an RDS station broadcasting special traffic announcements:

1. Press the TA button. The tuner will attempt to find an RDS station broadcasting traffic announcements.
2. If no station is located, the tuner will return to the last previously tuned station.
3. Cancel the TA function by pressing any button (except DIMMER or FM MONO).

AF Button  

1. Press the AF button. The tuner will scan each of the alternate frequencies for the same programming in the stored list and tune to the strongest signal.
2. If no station is located, the tuner will return to the last previously tuned station.
3. If the signal strength of the new station is weaker, the tuner will revert to the previously tuned station.

Cancel the AF function by pressing any button (except DIMMER or FM MONO).

Digital Audio Broadcast (DAB)

DAB Basic Information

DAB is short for 'Digital Audio Broadcast' and is a new form of radio broadcasting which utilizes digital technology. DAB is capable of providing near CD quality audio with virtually interference free reception.

DAB operates in frequency band III (174 – 240MHz). Band III is divided into 41 channels labeled 5A to 13F.

DAB channels are categorized into ensembles, which are also known as multiplexes. Each multiplex provides a number of stations and each service contains a primary service that can contain secondary services. DAB technology allows broadcasters to transmit additional data along with the audio, which can include other audio channels, text and in the future, even images and computer data.

NOTE: When the DAB tuner is used for the first time the FL display will ask whether you want to auto-tune to find the available service in your area. For most applications auto-tune should only need to be carried out once. Select <YES> to confirm the selection. The tuner will then search automatically for available stations on the DAB network. The number of stations received will depend on the location of your aerial and the available multiplexes in your area. For optimal reception we recommend using a dedicated outdoor aerial.

BAND, DAB Buttons  

The RT-1082 receives AM, FM and DAB signals. DAB mode is selected by pressing the BAND key on the front panel. Direct access to DAB mode can be selected using the DAB button on the remote control

UP / DOWN Buttons  

The UP and DOWN keys available on the front panel and remote control can be used to change between stations and also for selecting options in the set-up menu (see SETUP MENU).

ENTER Button 

Press the ENTER button on the front panel to confirm a selected parameter.

DISPLAY Button  

The RT-1082 displays service identification in the upper portion. This is information received from the network. The RT-1082 allows for several display modes which are shown in the lower portion of the FL display. Press <DISPLAY> button to toggle through the different modes:

- **Program type:** Displays genre or other program information.
- **Ensemble name:** Multiplex identification is displayed.
- **Frequency:** Indicates the frequency that the selected multiplex is transmitted on.
- **Bit rate:** The rate at which bits (information) are transmitted. This is expressed in thousands of bits per second (Kbps), which effectively shows the quality of the broadcast. The higher the bit rate is the better the sound quality is.
- **Dynamic label segment:** This is the text that scrolls across the FL display giving information on the play list and current program content. This feature is subject to the service provider and station.
- **Signal strength:** Indicates the input signal level to the DAB module in block format.

MEMORY Button  

The RT-1082 can store up to 99 DAB preset stations. When you want to save a selected station, press the memory button on the front panel, then one of the numerical buttons on the front panel that you wish to save the station to. FM and DAB memorized stations are separate meaning that a station can be saved to '1' on DAB and another station with the same number for DAB.

NUMERIC Buttons  

The numerical buttons can be used to store to a PRESET station or recall a PRESET.

TUNE/PRESET Button 

The RT-1082 has two operating modes:

- **DAB Manual Mode:** When the tuner is selected to this mode you can scroll through all the available stations using the up and down keys.
- **DAB Preset Mode:** Use the preset button to enable you to use the up and down keys to scroll through your saved stations. Preset is displayed in the FL display when you have selected this operating mode.

Setup Operation

NOTE: The set-up menu features advanced settings. In most installations the factory default will be the optimal required setting for the RT-1082.

SETUP Button 

The SETUP button on the front panel accesses the Setup menu used for the advanced settings of the RT-1082.

SETUP Menu

Press the SETUP button on the front panel to view the menu settings in the FL display. The operation can be cancelled by pressing SETUP again. The menu will also automatically be exited after a short period of when there is no key press.

Use the UP and DOWN keys on the front panel to scroll through the different menu settings. Press the enter button to confirm a selection.

The following options are available: Use of these features will require knowledge of your local DAB transmitter.

DAB DAC VOLUME – The RT-1082 allows level adjustments to the DAC volume. The DAC volume can be adjusted between 0 – 255 using the up and down keys. This feature can be used to match the output signal level of other equipment in your set-up.

DIMMER – Select to change the FL display brightness using the up and down keys. This can be adjusted to your preference.

FACTORY DEFAULT – Select when you wish to return the RT-1082 to its factory settings. Confirm factory default by pressing the ENTER button. **WARNING:** Selecting factory default will erase all saved settings.

TUNER AREA – Your tuner should be set to operate within the country of purchase. The tuner area can be set to either <EUROPE> or <N_AMERICA>.

VERSION – This feature will confirm the main software version of the RT-1082.

Front CPU Upgrade – select this option to upgrade the front CPU. Note: this menu selection is used only with the factory so there is no need for you to use this feature.

EXIT – Select to exit the set-up menu.



Searching for a DAB station

NOTE: When using the DAB tuner for the first time the FL display will ask whether you want to auto-tune to find the available service in your area. For most applications auto-tune should only need to be carried out once. Select YES to confirm the selection. The tuner will then search automatically for available stations on the DAB network. The number of stations received will depend on the location of your aerial and the available multiplexes in your location. For optimal reception we recommend using a dedicated outdoor antenna.

AUTO TUNE button

You may also wish to repeat the search periodically to discover if any new multiplexes (i.e. group of services) have gone on air, or if you move the tuner to a different area.

NOTE: Auto tune will erase any preset stations saved to memory.

1. Select the DAB tuner by pressing the BAND button  on the front panel or the DAB button  on the remote control.
2. Press AUTO TUNE to search for first ensemble stations. The FL display will change to [DAB Auto Tuning] and <No>, <Yes> to perform.
3. Choose <No> by keying the UP/DOWN buttons of front panel, press ENTER if you do not wish to retune. Choose <Yes> by keying the UP/DOWN buttons of the front panel, press ENTER to search new ensembles and replace current stations automatically.

How to store DAB stations

When auto tune is finished the service identification will be displayed. Use the up/down buttons to select the desired station.

To memorize the station press MEMORY followed by the your preference of number.

Example: "Memory" + "1" + "2"

Repeat this process for saving additional stations.

How to call a PRESET

After a station has been saved to memory it can be recalled using the number keys.

Example: "1" + "2"

Specifications

FM Tuner

Usable Sensitivity	14.2 dBf
50dB Quieting Sensitivity	20.2 dBf (mono) 45.3 dBf (stereo)
Signal to Noise Ratio (at 65 dBf)	73 dBf (mono) 70 dBf (stereo)
Harmonic Distortion (at 65 dBf)	0.2% (mono) 0.3% (stereo)
Frequency Response	10 Hz-15kHz, +-3 dB
Capture Ratio	2.0 dB
Alternate Channel Selectivity	47 dB (+-400 kHz)
Spurious Response Ratio	90 dB
Image Rejection Ratio	80 dB
IF Rejection Ratio	80 dB
AM Suppression Ratio	55 dB
Stereo Separation (100Hz/1kHz/10kHz)	40 dB/45 dB/35 dB
Output level	1V
Antenna Input	75 ohms unbalanced

AM Tuner

Usable Sensitivity	500 mV/m
Selectivity	25 dB
Harmonic Distortion	0.5%
Image Rejection Ratio	45 dB
Signal to Noise Ratio	40 dB
Output level	500 mV
Antenna Input	Loop Antenna

DAB Tuner

Sensitivity	-96dBm
Tuning Range	Band III (174-240MHz)
Audio Data Rate	224Kbps (Max)
Frequency Response	20-20KHz
Analog Output	2.0V at 0dBFS
Antenna Output	50 ohms F connector
Digital Output	S/PDIF Coaxial/Optical
Format/Sample Rate	PCM/48KHz

General

Power Consumption	15 watts
Standby Power Consumption	5 watts
Power Requirements (AC)	120 volts, 60Hz (USA version) 230 volts, 50Hz (European version)
Weight	5.4 Kg/11.9lb
Dimensions (W x H x D)	432 x 92 x 343mm 17 ¹ / ₈ " x 3 ⁵ / ₈ " x 13 ¹ / ₂ "
Panel Height	80 mm / 3 ³ / ₁₆ "

All specifications are accurate at the time of printing.

Rotel reserves the right to make improvements without notice.

Rotel and the Rotel HiFi logo are registered trademarks of The Rotel Co, Ltd., Tokyo Japan.

Free Manuals Download Website

<http://myh66.com>

<http://usermanuals.us>

<http://www.somanuals.com>

<http://www.4manuals.cc>

<http://www.manual-lib.com>

<http://www.404manual.com>

<http://www.luxmanual.com>

<http://aubethermostatmanual.com>

Golf course search by state

<http://golfingnear.com>

Email search by domain

<http://emailbydomain.com>

Auto manuals search

<http://auto.somanuals.com>

TV manuals search

<http://tv.somanuals.com>