

# Rowenta

## LISSIMA

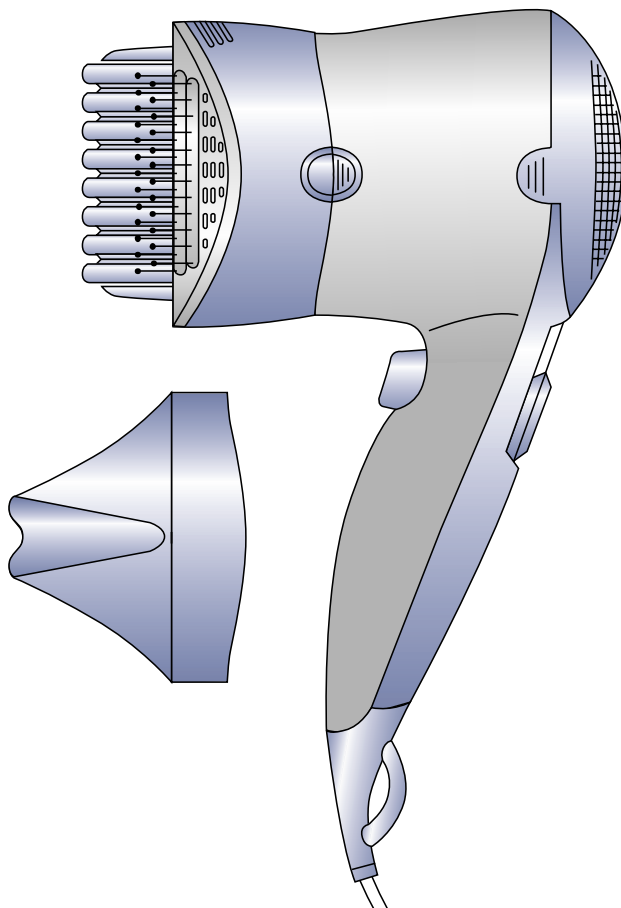

Gebrauchsanweisung  
Instructions for use  
Notice d'emploi  
Istruzioni per l'uso  
Modo de empleo  
Modo de utilização  
Инструкция по  
использованию  
Kullanma talimatı  
Οδηγίες χρήσεως

دليل الاستعمال

030140 - 26/03 PH570

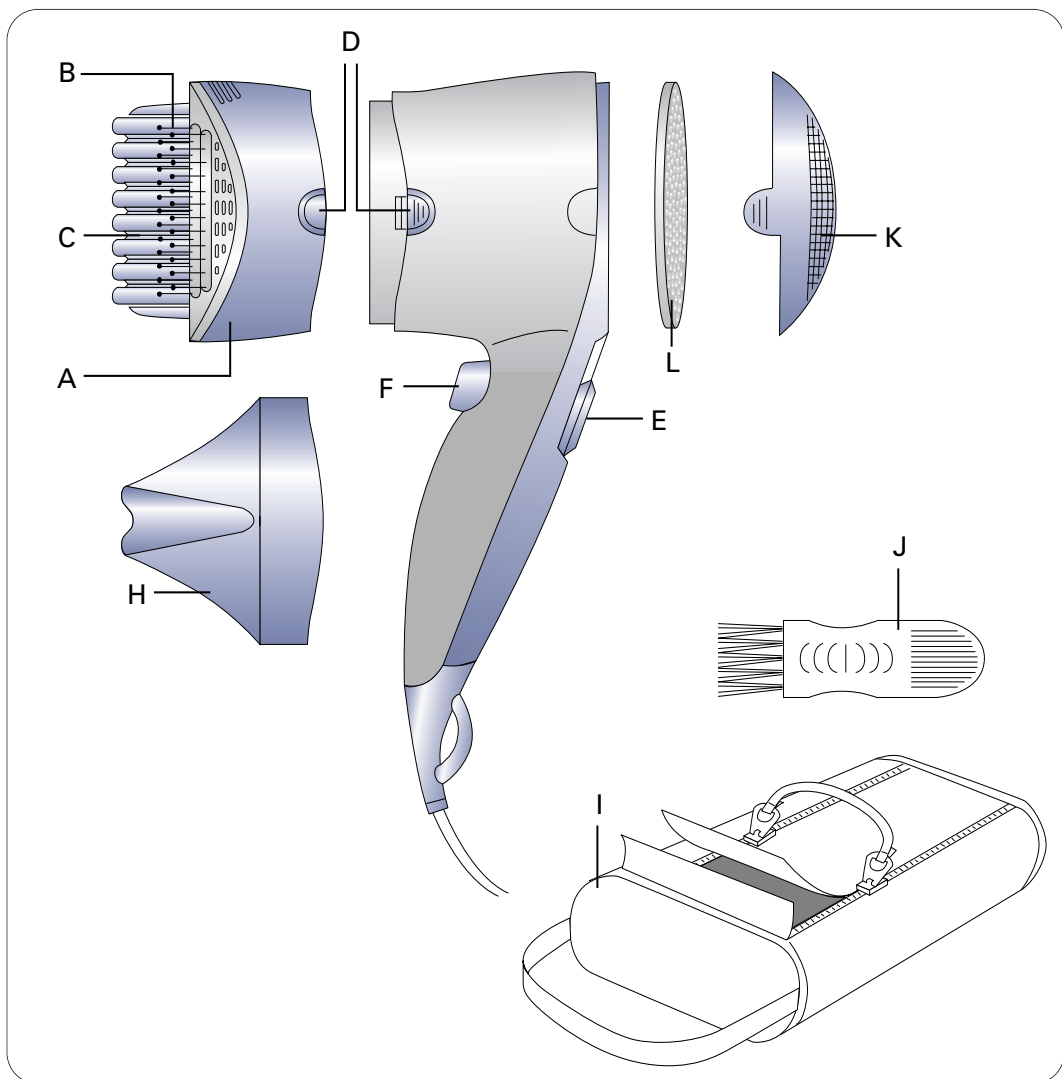

## D 1. ALLGEMEINE BESCHREIBUNG

- A. Zubehör zum Glätten
- B. Kämmе
- C. Scheiben zum Glätten " Ultra-liss system "
- D. Taste zum Entfernen des Zubehörs
- E. Steuertaste
- F. Fixierknopf
- G. Haltering
- H. Konzentrator
- I. Tasche (zum Aufbewahren von Gerät und Zubehör)
- J. Reinigungszubehör
- K. Abnehmbarer Filterschutz
- L. Filter

## GB 1. GENERAL DESCRIPTION

- A. Straightener attachment
- B. Combs
- C. "Ultra-liss system" smoothing prongs
- D. Attachment removal button
- E. Control button
- F. Cold air shot button
- G. Ring hanger
- H. Concentrator
- I. Carry case (dryer and attachments)
- J. Cleaning brush
- K. Removable grid
- L. Filter

*LISSIMA is a new Professional Hair straightener, specially designed to straighten and style all types of hair (long or shoulder-length, wavy or very curly): you will be able to blow your hair dry quicker and easier than with a traditional dryer. A LISSIMA dryer is held in one hand and will ensure a perfectly smooth style at the front and the back of your head.*



*Used with its slim concentrator nozzle attachment, LISSIMA also functions as a classic hair dryer.*

*To obtain the best results with your LISSIMA dryer, read the instructions and safety precautions carefully before using.*

## 2. SAFETY RECOMMENDATIONS

- Ensure that the voltage of your electrical installation corresponds to that of your appliance. Incorrect connection may cause irreversible damage which will not be covered by the guarantee.
- Don't use your appliance and contact a service Centre if:
  - your appliance is dropped
  - if it doesn't work normally
- Never use the dryer with wet hands or near water in a bath, washbasin or any other recipient.
- If the hair dryer is used in a bathroom, disconnect after use since water can present a danger even when the hair dryer is not being used.
- The dryer must be disconnected:
  - before cleaning and maintenance.
  - in the event of a malfunction
  - as soon as you have finished using it
  - if you have to leave it unattended, even for a few moments.
- To ensure additional protection, we recommend that you have a differential residual circuit breaker installed, with an operating differential of no more than 30 mA. Contact your installer for advice.
- If the power cable is damaged, it must be replaced by the manufacturer, its after-sales service or a person with similar qualifications to avoid any danger.
- If the power cable is damaged, it must be replaced by the manufacturer, its after-sales service or a person with similar qualifications to avoid any danger.
- The dryer is equipped with a heat-sensitive safety device. In the event of overheating (for example if the rear grill is blocked), the dryer will stop automatically: contact the After-Sales Service.



## GUARANTEE

This appliance has been designed for a domestic use only. It can not be used in any professional application. The guarantee becomes null and void in case of incorrect use.

## 3. RECOMMENDATIONS FOR USE

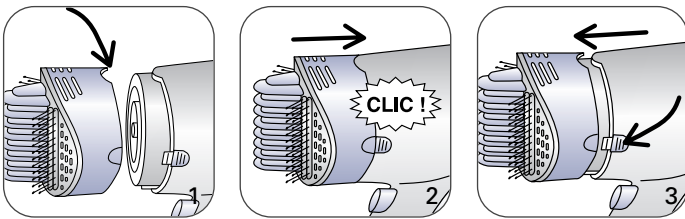

### FITTING AND REMOVING ATTACHMENTS:

Place the attachment (STRAIGHTENER or CONCENTRATOR) onto the dryer, with the notch at the top (Fig. 1). Push gently until the attachment clicks into place (Fig.2).

To remove: press on the buttons (Fig.3) to remove the attachment.

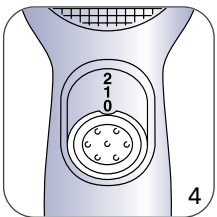

### SPEEDS:

LISSIMA has 2 heat/speed settings†(Fig.4):

- Level " 1 " : average airflow and heat to style your hair (ideal for a perfectly smooth result).
- Level " 2 " : faster airflow, ideal for drying your hair fast.

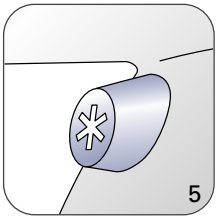
**LOCKABLE COOL SHOT BUTTON:**

To fix your hairstyle, you can direct cooler air towards your hair when it is almost dry.

Press the "Cool shot" button (Fig. 5), then press the button again to return to the original temperature.

**CONCENTRATOR:**

The concentrator directs the air onto your hair for more styling control (Fig.6).

**HOW TO USE LISSIMA ?**

**The basic technique for straightening hair from the roots to the ends is as follows:**

- After shampooing your hair, dry it well on a towel and comb to remove any tangles.
- Dry your hair slightly using the hair dryer function (with or without the concentrator attachment) leaving it damp.

- Fix the " Ultra-liss system " straightener attachment in place and select speed " 1 ".

Place the dryer at the roots of your hair, above and below the lock of hair to be straightened, ensuring that the lock of hair goes through the smoothing prongs (Fig.7 and 8).

- Turn the dryer slightly so the lock of hair is caught between the prongs, then slide the dryer along the length of the hair to the ends (Fig.9).

Repeat until you achieve the required result.

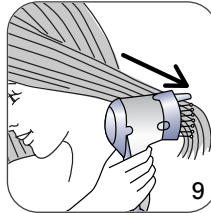
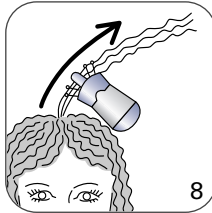
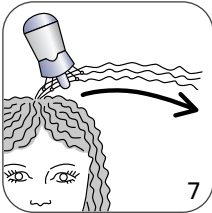
**4. TIPS ON ACHIEVING A PERFECT STYLE**

The LISSIMA dryer offers a number of possibilities. Here are a few **techniques and tips** on how to smooth your hair into various straight styles.

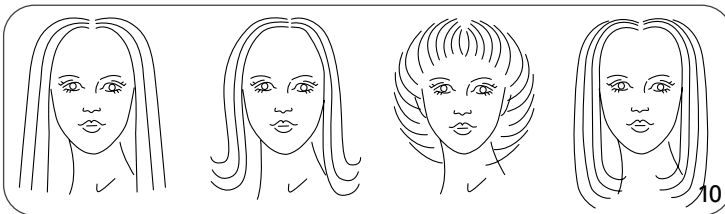

## Volume at the roots:

Once your hair is dry and straightened, place the dryer at the roots again, under the lock of hair to be styled, insert the smoothing prongs into the thickness of the hair and start smoothing the lock in the opposite direction to the way the hair grows for about 3 cm (Fig. 11), then hold the dryer against the scalp for 5 secs with the "cool air shot" button pressed, (Fig. 12) and finally allow the dryer to slide to the end of the lock of hair (Fig. 13).

*To give overall volume to your hairstyle, you must apply this process to each lock of hair.*



## A smooth, shaped fringe:

Dry your fringe, leaving it damp. Take the whole fringe in one hand, place the dryer at the root of your hair, under the fringe and smooth the hair vertically above your head (Fig.14), then slide the dryer slowly to the end of the fringe

To curve your fringe inwards, take the fringe in your other hand and place the hair between the smoothing prongs, following the curve of the dryer (Fig.15). Keep this position for 5 seconds with the "cool air shot" button pressed to set the curved shape.

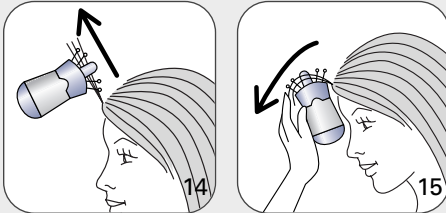

## Turning the ends of your hair under or flicked up:

**You can give this shape to a few locks of hair only or achieve an all-over effect.**

The dryer should be under the lock of hair.

Straighten the lock of hair in question and when you reach the end, block the ends of your hair with your other hand or a comb (Fig.16), turning the hair around the rounded base of the dryer. To emphasise the shape, turn the dryer further inwards.

To flick your hair out at the ends (Fig.17): Follow the same method but with the dryer above the lock of hair

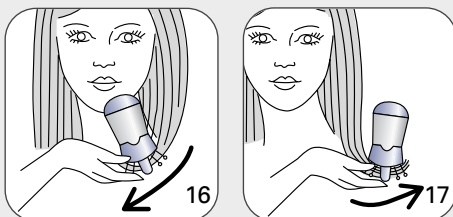

# HOW TO STRAIGHTEN LONG OR SHOULDER-LENGTH HAIR? :

(fig.18/19)

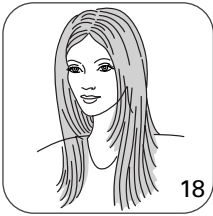

**Gradually separate your hair into 5 sections.**

**Section 1 :** Start by straightening the hair at the nape of your neck.

- Separate your hair horizontally with a comb, taking it from below one ear to the other ear (Fig.20).
  - Attach the rest of your hair with a hair clip.
  - Separate the hair at the nape into 3 vertical sections (Fig. 21):
- Start by straightening the side sections followed by the central section.
- Take the hair clip out and separate your hair as indicated in section 2.

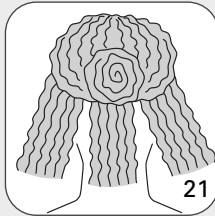

**Section 2:** Straightening the hair at the back of your head.

- Separate your hair horizontally from the top of one ear to the other ear (Fig.22)
- Attach the rest of your hair and do the same as for section 1.

**Section 3:** Straightening the hair at the sides.

- Separate your hair vertically from its "natural" parting down to your ear (Fig.23)
- Attach the hair on the top of your head and straighten the hair on either side of your face using the basic technique.
- Remove the clip and finish by straightening the locks of hair on the top of your head (Fig.24).

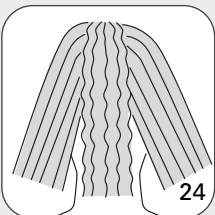

## HOW TO STRAIGHTEN SHOULDER-LENGTH, LAYERED HAIR:

(fig.25)



- Dry your hair until just damp using the normal hair dryer function, **with your head leaning forward.**
- Keep your **head down and straighten each lock of hair** (Fig.26), starting with the fringe and gradually working your way down to the side sections and top of the head, finishing by the hair at the nape.
- To obtain a straight style with curved volume, use this technique by placing the dryer under the lock of hair.
- **To obtain a straight, flat style**, the dryer should be held above the lock of hair.

## HOW TO STRAIGHTEN A SHORT, CLUB CUT WITH FEATHERED ENDS : (FIG.27)



- Dry your hair until just damp using the normal hair dryer function.
- Separate the hair into two parts vertically, from the crown of your head to the base of the nape (Fig.28).
- Start by straightening the first part of the hair at the nape, placing the dryer on the outside of the lock in a root -> end movement.
- Repeat the process until both sides of the nape are perfectly smooth.
- Continue with the hair at the sides of your face and end by the top of your head and fringe (if there is one).
- To obtain a straight style with curved volume, use this technique by placing the dryer under the lock of hair.
- To obtain a straight, flat style, the dryer should be held above the lock of hair.
- To ensure the ends are very smooth and straight and not curved (Fig.29), slide the dryer to the ends of your hair without turning it, keep this position for 5 secs with the cool air shot button pressed in, then gently release the lock of hair (Fig.30).

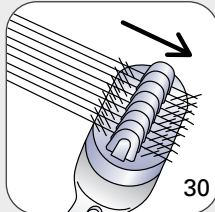
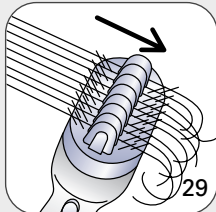
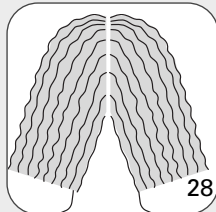

- You can of course use all your normal hair beauty products (conditioner, masks, mousse, lacquer and styling gel, etc..)

- **Caution!** never use the dryer with a chemical perming product. Your hair would not survive!

## 5. MAINTENANCE

CAUTION!: always disconnect the dryer before cleaning.

### A- Cleaning the dryer:

-Your dryer needs very little maintenance. You can wipe with a dry or damp cloth.

### Removable grill for easy maintenance:

this appliance is equipped with a rear grill and an ultra-fine filter (Fig.31) so as to prevent hair from entering the appliance. It is recommended to clean the filter regularly.

- Never use surgical spirit or similar to clean your dryer.
- Never immerse the dryer or attachments in water.
- Dry the parts you have cleaned very carefully.

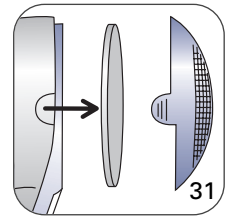

GB

### B- Cleaning the attachments:

- We recommend regular cleaning of the straightener attachments with the small cleaning brush provided.
- First remove the straightener attachment, then remove any hair clogging the plates, using the part of the cleaning attachment with rigid teeth (Fig.32), then finish with the soft brush.

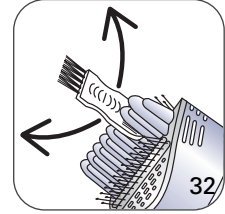

## 6. PROTECTION OF THE ENVIRONMENT

At the end of the life of your product, it should go to a specially-adapted waste recycling centre.



## 7. IN THE EVENT OF A PROBLEM

### LISSIMA blows cool air !:

- 1) You have inadvertently pressed the "cool shot" button
- 2) The thermostat has cut out because the "Ultra-liss system" or rear grill need cleaning with the cleaning attachment (cf. Paragraph 5).

If the problem persists after cleaning, contact the After-Sales Service.

- 3) You are allowing your hair to remain too long in contact with the "Ultra-liss system".

### The straightening effect is not efficient enough !:

Your hair is too wet, dry it off a little.

## WIRING INSTRUCTIONS - FOR U.K. ONLY.SAFETY NOTES FOR REWIREABLE OR MOULDED PLUG

The mains lead of this appliance may be already fitted with a BS 1363 13 A plug. Should the fuse need to be replaced, a 13 A ASTA approved BS 1362 fuse must be used.

If your socket outlet is not suitable for the plug, then the plug must be removed (cut off if it is a moulded on plug) and an appropriate one fitted. Warning : dispose of a plug that has been cut from the power supply cord, as such a plug is hazardous if inserted in a live 13 A socket outlet elsewhere in the house.

Always replace the fuse cover after fitting a fuse. The plug must NOT be used if the cover is omitted or lost until a replacement is obtained - make certain that only the correct fuse cover is used and fitted.

For plugs with a detachable fuse cover the replacement must be the same as the colour insert in the base of the plug, or as directly by the embossed wording on the base of the plug.

If the detachable fuse cover is lost, a replacement may be purchased from an approved Rowenta Service Centre (see enclosed Service Information leaflet). Information for supply may also be obtained from the plug manufacturer.

### U.K ONLY - FITTING A PLUG

Important : the wires in this lead are coloured in accordance with the following codes Blue, Neutral, Brown, live. Please read the instructions given below before connecting the cord to a plug. If in doubt, please consult a qualified electrician.

As the colours of the wires in the mains lead of this appliance may not correspond with the coloured markings identifying the terminals in your plug, proceed as follows :

- the wire which is coloured BLUE must be connected to the terminal which is marked with the letter " N " or coloured BLACK.
- the wire which is coloured BROWN must be connected to the terminal which is marked with the letter " L " or coloured RED.

Neither core is to be connected to the earth terminal of a three-pin plug.

This appliance requires a 13 fuse ASTA approved to BS 1362.

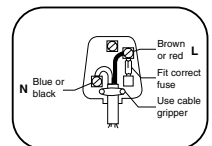



## Free Manuals Download Website

<http://myh66.com>

<http://usermanuals.us>

<http://www.somanuals.com>

<http://www.4manuals.cc>

<http://www.manual-lib.com>

<http://www.404manual.com>

<http://www.luxmanual.com>

<http://aubethermostatmanual.com>

Golf course search by state

<http://golfingnear.com>

Email search by domain

<http://emailbydomain.com>

Auto manuals search

<http://auto.somanuals.com>

TV manuals search

<http://tv.somanuals.com>