

Rowenta

PRO ACTIVE

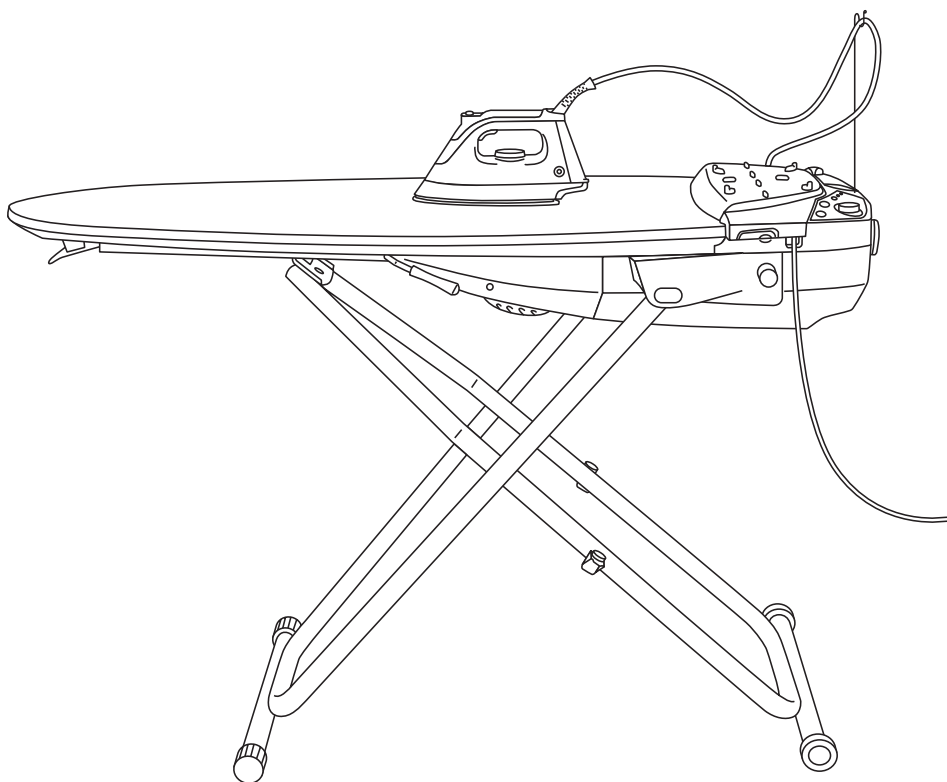

1 • UNDERSTANDING YOUR IRONING CENTRE

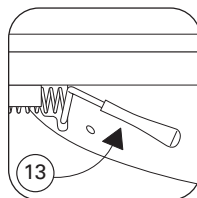
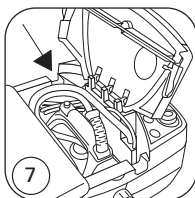
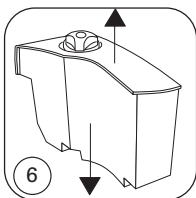
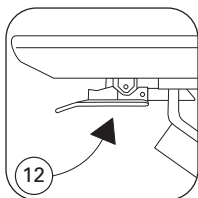
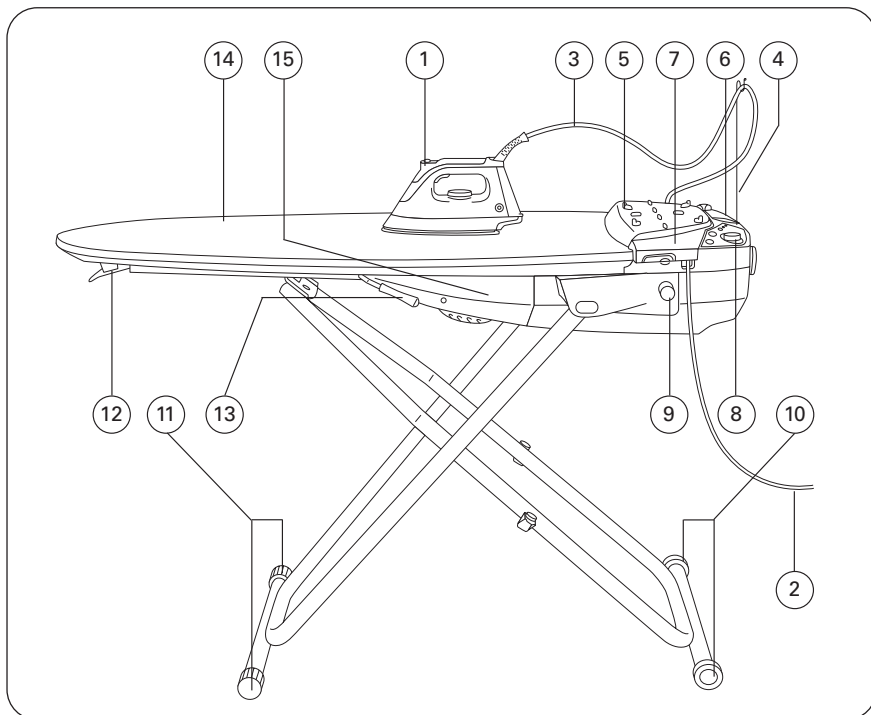

1. Iron
2. Electric power cord (iron + board)
3. Steam cord
4. Steam cord support
5. Iron rest-plate
6. Removable water tank
7. Iron, power cord and steam cord storage space
8. Control panel
9. Steam generator screw-clamps
10. Wheels (rubber-coated to protect delicate floors)
11. Feet
12. Semi-automatic **opening** lever (use **only** to open the board)
13. Board **closing** and height adjuster lever (use this lever to close the board)
14. Heated, active ironing area with ironing board cover
15. Suction-blower unit

a) Control panel

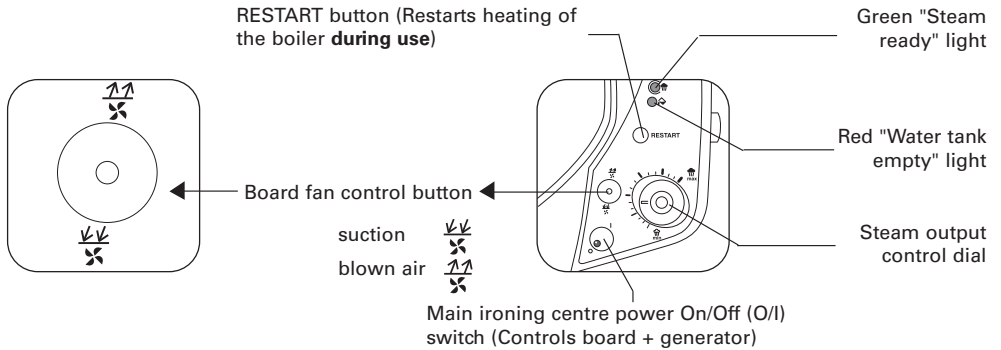

b) Heated board with suction and blown-air functions

Board heats up automatically when the ironing centre is switched on.

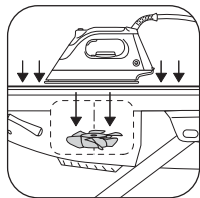

Suction function

Inside the board, the suction fan sucks air through the board.

Blown air function

Inside the board, the blower fan blows air through the board.

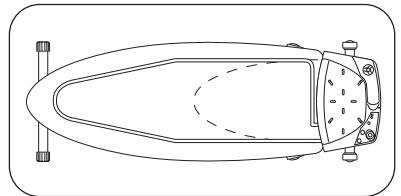
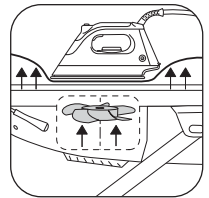

c) Iron

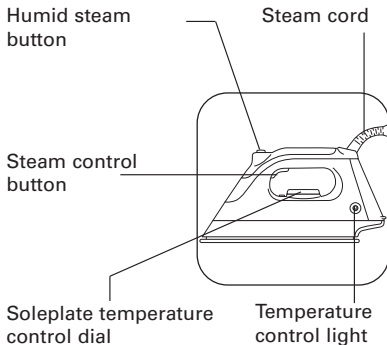

d) Steam generator

Iron, power cord and steam cord storage compartment catches

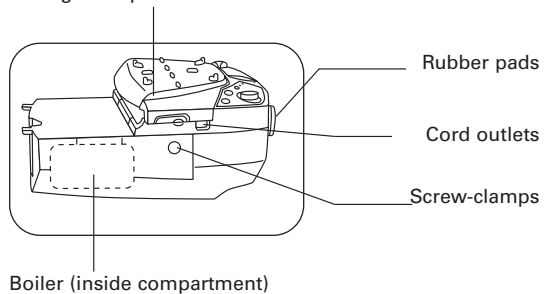

2 • PREPARING YOUR IRONING CENTRE

1. **Always** place your ironing board on the floor in a horizontal position. (1)
2. Hold down the ironing board feet under one of your own feet. (2)
3. Use your hand to press the semi-automatic opening lever located underneath the front end of the board, then raise the board to the required height (2).
4. If the board is too high for comfort, adjust its position using the adjuster lever (3).
5. Lift up and remove the water tank. (4)
6. Unscrew the water tank cap.
7. Fill the water tank, taking care not to exceed the maximum level. (4)
8. Replace the cap on the water tank.
9. Replace the water tank in its housing, **pressing down** until it clicks into place (5).

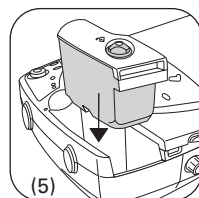
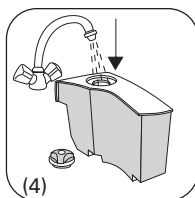
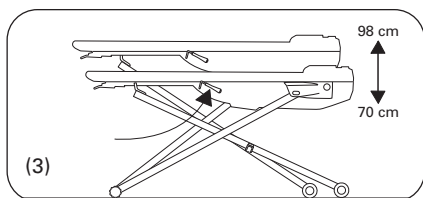
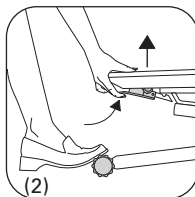
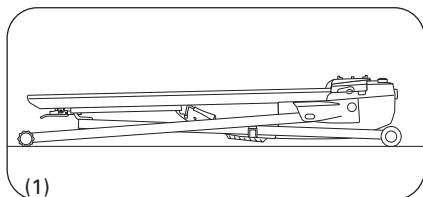

Suitable water:

Your steam generator has been designed to operate using untreated tap water. However, if your water is very hard, mix 50 % untreated tap water with 50 % distilled water. The ironing centre comes with a tester that can be used to test the hardness of the water.

Unsuitable water:

Do not add anything to the contents of the removable water tank, and do not use water from clothes-dryers, scented or softened water, water from refrigerators, batteries or air conditioners, pure distilled water, pure demineralised water or rainwater, as these types of water contain organic waste or mineral elements that become concentrated when heated and cause spitting, brown staining or premature wear to the appliance.

3 • USING YOUR IRONING CENTRE

1. Open the storage compartment cover by lifting the catches located on each side of the iron rest-plate (6).
2. Remove the iron, steam cord and electric power cord from the storage compartment. (7)
3. Insert the power cord and steam cord in the cut-outs located on the sides of the storage compartment. The ironing centre can be configured for left- or right-handed use.
4. Close the storage compartment cover and place the iron on its rest-plate (8).

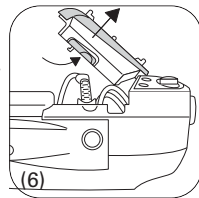

Warning : Your ironing centre is equipped with a safety device which cuts the power supply when the iron is stored in its compartment.

To switch the iron on again, it is imperative that the iron is removed from its storage compartment first.

5. For maximum ironing comfort, fit the steam cord support in its mounting and feed the steam cord through the support loop (9).
6. **Connect the power cord to an earthed mains socket.**
7. Switch on the main On/Off (O/I) switch (located on the control panel on the ironing board) (10 -①). The green light on the control panel will start to flash and the boiler will heat up (10 -②). When the green light stops flashing (after approximately 2 minutes), the steam supply is ready.

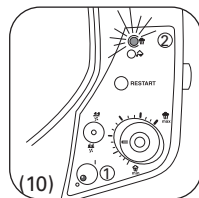
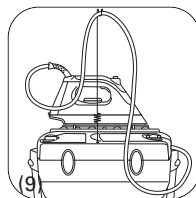
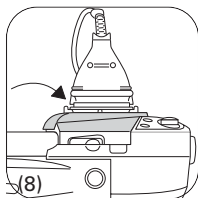
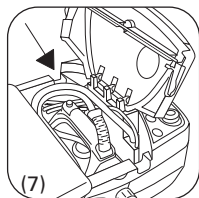

When you switch on your ironing centre, the ironing board surface heats up automatically, eliminating any risk of steam condensing. Your ironing board's surface will reach its operating temperature in approximately 7 minutes. This does not prevent you from starting your ironing as soon as the steam supply is ready (after 2 minutes).

- The first time you use your ironing centre, some fumes and a harmless smell may be released. They will not affect use and will quickly disappear.
- After about a minute, and at regular intervals during use, your appliance's electric pump will inject water into the boiler. It makes a noise, but this is quite normal.

4 • OPERATING THE CONTROL PANEL

- Flashing green light: Water is heating in the boiler.
- Continuous green light: The steam supply is ready for use.
- Continuous red light: The water tank is empty.
- RESTART button: Press this button to restart boiler heating, whenever you have stopped to refill the water tank (see chapter 9).

5 • SUCTION AND BLOWN-AIR FUNCTIONS

Your ironing centre is equipped with a range of professional ironing features. In addition to an automatically heated ironing board surface, your appliance is equipped with fans providing suction and blown-air functions which ensure outstanding ironing quality.

a) Suction and blown-air fan control button

BLOWN AIR position
Position O (no ventilation)
SUCTION position

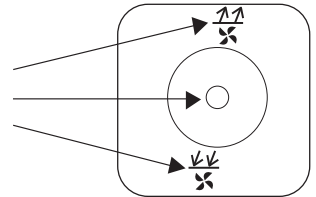

b) The benefits of the suction and blown-air functions include

BLOWN-AIR FUNCTION:

When you switch the control button to the blown-air position, the blower system is activated, creating an air cushion between the board and fabric. The blown-air function is recommended for:

- Ironing delicate fabrics (e.g. silk or wool);
- Preventing accidental creases on large and medium-sized items (e.g. tablecloths, sheets or jacket backs);
- Avoiding "buffing" fabrics, and preventing lines and seam marks.

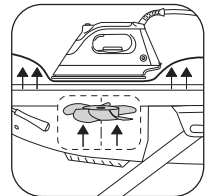



SUCTION FUNCTION:

When you switch the control button to the suction position, the suction system is activated, creating a downward airflow. The suction function is recommended for:

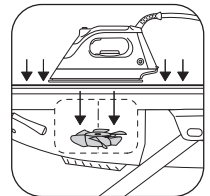
- Holding items in place on the ironing surface;
- Clearly marking creases (e.g. trouser creases);
- Ironing thick fabrics (e.g. denim and linen);
- Eliminating any residual moisture;
- Preventing steam from escaping while you are ironing.



c) Tips for using the suction and blown-air functions according to the type of fabric

 BLOWN AIR	<p>Delicate fabrics: silk, synthetic materials</p> <p>Delicate finishes: gathers, frills, glitter, embroidery, lace, etc.</p> <p>Linings and seams: jacket linings, double-layered delicate fabrics, etc.</p>
 SUCTION	<p>Thick and heavy fabrics: cotton, denim, corduroy, linen, tweed, wool, etc.</p> <p>Creases and turn-ups: pleated skirts, trouser turn-ups, knife pleats, etc.</p> <p>Lined finishes: cuffs, collars, waistbands, hems, button-holes, shirt back pleats, etc.</p>

For a more detailed explanation, please refer to the enclosed booklet entitled "Ironing Tips", inside the box.

6 • STEAM IRONING

1. Set the iron's temperature control selector according to the type of fabric to be ironed (11)
2. The iron temperature control light will light up.

Important: The ironing centre is ready when the iron temperature control light goes out and when the green "steam ready light" on the board's control panel stays continuous.

It is perfectly normal for the iron temperature control and boiler lights to switch on and off during use, according to the heating requirements. This does not prevent you from continuing to iron in the usual way.

3. Adjust the steam output (using the steam output control dial located on the control panel) (12).

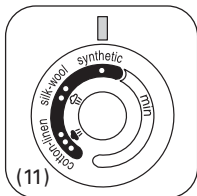

- Synthetics (low temperature)
- Silk/Wool (medium temperature)
- Cotton/Linen (high temperature)

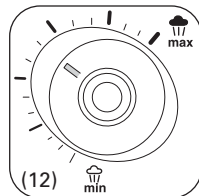

Set the iron's temperature control and steam output control dial according to the type of fabric to be ironed :

Fabric type	Iron temperature control setting	Steam output control dial setting
Synthetics	<p>● Low temperature</p>	
Silk / Wool	<p>●● Medium temperature</p>	
Cotton / Linen	<p>●●● High temperature</p>	

We advise you to begin by ironing any fabrics requiring a low temperature setting, e.g. synthetics (●)

To obtain steam, press on the steam control button located beneath the iron handle (13).

The flow of steam will stop when you release the button.

With delicate fabrics (●), press the steam control button under the iron handle intermittently, to avoid possible water droplets appearing with the steam.

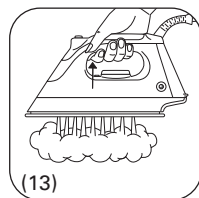

Recommendations:

- Before you begin using the iron, or if you have not used any steam for a few minutes, press the steam control button several times in a row, holding the iron away from your clothes. This will enable any cold water to be removed from the steam-circuit.
- Iron temperature control setting:
 - Start with any fabrics to be ironed at a low temperature (●), and finish with those which need higher temperatures (●●● or Max).
 - Mixed-fibre fabrics: Set the ironing temperature to the setting for the most delicate fabric.
 - Woollen garments : Press the iron's steam control button intermittently to produce short bursts of steam, without placing the iron on the garment itself.
- Steam output control dial setting:
 - Thick fabrics: Increase the steam output setting.
 - Low temperature ironing: Set the steam output control dial to the low position.
- Dry ironing: Do not press the steam control button under the iron handle.
- If you are using starch, it should be sprayed onto the reverse side of the fabric to be ironed.
- Ironing board cover:

We recommend ironing the ironing board cover with a very hot iron before you use it for the first time. For perfect results every time, only replace with a Rowenta ironing board cover available from our authorised service dealers.

7 • VERTICAL STEAM IRONING

1. Set the iron temperature control and the steam output control dial (located on the control panel) to the maximum position.
2. Hang the garment on a coat hanger and hold the fabric slightly taut with one hand.

As steam is very hot, never attempt to remove creases from a garment while it is being worn - always hang garments on a coat hanger.

3. Holding the iron in a vertical, tilted position, press in one second bursts on the steam control button (located beneath the iron handle) while moving the iron from top to bottom (14).

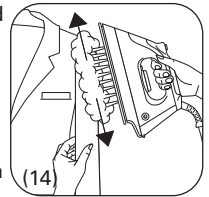

Recommendations: With fabrics other than linen or cotton, hold the iron a few centimetres away from the garment, to avoid burning the fabric.

8 • HUMID STEAM FUNCTION

Press the humid steam button (15) two or three times to obtain a steam boost as required:

- When ironing thick fabrics,
- In order to eliminate unwanted creases,
- For powerful vertical crease removal.

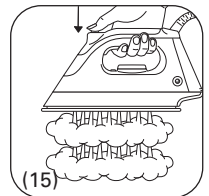

Important: Use the humid steam function very carefully because of the exceptional power of the steam that may cause burns.

9 • WHAT TO DO IF THE RED "WATER TANK EMPTY" LIGHT COMES ON

You can use your steam generator indefinitely, thanks to its removable water tank.

The red light (16:①) comes on when there is no more steam. The removable water tank is empty.

1. Unscrew the water tank cap.
2. Lift up and remove the water tank.
3. Fill the water tank.
4. Replace the cap.
5. Replace the water tank in its housing, **pressing down** until it clicks into place (17).
6. Press the boiler RESTART button (16:②) on the control panel to continue your ironing.

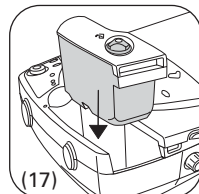
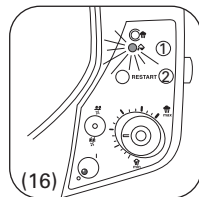

10 • MAINTAINING YOUR IRONING CENTRE

- **Before cleaning your appliance, ensure that it is unplugged and that the soleplate and the iron rest-plate have cooled down.**
- Do not use any cleaning or descaling products when cleaning the soleplate or boiler.
- Never hold the iron or steam generator under the tap.
- Do not place the iron on a metal rest, as this could damage it.
Place it instead on the supplied rest-plate, which is fitted with non-slip pads and is designed to withstand high temperatures.

a) Removable water tank

Empty and rinse the removable water tank (18)

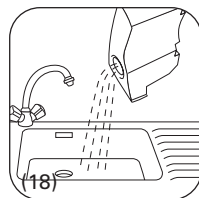

b) Iron soleplate

We recommend that you clean the soleplate using the Rowenta soleplate cleaning stick available from Rowenta Approved Service Centres (see After Sales Service chart for addresses).

The iron's high quality soleplate protects your laundry and makes ironing smoother.

When you are not ironing, you should always place the iron on its rest-plate; never stand the iron on its heel.

Do not place the iron on rough surfaces. Do not scratch or scrape the soleplate. Never clean it with corrosive or abrasive agents.

Never iron over zips or rivets eg on jeans.

c) Ironing board and iron

Clean the plastic parts of the iron and the ironing board legs occasionally by wiping with a damp cloth.

d) Ironing board cover

- We recommend ironing the ironing board cover with a very hot iron before you use it for the first time.
- **Washing instructions: machine-washable at 40°C.**
- **Removing the cover:**
 1. Loosen the drawstring by pulling the fastener downward (19).
 2. You can now remove the cover.
- **Replacing the cover:**
 1. Check that the drawstring is loose by pulling the fastener downward.
 2. Spread out the cover, wrapping it all round the board.
 3. Tighten the drawstring by moving the fastener upwards.
- **Replacement ironing board covers are available. Product reference: ZD 7200.**

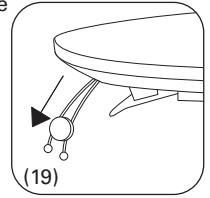

11 • RINSING OUT THE BOILER

Important :

- To extend the life of your boiler and to avoid any build-up of scale, it is **essential** to rinse out the boiler after every 10 uses. If your water is hard, you should rinse the boiler more frequently.
- Never use descaling agents when rinsing out the boiler, as they could damage it.

a) Rinsing the boiler using the rinsing accessory

For easier and more effective boiler rinsing, we recommend using the rinsing accessory supplied with your ironing station (20).

It will make rinsing the boiler easier as the steam generator will require less handling.

Your rinsing accessory has been designed to fit a wide range of taps. It is supplied with two types of membrane (21) (a) (b). Choose the one best suited to your tap.

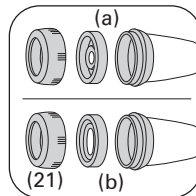
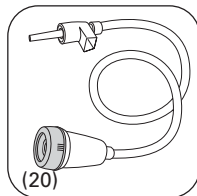

Before rinsing your steam generator, you MUST let your ironing station cool for 2 hours, to prevent any risk of burns.

Recommendation:

To avoid the need to wait, we recommend rinsing the boiler before you start your ironing session.

1. Completely unscrew the clamping knobs located on each side of the steam generator unit (22).
2. **Handle the steam generator unit with care.** Slide it gently backwards (23 -①). There are stops to prevent the steam generator from sliding too far. When it reaches the stops, lift the steam generator slightly, holding it **firmly** with both hands until it has been completely removed (23 -②).
3. Place your steam generator on the edge of your sink.
4. Use a coin to unscrew the boiler drain plug (24).
5. Insert the plastic nozzle of the rinsing pipe into the hole in the boiler, and gently twist clockwise until it locks. The outlet of the nozzle should be positioned over the sink (25).
6. Connect the rubber end of the rinsing pipe to the cold tap (26).
7. **Gradually** turn on the tap to provide a **moderate** flow of cold water through the rinsing pipe for approximately one minute (27).
8. Turn off the tap and remove the rinsing pipe.
9. **Replace the boiler drain plug and tighten using a coin.**
10. **Replace the steam generator in its housing and tighten the two steam generator unit clamps.**

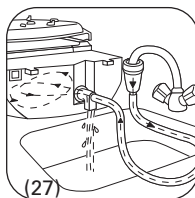
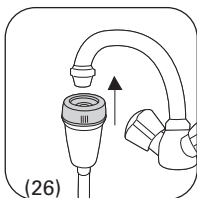
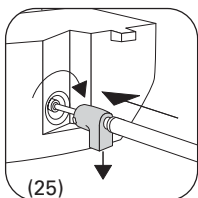
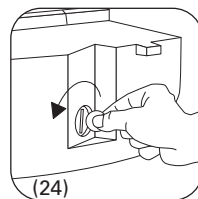
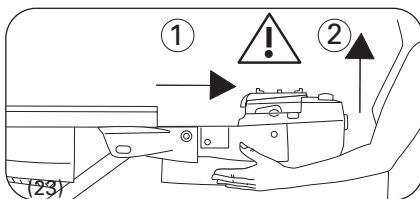
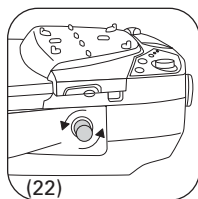

If neither of the rubber membranes fits your tap, refer to the procedure described in paragraph b) below:

b) Rinsing the boiler without using the rinsing accessory

Before rinsing your steam generator, you **MUST** let your ironing station cool for 2 hours, to prevent any risk of burns.

Recommendation:

To avoid the need to wait, we recommend rinsing the boiler before you start your ironing session.

1. Completely unscrew the clamping knobs located on each side of the steam generator unit (22).
2. **Handle the steam generator unit with care.** Slide it gently backwards (23 -①). There are stops to prevent the steam generator from sliding too far. When it reaches the stops, lift the steam generator slightly, holding it firmly with both hands until it has been completely removed (23 -②).
3. Place your steam generator on the edge of your sink.
4. Use a coin to unscrew the boiler drain plug (24).

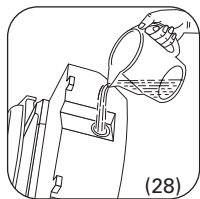

5. Hold the steam generator in a tilted position and use a jug to pour 1/4 litre of water into the boiler. (28)
6. Gently shake the unit for a few seconds, then **completely empty** it over a container or your sink. (29)

For best results, we recommend that this operation is done twice.

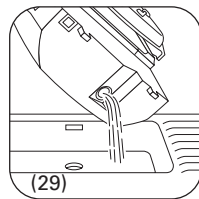

7. Replace the boiler drain plug and tighten using a coin.
8. Replace the steam generator in its housing and tighten the two steam generator unit clamps.

12 • PUTTING YOUR IRONING CENTRE AWAY

1. Switch off your ironing centre by pressing the main On/Off (O/I) switch.
2. **Take care to unplug the appliance from the mains socket.**
3. You can now store your iron in its storage compartment, even if the soleplate is still hot (30).
Never leave the iron in its storage compartment with the ironing centre plugged in.
4. Close the storage compartment cover.

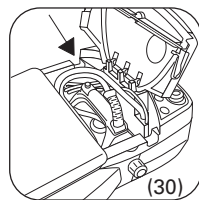

13 • FOLDING YOUR IRONING BOARD

Lift the board-adjuster lever (31) and simultaneously press the board down until it is folded completely flat on the floor (32).

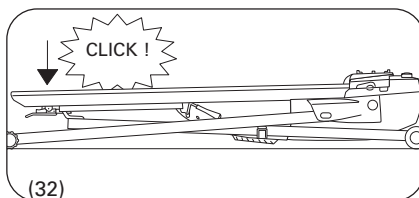
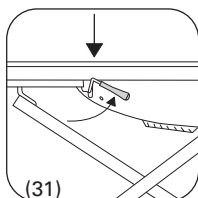

14 • TRANSPORT AND STORAGE

- Once folded, **carry the ironing board by its legs**, with the control panel facing downward (33).

The board's back feet are fitted with wheels to allow easy movement.

If you accidentally touch the board-opening lever, replace the board on the floor and check that it is correctly latched.

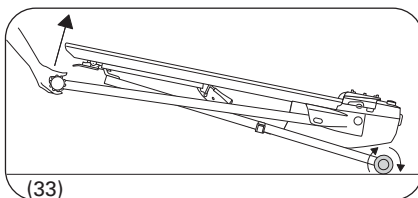

- To store the ironing centre, lift the board into the vertical position, again with the control panel facing downward (34).
- It is normal for the feet to open very slightly. This allows the rubber pads to touch the floor, enabling your ironing station to stand upright unsupported.

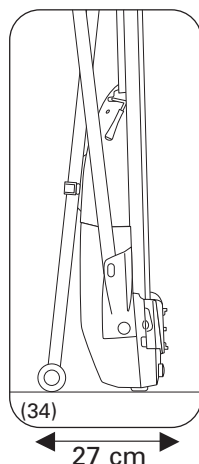

15 • SAFETY INSTRUCTIONS

- Your ironing centre is an electrical appliance: It should only be used for its intended purpose, and under normal conditions. It is designed for domestic use only.
It is fitted with two safety systems: a safety valve that releases any excess steam in the event of a malfunction and a thermal fuse to prevent overheating.
 - Check that your mains supply is the same voltage as shown on the appliance's rating plate.
 - This appliance complies with EU regulations 73/23/EEC and 89/336/EEC.
 - **Completely** remove the power cord from its housing before plugging it into an earthed socket.
 - Always plug your ironing centre into:
 - An electrical installation with a voltage between 220 V and 240 V AC. Connecting to the wrong voltage may cause irreparable damage and will invalidate your guarantee.
 - An earthed power socket. If you are using an extension lead, ensure that it is correctly rated (minimum 13A) with an earth, and is fully extended.
 - Never use the steam generator separately from the board.
 - Should the electric power cord or the iron's steam cord become damaged, it must be replaced by a Rowenta Approved Service Centre to avoid the risk of injury.
- Caution:**
- Your iron's soleplate and the rest-plate can become very hot and cause burns. Take care not to touch them while hot.
 - Your appliance releases steam, which can cause burns.
 - Handle your iron with care, particularly when using the vertical steam function.
 - Never direct steam toward people or animals.
 - Take care to ensure that you do not come into contact with electrical cords with the hot iron soleplate.
 - Keep your ironing station out of the reach of children.
 - Never leave the appliance unattended:
 - while it is plugged into a power socket;
 - until it has cooled down (approximately 1 hour after use).
 - Never unplug the appliance by pulling on the power cord.
 - Always unplug your appliance:
 - Before rinsing out the boiler,
 - Before cleaning it,
 - After each use.
 - Never leave the iron in its storage compartment with the ironing centre's power cord plugged in and the main switch is lit.
 - Before unscrewing the boiler drain plug, always wait until the steam generator is cold (unplugged for at least 2 hours).
 - Never fill the boiler through the drain hole, except when rinsing it.
 - Never immerse your steam generator in water or any other liquid. Never hold it under a running tap.
 - If the appliance falls, receives a violent blow or is not operating correctly, do not dismantle it; have it examined at a Rowenta Approved Service Centre in order to prevent any danger.
 - If you lose or damage the boiler drain plug, have it replaced at a Rowenta Approved Service Centre.
 - Always place the iron with the soleplate down on the iron rest-plate, never resting on its heel.

16 • GUARANTEE

- Rowenta offers a contractual warranty covering the appliance from the date of purchase for a period which may differ according to statutory requirements in each country. Please refer to the literature enclosed with your appliance.
- The ironing board cover is not protected under this guarantee.
- The product has been designed for domestic use only. Any commercial use, inappropriate use or failure to comply with the instructions, the manufacturer accepts no responsibility and the guarantee will not apply.

17 • TROUBLESHOOTING PROBLEMS WITH YOUR IRONING CENTRE

PROBLEM	POSSIBLE CAUSES	SOLUTIONS
<ul style="list-style-type: none"> The iron temperature control light and the main On/Off (O/I) switch are not lit. 	<ul style="list-style-type: none"> The appliance is not switched on. Your ironing centre is equipped with a safety device which cuts the power when the iron is stored in its compartment. 	<ul style="list-style-type: none"> Check that the appliance is correctly plugged in and press the main On/Off (O/I) switch on the control panel. To switch the iron on again, it is imperative that the iron is removed from its storage compartment first.
<ul style="list-style-type: none"> Water runs through the holes in the soleplate. 	<ul style="list-style-type: none"> You are using the steam control button before the iron is hot enough. Water has condensed in the pipes because you are using steam for the first time or because you have not used any for some time. 	<ul style="list-style-type: none"> Decrease the steam output when ironing at low temperature (steam output control dial on the control panel). Wait for the iron temperature control light to go out before pressing the steam control button. Hold the iron away from the ironing board and press the steam control button until the iron begins to produce steam.
<ul style="list-style-type: none"> White streaks come through the holes in the soleplate. 	<ul style="list-style-type: none"> Your boiler has a build-up of scale because it is not rinsed out regularly. 	<ul style="list-style-type: none"> Rinse out the boiler after every 10 uses. (See chapter 11). If your water is hard, rinse the boiler more frequently.
<ul style="list-style-type: none"> Brown streaks come through the holes in the soleplate and stain the linen. 	<ul style="list-style-type: none"> You are using chemical descaling agents or additives in the water for ironing. Your linen has not been rinsed sufficiently or you have ironed a new garment before washing it. 	<ul style="list-style-type: none"> Never add such products in the removable water tank or in the boiler (see our recommendations regarding the water to be used). Ensure linen is rinsed thoroughly to remove any soap deposits or chemicals on new garments which may be sucked up by the iron.
<ul style="list-style-type: none"> The soleplate is dirty or brown, and may stain the linen. 	<ul style="list-style-type: none"> You are ironing at too high a temperature. You are using starch. 	<ul style="list-style-type: none"> Refer to our temperature setting recommendations. Always spray starch onto the reverse side of the fabric to be ironed.
<ul style="list-style-type: none"> There is little or no steam. 	<ul style="list-style-type: none"> The boiler is not working, or the red light comes on even though there is still water left. The removable water tank is empty (the red "water tank empty" light is on).  The steam output control dial is set at a minimum. 	<ul style="list-style-type: none"> Check that the removable water tank is securely in place and press the RESTART button on the control panel to resume boiler heating. Fill the removable water tank and press the RESTART button on the control panel to resume boiler heating. Increase the steam output (using the control dial on the control panel).
<ul style="list-style-type: none"> Water escapes from around the removable water tank's cap when the ironing is stored upright. 	<ul style="list-style-type: none"> The removable water tank's cap has not been tightened correctly. 	<ul style="list-style-type: none"> Tighten the water tank's cap.
<ul style="list-style-type: none"> Water runs from the underside of the ironing board. 	<ul style="list-style-type: none"> You did not run the suction function enough before putting your ironing station away. 	<ul style="list-style-type: none"> Before putting your ironing station away, leave the main switch on for 4 to 5 minutes, then run the suction fan for a few minutes to remove any condensed steam.
<ul style="list-style-type: none"> Steam escapes from below the steam generator unit. 	<ul style="list-style-type: none"> The appliance is faulty. 	<ul style="list-style-type: none"> Stop using your ironing station and contact an Approved Service Centre.
<ul style="list-style-type: none"> Your ironing board is still not hot 10 minutes after being switched on. 	<ul style="list-style-type: none"> The appliance is faulty. 	<ul style="list-style-type: none"> Contact an Approved Service Centre
<ul style="list-style-type: none"> The fan unit does not make any noise. 	<ul style="list-style-type: none"> The appliance is faulty. 	<ul style="list-style-type: none"> Contact an Approved Service Centre

If you have any further problems or queries, please contact our Customer Relations Team first for expert help and advice. Our "PREMIER SERVICE" is available to you by calling the exclusive number below:
 HELPLINE : 0800 083 1190 – UK (01) 6774176 – Ireland
 Or, consult our web site : www.rowenta.co.uk

Free Manuals Download Website

<http://myh66.com>

<http://usermanuals.us>

<http://www.somanuals.com>

<http://www.4manuals.cc>

<http://www.manual-lib.com>

<http://www.404manual.com>

<http://www.luxmanual.com>

<http://aubethermostatmanual.com>

Golf course search by state

<http://golfingnear.com>

Email search by domain

<http://emailbydomain.com>

Auto manuals search

<http://auto.somanuals.com>

TV manuals search

<http://tv.somanuals.com>