

Rowenta



model DZ9030

www.rowenta.com

NL

BG

CZ

SR

HR

RO

SK

TR

S

DK

PL

SLO

H

AR

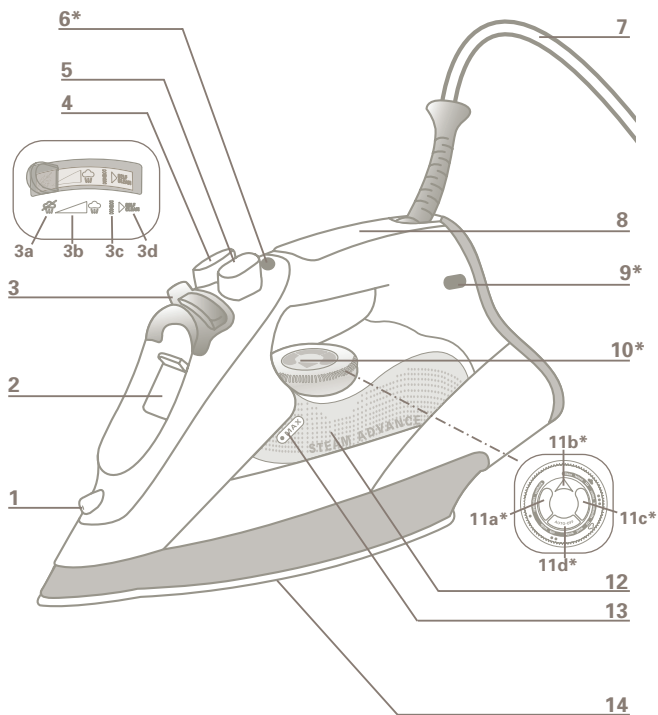

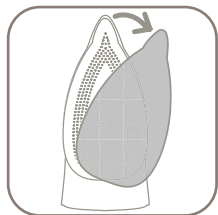

fig. 1

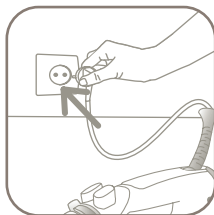

fig. 2



fig. 3

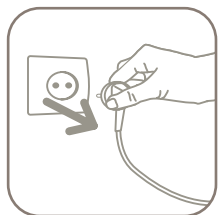

fig. 4



fig. 5

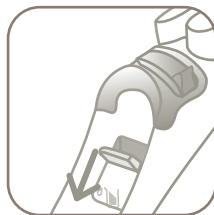

fig. 6



fig. 7

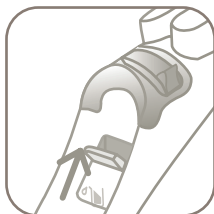

fig. 8



fig. 9

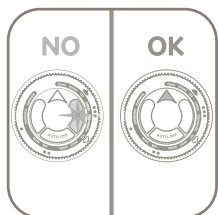

fig. 10

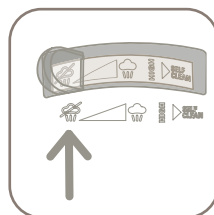

fig. 11

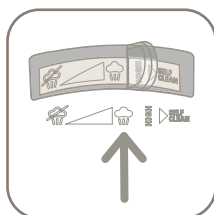

fig. 12

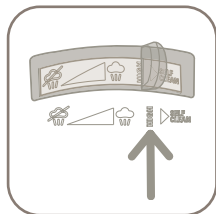

fig. 13

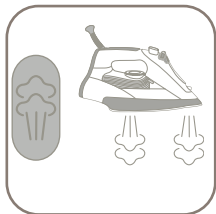

fig. 14

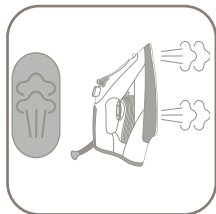

fig. 15

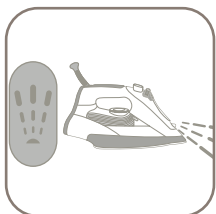

fig. 16



fig. 17

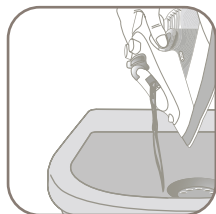

fig. 18

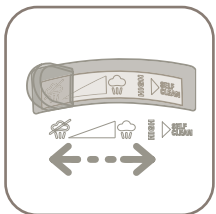



fig. 19



fig. 20

DESCRIPTION

- | | | | |
|---|--|----|----------------------------------|
| 1 | Spray nozzle | 8 | Handle |
| 2 | Filling inlet
(with slide-button opening) | 9 | Thermostat control light* |
| 3 | Variable steam control | 10 | Temperature control dial |
| | a Dry ironing | 11 | LED display* |
| | b Smooth steam | | a Yellow LED |
| | c High Pressure steam | | b Green LED |
| | d Self Clean | | c Red LED |
| 4 | Spray button  | 12 | Water tank |
| 5 | Shot of steam button  | 13 | Maximum water level
indicator |
| 6 | Auto-off indicator light* | 14 | Microsteam400 soleplate |
| 7 | Cord | | |

SAFETY INSTRUCTIONS

This appliance complies with the technical rules and standards for safety currently in force (Electromagnetic Compatibility, Low Voltage, Environment).

The appliance may only be connected to alternating current as specified on the rating plate. Only safe extension leads should be used.

An electrical appliance is not a toy. Use and store the appliance out of reach of children. Do not let the supply cord hang down.

Do not leave the appliance unattended while it is connected to the mains supply.

Electrical appliances generate high temperatures. Always use the handle and warn other users of the potential dangers (e.g. escaping steam or hot water, especially when ironing vertically).

Never direct steam at persons or animals, never treat clothing which is being worn.

Always disconnect the appliance before filling or emptying the water tank; before leaving the room (even for a short time); before cleaning the appliance and after use.

Never unplug the appliance by tugging on the cord.

Do not immerse the appliance in water.

An electrical appliance should not be used if:

- the appliance is not functioning correctly;
- the appliance, the supply cord or the cord protector is damaged;
- the appliance has been dropped;

* depending on model

– the appliance is obviously leaking. In these cases the appliance should be returned to an approved Rowenta Customer Service Centre for repair. (See enclosed Service Centre addresses.) Repairs to electrical appliances may only be carried out by specialists. Improperly carried out repairs can cause serious danger to users. To avoid danger to users, a defective or damaged supply cord may only be replaced by an authorised Rowenta Customers Service Centre .

This product has been designed for domestic use only. Any commercial use, inappropriate use or failure to comply with the instructions, the manufacturer accepts no responsibility and the guarantee will not apply.

Environment protection first !

Your appliance contains valuable materials which can be recovered or recycled.

Leave it at a local civic waste collection point.



Keep these instructions

BEFORE USE

1 • Unpacking

Take the iron out of the box and remove all the stickers.

IMPORTANT Before doing anything else, remove the soleplate protector (fig.1)!

2 • What water may be used ?

Your iron has been designed to operate using untreated tap water up to 17° dH (German water hardness) or 3 mmol/liter. However, if your water is very hard, you can mix 50% untreated tap water with 50% distilled or demineralised water.

IMPORTANT Heat concentrates the elements contained in water during evaporation. The type of water listed below

contain organic waste or mineral elements that can cause spitting, brown staining or premature wear of the appliance:
- water from clothes dryers, scented or softened water, water from refrigerators, batteries or air conditioners, pure distilled or demineralised water or rain water should not be used in your iron. Also do not use boiled, filtered or bottled water.

3 • Using for the first time

Plug in the iron (fig.2) and set the temperature control dial (fig.3) to ●●● to heat the appliance.

A little smoke and a slight smell may be emitted, but this is only temporary.

Unplug the iron (fig.4) and fill the water tank (§ 4 Filling the water tank).

To remove any impurities in the iron's steam chamber, unplug the iron and hold it over a sink horizontally. Push the steam control into the Self Clean position : steam will now begin to build up. After a few seconds water will emerge from the soleplate, rinsing any impurities out of the steam chamber (fig.5).

Move the steam control to steam HIGH position after approx. 1 minute. Plug in the iron and allow the iron to heat up again.

Wait until the remaining water has evaporated. Unplug from the mains and allow the iron to fully cool down.

USE

4 • Filling the water tank



IMPORTANT Before filling the water tank, unplug the iron and set the steam control to dry position .

Tilt the iron. Open the filling inlet (fig.6). Pour in water up to the max mark (fig.7). Close the filler inlet (fig.8) and return the iron to the horizontal.

5 • Setting the temperature

Set the iron temperature to suit the type of material using the temperature control dial (fig.3).

Temperature control*: The temperature control light indicates that the soleplate is heating up. When the temperature control light goes off (fig.9), the set temperature is reached and you can begin ironing.

Ironing label	Fabric	Temperature control
	Synthetic fibres, e.g. viscose, polyester...	•
	Silk, wool	••
	Cotton, linen	•••

Electronic temperature control*: The traffic lights tell you whether the soleplate is at the selected temperature (fig.10).

YELLOW (pulse)	The soleplate is still too cold for the selected material.
GREEN	The soleplate is at the right temperature for the selected material.
RED (pulse)	The soleplate is still too hot for the selected material.
AUTO- OFF (blinking)	The automatic electronic cut-out* is active.

IMPORTANT The iron takes longer to cool down than to heat up. We recommend that you start with fabrics to be ironed at a low temperature. For mixed fabrics set the temperature for the most delicate fabric.

TIP Always spray starch onto the reverse side of the fabric to be ironed.

6 • Dry ironing

Set the variable steam control to  (fig.11) and set the temperature to suit the type of material (care points •, ••, •••).

* depending on model

7 • Steam ironing

You can steam iron from temperature setting **••** up. The steam quantity can be adjusted between Smooth Steam  (soft steam continuous diffusion) up to High Pressure steam **HIGH**.

We recommend setting to High Pressure steam only when the iron is at temperature setting **•••**.

8 • High Pressure Steam

Your iron is fitted with the new High Pressure Steam system (fig.13). This technology generates higher steam pressure to enable the steam to penetrate much faster and further into the fabric.

This way you get excellent results from your ironing.

The steam is emitted in frequent bursts rather than continuously.

The pressure generated may cause a slight noise. This is not a technical fault!

9 • Shot of Steam

(from temperature setting **••** up)

IMPORTANT Leave an interval of 4 seconds between each shot and wait until the flow of steam is finished before standing the iron on its heel.

Press the shot of steam button  to generate a powerful jet of steam and remove stubborn creases (fig.14).

10 • Vertical shot of steam

(from temperature setting **••** up)

TIP Hold the iron 10 to 20 centimetres away from the garment to avoid burning delicate fabrics.

Hold the iron to the vertical and press the shot of steam button  (fig.15) to remove creases from suits, jackets, skirts, hanging curtains etc.

IMPORTANT Never direct the steam at persons or animals!

11 • Spray

Press the spray button  to dampen stubborn creases (fig.16).

12 • Anti-Drip system*

It prevents water escaping from the soleplate when the temperature is too low.

* depending on model

13 • Automatic electronic 3-position shut off

If, although switched on, the appliance is not moved, it will automatically switch off and the auto off light will blink after the following intervals (fig.17):

- After 30 sec., if the iron is standing on the soleplate or lying on its side.
- After 8 mins., if the iron is standing on its heel.

AFTER USE

14 • Emptying

Unplug the iron (fig.4), pour away remaining water (fig.18) and set steam control to .

Open and close the steam control several times (fig.19) to prevent the drip hole into the steam chamber from furring or blocking up.

15 • Storing

Allow the appliance to cool down before storing the iron standing on its heel (fig.20).

IMPORTANT Do not wind the cord around the hot soleplate. Never store your iron placed down on the soleplate (fig.20).

MAINTENANCE AND CLEANING

IMPORTANT Unplug and allow the iron to fully cool down before maintenance and cleaning.

16 • Anti-scale system

Your iron contains an anti-scale cartridge to reduce scale deposits. This considerably prolongs the operational life of your iron.

The anti-scale cartridge is an integral part of the water tank and does not need to be replaced.

IMPORTANT Do not use descaling agents, as these damage the lining of the steam chamber and so may impair the steam function.

17 • Self Clean function

(prolongs the life of the iron)

The Self Clean function flushes dirt and scale particles out of the steam chamber. Fill the water tank with tap water up to the max mark and heat the iron to the  temperature. Unplug the iron and hold it over a sink horizontally. Hold the steam control into the Self

Clean position (fig.5) : steam will now begin to build up. After a few seconds water will merge from the soleplate, rinsing dirt and scale particles out of the steam chamber. Move the steam control to **HIGH** position after approx. 1 minute. Plug in the iron and allow the iron to heat up again. Wait until the remaining water has evaporated. Unplug from the mains and allow the iron to fully cool down. When cool, the soleplate can be wiped with a damp cloth.

TIP Use the Self Clean function approx. every 2 weeks. If the water is very hard, clean the iron weekly.

18 • Cleaning the iron

When the appliance has cooled down, wipe it down with a damp cloth or sponge, as required. Remove the dirt from the soleplate with a damp cloth or sponge.

IMPORTANT Do not use sharp or abrasive cleaning agents or objects to clean soleplate and other parts of the iron. If the appliance has been standing unused for long periods, use the Self Clean function (see § 17).

PROBLEMS?

Problems	Cause	Solution
The iron is plugged in, but the soleplate of the iron remains cold.	No mains supply.	Check that the mains plug is properly inserted or try plugging the iron into a different socket.
	Temperature control set too low.	Set the temperature control to a higher temperature.
	The automatic electronic cut-out* is active.	Move your iron.
Thermostat control light* or the yellow led* goes on and off.	This is normal.	When the thermostat control light* or the yellow led* goes on and off the iron is heating up. As soon as the thermostat control light* goes off or the green led* lights up the set temperature has been reached.
Yellow and red LED are blinking alternately.	The electronic has an internal failure.	Contact an official Rowenta Customer service.

* depending on model

None or too little steam is being emitted.	Steam control set on dry position  .	Turn the steam control to the required setting area.
	Not enough water in the water tank.	Fill the water tank.
	Anti-Drip* is active (§ 12).	Wait for the soleplate to reach the correct temperature.
The soleplate is dirty or brown and can stain the linen.	Residues in the steam chamber or on the soleplate.	Use the Self Clean function then clean your iron.
	Use of chemical descaling agents.	Do not add any descaling agents to the water in the water tank. Use the Self Clean function and clean your iron.
	Pure distilled/demineralised or softened water is being used.	Only use untreated tap water or mix half tap water with half distilled/demineralised water. Use the Self Clean function and clean your iron.
	Use of starch.	Always spray starch onto the reverse side of the fabric to be ironed and clean your iron soleplate.
Iron is leaking.	Soleplate temperature too low or overuse of extra long shot of steam button.	Set the temperature control to a higher temperature and allow more time between each shot.

If you are unable to trace the cause of the fault, contact an official Rowenta Customer Service Centre. The addresses are shown in the enclosed service centre address list. Helplines listed at the front of this leaflet.

Further hints and tips are obtainable from our homepage:
www.rowenta.com.

Subject to modifications !

Free Manuals Download Website

<http://myh66.com>

<http://usermanuals.us>

<http://www.somanuals.com>

<http://www.4manuals.cc>

<http://www.manual-lib.com>

<http://www.404manual.com>

<http://www.luxmanual.com>

<http://aubethermostatmanual.com>

Golf course search by state

<http://golfingnear.com>

Email search by domain

<http://emailbydomain.com>

Auto manuals search

<http://auto.somanuals.com>

TV manuals search

<http://tv.somanuals.com>