

Rowenta

GARMENT STEAMER IS9000

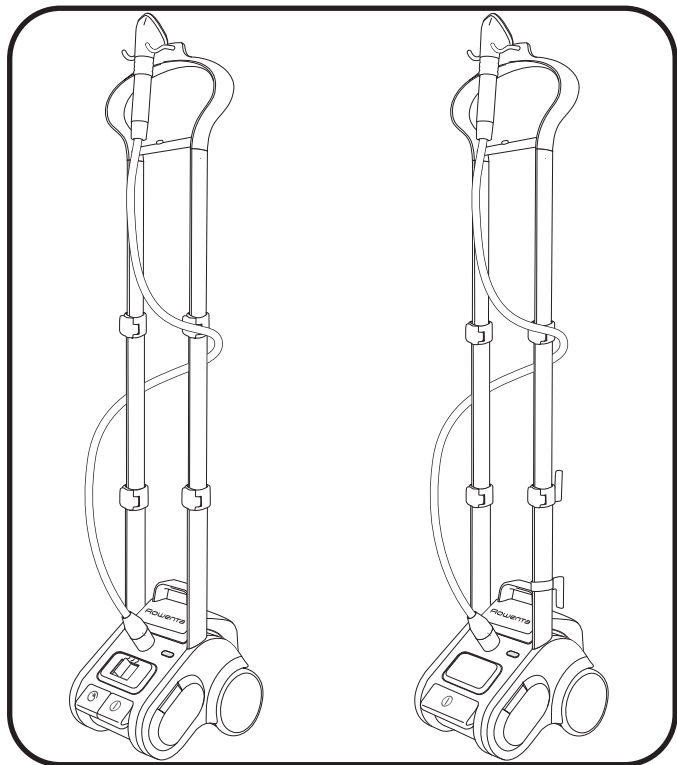

1103905164 - 39/08

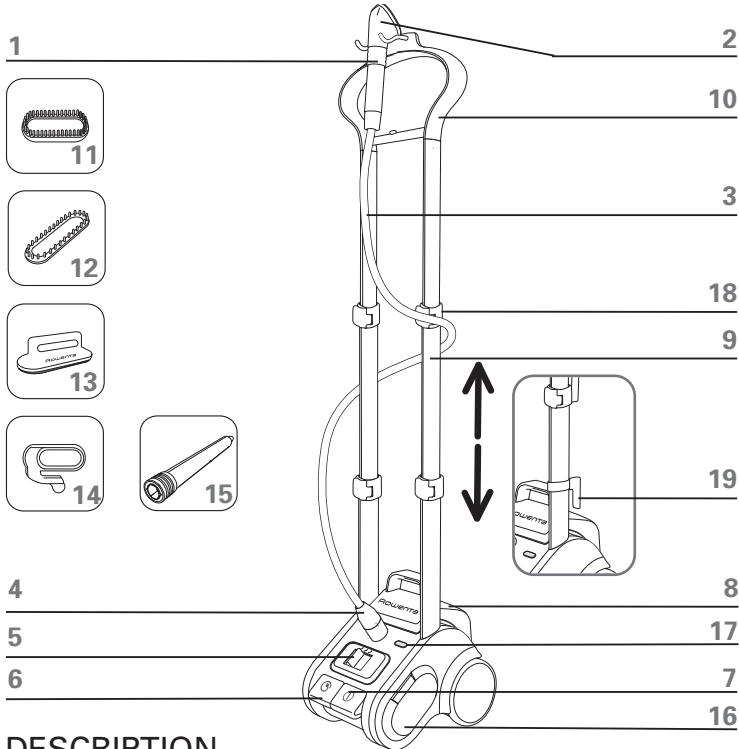

DESCRIPTION

- | | |
|---------------------------------------|---|
| 1. Handle | 11. Fabric brush * |
| 2. Steam head | 12. Upholstery brush* |
| 3. Flexible hose | 13. Lint pad* |
| 4. Hose connector | 14. Crease attachment* |
| 5. Variable steam control* | 15. Curtain rod extension* |
| 6. Foot operated cord reel* | 16. On board accessories storage |
| 7. On/off foot operated switch | 17. Power indicator light |
| 8. Removable water tank | 18. Clips for pole fastening |
| 9. Double telescopic pole | 19. Power cord clips* |
| 10. Integrated hanger | |

*Depending on the model, these accessories are specific to certain models or available as an option.

IMPORTANT SAFETY INSTRUCTIONS

When using your appliance, basic precautions should always be followed, including the following:

READ ALL INSTRUCTIONS BEFORE USING

-To reduce the risk of contact with hot water emitting from steam vents, check appliance before each use by holding it away from body and operating steam button.

-Use appliance for its intended use only.

-To reduce the risk of electric shock, do not immerse the appliance in water or other liquids.

-Appliance should always be turned "OFF" before plugging or unplugging from outlet. Never yank the cord to disconnect from the outlet, instead grasp plug and pull to disconnect.

-Do not allow cord to touch hot surfaces. Let appliance cool completely before storing away. Loop cord loosely around appliance when storing or rewind using the cord reel.

-Do not direct steam at people or animals, or use steamer on garments while they are being worn.

-Always disconnect appliance from electrical outlet when filling with water, emptying or when not in use.

-Do not operate appliance with a damaged cord or if the appliance has been dropped or damaged. To avoid the risk of electrical shock, do not disassemble or attempt to repair the appliance. Ship it to the nearest authorized Rowenta approved service center for examination and repair. Incorrect reassembly can cause risk of fire, injury and electrical shock to persons when the appliance is in use.

-This appliance is not intended for use by or near children and other persons whose physical, sensory or mental capabilities or lack of experience and knowledge prevents them from using the appliance safely without supervision or instruction by a responsible person to ensure that they can use the appliance safely.

-Children should be supervised by the responsible person to ensure that they do not play with the appliance.

-Burns could occur from touching hot metal parts, hot water or steam. Use care when you empty a steam appliance, there may be hot water in the reservoir.

- Never pour water directly into reservoir. Pour water in water tank only.
- Never drop or insert any object into any opening or hose.
- Always keep the hose and nozzle elevated above the water tank.
- Steam only in an up and down vertical motion. Never use steamer in a horizontal position or tilt into a backward position, this may result in hot water discharge.
- Do not place the steam nozzle directly on any surface or the appliance power cord while it is hot or plugged in. Use the stand provided.
- When changing attachments, please be sure, the unit is off and no steam is being released to avoid contact with hot water.
- Use caution when changing attachments, as they may contain hot water from condensation. Ensure the attachments are cooled off to avoid contact with hot water.
- The use of accessory attachments other than those provided by Rowenta is not recommended and may result in fire, electric shock or personal injury.
- This unit is for indoor use only.

SPECIAL INSTRUCTIONS

-To avoid a circuit overload, do not operate another high wattage appliance on the same circuit.

If an extension cord is absolutely necessary, a 15-ampere rated cord should be used. Cords rated for less amperage may overheat. Care should be taken to arrange the cord so that it cannot be pulled or tripped over.

SAVE THESE INSTRUCTIONS

ENVIRONMENTAL PROTECTION FIRST!

- ① Your appliance contains valuable materials which can be recovered or recycled.
- ➡ When disposing of it, take it to a collection point or an approved service center.



Assembly :

Preparation:

- Place the base on the floor and remove the water tank.

Install pole in main unit:

- Insert pole 1 and 2 according to the diagram to the right, ensuring the marks on the unit and the poles line up.
- Press pole firmly into place.

Locking the pole :

- With the poles inserted lay the base on its side.
- Turn the 2 lockbars on the base of the steamer 90° to secure the poles.
- Use a coin or similar object to turn the lockbar.
- After the poles are locked, pick up the unit and return to its use position.

Installing Integrated Hanger :

- Take the hanger with the brush hooks facing to the front.
 - Check for correct orientation with the index marks matching.
 - Insert both ends of the hanger into the pole connection and press both ends simultaneously into the pole until the hanger properly engages.
 - If it is required to dismantle the pole from the main unit, tilt the appliance and unlock the pole first.
 - Then place the appliance back into its upright position. Expand both poles to the desired height by unlocking them. Pulling them gently and locking them.
- WARNING :** unlock the four clips while keeping integrated hanger in your hand.
- Dismantling of the hanger from the poles by the customer is not foreseen.

Attaching Steam hose to main unit :

- 1) Insert hose plug into hose connector on main unit.
- 2) Fix hose connector by pulling clamping ring upwards.

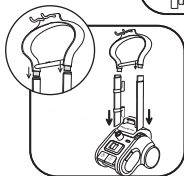
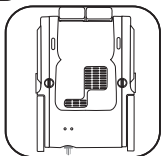
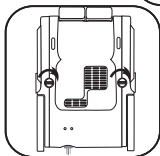
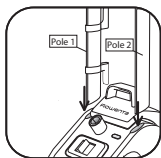

Filling the water tank

- The steamer is designed to be used with TAP WATER . If the water in your area is hard, Rowenta recommends that you mix half tap water and half distilled water, which reduces the hardness; you may also use bottled spring water or distilled water only.



- IMPORTANT**
Never use water that contains additives (starch, perfume, aromatic substances, softener, etc) in the steamer. Additives such as these can affect the properties of the steam and lead to the formation of deposits.
- Ensure that the device is unplugged. Remove the water tank from the base of the appliance by pulling it upwards. Unscrew the lid and fill the tank.
The tank holds 128 ounces.
 - After closing the lid, place the water tank into place on the base of the appliance.

Tips

- We recommend checking the garment care label for manufacturer recommendations. We also recommend testing the garment on an unobtrusive area such as an inner seam.
- Read the recommendations for the maintenance of the fabrics on the labels of the clothing to be steamed.
- Test the strength of the colour of the fabric on an area of the garment that is not visible (inside of a hem).
- Avoid contact between the steam head and silk or velvet.
- Certain garments are smoothed more easily on the reverse side.
- If you are using your steamer in a position close to the ground, raise the hose frequently in order to avoid the formation of condensation. You may hear a gurgling noise if the hose is obstructed in any way.
- Heavy fabrics may need to be steamed longer.
- Be careful at all times.

Use

Warning: Never steam a garment while it is being worn. The hose and steam head may become hot during use. This is perfectly normal. Be careful and avoid any prolonged contact.

- Only operate the steamer on the floor clear of any materials which may obstruct the base of the steamer (flat and horizontal surface). Do not obstruct the orifices on the lower part of the appliance.
- Depending on the model the steam amount can be set to the desired level with the variable steam control.*
- If necessary, expand the poles to the desired height by unlocking them. Gently pull the hanger with the hand and lock the poles to the desired height with the other hand. Take care not to jam the double poles by pulling them asymmetrically.
- Plug in the power cord and turn on the power using the foot operated pedal. The power light will illuminate. The steamer is operating.
- The unit will produce steam in 60 seconds.
- Put garment onto the hanger head. Grasp the steam head with the steam vents pointing away from you. Start steaming by touching material lightly with steaming head and moving in an up/down vertical motion. Beginning at the top of the garment move in a downward direction. Always steam in a vertical position.
- During use, the hose may make a gurgling noise. This is normal and caused by condensation. If you hear the gurgling noise, hold the hose up to direct the condensation back into the appliance.



Warning: Do not allow the steamer to run dry.

Warning: Never use the steamer more than 3 hours.

*Depending on the model these accessories are specific to certain models or available as an option.

Crease attachment*

- Gently push into place.
- Push on the handle to open out the crease attachment .
- Place the garment between the crease attachment and steam head.
- Release the handle.
- Starting at the top of the garment, move the crease attachment in a downwards motion.
- Once unit is unplugged and completely cooled down, remove the crease attachment by sliding it off of the steam head.



The lint pad is a separate accessory and cannot be attached to the steam head. You can use the lint pad independently from the steamer.

Lint pad*

The lint pad removes hair, lint and animal fur for a professional finish.

- To use the lint pad, slowly brush the clothing with the grain or nap of the fabric.
- The pad can be cleaned by brushing it in the opposite direction. We recommend cleaning the pad on an old cloth that can be discarded.



After use

- After using the steamer, switch the power off (power indicator light will go out) and unplug the appliance.
- Hang steam head in an upright position on hanger head when not in use.
- Wrap the cord around the power cord clips for storage.



or

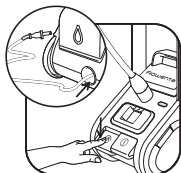

- Empty water tank before storage.
- Do not carry the steamer by the water tank handle.
The unit is designed to transport with the convenience of rolling luggage for easy storage.



Warning: Never touch the steam head until it has cooled down completely.



Cleaning

Clean the main unit with a damp cloth. To maintain maximum performance, your steamer must be descaled occasionally. The time between two descaling operations depends on the quality of the water and the frequency with which you use the appliance. The appliance must be descaled at least once a year or after 100 hours of use.

To carry out a descaling operation, follow the following steps:

1. Ensure that the appliance has cooled down completely. Unplug the unit and remove the steam hose from main unit. Collapse the telescopic poles.
2. Fill the water tank with fresh water and attach it to the main unit again.
3. Remove the tank from main unit and empty the water from the boiler through the open hose connector into a sink. Scale and other residues will be rinsed out.
4. Repeat Step 2 and 3 several times until the scale has been removed.

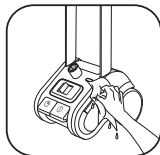

Troubleshooting

PROBLEMS	Possible causes	Solutions
There is no steam.	The appliance has not been turned on.	Check that your appliance is properly plugged in and press the On / Off button (on the front of the appliance). The power light should turn on.
	The hose has been obstructed.	Check that the hose is not bent or twisted.
	There is no water left.	Turn off the appliance and refill the water tank.
The steam flow is low.	Your steamer has a build-up of scale because it has not been rinsed out regularly.	Descale the steamer at least once a year or every 100 hours of use. If your water is hard, increase the frequency.
	There is no water left.	Turn the appliance off and refill it.
Water runs through the holes of the steambrush.	There is condensation in the hose.	Never use steamer in a horizontal position. Hold the hose vertically outstretched and wait for water to flow back into the steamer.
The steamer takes a long time to heat.	Your steamer has a build-up of scale because it has not been descaled regularly.	Rinse out the steamer at least once a year or every 100 hours of use. If your water is hard, increase the frequency.

If it is not possible to establish the cause of the problem, seek the assistance of an Approved ROWENTA Service Center www.rowentausa.com

In the interest of improving products, Rowenta reserves the right to change specifications without prior notice.

LIMITED WARRANTY

This Rowenta product is warranted for 6 months from date of purchase against defects in material and workmanship. During this period, any Rowenta product that, upon inspection by Rowenta, is proved defective, will be repaired or replaced, at Rowenta's option, without charge to the customer. If a replacement product is sent, it will carry the remaining warranty of the original product. This warranty does not apply to any defect arising from a buyer's or user's misuse of the product, negligence, failure to follow Rowenta's instructions, use on current or voltage other than that stamped on the product, or alteration or repair not authorized by Rowenta. Repair or disassembly by anyone other than a Rowenta authorized service center will void the warranty.

THE WARRANTIES SET FORTH HEREIN ARE EXCLUSIVE AND NO OTHER WARRANTIES, EXPRESS OR IMPLIED, INCLUDING BUT NOT LIMITED TO ANY WARRANTY OF MERCHANTABILITY OR FITNESS FOR A PARTICULAR PURPOSE OR USE, ARE MADE BY ROWENTA OR ARE AUTHORIZED TO BE MADE WITH RESPECT TO THE PRODUCT.

Some states do not allow limitations on how long an implied warranty lasts or do not allow the exclusion of incidental or consequential damages, so the above limitations may not apply to you. This warranty gives you specific legal rights, and you may also have other rights, which vary from state to state.

If you believe your product is defective, bring the product (or send it, postage prepaid) along with proof of purchase to the nearest authorized Rowenta Service Center (see below). If you send the product, please include a letter explaining the nature of the claimed defect.

CORRESPONDENCE CAN BE SENT TO:

Groupe SEB USA
2121 Eden Road
Millville, NJ 08332, USA
Tel: 856-825-6300
www.rowentausa.com

OFFICE LOCATION ONLY. Letters will be accepted at this address and packages without a return authorization number will be refused or forwarded to a service center. For product service, see information below.

SERVICE CENTER INFORMATION:

If your appliance needs service, ship the product to your nearest regional service center. Be sure to put your name on the outside of the shipping box (no P.O. boxes please), include a brief note describing the issue, and include a copy of the sales receipt if the product is in warranty. If in warranty, Rowenta will repair or replace the product at their discretion. If the product is out of warranty, you will be advised of the cost of repair before any work begins.

Turnpike Appliance
3495A Lawson Blvd.
Oceanside, NY 11572
516-483-5596

California Electric
1170G Burnett Ave.
Concord, CA 94520
925-827-1011

Authorized Appliance
1644 West Ogden Ave.
Downers Grove, IL 60515
630-852-1550

SERVICE CENTER INFORMATION IS SUBJECT TO CHANGE. Please visit our website at www.rowentausa.com or call 781-396-0600 for automated service center information.

Free Manuals Download Website

<http://myh66.com>

<http://usermanuals.us>

<http://www.somanuals.com>

<http://www.4manuals.cc>

<http://www.manual-lib.com>

<http://www.404manual.com>

<http://www.luxmanual.com>

<http://aubethermostatmanual.com>

Golf course search by state

<http://golfingnear.com>

Email search by domain

<http://emailbydomain.com>

Auto manuals search

<http://auto.somanuals.com>

TV manuals search

<http://tv.somanuals.com>