

# Rowenta

## P2 Professional

### Instructions for Use

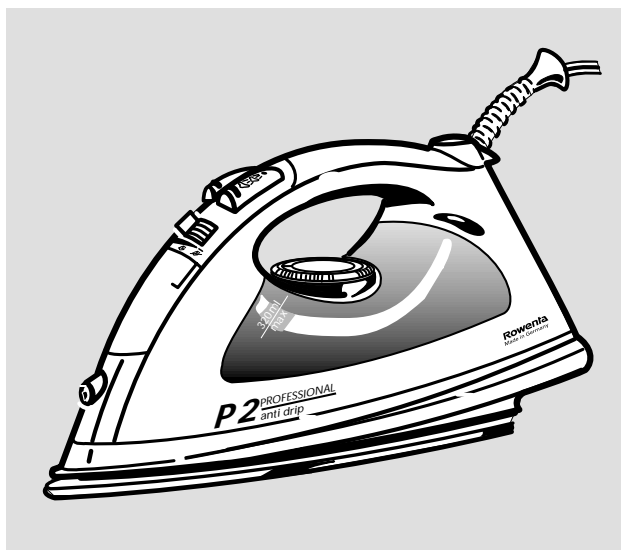

# IMPORTANT SAFETY INSTRUCTIONS

When using your iron, basic safety precautions should always be followed, including the following:

Read all instructions before using the iron.

1. Use iron only for its intended use.
2. To protect against a risk of electric shock, **do not** immerse the iron in water or other liquids.
3. The iron should always be turned to Minimum (Min) before plugging or unplugging from outlet. Never yank cord to disconnect from outlet, instead grasp plug and pull to disconnect.
4. Do not allow cord to touch hot surfaces. Let iron cool completely before putting away. Loop cord loosely around iron when storing.
5. Always disconnect iron from electrical outlet when filling iron with water, emptying iron or when not in use.
6. Do not operate iron with a damaged cord or if the iron has been dropped or damaged. To avoid the risk of electric shock, do not disassemble the iron, ship it to the nearest authorized Rowenta Appliance Service Center for examination and repair. Incorrect reassembly can cause a risk of electric shock when the iron is used.
7. Close supervision is necessary for any appliance being used by or near children. Do not leave iron unattended while plugged in or on an ironing board.
8. Burns can occur from touching hot metal parts, hot water or steam. Use caution when you turn a steam iron upside down there may be hot water in the reservoir.
9. The use of accessory attachments is not recommended by Rowenta Appliance Company and may result in fire, electric shock or personal injury.

## **SPECIAL INSTRUCTIONS**

1. This is a 1440 watt appliance. To avoid a circuit overload, do not operate another high wattage appliance on the same circuit.
2. If an extension cord is absolutely necessary, a 12-ampere cord should be used. Cords rated for less amperage may overheat. Care should be taken to arrange the cord so that it cannot be pulled or tripped over.
3. Your Rowenta appliance is intended for household use only.

## **SAVE THESE INSTRUCTIONS**

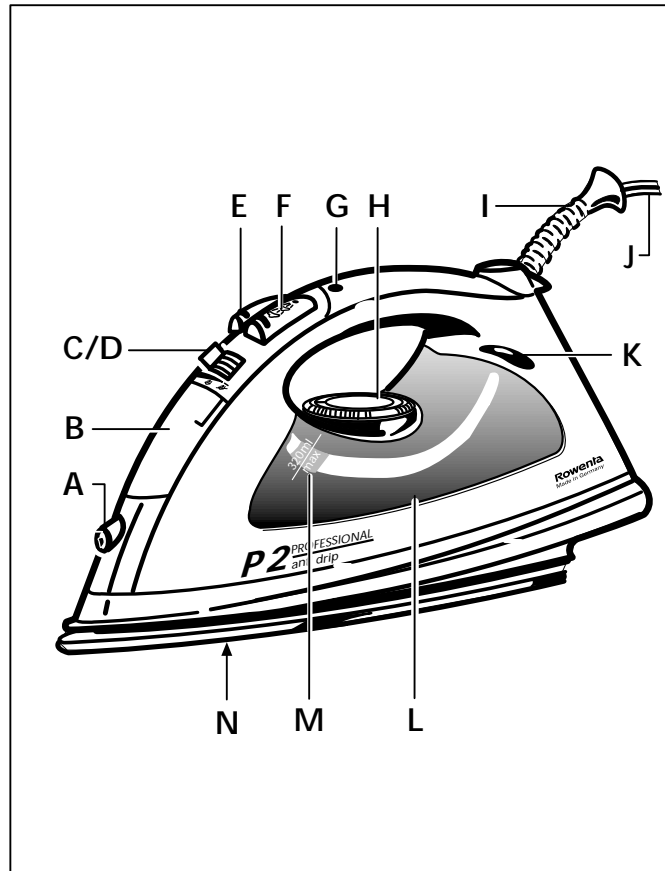

■ **Description:**

- |   |                             |
|---|-----------------------------|
| A Spray nozzle                              | H Temperature control dial  |
| B Covered water filling inlet               | I Swiveling cord protector  |
| C Variable steam control                    | J Supply cord               |
| D Self clean system<br>(depending on model) | K Temperature light         |
| E Spray button                              | L Transparent water tank    |
| F Burst of steam button                     | M Water level indicator     |
| G Auto-off indicator light                  | N Stainless steel soleplate |

## BEFORE USE

- Please read the instructions for use and the **Important Safeguards** very carefully.
- Slowly peel the protective cover off the soleplate or remove the transparent soleplate protector.
- It is normal for a small amount of smoke to be produced the first time the iron is used. This will quickly disappear.

## 3-WAY AUTO-OFF

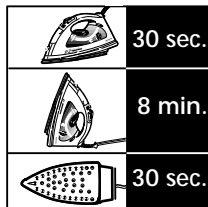

If the iron is not moved while it is plugged in, an internal safety switch will turn it off. It will turn off in 8 minutes if left vertically or in 30 seconds if left on its soleplate or tipped over. A red flashing light indicates that the auto-off has been activated. To switch the iron on again, move the iron or gently shake it.

Wait until iron is fully reheated before use.

## STEAM IRONING

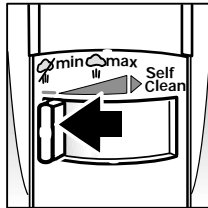

### Filling with water

- Ensure the iron is unplugged.
- Slide the variable steam control completely to the left.
- Hold the appliance upright so that the water filling inlet is horizontal.
- Fill the iron with tap water to the maximum level mark (see water usage for more information).

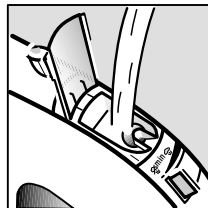

### Adding water

- If you need to add water during ironing, **UNPLUG** the iron and repeat above steps.
- Ensure iron is fully reheated after filling (temperature indicator light goes out) before ironing.
- To avoid damage to clothes from dust or dirt that may collect in the iron, we recommend that for the first use or after the iron has been stored for some time that you first iron an old cloth, testing both the steam and burst of steam feature.

## SELECTING THE TEMPERATURE

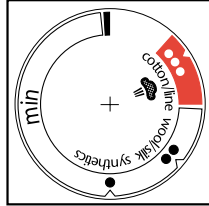

Set the temperature control dial according to the type of fabric you are ironing. Check the fabric's label for appropriate setting.

Laundry label	Fabric	Temperature setting
	synthetics e.g. viscose, polyester	●
	silk, wool	●●
	cotton, linen	●●●

To avoid an automatic switch off while the iron is heating up, always keep the iron on its heel. Start at low temperature ● and graduate to high temperature ●●●. For delicate fabrics we recommend carrying out a test on an unobtrusive part of the garment (inner seam).

## SETTING VARIABLE STEAM CONTROL

Set the variable steam control to required steam volume. Steam can only be produced when the thermostat is aligned to ●●● or max. (red zone). Allow iron to heat up (light goes out) before activating the variable steam control.

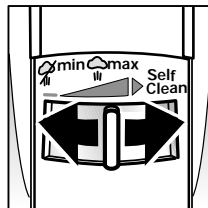

### Iron ready for steam ironing

Steam is produced as soon as the iron is held horizontally.

### Steam off

Steam generation can be interrupted by standing the iron on its heel or sliding the variable steam control fully to the left.

## ANTI-DRIP SYSTEM

In order to produce steam, all irons require a high temperature. If the soleplate is not hot enough some of the water will not turn to steam and can spit or leak from the soleplate. The new anti-drip system automatically reduces the volume of steam when ironing at low temperatures to prevent dripping.

### SPRAY SETTING

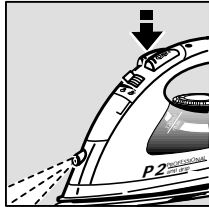

- Ensure there is water in the tank.
- Moistening the fabric with the spray will make wrinkle removal easier.
- Press the spray button down slowly for a jet or quickly and strongly for a mist.
- Do not spray silk, etc.

### BURST OF STEAM

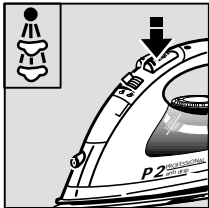

- To remove stubborn wrinkles or press in a sharp crease, use the burst of steam button.
- Press the button firmly, a strong burst of steam penetrates deep into the fabric.
- Leave an interval of at least four seconds between pressing the burst of steam button.
- With water in the tank, the burst of steam button can be used as soon as the steam ironing temperature has been reached (●●●).

### VERTICAL STEAM

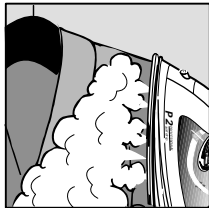

The iron can also be used vertically. This is especially useful for getting creases out of hanging clothes, curtains, tapestries, etc.

**Warning:**  
Never iron clothes while they are being worn.

### POINT TO NOTE

If the iron has not been used for a long time (e.g. several weeks) the steam channels should be cleaned and any deposits removed from the iron. To do this, hold the iron horizontally before you start to use it and allow it to produce steam for about 1 minute. Also activate the burst of steam button several times.

### DRY IRONING

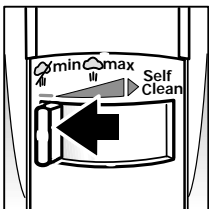

- Slide the variable steam control fully to the left. We recommend dry ironing with an empty tank to be sure there are no drips, but it can also be performed with water in the tank.

## AFTER IRONING

- Unplug the iron. Slide the variable steam control completely to the left (the minimum position) and empty any water left in the tank. Leave the iron to cool down.

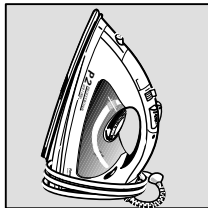

### Integrated cord wrap

- For easy storage, the cord can be wound loosely around the heel once the iron has cooled down completely.
- To protect the soleplate always store the iron on its heel.

### Important:

Always empty the water tank when you have finished ironing!

## WATER TO USE IN ROWENTA IRONS

### Tap water

Rowenta irons are designed to be used with REGULAR TAP WATER (up to 12 grains of hardness). If your water is harder than this, Rowenta recommends mixing half tap water with half distilled water which reduces the hardness; or using inexpensive bottled spring water. **Never use 100% distilled water since this can cause the iron to spit and leak.**

### Softened water

There are many types of household water softeners and the water from many of them is perfectly acceptable for use in an iron. However, some types of softeners, particularly those that use chemicals such as salt, can cause the iron to leak or spit during use. If you experience this type of problem, we recommend that you try using inexpensive bottled spring water or untreated tap water.

**Never use 100% pure distilled water.**

Once you have changed water it will take several uses to correct the problem. Rowenta recommends trying the steam function for the first time on an old towel or cloth to avoid damaging your clothes.

### Iron and other impurities

If your water supply contains large amounts of iron or organic matter, these minerals can collect inside the iron and eventually appear as brown stains. If you experience these problems Rowenta recommends using inexpensive bottled spring water.

**Never use 100% pure distilled water.**



## SELF CLEANING

Your iron is equipped with two self clean functions (depending on model). Do not use descaling agents in your Rowenta iron.

### Vapodur Valve

The patented Vapodur valve ensures that the opening which allows the water to drip from the water tank into the steam chamber of your iron remains unaffected by hard water deposits.

To ensure your iron continues to steam efficiently the valve **MUST** be opened and closed a few times. This is done by moving the variable steam control left to right a few times each time you finish ironing.

### Steam Chamber Cleaning Function (depending on model)

This function allows loose mineral deposits and other impurities that build up inside the iron to be flushed out. This type of self cleaning only needs to be carried out occasionally and never more than once a month.



- Fill the iron with cold tap water and set variable steam to min.
- Set thermostat dial to maximum position.
- Stand on heel and plug in.
- When the iron reaches the correct temperature, indicator light will go out, unplug iron.
- Hold iron horizontally over the sink with soleplate pointing away from body.
- Press and hold down the self clean button for about 1 minute.

**WARNING:** Doing this will cause steam and hot water to be ejected from the soleplate. Take all proper precautions and hold iron away from body.

- Move the iron gently back and forth and side to side until all water has run through.
- Carefully wipe all water and material from the soleplate with an old folded towel, as the water and minerals can stain the soleplate (although this has no effect on glide or performance).

**WARNING:** Iron and soleplate may still be hot, exercise care while wiping.

- Place iron on heel and leave to cool.
- **IMPORTANT:** before using the iron after self cleaning, test steam and burst of steam on an old towel or cloth to ensure all loose material has been removed from the iron.

## CLEANING AND MAINTENANCE

- When cold and unplugged, the iron can be cleaned with a damp cloth and wiped dry. Never use household cleaners or solvents.

### Cleaning the soleplate

Rowenta stainless steel soleplates have excellent non-stick properties and can simply be wiped clean when cold.

- In normal use a draggy coating may build up on the soleplate (starch, detergent buildup, burnt synthetic fibers). This can be easily removed by using the Rowenta Soleplate Cleaning Kit or a quality hot iron soleplate cleaner available at most stores.
- Do not use abrasive household cleaners or abrasive cleaning pads.
- The soleplate of your iron makes ironing easier. To prevent scratching of the soleplate, do not iron over sharp objects (zippers, etc.). Do not place the iron on rough surfaces, e.g. metal iron support, which may scratch the soleplate.

## IRON TROUBLESHOOTING

Problem	Possible cause	Solution
Iron is leaking.	<p>DISTILLED WATER</p> <p>SOFTENED WATER</p> <p>Auto-off activated? (depending on model)</p> <p>Overuse of burst of steam.</p>	<p>DO NOT use 100% pure distilled water, use tap water. In very hard water areas mix half tap water with half distilled to reduce hardness; or use inexpensive bottled spring water.</p> <p>Most softened water is alright, but if you experience leaks or spitting, change to untreated tap water or inexpensive bottled spring water. DO NOT use 100% distilled water.</p> <p>Move iron or gently shake.</p> <p>Allow more time between each burst.</p>
Iron won't heat.	<p>Is iron plugged in?</p> <p>Thermostat set too low?</p> <p>Auto-off activated? (depending on model)</p>	<p>Check plug is in socket.</p> <p>Turn thermostat higher.</p> <p>Move iron or gently shake.</p>
Ready light goes on and off.	This is normal.	The light goes on and off showing the thermostat is switching the heat on and off to maintain the correct temperature.
Iron does not steam.	<p>Iron is not hot enough.</p> <p>Is variable steam control correctly set?</p> <p>Steam valve is clogged.</p>	<p>If the iron is not hot enough the anti-drip system will activate and stop the iron's steam production. Set thermostat to the ●●● position. Always allow iron sufficient time to heat up (indicator light goes out) before activating the variable steam control.</p> <p>If iron is fitted with a variable steam control, turn it to a higher setting.</p> <p>Move variable steam control from min to max several times to clear blockage.</p>

### **STORE IRON ON HEEL (VERTICALLY) WITH STEAM CONTROL AT MIN.**

For more information refer to the full use instructions. If after using the trouble shooting guide you are still experiencing problems, do not return the iron to the store, but contact Rowenta Consumer Service who will be pleased to assist you.

In line with a policy of continuous product improvement Rowenta reserves the right to change product specifications without prior notice.

## Free Manuals Download Website

<http://myh66.com>

<http://usermanuals.us>

<http://www.somanuals.com>

<http://www.4manuals.cc>

<http://www.manual-lib.com>

<http://www.404manual.com>

<http://www.luxmanual.com>

<http://aubethermostatmanual.com>

Golf course search by state

<http://golfingnear.com>

Email search by domain

<http://emailbydomain.com>

Auto manuals search

<http://auto.somanuals.com>

TV manuals search

<http://tv.somanuals.com>