

Royal Sovereign LAMINATORS

OWNER'S MANUAL

RSH-1050/1650 ,RSR-685/1050



PLEASE READ AND SAVE INSTRUCTIONS

TABLE OF CONTENTS

TOPICS	PAGE
INSTRUCTION	3
SAFETY PRECAUTIONS	3
CHARACTERISTICS	4
SPECIFICATIONS	4
NAMES OF MAJOR PARTS OF MACHIN.....	5
HOW TO INSTALL THE REWINDER	6~7
HOW TO INSTALL THE UNWINDER	8
SETTING UP FILM	9
HANGING FILM	10
1.HOT FILM	10
2.COLD FILM	11
CONTROL OF ROLLER PRESSURE	12
INSTRUCTIONS FOR CONTROL PANEL	13
1.LCD WINDOW	14
2.FUNCTIONS OF BUTTONS	15
3.HOW TO USE BUTTONS	16~19
LAMINATING STEPS	20
1.HOT LAMINATING	20~21
2.COLD LAMINATING	22
TIPS FOR REMOTE CONTROL AND FOOT SWITCH	23
METHOD FOR USING CUTTER	23
*.CROSS CUTTER	23
IMPORTANT SAFETY CONCERNS	24
MAINTENANCE	24
IT'S NOT OUT OF ORDER	25
SPARE PARTS	25
WARRANTY	26
SPEED & TEMPERATURE ADJUSTMENT.....	27

INSTRUCTION

Thank you for purchasing a Royal Sovereign Roll Laminator. It has been designed and manufactured to provide years of continuous service in the professional environment. To insure high quality lamination, please read this instruction manual thoroughly. This manual will provide you with complete operating and maintenance information. For additional product support or factory-direct ordering information. Call Royal Sovereign Customer Service at 1-800-397-1025.

SAFETY PRECAUTIONS

The safety recommendations outlined in this section are to be read, understood and followed before operating machine.

Keep this information for future reference. Failure to comply any of the following safety procedures could result in serious personal injury.

1. To prevent the possibility of electrical shock, do not immerse machine in water or permit liquids to spill inside.
2. Do not allow articles of clothing (neckties, scarves, papers, etc.) near front or rear machine openings as they could get caught by rollers and be pulled inside, causing personal injury.
3. Do not insert sharp objects into front or rear machine openings. Do not place anything in feed tray openings of machine other than appropriate laminating materials or pouches.
4. Do not attempt to laminate items that exceed total recommended material thickness.
5. Do not operate machine for any other purposes than its intended use.
6. Do not operate machine if electrical plug or power cord is damaged.
7. Turn off the power when unattended or not in use. Unplug machine before moving it or when it is not in use for an extended period of time.
8. This machine is intended for indoor use only.
9. Do not alter or extend electric plug. Plug is configured for appropriate electrical supply.
10. The socket-outlet shall be installed near the equipment and shall be easily accessible.

CHARACTERISTIC

RS Roll Laminator Line is advanced laminators with time transcendental design, utilizing the latest in laminating technology.

It is designed for you to set temperature and speed as necessary and have the machine remember your settings. Also, you can laminate anything at high speed, regardless of thickness of material and type of film.

Remote control device allows for control of the machine from the front or rear.

Foot-Pedal Switch allows for hands-free operation.

It is also designed for convenient use by anyone through the simple procedure of adjusting film tension in accordance with the thickness of film and materials to be laminated.

SPECIFICATIONS

Description	RSH-1650	RSR-1050	RSH-1050	RSR-685
Dimensions(w x d x h)	1960x650x1210mm (77.2x25.6x47.4in)	1400x650x1220mm (55.1x25.6x48.0in)		1070x650x1220mm (42.1x25.6x48.0in)
Weight	300Kg (660lbs)	140Kg (308.6lbs)		100Kg (220.5lbs)
Voltage/Cycles	AC100~120V, 50/60Hz AC220~ 240V, 50/60Hz			
Power Consumption	3300w	3000w		2000w
Max. Laminating Speed	2m/min 6.5ft/min	4m/min 13.1ft/min	2m/min 6.5ft/min	4m/min 13.1ft/min
Max. Laminating Width	1650mm (64.9inch)	1050mm (41.3inch)		685mm (27inch)
Max. Laminating Thickness	15.0mm (0.6inch)		13.0mm (0.5inch)	
Film thickness	32 - 250micron (1.3-10mil)			
COLD and WARM Laminating	Yes	Yes		Yes
Cooling Blowers	3	2		1
Take-Up	Yes	Yes		Yes
Film Alignment	No	Yes		Yes
Cutter-Cross	Yes	Yes		Yes
Ass'y Stand	Yes	Yes		Yes
Switch-Foot	Yes	Yes		Yes
Wired Remote Control	Yes	Yes		Yes

NAMES OF MAJOR PARTS OF MACHINE



NO	PART NAME	RSH-1650	RSH-1050	RSR-1050	RSR-685
1	FRAME-GUIDE,PAPER	<input type="radio"/>	<input type="radio"/>	<input type="radio"/>	<input type="radio"/>
2	TAKE-UP SWITCH	<input type="radio"/>	<input type="radio"/>	<input type="radio"/>	<input type="radio"/>
3	TAKE-UP BOBBIN	<input type="radio"/>	<input type="radio"/>	<input type="radio"/>	<input type="radio"/>
4	IDLE BAR	<input type="radio"/>	<input type="radio"/>	<input type="radio"/>	<input type="radio"/>
5	TABLE-FRONT	<input type="radio"/>	<input type="radio"/>	<input type="radio"/>	<input type="radio"/>
6	HOT ROLLER	<input type="radio"/>	<input type="radio"/>	X	X
	HOT METAL ROLLER	X	X	<input type="radio"/>	<input type="radio"/>
7	ASS'Y-STAND	<input type="radio"/>	<input type="radio"/>	<input type="radio"/>	<input type="radio"/>
8	FOOT SWITCH	<input type="radio"/>	<input type="radio"/>	<input type="radio"/>	<input type="radio"/>
9	REMOTE CONTROL SWITCH	<input type="radio"/>	<input type="radio"/>	<input type="radio"/>	<input type="radio"/>
10	CONTROL PANEL	<input type="radio"/>	<input type="radio"/>	<input type="radio"/>	<input type="radio"/>
11	PRESSURE LEVER	<input type="radio"/>	<input type="radio"/>	<input type="radio"/>	<input type="radio"/>
12	TENSION CONTROL KNOB	<input type="radio"/>	<input type="radio"/>	<input type="radio"/>	<input type="radio"/>
13	FILM ALIGNMENT KNOB	X	<input type="radio"/>	<input type="radio"/>	<input type="radio"/>
14	SAFETY COVER	<input type="radio"/>	<input type="radio"/>	<input type="radio"/>	<input type="radio"/>

How to install the rewinder

1. Disassemble both the Right cover and the Left cover. (Note :Turn the fastening nut of the Emergency switch counterclockwise and disassemble the Emergency switch before disassembling the Right cover.)



2. Disassemble the Rear cover.
3. Disassemble the power switch bracket which is located at the left side of the machine.

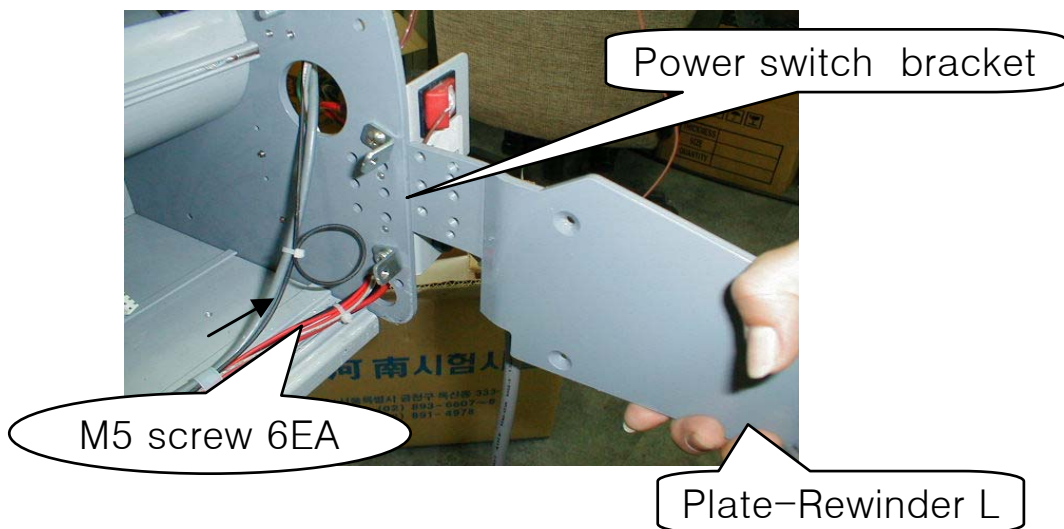

4. Put the Plate-Rewinder L on the outer side of the frame as shown in the following figure and fasten it with six M5 screws.
5. Put the Plate-Rewinder R on the outer side of the frame as shown in the following figure and fasten it with six M5 screws.

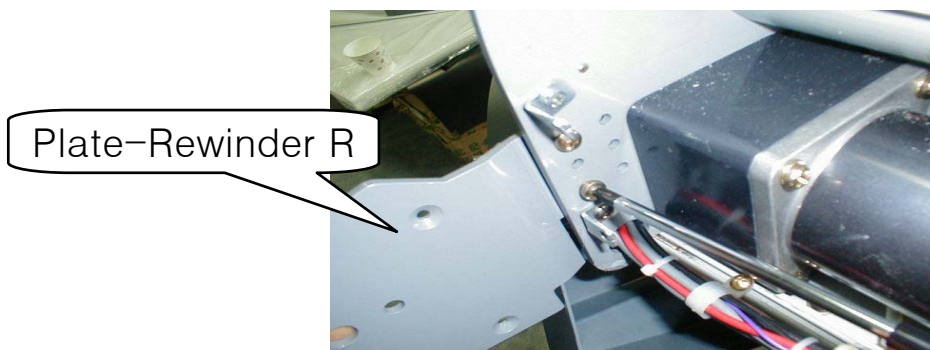

6. Insert the male connector from the Rewinder motor into the female connector from the

take-up motor.

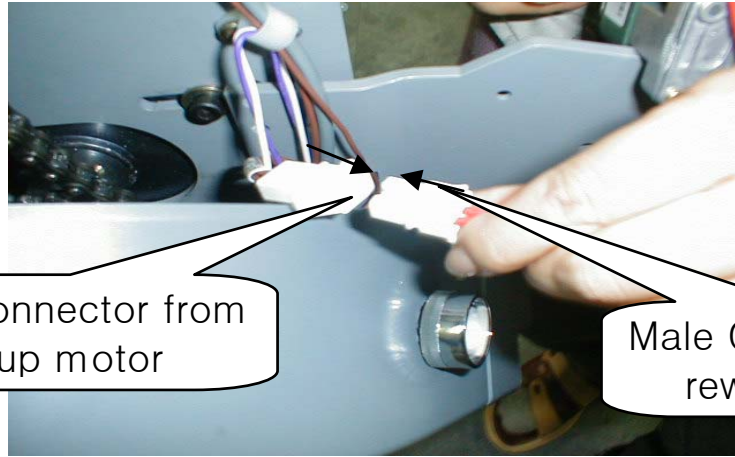

Female Connector from
take-up motor

Male Connector from
rewinder motor

7. Assemble the Right cover letting the wires go through the slot which is located at the rear side of the Right cover.

8. Put the Power switch bracket on the Plate-Rewinder L and fasten it with two M4 screws.

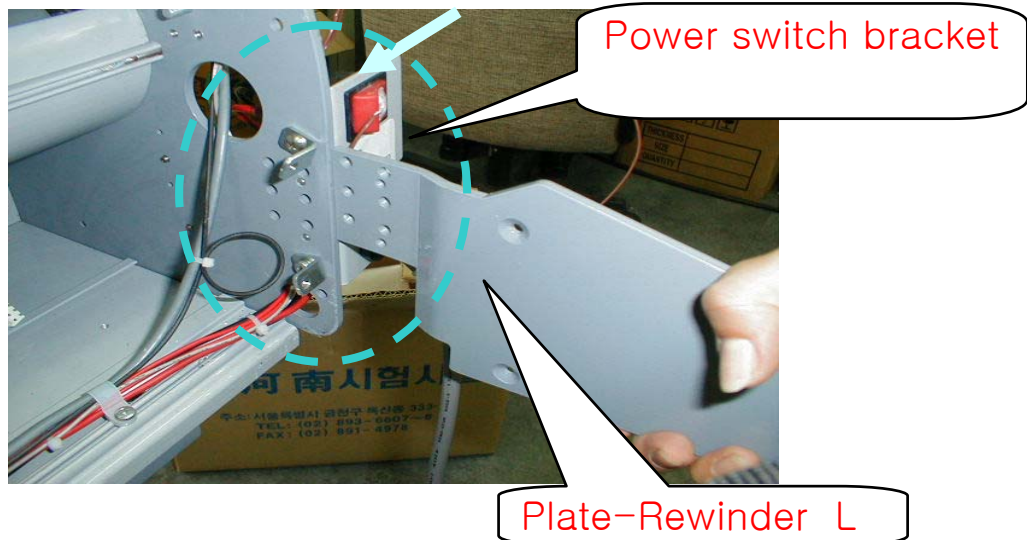

Power switch bracket

Plate-Rewinder L

How to install the unwinder

1. Put the Plate-Unwinder R on the inner side of the frame as shown in the following figure and fasten it with four M6 hexagonal bolts.

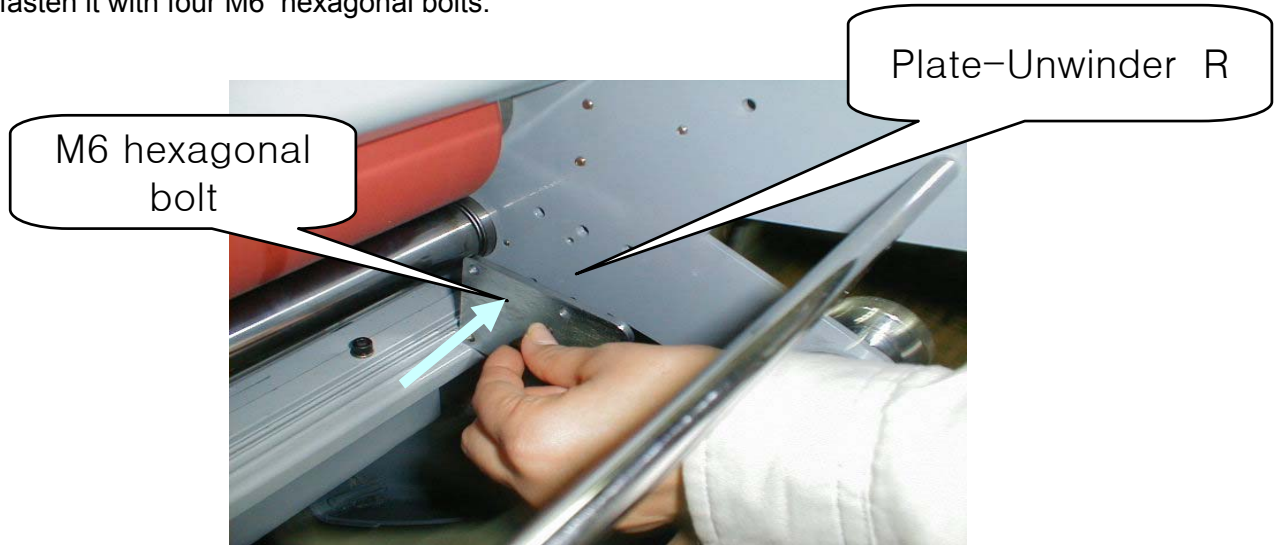

2. Put the Plate-Unwinder L on the inner side of the frame as shown in the following figure and fasten it four M6 hexagonal bolts.



SETTING UP FILM

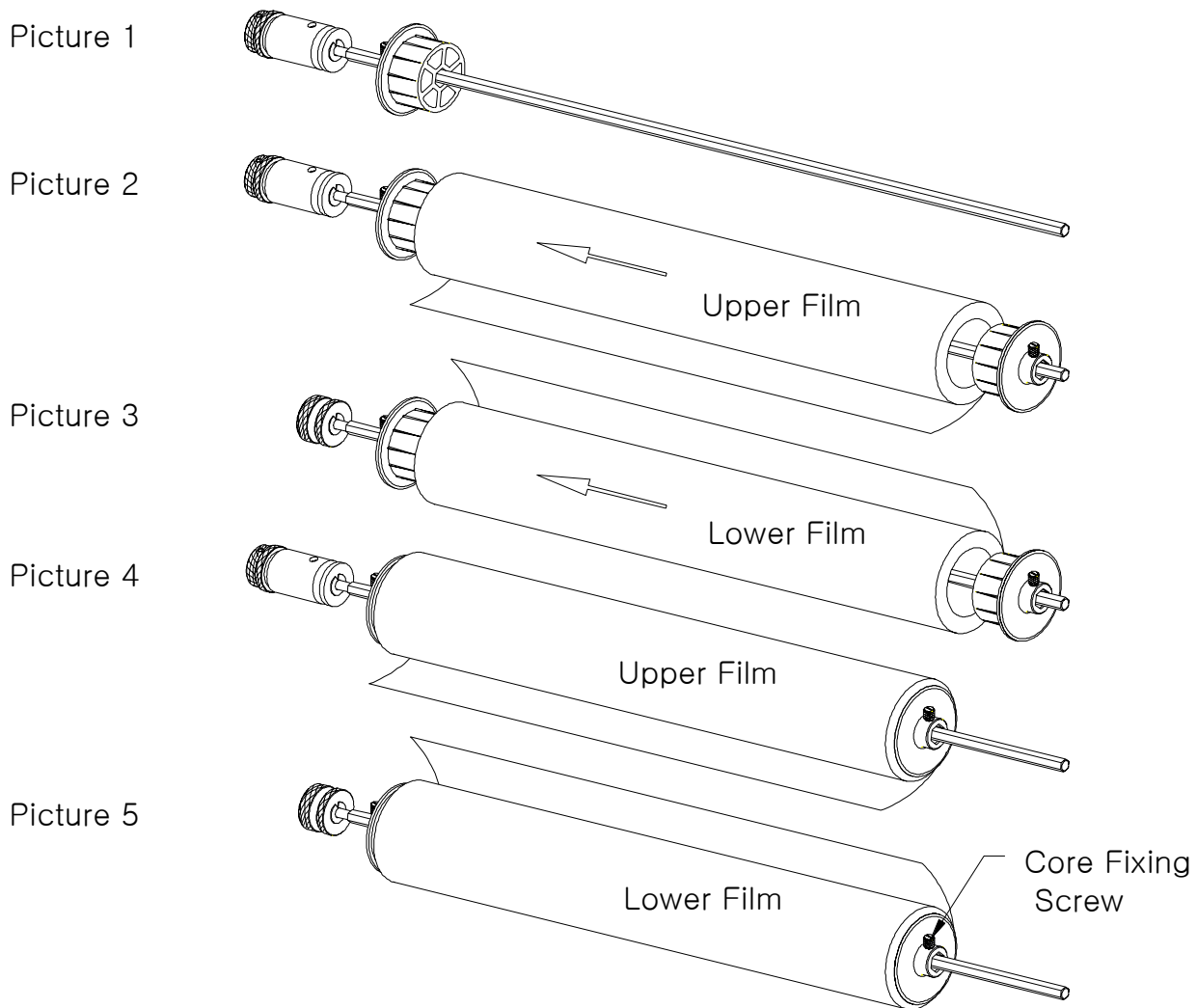

1. Set the glossy side of upper/lower film to face the heat.
(Glossy side is PET film and matte side is thermal polymer laminating film.)
2. Like picture 1, insert core into the left side of upper/lower film shaft.
3. Like picture 2 and 3, insert core into the right side of upper/lower film.
4. Like picture 4 and 5, adhere core closely.
(Make the right/left direction of fixing screw consistent.)
5. Locate film in the middle, and then fasten core fixing screw.

HANGING FILM

1. HOT FILM

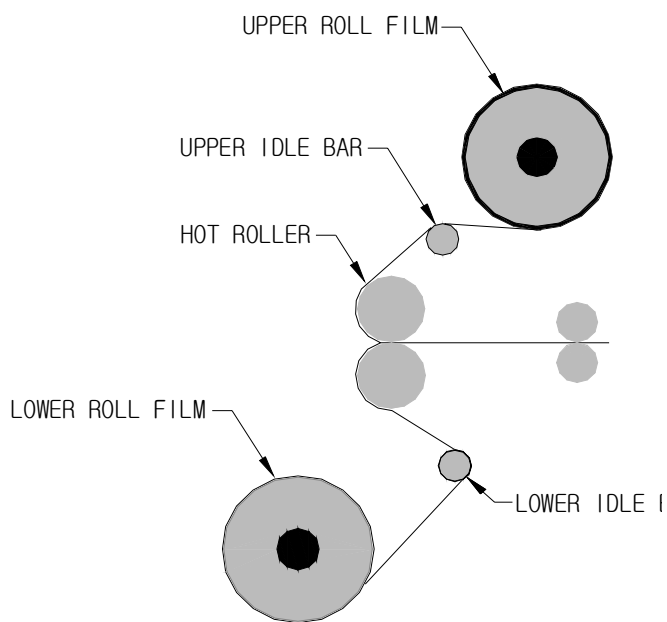

RSH-1050/1650

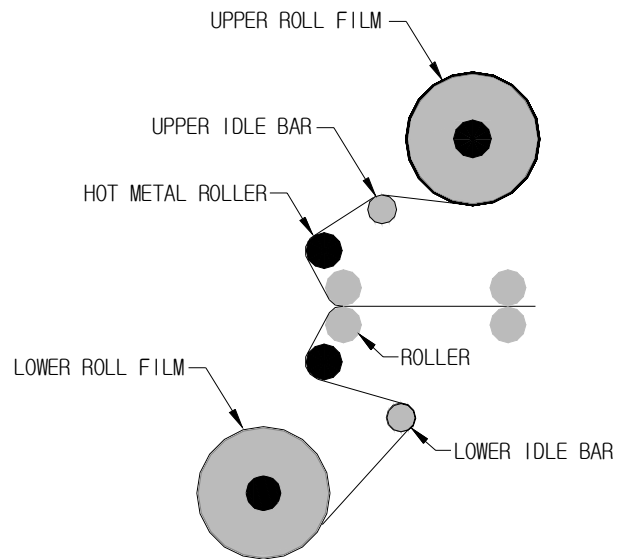

RSR-685/1050

1. Insert bar into the core of the roll film then place the bar on the machine.
2. Place the Pressure Lever (on the right side of machine) to the open mode at 15mm.
3. Insert a piece of wide cardboard (guiding paper/carrier) between the rollers.
4. Pull the film from the upper roller passing over the upper idle bar to the upper roller and put it on the roller.
5. When temperature reaches 80°C (176°F) , resin starts melting and films turn to be transparent.
6. Place the film from lower shaft beneath the film from the upper roller which is already melting and unwind films of both rollers 30~40Cm(1~1.3ft) for loosing the tension.
7. Set the pressure Lever to the 1mm.
8. Set speed at 1 and press Run button. The films will be fed into the machine and will come out from the rear site of machine.
9. Check the status of lamination and place the pressure lever at lamination mode.

2. COLD FILM

TAKE UP DEVICE

1.0

TAKE UP DEVICE

COLD FILM

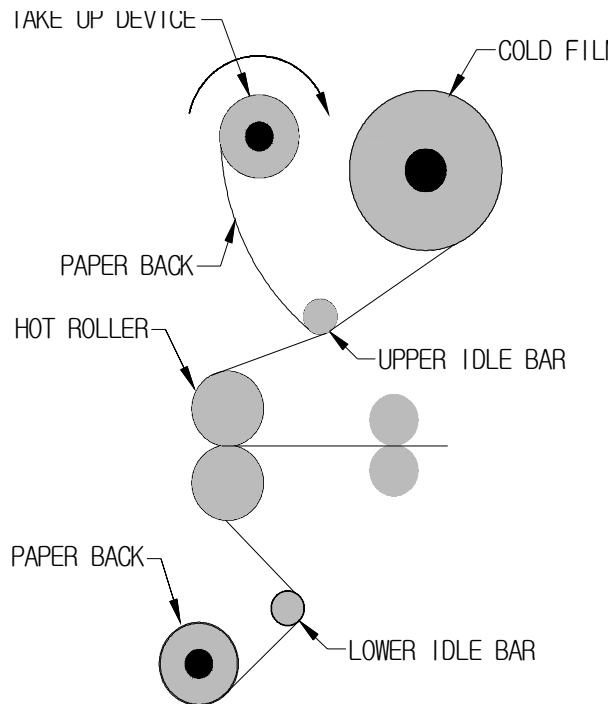

RSH-1050/1650

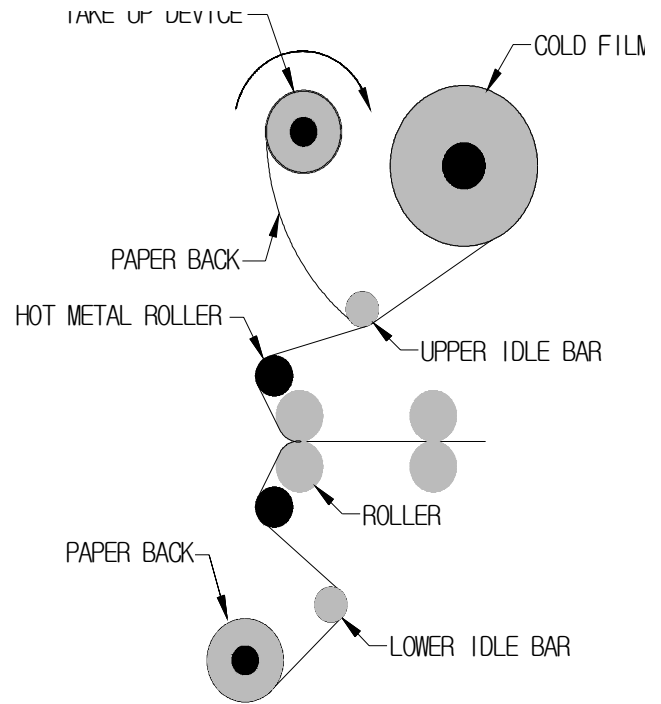

RSR-685/1050

1. Set up cold film below the upper bar of the machine
(Set the same as method of HOT film for protect paper of lower part)
2. Set the pressure Lever to the 15mm, open mode
3. Insert a piece of wide cardboard (guiding paper/carrier) between the rollers
4. Pull the film from the upper roller passing over the upper idle bar to the upper roller and put it on the upper roller.
5. Put the paper back of the film to the bobbin at take-up bar to rewind the paper back.
6. Allow some of the film with melted resin to stick to the Guiding Paper.
7. Place the film from lower shaft beneath the film from the upper roller which is already melting and unwind films of both rollers 30~40Cm(1~1.3ft) for loosing the tension.
8. Set the pressure Lever to the 1mm
9. Set speed at 1 and press Run button. The films will be fed into the machine and will come out from the rear site of machine
10. Check the status of lamination and place the pressure lever at lamination mode

CONTROL OF ROLLER PRESSURE

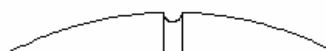

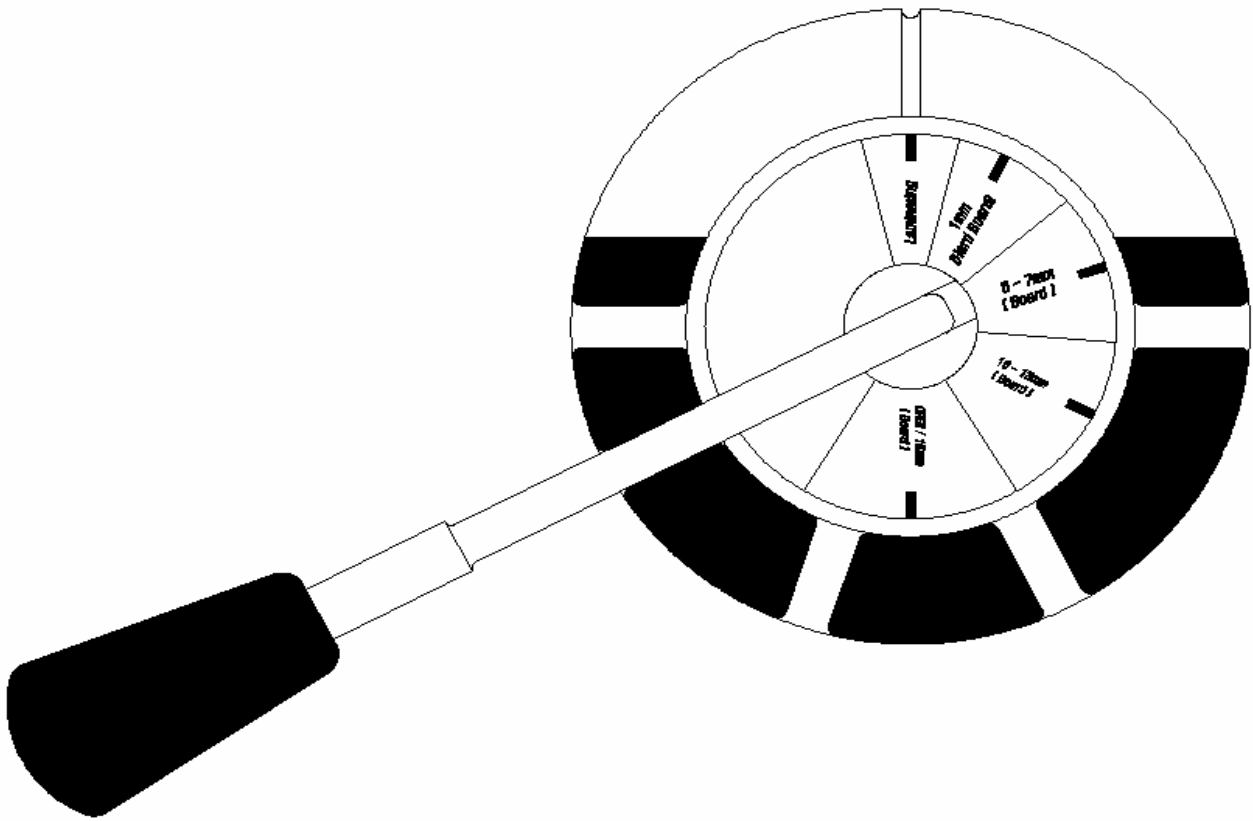

*****Methods of controlling pressure of the roller****

1. For setting, pull the pressure lever out and turn the lever to following the indication
2. Open/15mm : for laminating 15mm(0.6") thick board (RSH-1050/1650)
3. 10~13mm : for laminating 10~13mm (0.4" to 0.5") thick board
4. 5~7mm : for laminating 5~7mm(0.2" to 0.27") thick board
5. 1mm : for laminating 1mm(40mil) thick board
6. LAMINATING : for laminating 32~250micron thick film

INSTRUCTIONS FOR CONTROL PANEL

We designed this machine standing by user's convenience. You can manipulate

speed and temperature of rollers each by each by the LCD controller.

And with memory function, you don't need to set machine every time you laminate.

Terms

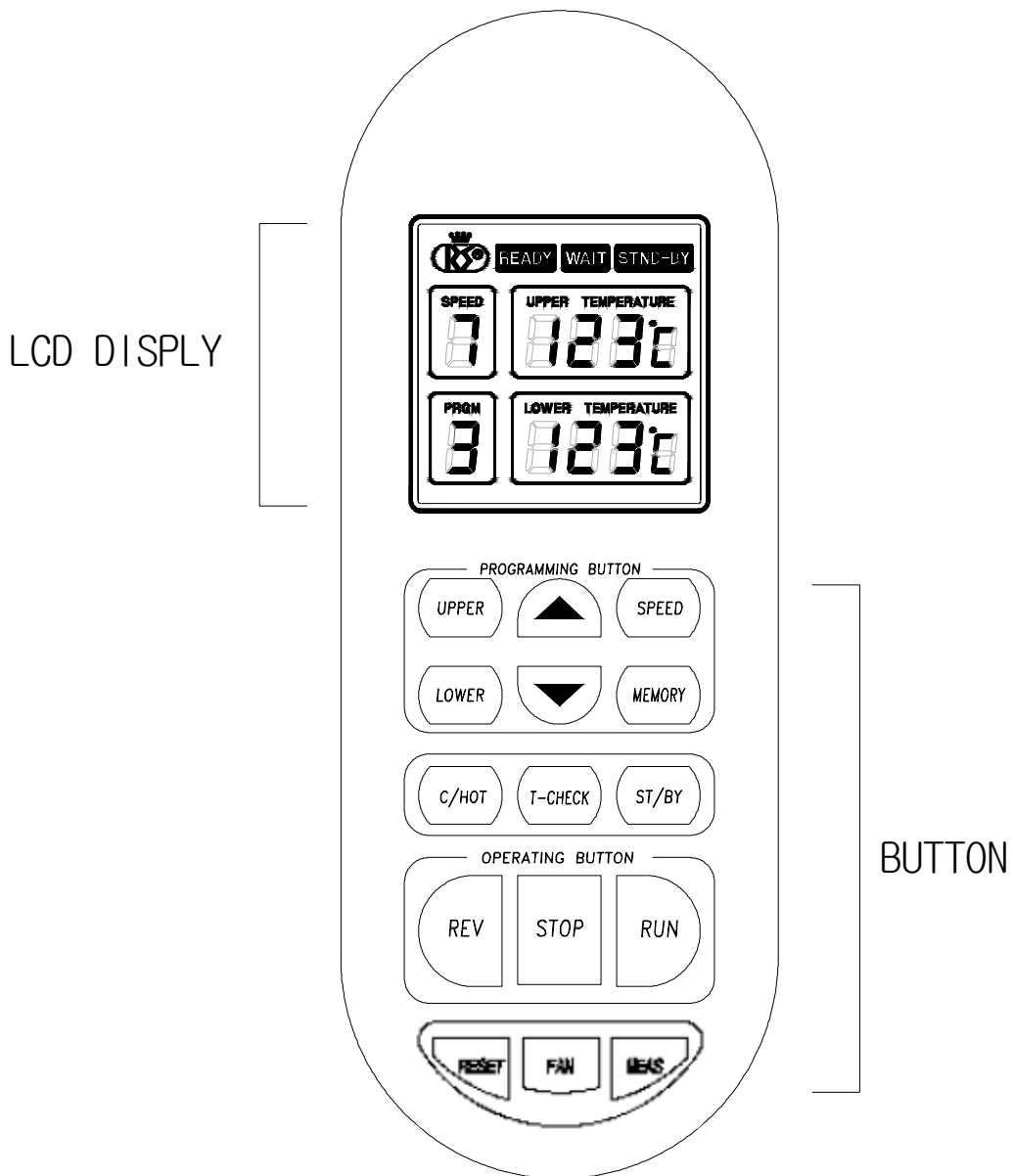

1.LCD WINDOW

1. Initial display status.



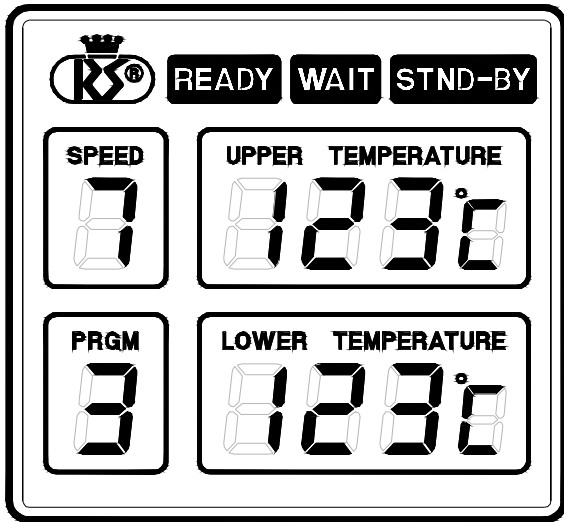







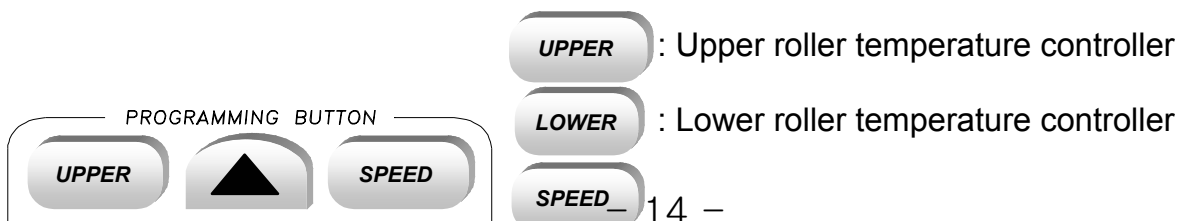

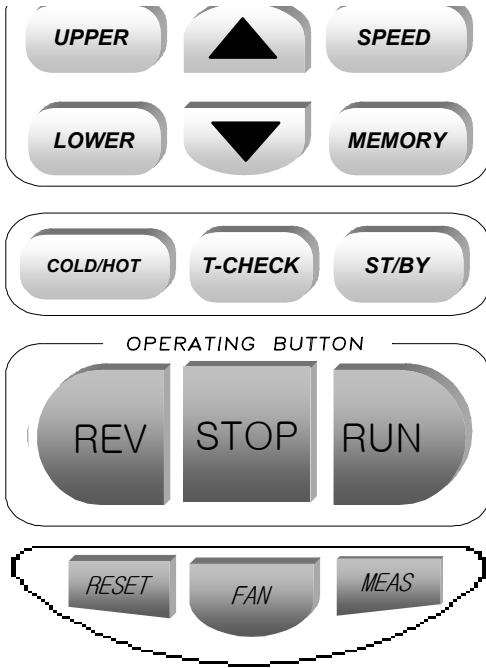





It displays you the last working condition when turned on.

2. **READY**
Is displayed when the preset temperature is reached.
3. **WAIT** Blinking
Indicates to wait till blinking stops. Current temperature is higher or lower than the preset temperature.
4. **STND-BY**
Saving electricity status.
5. Temperature
 - 1) Shows the preset temperature
 - 2) You can check the current temperature on the heat shoe by pressing T-Check
6. Speed
 - *9 different speed option.
 - "RSH" type---(SPEED1->0.4m(1.3ft)/min.
SPEED9-> 2.0m(6.5ft)/min.)
 - "RSR" type---(SPEED1->0.8m(2.6ft)/min.
SPEED9-> 4.0m(13.1ft)/min.)
 - *You can choice from1to4 for Cold Function
7. PRGM
 - *9 different memory cell (address)
 - You can memorize 9 different working conditions.

2. FUNCTIONS OF BUTTONS





-  : Speed controller
-  : Choose memorized working condition
-  : ① Increase temperature
② Increase speed
③ Restore the memorized working setting
-  : ① Decrease temperature
② Decrease speed
③ Restore the memorized working setting
-  : Cold and Hot mode change
-  : Check current temperature
-  : Saving electricity while the machine is not being operated.
-  : Reverse function
Stay pressing reverse button to have the roller run backward.
-  : Stop working
-  : Run the rollers.
-  : Run and stop the fans
-  : Count & Length Values Format
-  : Change Into Count & Length Mode

3.HOW TO USE BUTTONS

Set the upper/ lower hot rollers



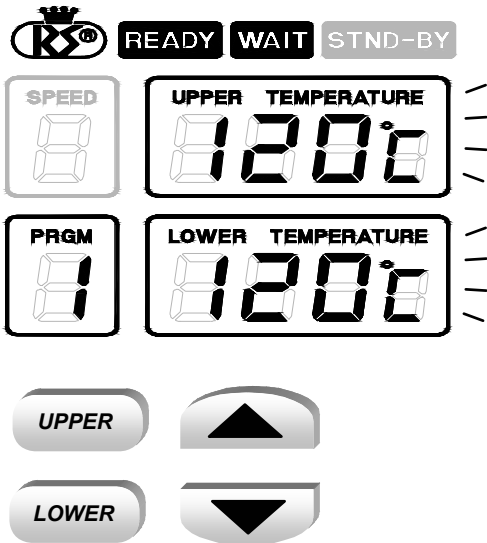

Button & Display

1. Temperature available range from 0°C (32°F)

Button & Display





to 160°C (320°F).

2. Temperature setting of upper roller
Press **UPPER** and you will see the LCD screen is blinking 6 times. Before blinking is finished, press  or  to set the temperature
3. Set temperature of lower roller
Press **LOWER** and choose the arrow button the same way to set temperature of upper roller.
- 4   Each time you press the button, it will change 1°C (2°F). If you press the button more than 1 seconds, temperature will change automatically until you press the button again.
5. Buzzer is ringing each time you press the button.

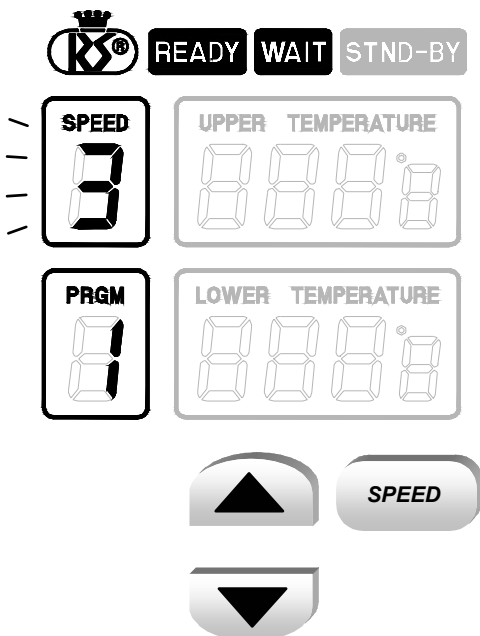
***Speed controls



1. The operator can use 9 different lamination speeds.
2. Press **SPEED** button then speed display mode is blinking 6 times
Before blinking finish, the operator can change the speed with  or 
3. Each time you press the button, buzzer will ring.

Memorizing Working condition and Using the memorized working condition



1) Memorize working condition

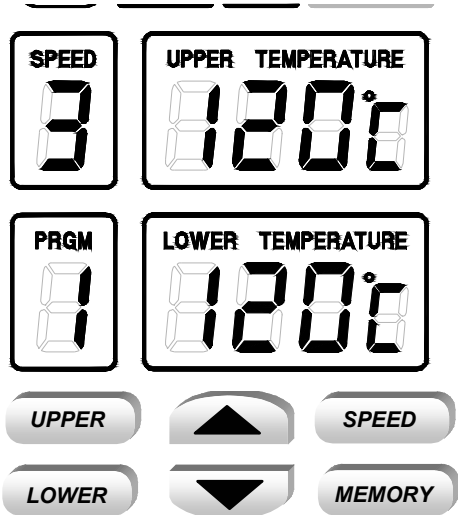

1. Operator can memorize 9 working conditions.
2. Choose working condition by pressing and button after pressing button.
and speed, press button.
3. It is memorized if buzzer is ringing with blinking.
* If you change the temperature or speed when LCD screen is still blinking, you have to press button after changing.
4. When you memorize another working condition, you can do above 2 and 3 operation over.

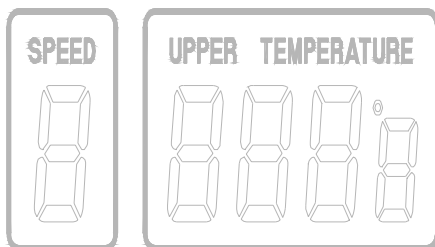

2) Use the memorized working condition.

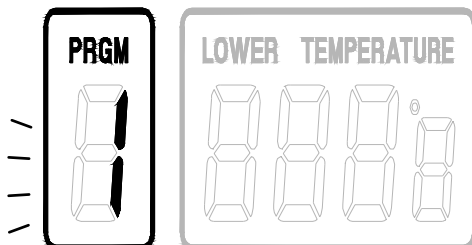

1. Operator can choose one of 9 memorized working conditions.
2. Press then or to select a working condition. The display will blink.
3. After the blinking stops, it is set the working condition you selected and shows the working condition on the display.

Check current temperature on the hot rollers.



1. When you press button, the present temperature will be shown on the screen and will

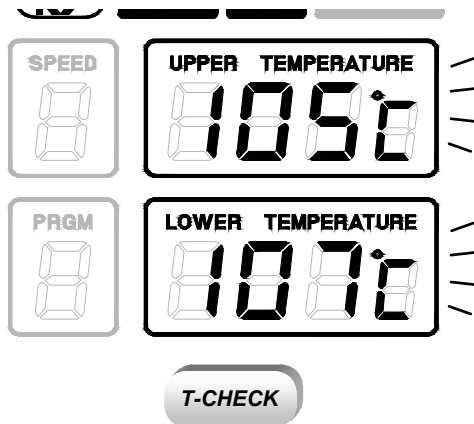

- blink five times.
- 2. After this, it automatically returns to the previous state.

Cold mode

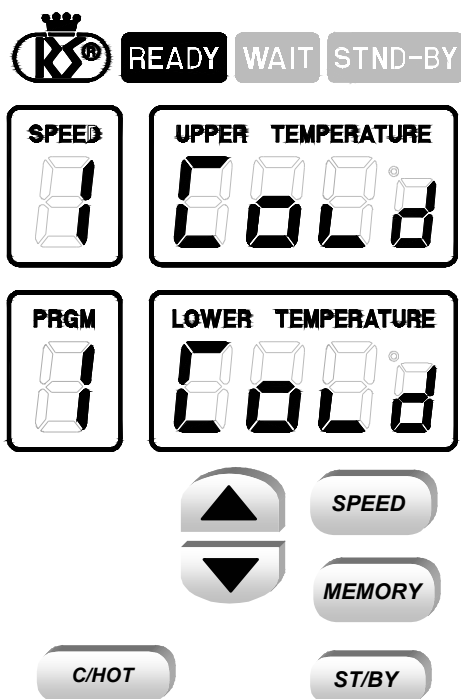

1. You can do cold lamination with this function.
2. Press the **C/HOT** button to show "Cold" on the display.
3. Speed will always show 2.
4. Speed can be varied 1 or 4 by selecting **▲** **▼** button.
5. You release the machine from cold mode by pressing **C/HOT** button.
6. Everytime you press the button, buzzer is ringing
7. ST/BY mode is not working at COLD mode.

STND-BY (Saving Electricity while you are not operating for a while)

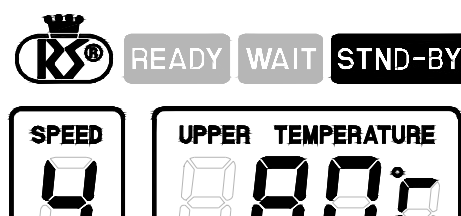

1. When press **ST/BY** button **STND-BY** will display on the screen and STND-BY mode is set at 80C.
2. When machine is in **STND-BY** mode, machine

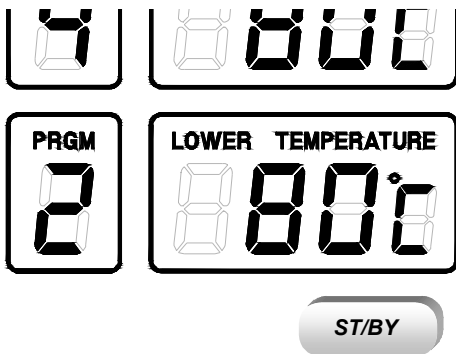

- condition wouldn't work. Press the **ST/BY** button and it will revert to the previous working.
- When machine runs, you can't change it to the **STND-BY** mode. In this case, press the **STOP** button and turn the machine to the **STND-BY** mode.

*****Check the laminating length & How many laminated papers*****

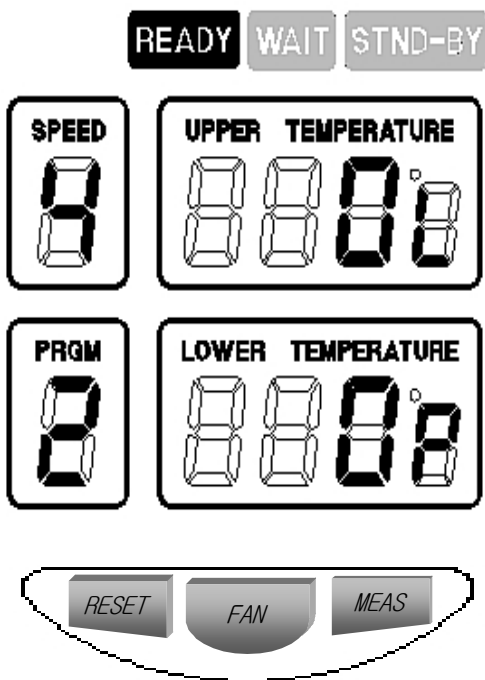





- When press **MEAS** button the present numbers of length and papers laminated will be shown on the screen.
- When you want to return to working mode Press **MEAS** button again.
- Also, you can reset measure mode by pressing **RESET** button.(for 2 second)



LAMINATING STEPS

1. HOT LAMINATING

- Turn the power switch on the back side of the machine.
(Emergency Switch must be turned off)

2. Set the pressure lever to the “Laminating mode”
3. Increase roller temperature. If you already memorized special working condition, press  button and choose right condition by using  or  button.
4. When it's ready, you will see ready sign on the screen and the buzzer will ring.
5. Press the  button. If rollers don't run, check the emergency switch whether it is located at “ON” position or not.
6. To set film tension properly, use the Tension Control Knob.
Lower tension would make better operation.
7. Set document on the table. You should allow at least 5mm(1/4”) space on each side for perfect laminations.
8. Press the  button when your lamination is finished.
9. For your convenience, it would be better to set table guide in proper position.
10. When lamination is just finished, it is hot and easily bent. Try not to touch it until it cools down.
11. After finishing your work, set the pressure lever to the “Hard Board/15mm
12. Turn the Power switch off

Useful Information

1. It would be easier for you to operate the machine next time if the temperature and the speed are set at the best condition and memorized by the using  function.
- 2  sign may appear on LCD window in the case continuous laminating.

If it happens, the speed needs to be lowered by one speed level and started again after **READY** signal on the LCD window.

3. In case of wrinkling or rolling of film due to wrong position of document, **REV** is needed to be keeping pushed in order that document could come out to the front with buzzer sound.
4. When document is much smaller than film, you should place it in the middle of film for preventing wrinkle
5. Use cooling fan when you laminate continuously without break and document is too hot.

*****Laminating Speed at each level (mm(ft)/min) *****

SPEED	RSR-685/1050	RSH-1050/1650
1	800mm(2.6ft)	400mm(1.3ft)
2	1200mm(3.9ft)	600mm(2ft)
3	1600mm(5.2ft)	800mm(2.6ft)
4	2000mm(6.56ft)	1000mm(3.3ft)
5	2400mm(7.9ft)	1200mm(3.9ft)
6	2800mm(9.2ft)	1400mm(4.6ft)
7	3200mm(10.5ft)	1600mm(5.2ft)
8	3600mm(11.8ft)	1800mm(5.9ft)
9	4000mm(13.1ft)	2000mm(6.6ft)

The above laminating speed numbers are at the condition on regular voltage with almost no film tension. There might be the possibility for difference to the above numbers due to the change of voltage or adjustment of tension.

2. COLD LAMINATING

1. Put cold roll film on upper bar.(Set the same as method of HOT film for protect paper of lower part)
2. Pull COLD film, and fix it so that backside protecting paper can be wound on take-up mandrel clockwise. (Revolve core to make protectingpaper tight a little bit.)
3. Set pressure lever at the proper position following to your lamination condition.

4. After pressing the **C/HOT** button choose and set proper speed by using the **SPEED** and **▲** **▼** button.
5. It is **READY** when ready is show on the screen and the buzzer rings three times. sound three times.
6. Turn on the take up device and set the proper film tension by pressing the **RUN** button. Lower tension would make better operation.

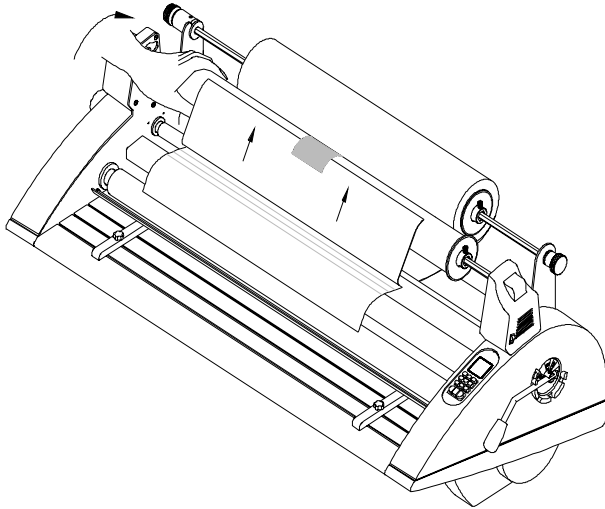

7. Set document on the table. You should allow at least 5mm(1/4") space on each side for perfect laminations
8. Turn the switch "Run" and "take up motor" at the same time. The liner and film will be rolled at the same time.
9. When lamination is finished, press the **STOP** button. For your convenience, it would be better to set table guide in proper position. And if needed, cut documents with cross cutter.

10. Set pressure lever at the Hard board/15mm mode.
11. Turn off the power switch.

*** Reference ***

1. Set up the protection paper. Otherwise, glue form the film will be stuck on the face of roller and it can be seriously damaged.
2. Turn the switch "Run" and "Take up motor" at the same time.
3. For worm lamination, set temperature from the hot mode.

TIPS FOR REMOTE CONTROL AND FOOT SWITCH

1. It is convenient to use the remote control in the back of machine while laminating.
2. It is also convenient if you use Foot Switch while laminating HARD BOARD.
3. "RUN", "STOP", "REV" buttons on Remote Control have same functions with the ones on Control Panel.

4. Press Foot Switch one time for "RUN", press one more time for "STOP".
(Don't keep pressing)
5. After use of Remote Control, attach it to the left side of rear of machine

METHOD FOR USING CUTTER

****Cross Cutter****

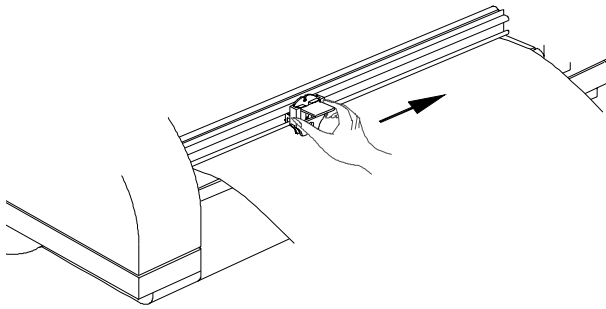

1. It is on the back side of the machine.

2. After lamination, move cutter to a point about 1/3 of the width of lamination

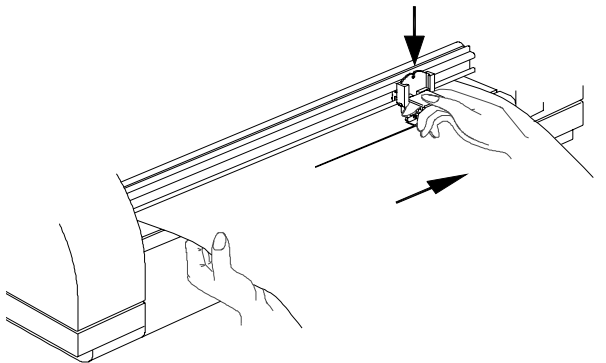

3. Grasp film with one hand and press the cutter downward and slide it to the direction intending to cut with another hand.

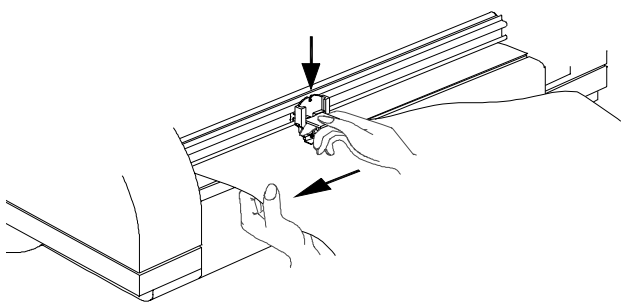

4. Press the cutter and slide it the other way.

IMPORTANT SAFETY CONCERNS

1. Please be cautious that neck tie, necklace, long hair, clothes are kept well away while operation.
2. Prevent children from accessing the machine

Extreme Heat Will Cause Injury

3. Place the machines on the plated place so that
4. Make certain that the machine is connected to an adequate power source.
5. Do not use any other purposes other than Lamination.

MAINTENANCE



1. Do not allow the machine to run with only one roll of film installed. The melted resin will adhere to one roller and ruin future laminations.
2. The width of film should be bigger than the material, and Width of upper side and lower side of film should be same in order not to allow melted resin to adhere to the rollers.
3. Be sure to adjust the film tension while in operation. If the tension is too tight, it could cause the film to stretch.
4. After work, you should clean the resin from the rollers before beginning the next operation.
5. Please check the lubricant after long operation or you do not use for a long time.
6. Check the chain linking each gear is not loosened. The limit tension allowed is 3mm.

It's not out of order

Symptom	Cause	Check point
*Rollers do not operate after press RUN button	<ol style="list-style-type: none">1. Power cord may not be plugged in.2. Power switch is at OFF mode.3. Emergency switch may be at ON mode.	<ol style="list-style-type: none">1. Check the power cord2. Check the switch is on3. Check the emergency switch is off4. Release STND-BY switch by

	4. It may stay at STAND-BY mode.	press the STND-BY button
*Hot roller is not heater up.	1. It is set at the cold mode 2. Memorized temp may be lower than atmosphere temp.	1. Change the function to hot lamination. 2. Set proper temperature for the work
*Wrinkled lamination result	1. Film tension is not proper, too tight.	1. Adjust film tension.
*Result of lamination is not clear	1. Temperature on the hot roller is too low or lamination is too speedy.	1. Increase the temperature on the hot roller or decrease the speed.

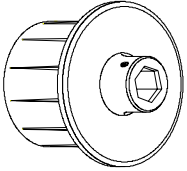
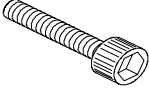
SPARE PARTS

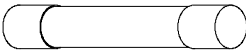
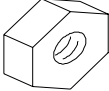
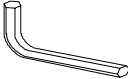
PART NAME	EA	MODEL	PART NAME	EA	MODEL
Core(76mm) 	6	RSH-1650 RSH-1050 RSR-1050 RSR-685	Bolt(M8X65) 	8	RSH-1650 RSH-1050 RSR-1050 RSR-685
FUSE(50T) (AC250V 6.3A) 	1		Washer(Φ8) 	8	
FUSE(65TS) (AC250V 20A) 	1		Nut(M8) 	4	
			L-Wrench 	1	

WARRANTY

1. For six month from the date of purchase, Royal Sovereign International Corporation or its authorized service center will repair this product free of charge if it is defective in material or workmanship.
2. This Limited Warranty does not include cleaning, or damage caused by accident, neglect, misuse or improper installation, operation or external scratch, any damage caused from service, maintenance, modifications or tampering by anyone other than

a Sovereign authorized service representative, or damage caused by a natural calamity such as fire or earthquake and etc...

3. Customers will bear the expense of Transportation fee and delivery fee of the damaged machine.

Speed & Temperature Adjustment

NO	Film thickness	Preset			User		Remark
		Temp	Speed	Func'No	Temp	Speed	
1	38 micron (1.5 mil)	110	5	1			
	75 micron						

2	75 micron (3 mil)	115	4	2			
3	80 micron (3.2 mil)	120	5	3			
4	100 micron (4 mil)	120	4	4			
5	125 micron (5 mil)	125	5	5			
6	150 micron (6 mil)	125	3	6			
7	175 micron (7 mil)	130	4	7			
8	200 micron (8 mil)	135	3	8			
9	250 micron (10 mil)	140	3	9			

Free Manuals Download Website

<http://myh66.com>

<http://usermanuals.us>

<http://www.somanuals.com>

<http://www.4manuals.cc>

<http://www.manual-lib.com>

<http://www.404manual.com>

<http://www.luxmanual.com>

<http://aubethermostatmanual.com>

Golf course search by state

<http://golfingnear.com>

Email search by domain

<http://emailbydomain.com>

Auto manuals search

<http://auto.somanuals.com>

TV manuals search

<http://tv.somanuals.com>