

## 16. WARRANTY

Royal Sovereign International warrants the equipment sold is free from defects in material and workmanship for a period of One (1) year for Parts and Labor from the date of installation, excluding lamination rollers which are warranted for Six (6) months. This warranty is extended only to the original purchaser. This warranty is the only warranty made by Royal Sovereign International and cannot be modified or amended. Royal Sovereign's sole and exclusive liability and the customer's sole and exclusive remedy under this warranty shall be, at Royal Sovereign's option, to repair or replace any such defective part or product. These remedies are only available if Royal Sovereign's examination of the product discloses to Royal Sovereign's satisfaction that such defects actually exist and were not caused by misuse, neglect, attempt to repair, unauthorized alternation or modification, incorrect line voltage, fire, accident, flood or other hazard.

All warranty claims must be filed through the authorized Royal Sovereign dealer or reseller through which the equipment was originally purchased. Model, serial number and date of delivery are required for all claims.

The warranty made herein is in lieu of all other warranties, expressed or implied, including any warranty or merchantability or fitness for a particular purpose. Royal Sovereign will not be liable for personal damage or personal injury (unless primarily caused by its negligence), loss of profit, or other incidental or consequential damages arising out of the use or inability to use this equipment.

### LIMITED WARRANTY

This warranty specifically does not cover damage to laminating rollers caused by knives, razor blades, or any sharp objects or abrasives, or failure caused by adhesives, or damage caused by lifting, tilting or improper use of the machine. Warranty repair or replacement by Royal Sovereign or its authorized Reseller(s) does not extend the warranty beyond the initial one year period from the date of installation. Unauthorized customer alterations will void this warranty.

#### CORPORATE HEADQUARTERS

#### Royal Sovereign International Inc.

2 Volvo Drive, Rockleigh, NJ 07647 U.S.A.

TEL : +1) 800-397-1025 FAX : +1) 201-750-1022

E-mail : [info@royalsovereign.com](mailto:info@royalsovereign.com)

#### RS Holland B.V.

Planetenweg 75 2132HM Hoofddorp, The Netherlands.

TEL : +31) 23-5626620, +31) 23-5654451

FAX : +31) 23-5654565

E-mail : [purchaseorder@royalsovereign.com](mailto:purchaseorder@royalsovereign.com)

#### Royal Sovereign Inc. <Oversea Sales Office>

1001, World Meridian II, 426-5, Gasan-dong,

Geumcheon-gu, Seoul, 153-759, KOREA

TEL : +82)2-2025-8800 FAX : +82)2-2025-8830

E-mail : [sales@royalsovereign.com](mailto:sales@royalsovereign.com)

#### RS Canada Inc.

164 Oakdale Road, Toronto, Ontario M3N 2S5

CANADA

TEL : +1) 416-741-8400 FAX : +1) 416-741-8185

E-mail : [info@royalsovereign.com](mailto:info@royalsovereign.com)

#### RS International Australia PTY. LTD.

30 Prime Drive, Seven Hills, NSW 2147, Australia

TEL : +61) 2-9674-2127

FAX : +61) 2-9674-2027

E-mail : [salesaust@royalsovereign.com](mailto:salesaust@royalsovereign.com)

# OWNER'S MANUAL

## RSC-1400L Laminators



Read all instructions carefully before use.

For any Customer Support needs please choose the **Customer Support tab** on [www.royalsovereign.com](http://www.royalsovereign.com)

Royal Sovereign International Inc.  
[www.royalsovereign.com](http://www.royalsovereign.com)

## TABLE OF CONTENTS

TOPIC	PAGE
1. Introduction.....	2
2. Safety Precautions .....	2
3. Installation .....	3
4. Included with Laminator .....	4
5. Product Identification.....	5
6. Control Panel.....	6
7. Roller Nip Settings.....	7
8. Using Foot Pedal and Remote Control.....	8
9. Using Cross Cutter .....	9
10. Loading Film.....	10
11. Threading Film	
11.1. Decaling .....	11
11.2. Mounting.....	13
12. Installation of the Front Feed and Rear Rewind Options .....	15
13. Maintenance.....	17
14. Troubleshooting .....	17
15. Specifications .....	18
16. Warranty.....	19

## 1. INTRODUCTION

Thank you for choosing a Royal Sovereign laminator. It has been designed and manufactured to provide years of continuous service. For complete operating and maintenance information please read this manual thoroughly. Upon receipt of your laminator, please inspect the box, the machine and all other contents for shipping damage. Damage should be brought to the immediate attention of the delivering carrier (See page 4 for list of shipment elements).

## 2. SAFETY PRECAUTIONS

Failure to comply with any of the following safety procedures could result in serious injury. Please read the instructions carefully and keep for future reference.

1. Only a licensed electrician should install wiring and outlet for the laminator.
2. Ensure the unit is plugged into a properly grounded outlet with the correct voltage.
3. Keep hands and clothing (i.e. Neckties) away from rollers. The rollers are pinch points that can trap body parts or clothing and cause serious injury.
4. Keep flammable and wet objects away from the machine.
5. Place machine on a level surface.
6. Avoid excessive sunlight, humidity and extreme temperatures.
7. Ensure the unit is turned off, cooled, and unplugged from the outlet prior to moving and/or repairing.
8. Keep out of reach of children.
9. Only Royal Sovereign authorized maintenance and service technicians should make repairs.
10. Do not attempt to laminate items that exceed total recommended material thickness for the unit
11. When cleaning the machine, don't use flammable sprays or materials.
12. Do not touch the rollers when they are hot or place foreign objects inside the machine.
13. Do not cover the surface of the machine until the machine has completely cooled.

### 3. INSTALLATION

**Note: The laminator should be installed by a trained service technician.**

The laminator comes fully assembled, except for the feed table, paper guide. Upon arrival, thoroughly inspect the unit. It is imperative that any shipping damage is reported and a claim is filed with the delivering carrier immediately upon receipt.

The laminator should be located in an area with adequate work space for feeding graphics and lamination materials.

Avoid placing the laminator in a dusty area or near sources of extreme heat or cold.

Once the laminator is in place, lock the casters into position("ON" position). Always unlock the casters ("OFF" position) when moving to a different location.

#### ELECTRICAL REQUIREMENTS

Royal Sovereign recommends that a licensed electrician ensures proper power installation to your laminator in accordance with electrical codes in your area.

The laminator should have a dedicated power line.

MODEL	RSC-1400L	
Power Supply	220-240V 50/60HZ	120V 50/60HZ
	single phase	



120V UL



230V UL



240V UK



220V EU



220V AU

### 4. INCLUDED WITH LAMINATOR

Thoroughly inspect the parts and the unit. It is imperative that any missing parts are reported and a claim is filed with the reseller immediately upon receipt of shipment.

Part Name	Quantity	Picture
Laminator	1	
Owner's Manual	1	
3" (76mm) / 2" (57mm) Auto Grip	6/4	
L-wrench (2.5)	1	
Dust Cover	1	
Spare Motor Fuse - FUSE(50T) (6.3A)	1	
Spare Main Power Fuse - FUSE(65TS) (5A)	1	
8 - 1/4"Hexa head Bolt (M6 * 20mm) 8 - Spring Washer( $\varnothing$ 6.1) (Included with option only)	10/10	
12 - 3/16"screw (M5 * 10mm). 12 - Spring Washer( $\varnothing$ 5.1) (Included with option only)	12/12	
Front Feeder and Rear Rewinder Kit (Included with option only)	2/2	
4 - 1/3"Hexa head Bolt (M8 * 70mm) 4 - Spring Washer( $\varnothing$ 8.5) (Included with option only)	4	
4 - 1/3"screw (M8 * 60mm). 4 - Spring Washer( $\varnothing$ 8.5) (Included with option only)	4	
NUT ( M8)	4	

## 5. PRODUCT IDENTIFICATION

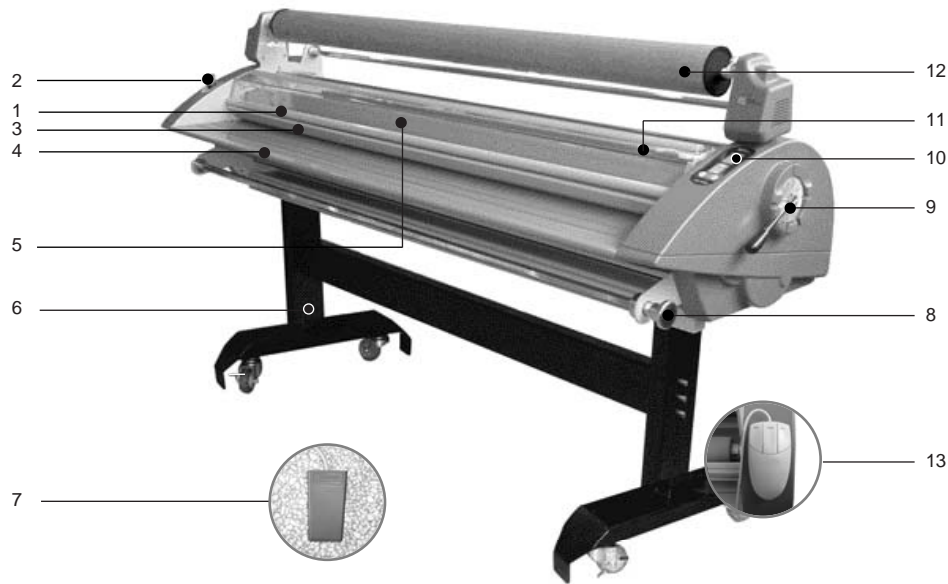

NO.	PART NAME	RSC-1400L
1	SAFETY COVER	○
2	EMERGENCY SWITCH	○
3	FRAME-PAPER GUIDE	○
4	TABLE-FRONT	○
5	MAIN ROLLER	○
6	ASSEMBLY STAND	○
7	FOOT PEDAL	○
8	TENSION CONTROL KNOBS	○
9	PRESSURE LEVER	○
10	CONTROL PANEL	○
11	UPPER IDLE BAR	○
12	RELEASE LINER TAKE UP	○
13	REMOTE CONTROL	○

## 6. CONTROL PANEL

When the machine is initially turned on, the LED display window will show the speed.

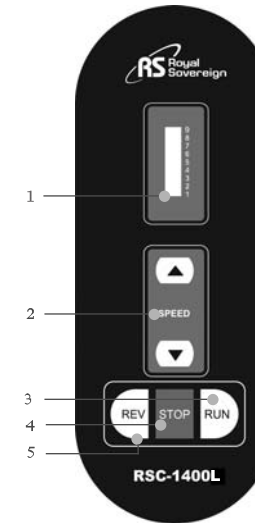

RSC-1400L

### Control Buttons

- SPEED DISPLAY:** Display's current Speed.
- SPEED BUTTON:** Adjusting the speed of the rollers. To change the speed of the rollers, press the up or down arrow button.
- RUN:** To start the rollers.
- STOP:** To stop the rollers.
- REV:** To reverse the rollers, press and hold the REVERSE button.



## 9. USING CROSS CUTTER

The cross cutter is located in the rear exit table of the machine.

1. After lamination, move the cutter approximately to the center of the completed application at the desired point of detachment (Figure 1).

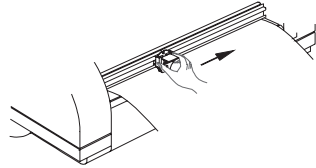

Figures 1

2. Grasp film with one hand, press the cutter downward into the application and slide it first to one end of the application, then to the other end to complete the cut (Figure 2 & 3).

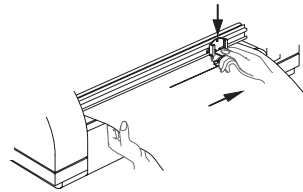

Figures 2

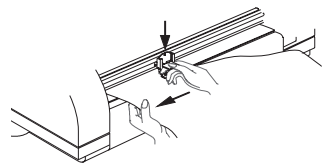

Figures 3

## 10. LOADING FILM

**Royal Sovereign films are wound with the adhesive side facing the inside of the roll (adhesive in).**

Loading films to upper and lower film shafts:  
(See page 5 for assistance with parts identification.)

1. Adjust the auto grip to fit to the film and tighten the auto grip screw (Figure 1).



Figure 1

2. Remove the upper and lower film shafts from the machine and load the films (Center the upper and lower films on the shaft). Note the direction of the adhesives on the lower and upper films (Figure 2).

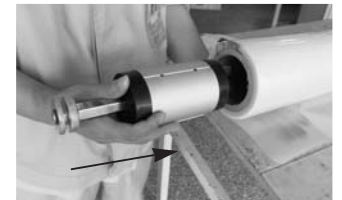

Figure 2

3. Load the upper and lower film shafts on the machine (Figure 3).



Figure 3

## 11. THREADING FILM

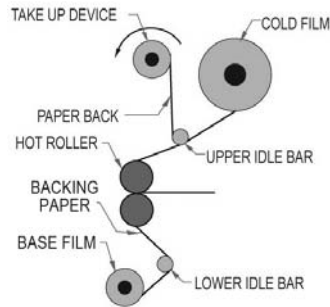

### 11.1. Decaling

1. Turn the power switch on ("I" position). The Power switch is located on the rear left side of the unit.
2. Complete the steps as in the "LOADING FILM" section (see page 10).
3. Take off the Frame-Paper Guide and the Feed Table.
4. Pull the top film down over the Safety Cover to the bottom of the craft paper / Mounting film.
5. Align and center the craft paper / Mounting film to the top film and tighten the two lower core screws (Figure 1).
6. Thread the top film underneath the Upper Idle Bar.(Figure 2)
7. Tape the top film on to the Release Liner Take-Up.(Figure 2)



Figure 1



Figure 2

8. Cut and separate the release liner and the film.(Figure 3)



Figure 3

9. Thread the craft paper behind the Lower Idle Bar to the top film that is resting on the main roller (do not use the Lower Idle Bar for Mounting). (Figure 4)



Figure 4

10. Reinstall the Feed Table and the Frame-Paper Guide, and close the Safety Cover.

11. Adjust the nip setting to appropriate gap.

12. Insert and push the leader board until they reach the front nip point.

13. Push the Run button.

14. Push the leader board into the rollers. (Figure 5)



Figure 5

15. Adjust the top and bottom tension knob by rotating it clockwise or counterclockwise. Turn it until the top and bottom roll films have some resistance varies (the tension depending on the film thickness; the thicker the film the more tension is required). (Figure 6)



Figure 6

16. Press the Stop button when the leader board has completely exited from the rollers.
17. Use the Cross Cutter to cut the leader board from the web (see page 9).
18. Set the nip setting to the appropriate position for the Over-lamination / Decaling application.

## 11.2. Mounting

1. Lay the decaled image face down on a flat surface. Carefully peel back and put a crease along the edge of the release liner ( Approximately 1 in or 25mm, Figure 1).



Figure 1

2. With the image facing up, align the image onto the board. Press firmly from the center out (Figure 2).



Figure 2

3. Adjust the pressure lever to ensure the proper opening (Figure 3).



Figure 3

4. Flip the image over the top roller and hold on to the release liner (Figure 4).



Figure 4

5. Press the foot pedal once, and then let it go while slowly pulling the release liner as the board enters the main roller nip (Figure 5)



Figure 5

6. Press the foot pedal once again when the board has completely exited from the rear of the unit. Trim the board if necessary.



## 12. INSTALLATION OF FRONT FEEDER and REAR REWINDER OPTIONS

Note: Below options are to be installed by an authorized RS reseller.

Installation of the Front Feeder Option (Includes 2 brackets, one spindle, and mounting hardware).

1. Install the Front Feeder to the inside of the front frames using four 1/4" (M6) hexagon bolts on each side (Figure 1)

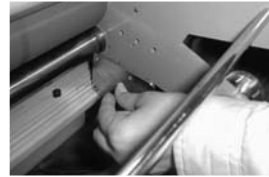

Figure 1

Installing the Rear Rewinder Option (Includes motorized winder, bracket, one spindle, and mounting hardware).

1. Remove the left and right covers by using a Phillips screwdriver (four screws on each side cover) (Figures 2 & 3).



Figure 2

Figure 3

2. Remove the lever knob screw and lever (Figure 4).



Figure 4

3. Remove the rear cover by removing all 10 screws (4 top, 4 bottom, and 1 on each side) (Figure 5 & 6).



Figure 5



Figure 6

4. Disassemble the power switch bracket and place the left rewriter outside of the frame; fasten with round head 3/16" (M5) screws (included in the option kit). Then, reinstall the power switch bracket (Figure 7).



Figure 7

5. Install the right rewriter on the outside of the frame and connect the motor wire connector to the rear wire (Figures 8 & 9).



Figure 8

6. Reinstall the rear cover.

7. Reinstall the side covers.



Figure 9

8. Reinstall the lever knob and screw.

### 13. MAINTENANCE

#### Cleaning the Body of the laminaor

- 1.To clean the machine body, dampen a cloth with water only and gently wipe the machine clean.

#### Removing Adhesive Build Up

1. Remove the film from the laminator.
2. Use a damp (water only) cloth and a rubber gum eraser to remove the adhesive on the Teflon (metal) and silicone rollers.

Note: Rub firmly but do not scrub the rollers vigorously as this may scratch the surface. Do not use sharp metal objects, steel wool, or abrasives, as these may also damage the rollers.

#### Lubrication

1. Drive chain and sprockets should be lubricated with either a light coat of gear lube or heavy grease (lithium grease) after 6 months or 1000 hours of operation, whichever comes first.

### 14. TROUBLESHOOTING

Symptom	Cause	Possible Solution
Machine will not turn on:	<ol style="list-style-type: none"> <li>a. Power plug is not plugged in.</li> <li>b. Power switch is in "0" (Off) position.</li> <li>c. Tripped circuit breaker.</li> <li>d. Blown main power fuse.</li> </ol>	<ol style="list-style-type: none"> <li>a. Plug the power cord into appropriate outlet.</li> <li>b. Put the power switch to the "I" (On) position.</li> <li>c. Reset the circuit breaker.</li> <li>d. Replace the fuse.</li> </ol>
There is power, but the rollers are not turning after the "RUN" button is pressed:	<ol style="list-style-type: none"> <li>a. Emergency switch (es) is (are) engaged.</li> <li>b. Paper guide is not installed correctly.</li> <li>c. Blown motor fuse.</li> </ol>	<ol style="list-style-type: none"> <li>a. Disengage the emergency switch (es).</li> <li>b. Properly install the paper guide so that the micro switch is activated.</li> <li>d. Replace the motor fuse.</li> </ol>
The unit is not heating up:	<ol style="list-style-type: none"> <li>a. Did not raise the temperature.</li> </ol>	<ol style="list-style-type: none"> <li>a. Raise the temperature.</li> </ol>
Curled lamination:	<ol style="list-style-type: none"> <li>a. Upward curl.</li> <li>b. Downward curl.</li> </ol>	<ol style="list-style-type: none"> <li>a. Loosen the top roll film tension.</li> <li>b. Loosen the bottom roll film tension.</li> </ol>

### 15. SPECIFICATIONS

Description	RSC-1400L
Power supply	AC 100, 200, 220~240V 50/60Hz 120V 60Hz
Power consumption	100W
Max laminating width	1400mm / 55"
Film thickness	60~500 mic / 1~15mil
Max laminating speed	5m/min / 16.4ft/min
Ready time	Not applicable
Heating method	None
Driving motor	DC geared
Max Temperature control	Not applicable
Speed control	9 settings
Transport type	2 Roller
Film core size	Auto grip (2",3")
Cross cutter	Yes
Hot lamination	No
Cold lamination	Yes
Mounting thickness	15mm / 0.6"
Take up system	Chain link to main motor
Reverse	Yes
Remote control	Yes
Foot pedal	Yes
Unit dimensions (w x d x h)	1710 × 650 × 1210 (mm) 67.5" × 21.5" × 47.5"
Unit weight	210kg / 462.9bs
Carton dimensions (w x d x h)	1960 × 900 × 850(mm) 77" × 35.5" × 33.5"
Gross Weight	292kg / 643.7bs

## Free Manuals Download Website

<http://myh66.com>

<http://usermanuals.us>

<http://www.somanuals.com>

<http://www.4manuals.cc>

<http://www.manual-lib.com>

<http://www.404manual.com>

<http://www.luxmanual.com>

<http://aubethermostatmanual.com>

Golf course search by state

<http://golfingnear.com>

Email search by domain

<http://emailbydomain.com>

Auto manuals search

<http://auto.somanuals.com>

TV manuals search

<http://tv.somanuals.com>