

MODEL:RSH-380SL

Roll Laminator Service Manual



Table of Content

1.Safety Precautions	3 ~ 3
2.Troubleshooting	4 ~ 10
2.1) Rollers Not Heating	4 ~ 6
2.2) Rollers Over Heating	6 ~ 7
2.3) Rollers Not Running	7 ~ 9
2.4) No Main Power	9 ~ 10
2.5) Poor Lamination Quality	11 ~ 11
3.Replacing Parts	12 ~ 14
3.1) Right Cover	12 ~ 12
3.2) Left Cover	13 ~ 13
3.3) Rear Cover	13 ~ 13
3.4) Main PCB	13 ~ 13
3.5) Sub PCB	13 ~ 13
3.6) Heaters	13 ~ 14
3.7) Cross Cutter	14 ~ 14
4.Adjustments	15 ~ 16
5. Parts List	17 ~ 19
6.Exploded Drawings	20 ~ 25
7.Wire Diagram	26 ~ 29
8.Backup	30 ~ 33

1. Safety Precautions

Failure to comply any of the following safety procedures could result in serious injury. Please read the instructions carefully and keep for future reference.

1. Only a licensed electrician should install wiring and outlet for the laminator.
2. Ensure the unit is plugged into a properly grounded outlet with the correct voltage.
3. Keep hands and clothing(ie.Neckties)away from rollers. The rollers are pinch points that can trap body parts or clothing and cause serious injury .
4. Keep flammable and wet objects away from the machine .
5. Place machine on a level surface.
6. Avoid excessive sunlight, humidity and extreme temperatures.
7. Ensure the unit is turned off, cooled ,and unplugged from the outlet prior to moving and/or repairing.
8. Keep out of reach of children.
9. Only Royal Sovereign authorized maintenance and service technicians should make repairs.
10. Do not attempt to laminate items that exceed total recommended material thickness for the unit.
11. When cleaning the machine, don't use flammable sprays or materials.
12. Do not touch the rollers when they are hot or place foreign objects inside the machine.
13. Do not cover the surface of the machine until the machine has completely cooled.

2. Troubleshooting

Note: While repairing:

- a. **Make sure the power plug is unplugged from the power outlet.**
- b. **Open both side covers and rear cover.**
- c. **Be sure to follow the steps below in order.**

2.1 Rollers Not Heating

CAUSES:

1. Improper laminating mode.
2. Heating wire is not connected to the main PCB.
3. Blown (burnt) upper and/or lower wire fuse (T/Fuse).
4. Defective Bi-Metal.
5. Defective heater.
6. Defective Main PCB.

MEASURE

1. Heating wire is not connected to the main PCB.

- a. Connect the upper and lower heating wires to the main PCB.

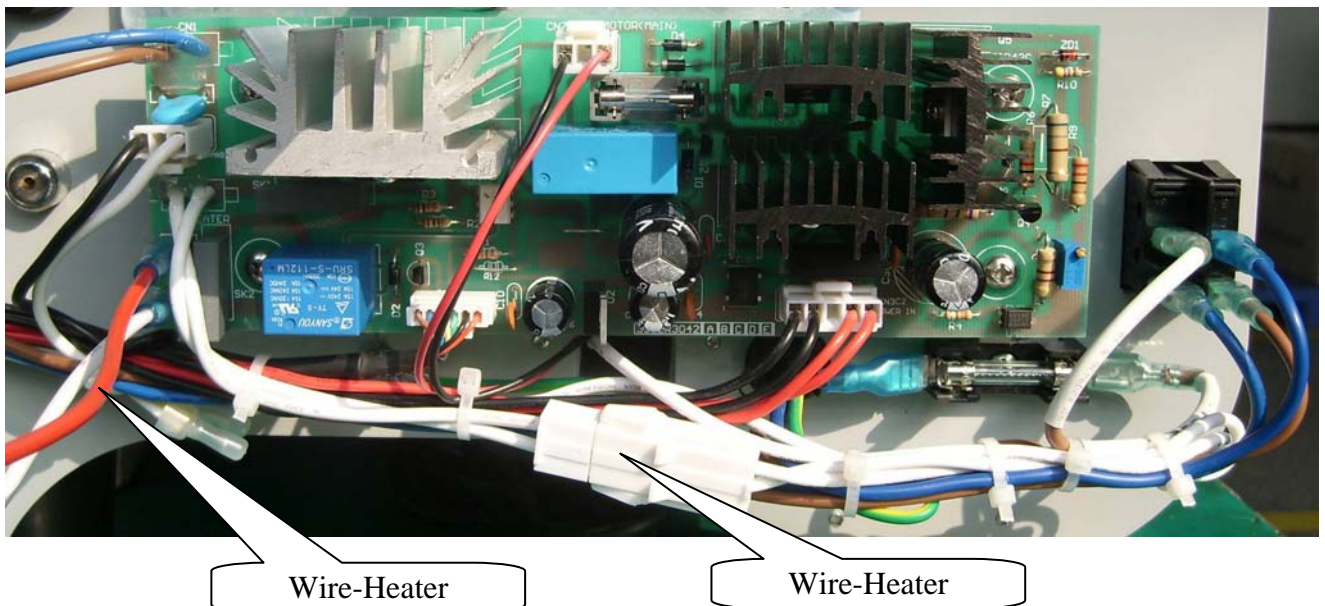

2. Blown (burnt) wire fuse (T/Fuse).

a. Replace the T/Fuse wire located on the left-hand side.

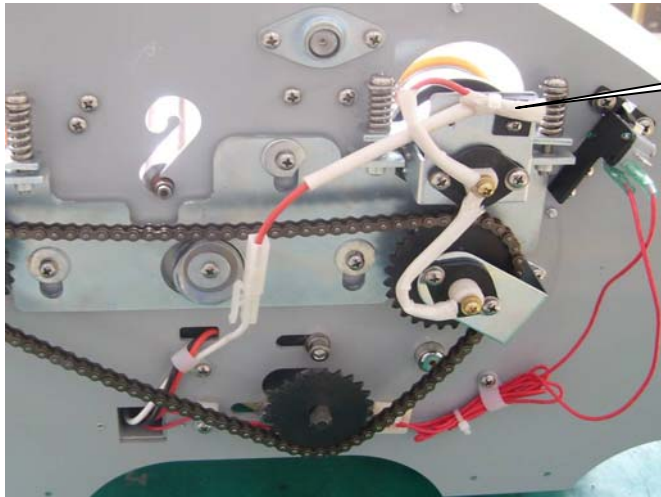

3. Defective Bi-Metal.

a. Replace the Bi-Metal

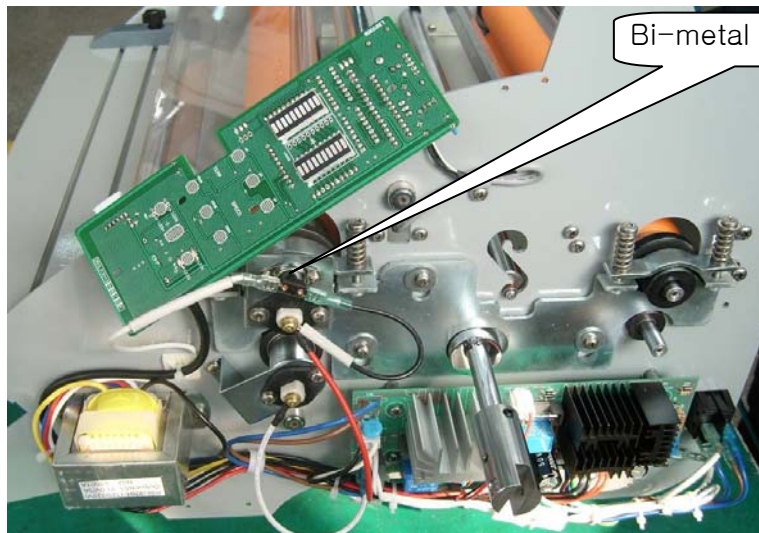

4. Defective heater.

a. Using the multi-meter, test the continuity of the heater. If it fails, replace the heater.

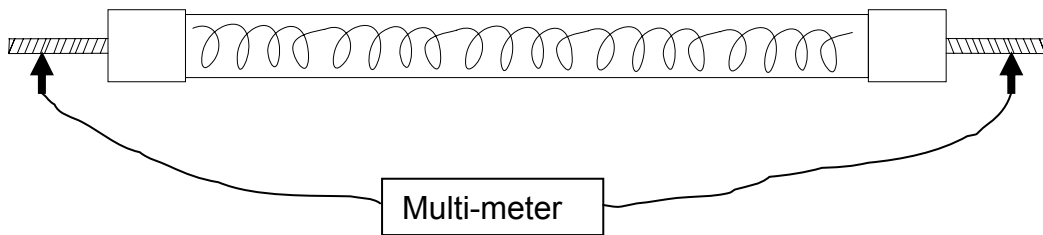

b. Physically examine the heater assembly for breakage.

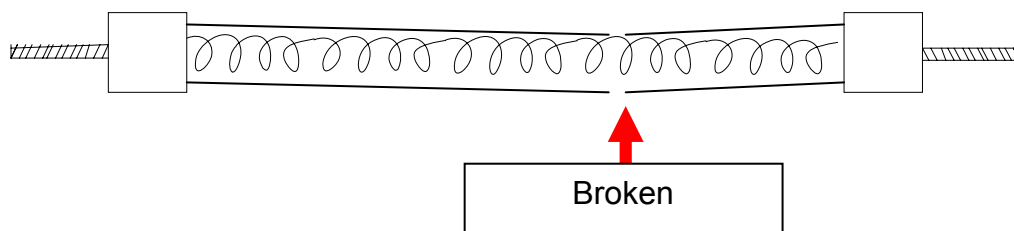

5. Defective Main PCB.

- a. Replace the PCB Main.

2.2 Rollers Over Heating

CAUSES

1. Heat sensor is reversed on the PCB Main.
2. Defective T/Fuse wire.
3. Defective heater.
4. Defective main PCB.

MEASURES

1. Wires for lower and upper heat sensors are reversed on the main PCB.

- a. Reverse the heat sensors.

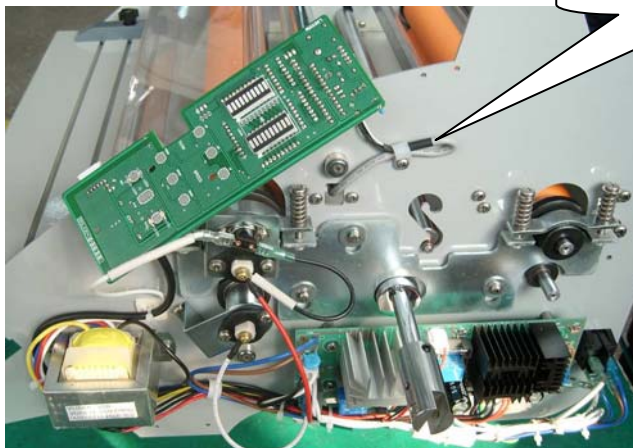

2. Defective T/Fuse wire.

- a. Replace the T/Fuse wire located on the left-hand side.

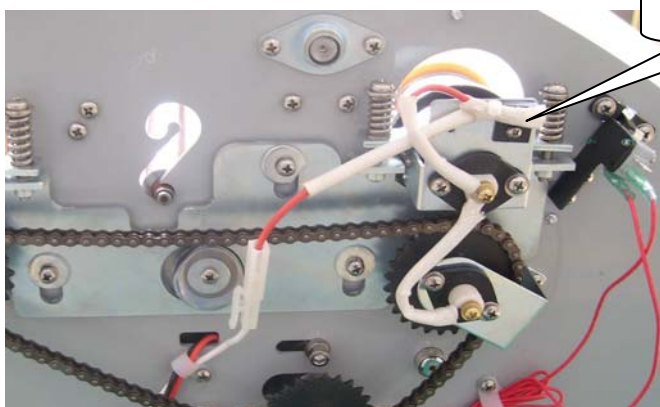

3. Defective heater.

- a. Test continuity of the heater. If it fails, replace the heater.
- b. Glass tube that surrounds heating coil is broken – replace the heating element.

4. Defective Main PCB.

- a. Replace the PCB Main.

2.3 Rollers Not Running

CAUSES

1. No power to the unit.
2. The main switch is close.
3. Opened safety cover.
4. Film is jammed on the rollers.
5. Disconnected motor wire.
6. Defective main motor.
7. Defective main PCB.

MEASURES

1. No power to the unit.

- a. Make sure the power plug is connected to the proper source of outlet

2. The main switch is close.

Main Switch



3. Opened safety cover.

- a. Close the safety cover and double check to insure that the safety cover switch is engaged.

Note: By closing the safety cover, it engages the safety cover switch.

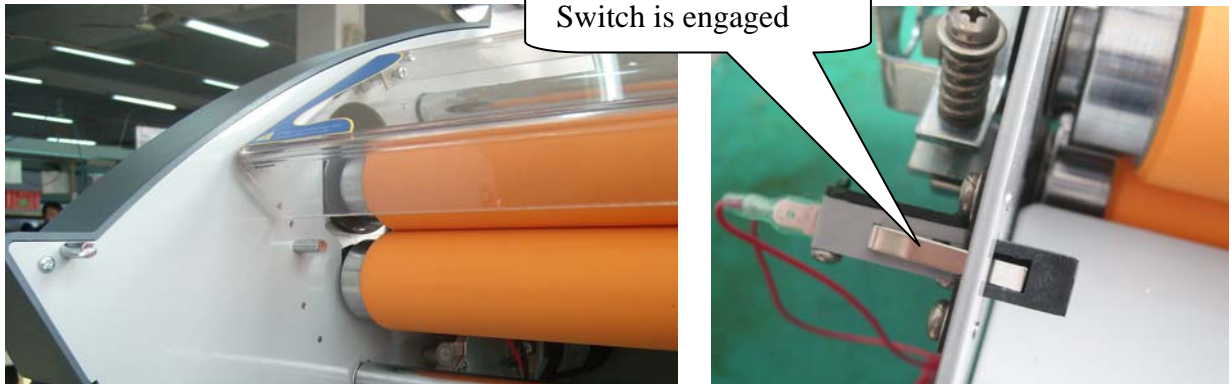

4. Film is jammed on the rollers.

- a. Un-jam the film using a combination of the pressure lever and reverse button.

5. Disconnected motor wire.

- a. Check the motor wire connection with PCB.

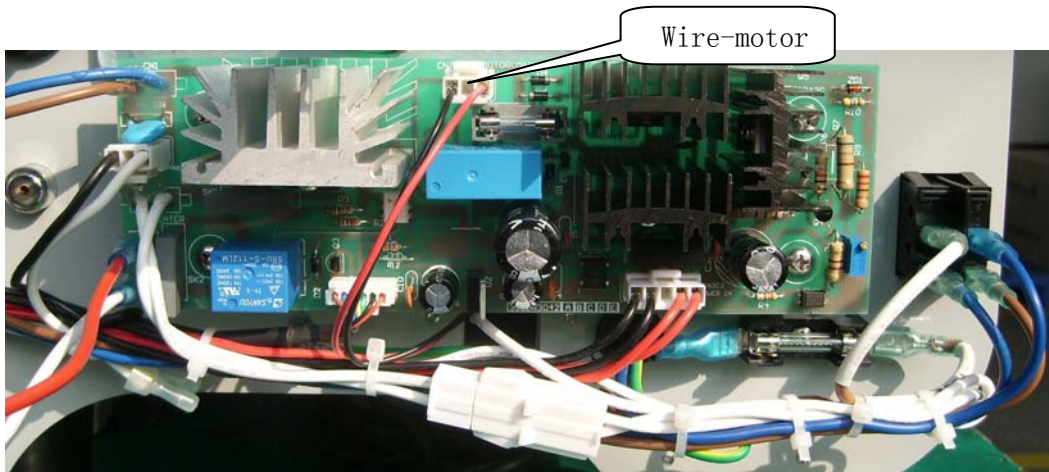

6. Defective main motor.

- a. Replace the main motor.

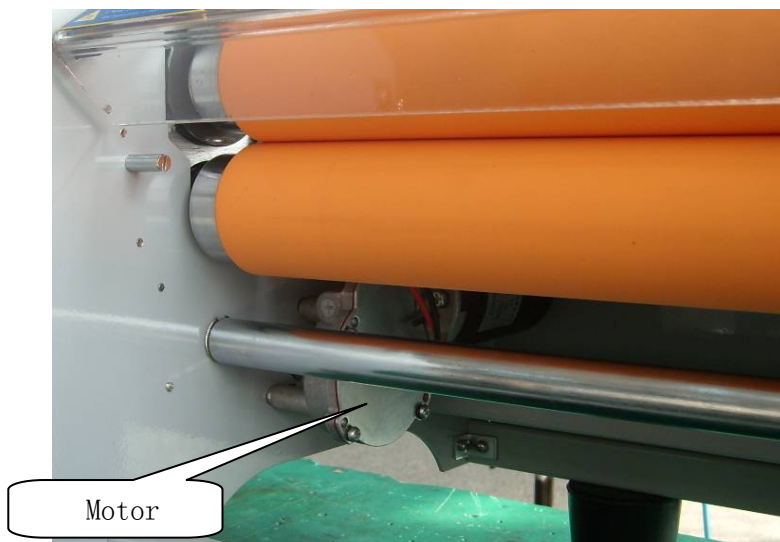

7. Defective main PCB.

- a. Replace the main PCB.

2.4 No Main Power

CAUSES

1. No electricity.
2. Blown main fuse.
3. Disconnected main power wires.
4. Defective transformer.

MEASURES

1. No Electricity.

- a. Double check to insure that you have electricity from your outlet.
- b. Check the circuit breaker.
- c. Double check that source of power is 220V, 15Amp, and single phase.

2. Blown main fuse.

- a. Replace the main fuse located above the main power switch.

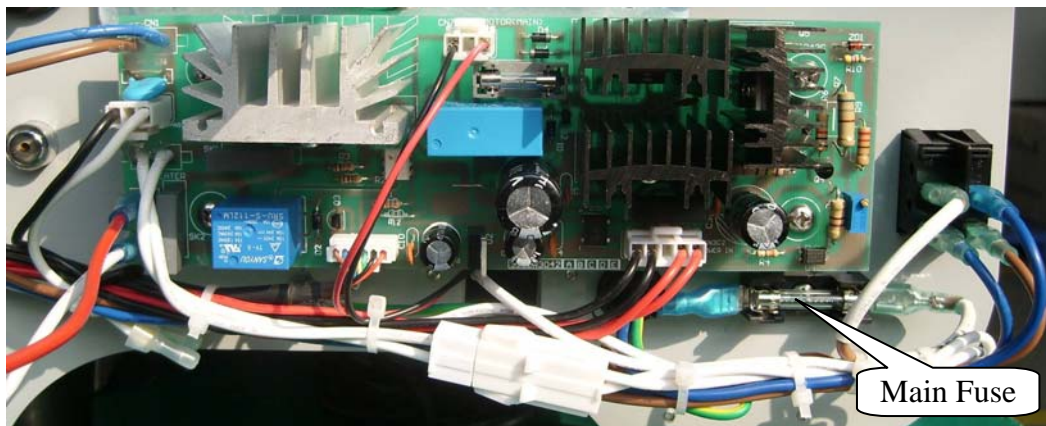

3. Disconnected main power wires.

- a. Check that the main power wires are properly connected.

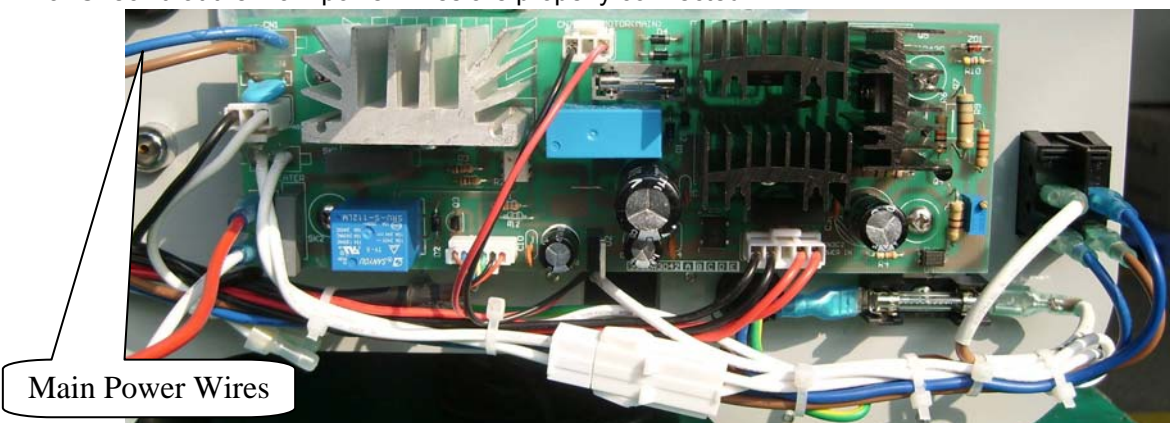

4. Transformer is defective

- a. Replace the transformer.

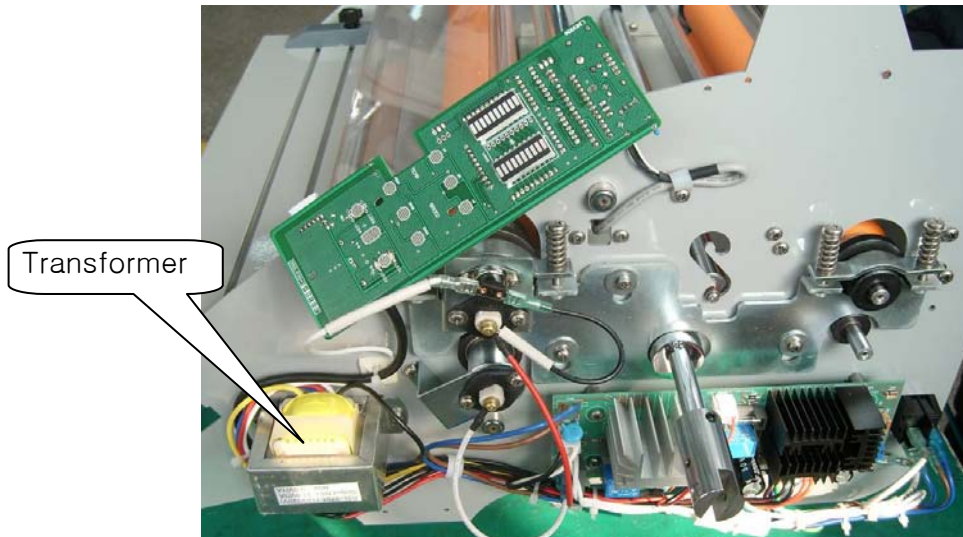

2.5 Poor Lamination Quality

<p>Problem: Straight wave lines across the output.</p> <p>Cause: Excessive front roller pressure.</p> <p>Measure: Loosen the front roller pressure.</p>	
<p>Problem: Concave waves in the lamination.</p> <p>Cause: Excessive rear (pulling) roller pressure.</p> <p>Measure: Loosen the rear back roller pressure.</p>	
<p>Problem: Angled waves on both sides of the output.</p> <p>Cause: Insufficient rear roller pressure.</p> <p>Measure: Tighten the rear roller pressure.</p>	
<p>Problem: Angled waves on one side of the output.</p> <p>Cause: Insufficient rear left (or right) side roller pressure.</p> <p>Measure: Tighten the rear left (or right) side roller pressure.</p>	
<p>Problem: Straight waves in the output.</p> <p>Cause: Excessive heat at the nip rollers.</p> <p>Measure: Lower the roller temperature.</p>	
<p>Problem: Wake waves.</p> <p>Cause: Insufficient heat at the nip rollers.</p> <p>Measure: Raise the roller temperature.</p>	
<p>Problem: Curling.</p> <p>Cause: 1.The film tension is very tight; 2.The decurling bar is not in the working location.</p> <p>Measure: 1.Loose the tension;2.Adjust the decurling bar to working location.</p>	

3. Replacing Parts

Note: While replacing parts:

a. Make sure the power plug is unplugged from the power outlet.

b. Open both side covers and rear cover.

3.1 Replacing the Right Cover.

a. Take out the pressure lever (Figure 1) and four cover screws using Phillips screw driver (Figure 2).

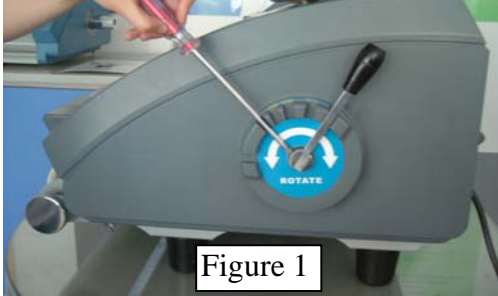

b. Pull out the male control panel connector from the Sub-PCB (Figure 3).

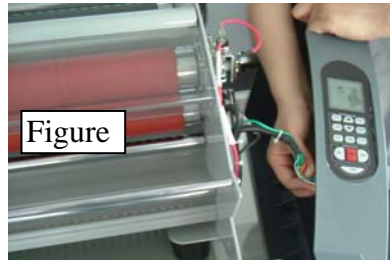

3.2 Replacing the Sub-PCB

a. Refer to "Replacing Right Cover".

c. Loosen two screws from Sub-PCB, installed on to new Right Cover (Figure 4).

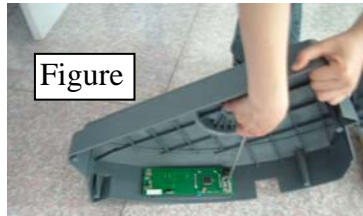

d. Follow the reverse order to assemble the Right Cover back.

3.3 Replacing the Main PCB

a. Remove the rear cover and label all the wires before unplugging from the Main PCB.

b. Detach the Main PCB from 6 white plastic holders (Figure 7).

c. Replace the board with new PCB and connect all the wires.

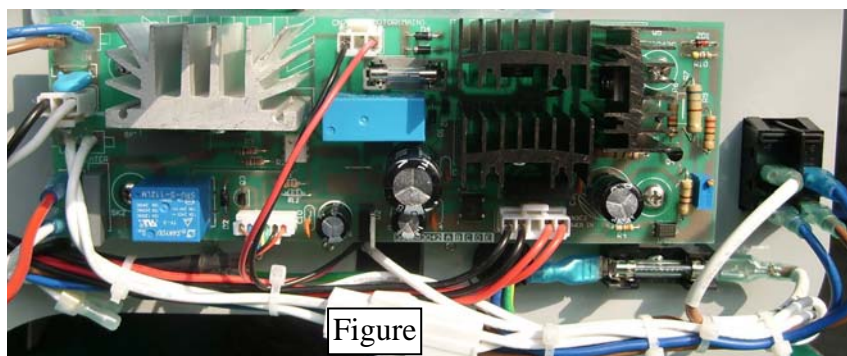

3.4 Replacing the Heaters

Note: Cotton or surgical gloves are recommended while handling the heater assembly.

- a. Disassemble Right and Left Covers (Refer to “Replacing Right Cover” and “Replacing Left Cover”).
- b. Take out the heater brackets on each side by loosening screws (Figure 8, 9).

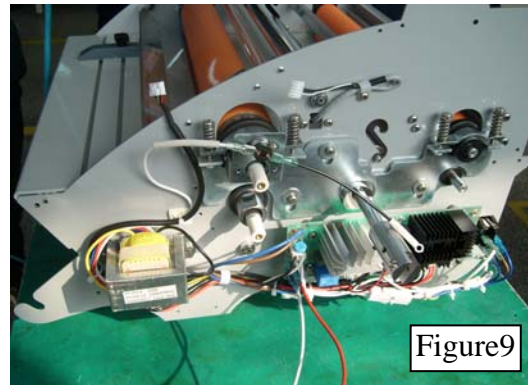
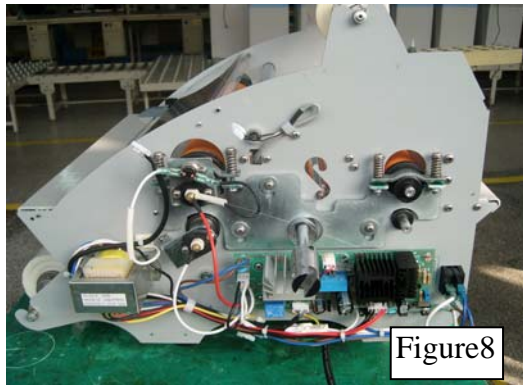

- c. Take out the broken heater. Figure 10

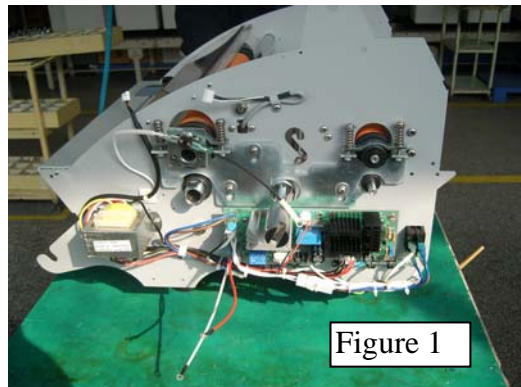

Note:

- a. When inserting the heater into the roller, rotate the heater slightly and push the rod in gently.
- b. Use an air blower to blow out the broken pieces of heating rod.

(Please ensure that no one is standing on the other side.)

3.5 Replacing the Cross Cutter

- a. Disassemble the nut from the Frame-Cutter.
- b. Unfasten the spring from the cutter.
- c. Change the Cutter.
- d. Assemble the Cutter by reversing the above steps.

4. Adjustments

.2 Adjusting front and rear rollers

Pressure

• Use Screwdriver

to adjust the roller pressure:

C.W – Increase pressure.

C.C.W – Decrease pressure.

1. Using **Push-Pull Scale**, measure

3 spots as shown on Figure B & C:

Front roller should be 5~6 and back

rollers should be 6~8.

2. **Checking for over all tension** –

when the machine is running, check that the top and the bottom films are fed in without any wrinkles.

3. **Pressure mark checking (Heat Line)** –

stop the machine for 30 seconds to create a heat line. Then check to see if you have two even parallel lines from one end to other. Note: A narrow parallel lines indicate that it has less pressure at that point.

4. **Laminating Test** – Laminate samples

with different thickness of substrates.

5. **Check above steps 2 through 4** with

3mil & 5mil films.

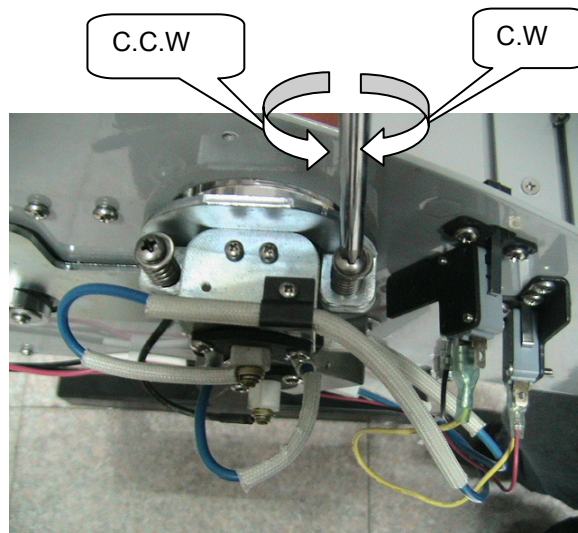

Figure A



Figure B



Figure C

5.PART LIST

No.	Part No.	Part Name	Spec.	Remark
1	021LR0001A	COVER-L	ABS PA-765 UL94 V-0 PANTON 431	
2	125LR4001A	HANDLE-TENSION	S45C Cu+Ni+Cr	
3	138LR4012A	SPRING-TENSION	SWP Φ 3.2	
4	12200X022A	BEARING-RADIAL	15*28	
5	141LR4033A	PLATE-PRESSURE,PULL	SPCC 3.0T	
6	138LR4015A	SPRING-PRESSURE	SWP Φ 2	
7	141LR4032A	PLATE-PRESSDURE,LAMI	SPCC 3.0T	
8	141LR4035A	PLATE-DU BUSH	SECC T=2.0	
9	141LR4019A	BRACKET-HEATER,UP	SPCC 1.6T	
10	36400X014B	MICRO SWITCH	AC 250V/5A 50-60HZ	
11	141LR4054A	BRACKET-LIMIT SWITCH	SPCC 2.0T	
12	147LR4013A	STOPPER-HEATER,UP	SILICONE	
13	141LR4020A	BRACKET-HEATER,LOW	SPCC 1.6T	
14	141LR3039A	PLATE-PRESSURE,L	SPCC 3.0T	
15	021LR4001A	LAMIT-SWITCH COVER	PP	
16	122LR4044A	BUSH-ROLLER LAMI,UP	FTG70 CU 3-35	
17	122LR4046A	BUSH-ROLLER PULL,UP	FTG70 CU 3-35	
18	111LR4024A	BOLT-GUIDE	S45C	
19	124LR4005A	CAM	S45C	
20	122LR4050A	BUSH-ROLLER LAMI, LO	FTG70 CU 3-35	
21	122LR4047A	BUSH-ROLLER PULL,LO	FTG70Cu3-35	
22	136LR4001X	CHAIN	RS#25 P6.35 98节	
23	013LR3142A	FRAME-L	SPCC 3.0T	
24	147LR4002A	PAD-TENSION	LEATER 1.5T	
25	140LR4036A	HOLDER-SHAFT,FILM	S45C Cu+Ni+Cr	
26	120LR4002M	SHAFT-FILM	S45C N19	
27	ASMLR1339A	ASSY-AUTO GRIP CORE 2"	RSH-380SL	
27-1	ASMLR1339B	ASM-AUTO GRIP CORE3"	RSH-380SL	
27-2	124LR4006A	CORE-24	AL 6063	
28	RIV05018E8	BRINDER RIVET	AL ϕ 5*18	
29	12200X029A	DU-BUSH	FLANGE Φ 10*10	
30	026LR4006A	FOOT	NBR 160g	
31	141LR4064A	BRACKET-TABLE	SPCC 2.2T	
32	013LR3146A	FRAME-STAND	25*25*2.0 SQUARE TUBE	
33	023LR4002A	KNOB-BOLT GUIDE	PHENOL BLK	
34	145LR3002A	GUIDE-DOCUMENT	ABS PA-765 UL94V-0 431C	

35	141LR4043A	FRONT TABLE SAFETY LEVER	SPCC 1.5T	
36	013LR4004A	SAFETY FRAME	SPCC	
37	021LR3024A	SAFETY-COVER	PC 3.0T	
38	014LR3001B	TABLE-FRONT	AL6063	
39	133LR3001A	ROLLER-LAMI	STPG ORG	
40	223LR3001H	HEATER ASS'Y	FCHW1 81Ω EU,KR,CH,EU(N),BR	
40-1	223LR3001J	HEATER ASS'Y	FCHW1 96Ω AU,UK	
40-2	223LR3001E	HEATER ASS'Y	FCHW1 24Ω CUL	
40-3	223LR3001D	HEATER ASS'Y	FCHW1 20.2Ω TW	
40-4	223LR3001F	HEATER ASS'Y	FCHW1 16.7Ω JOL,JAP	
41	140LR4003A	HOLDER-SAFETY COVER	S45C	
42	111LR4018A	SCREW-H	SWRH MFZN—Y	
43	131LR4027A	SPROCKET-MOTOR	S45 24Z	
44	210004002A	MOTOR-MAIN	DC 24V	
45	131LR4017A	SPROCKET-LAMI	FTG70Cu3-35 28z	
46	120LR3031B	SHAFT-CAM	S45C Cu+Ni+Cr	
47	013LR3143A	PLATE-MIDDLE	SPCC 0.5T	
48	015LR2010A	BAR-IDLE	S45C Φ20	
49	015LR3011C	IDLE-BAR	S45C Cu+Ni+Cr	
50	015LR3012C	SHAFT-DECURLING	S45C Cr	
51	131LR4018A	SPROCKET PULL	FTG70Cu3-35 20z	
52	133LR3002A	ROLLER-PULL	S45C GRY	
53	013LR3144A	REAR-COVER	SPCC 0.5T	
54	013LR3145A	TABLE-CUTTER	SPCC 2.0T	
55	013LR3002H	FRAME-CUTTER	AL6063	
56	021CR3001A	KNOB-CUTTER,C	ABS PA-765 UL94 V-0 PANTON 431C	
57	140LR3001A	HOLDER-CUTTER,C	ABS PA-765 UL94 V-0 PANTON 431C	
58	213LR4001A	CUTTER-CROSS	STS420 J2 1T	
59	34000S011A	POWER TRANSFORMER	AC110-120V,220-240V/50-60HZ	
60	141LR3038A	PLATE-PRESSURE,R	SPCC 3.0T	
61	144LR4001B	CLAMPER-LEVER	S45C Cu+Ni+Cr	
62	023LR4010A	KNOB LEVER	NYLON BLK	
63	125LR4003B	LEVER-PRESSURE	S45C Cu+Ni+Cr	
64	120LR4009B	SHAFT-COVER SAFETY	S45C	
65	350LR3042A	PCB MAIN ASM	ROHS	
66	032LR3029A	SHEET-FUNCTION	PC 0.75T	
66-1	032LR3029C	SHEET-FUNCTION	PC 0.75T	
67	023LR3007B	BUTTON-FUNC	SILICON	

68	350LR3043A	PCB-SUB ASSY	FR-4	
69	36600X001A	FUSE-BLOCK	FB66 LITTLE FUSE TRIAD INC	
70	32500X0008	FUSE-MAIN	65TS AC250V 10A EU,AU,KR,CH,UK,EU(N),BR	
70-1	32500X0005	FUSE-MAIN	65TS AC250V 20A TW,CUL,JOL,JAP	
71	021LR3018A	COVER-R	ABS PA-765 UL94 V-0 PANTON 431	
72	138LR4001A	SPRING-CUTTER CROSS	SWRH Φ 0.3	
73	KPS03012D2	KEY PLAIN	3*3*12 SUS27	
74	138LR4018A	SPRING-LEVER	SUS 304-WPB	
75	12200X027A	DU-BUSH	FLANGE Φ 25*10	
76	12200X028A	DU-BUSH	FLANGE Φ 25*20	
77	111LR4006A	BOLT-GUIDE	S45C SNC3 4*22.5	
78	12200X030A	DU-BUSH	FLANGE Φ 10*20	
79	013LR3141A	FRAME-R	SPCC 3.0T	
80	36400X002B	SWITCH-MAIN	8216 B/R I/O SIGNAL-LUX SPA	
81	013LR2012G	FRAME-SENSOR	AL6063	
82	033LP4016A	MICA-WASHER	Φ 4* Φ 11 T=0.5	
83	12200X032A	DU-BUSH	FLANGE Φ 12*10	
84	12200X040A	DU-BUSH	ϕ 6*8 FLANGE	
85	363LR4013A	BIMETAL THERMOSTAL	135°C 15A	
86	141LP4018A	BRACKET-FUSE	EGI T=1	
87	147CR4003A	SILICON RUBBER	SILICON Φ 7*160	
88	23300X001A	BUSHING-CORD,EU	7NR32 DONG-A	
89	111LR4004A	BOLT-CORE	S45C Φ 15*42	
90	ASMLR2023A	ASM SENSOR	RSH-380SL	
91	381LR4020B	WIRE-FUSE,EU	UL1015 AWG#14	
92	381LR4052A	WIRE-MOTOR	UL1007 AWG#20 BLK RED	
93	381LR4115A	WIRE-MAIN	UL2464 AWG#24,BLE	
94	381LR4062B	WIRE-HEATER	UL1015 AWG#16 WHITE	
95	381LR4063A	WIRE-TEMP FUSE	SF133E,AC250V 15A 133°C UL1015 AWG#14	
96	381LR4049A	WIRE-BIMETAL	UL1015 AWG#18, WHT	
97	381LR4114A	WIRE-HEATER LOW	UL1015 AWG#16, WHT	
98	381LR4051A	WIRE-HEATER LINK	UL1015 AWG#18, WHT	
99	380LR4001A	POWER CORD	EU AC250V 15A 1.8M	
99-1	380LR4003A	POWER CORD	AU AC250V 15A 1.8M	
99-2	380CR4007A	POWER CORD	UK AC250V 10A 1.8M	
99-3	380LR4001B	POWER CORD	KR AC250V 15A 1.8M	
99-4	380CR4003A	POWER CORD	JAP AC125V 15A 1.8M	
99-5	380CR4004A	POWER CORD	CUL AC125V 15A 1.8M	

6.EXPLODE VIEW

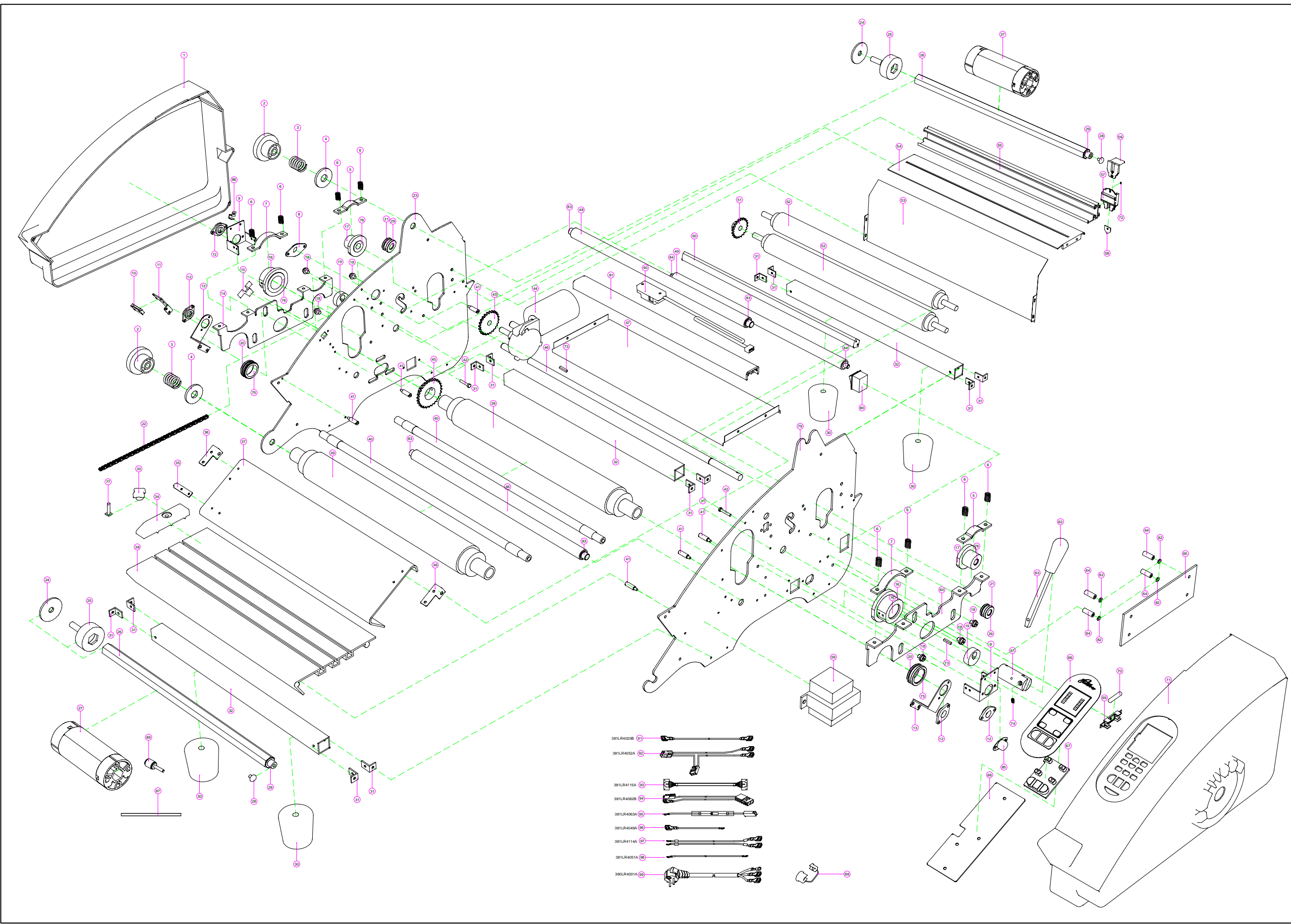

No.	Part No.	Part Name
1	021LR0001A	COVER-L
2	125LR4001A	HANDLE-TENSION
3	138LR4012A	SPRING-TENSION
4	1220X022A	BEARING-RADIAL
5	141LR4033A	PLATE-PRESSURE_PULL
6	138LR4015A	SPRING-PRESSURE
7	141LR4032A	PLATE-PRESSURE_LAMI
8	141LR4035A	PLATE-DU_BUSH
9	141LR4019A	BRACKET-HEATER_UP
10	3640X014B	MICRO SWITCH
11	141LR4054A	BRACKET-LIMIT_SWITCH
12	147LR4013A	STOPPER-HEATER_UP
13	141LR4020A	BRACKET-HEATER_LOW
14	141LR3039A	PLATE-PRESSURE_L
15	021LR4001A	LIMIT-SWITCH COVER
16	122LR4044A	BUSH-ROLLER_LAMI_UP
17	122LR4046A	BUSH-ROLLER_PULL_UP
18	111LR4024A	BOLT-GUIDE
19	124LR4005A	CAM
20	122LR4050A	BUSH-ROLLER_LAMI_LO
21	122LR4047A	BUSH-ROLLER_PULL_LO
22	136LR4001X	CHAIN
23	013LR3142A	FRAME-L
24	147LR4002A	PAD-TENSION
25	140LR4036A	HOLDER-SHAFT_FILM
26	120LR4002M	SHAFT-FILM
27	ASMLR1339A	ASSY-AUTO GRIP_CORE 2"
27-1	ASMLR1339B	ASM-AUTO GRIP_CORE3"
27-2	124LR4006A	CORE-24
28	R1V05018E8	BRINDER RIVET
29	1220X029A	DU-BUSH
30	028LR4006A	FOOT
31	141LR4064A	BRACKET-TABLE
32	013LR3146A	FRAME-STAND
33	023LR4002A	KNOB-BOLT_GUIDE
34	145LR3002A	GUIDE-DOCUMENT
35	141LR4043A	FRONT TABLE SAFETY LEVER
36	013LR4004A	SAFETY FRAME
37	021LR3024A	SAFETY-COVER
38	014LR3001B	TABLE-FRONT
39	133LR3001A	ROLLER-LAMI
40	223LR3001H	HEATER ASS'Y
40-1	223LR3001J	HEATER ASS'Y
40-2	223LR3001E	HEATER ASS'Y
40-3	223LR3001D	HEATER ASS'Y
40-4	223LR3001F	HEATER ASS'Y
41	140LR4003A	HOLDER-SAFETY COVER
42	111LR4018A	SCREW-H
43	131LR4027A	SPROCKET-MOTOR
44	210004002A	MOTOR-MAIN
45	131LR4017A	SPROCKET-LAMI
46	120LR3031B	SHAFT-CAM
47	013LR3143A	PLATE-MIDDLE
48	015LR2010A	BAR-IDLE
49	015LR3011C	IDLE-BAR
50	015LR3012C	SHAFT-DECURLING
51	131LR4018A	SPROCKET_PULL
52	133LR3002A	ROLLER-PULL
53	013LR3144A	REAR-COVER
54	013LR3145A	TABLE-CUTTER
55	013LR3002H	FRAME-CUTTER
56	021CR3001A	KNOB-CUTTER_C
57	140LR3001A	HOLDER-CUTTER_C
58	213LR4001A	CUTTER-CROSS
59	3400S011A	POWER TRANSFORMER
60	141LR3038A	PLATE-PRESSURE_R
61	144LR4001B	CLAMPER-LEVER
62	023LR4010A	KNOB LEVER
63	125LR4003B	LEVER-PRESSURE
64	120LR4009B	SHAFT-COVER SAFETY
65	350LR3042A	PCB_MAIN ASM
66	032LR3029A	SHEET-FUNCTION
66-1	032LR3029C	SHEET-FUNCTION
67	023LR3007B	BUTTON-FUNC
68	350LR3043A	PCB-SUB ASSY
69	3660X001A	FUSE-BLOCK
70	3250X0008	FUSE-MAIN
70-1	3250X0005	FUSE-MAIN
71	021LR3018A	COVER-R
72	138LR4001A	SPRING-CUTTER CROSS
73	KPS03012D2	KEY PLAIN
74	138LR4018A	SPRING-LEVER
75	1220X027A	DU-BUSH
76	1220X028A	DU-BUSH
77	111LR4006A	BOLT-GUIDE
78	1220X030A	DU-BUSH
79	013LR3141A	FRAME-R
80	3640X002B	SWITCH-MAIN
81	013LR2012G	FRAME-SENSOR
82	033LR4016A	MICA-WASHER
83	1220X032A	DU-BUSH
84	1220X040A	DU-BUSH
85	363LR4013A	BIMETAL THERMOSTAL
86	141LR4018A	BRACKET-FUSE
87	147CR4003A	SILICON RUBBER
88	2330X001A	BUSHING-CORD_EU
89	111LR4004A	BOLT-CORE
90	ASMLR2023A	ASM SENSOR
91	381LR4020B	WIRE-FUSE_EU
92	381LR4052A	WIRE-MOTOR
93	381LR4115A	WIRE-MAIN
94	381LR4062B	WIRE-HEATER
95	381LR4063A	WIRE-TEMP FUSE
96	381LR4049A	WIRE-BIMETAL
97	381LR4114A	WIRE-HEATER_LOW
98	381LR4051A	WIRE-HEATER LINK
99	380LR4001A	POWER CORD
99-1	380LR4003A	POWER CORD
99-2	380CR4007A	POWER CORD
99-3	380LR4001B	POWER CORD
99-4	380CR4003A	POWER CORD
99-5	380CR4004A	POWER CORD

7. Wire Diagram

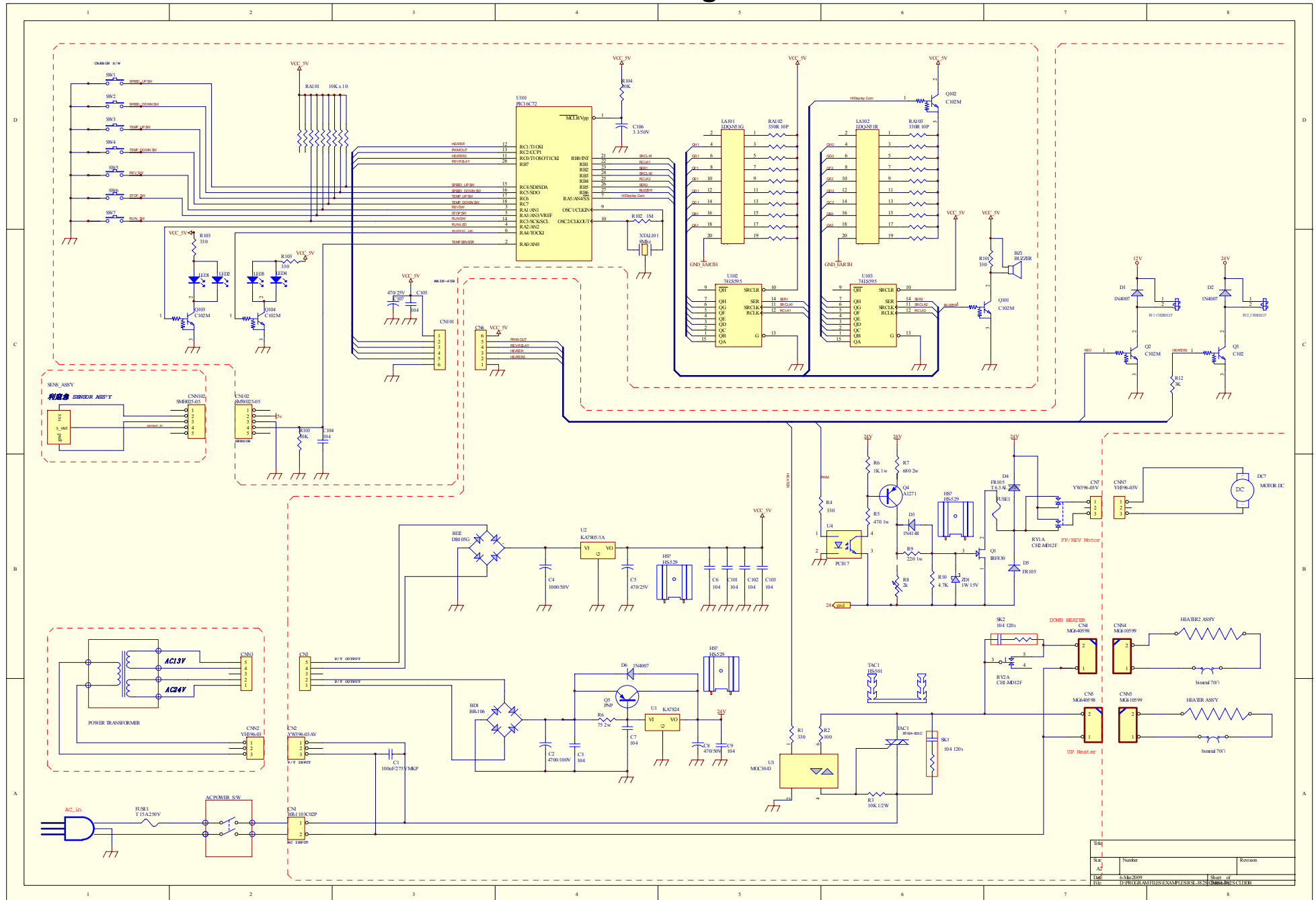

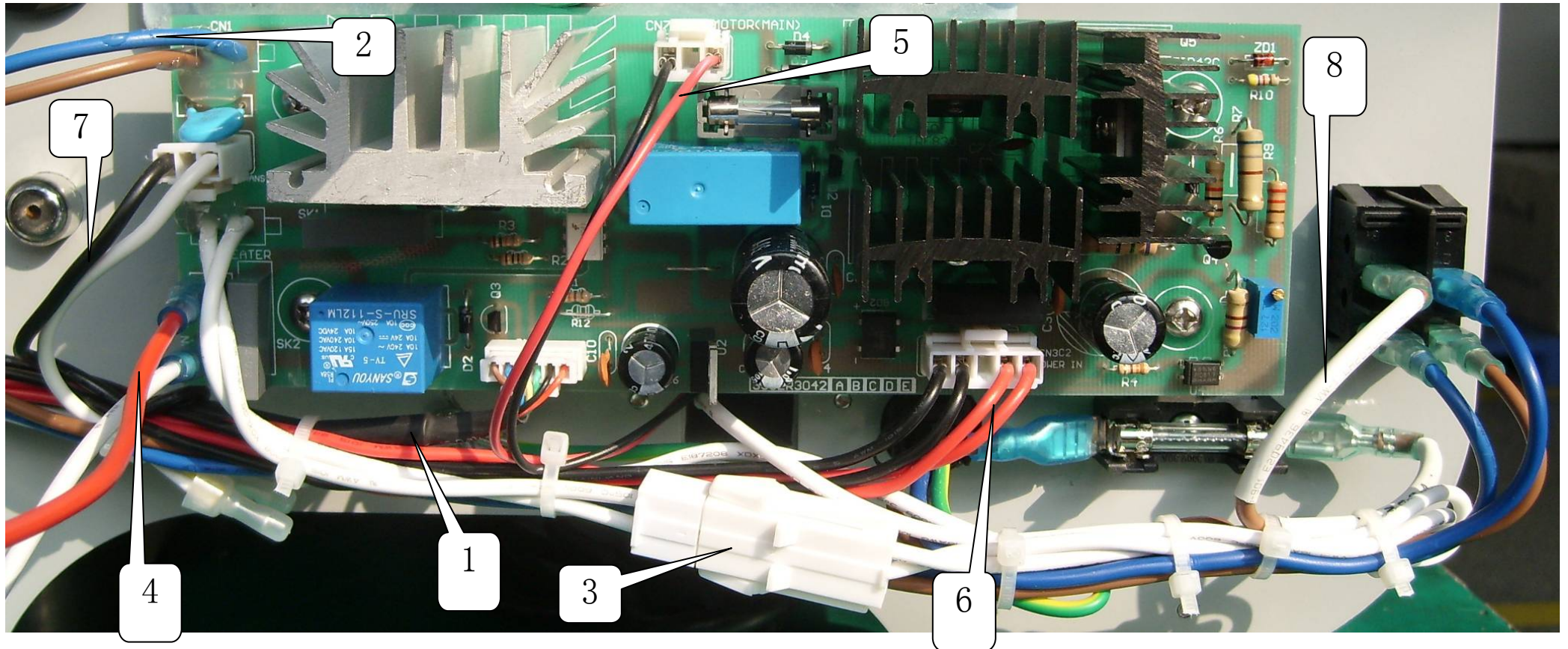

<Connect part>

- | | |
|---------------------|-----------------------------------|
| 1. Wire Main. | 6. Wire Power Transformer In |
| 2. Wire Power | 7. Wires Power Transformer Output |
| 3. Wire Heater, up | 8. Wire Fuse |
| 4. Wire Heater, low | |
| 5. Motor wires | |

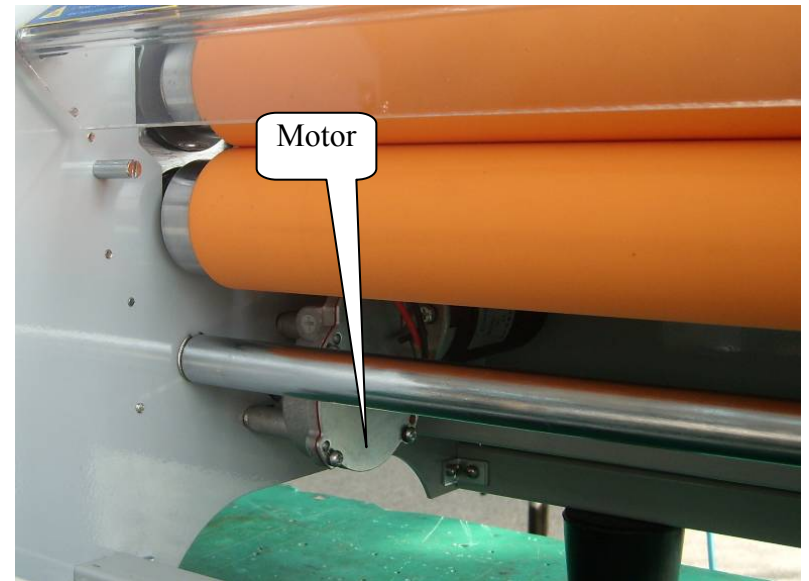
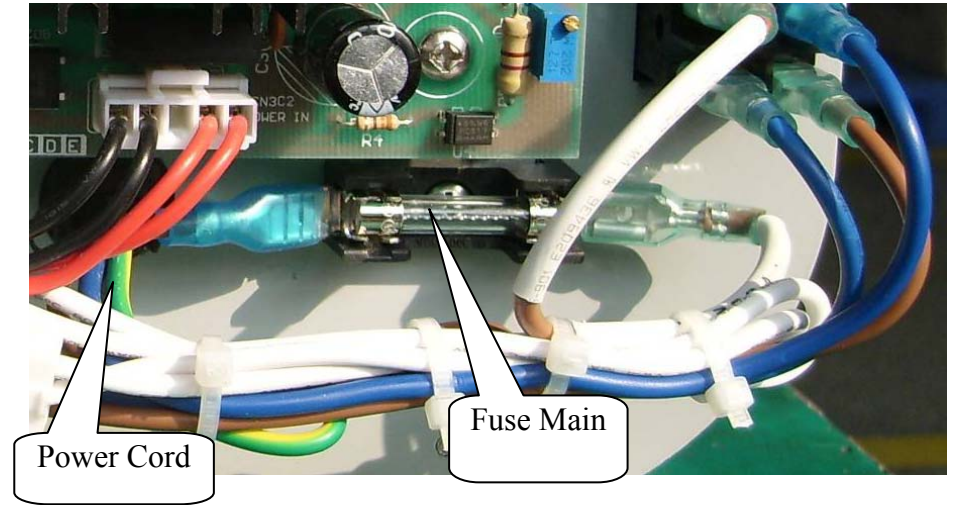
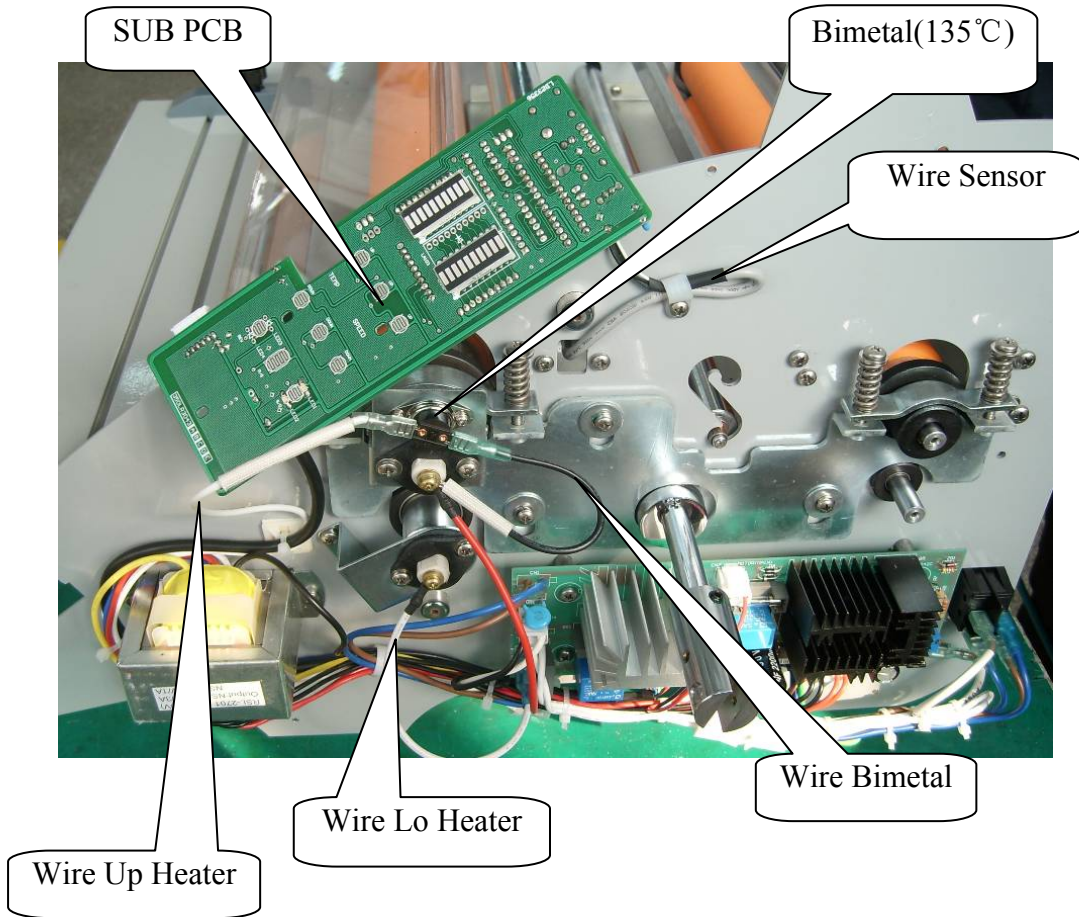

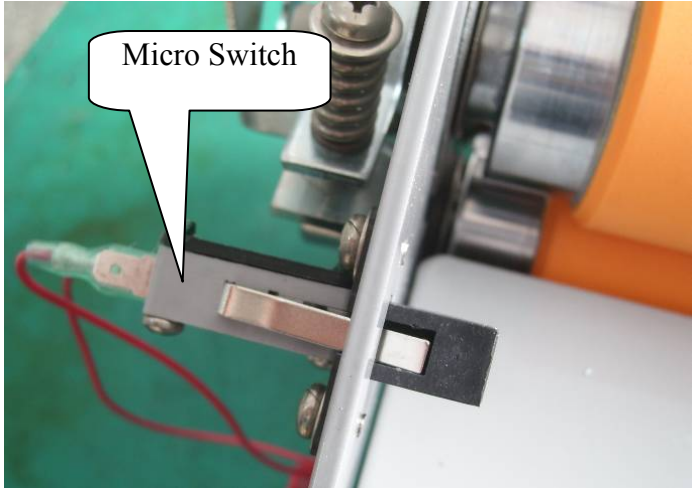
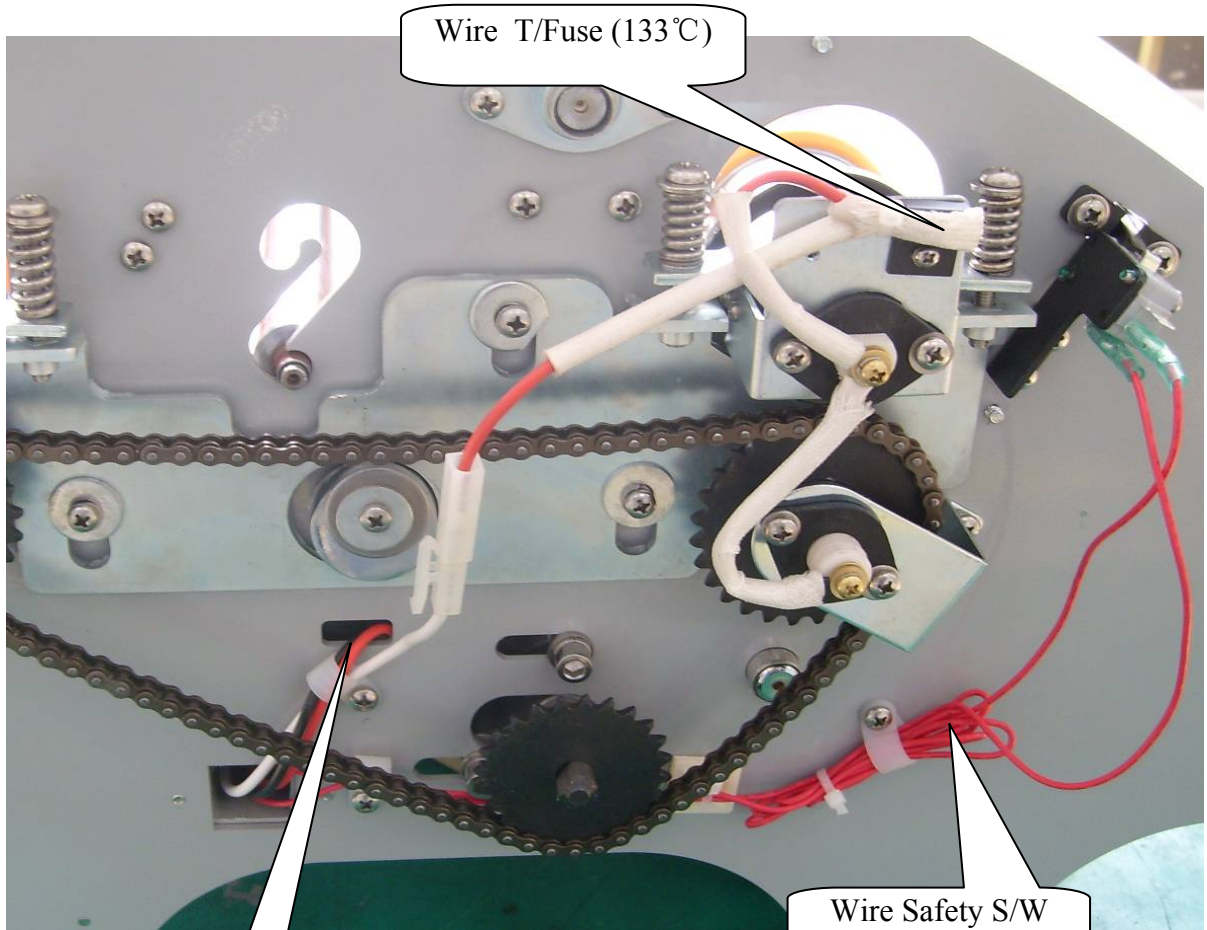

Wire Motor

Wire Safety S/W

Micro Switch

Wire T/Fuse (133°C)

Free Manuals Download Website

<http://myh66.com>

<http://usermanuals.us>

<http://www.somanuals.com>

<http://www.4manuals.cc>

<http://www.manual-lib.com>

<http://www.404manual.com>

<http://www.luxmanual.com>

<http://aubethermostatmanual.com>

Golf course search by state

<http://golfingnear.com>

Email search by domain

<http://emailbydomain.com>

Auto manuals search

<http://auto.somanuals.com>

TV manuals search

<http://tv.somanuals.com>