

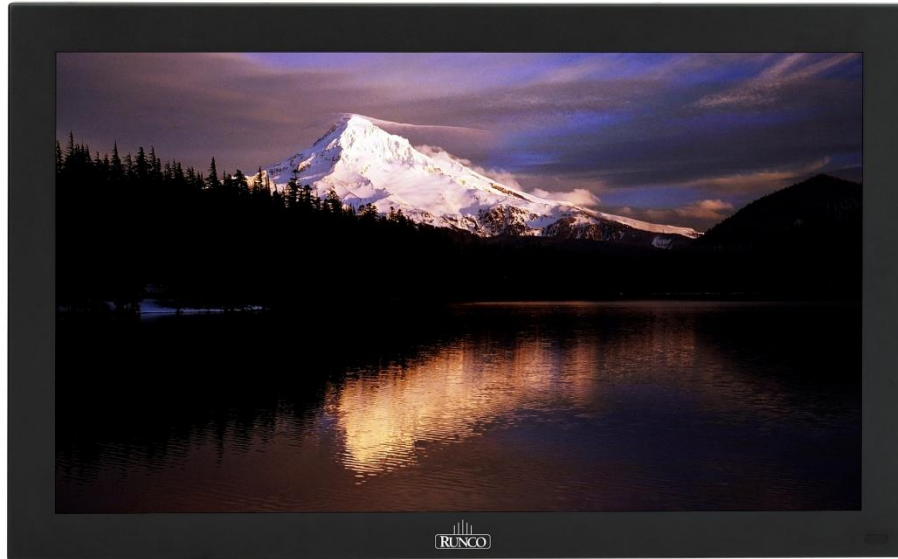

INSTALLATION/OPERATION MANUAL



CP-42HD

CP-52HD

Climate Series High Definition LCD Monitor



THE WORLD'S FINEST HOME THEATER PRODUCTS™

RuncoCare™ One Year Limited Warranty

For North America

Congratulations on your purchase of a Runco® product! With proper installation, setup and care, you should enjoy many years of unparalleled video performance.

This RuncoCare One Year Limited Warranty is provided free of charge by Runco International, LLC ("Runco") with the purchase of a covered Runco product.

The following terms and conditions of the RuncoCare One Year Limited Warranty represent a contract between us, Runco, and you, the customer, who has purchased a Runco product. This contract applies to purchases of covered Runco products occurring on or after the effective date printed at the bottom of this document. Runco reserves the right to change the terms of this contract, and such changes shall apply to purchases of covered Runco products that occur on or after any future effective date.

RuncoCare 1 Year Limited Warranty Features

- 1-Year protection from defects in material and workmanship
- Access to 24x7 phone support
- Complimentary, 2nd day one-way shipping

Warranty Coverage

Runco warrants its products to be free from defects in material and workmanship during the warranty period provided below. If, in Runco's sole determination, a product proves to be defective in material or workmanship during the warranty period, Runco will repair the product, replace the product with a substantially similar new or like new product, or refund a prorata share of the purchase price (calculated based on the remainder of the warranty period and the then-current MSRP² of a similar product), if repair or replacement of the product is determined by Runco to not be feasible. Runco has sole discretion in determining whether a same or like model is offered, and what constitutes as 'substantially similar model'.

Length of Warranty

Runco products are warranted for one (1)-year from the date of shipment from Runco. Lamps are warranted six (6) months from the date of shipment or 1000 hours of use, whichever comes first. All other accessories, which include but are not limited to, cables, remotes, carrying cases, lens cap and other peripherals sold with the Runco product, are warranted for ninety (90) days from the date of the original shipment of the accessory.

Eligibility

This RuncoCare One Year Limited Warranty is valid only for the first customer who purchases the covered product from an authorized Runco dealer or distributor. This warranty is not transferable. You may be required to provide proof of purchase in order to receive warranty services.

-
1. Runco may update this list of products excluded from this warranty from time to time at Runco's sole discretion, but updates to the list of covered products will not apply on a retroactive basis.
 2. MSRP is defined as the most recent product price listed on Runco's price list.

RuncoCare Claim Procedure

In the event of a product defect, please follow the warranty claim procedure provided below:

1. The customer is required to contact a Runco dealer or Runco Technical Support via email at support@runco.com or via phone at (toll free) 800-23-RUNCO (800-237-8626). If the customer is located outside North America, call +3589 4200 554 in Europe for product service.
2. Be prepared to provide the date of purchase, the place of purchase, serial number, product model number, description of the problem and troubleshooting steps already attempted.
3. Runco Technical Support staff will attempt to correct any minor issues that may be causing the problem. If Runco is unable to resolve the problem through troubleshooting, a Return Material Authorization (RMA) number will be issued for the exchange of the defective product if it is determined that the claim was made within the coverage period of the Standard Limited Warranty.
4. If it is determined that the Standard Limited Warranty applies to the claim, the customer will need to return the defective product to the Runco repair depot location specified by the Runco technical support representative. The customer will need to properly package the defective product, consisting of the product only, and not include any accessories (e.g., cables, remotes, carrying cases, lens, lens cap and other peripherals) and return it to the Runco repair depot specified by the technical support representative. It is the customer's responsibility to properly package the hardware, include all appropriate materials, and return it to the location specified by the Runco technical support department. The customer will need to address and resolve any shipping damage claims directly with the shipping company.
5. The customer is responsible for providing a suitable box to ship the defective product to an authorized Runco repair depot. Boxes may be purchased from a Runco technical support representative.
6. The customer is responsible for paying freight charges to ship the defective product to an authorized Runco repair depot.
7. For in-warranty repairs, Runco will pay freight charges to return the repaired/replacement product (which shall not include accessories--e.g., cables, remotes, carrying cases, lens cap and other peripherals sold with the Runco product) to the customer from the Runco repair depot.
8. Once an RMA has been created, the customer may contact serviceorders@runco.com for follow-up questions or confirmation status of the claim process.

Warranty Exclusions

This RuncoCare Standard Limited Warranty does not include or is limited by the following:

1. Products not purchased from an authorized Runco dealer
2. Rental costs incurred by the customer in the event of product defect or failure
3. Any product with a defaced, modified, or removed serial number
4. Damage, deterioration, or malfunction resulting from:
 - a. Accident, abuse, misuse, neglect, improper ventilation, fire, water, disaster, lightning, or other acts of nature, smoke exposure (cigarette or otherwise), unauthorized product modification (including use of an unauthorized mount), or failure to follow instructions supplied with the product
 - b. Repair or attempted repair by anyone not authorized by Runco
 - c. Any damage to the product due to shipment
 - d. Removal or installation of the product
 - e. Causes external to the product, such as electric power fluctuations or failure
 - f. Use of supplies or parts (including lamps) that are not purchased from Runco or do not meet Runco's specifications
 - g. Normal wear and tear
 - h. Expected lamp degradation and normal decrease in lamp output over a period of time or as the lamp is consumed
 - i. Customer caused defects, including but not limited to, scratched/defaced/altered plastics
 - j. Failure to follow maintenance procedures as outlined in the product's user guide where a schedule is specified for regular cleaning of the product
 - k. Opening the product and/or tampering with internal circuitry
 - l. Products lost, stolen or discarded

- m. Any damage or dissatisfaction associated with latent images, "burn-in," or any other damage determined by Runco to be the result of customer use patterns
 - n. Any other cause, which does not relate to a product defect in material or workmanship
5. Removal, installation, and set-up service charges are excluded from this Standard Limited warranty
 6. Black uniformity issues or other LCD issues associated with usage outside the Runco recommended guidelines and specifications for the product
 7. Bright or dark sub pixels that are characteristic of LCD technology and considered by Runco to be acceptable and within Runco's manufacturing specifications. (See Sub Pixel Policy below)
 8. Second day shipment delivery time and availability may vary based on origin and destination and Runco is unable to deliver to PO Box and FPO Box addresses

Sub Pixel Policy

It is not uncommon for one or more sub pixels to become bright or dark during or after the manufacturing process. A bright sub pixel is one that remains in the on position, and a dark sub pixel is one that appears black or off. The sub pixels are usually hard to see and will not detract from the display quality or usability at normal viewing distance. The following are Runco's criteria for identifying bright or dark sub pixels that would be considered unacceptable: a) the number of bright or dark sub pixels; b) the location of the bright or dark sub pixels; c) the color of the bright sub pixels; and d) the Runco model size. If sub pixels have been identified as unacceptable by Runco the LCD will be deemed faulty and will be replaced if reported within the warranty period. If there are issues with bright or dark sub pixels, gather the information listed above and call or email support@Runco.com.

Other Terms and Conditions

1. Runco will not accept returned Product unless an RMA number has been issued by Runco.
2. If an Advance Exchange return occurs, it is the customer's responsibility to properly package the defective product and ship it to the address provided by the Runco technical support representative with the RMA number prominently displayed. If the defective product is not properly packaged and is damaged in transit during its return to Runco, you may be invoiced for either the repair costs, if repairable, or the MSRP of a replacement product and shipping costs incurred by Runco.
3. The repaired or replaced product will assume the remainder of your original product's RuncoCare Service Plan term or 90 days from the date the repaired unit is shipped, whichever is longer.
4. If a replacement product is sent, the customer agrees to retain the replacement for the product you purchased and your defective product becomes the property of Runco.

Extended Service Options

Runco offers extended and expanded service plans. For information on additional product protection, please email serviceorders@runco.com or call (toll free) 800-23-RUNCO (800-237-8626).

Online Product Registration

Please visit <http://www.runco.com/support/product-registration/> to register product.

Limitation of Implied Warranties

RUNCO PROVIDES NO WARRANTIES, EXPRESS OR IMPLIED, EXCEPT THOSE EXPRESSLY PROVIDED HEREIN. RUNCO EXPRESSLY DISCLAIMS ALL OTHER WARRANTIES, INCLUDING THE IMPLIED WARRANTIES OF MERCHANTABILITY AND FITNESS FOR A PARTICULAR PURPOSE.

Exclusion of Damages

RUNCO'S MAXIMUM AGGREGATE LIABILITY HEREUNDER IS LIMITED TO THE COST OF REPAIR OR REPLACEMENT OF THE PRODUCT.

1. RUNCO SHALL NOT BE LIABLE FOR DAMAGE TO OTHER PROPERTY CAUSED BY ANY DEFECT IN THE PRODUCT, DAMAGES BASED UPON INCONVENIENCE, LOSS OF USE OF THE PRODUCT, LOSS OF TIME, LOSS OF PROFITS, LOSS OF BUSINESS OPPORTUNITY, LOSS OF GOODWILL, INTERFERENCE WITH BUSINESS RELATIONSHIPS, OR OTHER COMMERCIAL LOSS, EVEN IF THE CUSTOMER HAS BEEN ADVISED OF THE POSSIBILITY OF SUCH DAMAGES.
2. RUNCO SHALL NOT BE LIABLE FOR ANY CONSEQUENTIAL, INCIDENTAL, INDIRECT, SPECIAL, OR PUNITIVE DAMAGES ANY OTHER DAMAGES, WHETHER INCIDENTAL, INDIRECT, CONSEQUENTIAL OR OTHERWISE.
3. RUNCO SHALL NOT BE LIABLE FOR ANY CLAIM AGAINST THE CUSTOMER BY ANY OTHER PARTY.

Effect of Local Law

This warranty gives you specific legal rights, and you may have other rights, which vary from locality to locality. Some localities do not allow limitations on implied warranties and/or do not allow the exclusion of incidental or consequential damages, so the above limitations and exclusions may not apply to you.

COPYRIGHT AND TRADEMARKS

© Copyright 2009 Runco International, LLC ("Runco"). This document contains proprietary information protected by copyright, trademark and other intellectual property laws. All rights are reserved. No part of this manual may be reproduced by any mechanical, electronic or other means, in any form, without prior written permission of Runco.

The trademarks reproduced in this Runco Owner's Manual and used on the Runco Products are either owned by Runco or are licensed by Runco. You may not reproduce or use the trademarks without the prior written consent of Runco.

Runco Products are manufactured under one or more of the following patents: US. Patent 6755540 and Other Patents Pending.

Important Safety Instructions

Thank you for your purchase of this quality Runco video product! For the best performance, please read this manual carefully as it is your guide through the menus and operation.



WARNING

This symbol is intended to alert the user to the presence of uninsulated "dangerous voltage" within the product's enclosure that may be of sufficient magnitude to constitute a risk of electric shock.



This symbol is intended to alert the user to the presence of important operating and maintenance (servicing) instructions in the literature accompanying the appliance.

1. Read these instructions.
2. Keep these instructions.
3. Heed all warnings.
4. Follow all instructions.
5. Do not block any of the ventilation openings. Install in accordance with the manufacturer's instructions.
6. Do not place your LCD monitor on an unstable stand, shelf or table. Serious bodily injury and/or damage to the LCD monitor may result if it should fall. Your sales person can recommend an approved wall mounting kit. A special wall mounting kit is available for this model. To prevent injury, the LCD monitor must be securely attached to the wall in accordance with the installation instructions provided with the mounting kit. Always mount using recommended and substantial fixture and fittings.
7. Do not install near any heat sources such as radiators, heat registers, stoves, or other apparatus (including amplifiers) that produce heat. Do not mount near an open flame source. Open flames must never be used near this LCD monitor.
8. This monitor surpasses IP56 weatherproof standards. It is **not** protected against temporary or continuous immersion in liquid. Do not submerge this monitor in liquid.
9. Do not defeat the safety purpose of the polarized or grounding type plug. A polarized plug has two blades with one wider than the other. A grounding type plug has two blades and a third grounding prong. The wide blade or the third prong is provided for your safety. When the provided plug does not fit into your outlet, consult an electrician for the replacement of the obsolete outlet.
10. Protect the power cord from being walked on or pinched particularly at plugs, convenience receptacles and the point where they exit from the apparatus. Do not allow anything to rest on the power cord and do not locate this LCD monitor where the cord will be damaged by people walking on it.
11. Only use the attachments/accessories specified by the manufacturer.
12. Use only with a cart, stand, tripod, bracket or table specified by the manufacturer or sold with the apparatus. When a cart is used, use caution when moving the cart/apparatus to avoid injury from tip-over.
13. This LCD monitor should be operated only from the type of power source indicated on the monitor or as indicated in the Operating Instructions. If you are not sure of the type of power supply, consult your sales person or your local power company.
14. Unplug this apparatus during lightning storms or when unused for long periods of time.
15. Do not use immediately after moving the LCD monitor from a low temperature to a high temperature environment, as this causes condensation, which may result in fire, electric shock, or other hazards.
16. Before cleaning, be sure to unplug the power cord from the power outlet.
17. Do not apply liquid cleaners or aerosol cleaners directly onto the LCD monitor. Use a damp cloth for cleaning.



18. This LCD monitor should have a minimum distance of 5cm away from the wall and the monitor should have 10cm distance around the top and sides.

19. Refer all servicing to qualified service personnel. Servicing is required when the apparatus has been damaged in an way, such as power supply cord or plug is damaged, objects have fallen into the apparatus, the apparatus does not operate normally, or has been dropped.

20. Keep the packing material in case the equipment should ever need to be shipped.

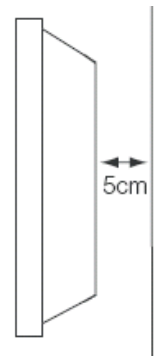
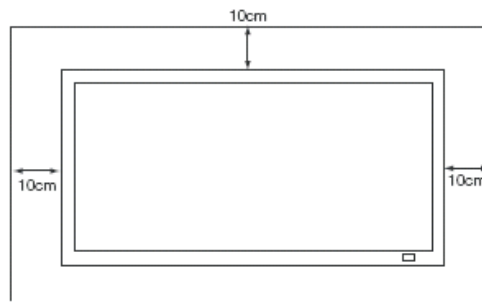

Compliance Information

FCC PART 15:

NOTE: This equipment has been tested and found to comply with the limits for a Class B digital device, pursuant to Part 15 of the FCC Rules. These limits are designed to provide reasonable protection against harmful interference in a residential installation.

This equipment generates, uses and can radiate radio frequency energy and, if not installed and used in accordance with the instructions, may cause harmful interference to radio communications. However, there is no guarantee that interference will not occur in a particular installation. If this equipment does cause harmful interference to radio or television reception, which can be determined by turning the equipment off and on, the user is encouraged to try to correct the interference by one or more of the following measures:

- Reorient or relocate the receiving antenna.
- Increase the separation between the equipment and receiver.
- Connect the equipment into an outlet on a circuit different from that to which the receiver is connected.
- Consult the dealer or an experienced radio/TV technician for help.

INDUSTRY CANADA (ICES-003)

This Class B digital apparatus complies with Canadian ICES-003.

Cet appareil numérique de la classe B est conforme à la norme NMB-003 du Canada.

IMPORTANT RECYCLE INSTRUCTIONS



Lamp(s) inside this product contain mercury. This product may contain other electronic waste that can be hazardous if not disposed of properly. Recycle or dispose in accordance with local, state, or federal Laws.

For more information, contact the Electronic Industries Alliance at WWW.EIAE.ORG.

For lamp specific disposal information check WWW.LAMPRECYCLE.ORG.

DISPOSAL OF OLD ELECTRICAL AND ELECTRONIC EQUIPMENT (Applicable throughout the European Union and other European countries with separate collection programs)



This symbol found on your product or on its packaging, indicates that this product should not be treated as household waste when you wish to dispose of it. Instead, it should be handed over to an applicable collection point for the recycling of electrical and electronic equipment. By ensuring this product is disposed of correctly, you will help prevent potential negative consequences to the environment and human health, which could otherwise be caused by inappropriate disposal of this product. The recycling of materials will help to conserve natural resources. This symbol is only valid in the European Union. If you wish to discard this product, please contact your local authorities or dealer and ask for the correct method of disposal.

Notes:

Table of Contents

RuncoCare™ Standard One Year Limited Warranty	iii
Important Safety Instructions	vii
Compliance Information	ix
1. Introduction	1
About This Manual	1
Target Audience.....	1
If You Have Comments About This Manual	1
Textual and Graphic Conventions.....	1
Using This Manual	2
Description, Features and Benefits.....	3
Key Features and Benefits.....	4
Parts List	4
2. Controls & Functions	5
Climate Series LCD at a Glance	5
Controls and Indicators	5
Climate Series LCD Inputs and Outputs	7
Climate Series LCD Remote Control	9
3. Installation	12
Remote Control.....	12
PET Film Removal	12
Battery Installation	12
Notes on Remote Control Operation.....	12
Quick Setup	13
Installation Considerations.....	14
Wall-Mounting the Climate Series LCD	14
Connections to the Climate Series LCD	14
Input/Output Connection Panel Access	14
Connecting the Climate Series LCD to Source Components	15
Connecting External Speakers (Optional).....	18
RS-232 Controller Connection (Optional)	18

4. Operations	20
Turning on the Power	20
Changing the OSD Language.....	20
Setting the PC Display Properties	21
Using the On-Screen Menus	22
Picture.....	24
Audio.....	25
Time	26
Setup.....	27
Lock	28
Channel.....	29
Stereo Sound/SAP.....	30
5. Maintenance and Troubleshooting	31
Cleaning.....	31
Cleaning the Display, Panel Body and Remote Control	31
Cleaning the Air Filters and Vents	31
Trouble Shooting Tips.....	31
6. Serial Communications	33
RS-232 Connection and Port Configuration	33
Serial Command Syntax	33
7. Specifications	36
Climate Series LCD Specifications	36
Climate Series LCD Dimensions	37
Supported Timings.....	39

List of Figures

2-1. Climate Series LCD Controls and Indicators	5
2-2. Climate Series LCD Inputs and Output Interfaces	7
2-3. Climate Series LCD Remote Control	9
3-1. HDMI Connections	15
3-2. Analog RGB Connections.....	16
3-3. Component Video Connections	17
3-4. Composite and S-Video Connections.....	17
3-5. External Speaker Connection	18
3-6. RS-232 Control System Connection.....	18
4-1. Climate Series LCD OSD Menu Structure.....	23
7-1. CP-42HD Dimensions (Front/Side/Rear)	37
7-2. CP-52HD Dimensions (Front/Side/Rear)	38

Notes:

1. Introduction

This Owner's Manual describes how to Install, set up and operate a Runco Climate Series Model CP-42HD and CP-52HD Weatherproof Flat-Panel LCD. Throughout this manual, the Runco CP-42HD and CP-52HD are referred to collectively as the "Climate Series LCD." The information in this manual applies to both products, except where otherwise indicated.

Runco has prepared this manual to help home theater installers and end users get the most out of the Climate Series LCD.

Runco has made every effort to ensure that this manual is accurate as of the date it was printed. However, because of ongoing product improvements and customer feedback, it may require updating from time to time. You can always find the latest version of this and other Runco product manuals on-line, at www.Runco.com.

Runco welcomes your comments about this manual. Send them to sales@runco.com.

Text Conventions: The following conventions are used in this manual. In order to clarify the information and instructions provided:

- Remote and built-in keypad button identifiers are set in upper-case bold type; for example, "Press **EXIT** to return to the previous menus."
- Computer Input (commands you type) and output (responses that appear on-screen) is shown in monospace (fixed-width) type; for example:
"To change the aspect ratio to Letterbox, type `op aspect = 1`
<Enter>."
- All keys with functional names are initial-capped, set in bold type and enclosed in angle brackets. These keys are the following: **<Enter>**, **<Spacebar>**, **<Control>**, **<Esc>** and **<Tab>**.
- **<Enter>** indicates that you may press either the RETURN or ENTER key on your keyboard if it has both keys.

In addition to these conventions, underlining, boldface and/or italics are occasionally used to highlight important information, as in this example:



Note A carriage return **must** be used after each command or string.

1.1 About This Manual

◀ Target Audience

◀ If You Have Comments About This Manual...

◀ Textual and Graphic Conventions

Graphic Conventions: These symbols appear in numerous places throughout the manual, to emphasize points that you must keep in mind to avoid problems with your equipment or injury:



Tip

TIPS highlight time-saving short cuts and helpful guidelines for using certain features.



Note

NOTES emphasize text with unusual importance or special significance. They also provide supplemental information.



Caution

CAUTIONS alert users that a given action or omitted action can degrade performance or cause a malfunction.



WARNING

WARNINGS appear when a given action or omitted action can result in damage to the equipment, or possible non-fatal injury to the user.



DANGER!

DANGER appears when a given action can cause severe injury or death

1.2 Using This Manual

Use the following table to locate the specific information you need in this manual.

If you need...	...Turn to page:
Information about obtaining service	iv
General information about the CP-42HD and CP-52HD Flat-Panel LCDs	3
Installation instructions	12
First-time configuration instructions	20
Troubleshooting Tips	31
Specifications for the CP-42HD and CP-52HD Flat-Panel LCDs	37

The Climate™ Series LCD offers legendary Runco® product quality and attention to detail housed inside a slim, yet rugged, weatherproof cabinet. Best of all, this display is finished with the same clean and elegant look and style that distinguishes all Runco flat panels.

Rain or shine, the Climate Series LCD will enhance your luxury outdoor lifestyle. This full high-definition widescreen flat-panel monitor utilizes advanced LCD technology in an enclosure designed to withstand the elements. Featuring 1920 x 1080 native resolution and reflection-rejection glass, the Climate Series LCD's image quality is impressive.

The enclosure has been engineered for maximum durability. We have gone to great lengths to ensure protection from adverse environmental conditions including temperature, exposure to moisture, dust, oils, and even intermittent direct water spray.

Engineered into the monitor is an internal setting that allows operation in colder temperatures (down to 0° F) so you can enjoy viewing year round. The aluminum cabinet is sealed to ensure protection from the elements and features a specially-designed internal ventilation system to provide adequate cooling when needed. The ThermoCare™ internal thermostat activates a cooling system regardless of whether the TV is on or off, to avoid damage to the display in hot weather. As a result, the Runco Climate Series LCD surpasses IP56 weatherproof standards, which accommodates leaving it outdoors 365 days a year, without worry.

Installation options are limited only by the imagination. Patios, barbeques, gazebos, pools, hot tubs, gardens, tennis courts, putting greens – literally anywhere you want amazing video in a sleek flat-panel design.

The Climate Series LCD is a Runco, offering all the user-friendly features you've come to expect from the brand that prides itself in providing the world's finest home theater products. Custom installation capabilities include an RS-232 automation interface with discrete on/off, input selection and aspect ratio control. These models also features Runco's exclusive Vivix® video processing for outstanding imagery, artifact-free scaling and superb reproduction of both native film and native video formats.

A wide variety of inputs include two HDMI signals and a range of video inputs for gaming, internet surfing and other computer activities. The Climate Series LCD has an exceptionally wide viewing angle of 176 degrees to make enjoyment possible for a large number of viewers with widely dispersed seating positions.

Runco invites you to enjoy the world of true luxury outdoor living with the Climate Series LCD.

1.3 Description, Features and Benefits

Key Features and Benefits ➤

The Climate Series LCD offers these key features and benefits:

- Full HD Native Resolution: 1920 x 1080
- Anti-Reflective Glass that helps to reduce glare and reflection for easy viewing in direct sunlight as well as protect the LCD from being damaged by sunlight.
- Engineered into the monitor is an internal setting that allows operation in colder temperatures (down to 0° F) so you can enjoy viewing year round.
- The ThermoCare™ internal thermostat activates a cooling system regardless of whether the TV is on or off, to avoid damage to the display in hot weather.
- The Runco Climate Series LCD surpasses IP56 weatherproof standards, which accommodates leaving it outdoors 365 days a year, without worry.
- Includes an RS-232 automation interface with discrete on/off, input selection and aspect ratio control.
- Features Runco's exclusive Vivix® video processing for outstanding imagery, artifact-free scaling and superb reproduction of both native film and native video formats.
- Has a wide variety of inputs including two HDMI signals and a range of video inputs for gaming, internet surfing and other computer activities.
- Has an exceptionally wide viewing angle of 176 degrees to make enjoyment possible for a large number of viewers with widely dispersed seating positions.
- Comes with a waterproof remote that is able to float.

Parts List ➤

Your Climate Series LCD is shipped with the following items. If any items are missing or damaged, please contact your Runco dealer or Runco Customer Service rep at (800) 23-RUNCO.

- Climate Series LCD Panel: Model CP-42HD (part number 997-6156-00) or CP-52HD (part number 997-6157-00)
- Remote Control unit and (1) Lithium CR2032 battery
- AC Power Cord
- CP-42HD/CP-52HD Installation/Operation Manual (this document)

Optional Accessories:

- Outdoor Wall Mount Kit
- Table Stand
- ColourPalette Outdoor

2. Controls & Functions

2.1 Climate Series LCD at a Glance

Figure 2-1 shows the locations of the Climate Series LCD controls and indicators (shown with stand).

◀ **Controls and Indicators**

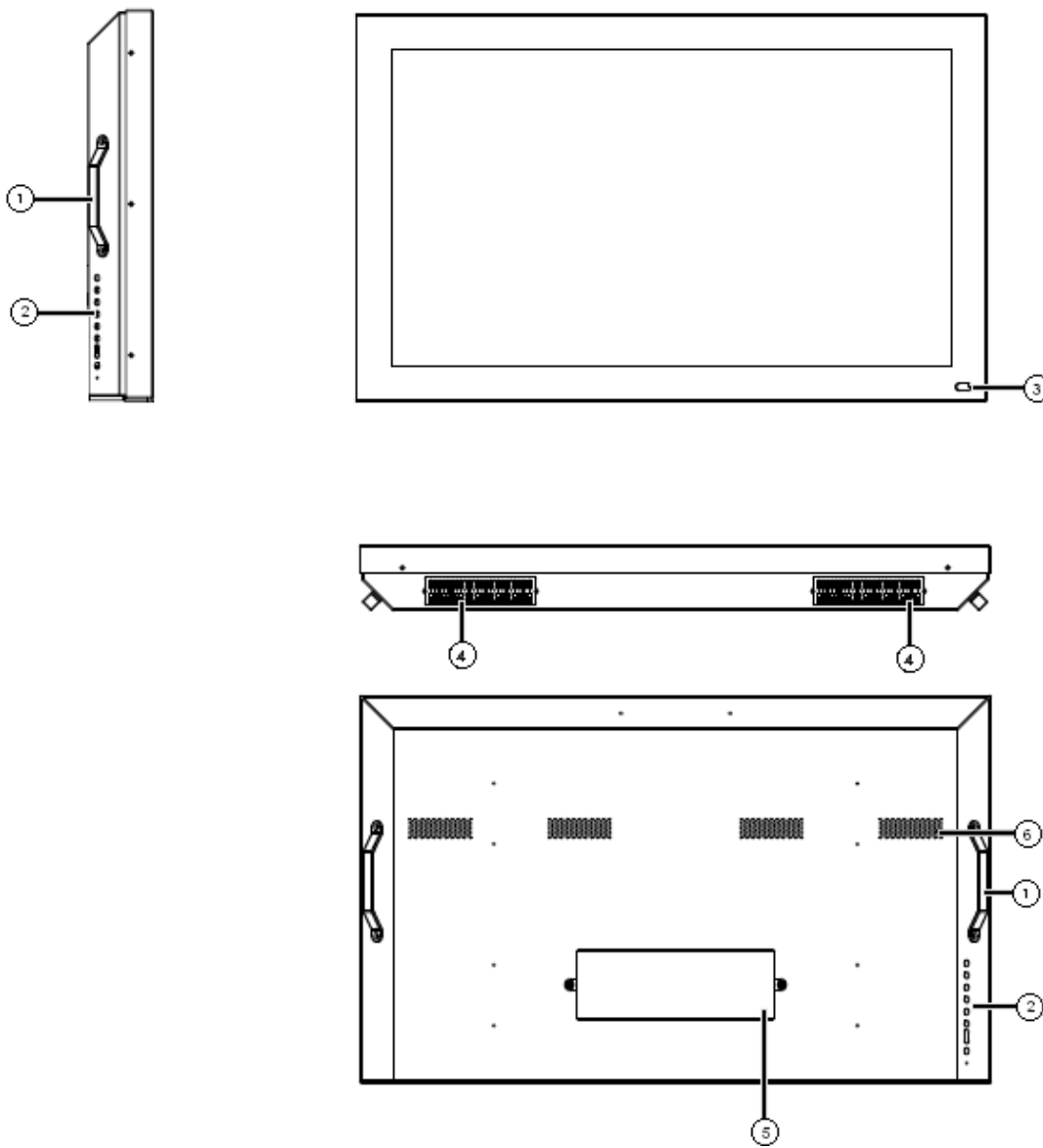

Figure 2-1 shows the Climate Series LCD Side/Front/Back/Bottom View

1. HANDLES

Always use the handles when carrying the display. DO NOT touch or hold the screen face.

2. KEYPAD

You can use the keypad instead of the remote control unit to operate the on-screen display (OSD) controls. The keypad operates as follows:

VOLUME DOWN / MENU LEFT 

Use this button to increase sound volume. When a menu is visible on-screen, this button operates identically to the Left Key on the Climate Series remote control unit.

VOLUME UP / MENU RIGHT 

Use this button to increase sound volume. When a menu is visible on-screen, this button operates identically to the Right Key on the Climate Series remote control unit.

CHANNEL DOWN / MENU DOWN 

Use this button to adjust the channel up. When a menu is visible on-screen, this button operates identically to the Down Key on the Climate Series remote control unit.

CHANNEL UP / MENU UP 

Use this button to adjust the channel down. When a menu is visible on-screen, this button operates identically to the Up Key on the Climate Series remote control unit.

SOURCE

To select a source, press the **SOURCE** button repeatedly (with no menu available on-screen).

MENU

Press this button to access the on-screen display (OSD), or to exit the current menu and return to the previous one.

POWER

Use this button to turn the unit on and off.



3. IR SENSOR / STATUS LED

Infrared (IR) Sensor that receives signals from the remote control. Status LED lights red to indicate that the Climate Series LCD is in standby mode or if the main power switch is set to off; green during normal operation.

4. INTAKE VENTS

Internal fans draw cool air into the monitor through these vents.

5. BACK PANEL INPUT/OUTPUT COVER

Input/Output connections are recessed in the back of the monitor and have a cover engineered to keep connections dry.

6. EXHAUST VENT

Warm air exits the monitor through these vents. Ensure that they are not blocked.

Figure 2-2 shows the Climate series Input and Output Interfaces.

◀ **Climate Series LCD Inputs and Outputs**

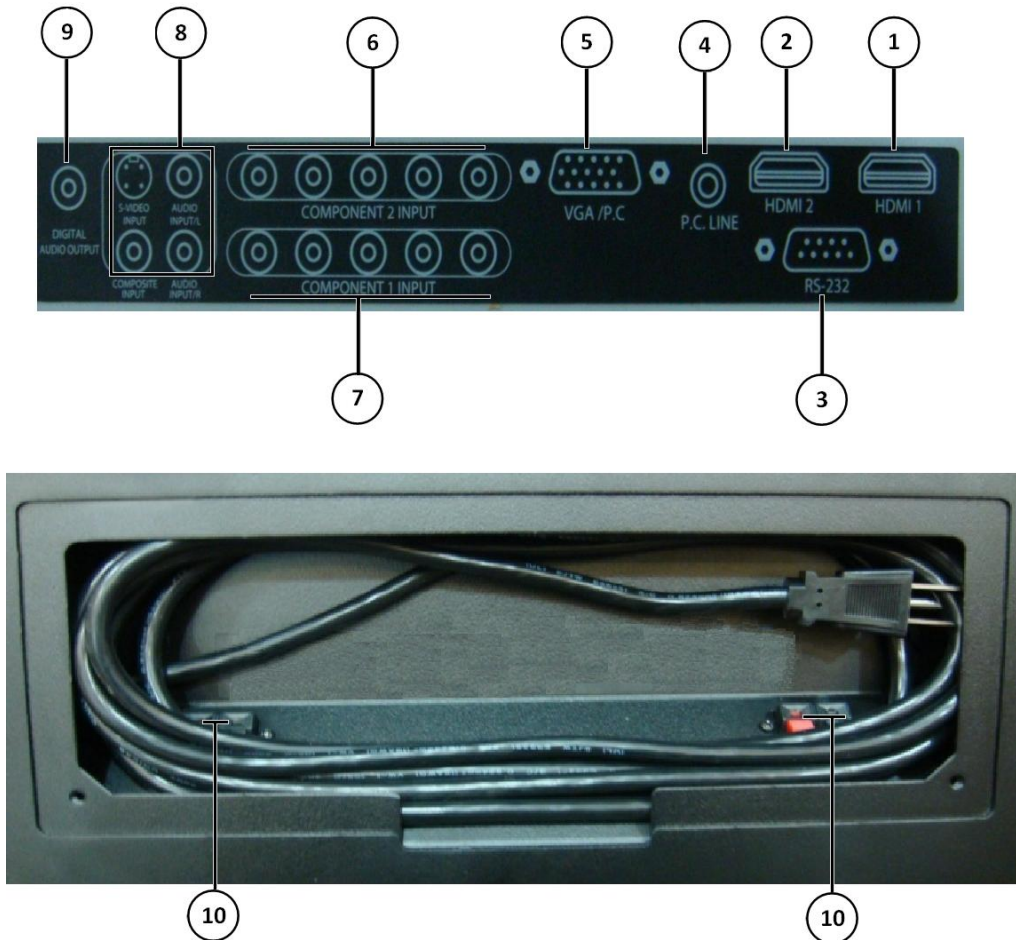

Figure 2-2. Climate Series LCD Input/Output Interfaces

1. **HDMI 1 (Digital)**
HDCP-compliant digital video inputs for connecting an HDMI or DVI source.
2. **HDMI 2 (Digital)**
HDCP-compliant digital video inputs for connecting an HDMI or DVI source.
3. **RS-232**
A female, 9-pin D-sub connector for interfacing with a PC or home theater automation/control system.
4. **PC LINE**
Connect the audio output from a personal computer here.
5. **RGB/VGA P.C.**
Provides a standard, 15-pin VGA-style connection to either an RGB or component high-definition source, or to a personal computer.
6. **COMPONENT 2**
Standard- or high-definition (up to 1080p), YPrPb component video and stereo audio input.
7. **COMPONENT 1**
Standard- or high-definition (up to 1080p), YPrPb component video and stereo audio input. Also provides RGB input for RGBS sources.

8. **VIDEO INPUT (Composite or S-Video + Stereo Audio)**
Standard, composite or S-video input and stereo audio input for connecting a VCR, camcorder, laser disc player, Super VHS (S-VHS) VCR or other composite or S-video source.
9. **DIGITAL AUDIO OUTPUT**
Connects the TV audio out to the digital audio input of an amplifier.
10. **SPEAKER OUTPUT (LEFT + RIGHT)**
For connecting external speakers with an impedance of 4 ohms.

Figure 2-3 shows the Climate Series LCD remote control, and the paragraphs that follow describe its functionality.

2.2 Climate Series LCD Remote Control

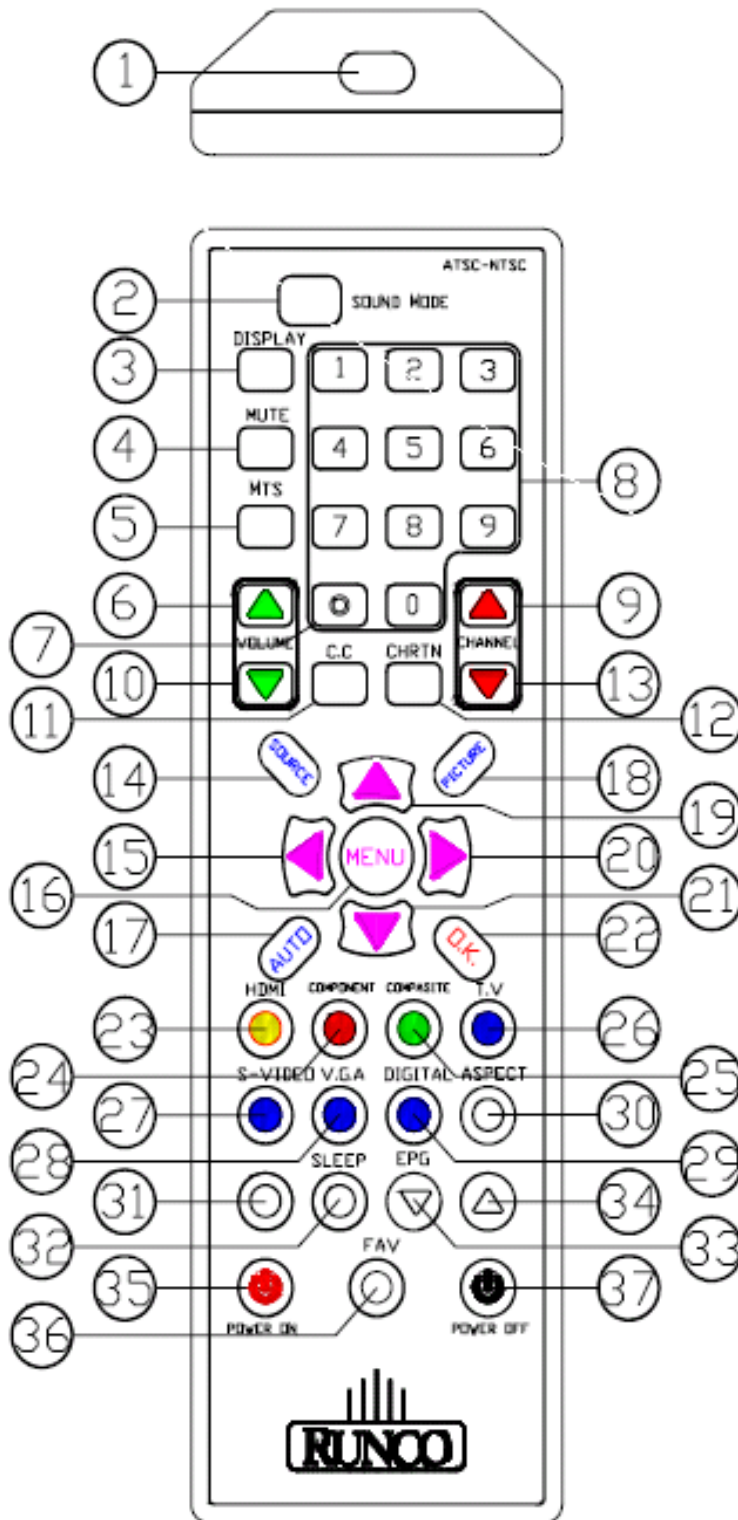

Figure 2-3. Climate Series LCD Remote Control

1. **REMOTE SENSOR**
2. **SOUND MODE**
Press this button to select sound mode, Standard, Music, Movie, or Personal.
3. **DISPLAY INFORMATION**
Press this button to view input signal information (source and resolution).
4. **MUTE ON/OFF**
Press this button to mute the audio output to the speakers.
5. **MTS**
Press this button to scroll through the available MTS settings.
6. **VOLUME UP**
Use this button to increase sound volume.
7. **DOT**
Press this button when entering the channel number for direct tuning to a digital TV channel.
8. **0 - 9**
Use these keys to enter numeric characters.
9. **CHANNEL UP**
Use this button to adjust channel up.
10. **VOLUME DOWN**
Use this button to decrease sound volume.
11. **C.C. KEY**
Press this button to activate Closed Caption function. Supports CEA608B and CEA708B.
12. **CHANNEL RETURN**
Press this button to return to the previous channel selected.
13. **CHANNEL DOWN**
Use this button to adjust channel down.
14. **SOURCE INPUT**
Press this button to select the input you would like. Use the **Up/Down Keys** to highlight the input source and then press **OK. / ENTER**.
15. **LEFT KEY**
Use this button to select items or settings.
16. **MENU / EXIT**
Press this button to show or hide the OSD controls, to save menu item setting(s) or exit the current menu and return to the previous one.
17. **AUTO FUNCTION**
Press this button to auto-scan input sources.
18. **PICTURE MODE**
Press this button to select picture mode, Standard/Dynamic/Personal.
19. **UP KEY**
Use this button to select items or settings.
20. **RIGHT KEY**
Use this button to select items or settings.
21. **DOWN KEY**
Use this button to select items or settings.
22. **O.K. / ENTER**
Press to select a highlighted menu item or confirm a changed setting.
23. **HDMI 1 & 2**
Press to select an HDMI input.
24. **COMPONENT 1 & 2**
Press to select a Component input.

25. **COMPOSITE**
Press to select the Composite input as the source.
26. **T.V**
Press this button to switch to the antenna/DTV/CATV input.
27. **S-VIDEO BUTTON**
Press to select the S-Video input as the source.
28. **VGA BUTTON**
Press to select the VGA input as the source.
29. **DIGITAL BUTTON**
Press this button to switch to the Digital Video input.
30. **ASPECT BUTTON**
Use this button to select Normal, Wide, Zoom, or Cinema.
31. **NC**
Reserved button
32. **SLEEP BUTTON**
Press this button to set the sleep mode function.
33. **EPG**
Switches the Electronic Program Guide (EPG) on/off.
34. **NC**
Reserved button
35. **POWER ON**
Use this button to turn the display on.
36. **FAV**
Use this button to select stored favorite channel. To store favorite channel, select Favorite from the Channel menu (see page 30).
37. **POWER OFF**
Use this button to turn the display off.

3. Installation

3.1 Remote Control

PET Film Removal ➤

For the first time use of the remote control, please pull out the PET Film.

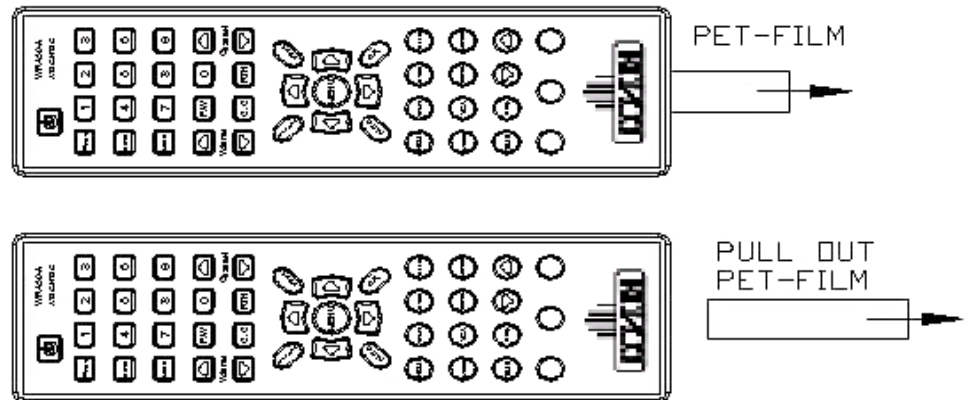

Battery Installation ➤

To change the battery in the remote control:

1. Remove the six screws on the back of the remote.
2. Remove the battery and replace with another Lithium CR2032 Battery.
3. Please follow the drawing to remove the screws and replace the battery.

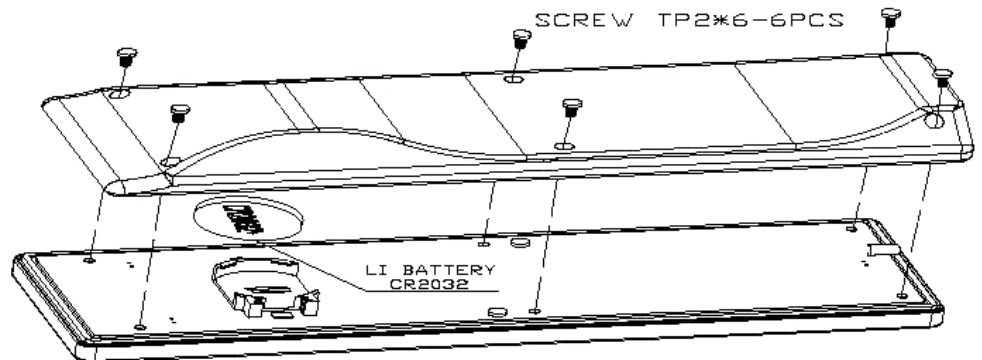

Notes on Remote Control Operation ➤

- Make sure that there is nothing obstructing the infrared beam between the remote control and the IR receiver on the projector.
- If the effective range of the remote control decreases, or it stops working, replace the battery with a new one.
- Ambient conditions may possibly impede the operation of the remote control. If this happens, point the remote control at the monitor, and repeat the operation.
- This remote control is waterproof and floats.

Table 3-1 gives a quick overview of the Climate Series LCD installation process. The sections following this one provide detailed instructions.

3.2 Quick Setup

Installation should be performed by a qualified custom video installation specialist.



Note

Table 3-1. Installation Overview

Step	Procedure	For Details, Refer to page...
1	Mount the Climate Series LCD on a wall (optional)	14
2	Connect signal sources to the Climate Series LCD	14
3	Connect external controller to RS-232 port (optional)	18
4	Apply power to the Climate Series LCD	20
5	Change the OSD language	20
6	If using the Climate Series LCD with a PC, adjust PC display properties	21
7	Display calibration: adjust the following for each input , save settings when finished: <ul style="list-style-type: none"> • Contrast • Brightness • Color level • Tint • Sharpness 	24

3.3 Installation Considerations

Proper installation of your Climate Series LCD will ensure the highest possible picture quality. Whether you are installing the Climate Series LCD temporarily or permanently, you should take the following into account to ensure that it performs optimally.

Wall-Mounting the Climate Series LCD



You can either place the Climate Series LCD on a table or in an entertainment center, or mount it on a wall.

If you do decide to wall-mount the Climate Series LCD, ensure that the wall-mount bracket is installed according to the instructions included with it. The wall must be capable of supporting a redundant weight factor three (3) times the weight of the display, or be reinforced.

Runco recommends that this be done by a customer installation specialist.



Note

Use only the Runco-approved wall-mount kit designed for your display.

Other considerations and tips that can help improve your installation:

- Keep the Climate Series LCD away from devices that radiate electromagnetic energy such as motors and transformers. Common sources of these include slide projectors, speakers, power amplifiers and elevators.

3.4 Connections to the Climate Series LCD

Proceed as follows to connect the Climate Series LCD to your video sources, external controller(s) – if present – and AC power.

When connecting your equipment:

- Turn off all equipment before making any connections.
- Use the correct signal cables for each source.
- Ensure that the cables are securely connected. Tighten the thumbscrews on connectors that have them.
- Use the left audio input when connecting mono audio sources.

Input/Output Connection Panel Access



To access the rear input/output connectors, loosen the two captive screws on the input/output cover and remove the input/output connector cover.

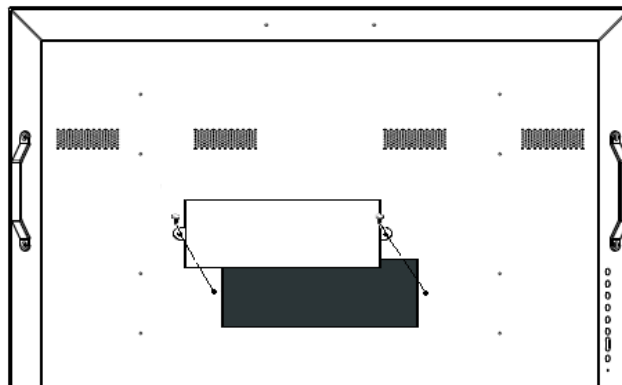

Connect your video sources to the Climate Series LCD as shown and described in the sections that follow.

◀ Connecting the Climate Series LCD to Source Components

HDMI Connections: The Climate Series LCD has two HDMI inputs for connecting a BD/HD-DVD/DVD player, DTV decoder, personal computer or any other device with an HDMI or DVI output. Connect such devices as shown in Figure 3-1.

Use the HDMI inputs whenever possible. This ensures the highest video quality because the signal is carried in the digital domain throughout the entire signal path, from source component output into the display.



Tip

This Climate Series LCD supports the VESA Display Data Channel (DDC) standard. This standard provides “Plug and Play” capability; the display and a VESA DDC-compatible computer communicate their setting requirements, allowing for quick and easy set-up.



Note

In order for Plug and Play to work correctly, you must turn on the display before you turn on the connected computer.

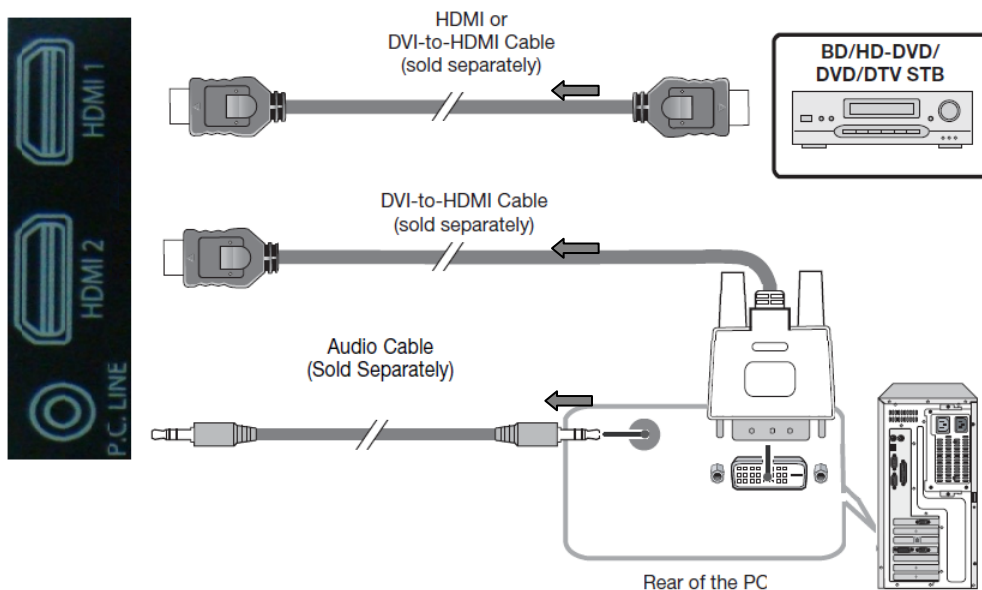

Figure 3-1. HDMI Connections

RGB Connections: The Climate Series LCD has an RGB input and a stereo audio input for connecting a personal computer; see Figure 3-2.

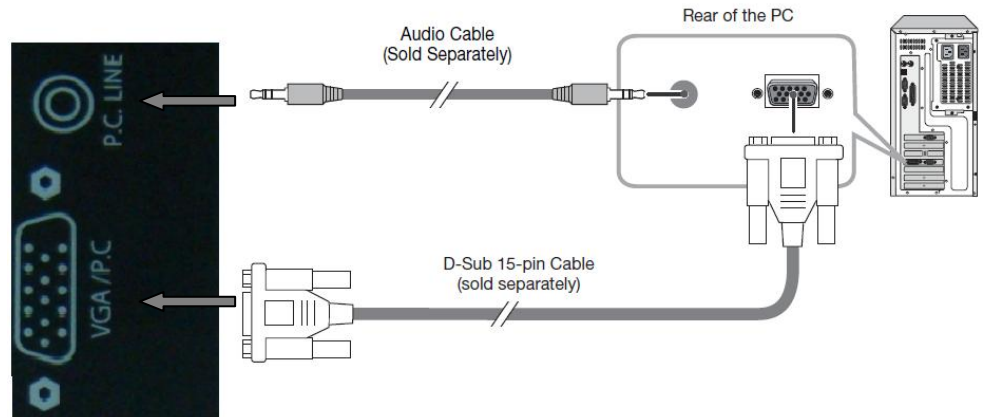

Figure 3-2. Analog RGB Connections



Note

1. Refer to **Supported Timings** on page xx for a list of computer signals compatible with the Climate Series LCD. Use with signals other than those listed may cause some functions not to work.
2. Some Macintosh computers may require a Macintosh video adapter. Contact your nearest authorized service center or dealer.
3. This Climate Series LCD may not be able to display images from notebook computers in simultaneous (CRT/LCD) mode. Should this occur, switch the notebook computer to "CRT only" mode. If you are unsure how to do this, refer to your notebook computer's user manual.

Component Video Connections: If you have a DVD player, DTV decoder with a component (YPbPR) output or other component video source, connect it to the COMPONENT 1 or COMPONENT 2 input as shown in Figure 3-3.

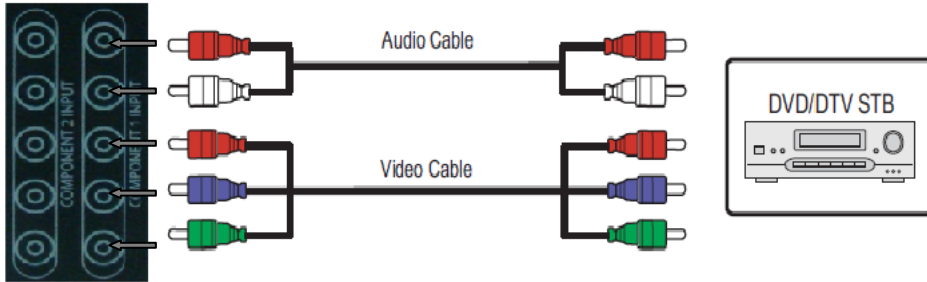

Figure 3-3. Component Video Connections

Composite/S-Video Connections: The Climate Series LCD has one (1) Composite video input and an S-Video input for connecting a VCR, camcorder, laser disc player or DVD player; see Figure 3-4.

If you connect an S-Video source to the Video 2 input, the Composite input on Video 2 is inactive.



Note

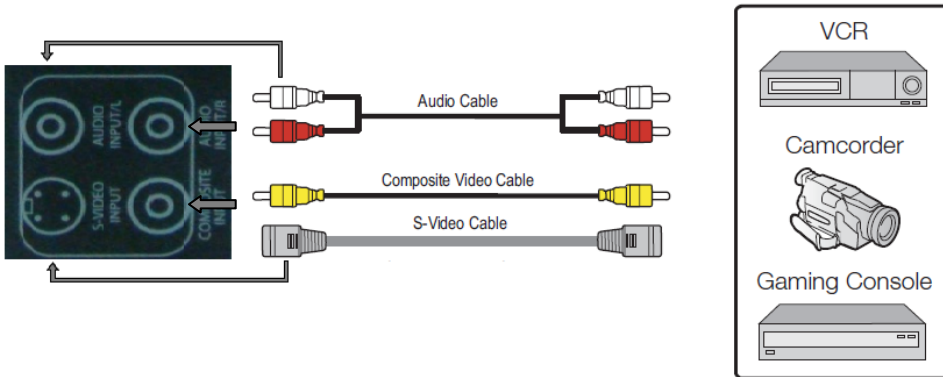

Figure 3-4. Composite and S-Video Connections

Connecting External Speakers (Optional)

- Connect the ⊕ (positive) and ⊖ (negative) speaker wires to the SPEAKER-R and SPEAKER-R terminals; see figure 3-5. **Maintain the correct polarity.** For more information, refer to the owner’s manual for your speakers.

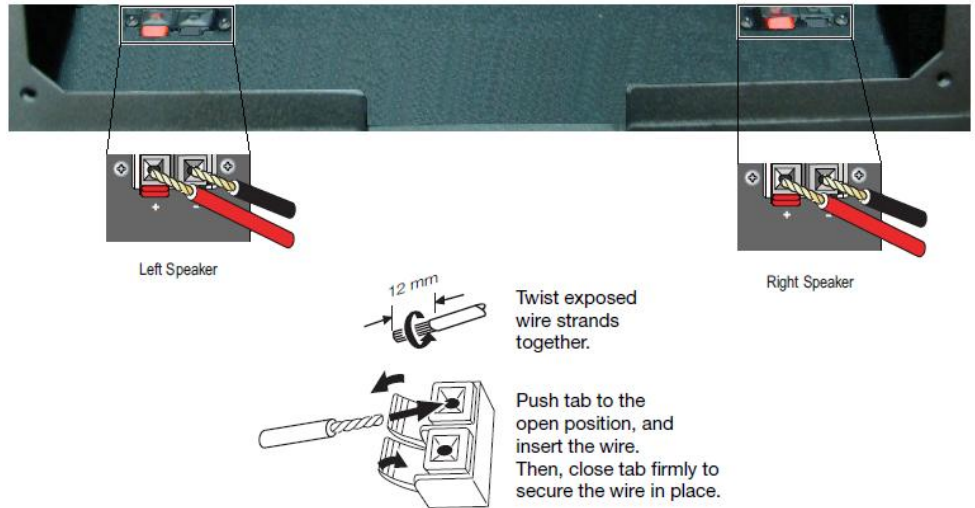

Figure 3-5. External Speaker Connection

RS-232 Controller Connection (Optional)

- Use a straight-through RS-232 cable with a 9-pin make connector to connect a PC or home theater control/automation system (if present) to the RS-232 port on the Climate Series LCD; see Figure 3-6.

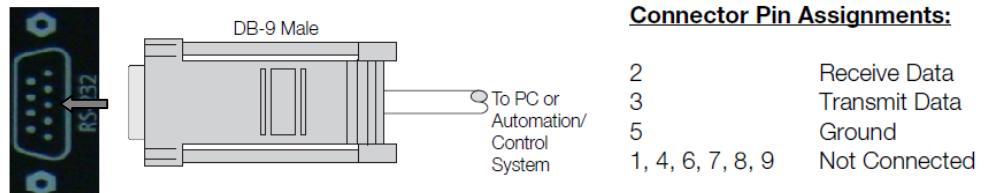



Figure 3-6. RS-232 Control System Connection.

Notes:

4. Operations



4.1 Turning on the Power

1. Turn on your source components.
2. Plug the female end of the supplied power cord into the AC receptacle inside the back input panel of the Climate Series LCD (AC 100V ~ 240 V).
3. Connect the other end to your AC power source.
4. Press the **ON** button () on the remote control to turn on the display (or press the power button () on the side of the display).
5. After a brief warm-up period (approximately 10 seconds), the Climate Series LCD will display an image.



4.2 Changing the OSD Language

The Climate Series LCD OSD language is initially set to English, but can also display the menus in French or Spanish. To change the OSD language:

1. Press **MENU**.
2. Select **Setup** from the Main Menu.
3. Select **Menu Language** from the Setup Menu.
4. Press  or  to highlight the desired language and press **O.K.** The change takes effect immediately.

To maximize image quality when using the Climate Series LCD with a personal computer, you may need to adjust the display properties of your PC Video Card. To do this:

1. Choose Settings from the Windows Start menu and click on "Control Panel."

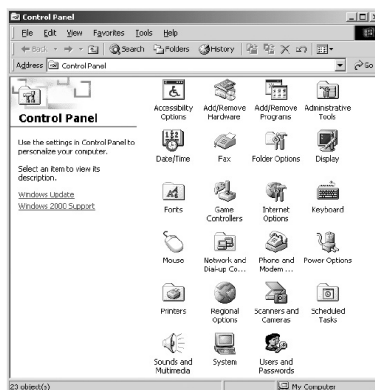

2. Double click on the **Display** icon.
3. Click the **Settings** tab on the display dialog box.
4. Set the Screen area to 1400x1050 pixels.

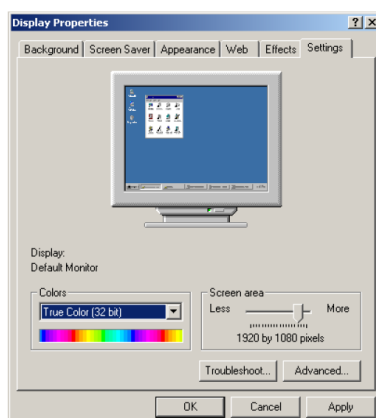

5. Click the **Advanced** button and click the **Monitor** tab on the dialog box. Set the Refresh Frequency to 60 Hz and click **OK**.



4.3 Setting the PC Display Properties



Note

1. *The maximum available resolution and vertical frequency is 1920x1200/60Hz or the maximum supported by your video card, whichever is lower.*
2. *The Climate Series LCD supports 8-bit color (16,777,216 possible colors).*

4.4 Using the On-Screen Menus

Many functions are controlled through the menu function, using the remote control handset or keypad on the side of the display.

To use the on-screen menus:

1. Press **MENU** to display the Main Menu.
2. To select a menu item, use the left- or right-arrow buttons (◀, ▶) on the remote to control to highlight it.
3. Press the down-arrow button (▼) to access that menu.
4. Use the up- or down-arrow buttons (▼, ▲) to select the setting you want to change. Then, press the right-arrow button (▶).
5. Press the right- or left-arrow button (◀, ▶) to change that setting.
6. To return to the previous menu, press **MENU** or (▲).

The Climate Series LCD OSD menus are arranged hierarchically, as shown in Figure 4-1. Depending on the selected input source and/or signal characteristics, some menu options may not be available.

Picture	Picture Mode	Standard		
		Dynamic		
		Personal		
	Contrast	0~100		
	Brightness			
	Color			
	Tint		-50~+50	
	Sharpness	0~100		
Color Mode	Normal			
	Warm			
	Cool			
Audio	Sound Mode	Standard		
		Music		
		Movie		
		Personal		
	Bass	0~100		
	Treble			
	Balance			
	Surround	Off / On		
	AVC	Off / On		
	SPDIF Type	PCM / RAW		
Audio Language	English			
	French			
	Spanish			
Time	Sleep Timer	Off, 5 min ~ 240 min		
	Time Zone	Pacific		
		Alaska		
		Hawaii		
		Eastern		
		Central		
		Mountain		
	Daylight Savings Time	Off / On		
Clock	Auto			
Setup	Menu Language	English		
		French		
		Spanish		
	Transparency	Off / On		
	Zoom Mode	Normal		
		Wide		
		Zoom		
		Cinema		
	Noise Reduction	Off		
		Weak		
		Middle		
		Strong		
	Advanced			
	Closed Caption	CC Mode	On	
Off				
CC on mute				
Basic Selection		CC1		
		CC		
Advanced Selection	Service 1			
MISC Setup	XVS On / Off			
Restore Default	Reset to Factory Setup default			
Lock	Enter Password			
Channel	Air/Cable	Air / Cable		
	Auto Scan	Auto		
		STD		
		IRC		
		HRC		
	Favorite	FAV channel		
	Show/Hide	Channel On / Off		
	Channel No.			
	Channel Label			
DTV Signal				

Figure 4-1. Climate Series LCD OSD Menu Structure

Picture ➤ Use the controls in the Picture Menu to calibrate your Climate Series LCD for optimum picture quality.

Picture Mode: To set the Picture Mode, select Picture Mode from the Picture menu and press the left- or right- arrow buttons to select Standard, Dynamic or Personal. Press **O.K.** or **MENU** to confirm your selection.

Contrast: To adjust the Contrast, select Contrast from the Picture menu and press the left- or right- arrow buttons to adjust. Press **O.K.** or **MENU** to confirm your selection.

Brightness: To adjust the Brightness, select Brightness from the Picture menu and press the left- or right- arrow buttons to adjust. Press **O.K.** or **MENU** to confirm your selection.

Color: To adjust the Color, select Color from the Picture menu and press the left- or right- arrow buttons to adjust. Press **O.K.** or **MENU** to confirm your selection.

Tint: To adjust the Tint, select Tint from the Picture menu and press the left- or right- arrow buttons to adjust. Press **O.K.** or **MENU** to confirm your selection.

Sharpness: To adjust the Sharpness, select Sharpness from the Picture menu and press the left- or right- arrow buttons to adjust. Press **O.K.** or **MENU** to confirm your selection.

Color Mode: To set the Color Mode, select Color Mode from the Picture menu and press the left- or right- arrow buttons to select Normal, Warm or Cool. Press **O.K.** or **MENU** to confirm your selection.

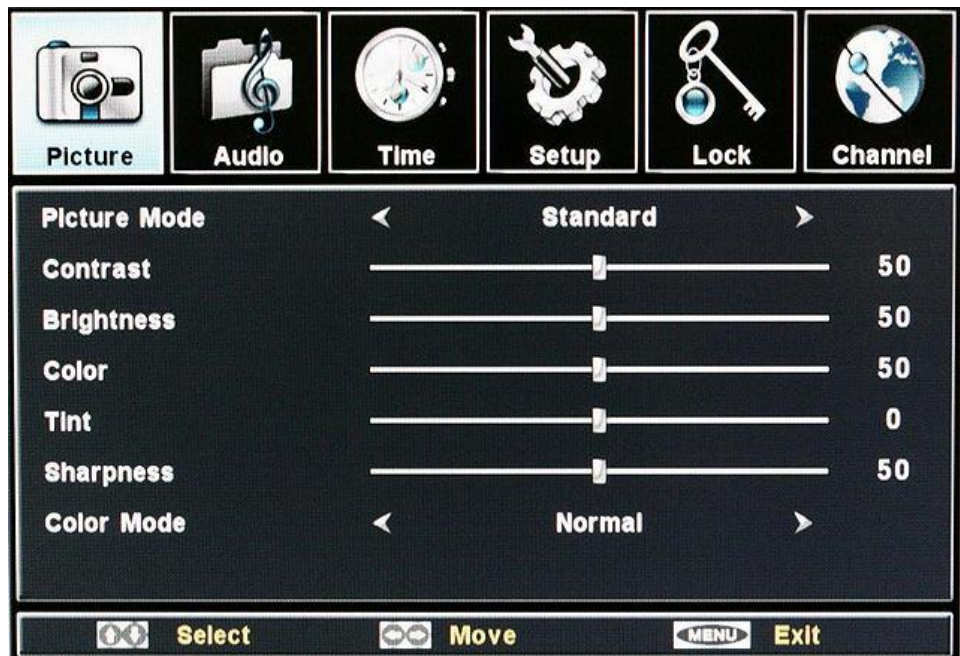

To adjust the Climate Series LCD audio setting, select Audio from the Main Menu and press the up- or down-button to select the setting you want to change.



Audio

Sounds Mode: To set the Sound Mode, select Sound Mode from the Audio menu and press the left- or right- arrow buttons to select Standard, Music, Movie or Personal. Press **O.K.** or **MENU** to confirm your selection.

Bass: To adjust the Bass, select Bass from the Audio menu and press the left- or right- arrow buttons to adjust. Press **O.K.** or **MENU** to confirm your selection.

Treble: To adjust the Treble, select Treble from the Audio menu and press the left- or right- arrow buttons to adjust. Press **O.K.** or **MENU** to confirm your selection.

Balance: To adjust the left/right speaker balance, select Balance from the Audio Menu and press the left- or right- arrow buttons to make one channel louder than the other.

Surround: To turn the Surround Sound on or off, select Surround from the Audio Menu and press the left- or right- arrow buttons to change setting. When finished, press **O.K.** or **MENU**.

AVC: To turn the AVC on or off, select AVC from the Audio Menu and press the left- or right- arrow buttons to change setting. When finished, press **O.K.** or **MENU** to confirm your selection.

SPDIF Type: To set the SPDIF Type, select SPDIF Type from the Audio menu and press the left- or right- arrow buttons to select PCM or RAW. Press **O.K.** or **MENU** to confirm your selection.

Audio Language: To change the Audio Language, select Audio Language from the Audio menu and press the left- or right- arrow buttons to select English, French or Spanish. Press **O.K.** or **MENU** to confirm your selection.

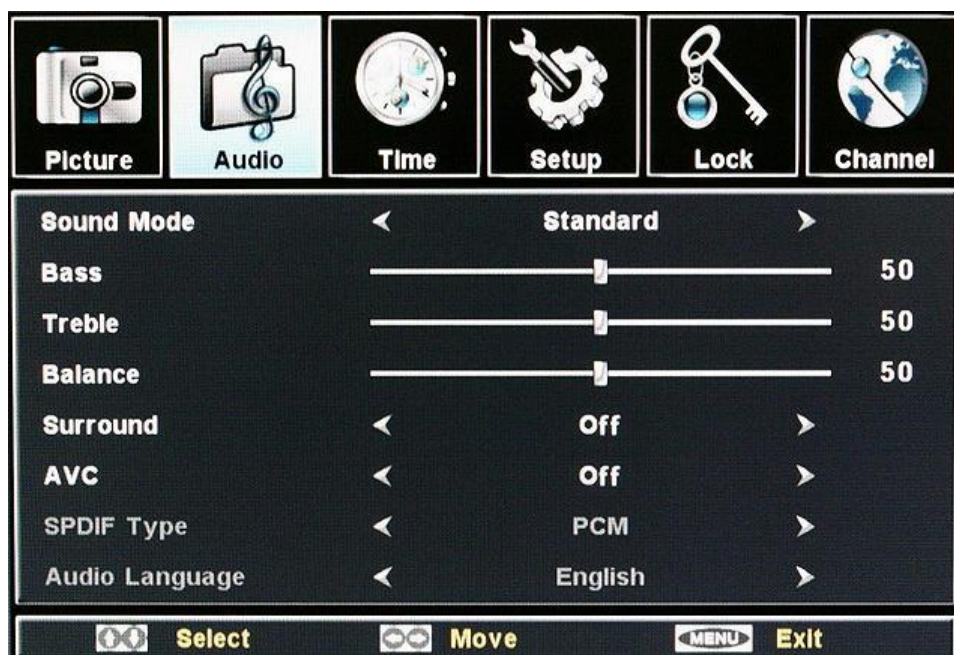

Time ➤ To set the Climate Series LCD Time functions, select Time from the Main Menu and press the up- or down-button to select the setting you want to change.

Sleep Timer: Use the Sleep Timer to turn off the Climate Series LCD after a specified interval.

To set the Sleep Timer:

- Select Sleep Timer from the Time menu and press the left- or right- arrow buttons to change setting.
- OR-
- Press the **SLEEP** button on the remote control.

Use the left- or right- arrow buttons to turn Sleep Timer off or select 5min ~ 240min. Then, press **O.K.** or **MENU**.

Time Zone: To set the local (North American) time zone, select Time Zone from the Time menu and press the left- or right- arrow buttons to select Pacific, Alaska, Hawaii, Eastern, Central or Mountain. Press **O.K.** or **MENU** to confirm your selection.

Daylight Saving Time: To turn the Daylight Saving Time setting on or off, select Time Zone from the Time menu and press the left- or right- arrow buttons to change setting. When finished, press **O.K.** or **MENU**.

Clock: To set the Climate Series LCD internal clock, select Clock from the Time menu and press **ENTER**. Clock should automatically update based on the digital channel's time source. When finished, press **O.K.** or **MENU**.



Use the controls in the Setup menu to perform advanced image quality adjustments and access various other Climate Series LCD Display functions.



Setup

Menu Language: Select Menu Language from the Setup menu and press the left- or right- arrow buttons to select English, French or Spanish. Press **O.K.** or **MENU** to confirm your selection.

Transparency: To turn the Transparency of the Menu on or off, select Transparency from the Setup Menu and press the left- or right- arrow buttons to change setting. When finished, press **O.K.** or **MENU**.

Zoom Mode: Select Zoom Mode from the Setup menu and press the left- or right- arrow buttons to select Normal, Wide, Zoom or Cinema. Press **O.K.** or **MENU** to confirm your selection.

Noise Reduction: Select Noise Reduction from the Setup menu and press the left- or right- arrow buttons to select Off, Weak, Middle or Strong. Press **O.K.** or **MENU** to confirm your selection.

Closed Caption: Select Closed Caption from the Setup menu to control the display of closed captions when watching programs that contain them.

Restore Default: Restore Default setting returns your Climate Series LCD to the original Factory Default setting.



- Lock** ➤ Use the Lock Menu to set your own password and use this password to lock your Climate Series LCD. Password default is set to 0000.

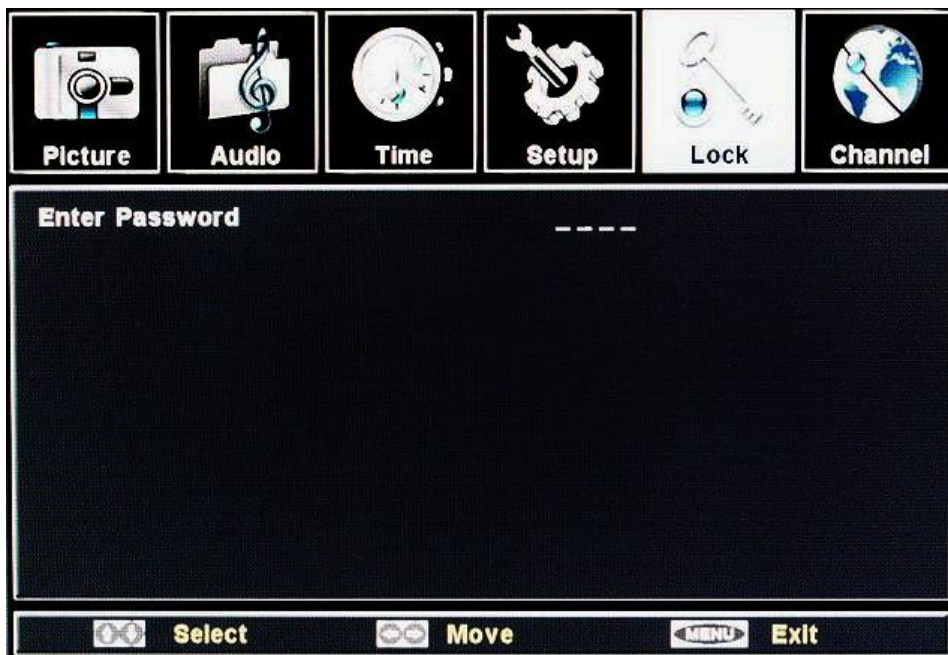

Use the controls in the Channel menu to adjust Channel settings and access various other Climate Series LCD Display functions.

◀ **Channel**

Air/Cable: Use the Air/Cable setting in the Channel menu to select Air or Cable.

Auto Scan: Use the Auto Scan to select the Cable system. Press the left- or right- arrow buttons to select Auto, STD, IRC or HRC.

Favorite: Select Favorite from the Channel menu to set the favorite channel associated with the **FAV** button on the Climate Series remote control.

Show/Hide: Select the Show/Hide from the Channel menu to show or hide a specific channel.

Channel No.: Allows you to tune up and down through various channels to select channel options.

Channel Label: Select this Channel setting to enter customer names for individual channels.

DTV Signal: Shows the format of the currently tuned channel.

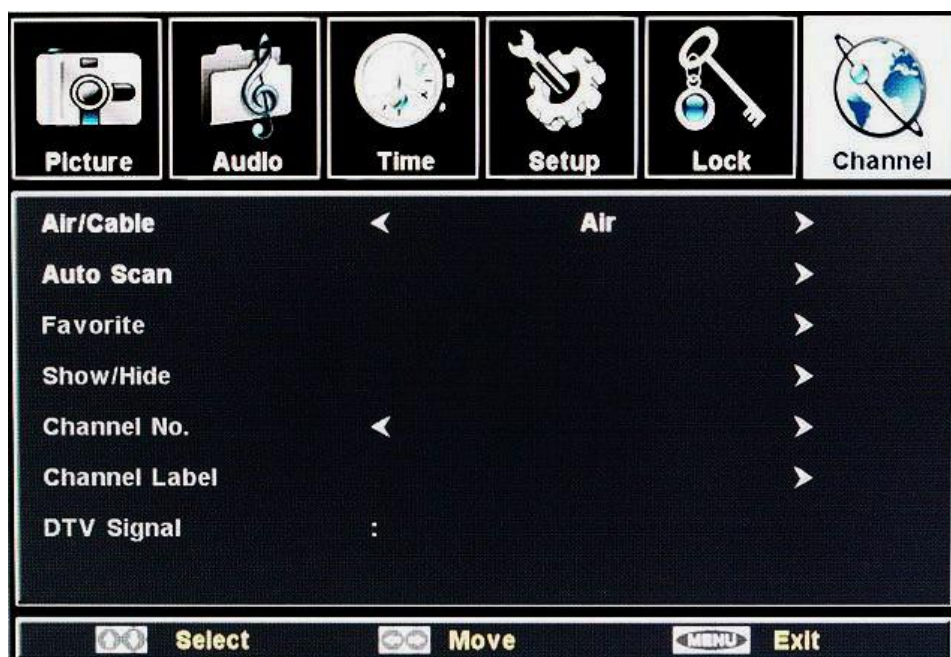

4.5 Stereo Sound/SAP

The Climate Series LCD supports Multichannel Television Sound (MTS), the broadcast audio standard that allows transmission of both stereo and Secondary Audio Program (SAP) content.

The SAP is usually a foreign-language translation. However, it can also be used for other purposes such as Described Video Services (DVS0, which provide descriptive narration of key visual elements in programs for the benefit of the visually impaired.

You can select sound options depending on the broadcast signal by pressing the **MTS** button on the remote control.



5. Maintenance and Troubleshooting

Regular cleaning will extend the life and performance of the Climate Series LCD. Before cleaning, be sure to unplug the power cord from the power outlet.

Do not under any circumstances use solvents such as benzene or thinner to clean the Climate Series LCD. Doing so may cause deterioration or peeling of paint from the display or remote control unit.

For cleaning the weatherproof protective front glass or remote control, use a mild household glass cleaner with a non abrasive soft cloth. If using a cleaner for the first time, we suggest using a test spot in a corner before cleaning the entire surface.

For cleaning the body, use a mild household cleaner with a non abrasive with a soft cloth. If using a cleaner for the first time, we suggest using a test spot on the back of the TV before cleaning the entire surface.

It is recommended that you clean the air filters located at the bottom of the Climate Series LCD every six (6) months. To remove the filters, simply unscrew the two (2) screws. Wash the filter with warm water. Do not use chemicals of any sort. Allow to dry before reinstalling.

As a general rule, use a vacuum cleaner about once a month to clean the vents on the rear panel of the display of dust buildup (set the vacuum cleaner to its weakest setting when doing this). If not removed, accumulated dust can cause the internal temperature to increase, resulting in possible breakdown or fire.

5.1 Cleaning

◀ ***Cleaning the Display, Panel Body and Remote Control***

◀ ***Cleaning the Air Filters and Vents***

Table 5-1. Troubleshooting Chart

Symptom	Possible Cause(s)	Solution
The display does not turn on after initial installation.	<ul style="list-style-type: none"> The Climate Series LCD is not plugged in or the AC outlet is not active. The remote control battery has run out. 	<ul style="list-style-type: none"> Ensure that the Climate Series LCD is plugged in and that the AC outlet is active. Replace the battery.
The display is on, but there is no picture.	<ul style="list-style-type: none"> Incorrect source selection. Source component is not turned on. Source component is connected incorrectly or not at all. 	<ul style="list-style-type: none"> Select the correct source. Turn on the source component. Check video connections to the source component.

5.2 Troubleshooting Tips

Table 5-1. Troubleshooting Chart (continued)

Symptom	Possible Cause(s)	Solution
Picture is okay, but there is no sound.	<ul style="list-style-type: none"> • Audio output is muted. • Volume setting is too low. • Source component is connected incorrectly or not at all. • Speakers are connected incorrectly or not at all. • Audio settings are incorrect 	<ul style="list-style-type: none"> • Press the MUTE button on the remote control. • Turn up the volume. • Check audio connections to source component. • Check speaker connections (Figure 3-5). • Check the setting for SPDIF Type (page 26). For HDMI audio sources, ensure that the SPDIF type is “PCM” (refer to the manual for the source component).
Image is too bright and/or lacks definition in the bright areas of the image.	<ul style="list-style-type: none"> • Contrast is set too high. 	<ul style="list-style-type: none"> • Lower the contrast setting.
Image appears “washed out” and/or dark areas appear too bright.	<ul style="list-style-type: none"> • Brightness is set too high. 	<ul style="list-style-type: none"> • Lower the brightness setting.
Colors in the image are swapped; for example, reds appear blue or vice versa.	<ul style="list-style-type: none"> • The Red/Pr, Green/Y, or Blue/Pb outputs from the source are connected to the wrong inputs on the Climate Series LCD. 	<ul style="list-style-type: none"> • Ensure that the source outputs are connected to the correct Climate Series LCD input.
The image is too large or too small.	<ul style="list-style-type: none"> • Image size needs adjusting. 	<ul style="list-style-type: none"> • Adjust the image size (refer to the Zoom Mode on page 28).

6. Serial Communications

To Interface the Climate Portfolio Series LCD with a home theater automation/control system or a PC running terminal emulation software (such as TeraTerm Open Source project at <http://tssh2.sourceforge.jp/>), connect it to your control system or PC as shown in Figure 3-6. **Use a straight-through cable.**

Configure the RS-232 controller or PC serial port as follows: no parity, 8 data bits, 1 stop but and no flow control. Set the baud rate to 38400

- Commands are in four-byte raw HEX format in the form of Command + Data 1 + ID + Data 2. The Command byte is always 0x69, Data byte 1 defines which command is to be executed, ID byte is always 0x00; Data byte 2 is always 0x00, except in the case of the discrete volume command, in which case it is a value between 0x00 and 0x64.
- To send a command from a PC running terminal emulation software, create either a separate script file for each command or a single script file containing all the commands along with logic to determine which command is to be sent. You cannot type commands in by hand because the Climate Portfolio Series LCD expects the bytes to be sent faster than a human can type, and also many of the HEX values for Data byte 1 are outside the range one can enter using the keys on a keyboard.
- When you send a valid command, the Climate Portfolio Series LCD executes it and acknowledges it with "OK" (0x4F followed by 0x4B). Depending upon the command, it may also return additional strings having to do with execution of that command.
- When you send an invalid or unrecognized command the Climate Portfolio Series LCD ignores it and returns "NG" (0x4E followed by 0x47).

Table 6-1 lists the RS-232 command set.

Table 6-1. Serial Commands

COMMAND	DATA 1	ID	DATA 2
0X69	0X90 : SOURCE	0x00	0X00
	0X91 : SLEEP	0x00	0X00
	0X92 : 1	0x00	0X00
	0X93 : 4	0x00	0X00
	0X94 : 7	0x00	0X00
	0X95 : 0	0x00	0X00
	0X96 : ENTER	0x00	0X00

6.1 RS-232 Connection and Port Configuration

6.2 Serial Command Syntax

Table 6-1. Serial Commands (continued)

COMMAND	DATA 1	ID	DATA 2
	0X97 : MENU	0x00	0X00
	0X98 : CHRTN	0x00	0X00
	0XA1 : DISPLAY	0x00	0X00
	0XA2 : 2	0x00	0X00
	0XA3 : 5	0x00	0X00
	0XA4 : 8	0x00	0X00
	0XA5 : . (DOT)	0x00	0X00
	0XA7 : LEFT	0x00	0X00
	0XB1 : MTS	0x00	0X00
	0XB2 : 3	0x00	0X00
	0XB3 : 6	0x00	0X00
	0XB4 : 9	0x00	0X00
	0XB5 : CC	0x00	0X00
	0XB6 : ASPECT	0x00	0X00
	0XB7 : RIGHT	0x00	0X00
	0XC0 : MUTE OFF	0x00	0X00
	0XC1 : MUTE ON	0x00	0X00
	0XC2 : VOL+	0x00	0X00
	0XC3 : VOL-	0x00	0X00
	0XC4 : CH+	0x00	0X00
	0XC5 : CH-	0x00	0X00
	0XC6 : PICTURE	0x00	0X00
	0XC7 : DOWN	0x00	0X00
	0XD0 : POWER OFF	0x00	0X00
	0XD1 : POWER ON	0x00	0X00
	0XD2 : FAV	0x00	0X00
	0XD3 : SOUND	0x00	0X00
	0XD5 : EPG	0x00	0X00
	0XD6 : EXIT	0x00	0X00
	0XD7 : UP	0x00	0X00
	0XD8 : AUTO	0x00	0X00
	0XC9 : COMPONENT 1,2	0x00	0X00
	0XCA : HDMI 1,2	0x00	0X00
	0XCB : COMPOSITE	0x00	0X00
	0XCC : TV	0x00	0X00

Table 6-1. Serial Commands (continued)

COMMAND	DATA 1	ID	DATA 2
	0XCD : S-VIDEO	0x00	0X00
	0XBA : DIGITAL	0x00	0X00
	0XDA : VGA	0x00	0X00
	0X60 : CLEAR EEPROM	0x00	0X00
	0X61 : DIRECTLY CONTROL VOLUME	0x00	0x00-0x64
	0X64 : BLACKLIGHT OFF	0x00	0X00
	0X65 : BLACKLIGHT ON	0x00	0X00
	0X67 : HDMI 1	0x00	0X00
	0X68 : HDMI 2	0x00	0X00
	0X69 : COMPONENT 1	0x00	0X00
	0X6A : COMPONENT 2	0x00	0X00

Example code fragment from a TeraTerm v4.66 script:

```
inputbox "Enter Command " "Command"

strcompare inputstr "power off"
if result == 0 then
    send $69 $D0 $00 $00
endif

strcompare inputstr "power on"
if result == 0 then
    send $69 $D1 $00 $00
endif

strcompare inputstr "hdmi1"
if result == 0 then
    send $69 $67 $00 $00
endif
```

7. Specifications

7.1 Climate Series LCD Specifications

Table 7-1 lists the Climate Series LCD specifications.

Table 7-1. Climate Series LCD Specifications

Native Resolution:	1920 x 1080 (full high definition)
Screen Size:	CP-42HD = 42 in. (diagonal) CP-52HD = 52 in. (diagonal)
Screen Aspect Ratio:	16:9
Available Aspect Ratios:	4:3, Letterbox, 16:9, Anamorphic
DTV Compatibility:	480i, 480p, 720p, 1080i, 1080p
Contrast Ratio:	2,000:1
Data/Graphics Compatibility:	Up to 1920x1200 at 60 Hz
Response Time (typical):	CP-42HD = 6.5 ms CP-52HD = 6 ms
Vivix Processing:	RTR™: Real Time Refresh 60Hz panel and processing, Vivix 3:2 pull down
Video/Audio Inputs:	(1) Composite, (1) S-video, (2) component, (2)HDMI, (1) VGA (15-pin D-sub)
Outputs:	(1) Digital Audio RCA, (1) Speakers out (amplifier recommended)
Discrete IR Control:	Source, power and aspect ratios via RS-232 or remote
Power Requirements:	AC 100~240V 50~60Hz 5A max
Power Consumption (typical):	CP-42HD = 350W CP-52HD = 500W
Operating Environment:	Operation temperature 0 degrees C to 40 degree C.
Dimensions (w/o stand):	CP-42HD = 40.9" (1,040mm) x 4.6" (116.5mm) x 25.2" (640mm) CP-52HD = 50.4" (1,280mm) x 5.3" (135mm) x 30.5" (775mm)
Weight (w/o stand):	CP-42HD = 73.1 lbs (33.2 Kg) CP-52HD = 121 Lbs (55 Kg)
Limited Warranty:	(1) One year RuncoCare parts and labor from the date of delivery to the end user. RuncoCare™ and Runco RedCarpet™ plans are also available.
Specifications are subject to change without notice.	

Figure 7-1 shows the CP-42HD dimensions (all dimensions are in millimeters).

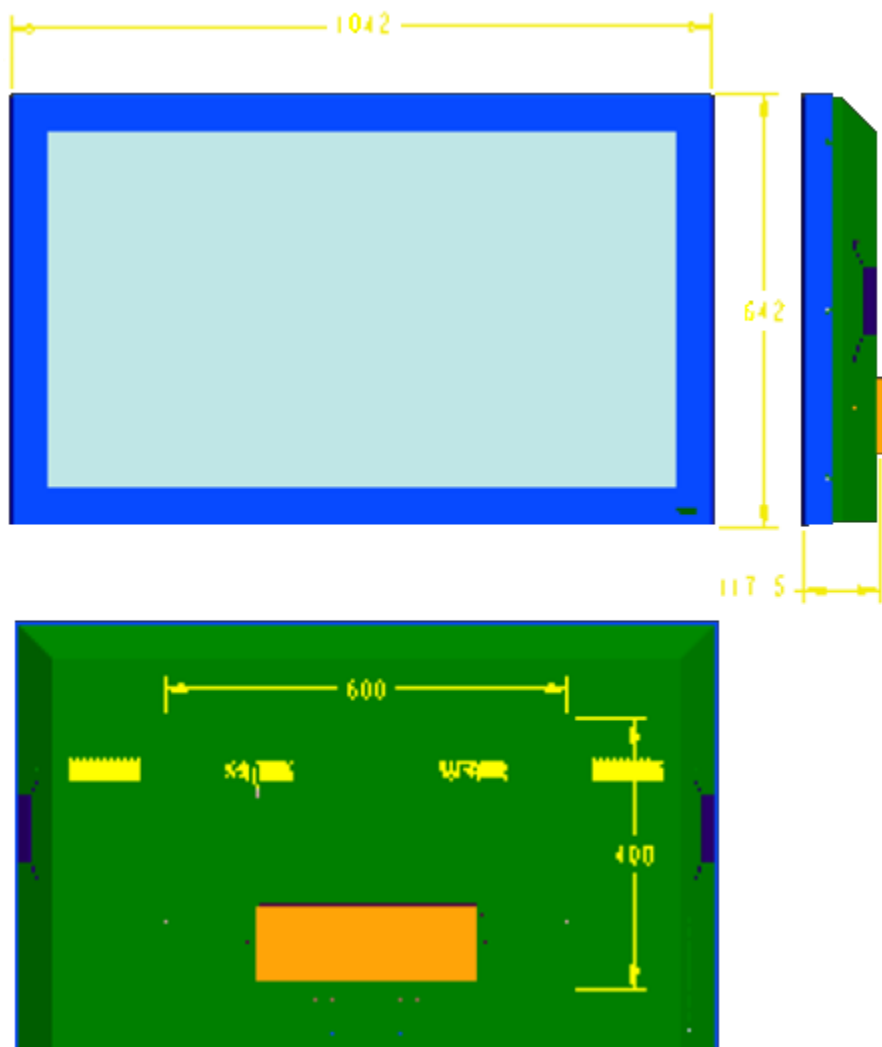

7.2 Climate Series LCD Dimensions

Figure 7-1. CP-42HD Dimensions (Front/Side/Rear)

Figure 7-2 shows the CP-52HD dimensions (all dimensions are in millimeters).

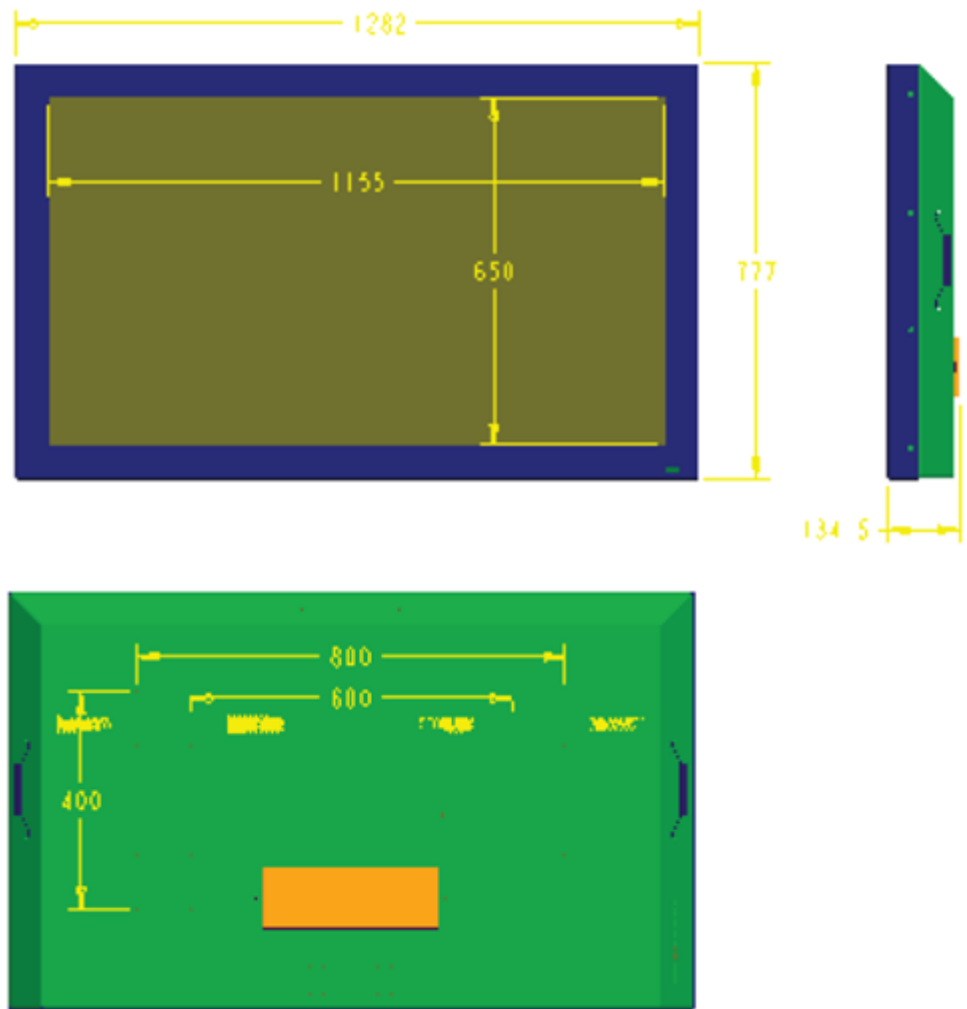

Figure 7-2. CP-52HD Dimensions (Front/Side/Rear)

Table 7-2 lists the signal types supported by each input on the Climate Portfolio Series LCD.

7.3 Supported Timings

Table 7-2. Supported Signal Timings by Input

Format	Resolution	Refresh Rate (Hz)	Horizontal Frequency (kHz)	Pixel Frequency (MHz)	Supported? (√ = Yes, - = No)			
					RGB	Component 1 Component 2	HDMI 1 HDMI 2	Composite S-Video
640x480	640x480	60.00	31.469	25.175	√	-	√	-
		72.00	37.861	31.500	√	-	√	-
		75.00	37.500	31.500	√	-	√	-
		85.00	43.269	36.000	-	-	-	-
800x600	800x600	60.00	37.879	40.000	√	-	√	-
		72.00	48.077	50.000	√	-	√	-
		75.00	46.875	49.500	√	-	√	-
		85.00	53.674	56.250	-	-	-	-
1024x768	1024x768	60.00	48.363	65.000	√	-	√	-
		70.00	56.476	75.000	√	-	√	-
		75.00	60.023	78.750	√	-	√	-
		85.00	68.677	94.500	-	-	-	-
1152x864	1152x864	75.00	67.500	108.000	-	-	-	-
1280x768	1280x768	60.00	47.700	68.250	√	-	√	-
		60.00	47.776	79.500	√	-	√	-
		75.00	60.289	102.250	√	-	√	-
		85.00	68.633	117.500	-	-	-	-
1280x960	1280x960	60.00	60.000	108.000	-	-	-	-
		85.00	85.938	148.500	-	-	-	-
1280x1024	1280x1024	75.00	79.976	135.000	√	-	√	-
1366x768	1366x768	60.00	47.720	84.750	√	-	√	-
1400x1050	1400x1050	60.00	64.700	101.000	√	-	√	-
		60.00	65.317	121.750	√	-	√	-
		75.00	82.300	156.000	-	-	-	-
1600x1200	1600x1200	60.00	75.000	162.000	√	-	√	-
1920x1200	1920x1200	60.00	74.000	154.000	√	-	√	-

Table 7-2. Supported Signal Timings by Input (continued)

Format	Resolution	Refresh Rate (Hz)	Horizontal Frequency (kHz)	Pixel Frequency (MHz)	Supported? (√ = Yes, - = No)			
					RGB	Component 1 Component 2	HDMI 1 HDMI 2	Composite S-Video
480/60i	720x487	60.00	15.734	13.500	√	√	√	√
480/60p	720x483	60.00	31.469	27.000	√	√	√	-
576/50i	720x576	50.00	15.625	13.500	√	√	√	-
576/50p	720x576	50.00	31.250	74.250	√	√	√	-
720/50p	1280x720	50.00	37.500	74.250	√	√	√	-
720/60p	1280x720	60.00	45.000	74.250	√	√	√	-
1080/24i	1920x1080	24.00	26.997	74.250	√	√	√	-
1080/25i	1920x1080	25.00	28.125	74.250	√	√	√	-
1080/30i	1920x1080	30.00	33.749	74.250	√	√	√	-
1080/24p	1920x1080	24.00	26.990	74.250	-	-	√	-
1080/25p	1920x1080	25.00	28.200	74.250	√	√	√	-
1080/30p	1920x1080	30.00	33.750	74.250	√	√	√	-
NTSC 3.58	-	60.00	15.734	3.580	-	-	-	√
NTSC 4.43	-	60.00	15.734	4.430	-	-	-	√
PAL	702x574	50.00	15.625	13.500	√	√	√	√
SECAM	-	50.00	15.625	13.500	-	-	-	√



SERIAL NUMBER
020-1065-00 Rev. B
January 2011

Free Manuals Download Website

<http://myh66.com>

<http://usermanuals.us>

<http://www.somanuals.com>

<http://www.4manuals.cc>

<http://www.manual-lib.com>

<http://www.404manual.com>

<http://www.luxmanual.com>

<http://aubethermostatmanual.com>

Golf course search by state

<http://golfingnear.com>

Email search by domain

<http://emailbydomain.com>

Auto manuals search

<http://auto.somanuals.com>

TV manuals search

<http://tv.somanuals.com>