



---

**OWNER'S OPERATING MANUAL**

---

# PlasmaWall™

## **PL-50XA PL-61DHD**

**Flat Panel Plasma Display Monitor  
with  
Widevision™  
and  
Digital High Definition™ Controller  
with Vivix II™ Technology**



**THE WORLD'S FINEST HOME THEATER PRODUCTS™**



---

# THREE YEAR LIMITED WARRANTY

## For Plasma Displays

Congratulations on your purchase of a Runco video product and welcome to the Runco family! We believe Runco produces "The World's Finest Home Theater Products." With proper installation, setup and care, you should enjoy many years of unparalleled video performance.

This is a LIMITED WARRANTY as defined in the Magnuson-Moss Warranty Act. Please read it carefully and retain it with your other important documents.

### WHAT IS COVERED UNDER THE TERMS OF THIS LIMITED WARRANTY:

**SERVICE LABOR:** Runco will pay for service labor by Runco Authorized Service Center when needed as a result of a manufacturing defect for a period of three (3) years from the effective date of delivery to the end user (excluding the plasma glass panel).

**PARTS** (not including plasma glass panel): Runco will provide new or rebuilt replacement parts for the parts that fail due to defects in materials or workmanship for a period of three (3) years from the effective date of delivery to the end user. Such replacement parts are then subsequently warranted for the remaining portion (if any) of the original warranty period.

**PLASMA GLASS PANEL:** Runco will pay for service labor by a Runco Authorized Service Center when needed as a result of a manufacturing defect for a period of one (1) year from the effective date of delivery to the end user. In addition, Runco will provide new or rebuilt replacement parts for the parts that fail due to defects in materials or workmanship for a period of one (1) year from the effective date of delivery to the end user. Such replacement parts are then subsequently warranted for the remaining portion (if any) of the original warranty period.

### WHAT IS NOT COVERED UNDER THE TERMS OF THIS LIMITED WARRANTY:

Image burn-in on plasma display panels is specifically excluded from coverage under this Limited Warranty. Image burn-in is the result of misuse of the product and therefore cannot be repaired under the terms of this Limited Warranty.

Normal viewing material such as television/satellite broadcasts, videotape or DVDs (not put into pause for extended periods of time) will not cause damage to your display under normal conditions. Many DVD players are also equipped with screen savers for this reason.

**TO AVOID IMAGE RETENTION (Burn-in):** Please ensure that still images are left on your plasma display panel for no more than a few minutes. Also ensure that images displayed in the 4:3 aspect ratio mode (black or gray stripes, but no picture information is present on the left and right edges of the screen) are used as infrequently as possible. This will prevent permanent image burns on your plasma display panel, which can be seen permanently under certain conditions once burn-in has occurred.

The types of images to avoid include video games, still images and computer screens with stationary tool bars and icons. (This is why computers are equipped with screen savers – to prevent still images from burning into the monitor's phosphors after being displayed continuously for an extended period of time).

This Limited Warranty only covers failure due to defects in materials and workmanship that occur during normal use and does not cover normal maintenance. This Limited Warranty does not cover cabinets or any appearance items; failure resulting from accident, misuse, abuse, neglect, mishandling, misapplication, faulty or improper installation or setup adjustments; improper maintenance, alteration, improper use of any input signal; damage due to lightning or power line surges, spikes and brownouts; damage that occurs during shipping or transit; or damage that is attributed to acts of God. In the case of remote control units, damage resulting from leaking, old, damaged or improper batteries is also excluded from coverage under this Limited Warranty.

---

CAUTION: THIS LIMITED WARRANTY ONLY COVERS RUNCO PRODUCTS PURCHASED FROM RUNCO AUTHORIZED DEALERS. ALL OTHER PRODUCTS ARE SPECIFICALLY EXCLUDED FROM COVERAGE UNDER THIS LIMITED WARRANTY. MOREOVER, DAMAGE RESULTING DIRECTLY OR INDIRECTLY FROM IMPROPER INSTALLATION OR SETUP IS SPECIFICALLY EXCLUDED FROM COVERAGE UNDER THIS LIMITED WARRANTY.

### **RIGHTS, LIMITS AND EXCLUSIONS:**

Runco limits its obligations under any implied warranties under state laws to a period not to exceed the warranty period. There are no express warranties. Runco also excludes any obligation on its part for incidental or consequential damages related to the failure of this product to function properly. Some states do not allow limitations on how long an implied warranty lasts, and some states do not allow the exclusion or limitation of incidental or consequential damages. So the above limitations or exclusions may not apply to you. This warranty gives you specific legal rights, and you may also have other rights that vary from state to state.

### **EFFECTIVE WARRANTY DATE:**

This warranty begins on the effective date of delivery to the end user. For your convenience, keep the original bill of sale as evidence of the purchase date.

### **IMPORTANT -- WARRANTY REGISTRATION:**

Please fill out and mail your warranty registration card. It is imperative that Runco knows how to reach you promptly if we should discover a safety problem or product update for which you must be notified.

### **CONTACT A RUNCO AUTHORIZED SERVICE CENTER TO OBTAIN SERVICE:**

Repairs made under the terms of this Limited Warranty covering your Runco video product will be performed at the location of the product, during usual working hours, providing location of product is within normal operating distance from a Runco Authorized Service Center. In some instances it may be necessary for the product to be returned to the Runco factory for repairs. If, solely in Runco's judgment, location of product to be repaired is beyond normal operating distance of the closest Runco Authorized Service Center, or the repair requires the unit be returned to the Runco factory, it is the owner's responsibility to arrange for shipment of the product for repair. These arrangements must be made through the selling Runco Dealer. If this is not possible, contact Runco directly for a Return Authorization number and shipping instructions. Runco will return product transportation prepaid in the United States, unless no product defect is discovered. In that instance, shipping costs will be the responsibility of the owner.

### **COPYRIGHT AND TRADEMARKS:**

© Copyright 2005 Runco International. This document contains proprietary information protected by copyright. All rights are reserved. No part of this manual may be reproduced by any mechanical, electronic or other means, in any form, without prior written permission of the manufacturer.

All trademarks and registered trademarks are the property of their respective owners.

---

**ADDITIONAL INFORMATION:**

To locate the name and address of the nearest Runco Authorized Service Center, or for additional information about this Limited Warranty, please call or write:

**RUNCO INTERNATIONAL, INC.**  
**Attn: Customer Service Department**  
**2900 Faber Street**  
**Union City, CA 94587**  
**Ph: (510) 324-7777**  
**Fax: (510) 324-9300**  
**Toll Free: (800) 23-RUNCO**

---

**RUNCO VIDEO-PRODUCT INFORMATION**  
**RETAIN THIS INFORMATION FOR YOUR RECORDS**

---

Model Purchased

---

Date

---

Serial Number

---

Runco Authorized Dealer Name

---

Address

---

City

---

State/Province

---

Postal Code

---

Phone

---

Fax

# Safety Precautions

Thank you for your purchase of this quality Runco product! It has been designed to provide you with the quality of video that is expected in a home theater. This manual is your guide through the menus and operation. For the best performance, please read it carefully and keep it handy for future reference.

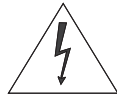
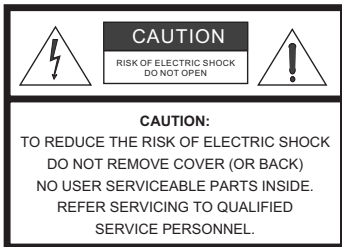

## WARNING

This symbol is intended to alert the user to the presence of uninsulated “dangerous voltage” within the product’s enclosure that may be of sufficient magnitude to constitute a risk of electric shock.

This symbol is intended to alert the user to the presence of important operating and maintenance (servicing) instructions in the literature accompanying the appliance.

## CAUTION

To turn off main power, be sure to remove the plugs from power outlets. The power outlet socket should be installed as near to the equipment as possible, and should be easily accessible.

## WARNING

TO PREVENT FIRE OR SHOCK HAZARDS, DO NOT EXPOSE THIS UNIT TO RAIN OR MOISTURE. ALSO DO NOT USE THIS UNIT’S POLARIZED PLUG WITH AN EXTENSION CORD RECEPTACLE OR OTHER OUTLETS, UNLESS THE PRONGS CAN BE FULLY INSERTED. REFRAIN FROM OPENING THE CABINET AS THERE ARE HIGH-VOLTAGE COMPONENTS INSIDE. REFER SERVICING TO QUALIFIED SERVICE PERSONNEL.

## WARNING

This equipment has been tested and found to comply with the limits for a Class ‘B’ digital device, pursuant to Part 15 of FCC Rules. These limits are designed to provide reasonable protection against harmful interference when the equipment is operated in a commercial environment. This equipment generates, uses, and can radiate radio frequency energy and, if not installed and used in accordance with the Installation Manual, may cause harmful interference to radio communications. Operation of this equipment in a residential area may cause harmful interference, in which case the user will be required to correct the interference at his own expense.

## DOC Compliance Notice

This Class B digital apparatus meets all requirements of the Canadian Interference-Causing Equipment Regulations.

Please read and follow the safety precautions listed below to ensure the equipment is free from damage, and to ensure that no injury will occur as a result of improper use.

- Do not insert any object, especially metal or liquids, into the plasma display.
- Do not place any objects containing water or any other liquid on top of the plasma display.
- Do not place the units in direct sunlight, near heaters or in extremely dusty or humid locations.
- Do not install this system outdoors or otherwise exposed to the elements.
- Do not place heavy objects on top of the plasma display.
- If the power cord is damaged or frayed in any way, electrical shock and/or fire may result. Do not place objects on the power cord, and keep the cord away from heat-emitting devices. Should the power cord become damaged in any way, please contact your Runco Dealer for a replacement cord.
- Do not remove the cover of the plasma display for any reason. If any problems arise with the unit, please contact a Runco Dealer or Runco International for service. Removing the covers will void the warranty.

# Table of Contents

<b>THREE YEAR LIMITED WARRANTY .....</b>	<b>iii</b>
<b>Safety Precautions .....</b>	<b>vi</b>
<b>1. Introduction .....</b>	<b>1</b>
About This Manual .....	1
Target Audience .....	1
If You Have Comments About This Manual.....	1
Textual and Graphic Conventions .....	1
Using This Manual .....	2
Description, Features and Benefits .....	3
Key Features and Benefits .....	3
Parts List .....	4
<b>2. Controls and Functions .....</b>	<b>5</b>
PlasmaWall at a Glance .....	5
Controls and Indicators.....	5
Connectors .....	6
DHD Controller Front Panel .....	8
DHD Controller Rear Panel .....	10
Outputs .....	10
Inputs .....	10
DHD Controller Remote Control .....	12
<b>3. Installation .....</b>	<b>15</b>
Remote Control .....	15
Notes on Batteries.....	15
Notes on Remote Control Operation.....	15
Quick Setup .....	17
Installation Considerations .....	18
Mounting the PlasmaWall on a Wall or Table Stand .....	18
Ambient Light .....	18
Ventilation.....	19
Other Considerations.....	19

---

Connections to the PlasmaWall and DHD Controller .....	20
Connecting the PlasmaWall to the DHD Controller.....	20
Connecting Source Components to the DHD Controller .....	22
RS-232 Controller Connection .....	26
Connecting 12-Volt Trigger Outputs to External Theater Components .....	26
Cable Management .....	27
<b>4. Operation .....</b>	<b>29</b>
Turning on the Power .....	29
Changing the OSD Language .....	30
Setting the PC Display Properties .....	30
Using the On-Screen Menus .....	31
Main Menu .....	33
Input Source .....	33
Aspect Ratio .....	33
Picture .....	35
Input Position.....	38
ISF Presets .....	39
Information .....	39
Calibration .....	39
Service .....	41
<b>5. Maintenance and Troubleshooting .....</b>	<b>45</b>
Troubleshooting Tips .....	45
<b>6. Serial Communications .....</b>	<b>47</b>
RS-232 Connection and Port Configuration .....	47
Serial Command Syntax .....	47
<b>7. Specifications .....</b>	<b>51</b>
PlasmaWall Specifications .....	51
DHD Controller Specifications .....	52
PlasmaWall Dimensions .....	53
Computer/Video Signal Compatibility .....	55



# List of Figures

---

2-1. PlasmaWall Controls and Indicators .....	5
2-2. PlasmaWall Connectors .....	6
2-3. DHD Controller Front Panel .....	8
2-4. DHD Controller Rear Panel .....	10
2-5. DHD Controller Remote Control .....	12
3-1. Available Range of the Remote Control .....	15
3-2. Ventilation Requirements for Enclosure Mounting .....	19
3-3. Connecting the PlasmaWall to the DHD Controller .....	20
3-4. RS-232 Connection from the DHD Controller to the PlasmaWall .....	21
3-5. DVI Source Connections .....	22
3-6. Digital (DTV) RGB Connections.....	23
3-7. Analog RGB Connections.....	24
3-8. Composite, S-Video and Component Video Connections.....	25
3-9. RS-232 Control System Connection.....	26
3-10. Connecting 12-Volt Trigger Outputs .....	26
3-11. Installing the Cable Clamps .....	27
4-1. Attaching the Ferrite Cores to the Power Cable .....	29
4-2. DHD Controller OSD Menu Structure for PlasmaWall.....	32
4-3. Typical PLUGE Pattern for Adjusting Brightness .....	35
4-4. Typical Gray Bar Pattern for Adjusting Contrast .....	36
4-5. Typical Color Bar Pattern for Adjusting Color Saturation and Tint.....	37
4-6. Typical Test Pattern for Adjusting Sharpness .....	38
7-1. PlasmaWall Model PL-50XA Dimensions .....	53
7-2. PlasmaWall Model PL-61DHD Dimensions .....	54



# 1. Introduction

---

This Owner's Manual describes how to install, set up and operate the Runco PlasmaWall Flat-Panel Plasma Display Monitor and DHD Controller (Models PL-50XA and PL-61DHD). Throughout this manual, the Runco PlasmaWall Flat-Panel Plasma Display Monitor is referred to simply as the "PlasmaWall."

Runco has prepared this manual to help home theater installers and end users get the most out of the PlasmaWall.

Runco has made every effort to ensure that this manual is accurate as of the date it was printed. However, because of ongoing product improvements and customer feedback, it may require updating from time to time. You can always find the latest version of this and other Runco product manuals on-line, at [www.runco.com](http://www.runco.com).

Runco welcomes your comments about this manual. Send them to [techpub@runco.com](mailto:techpub@runco.com).

**Text Conventions:** The following conventions are used in this manual, in order to clarify the information and instructions provided:

- Remote control button identifiers are set in upper-case bold type; for example, "Press **EXIT** to return to the previous menu."
- All keys with functional names are initial-capped, set in bold type and enclosed in angle brackets. These keys are the following: **<Return>**, **<Spacebar>**, **<Control>**, **<Esc>** and **<Tab>**.
- **<Return>** indicates that you may press either the RETURN or ENTER key on your computer keyboard if it has both keys.
- Computer input (commands you type) and output (responses that appear on-screen) is shown in monospace (fixed-width) type; for example: "To change the aspect ratio to Anamorphic, type ANAMORPHIC **<Return>**."

In addition to these conventions, underlining, boldface and/or italics are occasionally used to highlight important information, as in this example:



**Note**

*A carriage return **must** be used after each command or string.*

---

## 1.1 About This Manual

### ◀ Target Audience

### ◀ If You Have Comments About This Manual...

### ◀ Textual and Graphic Conventions

**Graphic Conventions:** These symbols appear in numerous places throughout the manual, to emphasize points that you must keep in mind to avoid problems with your equipment or injury:



**Tip**

*TIPS highlight time-saving short cuts and helpful guidelines for using certain features.*



**Note**

*NOTES emphasize text with unusual importance or special significance. They also provide supplemental information.*



**Caution**

*CAUTIONS alert users that a given action or omitted action can degrade performance or cause a malfunction.*



**WARNING**

*WARNINGS appear when a given action or omitted action can result in damage to the equipment, or possible non-fatal injury to the user.*



**DANGER!**

*DANGER appears when a given action can cause severe injury or death.*

## 1.2 Using This Manual

Use the following table to locate the specific information you need in this manual.

<b>If you need...</b>	<b>... Turn to page:</b>
Information about obtaining service	iv
General information about the PlasmaWall Flat-Panel Plasma Display Monitor and DHD Controller	3
Installation instructions	15
First-time configuration instructions	30
Advanced configuration instructions	39
Troubleshooting tips	45
Specifications for the PlasmaWall Flat-Panel Plasma Display Monitor and DHD Controller	51

---

The PlasmaWall™ is large enough to be used as the centerpiece of any home theater, yet slim enough (less than five inches) to be used in any type of room environment. Its size is only one of its advantages. It also has HDTV resolution of 1365 x 768, is bright enough to be used in any lighting situation, and can be mounted on a wall or placed on a tabletop.

The PlasmaWall is supplied with Runco's next-generation, all-digital DHD Controller, featuring advanced Vivix II™ processing. This controller produces stunning video imagery, elevating even standard NTSC material to near high-definition levels.

Multiple aspect ratio control includes Runco's VirtualWide™ for viewing 4:3 material in widescreen with no loss of picture quality. The DHD provides for a pure digital signal path from input to output, making this system ready for Runco's exclusive LiveLink™ DVI cable solution to preserve HD signal quality over long runs.

The PlasmaWall has been skillfully engineered for the finest video performance at altitudes of up to 9,000 feet. The advanced design features both RS-232C and IR control interfaces to accommodate custom installation and everyday operation with ease.

The PlasmaWall offers these key features and benefits:

- Native Resolution: 1365 x 768 (16:9 Native Aspect Ratio)
- Screen Size (diagonal): PL-50XA = 50 inches; PL-61DHD = 61 inches
- Multiple Aspect Ratios with VirtualWide™ Mode
- Less than five inches deep
- Dual HDMI Inputs with High-bandwidth Digital Content Protection (HDCP)
- HDTV Compatible
- Exceptional detail and artifact-free video enhancement
- Vivix™ video processing with 3:2 film detection circuitry

---

## **1.3 Description, Features and Benefits**

### **◀ Key Features and Benefits**

**Parts List** ➤ Your PlasmaWall is shipped with the following items. If any items are missing or damaged, please contact your Runco dealer or Runco Customer Service at (800) 23-RUNCO.

- PlasmaWall Flat-Panel Plasma Display Monitor and DHD Controller
- AC Power Cords (2)
- Remote Control Unit and two (2), AAA-size batteries
- Warranty information and registration card
- Runco PlasmaWall Owner's Operating Manual (this document)
- Ferrite cores (2)
- Cable Clamps
- Safety metal fittings
- Screws for safety metal fittings



**Note**

*Use the safety fittings to fasten the PlasmaWall to a wall when using the optional tablestand. This prevents tipping due to external shock. Use the supplied screws to fasten the safety fittings to the holes in the back of the plasma.*

**Optional Accessories:**

- Wall Mount Kit
- Table Stand

## 2. Controls and Functions

Figure 2-1 and Figure 2-2 show the locations of the PlasmaWall controls, indicators and connectors.

### 2.1 PlasmaWall at a Glance

#### ← Controls and Indicators

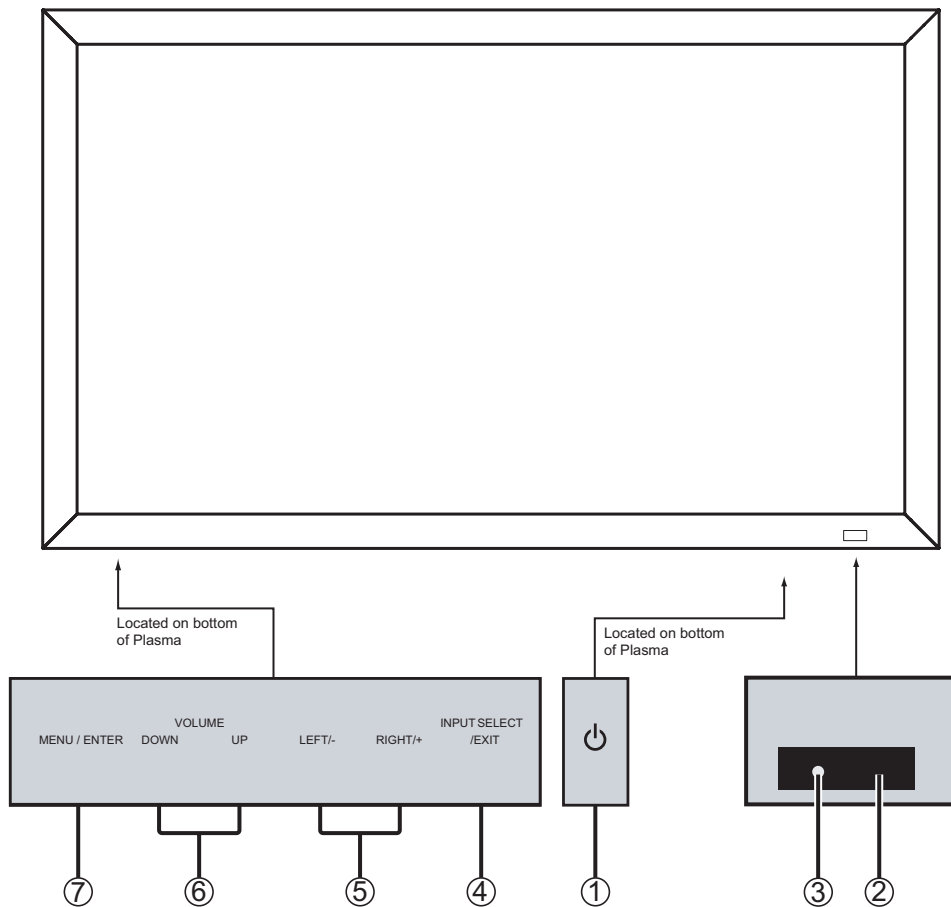

**Figure 2-1. PlasmaWall Controls and Indicators**

- 1. POWER BUTTON**  
Turns the monitor's power on and off.
- 2. REMOTE CONTROL SENSOR**  
Receives the signals from the remote control.
- 3. POWER/STANDBY INDICATOR**
  - Lights red to indicate that the PlasmaWall is in standby mode;
  - Lights green to indicate normal operation;
  - Flashes red to indicate that the internal temperature is too high.

4. **INPUT SELECT/EXIT**  
Not used with this model. Use the DHD Controller to select an input source.
5. **LEFT/- and RIGHT/+**  
Not used with this model.
6. **VOLUME DOWN and UP**  
Not used with this model.
7. **MENU/ENTER**  
Not used with this model. Use the DHD Controller to access the on-screen menus.



**WARNING**

*The Power on/off switch does not disconnect the plasma display completely from the supply mains.*

**Connectors** ➤

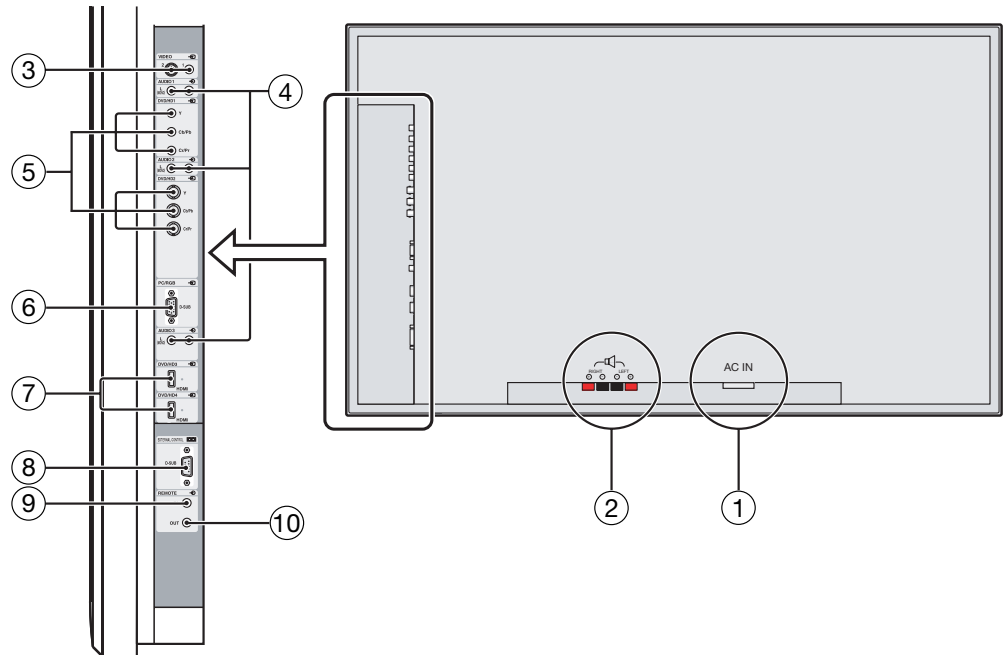

**Figure 2-2. PlasmaWall Connectors**



- 
1. **POWER INPUT (100 to 240 VAC)**  
Connect the PlasmaWall to power here, using the included power cord.
  2. **EXTERNAL SPEAKER OUTPUTS**  
Not used. Connect speakers to an external audio amplifier/receiver.
  3. **VIDEO1, 2 (RCA, S-Video)**  
Not used. Connect all video sources to the DHD Controller.
  4. **AUDIO1, AUDIO2, AUDIO3**  
Not used with this model. Connect the audio outputs from your sources to an external audio receiver.
  5. **DVD/HD1  
DVD/HD2**  
Not used. Connect all video sources to the DHD Controller.
  6. **PC/RGB (15-pin D-Sub)**  
Connect the RGBHV (5xBNC) output from the DHD Controller here.
  7. **DVD/HD3, DVD/HD4 (HDMI)**  
HDCP-compliant digital video inputs. Connect the DVI output from the DHD Controller to the DVD/HD3 input. (DVD/HD4 is not used.)
  8. **EXTERNAL CONTROL (9-pin, male D-Sub)**  
A male, 9-pin D-sub connector. Connect the RS-232 OUT port on the DHD Controller to this input.
  9. **REMOTE IN (3.5-mm mini phone jack, tip/ring/sleeve)**  
Wired input from an external remote control or infrared (IR) receiver.
  10. **REMOTE OUT (3.5-mm mini phone jack, tip/ring/sleeve)**  
Wired output to the REMOTE IN jack of another device; allows you to control both the PlasmaWall and the other device using the same wired remote control.

## 2.2 DHD Controller Front Panel

Figure 2-3 shows the controls and indicators on the DHD Controller front panel; the paragraphs that follow describe them.

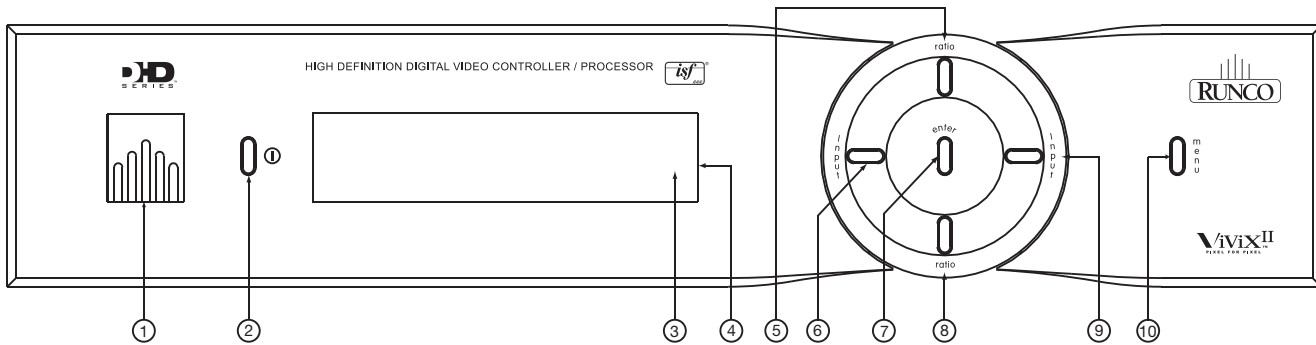

Figure 2-3. DHD Controller Front Panel

1. **RUNCO ICON**  
Lights red to indicate that the DHD Controller is in standby mode; lights blue to indicate that the unit is on.
2. **POWER BUTTON**  
Press once to toggle from standby mode to on mode. Press it again to return to standby mode. For a discrete on or off command, you can use the direct access buttons on the remote control.
3. **IR SENSOR**  
Receives IR commands from the remote.
4. **VACUUM FLUORESCENT DISPLAY**  
Can be used instead of the On-Screen Display (OSD). Displays currently-selected menu or -- if no menu is selected -- the current source, signal format (NTSC or PAL), input resolution and aspect ratio.

---

**5. UP BUTTON**

Use to direct-select aspect ratios or move the menu cursor up in the On-Screen Display. When no menus are present on-screen, the **UP** button toggles you through aspect ratios in the following order:

Anamorphic - Standard (4:3) - Letterbox - VirtualWide - Cinema

(For more information about aspect ratios, refer to Table 4-1.)

**6. LEFT BUTTON**

Used to direct select inputs or move the menu cursor left in the On Screen Display. When no menu is present on-screen, the **LEFT** button toggles you through the different sources, in this order:

HD Pass Thru 2 - HD Pass Thru 1 - DVI 2 - DVI 1 - HD/RGB2 - HD/RGB1 - Component SD - S-Video 2 - S-Video 1 - Composite

**7. ENTER BUTTON**

When an item is highlighted on the On-Screen Display, the **ENTER** button selects the item.

**8. DOWN BUTTON**

Use to direct select aspect ratios or move the menu cursor down in the On-Screen Display. When no menu is present on-screen, this button toggles you through the different aspect ratios, in this order:

Cinema - VirtualWide - Letterbox - Standard (4:3) - Anamorphic

**9. RIGHT BUTTON**

Used to direct select inputs or move the menu cursor right in the On Screen Display. When no menus are present on-screen, the **RIGHT** button toggles you through the different sources, in this order:

Composite - S-Video 1 - S-Video 2 - Component SD - HD/RGB 1 - HD/RGB 2 - DVI 1 - DVI 2 - HD Pass Thru 1 - HD Pass Thru 2

**10. MENU BUTTON**

Pressing the **MENU** button brings up the main menu. Also, if you are in an adjustment mode or function, pressing **MENU** brings the menu back one level.

## 2.3 DHD Controller Rear Panel

Figure 2-4 shows the rear connector panel on the DHD Controller.

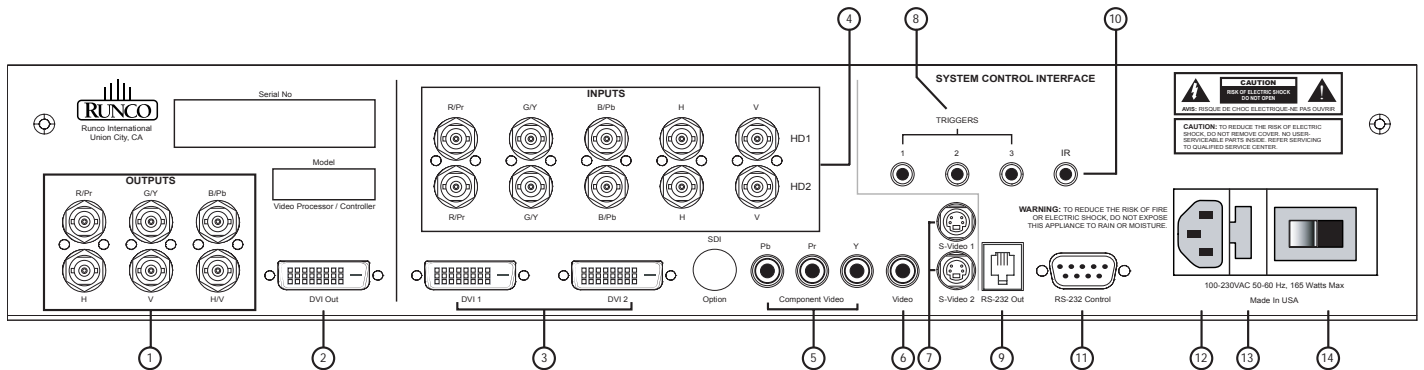

Figure 2-4. DHD Controller Rear Panel

- Outputs** ➤
- 1. ANALOG OUTPUTS (RGBHV)**  
Connect these to the PC/RGB input of the PlasmaWall, using a DB15HD-to-5 x BNC breakout cable.
  - 2. DVI OUT**  
Connect this to the DVD/HD3 input on the PlasmaWall, using a DVI-to-HDMI cable.
- Inputs** ➤
- 3. DVI 1 / DVI 2 (Digital)**  
Two, HDCP-compliant digital video inputs for connecting a DVD player or HD tuner with a DVI or HDMI output.
  - 4. HD1 / HD2 (Analog BNC connectors)**  
Five, BNC connectors for connecting either RGB or component high-definition television signals. The PlasmaWall automatically detects the signal format: RGB(HV) or YPrPb, 480p, 720p, 480i, 576i or 1080i.
  - 5. COMPONENT VIDEO (RCA connectors)**  
Standard Definition (480i/576i) Component (YPrPb) input. This is the input for component video from sources such as DVD players.



**Tip**

*For best results, do not run your DVD player in progressive mode.*

- 
6. **COMPOSITE VIDEO INPUT**  
Standard composite video input for connecting a VCR, camcorder, laser disc player or other composite video source.
  7. **S-VIDEO 1 / S-VIDEO 2**  
Two, standard S-Video inputs for connecting a DVD player, satellite receiver or Super VHS (S-VHS) VCR.
  8. **12-VOLT (800 mA) TRIGGER OUTPUTS**  
Connection for up to three (3), 12-volt trigger-controlled devices.
  9. **RS-232 OUTPUT (6-Wire, RJ-11 jack)**  
Connect this to the EXTERNAL CONTROL input of the PlasmaWall.
  10. **IR**  
Wired input from an external remote control or infrared receiver. It is a 3.5-mm, mini phono jack, wired as follows:  
Ring = +5V  
Tip = IR Input  
Sleeve = Ground

**Note**

*When an external remote control or infrared receiver is connected to the wired IR input, the IR sensor on the front of the DHD Controller is disabled.*

11. **RS-232 CONTROL PORT**  
A female, 9-pin D-sub connector for interfacing with a PC or home theater automation/control system.
12. **POWER INPUT (100 to 240 VAC)**  
Connect the DHD Controller to power here.
13. **MAIN AC FUSE**  
This is the main AC input fuse (5mm x 20mm, 500 mA, 250V slow-blow).
14. **MAIN POWER SWITCH**  
Disconnects or applies power to the DHD Controller.

## 2.4 DHD Controller Remote Control

Figure 2-5 shows the DHD Controller remote control, and the paragraphs that follow describe its functionality.

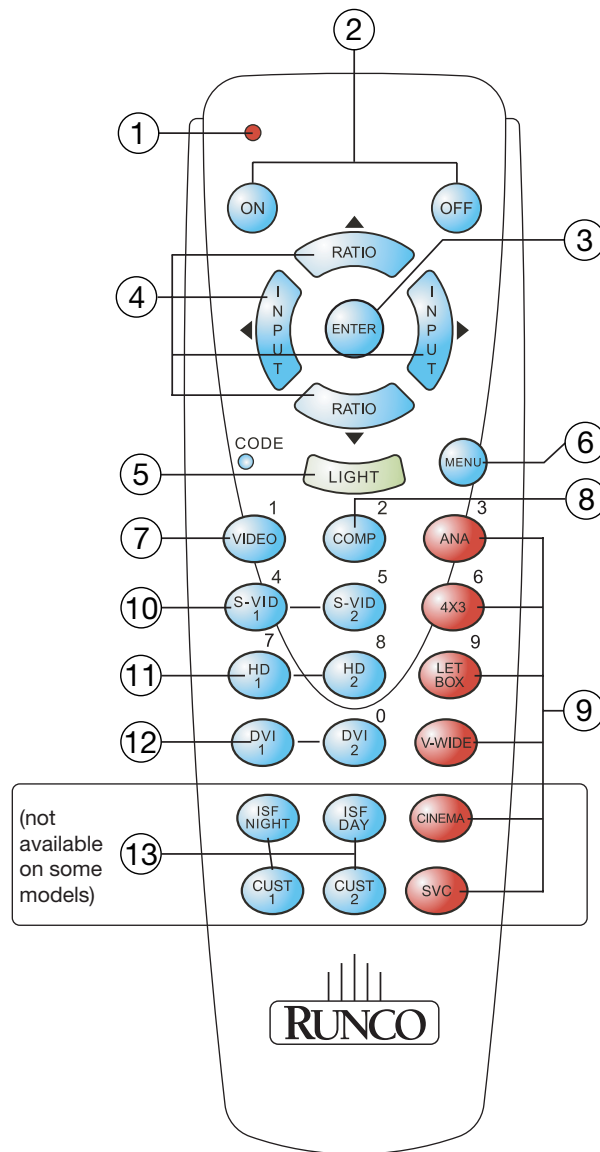

Figure 2-5. DHD Controller Remote Control

- 
1. **IR OUTPUT INDICATOR**  
Lights when a button is pressed to indicate that an IR signal is being transmitted.
  2. **ON / OFF**  
Press to turn the PlasmaWall on or off.
  3. **ENTER**  
Press to select a highlighted menu item or confirm a changed setting.
  4. **Cursor Keys (▲, ◀, ▼, ▶)**  
Use these buttons to select items or settings, adjust settings or switch display patterns.

When no menus are present on-screen, the **UP** and **DOWN** buttons toggle through the available aspect ratios, in this order:

**UP** Button = Anamorphic - Standard (4:3) - Letterbox - VirtualWide - Cinema

**DOWN** Button = Cinema - VirtualWide - Letterbox - Standard (4:3) - Anamorphic

Likewise, the **LEFT** and **RIGHT** buttons toggle through the different source inputs, in this order:

**LEFT** Button = HD Pass Thru 2 - HD Pass Thru 1 - DVI 2 - DVI 1 - HD/RGB2 - HD/RGB 1 - Component SD - S-Video 2 - S-Video 1 - Composite

**RIGHT** Button = Composite - S-Video 1 - S-Video 2 - Component SD - HD/RGB 1 - HD/RGB 2 - DVI 1 - DVI 2 - HD Pass Thru 1 - HD Pass Thru 2

5. **LIGHT**  
Press to illuminate the buttons. (Not available on all models.)
6. **MENU**  
Press this button to access the OSD controls, or to exit the current menu and return to the previous one.
7. **VIDEO (1)**  
Press to select Composite video input as the source or to enter the numeric character "1."
8. **COMP (Component) (2)**  
Press to select Component SD (480i/576i) video input as the source or to enter the numeric character "2."

9. **Aspect Ratio Selection Buttons**

Use the red buttons to select an aspect ratio directly or to enter numeric characters, as follows:

**ANA (Anamorphic) (3)**

For viewing 16:9 DVDs or HDTV programs in their native aspect ratio.

**4X3 (Standard 4:3) (6)**

Scales the input signal to fit 4:3 display mode in the center of the screen.

**LETBOX (Letterbox) (9)**

For viewing LaserDisc movies or non-anamorphic DVDs on a 4:3 screen.

**V-WIDE (VirtualWide)**

Enlarges a 4:3 image horizontally in a NON-linear fashion to fit 16:9 full screen display.

**CINEMA**

For viewing 2.35:1 source material on a 1.78:1 (16:9) screen. The upper and lower portions are masked.

**SVC**

Not used.

10. **S-VID 1 (4) / S-VID 2 (5) (S-Video)**

Press to select an S-Video input or to enter the numeric character "4" or "5."

11. **HD 1 (7) / HD 2 (8)**

Press to select a HD (RGBHV or YPbPr component) input or to enter the numeric character "7" or "8."

12. **DVI 1 / DVI 2 (0)**

Press to select a Digital Video input. Press **DVI2** to enter the numeric character "0."

13. **Memory Preset Buttons:**

**ISF NT (Night)**

Press to recall settings for the current input from the "ISF Night" memory preset.

**ISF DAY**

Press to recall settings for the current input from the "ISF Day" memory preset.

**CUST 1**

Press to recall settings for the current input from the "Custom 1" memory preset.

**CUST 2**

Press to recall settings for the current input from the "Custom 2" memory preset.



# 3. Installation

To install batteries in the remote control:

1. Press down the tab on the cover and pull the cover in the direction of the arrow.
2. Insert the included batteries. Ensure that the polarities correctly match the  $\oplus$  and  $\ominus$  markings inside the battery compartment.
3. Insert the lower tab of the cover into the opening, and press down the cover until it clicks in place.

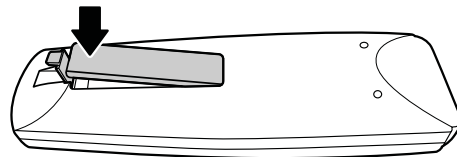
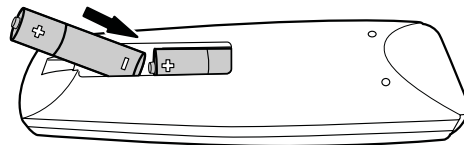
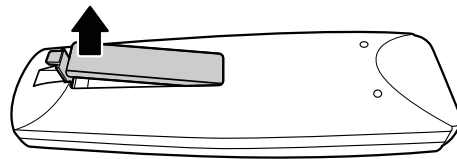

## 3.1 Remote Control

- When installing batteries, make sure that the battery polarities are correct.
- Do not mix an old battery with a new one or different types of batteries.
- If you will not use the remote control for a long time, remove the batteries to avoid damage from battery leakage.

### ◀ Notes on Batteries

The remote control can be used to control the PlasmaWall within the ranges shown in Figure 3-1.

### ◀ Notes on Remote Control Operation

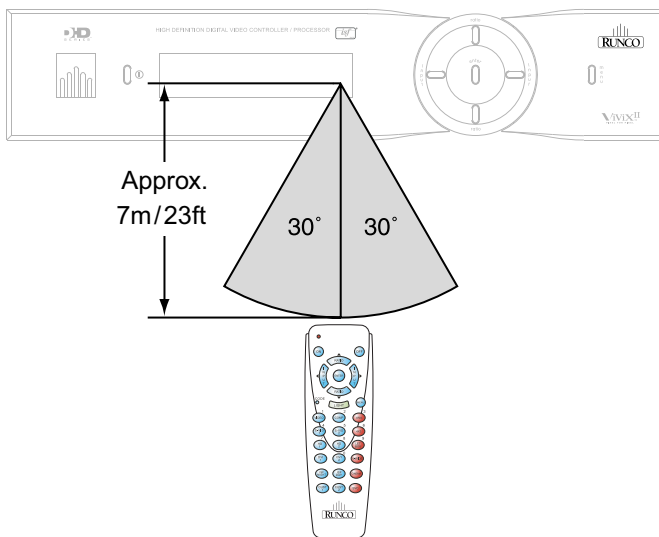

**Figure 3-1. Available Range of the Remote Control**

- Do not drop the remote control or expose it to moisture or high temperature.
- The remote control may malfunction under a fluorescent lamp. If that occurs, move the plasma display away from the fluorescent lamp.
- Make sure that there is nothing obstructing the infrared beam between the remote control and the IR receiver on the plasma display.



**Note**

*The signal from the remote control can be reflected by walls or other surfaces.*

- If the effective range of the remote control decreases, or it stops working, replace the batteries with new ones.
- Ambient conditions may possibly impede the operation of the remote control. If this happens, point the remote control at the plasma display and repeat the operation.

Table 3-1 gives a quick overview of the PlasmaWall installation process. The sections following this one provide detailed instructions.

## 3.2 Quick Setup



### Note

*Installation should be performed by a qualified custom video installation specialist.*

**Table 3-1. Installation Overview**

Step	Procedure	For Details, refer to page...
1	Mount the PlasmaWall on a wall or table stand	18
2	Connect the DHD Controller to the PlasmaWall	20
2	Connect signal sources to the DHD Controller	22
3	Connect external controller to DHD Controller RS-232 port (optional)	26
4	Apply power to the PlasmaWall	29
5	Change the OSD language	30
6	If using the PlasmaWall with a PC, adjust PC display properties	30
7	Display calibration: adjust the following <b>for each input</b> , starting with Component SD; save settings when finished: <ul style="list-style-type: none"> <li>• Aspect ratio</li> <li>• Brightness</li> <li>• Contrast</li> <li>• Color level</li> <li>• Tint</li> <li>• Sharpness</li> </ul>	33 through 39

### 3.3 Installation Considerations

#### **Mounting the PlasmaWall on a Wall or Table Stand** ➤

Proper installation of your PlasmaWall will ensure the highest possible picture quality. Whether you are installing the PlasmaWall temporarily or permanently, you should take the following into account to ensure that it performs optimally.

To install the PlasmaWall, you will need either an optional table stand or wall-mounting kit. The PlasmaWall cannot be installed on its own.

If you do decide to wall-mount the PlasmaWall, ensure that the wall-mount bracket is installed according to the instructions included with it. The wall must be capable of supporting a redundant weight factor three (3) times the weight of the display, or be reinforced.

Runco recommends that this be done by a custom installation specialist.



**Note**

*Use only a Runco-approved wall-mount kit or table stand that is specifically designed for your display.*

You can attach your optional mounts or stand to the PlasmaWall in either of two ways:

- While it is upright.

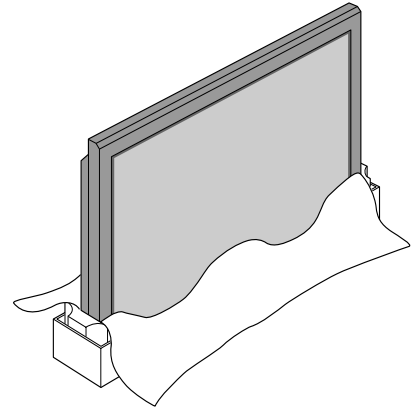

- As it lies flat with the screen face down. Place the protective sheet, which was wrapped around the plasma monitor when it was packaged, between the screen and your work surface to avoid scratching or otherwise damaging the screen surface.

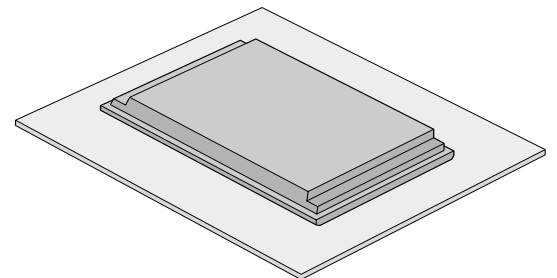

#### **Ambient Light** ➤

In general, minimize or eliminate light sources directed at the display. Contrast ratio in your images will be noticeably reduced if light directly strikes the display, such as when a shaft of light from a window or floodlight falls on the image. Images may then appear washed out and less vibrant.

If you are mounting the PlasmaWall in an enclosure, leave at least 2 inches (50 mm) of space on all sides between it and surrounding objects, as shown in Figure 3-2. This allows heat to disperse, maintaining the proper operating temperature.

### ◀ Ventilation

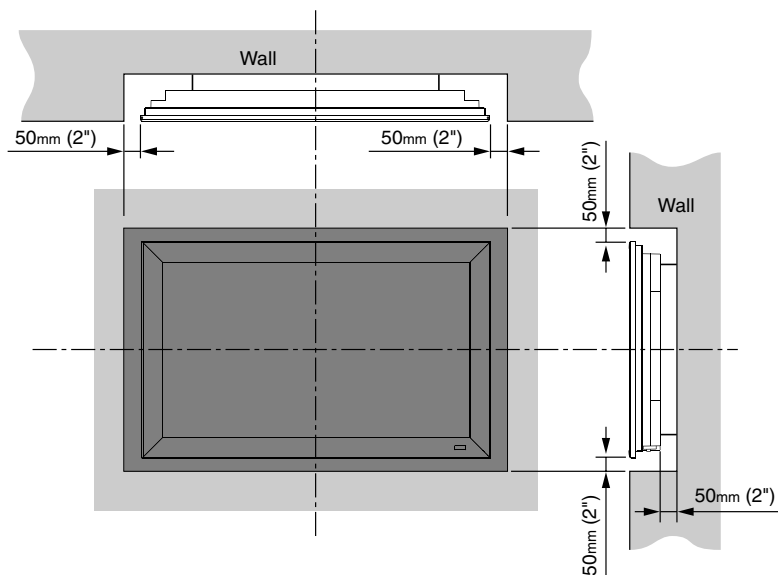

**Figure 3-2. Ventilation Requirements for Enclosure Mounting**

Other considerations and tips that can help improve your installation, avoid damage and prolong operating life:

### ◀ Other Considerations

- Keep the ambient temperature constant and below 35°C (95°F). Keep the display away from heating and/or air conditioning vents. Changes in temperature may cause drifts in the display circuitry, which may affect performance.
- Keep the PlasmaWall away from devices that radiate electromagnetic energy such as motors and transformers. Common sources of these include slide projectors, speakers, power amplifiers and elevators.
- Handle the unit carefully when installing or carrying it. Use the built-in handles; DO NOT touch or hold the screen face.
- Set the unit away from heat, excessive dust, and direct sunlight.
- Protect the inside of the unit from liquids and small metal objects. In case of accident, unplug the power cord and have it serviced by an authorized Service Center.
- Do not hit or scratch the panel surface as this causes flaws on the surface of the screen.
- For correct installation and mounting it is strongly recommended to use a trained, authorized dealer.
- To avoid sulfurization, it is strongly recommended not to place the unit in a dressing room in a public bath or hot spring bath.

### 3.4 Connections to the PlasmaWall and DHD Controller

Proceed as follows to connect the PlasmaWall to the DHD Controller, your video sources, external controller(s) -- if present -- and AC power.

When connecting your equipment:

- Turn off all equipment before making any connections.
- Use the correct signal cables for each source.
- Ensure that the cables are securely connected. Tighten the thumbscrews on connectors that have them.
- Use the left audio input when connecting mono audio sources.

#### Connecting the PlasmaWall to the DHD Controller

Connect the DHD Controller to the PlasmaWall as shown in Figure 3-3 and described in the sections that follow.

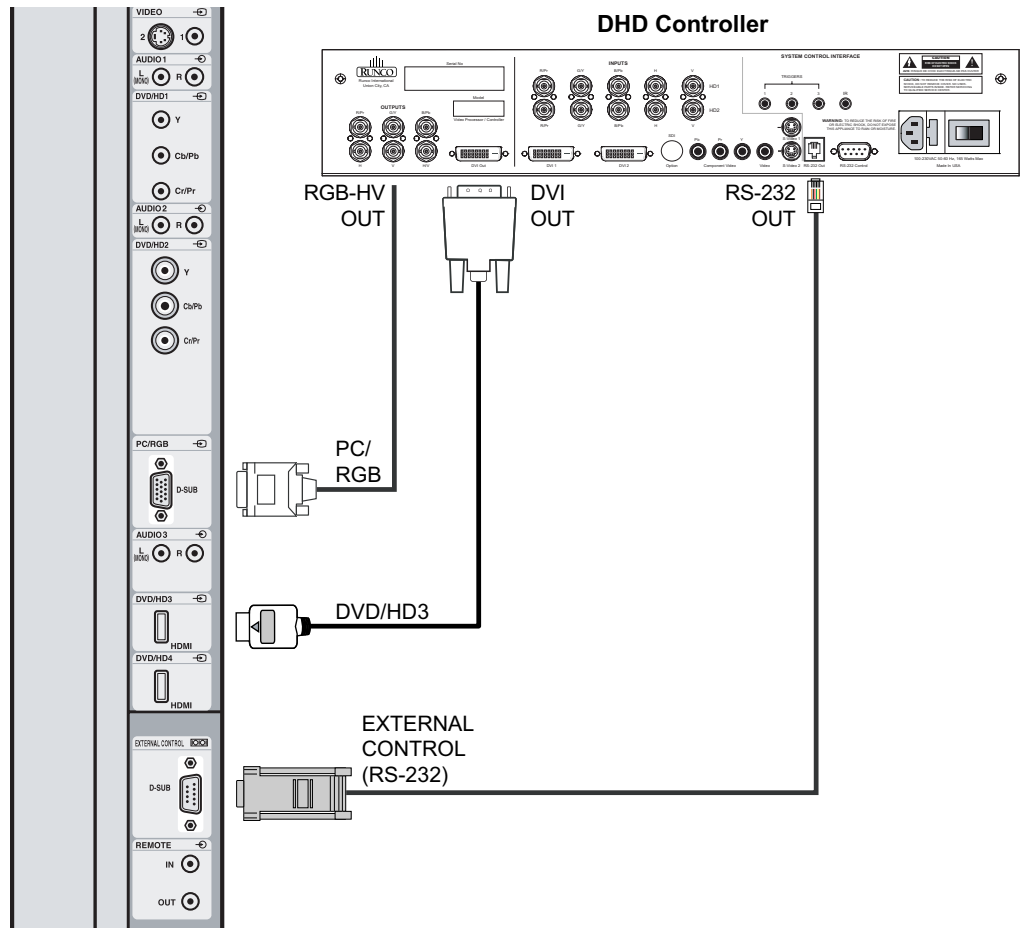

Figure 3-3. Connecting the PlasmaWall to the DHD Controller

**Digital Video Connection:** The PlasmaWall has two HDMI inputs. Connect the DVI output from the DHD Controller to the DVD/HD3 input, using a DVI-to-HDMI cable.

**RGB-HD Connection:** Connect the RGBHV output from the DHD Controller to the PC/RGB input on the PlasmaWall. Use a VGA-to-RGBHV breakout cable with 5 BNC connectors on the DHD end and a standard, 15-pin, male VGA connector on the PlasmaWall end.

**RS-232 (External Control) Connection:** Connect the RS-232 output from the DHD Controller to the EXTERNAL CONTROL input on the PlasmaWall. Use a standard, modular telephone cable with RJ11 plugs at both ends. On the PlasmaWall end, use an RJ11-to-DB9, crossover adapter wired as shown in Figure 3-4.

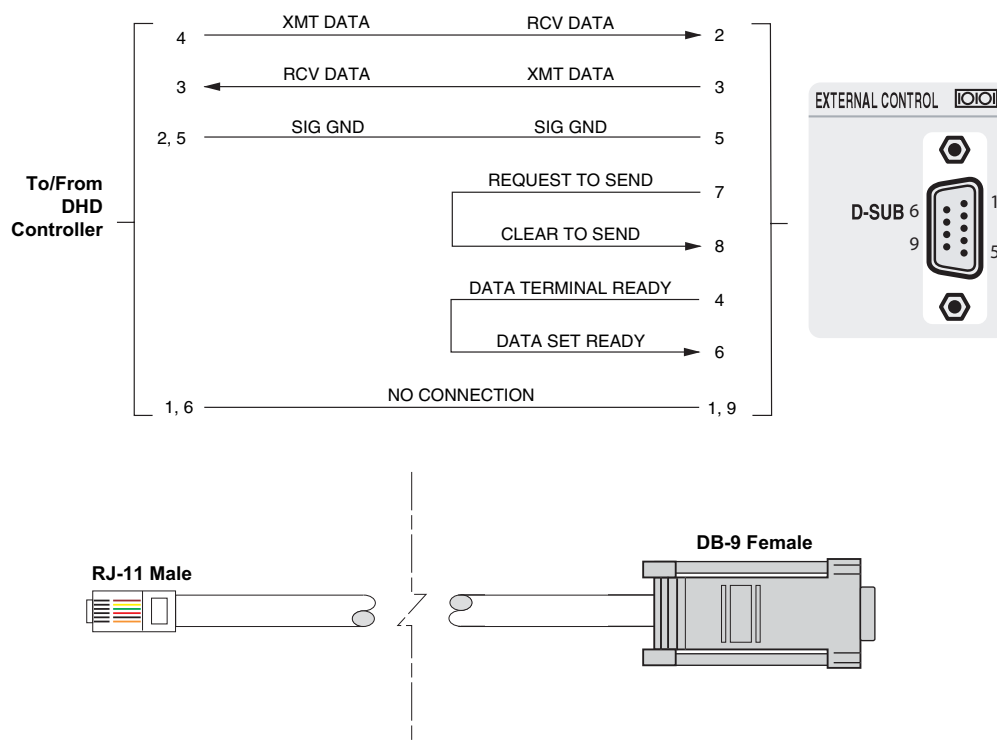

Figure 3-4. RS-232 Connection from the DHD Controller to the PlasmaWall

**Connecting Source Components to the DHD Controller**

Connect your video sources to the DHD Controller as shown and described in the sections that follow.

**DVI Connections:** See Figure 3-5.



**Tip**

Use the DVI inputs whenever possible. This ensures the highest video quality because the signal is carried in the digital domain throughout the entire signal path, from source component output into the display.

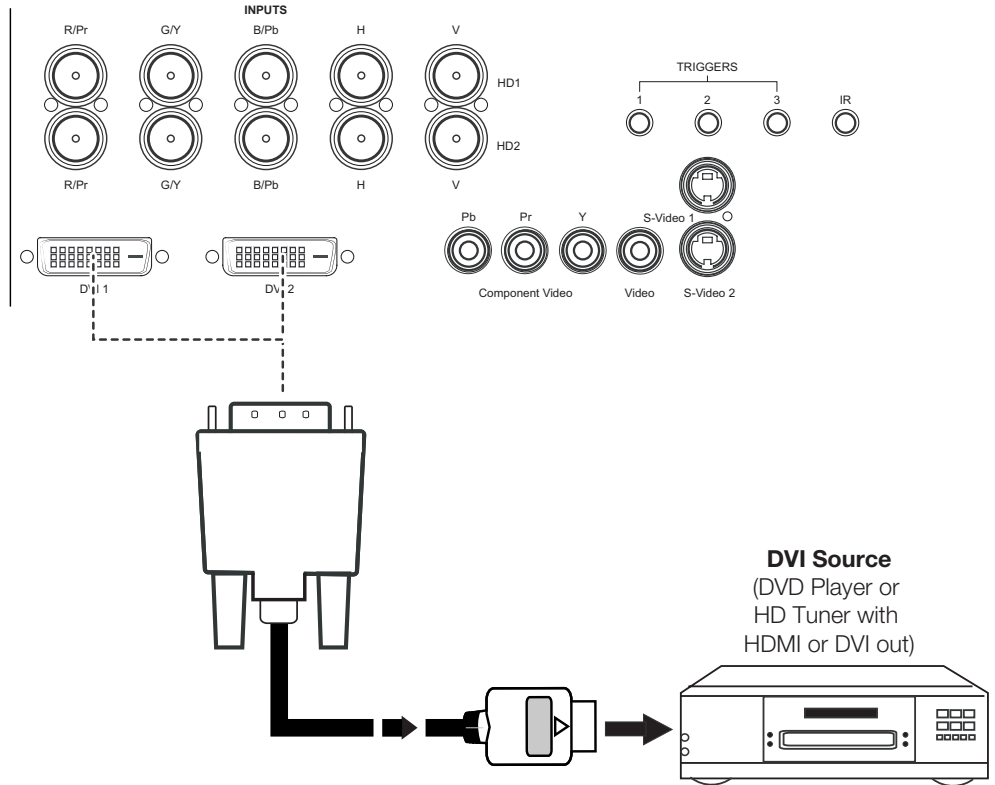

**Figure 3-5. DVI Source Connections**



**Digital (DTV) RGB Connections:** See Figure 3-6.

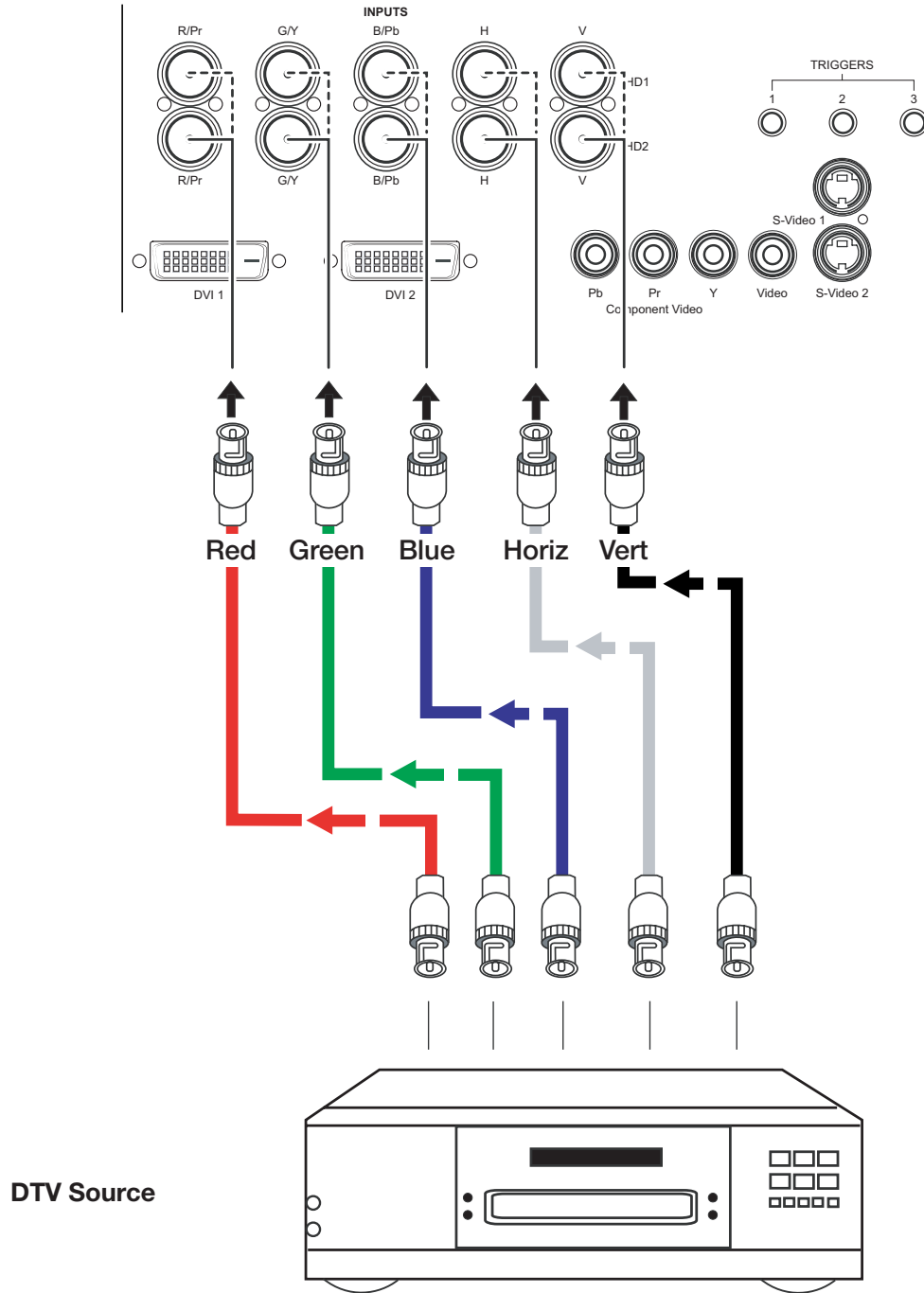

**Figure 3-6. Digital (DTV) RGB Connections**

**Analog (Computer) RGB Connections:** See Figure 3-7.



**Note**

1. Refer to **Computer/Video Signal Compatibility** on page 55 for a list of computer signals compatible with the PlasmaWall. Use with signals other than those listed may cause some functions not to work.
2. Some Macintosh computers may require a Macintosh video adapter. Contact your nearest authorized service center or dealer.

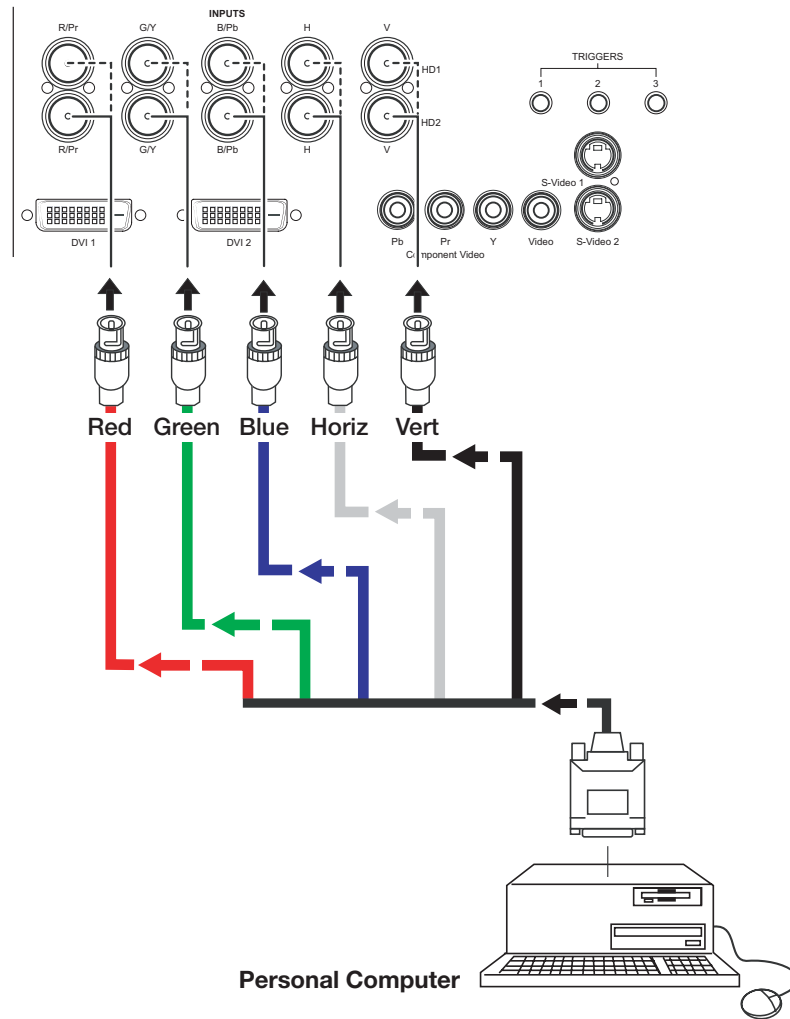

**Figure 3-7. Analog RGB Connections**

**Composite/S-Video/Component Video Connections:** See Figure 3-8.

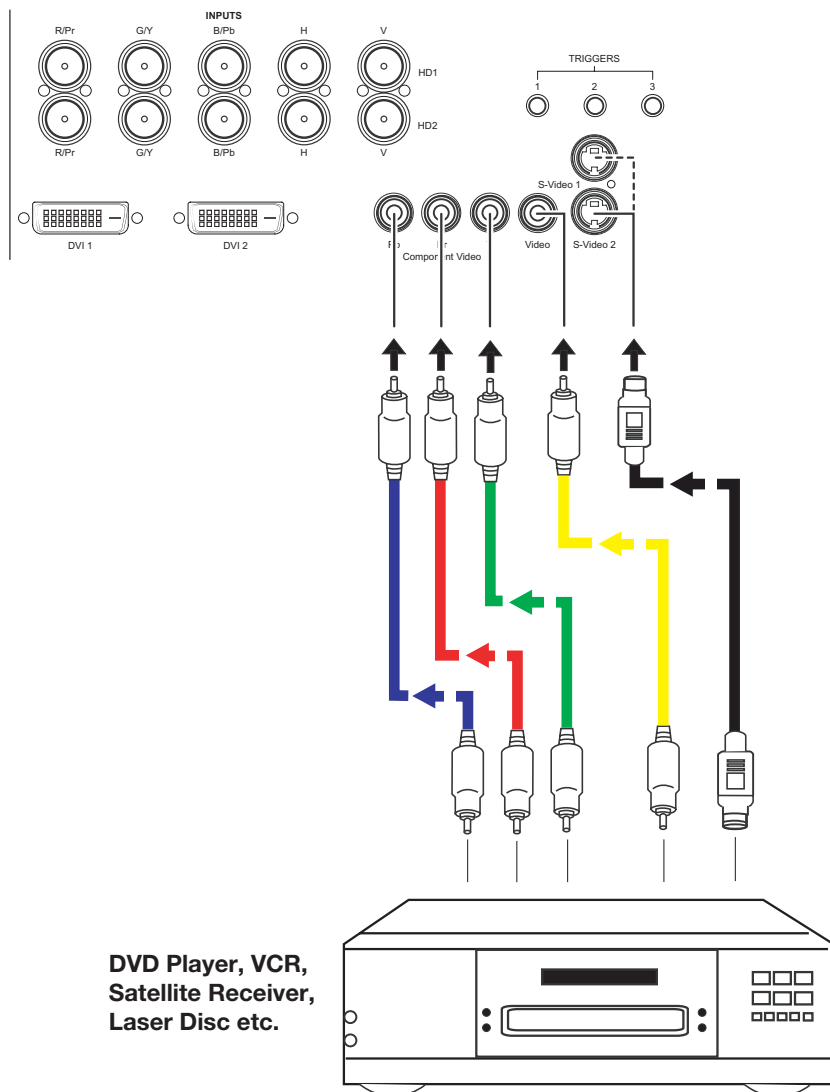
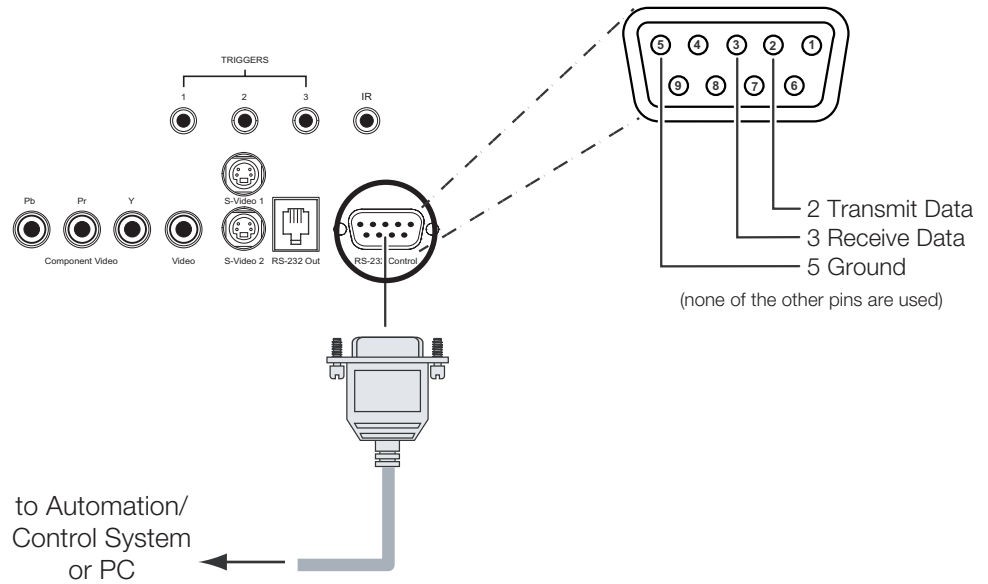

**Figure 3-8. Composite, S-Video and Component Video Connections**

**RS-232 Controller Connection**

Use a standard, 9-pin RS-232 cable to connect a PC or home theater control/automation system (if present) to the RS-232 Control port on the DHD Controller; see Figure 3-9.

For more information about using this connection, refer to **Serial Communications** on page 47.



**Figure 3-9. RS-232 Control System Connection**

**Connecting 12-Volt Trigger Outputs to External Theater Components**

If your home theater contains equipment that responds to 12-volt triggers, connect them to the 12-volt trigger outputs as shown in Figure 3-10.

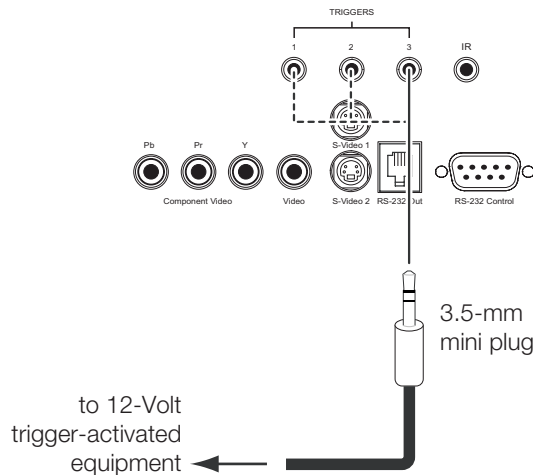

**Figure 3-10. Connecting 12-Volt Trigger Outputs**

To minimize cable clutter, use the cable clamps provided with the PlasmaWall to bundle the video, audio and control cables at the back of the display. Install the clamps as shown in Figure 3-11.

◀ **Cable Management**

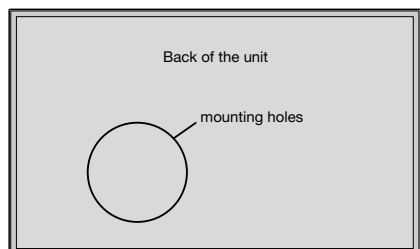

To attach

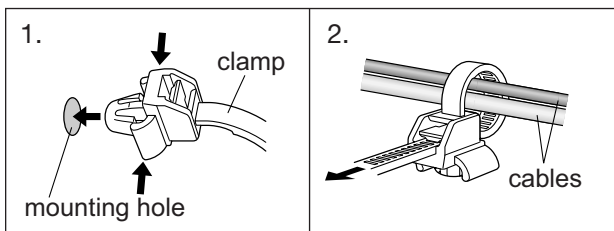

To detach

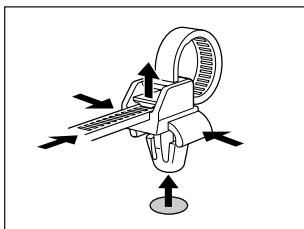
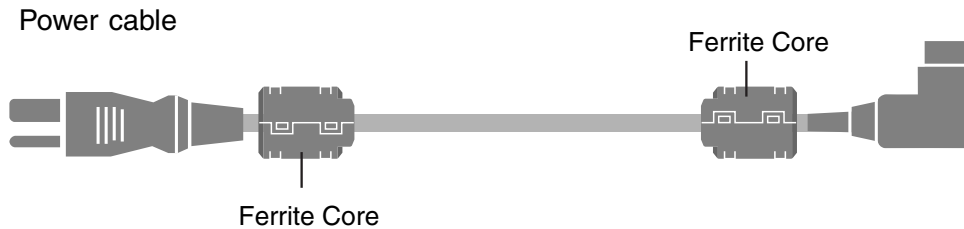

**Figure 3-11. Installing the Cable Clamps**

**Notes:**

# 4. Operation

1. Turn on your source components.
2. Attach the two ferrite cores supplied with the display to each end of the AC power cable as shown in Figure 4-1. Doing so will reduce radio frequency interference (RFI) emissions to a level that conforms to FCC regulations. Use the supplied plastic bands to secure the cores in place.



**Figure 4-1. Attaching the Ferrite Cores to the Power Cable**

3. Plug the female end of the power cord into the AC receptacle on the rear of the PlasmaWall (AC 100V ~ 240V). Connect the other end to your AC power source.
4. Similarly connect the DHD Controller to a nearby AC outlet.
5. Press the **POWER** button on the underside of the PlasmaWall. Its power indicator lights green.
6. Turn on the main power switch at the rear of the DHD Controller.
7. Press the **ON** button on the remote control to turn on the DHD Controller (or press the power button on the front of the DHD Controller). The power indicator on the DHD Controller lights solid blue.
8. After a brief warm-up period (approximately 10 seconds), the PlasmaWall will display an image.

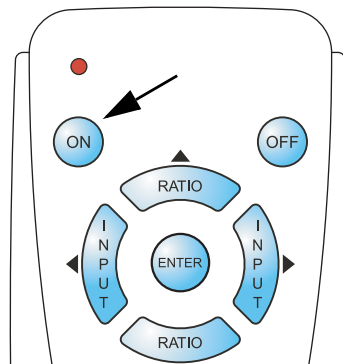

## 4.1 Turning on the Power

## 4.2 Changing the OSD Language

The PlasmaWall OSD language is initially set to English, but can also display the menus in French (Français), Spanish (Español) or German (Deutsch). To change the OSD language:

1. Press **MENU** and enter the Service menu passcode.
2. Press **MENU** again and select **Service** from the Main Menu.
3. Select **Language** from the Service Menu.
4. Press **▲** or **▼** to highlight the desired language and press **ENTER**. The change takes effect immediately.



**Note**

*You must enter a passcode to access the Service menu.*

## 4.3 Setting the PC Display Properties

To maximize image quality when using the PlasmaWall with a personal computer, you may need to adjust the display properties of your PC video card. To do this:

1. Choose Settings from the Windows Start menu and click on “Control Panel.”
2. Double click on the **Display** icon.
3. Click the **Settings** tab on the display dialog box.
4. Adjust the resolution to 1024x768 pixels.

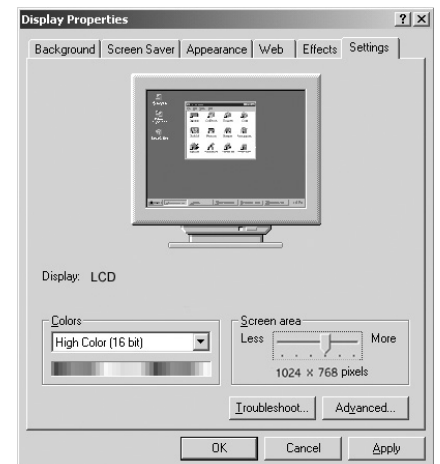

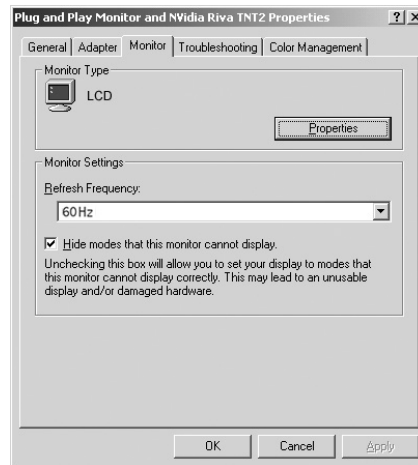

5. Click the **Advanced** button and click the **Monitor** tab on the dialog box. Set the vertical frequency to 60Hz and click **OK**.

**Note**

1. The native resolution of the PlasmaWall is 1365 x 768. Other horizontal or vertical resolutions may be scaled upward or downward to fit the display.
2. With most computers, you can get the best picture at 1024 x 768 @ 60Hz.
3. For best results when using a computer, set the input on the DHD Controller to HD Pass Thru 1 or HD Pass Thru 2, depending on which RGB/HD input you are using.
4. The PlasmaWall supports 36-bit color (68.7 billion possible colors).

**WARNING**

To prevent image retention (burn) on your display, **ALWAYS** use a screen saver and set it to the shortest possible time.

Press the **MENU** button on either the remote control or the DHD Controller front panel to display the Main Menu, shown below. To select a menu item, use the UP and DOWN buttons on either the remote control or the DHD Controller front panel to highlight it. Press **ENTER** to confirm your selection.

The PlasmaWall OSD menus are arranged hierarchically, as shown in Figure 4-2. Depending on the selected input source and signal characteristics, some menu options may not be available.

## 4.4 Using the On-Screen Menus

<b>Input Source</b>	Composite
	S-Video 1
	S-Video 2
	Component SD
	HD/RGB 1
	HD/RGB 2
	DVI 1
	DVI 2
<b>Aspect Ratio</b>	HD Pass Thru 1/ HD Pass Thru 2 (available only when Display Device Input Source = RGB)
	Anamorphic
	Standard 4:3
	Letterbox
	VirtualWide
<b>Picture</b>	Cinema
	Brightness
	Contrast
	Color
	Tint
<b>Input Position</b>	Sharpness
	Left/Right
	Up/Down
	Width
	Height
<b>ISF Presets</b>	Overscan
	Recall ISF Night
	Recall ISF Day
	Recall/Save Custom 1
	Recall/Save Custom 2
<b>Information</b> (read-only)	Reset to Factory Default
	Serial Number
	Hardware
	Firmware
	Date

<b>Calibration</b>	ISF Night - Display Color	Gain
		Offset
	ISF Night - Input Image	Brightness
		Contrast
		Color
		Tint
	ISF Night - Input Color	Sharpness
		Gain
		Offset
		Chroma Delay
		Phase
	ISF Day - Display Color	Noise Reduction (480i signals only)
		Gain
	ISF Day - Input Image	Offset
		Brightness
		Contrast
		Color
	ISF Day - Input Color	Tint
		Sharpness
		Gain
Offset		
Chroma Delay		
Output Shift	Phase	
	Noise Reduction (480i signals only)	
	Left/Right	
	Up/Down	
Splash Configure	Width	
	Height	
	Owner Name	
OSD Position	ISF Calibrated	
	ISF Other	

<b>Service</b>	Test Video	Grey Bars 1		
		Grey Bars 2		
		Color Bars 1		
		Color Bars 2		
	Language	English		
		French		
		German		
		Spanish		
	Remote Control	Primary		
		Secondary		
	Analog Out Mode	RGB--, RGB++ or RGBS		
	Display Device	Configure	Input Source	RGB or DVI/HDMI
			Noise Reduction	
			Inverse	
			Left/Right	
Up/Down				
Width				
Height				
HD Format	HD/RGB 1			
	HD/RGB 2			
Triggers	1 / 2 / 3			
Miscellaneous	Menu Mode			
	Timeout			
	Side Bar Color			
Resolution	Film Mode			
	800x600 ... 1400x1050			
System Reset	480i ... 720p ... 1080i			

Figure 4-2. DHD Controller OSD Menu Structure for PlasmaWall

The Main Menu is the starting point for accessing all display functions.

(The Calibration and Service menus are hidden and not accessible until you enter a passcode.)

◀ **Main Menu**

Runco Video
<b>Input Source</b>
Aspect Ratio
Picture
Input Position
ISF Presets
Information
Calibration
Service

From the Main Menu, select Input Source to choose a video signal source.

The active source is indicated by an arrow (>) to its left; in the example at left, Composite is the active source.

◀ **Input Source**

<b>Input Source</b>	
>	<b>Composite</b>
	S-Video 1
	S-Video 2
	Component SD
	HD/RGB 1
	HD/RGB 2
	DVI 1
	DVI 2
	HD Pass Thru 1
	HD Pass Thru 2



**Note**

1. HD Pass Thru 1 and HD Pass Thru 2 are available only when the Display Device Input Source is set to RGB (refer to **Display Device** on page 42).
2. Selecting HD Pass Thru 1 or HD Pass Thru 2 loops the HD/RGB 1 or HD/RGB 2 input signal respectively to the RGB output. This prevents display of the on-screen menus. To switch from HD Pass Thru 1 or 2 to another source, use the direct access buttons on the remote control, or the left- or right-arrow buttons on the DHD Controller.

To change the aspect ratio (size and shape) of the projected image, select Aspect Ratio from the Main Menu and press **ENTER**. Select the appropriate aspect ratio for your screen size and the type of program material being viewed; refer to Table 4-1.

The currently-selected aspect ratio is indicated by a "☒" to its left; in the example at right, Anamorphic is selected.

◀ **Aspect Ratio**



<b>Aspect Ratio</b>	
<input checked="" type="checkbox"/>	<b>Anamorphic</b>
<input type="checkbox"/>	Standard 4:3
<input type="checkbox"/>	Letterbox
<input type="checkbox"/>	VirtualWide
<input type="checkbox"/>	Cinema



**Note**

When you change the aspect ratio, save the change to a preset afterwards. Otherwise, the change will be lost when a different input is selected. (The aspect ratio is saved for each input and resolution separately.) For information about saving settings, refer to **ISF Presets** on page 39.

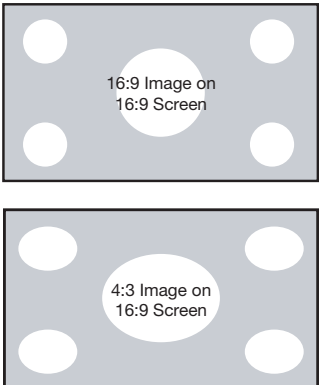
**Table 4-1. Aspect Ratio Settings**

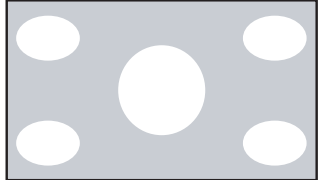
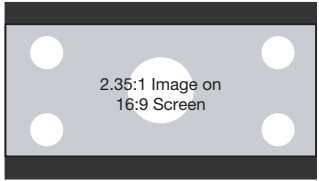
Aspect Ratio	Remote Control Key	Description	
Anamorphic	ANA	 <p>16:9 Image on 16:9 Screen</p> <p>4:3 Image on 16:9 Screen</p>	<p>Select Anamorphic to view 16:9 DVDs and HDTV programs in their native aspect ratio. 4:3 images are stretched horizontally to fit a 16:9 screen.</p>
Standard 4:3	4X3	 <p>Active Image Area (4:3)</p>	<p>Standard 4:3 scales the input signal to fit in the center of the 16:9 screen. 4:3 is the aspect ratio used by computer monitors, standard television programming and most VHS video cassettes.</p>
Letterbox	LET BOX	 <p>Letterbox Image on 16:9 Screen</p>	<p>In Letterbox mode, the image is stretched vertically; the top and bottom portions are “blanked off.” Letterbox is best suited for viewing LaserDisc movies or non-anamorphic DVDs on a 4:3 screen.</p>
VirtualWide	V-WIDE		<p>A 4:3 image is scaled NON-linearly (more on the sides than in the center) to fit a 16x9 screen.</p>
Cinema	CINEMA	 <p>2.35:1 Image on 16:9 Screen</p>	<p>Select Cinema to view 2.35 source material on a 16:9 screen. The upper and lower portions of the screen are masked, but the geometry of the active image area is not changed.</p>

Use the controls in the Picture Menu to calibrate your PlasmaWall for optimum picture quality.

The PlasmaWall has been designed to incorporate setup and calibration standards established by the Imaging Science Foundation (ISF). The ISF has developed carefully crafted, industry-recognized standards for optimal video performance and has implemented a training program for technicians and installers to use these standards to obtain optimal picture quality from Runco video display devices. Accordingly, Runco recommends that setup and calibration be performed by an ISF certified installation technician.

All signal types require separate processing. Therefore, you need to calibrate each input separately. Runco recommends calibrating the PlasmaWall inputs in the following order:

1. Component SD
2. S-Video 1 / S-Video 2
3. Composite
4. HD/RGB 1 / HD/RGB 2
5. DVI 1 / DVI 2

◀ **Picture**

Picture
Brightness
Contrast
Color
Tint
Sharpness



**Note**

*When you change a picture quality setting, save the change to a preset afterwards. Otherwise, the change will be lost when a different input is selected. (Picture quality settings are saved for each input and resolution separately.) For information about saving settings, refer to **ISF Presets** on page 39.*

Although it may be possible to obtain satisfactory picture quality using the naked eye and regular program material, Runco recommends using the following calibration tools for best results:

- External test pattern source -- Ovation Multimedia, Video Essentials or AVIA test DVD (or equivalent).
- A blue filter (provided with many test DVDs), for color level and tint adjustments.

Connect your test pattern source to the input that you are calibrating and proceed as follows. **Perform the adjustments in the order listed here.**

**Brightness:** On your external test pattern source, select a PLUGE pattern. (PLUGE is an acronym for "Picture Line-Up Generation Equipment.") Figure 4-3 shows a typical PLUGE pattern.

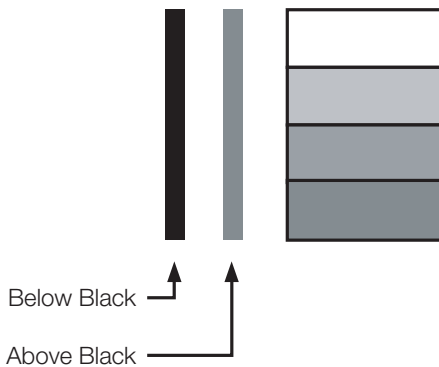

**Figure 4-3. Typical PLUGE Pattern for Adjusting Brightness**

PLUGE patterns vary but generally consist of some combination of black, white and gray areas against a black background. The example above includes two vertical bars and four shaded boxes.

Select Brightness from the Picture menu and press **ENTER**. Adjust the brightness so that:

- The darkest black bars disappear into the background.
- The dark gray areas are barely visible.
- The lighter gray areas are clearly visible.
- The white areas are a comfortable level of true white.
- The image contains only black, gray and white (no color).

**Contrast:** On your external test pattern source, select a stepped, gray-bar pattern like the one shown in Figure 4-4.



**Figure 4-4. Typical Gray Bar Pattern for Adjusting Contrast**

Select Contrast and press **ENTER**. Adjust the contrast to a point just below which the white rectangle starts to increase in size.



**Note**

*Brightness and contrast controls are interactive. A change to one may require a subtle change to the other in order to achieve the optimum setting.*

**Color Saturation:** On your external test pattern source, select a color bar pattern like the one shown in Figure 4-5.

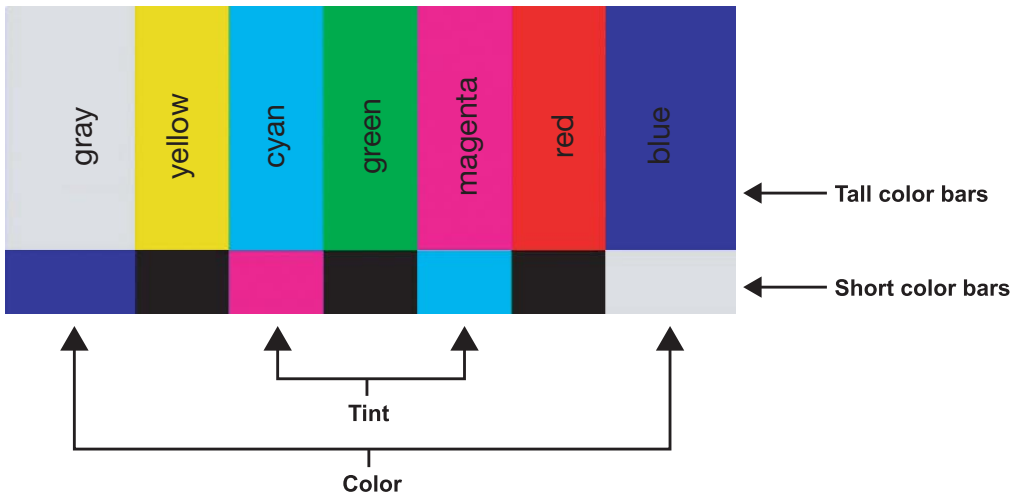

**Figure 4-5. Typical Color Bar Pattern for Adjusting Color Saturation and Tint**

Select Color and press **ENTER**. While looking at the color bar pattern through a blue filter, adjust the color saturation level until the outermost (gray and blue) color bars appear to be a single shade of blue:

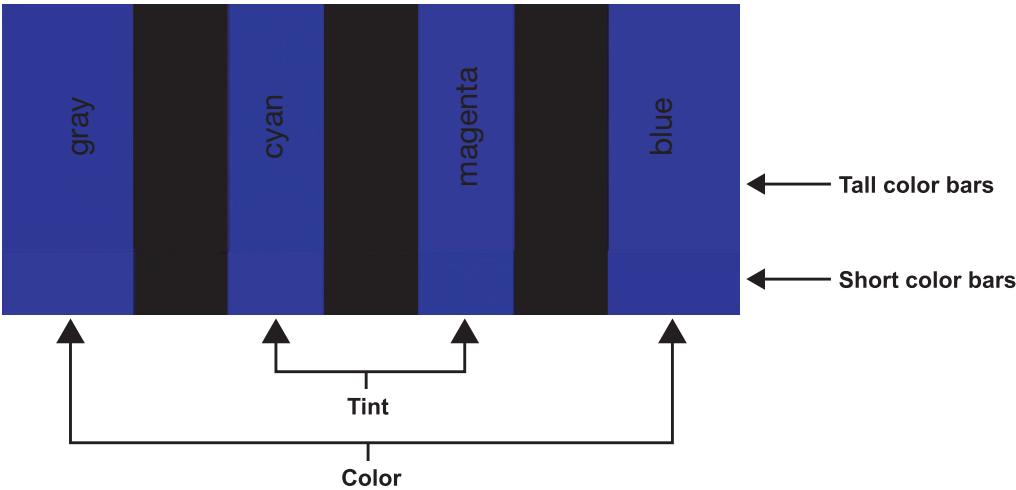

**Tint:** Tint or “hue” is essentially the ratio of red to green in the color portion of the image. When tint is decreased, the image appears redder; when it is increased the image appears greener. To set the tint, select Tint and press **ENTER**. While looking at the color bar pattern through a blue filter, adjust the tint level until the cyan and magenta color bars (on either side of the green bar) appear to be a single shade of blue.



**Note**

*Like the brightness and contrast controls, the color and tint controls are interactive. A change to one may require a subtle change to the other in order to achieve the optimum setting.*

**Sharpness:** “Sharpness” is the amount of high-frequency detail in the image. To adjust sharpness, select Sharpness from the Picture menu and press **ENTER**. On your external test pattern source, select a pattern like the one shown in Figure 4-6. Adjust as needed, looking for white edges around the transitions from black to gray and differently-sized lines in the “sweep” patterns at the top and bottom. Lower the sharpness setting to eliminate them.

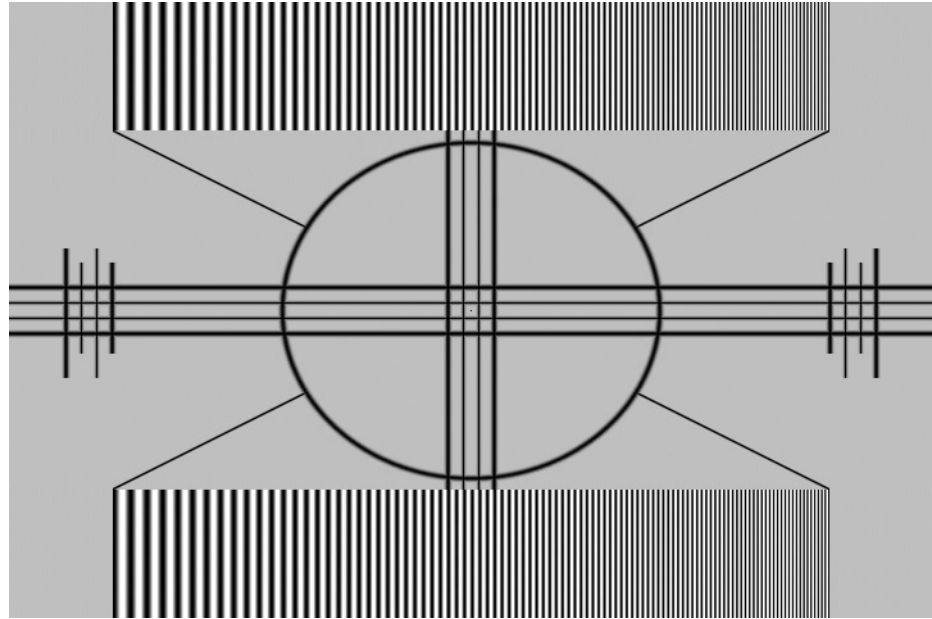

**Figure 4-6. Typical Test Pattern for Adjusting Sharpness**

**Input Position** ➤

Use the controls in the Input Position Menu to fine-tune the aspect ratio and image position for the current source.

Input Position
Left/Right
Up/Down
Width
Height
Overscan



**Note**

*When you change an input position setting, save the change to a preset afterwards. Otherwise, the change will be lost when a different input is selected. (The input position settings are saved for each input and resolution separately.) For information about saving settings, refer to **ISF Presets** on page 39.*

**Left/Right:** Select Left/Right from the Input Position menu to shift the projected image horizontally. Use the right or up cursor button to shift the image to the right; use the left or down button to shift it to the left.

**Up/Down:** Select Up/Down from the Input Position menu to shift the projected image vertically. Use the right or up cursor button to shift the image upward; use the left or down button to shift it downward.

**Width:** Select Width from the Input Position menu to change the projected image width. Use the right or up cursor button to increase the width; use the left or down button to decrease it.

**Height:** Select Height from the Input Position menu to change the projected image height. Use the right or up cursor button to increase the height; use the left or down button to decrease it.



**Overscan:** Image Overscan pushes the outside edge of the active picture area of the video signal out beyond the edge of the display area.

Some television programs are produced based on the assumption that older television sets may not display the outer edges of the broadcast picture area. Over scan effectively trims away these inactive, outer edges and enlarges the remaining portion of the image to fill the display area.

Select from 1% to 10% of Overscan, as desired.

For HDTV, DVDs and other video sources, Overscan is generally not necessary or desirable.

For each input, the PlasmaWall lets you save image quality settings as presets that you can recall at a later time. You can create up to four presets per input and resolution. Use the ISF Presets menu to recall saved image presets, or to save image settings in the “Custom 1” or “Custom 2” memory location. The currently-selected preset is indicated by a “☒” to its left; in the example shown here, ISF Night is selected.

You should save changes to any of the following settings to a preset; otherwise they will be lost when a new input source or resolution is selected:

- Aspect ratio
- Picture quality settings (brightness, contrast, color saturation, tint and sharpness)
- Input position (image position, width, height and overscan percentage)

To reset all image presets to their factory defaults, select Factory Default and press **ENTER**.

Select Information from the Main Menu to see information that uniquely identifies your display: its serial number, the installed hardware and firmware versions and the firmware version build date. Should you ever need to contact Runco Technical Support, this information will help them answer your questions or resolve product performance issues.

Use the Calibration menu to perform advanced picture quality adjustments. **This menu should be used by ISF-certified technicians only.**



**Note**

*You must enter a passcode to access the Calibration menu.*

The changes you make here take effect immediately; you do not need to save them. To recall the ISF Night or ISF Day settings, select “ISF Night” or “ISF Day” from the ISF Presets menu (see above).

◀ **ISF Presets**

ISF Presets	
<input checked="" type="checkbox"/>	<b>ISF Night</b>
<input type="checkbox"/>	<b>ISF Day</b>
<input type="checkbox"/>	<b>Custom 1 Save</b>
<input type="checkbox"/>	<b>Custom 2 Save</b>
<b>Factory Default</b>	

◀ **Information**

Information	
<b>Serial Number</b>	
<b>Hardware</b>	
<b>Firmware</b>	
<b>Date</b>	

◀ **Calibration**

Calibration	
<b>ISF Night</b>	
<b>Display Color</b>	
<b>Input Image</b>	
<b>Input Color</b>	
<b>ISF Day</b>	
<b>Display Color</b>	
<b>Input Image</b>	
<b>Input Color</b>	

**ISF Night - Display Color:** Use the Display Color settings to change the characteristics of the output signal. These settings are global (independent of any particular input).

- **Gain:** Use the Gain controls to correct color imbalances in the bright areas of the image. A good way to do this is to use a test pattern consisting mostly of solid white areas, such as an 80 IRE “window” pattern. If the white areas contain traces of red, green or blue, decrease the Gain for that color.
- **Offset:** Use the Offset controls in the White Balance sub-menu to correct color imbalances in the dark areas of the image. A good way to do this is to use a test pattern consisting mostly of dark gray areas, such as a 30 IRE “window” pattern. If the gray areas contain traces of red, green or blue, decrease the Offset for that color.

**ISF Night - Input Image:** The Input Image controls are similar to those in the Picture menu, but are accessible only by entering the Calibration menu passcode. This makes it possible to restore the picture quality settings to what they were when the display was installed, simply by recalling the “ISF Night” preset.

**ISF Night - Input Color:** The Input Color controls are similar to those in the Display Color menu (see above), but can be set independently for each input.

- **Gain/Offset:** Refer to ISF Night - Display Color, above.
- **Chroma Delay:** use the Chroma Delay control to correct a mis-aligned image from a Composite, S-Video or Component video source. Chroma delay in an image causes color shifts to occur to the left of the vertical edge transitions, producing artificial shadows or a “halo” effect. If necessary, adjust this setting to eliminate them.
- **Phase:** Adjust the phase if the image (usually from an RGB source) shows shimmer or “noise.” Pixel phase adjusts the phase of the pixel sampling clock relative to the incoming signal. The effect of this control is similar to that of a tracking control on a VCR.

For best results, use a good test pattern such as a smooth gray consisting of a clear pattern of black and white pixels, or a similar “half on, half off” graphic image. (You may notice that you can stabilize the image at more than one point. Use either setting in this case.)

- **Noise Reduction:** To apply Digital Noise Reduction (DNR) to the input signal, select Noise Reduction from the Input Color menu. Noise reduction is useful for clearing up noisy images from 480i video sources.

Use the left- or right-arrow buttons to select the desired amount of noise reduction, keeping in mind that higher settings (which reduce high frequencies) may also “soften” the image.

**ISF Day - Display Color:** Refer to *ISF Night - Display Color*.

**ISF Day - Input Image:** Refer to *ISF Night - Input Image*.

**ISF Day - Input Color:** Refer to *ISF Night - Input Color*.

**Output Shift:** The controls in the Output Shift menu are similar to those in the Input Position menu, except that they change the characteristics of the output signal (so the change is visible no matter which input is selected).

**Splash Configure:** Use the Splash Configure menu to customize the appearance of the start-up message that appears on the vacuum fluorescent display upon power-up. You can have the PlasmaWall display the owner’s name, your name, the phrase “ISF Calibrated” and/or any other string, up to 20 characters in length.

Use the up or down cursor button to select a character. Use the right and left cursor buttons to change the cursor position. Press MENU when you have finished entering text. Then, check the “Splash Enable” box to have the PlasmaWall display the information you enter here when it is turned on.

**OSD Position:** Select OSD Position, press ENTER and use the arrow buttons to change the size and position of the OSD controls.

Use the Service menu to access advanced display configuration settings. **This menu should be used by ISF-certified technicians only.**

◀ **Service**



**Note**

*You must enter a passcode to access the Service menu.*

**Test Video:** Select Test Video from the Service Menu to access the internal test patterns on the PlasmaWall. Four patterns are available, consisting of white/gray or colored bars. These are useful for calibrating other theater source components (DVD player, HD tuner etc.) that have their own picture controls.

Press **MENU** to exit test pattern mode.

**Language:** Select Language from the Service menu and press the up- or down-arrows to select the OSD Language (English, French, Spanish or German).

<b>Service</b>
<b>Test Video</b>
<b>Language</b>
<b>Remote Control</b>
<b>Analog Out Mode</b>
<b>Display Device</b>
<b>HD Format</b>
<b>Triggers</b>
<b>Miscellaneous</b>
<b>Resolution</b>
<b>System Reset</b>

**Remote Control:** The Remote Control menu shows you the primary and secondary infrared (IR) codes to which the DHD Controller and PlasmaWall will respond. By default, both are set to 17. You can change these codes if either:

- Another device in the theater (a DVD player, for example) is responding to commands from the PlasmaWall remote control in ways that are unpredictable or undesirable.
- You have multiple PlasmaWall displays and want to control them independently, as opposed to broadcasting commands from a single remote to all of them. In this scenario, you can use multiple remotes programmed to use different IR codes. Or, you can use a single remote and change the IR code as needed to address a specific display.



*Use the front-panel keypad on the DHD Controller to change its IR code. Then, change the code sent by the remote to match as described below.*

When you change a remote code on the DHD Controller, you must re-program your remote control to send that same code. To do this:

1. Using a straightened paper clip or similar object, press and hold the **CODE** button on the remote control for approximately three seconds, or until the red LED on the remote lights solid red.
2. Enter a new two-digit code between 00 and 31 inclusive. Include a leading zero for single-digit codes; for example, enter 9 as "09."
3. The LED turns off to confirm the code change. If you enter an invalid code, the LED flashes for three or four seconds. Try again, entering a valid code.

**Analog Out Mode:** Select Analog Out Mode from the Service menu to change the characteristics of the analog output signal from the DHD Controller. The choices are RGB-- (separate sync with negative polarity), RGB++ (separate sync with positive polarity) or RGBS (composite sync).

**Display Device:** The options in the Display Device menu allow you to perform certain adjustments at the plasma display.

- **Input Source:** Select Input Source from the Display Device menu to switch from one DHD output/PlasmaWall input to the other. To display the analog signal from the DHD Controller, select RGB. To display the digital signal, select DVI/HDMI.
- **Configure:** Select Configure from the Display Device menu to perform the following display device adjustments (these are global, independent of any input):
  - Select **Noise Reduction** to apply noise reduction to the displayed image.
  - Select **Inverse** to invert the colors in the displayed image. Use this for repairing burned-in areas of the plasma display.
  - Select **Left/Right, Up/Down, Width** or **Height** to fine-tune the aspect ratio and image position.

**HD Format:** If for some reason the PlasmaWall does not properly detect the incoming signal format (color space) on the HD1 or HD2 inputs, specify it here (RGB or YUV). Otherwise, leave it set to **Auto**.

**Triggers:** Select Triggers from the Service menu to configure the 12-volt trigger outputs. You can assign one or more trigger outputs to each aspect ratio. Those triggers are then activated by selecting that aspect ratio.

**Miscellaneous:** Select Miscellaneous from the Service menu to set the following options:

- **Menu Mode:** This is the manner in which the OSD menus appear and disappear when you press MENU. Choose one of the following:
  - 0 = No transition; menus abruptly appear and disappear.
  - 1 = Menu fade in and out.
  - 2 = “Checkerboard” dissolve; menus appear and disappear in sections.
  - 3 = “Window shade” effect; menus are drawn on a diagonal from top left to bottom right, and retract in the opposite direction.
- **Timeout - Short/Long:** These settings control how long the OSD menus stay on screen. Select a time-out period of from 2 to 60 seconds.
- **Side Bar Color:** This controls the color of the inactive image area. The range is from -100 (black) to 100 (white).

The inactive image area is on either side of the active image area when using the Standard 4:3 aspect ratio, and above and below the active image area when using the Letterbox aspect ratio.

- **Film Mode:** Enable Film Mode to smooth out moving images from interlaced sources. In most cases, the PlasmaWall detects the proper “pull-down” rate and vertical frequency. However, if your source is jittery and/or tearing you may wish to enable Film Mode to ensure stable processing for that source.

**Resolution:** The DHD Controller defaults to an output resolution of 720p. When using the PlasmaWall with a computer or certain HD sources, you may want to force the DHD Controller to use a different output resolution. If so, select Resolution from the Service menu and choose one. Then, press **ENTER** to confirm.

**System Reset:** To reset ALL display settings (including image settings) back to their factory defaults, choose System Reset from the Service menu. Select Confirm to continue or Back to cancel. ***This action is not undoable. Use it with caution!***

**Notes:**

# 5. Maintenance and Troubleshooting

Table 5-1 provides some general guidelines for troubleshooting problems you may encounter with the PlasmaWall. If you encounter an issue not described here, please contact your Runco dealer or Runco Technical Support.

## 5.1 Troubleshooting Tips

**Table 5-1. Troubleshooting Chart**

Symptom	Possible Cause(s)	Solution
The display does not turn on after initial installation.	<ul style="list-style-type: none"> <li>The PlasmaWall is not plugged in or the AC outlet is not active.</li> <li>The remote control batteries have run out.</li> <li>The serial connection from the DHD Controller to the PlasmaWall is incorrect.</li> </ul>	<ul style="list-style-type: none"> <li>Ensure that the PlasmaWall is plugged in and that the AC outlet is active.</li> <li>Replace the batteries.</li> <li>Ensure that the RS-232 output from the DHD Controller is properly connected to the EXTERNAL CONTROL input on the PlasmaWall (see Figure 3-4).</li> </ul>
The display is on, but there is no picture or sound.	<ul style="list-style-type: none"> <li>Incorrect source selection.</li> <li>Source component is not turned on.</li> <li>Source component is connected incorrectly or not at all.</li> </ul>	<ul style="list-style-type: none"> <li>Select the correct source.</li> <li>Turn on the source component.</li> <li>Check video and/or audio connections to source component.</li> </ul>
Image is too bright and/or lacks definition in the bright areas of the image.	<ul style="list-style-type: none"> <li>Contrast is set too high.</li> </ul>	<ul style="list-style-type: none"> <li>Lower the contrast setting.</li> </ul>
Image appears "washed out" and/or dark areas appear too bright.	<ul style="list-style-type: none"> <li>Brightness is set too high.</li> </ul>	<ul style="list-style-type: none"> <li>Lower the brightness setting.</li> </ul>
Colors in the image are swapped; for example, reds appear blue or vice versa.	<ul style="list-style-type: none"> <li>The Red/Pr, Green/Y or Blue/Pb outputs from the source are connected to the wrong inputs on the PlasmaWall.</li> </ul>	<ul style="list-style-type: none"> <li>Ensure that the source outputs are connected to the correct PlasmaWall input.</li> </ul>
RGB-HD images appear "noisy."	<ul style="list-style-type: none"> <li>Clock and Phase settings need adjustment.</li> </ul>	<ul style="list-style-type: none"> <li>Manually adjust Clock and Phase settings, or perform an Auto-Adjust (refer to <b>ISF Night - Input Color</b> on page 40).</li> </ul>

**Table 5-1. Troubleshooting Chart (continued)**

Symptom	Possible Cause(s)	Solution
"Out of range" appears on-screen.	<ul style="list-style-type: none"> <li>The resolution and frequency of the video card in the computer are not compatible with the PlasmaWall.</li> </ul>	<ul style="list-style-type: none"> <li>Select a compatible resolution and vertical frequency (refer to <b>Computer/Video Signal Compatibility</b> on page 55).</li> </ul>
The image is too large or too small.	<ul style="list-style-type: none"> <li>Image size needs adjusting.</li> </ul>	<ul style="list-style-type: none"> <li>Adjust the image size (refer to <b>Input Position</b> on page 38).</li> </ul>



# 6. Serial Communications

To interface the PlasmaWall with a home theater automation/control system or a PC running terminal emulation software, connect it to the RS-232 output of the DHD Controller as shown in Figure 3-4. Connect your control system or PC to the RS-232 input of the DHD Controller as shown in Figure 3-9.

Configure the RS-232 controller or PC serial port as follows: no parity, 8 data bits, 1 stop bit and no flow control. Set the baud rate to 19200, to match that of the DHD Controller RS-232 port.

Serial commands to the DHD Controller take the following form:

- Commands are not case-sensitive.
- For a single command that takes no parameters, type the command followed by a carriage return; for example, to set the aspect ratio to Letterbox, type `LETTERBOX <Return>`.
- For a single command that takes a parameter, type the command, a space or a comma and the desired value followed by a carriage return; for example, to set the brightness to -10, type `BRIGHTNESS -10 <Return>` or `BRIGHTNESS,-10 <Return>`.
- You can also send a string of multiple commands on a single line, separated by commas. For example, `COMPOSITE ,BRIGHTNESS 100 ,ANAMORPHIC <Return>` switches to the Composite video input, sets the brightness to 100 and sets the aspect ratio to Anamorphic. Command strings can be up to 255 characters long.

Table 6-1 lists the RS-232 command set. The "Parameter (min/max)" column shows the valid parameter ranges, or "NA" for commands that take no parameters.

When you enter a valid command, the DHD Controller executes it and acknowledges it with a plus sign on the command line (+ >). When you enter an invalid command -- one that is misspelled or followed by values outside the valid range for that command -- the DHD Controller ignores it and returns a minus sign (- >).

**Table 6-1. Serial Commands**

Command	Parameter (min/max)	Value Stored?	Description
POWER	0/1	NA	Turns display on and off
ON	NA	NA	Turns display on
OFF	NA	NA	Turns display off
COMPOSITE	NA	YES	Selects the Composite video input
SVIDEO1	NA	YES	Selects the S-Video 1 input
SVIDEO2	NA	YES	Selects the S-Video 2 input
COMPONENT	NA	YES	Selects the Component input

## 6.1 RS-232 Connection and Port Configuration

## 6.2 Serial Command Syntax

**Table 6-1. Serial Commands (continued)**

<b>Command</b>	<b>Parameter (min/max)</b>	<b>Value Stored?</b>	<b>Description</b>
HD1	NA	YES	Selects the RGB HD 1 input
HD2	NA	YES	Selects the RGB HD 2 input
DVI1	NA	YES	Selects the DVI 1 input
DVI2	NA	YES	Selects the DVI 2 input
HD1PASS	NA	YES	Loops HD1 Input to RGB/HD output
HD2PASS	NA	YES	Loops HD2 Input to RGB/HD output
OUT169	NA	YES	Sets the output screen to 1.78:1 (16:9)
OUT235	NA	YES	Sets the output screen to 2.35:1
ANAMORPHIC	NA	YES	Selects the Anamorphic aspect ratio
STANDARD	NA	YES	Selects the Standard (4:3) aspect ratio
LETTERBOX	NA	YES	Selects the Letterbox aspect ratio
VIRTUALWIDE	NA	YES	Selects the VirtualWide aspect ratio
CINEMA	NA	YES	Selects the Cinema aspect ratio
RGBNN	NA	YES	Outputs color space RGB with negative, negative sync
RGBPP	NA	YES	Outputs color space RGB with positive, positive sync
RGBS	NA	YES	Outputs color space RGB with embedded sync on green
PHASE	0/3	YES	Adjusts phase
IHPOS	-100/100	YES	Sets a value for horizontal input position
IVPOS	-100/100	YES	Sets a value for vertical input position
IWIDTH	-100/100	YES	Sets the value for input width
IHEIGHT	-100/100	YES	Sets the value for input height
OVERSCAN	0/10	YES	Sets the overscan percentage
OHPOS	-100/100	YES	Sets the value for output horizontal position
OVPOS	-100/100	YES	Sets the value for output vertical position
OWIDTH	-100/100	YES	Sets the value for output width
OHEIGHT	-100/100	YES	Sets the value for output height
BRIGHTNESS	-100/100	YES	Sets a value for brightness
CONTRAST	-100/100	YES	Sets a value for contrast
COLOR	-100/100	YES	Sets a value for color

**Table 6-1. Serial Commands (continued)**

Command	Parameter (min/max)	Value Stored?	Description
TINT	-100/100	YES	Sets a value for tint
SHARPNESS	-6/6	YES	Sets a value for sharpness
NIGHT	NA	YES	Loads "ISF Night" image preset
DAY	NA	YES	Loads "ISF Day" image preset
CUSTOM1	NA	YES	Loads "Custom 1" image preset
CUSTOM2	NA	YES	Loads "Custom 2" image preset
TRIGGER	1/3	YES	Assigns trigger to currently-selected aspect ratio
BKGND	-100/100	YES	Sets the background color for letterbox or 4:3 aspect ratio (-100 = black; 100 = white)
IHPOS?	NA	NA	Returns input horizontal position value
IHEIGHT?	NA	NA	Returns input height value
OHPOS?	NA	NA	Returns output horizontal position value
OHEIGHT?	NA	NA	Returns output height value
COLOR?	NA	NA	Returns color setting value
ASPECT?	NA	NA	Returns current aspect ratio
INPUT?	NA	NA	Returns active input
OUTRES?	NA	NA	Returns output resolution
SERIALNUM?	NA	NA	Returns product serial number
DATE?	NA	NA	Returns product manufacture date
IVPOS?	NA	NA	Returns input vertical position value
OVERSCAN?	NA	NA	Returns overscan percentage
OVPOS?	NA	NA	Returns output vertical position value
BRIGHTNESS?	NA	NA	Returns brightness setting value
TINT?	NA	NA	Returns tint setting value
PRESET?	NA	NA	Returns currently-selected preset (ISF Day, ISF Night, Custom 1 or Custom 2)
POWER?	NA	NA	Returns power status
ASPECTIN?	NA	NA	Returns the input source aspect ratio
SWVER?	NA	NA	Returns software version number
IWIDTH?	NA	NA	Returns input horizontal width value
PHASE?	NA	NA	Returns phase setting value

**Table 6-1. Serial Commands (continued)**

<b>Command</b>	<b>Parameter (min/max)</b>	<b>Value Stored?</b>	<b>Description</b>
OWIDTH?	NA	NA	Returns output horizontal width value
CONTRAST?	NA	NA	Returns contrast setting value
SHARPNESS?	NA	NA	Returns sharpness setting value
BKGND?	NA	NA	Returns background setting value
INRES?	NA	NA	Returns input resolution
ASPECTOUT?	NA	NA	Returns output screen size
HWVER?	NA	NA	Returns hardware version number

# 7. Specifications

Table 7-1 lists the PlasmaWall specifications.

**Table 7-1. PlasmaWall Specifications**

<b>Native Resolution:</b>	1365 x 768 WXGA
<b>Screen Size (diagonal):</b>	<b>Model PL-50XA</b> -- 50 in. <b>Model PL-61DHD</b> -- 61 in.
<b>Active Screen Area:</b>	<b>Model PL-50XA</b> -- 43.5 x 24.5 in. (1106 x 622 mm) <b>Model PL-61DHD</b> -- 53.2 x 29.9 in. (1351 x 760 mm)
<b>Screen Aspect Ratio:</b>	16:9
<b>Available Aspect Ratios:</b>	Refer to Table 7-2
<b>DTV Compatibility:</b>	480i/p, 576i/p, 720p, 1080i/p
<b>ISF Settings:</b>	Yes
<b>Data/Graphics Compatibility:</b>	Up to 1600 x 1200
<b>Inputs:</b>	(1) Composite, (1) S-Video, (2) HD Component, (2) HDMI 1.1 with HDCP, (1) RGB (15-pin D-sub), (1) RS-232, (1) Wired IR (3.5-mm mini jack)
<b>Power Requirements:</b>	100 to 240 VAC, 50/60Hz
<b>Power Consumption (typical):</b>	<b>Model PL-50XA</b> -- 435W <b>Model PL-61DHD</b> -- 540W
<b>Operating Environment:</b>	40°F to 95°F (5°C to 35°C); 20% to 80% humidity (non-condensing) Altitude -- up to 9,000 feet (2,740m)
<b>Dimensions:</b>	<b>Model PL-50XA</b> -- See Figure 7-1 <b>Model PL-61DHD</b> -- See Figure 7-2
<b>Weight (with Stand):</b>	<b>Model PL-50XA</b> -- 97.9 lbs. (44.50 kg) <b>Model PL-61DHD</b> -- 134.2 lbs. (61.00 kg)
<b>Regulatory Approvals:</b>	Complies with FCC
<b>Limited Warranty:</b>	Three (3) years parts and labor from the date of delivery to the end user (except for plasma glass panel). Plasma Glass Panel: One (1) year parts and labor from the date of delivery to the end user.

**Specifications are subject to change without notice.**

## 7.1 PlasmaWall Specifications

## 7.2 DHD Controller Specifications

Table 7-2 lists the DHD Controller specifications.

**Table 7-2. DHD Controller Specifications**

<b>Aspect Ratios:</b>	4:3, Letterbox, 16:9 Anamorphic, VirtualWide, Cinema
<b>Video Standards:</b>	NTSC, PAL
<b>Output Resolution:</b>	480p, 576p, 720p, 840p, 960p, 1080i
<b>Inputs:</b>	(1) Composite; (2) S-Video; (1) Component; (2) HD-R (Pr), G (Y), B (Pb), H, V; (2) DVI with HDCP
<b>Outputs:</b>	(1) HD-R (Pr), G (Y), B (Pb), H, V (1) DVI-I with HDCP
<b>Control Options:</b>	<ul style="list-style-type: none"> <li>- Discrete infrared remote</li> <li>- Serial commands via RS-232</li> <li>- Front-panel controls</li> </ul>
<b>RS-232 Communication Parameters:</b>	19200 bps, no parity, 8 data bits, 1 stop bit, no flow control
<b>Trigger Outputs:</b>	(3) +12 VDC, 800 mA
<b>Bandwidth:</b>	150 Mega Samples per Second (MSPS)
<b>Power Requirements:</b>	100 to 240 VAC (auto-sensing), 50/60 Hz, 160 Watts
<b>Operating Environment:</b>	41°F to 95°F (5°C to 35°C), 0% to 90% humidity (non-condensing)
<b>Dimensions:</b>	Width = 17.50 inches (444.5 mm) Depth = 11.19 inches (284.1 mm) Height = 3.75 inches (95.3 mm)
<b>Weight:</b>	13.0 lbs. (5.90 kg)
<b>Regulatory Approvals:</b>	Complies with FCC, CE C-Tick
<b>Limited Warranty:</b>	Two (2) years parts and labor from the date of delivery to the end user.

**Specifications are subject to change without notice.**

Figure 7-1 and Figure 7-2 show the PlasmaWall dimensions (all dimensions are in inches).

### 7.3 PlasmaWall Dimensions

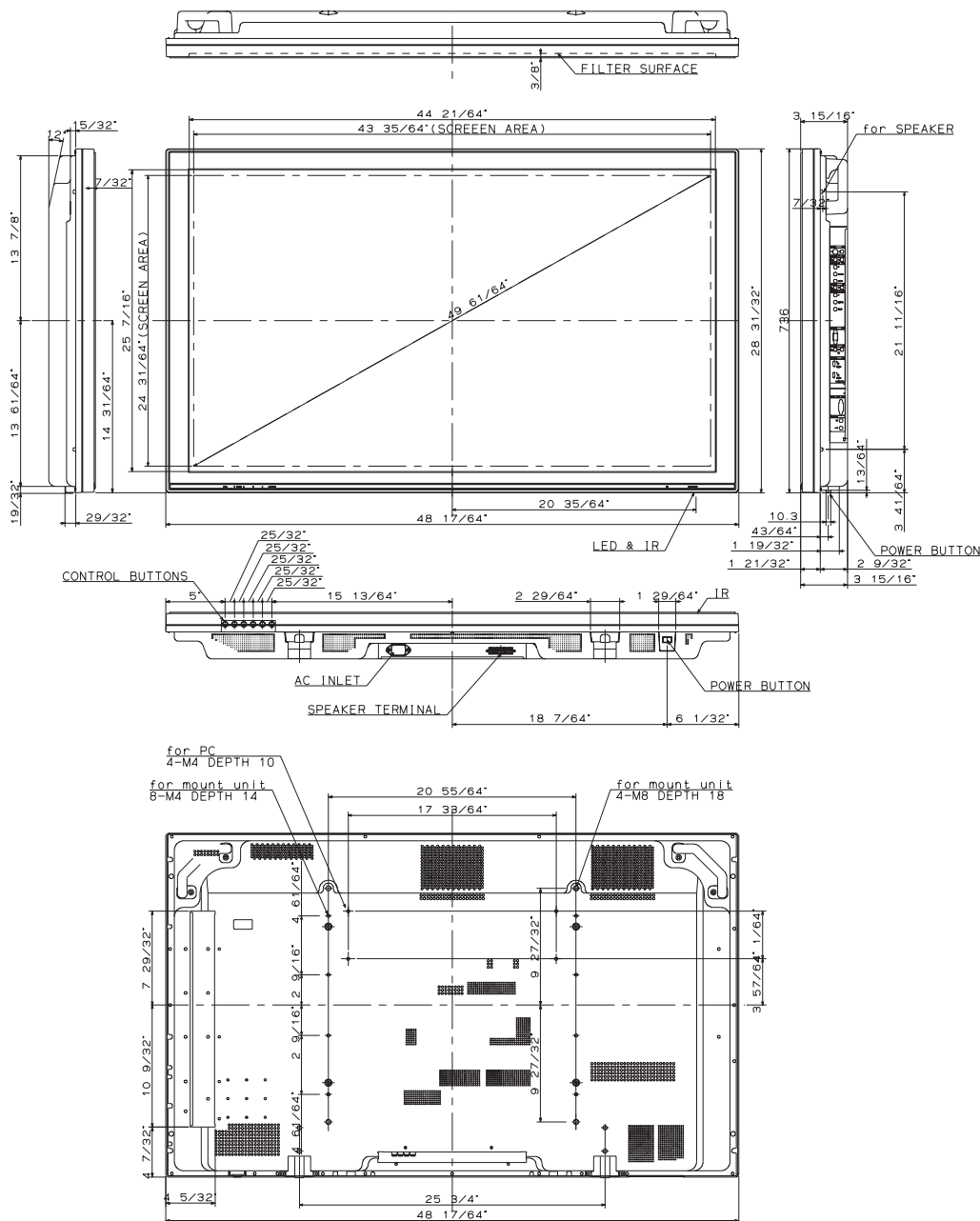

Figure 7-1. PlasmaWall Model PL-50XA Dimensions

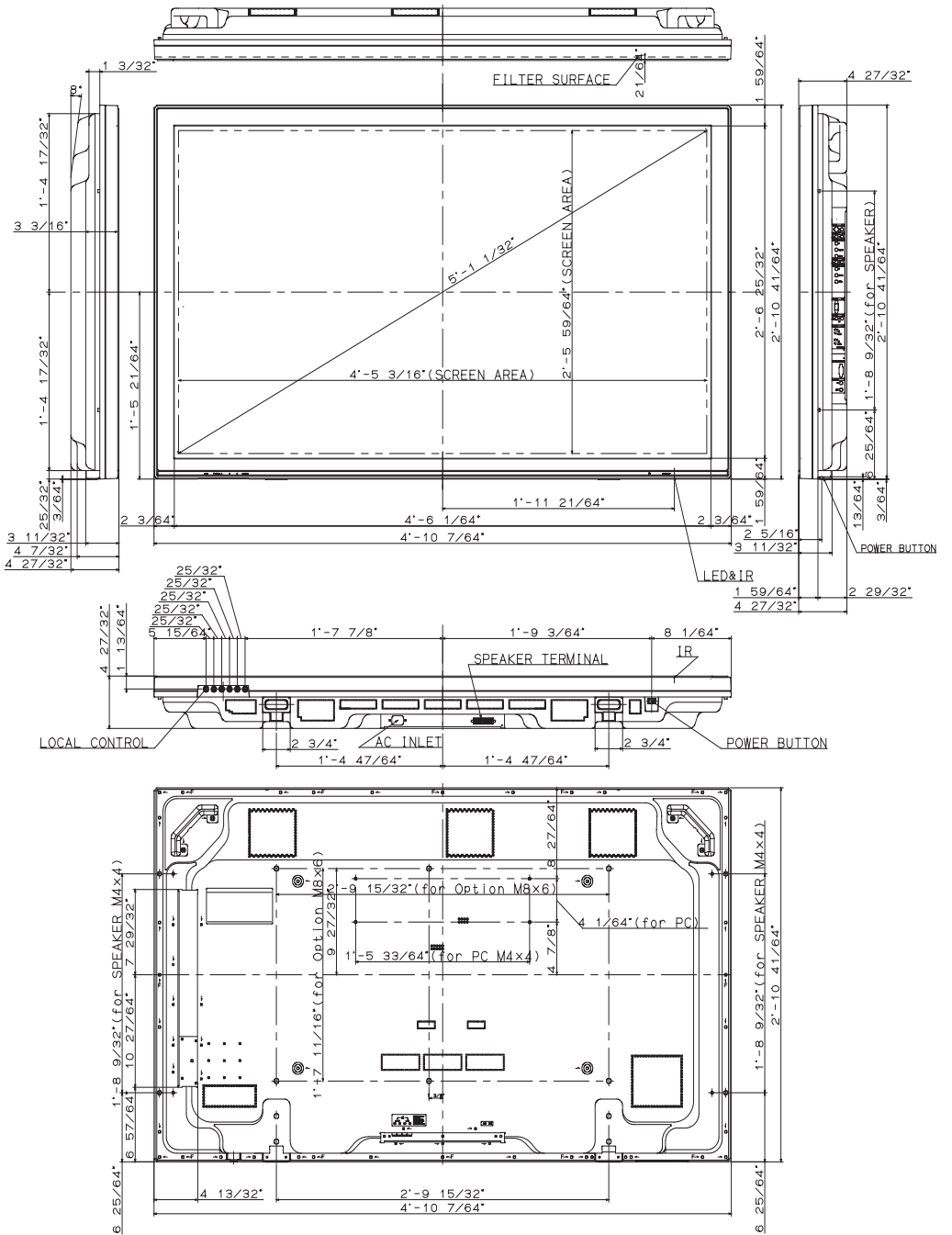

Figure 7-2. PlasmaWall Model PL-61DHD Dimensions



The PlasmaWall can display video signals from a variety of computer sources via its PC/RGB and HDMI inputs.

Table 7-3 lists the signal types that are compatible with the PlasmaWall, and indicates which of those are VESA standards.

**Table 7-3. Computer/Video Signal Compatibility Chart**

Signal Type	Mode (Dots x Lines)	Vertical Frequency (Hz)	Horizontal Frequency (kHz)	Sync Polarity	
				Horiz.	Vert.
IBM	640x400	70.10	31.50	neg	neg
IBM	640x480	59.90	31.50	neg	neg
MAC		66.70	35.00	Sync on Green	
VESA		72.80	37.90	neg	neg
VESA		75.00	37.50	neg	neg
VESA		85.00	43.30	neg	neg
IBM		100.40	51.10	neg	neg
IBM		120.40	61.30	neg	neg
IBM		720x400	70.10	31.50	neg
VESA	85.10		37.90	neg	pos
VESA	800x600	56.25	35.20	pos	pos
VESA		60.30	37.90	pos	pos
VESA		72.20	48.10	pos	pos
VESA		75.00	46.90	pos	pos
VESA		85.10	53.70	pos	pos
IBM		99.80	63.00	pos	pos
IBM		120.00	75.70	pos	pos
MAC		832x624	74.60	49.70	Sync on Green
IBM	848x480	60.00	31.00	pos	pos
IBM	852x480	60.00	31.70	neg	neg
VESA	1024x768	60.00	48.40	neg	neg
SGI		60.00	49.70	--	--
VESA		70.10	56.50	neg	neg
MAC		74.90	60.20	Sync on Green	
VESA		75.00	60.00	pos	pos
VESA		85.00	68.70	pos	pos
IBM		100.00	80.50	neg	neg
IBM		1280x768	56.20	45.10	pos
SGI	1280x1024	60.00	63.90	--	--
IBM	1280x1024	60.00	64.00	pos	pos

**Notes:**

1. The PlasmaWall may not be able to display images from notebook computers in simultaneous (CRT/LCD) mode. Should this occur, switch the notebook computer to "CRT only" mode. If you are unsure how to do this, refer to your notebook computer's user manual.
2. When the aspect ratio is set to Anamorphic, all modes other than 1365x768 are scaled up or down to 1365x768. When the aspect ratio is set to Standard 4:3, all modes other than 1024x768 are scaled up or down to 1024x768.

## 7.4 Computer/Video Signal Compatibility

**Table 7-3. Computer/Video Signal Compatibility Chart (continued)**

Signal Type	Mode (Dots x Lines)	Vertical Frequency (Hz)	Horizontal Frequency (kHz)	Sync Polarity	
				Horiz.	Vert.
HP	1280x1024	72.00	81.10	--	--
IBM	1280x1024	75.00	80.00	pos	pos
SUN	1280x1024	76.10	81.10	Composite sync	
IBM	1280x1024	85.00	91.10	pos	pos
IBM	1280x1024	100.10	108.50	pos	pos
IBM	1360x768	60.00	47.70	pos	pos
IBM	1400x1050	60.00	65.30	neg	pos
IBM	1400x1050	75.00	82.30	neg	pos
IBM	1400x1050	85.00	93.90	neg	pos

**Notes:**

- 1. The PlasmaWall may not be able to display images from notebook computers in simultaneous (CRT/LCD) mode. Should this occur, switch the notebook computer to "CRT only" mode. If you are unsure how to do this, refer to your notebook computer's user manual.*
- 2. When the aspect ratio is set to Anamorphic, all modes other than 1365x768 are scaled up or down to 1365x768. When the aspect ratio is set to Standard 4:3, all modes other than 1024x768 are scaled up or down to 1024x768.*



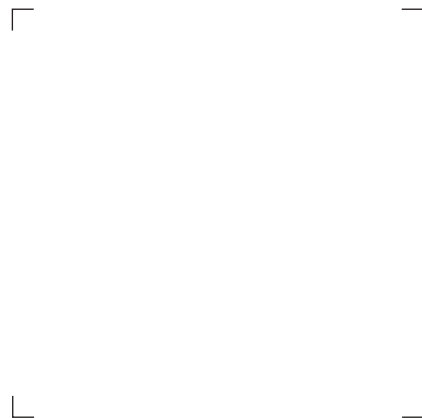

SERIAL NUMBER  
RUMA-010950  
rev 12-22-05 v3.1

## Free Manuals Download Website

<http://myh66.com>

<http://usermanuals.us>

<http://www.somanuals.com>

<http://www.4manuals.cc>

<http://www.manual-lib.com>

<http://www.404manual.com>

<http://www.luxmanual.com>

<http://aubethermostatmanual.com>

Golf course search by state

<http://golfingnear.com>

Email search by domain

<http://emailbydomain.com>

Auto manuals search

<http://auto.somanuals.com>

TV manuals search

<http://tv.somanuals.com>