



OWNER'S OPERATING MANUAL



DTV-992/992 ULTRA

DTV Capable CRT Projector



THE WORLD'S FINEST HOME THEATER PRODUCTS™

TABLE OF CONTENTS

SAFETY INSTRUCTIONS	1-1
On Safety	1-1
On Installation	1-2
On Servicing	1-2
On Cleaning	1-2
On Repacking	1-2
On Illumination	1-2
LOCATION AND FUNCTION OF CONTROLS.....	2-1
Rear Panel Terminology	2-1
Front Panel Terminology	2-1
Control Panel Terminology.....	2-2
Remote Control Description.....	2-3
CONNECTIONS	3-1
AC Power (mains) Cord Connection	3-1
Power Check.....	3-1
Switching on/off.....	3-1
Start Up With Full White Image	3-2
Signal Input Connection to the Projector	3-2
Connecting a Composite Video Source to Port 1	3-3
Connecting an S-Video or Video Source to Port 2	3-3
Connecting an RGB Analog Source With Composite Sync	3-4
Connecting an RGB Analog Source With Tri-Level Sync.....	3-4
RGB3S or RG3sB Input Selection	3-4
Connecting a Component Source.....	3-5
(R-Y)Y(B-Y)S or (R-Y)Ys(B-Y) Input Selection	3-5
Connecting a Component Source With Tri-Level Sync	3-5
(R-Y)Y(B-Y)3S or (R-Y)Y3s(B-Y) Input Selection	3-6
Connecting a Computer, e.g. IBM PC (or compatible), Apple Macintosh to the RS232 Input of the Projector.....	3-6
CONTROLLING	4-1
Battery Installation in the RCU	4-1
How to Use Your RCU	4-2
Projector Address	4-2
How to Display a Projector Address.....	4-2
How to Program an Address Into the RCU	4-2
Input Selection	4-3
Analog Picture Controls	4-4
Brightness Control	4-4
Contrast Control	4-4
Color Saturation Control.....	4-4
Tint Control	4-4
Sharpness Control.....	4-4
The Pause Key	4-4
START UP OF THE ADJUSTMENT MODE.....	5-1

TABLE OF CONTENTS

RANDOM ACCESS ADJUSTMENT MODE	6-1
Starting Up the Random Access Adjustment Mode.....	6-1
Overview 'Random Access Adjustment' Mode	6-1
Selecting Setup Pattern	6-2
Internal Cross Hatch Pattern.....	6-2
Random Access Adjustment Mode Selection Menu	6-3
Picture Tuning	6-3
Color Balance.....	6-3
Sync Fast/Slow Adjustment	6-3
Peaking	6-4
Color Select.....	6-4
Clamp Tuning.....	6-4
Focusing.....	6-5
Geometry Adjustments.....	6-6
Horizontal Phase Adjustment.....	6-6
Raster Shift Adjustment	6-7
Left-Right (east-west) Adjustments	6-8
Left Side Correction	6-9
Top-Bottom (north-south) Adjustments	6-10
Size Adjustment.....	6-11
Vertical Linearity Adjustment.....	6-11
Blanking Adjustments.....	6-12
Convergence Adjustment.....	6-13
Vertical Corners.....	6-14
Fine Convergence Adjustments.....	6-14
SERVICE MODE	7-1
Starting up the Service Mode.....	7-1
Overview flowchart 'Service' Mode	7-1
Identification	7-2
Copy a Block.....	7-2
Deletion of Blocks	7-3
Deleting Block by Block	7-3
Deletion of All Blocks	7-3
Change Password.....	7-4
Change Language.....	7-4
Total Run Time	7-4
All settings to Midposition	7-5
Undo All Settings to Midpos.....	7-5
R & B Convergence Mid	7-5
Undo R & B Convergence Mid.....	7-5
Dynamic Astigmatism.....	7-6
G2 Adjustment	7-7
CRT Run in Cycle	7-7
Projector Warm-Up.....	7-8
MESSAGES, WARNINGS, AND FAILURES	8-1
SPECIFICATIONS	9-1
APPENDIX 1 (RS 232 Control)	APP-1

Hardware Configuration	APP-1
How to Format the Control Data	APP-1
Sending a RECORD (single instruction).....	APP-2
Example String to Send to the Projector With Address 3 to Turn it On/Off.....	APP-3
COMMAND CODE LIST.....	APP-3
APPENDIX 2 (EYE-Q™ Autoconvergence).....	APX-1
Overview	APX-1
THE QUICK GUIDE to using the EYE-Q™ system	APX-1
Easy-To-Use, High Precision Automatic Convergence System	APX-2
Easy-To-Use, High Precision Automatic Geometry System	APX-2
Compact Built-In System	APX-2
Preparing Your EYE-Q™	APX-2
ON-SCREEN OPERATING INSTRUCTIONS.....	APX-3
ACCESS TO EYE-Q™ ON-SCREEN MENUS.....	APX-3
EYE-Q™ MENU.....	APX-3
EYE-Q™ SETUP.....	APX-4
Setting the Configuration	APX-4
FOCUSING THE CAMERA LENS.....	APX-5
CENTERING THE CAMERA	APX-6
Centering The Camera Horizontally	APX-6
Centuring The Camera Vertically.....	APX-7
SET TOUCH-UP OPTIONS	APX-7
Touch-Up On Source On/Off.....	APX-7
Touch-Up On Timer.....	APX-8
Reference Source	APX-8
Adjusting Other Sources.....	APX-8
Learning A Reference	APX-9
WHAT IS BEING MEASURED BY EYE-Q™	APX-9
TOUCH UP AND AUTOCONVERGENCE	APX-10
Adjusting Screen Size.....	APX-10
On Current Source.....	APX-10
Touch-Up.....	APX-11
Align On Current Source	APX-11
Align From Midposition On Current Source	APX-11
On All Sources	APX-12
Touch-Up On All Sources	APX-12
Align On All Sources.....	APX-12

TABLE OF CONTENTS

Align From Midposition on All Sources.....	APX-13
Interrupting the Automatic Convergence Process	APX-13
Error Messages.....	APX-13
No Pattern Error.....	APX-14
Status Reporting Forced Break	APX-14
EYE-Q™ DIAGNOSTICS.....	APX-15

SAFETY INSTRUCTIONS

Notice on Safety

This equipment is built in accordance with the requirements of the international safety standards EN60950, UL 1950 and CSA C22.2 No.950, which are the safety standards of information technology equipment including electrical business equipment.

These safety standards impose important requirements on the use of safety critical components, materials and isolation, in order to protect the user or operator against risk of electric shock and energy hazard, and having access to live parts.

Safety standards also impose limits to the internal and external temperature rises, radiation levels, mechanical stability and strength, enclosure construction and protection against the risk of fire.

Simulated single fault condition testing ensures the safety of the equipment to the user even when the equipment's normal operation fails.

INSTALLATION INSTRUCTIONS

Before operating this equipment please read this manual thoroughly, and retain it for future reference.

Installation and preliminary adjustments should be performed by qualified RUNCO personnel or by authorized RUNCO service dealers.

OWNER'S RECORD

The part number and serial number are located at the back side of the projector. Record these numbers in the spaces provided below. Refer to them whenever you call upon your RUNCO dealer regarding this product.

SER. NUMBER:

DEALER:

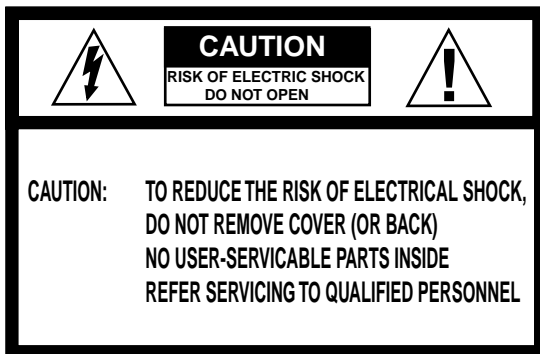

The lightning flash with an arrowhead within a triangle is intended to tell the user that parts inside this product may cause a risk of electrical shock to persons.



The exclamation point within a triangle is intended to tell the user that important operating and/or servicing instructions are included in the technical documentation for this equipment.

FEDERAL COMMUNICATION COMMISSION (FCC STATEMENT)

This equipment has been tested and found to comply with the limits of a class B digital device, pursuant to Part 15 of the FCC Rules. These limits are designed to provide reasonable protection against harmful interference when the equipment is operated in a commercial environment. This equipment generates, uses and can radiate radio frequency energy and, if not installed and used in accordance with the instruction manual, may cause harmful interference to radio communications. Operation of this equipment in a residential area is likely to cause harmful interference in which case the user will be required to correct the interference at his own expense.

Note:

The use of shielded cables is required to comply within the limits of Part 15 of FCC rules and EN55022

- *All the safety and operating instructions should be read before using this unit.
- *The safety and operating instructions manual should be retained for future reference.
- *All warnings on the equipment and in the documentation manuals should be adhered to.
- *All instructions for operating and use of this equipment must be followed precisely.

On Safety

1. This product should be operated from an AC power source. This projector may be connected to an IT-power system.

Operating AC power voltage of the projector:

DTV-992 / 992 ULTRA: 110/120 VAC, 50/60 Hz; unless otherwise specified.

Consult your dealer to switch over from 230Vac to 120Vac or from 120Vac to 230Vac.

If you are not sure of the type of AC power available, consult your dealer or local power company.

2. This product is equipped with a 3-wire grounding plug, a plug having a third (grounding) pin. This plug will only fit into a grounding-type power outlet. This is a safety feature. If you are unable to insert the plug into the outlet, contact your electrician to replace your obsolete outlet. Do not defeat the purpose of the grounding-type plug.

WARNING FOR THE CUSTOMERS: THIS APPARATUS MUST BE GROUNDED (EARTHED) via the supplied 3 conductor AC power cable.

(If the supplied power cable is not the correct one, consult your dealer.)

A. Mains lead (Power cord) with CEE 7 plug:

The wires of the mains lead are colored in accordance with the following code.

Green and yellow: earth (safety earth)
 Blue: neutral
 Brown: line (live)

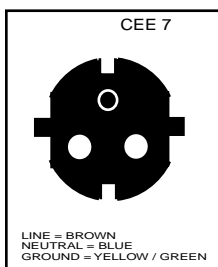

B. Power cord with ANSI 73.11 plug:

The wires of the power cord are colored in accordance with the following code.

Green/yellow: ground
 White: neutral
 Black: line (live)

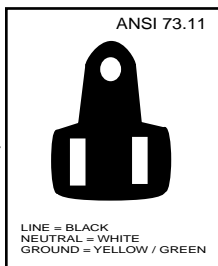

3. Do not allow anything to rest on the power cord. Do not locate this product where persons will walk on the cord.

To disconnect the cord, pull it out by the plug. Never pull the cord itself.

4. If an extension cord is used with this product, make sure that the total of the ampere ratings on the products plugged into the extension cord does not exceed the extension cord ampere rating. Also make sure that the total of all products plugged into the wall outlet does not exceed 15 amperes.

5. Never push objects of any kind into this product through cabinet slots as they may touch dangerous voltage points or short out parts that could result in a risk of fire or electrical shock.

Never spill liquid of any kind on the product. Should any liquid or solid object fall into the cabinet, unplug the set and have it checked by qualified service personnel before resuming operations.

6. Lightning - For added protection for this video product during a lightning storm, or when it is left unattended and unused for long periods of time, unplug it from the wall outlet. This will prevent damage to the projector due to lightning and AC power-line surges.

On installation

1. Do not place this equipment on an unstable cart, stand, or table. The product may fall, causing serious damage to it.

2. Do use this equipment near water.

3. Slots and openings in the cabinet and the back or bottom are provided for ventilation; to ensure reliable operation of the product and to protect it from overheating, these openings must not be blocked or covered. The openings should never be blocked by placing the product on a bed, sofa, rug, or other similar surface. This product should never be placed near or over a radiator or heat register.

The projector should not be placed in a built-in installation or enclosure unless proper ventilation is provided.

4. Do not block the projector cooling fans or free air movement under and around the projector. Loose papers or other objects may not be nearer to the projector than 4" on any side.

On servicing

Do not attempt to service this product yourself, as opening or removing covers may expose you to dangerous voltage potentials and risk of electric shock!

Refer all servicing to qualified service personnel.

Unplug this product from the wall outlet and refer servicing to qualified service personnel under the following conditions:

- a. When the power cord or plug is damaged or frayed.
 - b. If liquid has been spilled into the equipment.
 - c. If the product has been exposed to rain or water.
 - d. If the product does not operate normally when the operating instructions are followed.
- Note: Adjust only those controls that are covered by the operating instructions since improper adjustment of the other controls may result in damage and will often require extensive work by a qualified technician to restore the product to normal operation.
- e. If the product has been dropped or the cabinet has been damaged.
 - f. If the product exhibits a distinct change in performance, indicating a need for service.

Replacement parts - When replacement parts are required, be sure the service technician has used original RUNCO replacement parts or authorized replacement parts which have the same characteristics as the RUNCO original part. Unauthorized substitutions may result in degraded performance and reliability, fire, electric shock or other hazards. Unauthorized substitutions may void warranty.

Safety check - Upon completion of any service or repairs to this projector, ask the service technician to perform safety checks to determine that the product is in proper operating condition.

On Cleaning

Unplug this product from the wall outlet before cleaning. Do not use liquid cleaners or aerosol cleaners. Use a damp cloth for cleaning.

- To keep the cabinet looking brand-new, periodically clean it with a soft cloth. Stubborn stains may be removed with a cloth lightly dampened with mild detergent solution. Never use strong solvents, such as thinner or benzine, or abrasive cleaners, since these will damage the cabinet.

- To ensure the highest optical performance and resolution, the projection lenses are specially treated with an anti-reflective coating, therefore, avoid touching the lens. To remove dust on the lens, use a soft dry cloth. Do not use a damp cloth, detergent solution, or thinner.

On repacking

Save the original shipping carton and packing material; they will come in handy if you ever have to ship your equipment. For maximum protection, repack your set as it was originally packed at the factory.

On illumination

In order to obtain the best quality for the projected image, it is essential that the ambient light which is allowed to fall on the screen be kept to an absolute minimum.

When installing the projector and screen, care must be taken to avoid exposure to ambient light directly on the screen. Avoid adverse illumination on the screen from direct sunlight or fluorescent lighting fixtures.

The use of controlled ambient lighting, such as incandescent spotlight or a dimmer, is recommended for proper room illumination. Where possible, care should also be taken to ensure that the floors and walls of the room in which the projector is to be installed are non-reflecting, dark surfaces. Brighter surfaces will tend to reflect and diffuse the ambient light and hence reduce the contrast of the projected image on the screen.

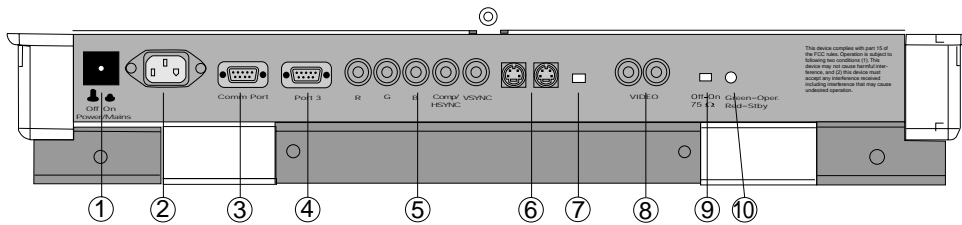

REAR PANEL TERMINOLOGY

- ① **Power Switch:** press the switch to turn the projector ON.
Depending on the hardware set-up of the projector during installation, the projector switches to 'Standby' or to 'Operational' mode. If in standby, the standby LED lights up.
- ② **AC Power Input**
- ③ **Communication Port**
 - allows connection of a remote IR receiver unit to the projector.
- ④ **Port 3**
RGB Analog Input (9 pin female sub D connector). Allows a character generator, microcomputer, etc. having analog RGB outputs to be connected to the projector.
- ⑤ **Port 4/5:** RGB-S Input (5x BNC connector):
RGB-S input: allows a character generator, microcomputer, video camera, etc. having analog RGB Output to be connected to the projector.

Line inputs
 - signals RED-GREEN-BLUE
 - COMPOSITE sync. signal
 - Tri level sync. signal (option>)
- ⑥ **S-VIDEO Input:** (Not Active)
- ⑦ **75 ohm Termination Switch for S-Video signals**
- ⑧ **VIDEO Input:** (Not Active)
- ⑨ **75 ohm Termination Switch for Video signals:** (Not Active)
- ⑩ **Projector Pilot Lamp:** indicates the Status of the projector.
 - unlit: mains (power) switch is not pressed.
 - lit: mains (power) switch is pressed and the indicated color shows the projector mode:
Green color : operational mode of the projector.
Red color: standby mode of the projector.

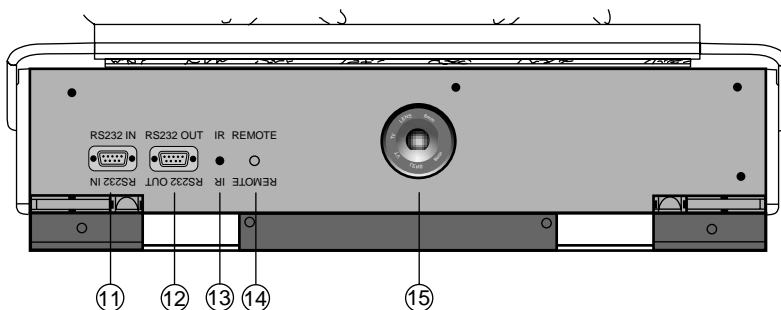

FRONT PANEL TERMINOLOGY

- ⑪ **RS 232 Input Port**
Connection between the DTV-992 / 992 ULTRA and an IBM PC (or compatible) Or MAC (RS422) for remote computer control and data communication.
- ⑫ **RS 232 Output Port**
RS232 Input Port allows a communication link for PC Or MAC to the next projector in a series of projector.
- ⑬ **IR Sensor**
receiver for control signals transmitted from the RCU.
- ⑭ **IR Remote**
Connector for remote input for hard wired remote Control.
- ⑮ **EYE-Q Camera**

Control panel terminology

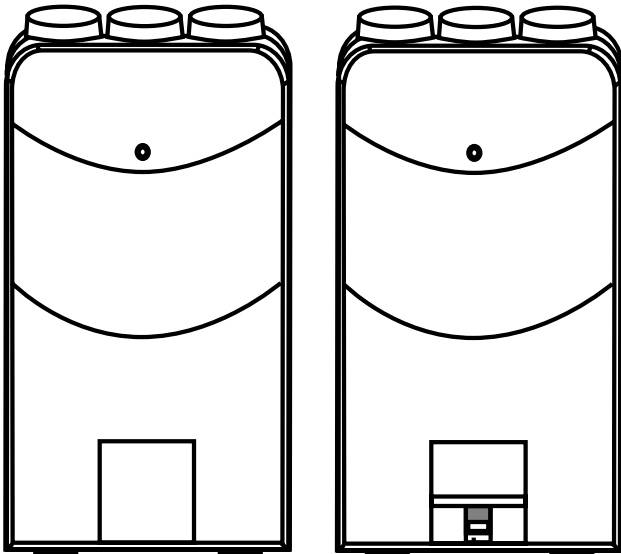

a. The Local Keypad

Getting Access

The local keypad is underneath the top cover door with the Runco logo.

To open this door, push as indicated on drawing and turn it to the front side of the projector.

This local keyboard has the same functions as the Remote Control Unit (RCU)

b. RCU control panel terminology

This remote control includes a battery powered infrared (IR) transmitter that allows the user to control the projector remotely. This remote control is used for source selection, control, adaptation and set-up. It includes automatic storing of picture controls (Brightness, Sharpness)

- picture geometry adjustments
- convergence adjustments

Other functions of the remote control are:

- switching between standby and operational modes
- switching to "pause" (blanked picture, full power for immediate restarting)
- direct access to all connected sources
- variable adjustment speed : when pushing continuously on the control stick or the picture keys, the adjustment will be executed in an accelerated fashion.

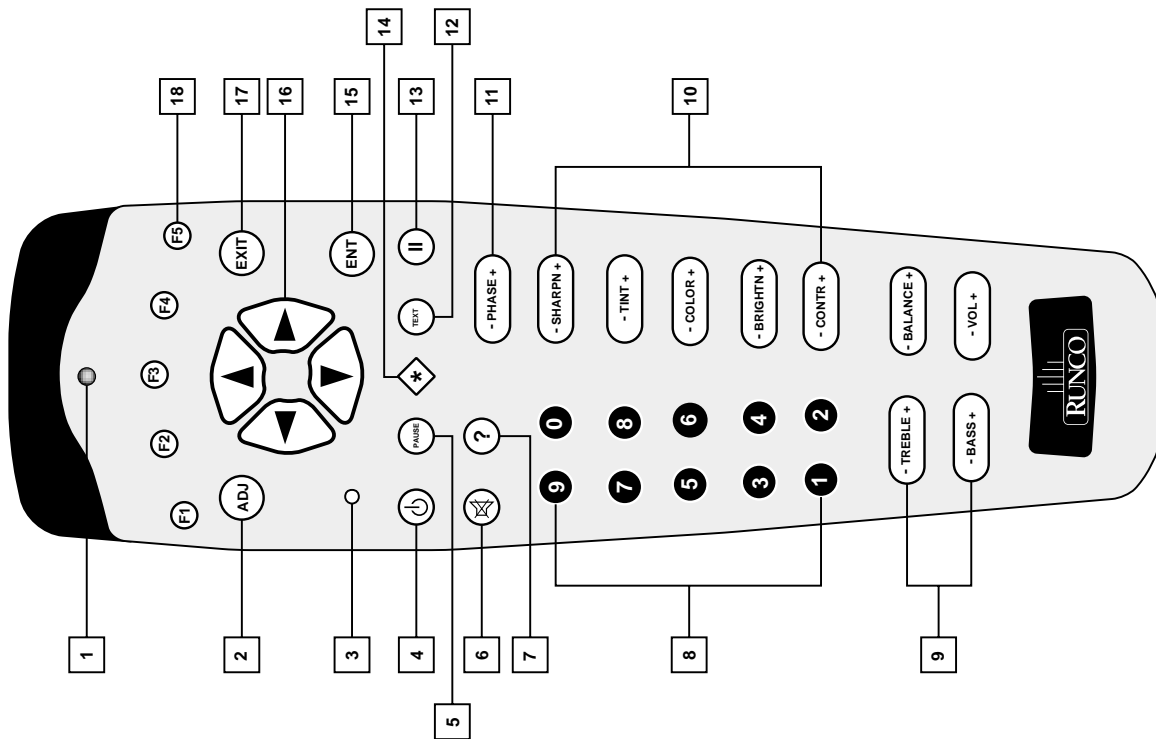

1 IR Transmission Indicator

2 ADJ. : Adjust key, to enter or exit the adjustment mode.

3 Address key (recessed key) : to enter the address of the projector (between 0 and 9). Press the address key, followed by pressing one digit button between 0 and 9. When addressed to 0, the remote will talk to any projector, regardless of its address.

4 STBY : Stand by button:
 - To initiate remote power up operation
 - To stop projection without main power off.

5 Pause : To mute the image, press PAUSE. The image disappears but full power is retained for immediate restarting.

6 Mute : Not used

7 Help : Not used.

8 Digit buttons : Direct aspect ratio selection.

9 Sound controls : Not used.

10 Picture controls : Use these buttons to obtain the desired level (see also "Controlling") for each picture function.

11 Phase : Not used.

12 Text : When adjusting one of the image controls during a meeting, the displayed bar scale can be removed by pressing 'TEXT' key first. To re-display the bar scale on the screen, press 'TEXT' key again. 'TEXT' key is only active in operational mode. When 'TEXT' is off, no warning message will be displayed.

13 FREEZ : Not used.

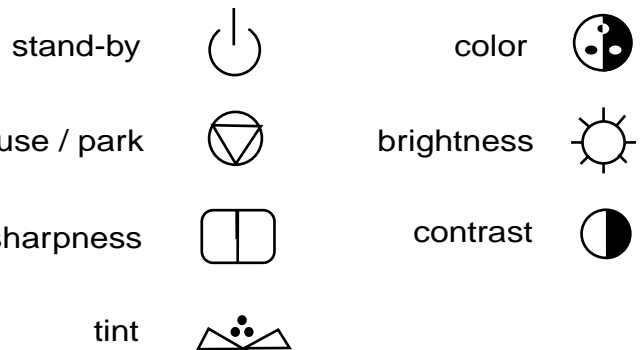

14 For Future Use

15 ENTER : To start up the adjustment mode or to confirm an adjustment or selection in the adjustment mode.

16 Control disc : To make menu selections when in the adjustment mode. Also allows to increment or decrement an adjustment in the adjustment mode.
 Control disc up = up arrow in the menus
 Control disc down = down arrow in the menus
 Control disc to the right = arrow to the right on the menus
 Control disc to the left = arrow to the left on the menus

17 EXIT : To leave the adjustment mode or to scroll upwards when in the adjustment mode.

18 For Future Use

AC Power (mains) Cord Connection

Use the supplied power cord to connect your projector to the wall outlet. Plug the female power connector into the male connector at the backside of the projector.

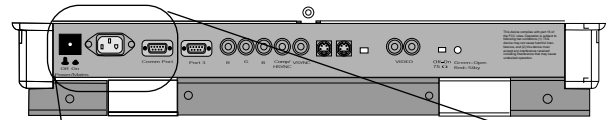

Power Check

Power voltage indication on sticker on the back side of the projector. The power voltage is indicated here.

Warning!

Check if the indicated power voltage corresponds to that of the wall outlet.

If the wall outlet voltage is different, call a Runco technician for power adaptation of the projector.

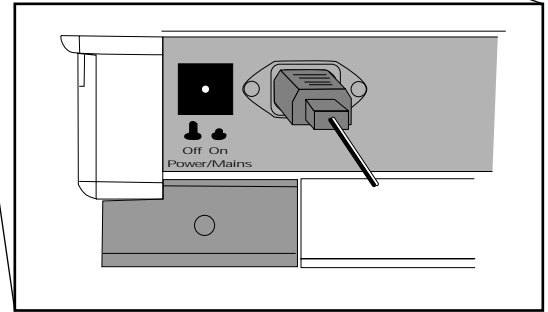

Switching On/Off

The projector is switched ON and OFF using the power (mains) switch ON/OFF.

Pressed : ON
Not pressed : OFF

The projector can start now in the 'operational mode' (image displayed) or in the 'stand by mode', depending on the position of the 'power up' dip switch on the controller unit. This DIP switch must be set during installation by a qualified technician. If you want to change this start up mode, call a qualified technician.

Stand by indication lamp:

no light up: projector switched OFF
green color: projector in Operational mode
red color : projector is in Standby mode.

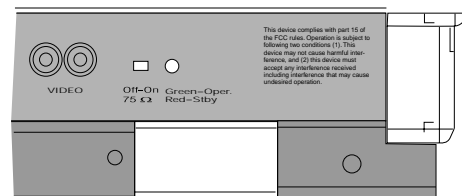
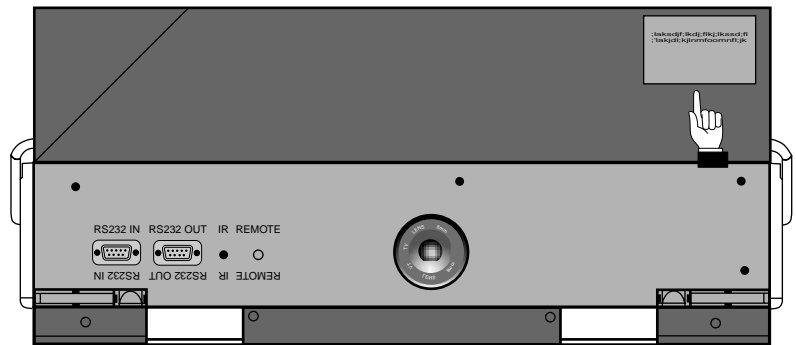

When starting up the projector, with the power switch or via the stand-by key, the projector can start up in two ways if the "CRT run in" cycle option is switched OFF.

- full white image (projector warm up) or
- immediately image display.

The way of starting up can be set in the service mode.

Start up with full white image.

The next menu will be displayed for 30 seconds.

- a. Start up with warm up period.

If no action is taken, a white image will be displayed for 20 minutes.

This white image will be shifted on the faceplate of the CRT to avoid burn in. During this warm up period, it is possible to interrupt this white image projection by pressing the EXIT key. The previous menu will be repeated for another 30 seconds but the remaining time will be indicated.

If EXIT is pressed, the remaining warm up period will be shipped.

During the warm up period, every 30 seconds a text box with the remaining time will be displayed on the screen for 2 seconds. This text box will be displayed every time on another place.

If another key, different from EXIT, is pressed, a text box with following text will be displayed:
Please use <EXIT> to leave this procedure.

- b. Start up without warm up period.

If the EXIT key is pressed, the warm up period will be skipped and the projector is immediately ready for use.

Warning : skipping this warm up procedure can reduce the initial picture quality of the projected image.

Signal Input Connection to the Projector:

- Composite Video
- S-Video
- RGBS or RGsB
- RGB3S or RG3sB (option)

Port No.	Projector Input	Press Digit Button
1	Not Used	Not Used
2	Not Used	Not Used
3	RGB ²	3
4/5	RGB ²	4 or 5
4/5	Component Video ³	6
4/5	RGB with Tri-Level Sync ⁴	7
4/5	Component Video with Tri-Level Sync ⁵	8

Only available when the optional Tri-level sync module is installed.

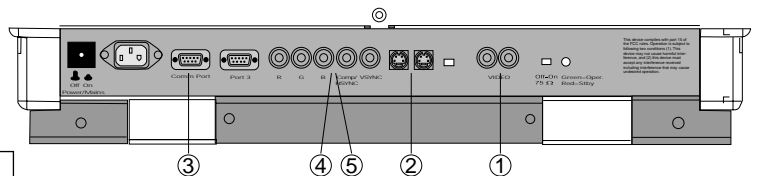
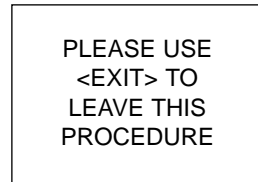
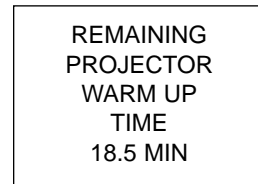
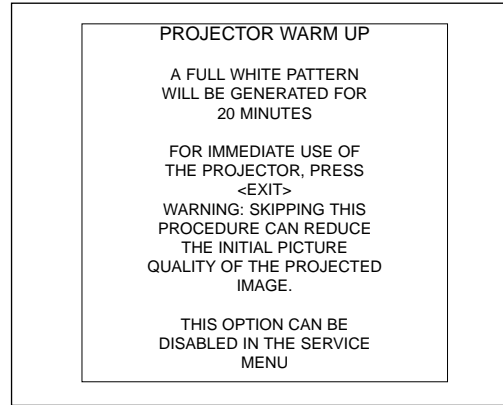

- 1 Not Used
- 2 Not Used
- 3 Input signal : R-Y, Y and B-Y with separate composite sync or with separate Hor and Vert. sync or with composite sync on Y.
- 4 Input signal : R, G and B with separate Tri level sync or with Tri-level sync on green.
- 5 Input signal : R-Y, Y and B-Y with separate Tri level sync or with composite Tri-level sync.

* Video or S-Video : switchable in the Picture Tuning menu.

Connecting a RGB Analog source with composite sync.

RGB analog input terminals with composite sync input or with sync on green. The projector detects automatically where the sync signal is located. Always use an interface when a computer and local monitor have to be connected to the projector. Examples of interfaces which can be applied :

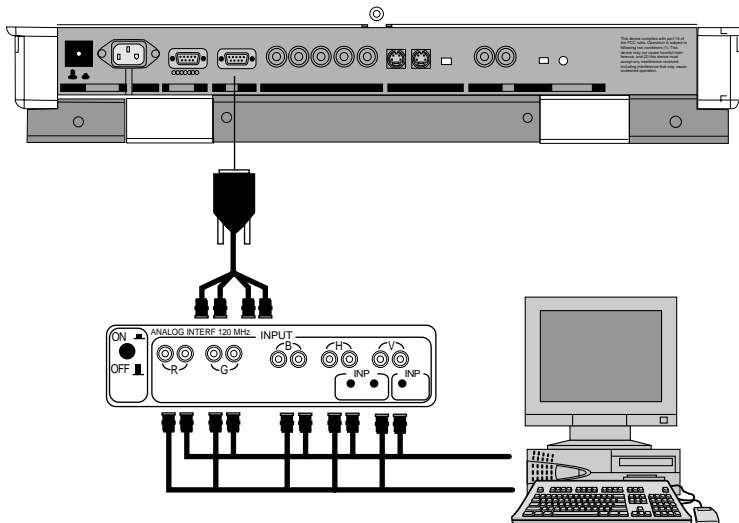

RGBS or RGsB input selection

- a. With the RCU: Select RGB in the Source Selection menu
- b. With the local keypad :

(to gain access to the local keypad, see 'Local keypad' in chapter "Location and function of controls'.)

- Press **ADJUST** key, the General access menu is displayed on the screen.
- Use the control disk to highlight **3**.
- Press **ENTER** to select the highlighted source.

Connecting a RGB Analog source with Tri-level sync.

RGB analog input terminals with Tri level sync input or with Tri-level sync on green. The projector detects automatically where the sync signal is located.

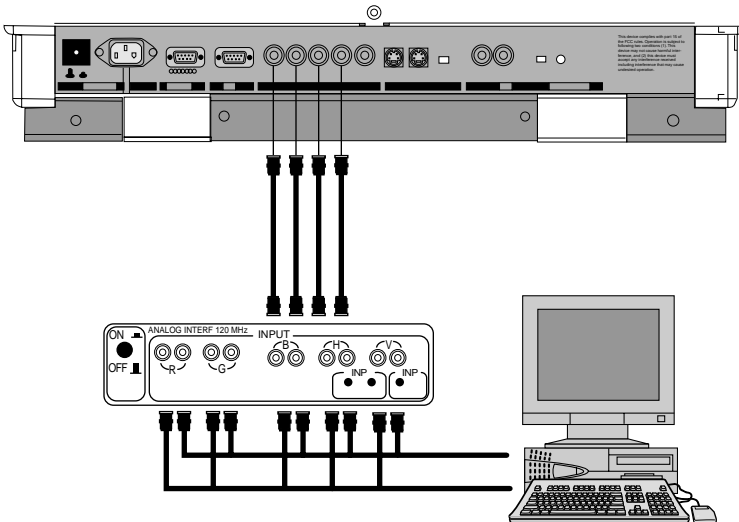

RGB3S or RG3sB input selection

- a. With the RCU: Select RGB in the Source Selection menu
- b. With the local keypad :

- (to gain access to the local keypad, see 'Local keypad' in chapter 'Location and function of controls'.)
- Press **ADJUST** key, the General access menu is displayed on the screen.
 - Use the control disk to highlight **4**.
 - Press **ENTER** to select the highlighted source.

Connecting a Component source.

(R-Y)Y(B-Y) analog input terminals with sync input or with sync on the luminance (Y) input. The projector detects automatically where the sync signal is located.

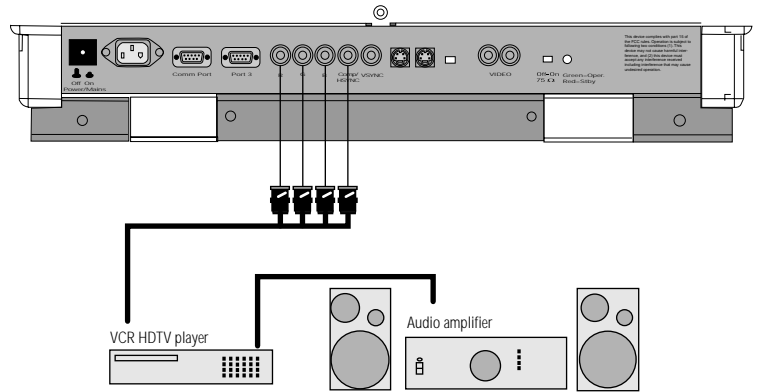

(R-Y)Y(B-Y)S or (R-Y)Ys(B-Y) input selection

- a. With the RCU: Select "Component" in the Source Selection Menu
- b. With the local keypad :
 (to gain access to the local keypad, see 'Local keypad' in chapter 'Location and function of controls'.)
 -Press **ADJUST** key, the General access menu is displayed on the screen.
 -Use the control disk to highlight **5**.
 -Press **ENTER** to select the highlighted source.

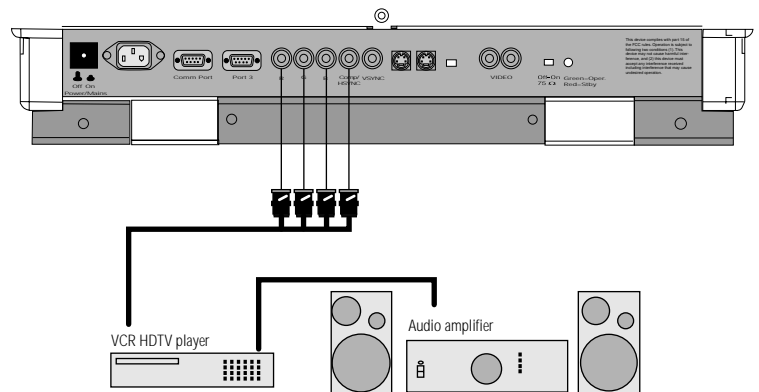

Connecting a Component source with Tri-level sync.

(R-Y)Y(B-Y) analog input terminals with Tri-level sync input or with Tri-level sync on the luminance (Y) input.

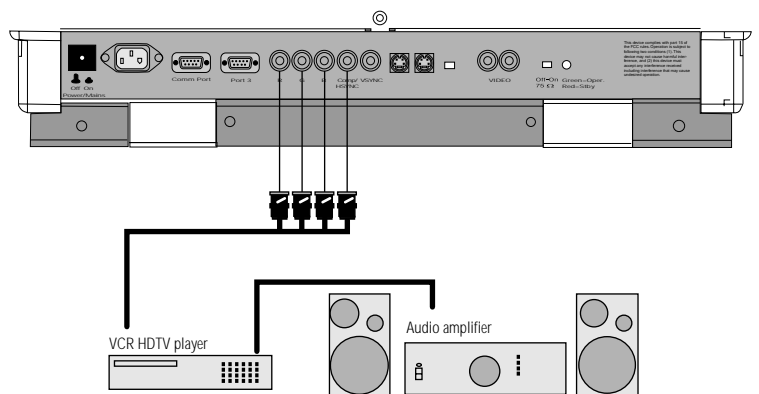

(R-Y)Y(B-Y)3S or (R-Y)Y3s(B-Y) input selection

a. With the RCU: Select "Component" in the Source Selection Menu

b. With the local keypad :

(to gain access to the local keypad, see 'Local keypad' in chapter 'Location and function of controls'.)

-Press **ADJUST** key, the General access menu is displayed on the screen.

-Use the control disk to highlight 6.

-Press **ENTER** to select the highlighted source.

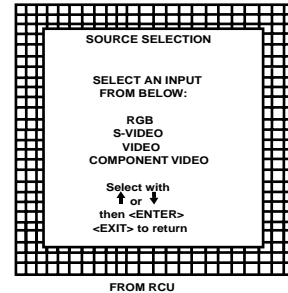
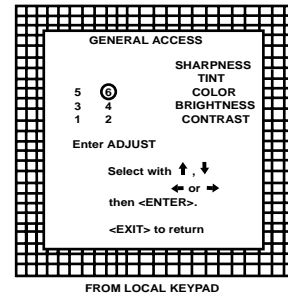

Connecting a computer, e.g. IBM PC (or compatible), Apple Macintosh to the RS232 input of the projector.

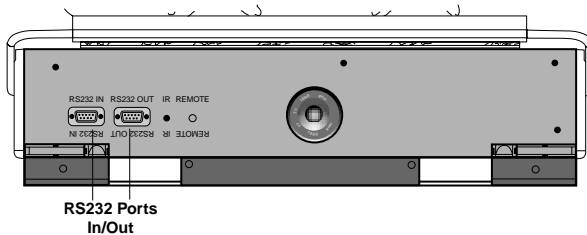

The projector has a RS232 port that allows it to communicate with a computer.

Applications: remote control and data communications.

a) remote control:

- easy adjustment of the projector via IBM PC (or compatible) or MAC connection.
- allow storage of multiple projector configurations and set ups.
- wide range of control possibilities.
- address range from 0 to 255.

b) data communications:

- sending data to the projector or copying the data from the projector to a hard memory device.

Caution : Do not display a stationary image with full brightness and contrast for longer than 10 min., otherwise you risk damage to the CRTs.

Battery installation in the RCU.

A new battery (not yet installed to save the battery life) is delivered inside the plastic bag with the power cord. Install the battery as follows :

Remove the battery cover on the backside of the RCU by pushing the indicated handle a little to the bottom of the RCU. Lift up the top side of the cover at the same time (fig. 1).

Insert the new 9 V battery (type 6F22S or equivalent) in the lower compartment and connect the battery to the contact plate.

Insert the battery into the lower compartment and put the cover back.

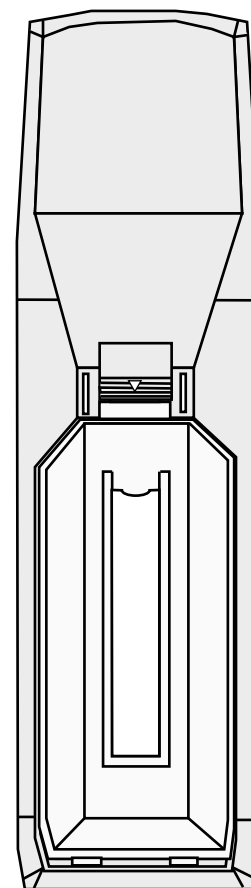
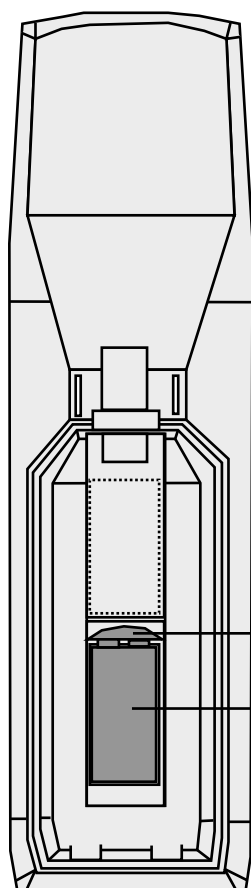
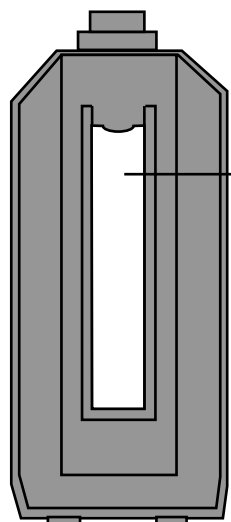

fig.1



Contact plate
Battery



Behind the plastic cover, insert the 'card for RCU'. You can cut out the insert card on the last page of the installation manual.

fig.2

The DTV-992 / 992 ULTRA can be controlled with

- The RCU
- The hardwired RCU (cable not included)
- The local keyboard

The procedure and results of controlling the projector with either of these RCU options is essentially the same.

How to use your RCU

a) Point the front of the RCU towards the projector

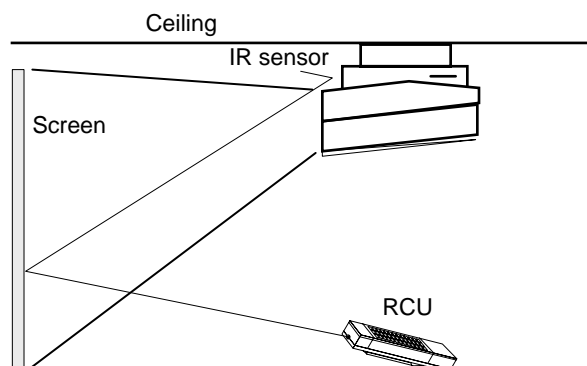

b) RCU used in a hardwired configuration.

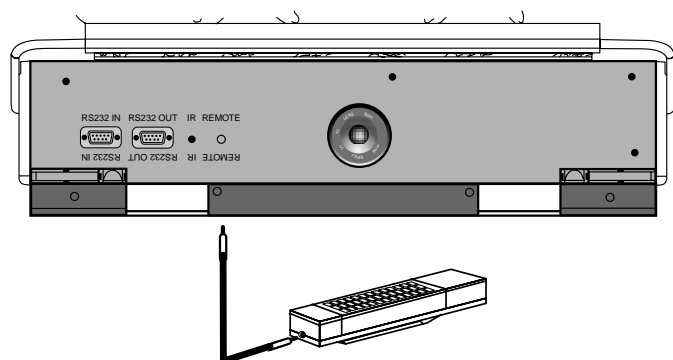

Plug one end of the remote cable in the connector on the bottom of the RCU and the second side in the connector in the rear panel of the DTV-992 / 992 ULTRA labeled 'REMOTE'.

Projector Address

a. Hardware set up of the projector address.

Every projector requires an individual address between 0 and 255 which is set with hardware DIP switches inside the projector. To change that address, contact a RUNCO authorized technician.

b. How to control the projector.

The projector's address may be set to any value between 0 and 255. When the address is set, the projector can be controlled now with :

- the RCU for addresses between 1 and 9.
- computer, e.g. IBM PC (or compatible), Apple MAC, etc. for addresses between 0 and 255.

Note : A projector will respond to a RCU set to an address of '0' regardless of what address is set in the projector itself. Address "0" is therefore a universal address.

c. Using your RCU.

Before using your RCU, it is necessary to enter the projector address into the RCU (only when that address is between 1 and 9). The projector with the corresponding address will listen to that specific RCU.

When address 0, 'zero address' is programmed into the RCU, every projector, without exception will listen to the commands given by this RCU.

How to display a projector address?

Press the ADDRESS key (recessed key on the RCU) with a pencil. The projector's address will be displayed in a 'Text box'. This text box disappears after a few seconds.

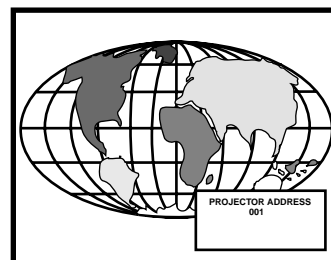

To continue using your RCU, it is necessary to enter the same address with the digit buttons (address between 0 and 9). For example, if the Address Key displays projector address 003, then press the "3" digit button on the RCU to set the RCU's address to match the projector's address. Do not press digit 003. This will address the remote to '0' and control all projectors in the room.

How to program an address into the RCU?

Press the ADDRESS key (recessed key on the RCU) with a pencil and enter the address with the digit buttons. That address can be any digit between 0 and 9.

When programming '0', zero address, the RCU will control a projector regardless of the projector's address. This feature allows multiple projectors with different addresses to be controlled by a single RCU.

Input selection.

GENERAL ACCESS MENU ITEMS	
SOURCE	Projector input
1	Comp. Video
2	S - Video
3	RGBS of RGsB
4	RGB3S or RG3sB
5	(R - Y) Y (B - Y)3S or (R - Y)Ys(B - Y)
6	(R - Y) Y (B - Y)3S or (R - Y)Y3s(B - Y)

Choose from table above. Push the control disk up or down to move the cursor up and down, push the control disk to the left or to the right to move the cursor to the left and to the right. Press **ENTER** to confirm your selection.

When a valid and available source is selected, there will be information displayed on the screen about that source. This information includes :

- Source number
- Horizontal frequency
- Vertical frequency

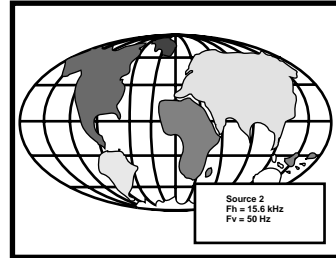

When the entry is a non valid source number, a warning appears on the screen : 'input not available'.

Two possible ways of selecting an input :

a) Display General access menu with RCU by pressing ADJ button. This brings up a secondary general access menu. Choose source selection and highlight desired source.

b) With the local keypad :
Press first the **ADJUST** key to display the General access menu. Use the control disk to highlight the desired source number.

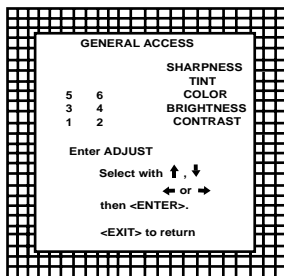
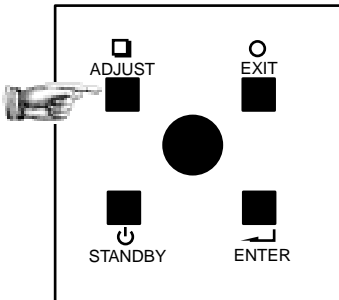

General Access From Local Keypad

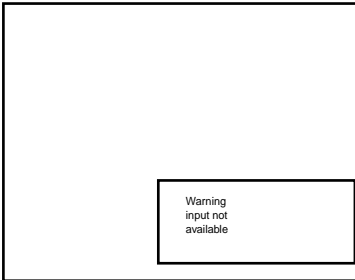
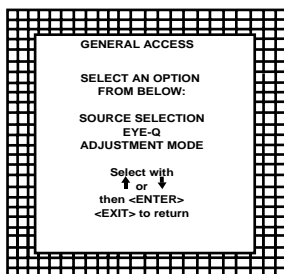

When a valid source number is selected, the projector will display this source or it will wait on the selected source number until the source becomes available. A message 'source not available' will be displayed for a short time.

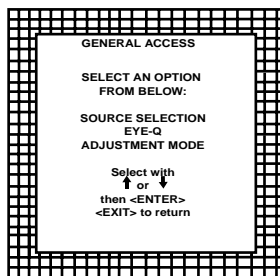
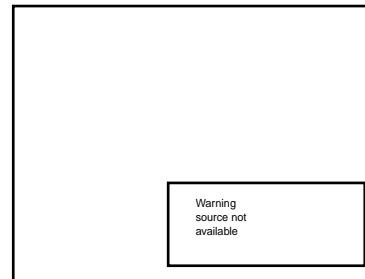

Analog Picture Controls

The analog picture controls can be adjusted with the RCU. The control keys are located on the lower right side of the key panel of the RCU and indicated with the name of the control and an icon. When an analog picture control is pressed, a text box with bar scale and the function name of the control, e.g. 'brightness...' appears on the screen (only if 'TEXT' is ON). The length of the bar scale indicates the current memorized setting for this source. The bar scale changes as the + or - buttons of the control are pressed.

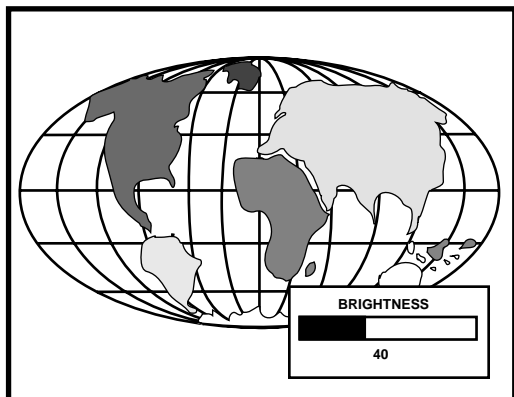

Brightness Control

A correct 'brightness' setting is important for good image reproduction. Adjust the brightness with the + or - button (RCU) until the darkest parts of the picture appear black.

A bar scale gives a visual indication on the screen of the current brightness setting while pressing on the above indicated keys. If the bar scale is not visible on the screen, press 'TEXT' key once and retry the above indicated keys.

The bar scale increases when pressing on the + button (higher brightness) and decreases when pressing on the - button (lower brightness).

Contrast Control

A correct 'contrast' setting is important for good image reproduction. Adjust the contrast to the level you prefer, according to room lighting conditions. If the Contrast Control is too low, the picture will be too dim. If it is set too high, the picture may be too bright and not sharp. A bar scale gives a visual indication on the screen of the current contrast setting while pressing the + or - buttons (RCU). If the bar scale is not visible on the screen, press 'TEXT' key once and retry the above indicated keys.

The bar scale increases when pressing on the + button (higher contrast) and decreases when pressing on the - button (lower contrast).

Color Saturation Control

Color saturation is only active for Video and S-Video. Adjust the color intensity of the picture. Adjust the color saturation using the = and - buttons (RCU) or pushing the control disk to the left or to the right (local keypad). A bar scale gives a visual indication on the screen of the current color setting while pressing on the above indicated buttons. If the bar scale is not visible on the screen, press 'TEXT' key once and retry the above indicated buttons. The bar scale increases when pressing on the + button (richer colors) and decreases when pressing the - button (lighter colors).

Tint Control

Tint is only active for Video and S-Video. Tint control is effective only when using the NTSC 4.43 or NTSC 3.58 system. A bar scale gives a visual indication on the screen of the current tint setting while pressing the + or - buttons (RCU) or pushing the control disk to the left or to the right (local keypad). If the bar scale is not visible on the screen, press the 'TEXT' key once and retry the above indicated buttons.

The bar scale increases when pressing on the + button and decreases when pressing the - button.

Sharpness Control

Sharpness control is only active for Video and S-Video. A bar scale gives a visual indication on the screen of the current sharpness setting while pressing the + or - buttons (RCU) or pushing the control disk to the left or to the right (local keypad). If the bar scale is not visible on the screen, press 'TEXT' key once and retry the above indicated buttons.

The bar scale increases when pressing on the + button (sharper picture) and decreases when pressing on the - button (softer picture).

The Pause key

When the Pause key is pressed, the image projection is muted but the projector remains with full power for immediate restart.

To restart the image :

- Press the Pause key,
- Select a source number.

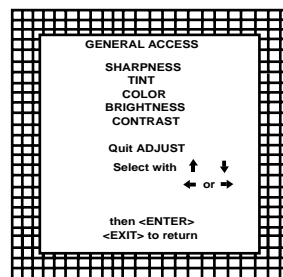

The GENERAL ACCESS MENU is available from the LOCAL KEYPAD. Press the **[ADJ]** 3X to display.

Adjustment mode

All picture geometry and convergence adjustments are made while in the 'Adjustment mode'. Two possible ways to enter the adjustment mode:

a) Using the **RCU**.

Press the **ADJUST** key.
The projector displays the path selection menu.

b) Using the local keypad.

Press the **ADJUST** key.
The projector displays the General access menu.

Use the control disc to highlight enter **ADJUST** and press **ENTER**.
The path selection menu will be displayed.

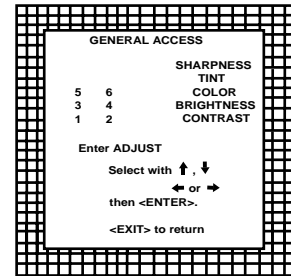
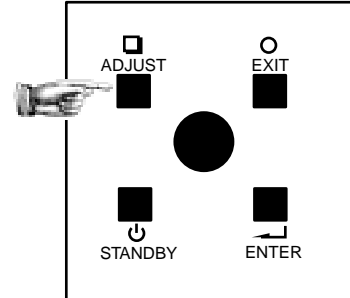

General Access From Local Keypad

Note: to adjust the Analog picture control while in the 'Adjustment mode', press the **ADJUST** key. The next General Access menu will be displayed.

Push the control disc up or down to select the analog control to be adjusted and press the ENTER key to confirm.

When the analog control is adjusted the projector returns automatically to the General access menu. When you want to return to the Adjustment mode, press **EXIT**, otherwise select quit **ADJUST** and press **ENTER** to return to operational mode.

You are now in the 'Adjustment mode'. The control disc is used to make menu selections and also vertical and horizontal adjustments. The ENTER and EXIT keys are used to move forward and backward through the menu structure. The ADJUST key can be used to terminate the adjustment mode while a path selection menu (head menu) is displayed.

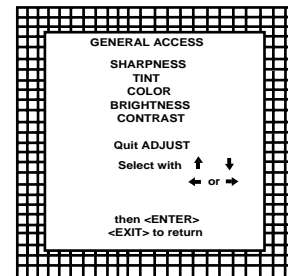

There are 5 possible paths to follow once in the Adjustment mode. They are :

INSTALLATION - Installation should be selected if the projector has been relocated and/or a different screen size is desired.

When selecting 'Installation', the user or operator will be warned to call a qualified technician to perform the installation procedure (see example of projected warning on next page).

GUIDED - Guided should be selected if the user intends to perform a complete alignment of the projected image. All of the necessary geometry and convergence adjustments are made in a predetermined sequence.

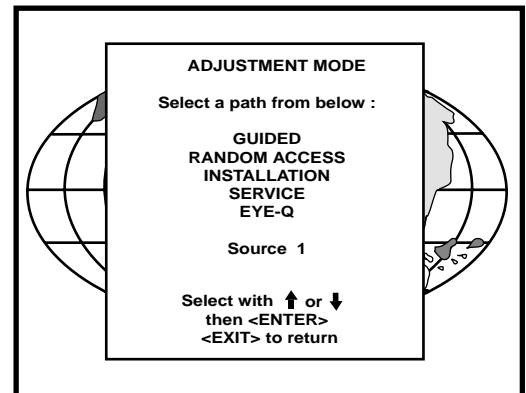

RANDOM ACCESS - Random Access should be selected if the user intends to make only a few adjustments.

SERVICE - Service should be selected if the user intends to delete blocks, change password or apply information.

EYE-Q - This selection will only be available when the subconvergence unit EYE-Q is connected to the projector.

While in Guided or Random Access adjustment Mode, the user may use an external source, an internally generated genlocked pattern or an internally generated multifrequency cross hatch pattern as a setup pattern. Some items in the Adjustment mode are password protected. While selecting such an item, the projector asks you to enter your password. (Password protection is only available when the password DIP switch on the controller module is in the ON position. Contact a RUNCO authorized technician when no password is requested during the adjustment procedure and password protection is desired.)

Your password contains 4 digits.

a) Adjusting the projector with the RCU.

Enter the digits with the numeric keys on the RCU.

Example : 2 3 1 9

For each digit entered, a 'X' appears on the screen under the displayed text 'enter password'

When your password is correct, you get access to the 'Adjustment mode'. When the entered password is wrong, the message 'Wrong password !!!' will be displayed. The projector stays on the previous selected item.

Factory programmed password : **0000**

b) adjusting the projector with the local keypad.

When the 'compose password' menu is displayed, select with control disc the first digit of your password and press **ENTER**. Continue by selecting the second digit with the control disc and press **ENTER**. Handle in the same way for the third and fourth digit.

When your password is correct, you get access to the 'Adjustment mode'.

When the entered password is wrong, the message 'Wrong password' will be displayed.

Once the password is correctly entered, all other password protected items are accessible without re-entering your password. When re-entering the adjustment mode, it will be necessary to enter your password again when selecting a password protected item.

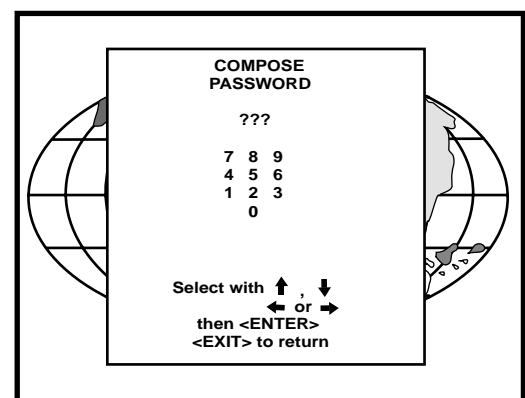
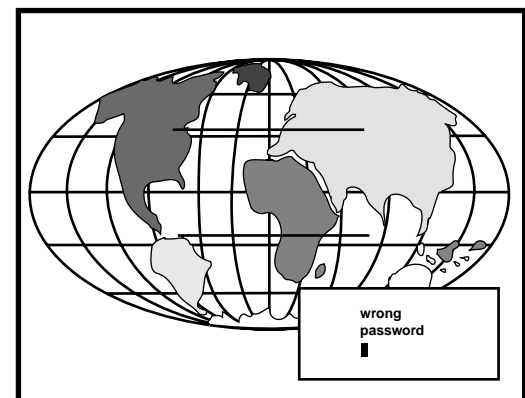
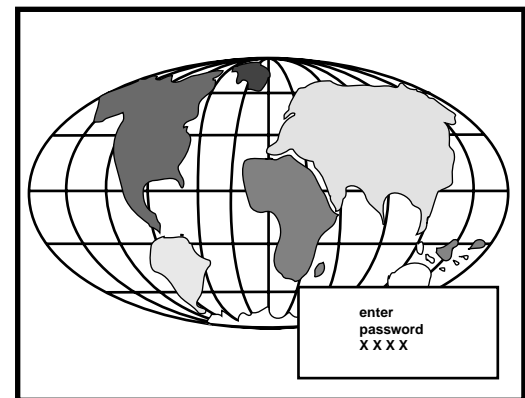
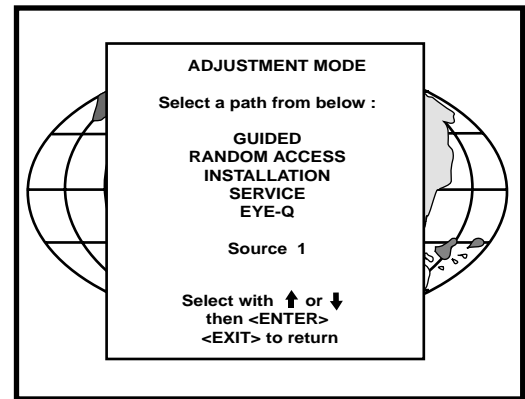

Starting up the random access adjustment mode

Push the control disc up or down to highlight "RANDOM ACCESS" and the press ENTER.

Some items in the Random access mode are password protected (when the password function is enabled). Enter your password to continue. All other password protected items are now also available if

ENTER continues to Setup Pattern Selection
EXIT returns to operational mode

you stay in the adjustment mode.

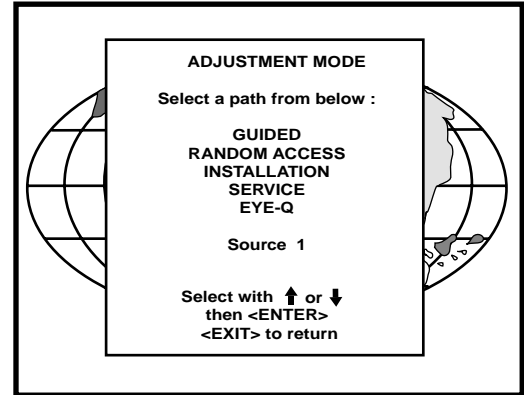

Overview 'Random Access Adjustment' mode.

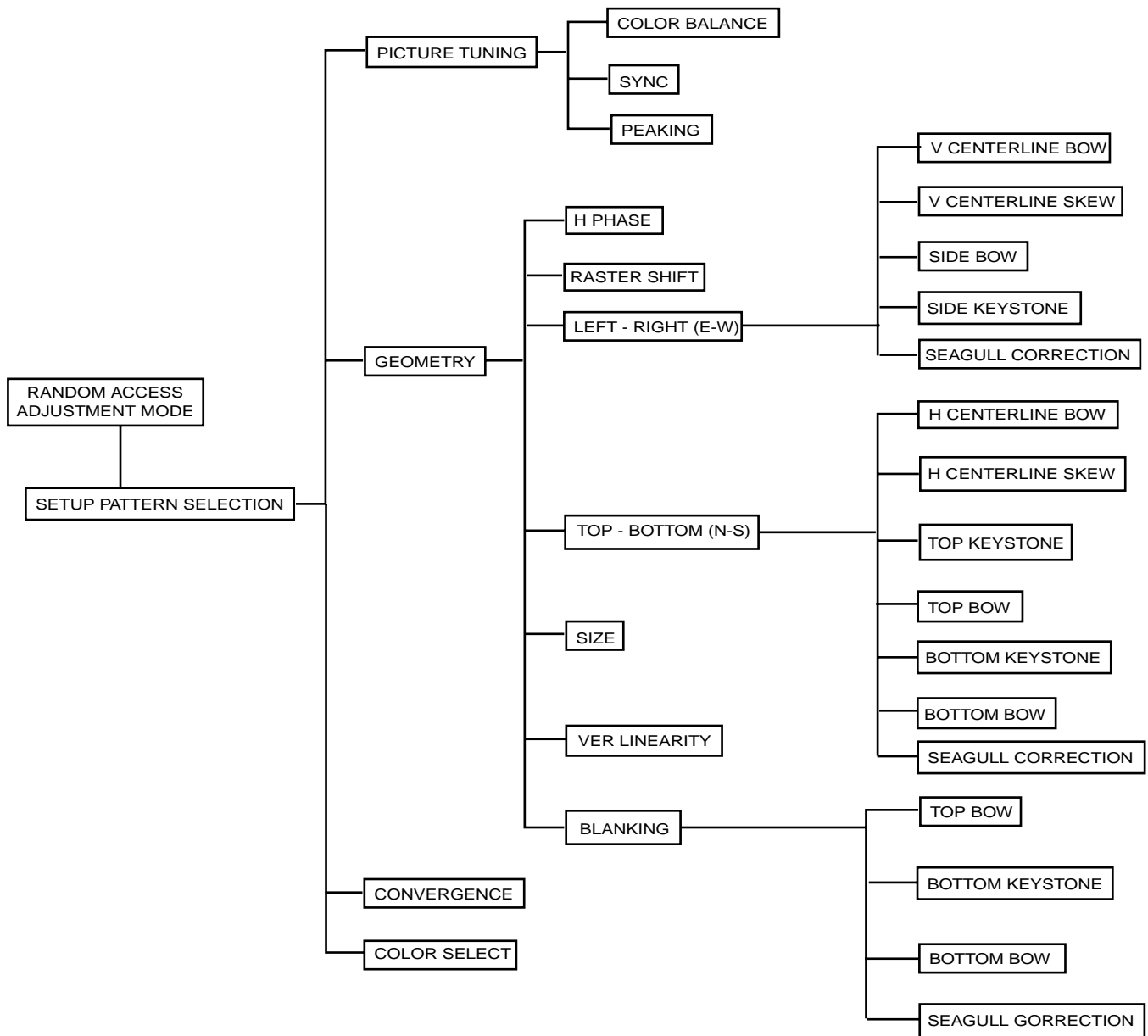

Selecting Setup Pattern

If an external source is connected to the projector, this menu will be displayed. Push the control disc up or down to highlight the desired setup pattern and then press **ENTER**.

Genlocked pattern : internally generated cross hatch pattern, locked on the external source.

Internal # pattern : internally generated cross hatch pattern and locked on internal generated sync signals. (no external source necessary)

ENTER continues to Random Access Adjustment Mode or Internal # Pattern Selection.
EXIT returns to Path Selection menu.
ADJUST returns to Operational mode.

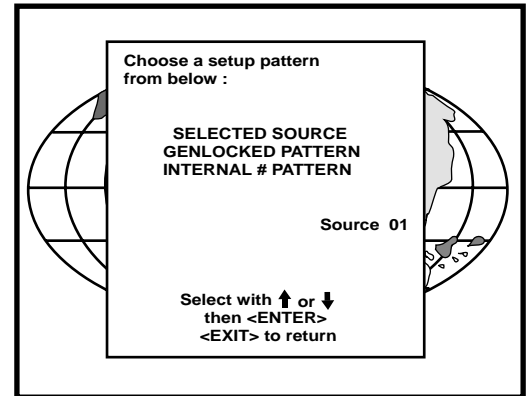

If no external source is connected to the projector, the internal cross hatch pattern menu will be displayed.

Note: The menus in the manual are created for an external source, connected to one of the inputs, and the 'Genlocked Pattern' is selected.

Internal Cross Hatch Pattern

The internal # pattern menu will be displayed if the internal cross hatch pattern has been selected or if no source is connected to the projector.

The table below lists the 8 fixed factory preset frequencies available. Another 8 blocks are custom programmable.

Push the control disc up or down to highlight the desired cross hatch frequency. Push the control disc to the left or to the right to scroll to another page. Press **ENTER** if the desired block is selected.

15.6/50	PAL/SECAM
15.7/60	NTSC
31.2/50	EDTV
31.5/60	IDTV
31.2/50	HDTV EUREKA
31.5/60	HDTV ATV
33.7/60	HDTV HISION
15.8/60	EGA 1
21.8/60	EGA 2
31.5/60	VGA 3
31.5/70	XGA 1,2
35.5/97	VGA 4
44.2/70	SUPER VGA 2
48.5/60	SUPER VGA 1
61.0/76	SUPER VGA 3
63.9/76	APOLLO

ENTER continues to the Random Access Adjustment Mode.
EXIT returns to the Setup Pattern Selection menu.

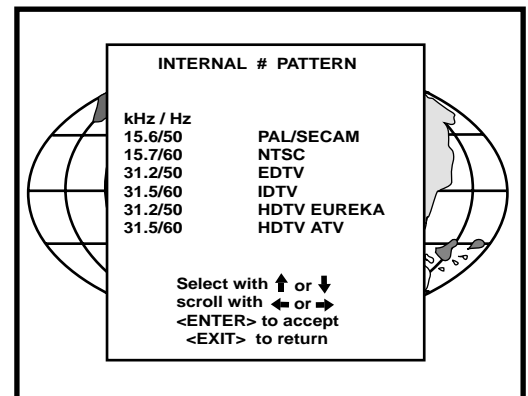

Random access adjustment mode selection menu

This is the main menu for the Random Access adjustment mode. Through this menu, the following adjustments and features are accessible:

- Picture Tuning
 - Sync slow/fast (video/s-video)
 - Color Balance
- Geometry
- Convergence
- Color Select

And also Orbiting, Contrast modulation and Soft Edge, if these options are installed.

Picture Tuning

Highlight Picture tuning by pushing the control disc up or down and press **ENTER**. The Picture tuning menu will be displayed. Depending on the input source, the 'Picture tuning' menu will display different items.

- Color Balance
- Sync slow/fast
- Peaking

Color Balance

The Color Balance function is used to select or adjust the color temperature of white used by the projector.

The Color Balance can be adjusted in two different ways:

- fixed color balance. You have the choice between 3200k (reddish), 5400 K, 6500 K (white), or 9300 K (bluish).
- Custom white and black balance.

Fixed Color Balance

Highlight one of the 4 programmed color temperatures with the control disc and press **ENTER** to display the desired color balance.

Custom Color Balance

Select custom white balance by pushing the control disc up or down and press **ENTER** to start the adjustment. Push the control disc up or down to adjust the red gain and push the control disc to the left or right to adjust the blue gain. A bar scale indicates the amount of adjustment. Select custom black balance with the control disc and press **ENTER** to start the adjustment. Push the control disc up or down to adjust the red cut-off and push the control disc to the left or to the right to adjust the blue cut-off. When the color balance is adjusted, select continue by pushing the control disc up or down and press **ENTER**.

Sync Fast/Slow Adjustment

The sync function is used to minimize horizontal jittering or tearing at the top to the displayed image. Highlight **SYNC** with the control disc and press **ENTER** to toggle between **FAST** and **SLOW**.

Note: SYNC is normally used in the SLOW position. The FAST position is used to compensate for unsteady sync pulses from older video playback equipment, such as a VCR.

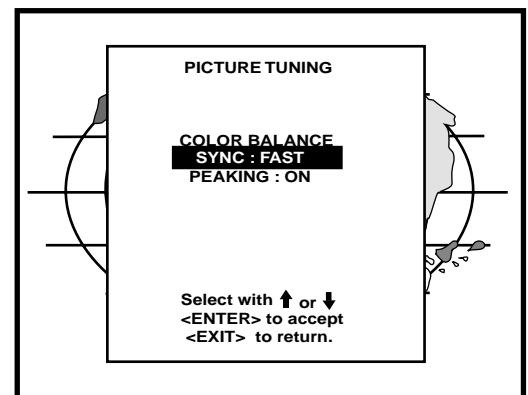
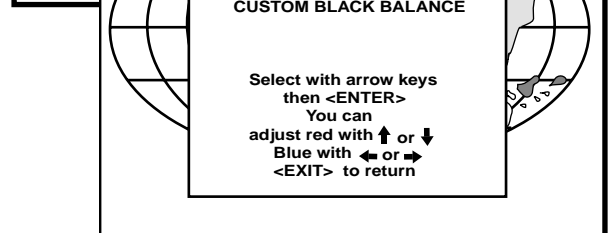
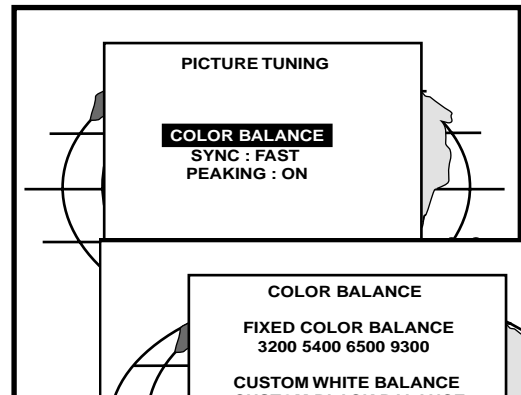
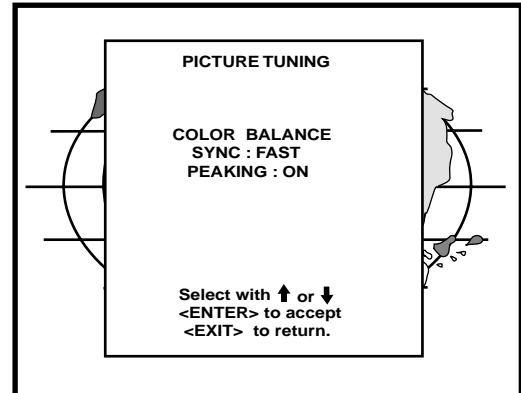
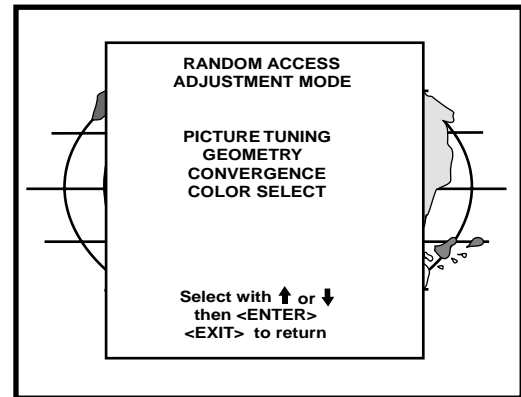

**ENTER will toggle Sync between FAST and SLOW.
EXIT will return to the Random Access Adjustment menu.**

Peaking

Peaking improves the contours in a projected image. Highlight *PEAKING* by pushing the control disc up or down and press **ENTER** to toggle the peaking between OFF and ON. During the creation of new settings for a RGB source the peaking is switched to OFF.

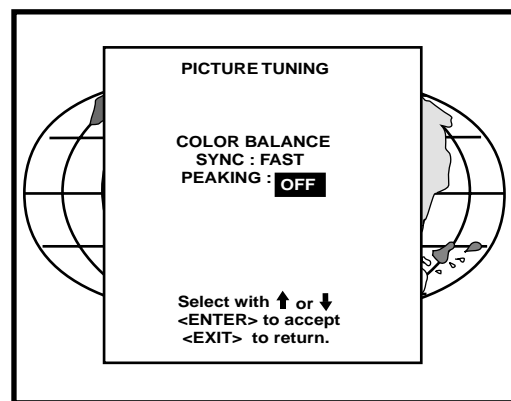

Color Select

Highlight *COLOR SELECT* by pushing the control disc up or down and press **ENTER** to display the color select menu.

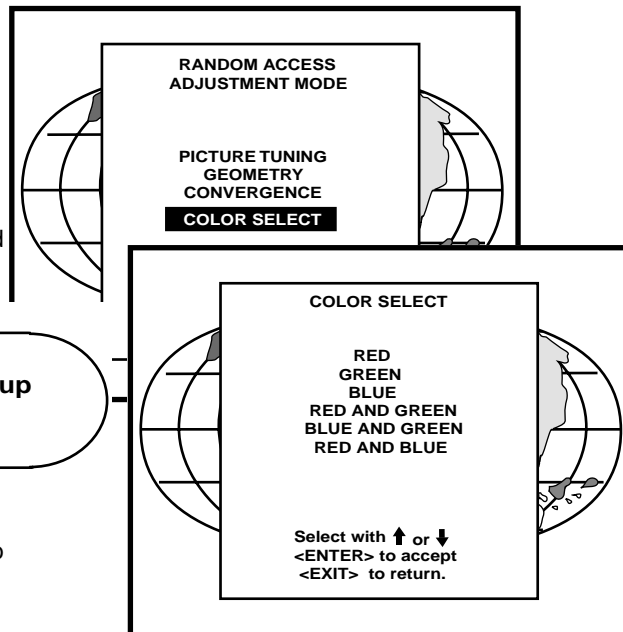

ENTER continues to the color select menu.
EXIT will return to Internal Crosshatch Selection or Setup Pattern Selection Menu.
ADJUST returns to operational mode.

Use the control disc to highlight a color (CRT) or combination of colors to display the projected image in that specific color. To select a new color, press **ENTER**, the color selection menu appears.

ENTER continues to the color select menu.
EXIT will return to Internal Crosshatch Selection or Setup Pattern Selection Menu.
ADJUST returns to operational mode.

Clamp Tuning

Highlight *CLAMP TUNING* by pushing the control stick forward or backward and press **ENTER** to toggle between NORMAL and RESTORATION.

Select Normal :

- for all standard sources and all sources with a bac porch > 0.8ms,
- for sources with noise and spikes in the signal.

Select Restoration

- for standard sources with a backporch between 0.4 ms and 0.8 ms,
- for sources with sync separate or sync on Green.

Port 2 : Video or S-Video

Port 2 can be used as a Video or S-Video input. Highlight Port2 by pushing the control stick forward or backward and press **ENTER** to toggle between VIDEO and S-VIDEO.

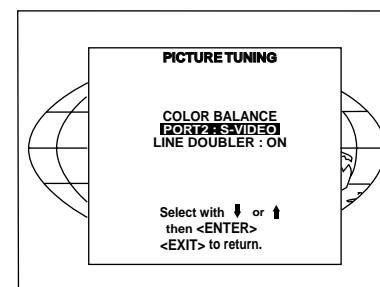
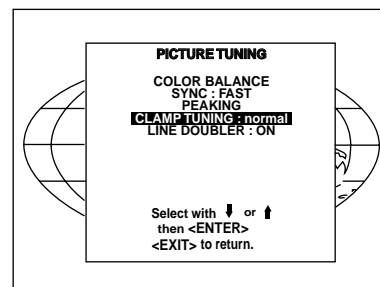

Focusing

Before starting the 'focusing' adjustment, be sure the lenses are correctly focused.
Push the control stick forward or backward to select 'Focusing' and press **ENTER**.

ENTER continues to the Focusing color select menu.
EXIT returns to Internal Crosshatch Selection or Setup Pattern Selection menu.
ADJUST returns to operational mode.

Focusing color select

The focusing has to be done for the three colors separately. Therefore, start by selecting Green by pushing the control stick forward or backward and adjust Midpoint, top, bottom left and right focusing. Return to this focusing color select menu and continue with Red and Blue. Repeat for both colors Midpoint, top, bottom left and right focusing.

ENTER selects the focusing menu for the selected color.
EXIT returns to the Random access main menu.

Midpoint focusing

Push the control stick forward or backward to select midpoint and press **ENTER** continue with the midpoint focusing.

Adjust by pushing the control stick to the left or to the right until the center of the image is sharp.
Press **ENTER** to return to the focusing menu.

Top image focusing

The same procedure has to be repeated as for the midpoint focusing. Push the control stick forward or backward and press **ENTER** to continue to the top focusing.
Push the control stick to the left or to the right to adjust the top focusing. Adjust until the upper part of the image is sharp. **ENTER** to return to the Green Focusing menu.

Bottom image focusing

The same procedure has to be repeated as for the midpoint focusing. Push the control stick forward or backward to select bottom and press **ENTER** to continue to the bottom focusing.
Push the control stick forward or backward to adjust the bottom focusing. Adjust until the lower part of the image is sharp. **ENTER** to return to the Green Focusing menu.

Left image focusing

The same procedure has to be repeated as for the midpoint focusing. Push the control stick forward or backward to select LEFT and press **ENTER** to continue to the left focusing.
Push the control stick forward or backward to adjust the left focusing. Adjust until the left part of the image is sharp. **ENTER** to return to the Green Focusing menu.

Right image focusing

The same procedure has to be repeated as for the midpoint focusing. Push the control stick forward or backward to select RIGHT and press **ENTER** to continue to the right focusing.
Push the control stick to the left or to the right to adjust the right focusing. Adjust until the right part of the image is sharp. **ENTER** to return to the Green Focusing menu.

When on the Green Focusing menu, press **EXIT** to return to the focusing color select menu and continue with the other colors.

Blue on source

After focusing the three color, and a discoloring on a normal image is still visible, select 'Blue on source' on the Focusing menu and repeat the above steps for Midpoint, top, bottom left and right focusing. Press **EXIT** to return to focusing menu.

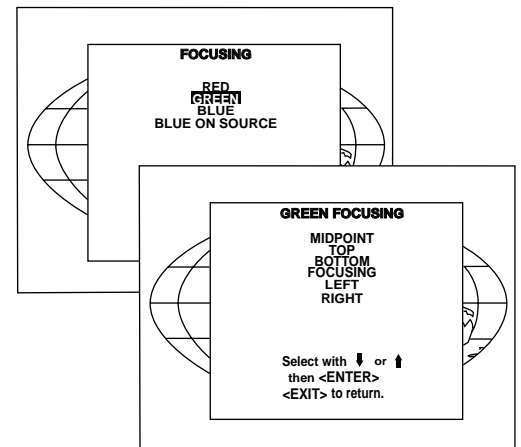
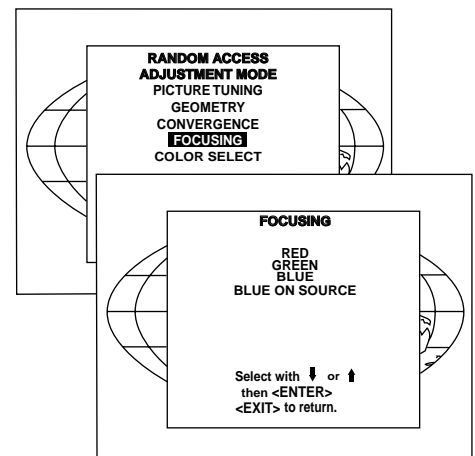

Geometry Adjustments

The geometry adjustments have to be done only on the green image. These adjustments are automatically implemented for the other color images : Left-right (EW) and Top-Bottom Corrections, Blanking, Horizontal Amplitude, Vertical Amplitude, Vertical Linearity and Horizontal Phase.

Highlight *GEOMETRY* by pushing the control disc up or down and press **ENTER** to display the geometry menu.

ENTER will display **Geometry** menu.
EXIT will return to **Internal Crosshatch Selection or Setup Pattern Selection Menu**.
ADJUST returns to operational mode.

Within the Geometry Adjustment menu, the following adjustments are available :

- Horizontal Phase (not for internal # pattern).
- Raster Shift
- Left-Right Corrections
- Top-Bottom Corrections
- Horizontal Size
- Vertical Linearity
- Vertical Size
- Blanking

The convergence corrections are disabled during geometry corrections. The blanking corrections are only enabled during the blanking adjustments.

Horizontal Phase Adjustment

Push the control disc up or down to highlight *H PHASE* on *Geometry* menu and the press **ENTER**.

Note : No horizontal phase adjustment is available on the internal # pattern.

For external sources :

If the raster shift is correctly adjusted, the H Phase text box is projected in the middle of the raster. At that moment, the "><" icon indicates the middle of the raster. Adjust the H Phase control until the middle of the projected image is equal with the middle of >< icon.

Note : If the genlocked pattern was selected, the external source will be displayed.

A bar scale and a number indicator (between 0 and 100) on the screen give a visual indication of the horizontal phase adjustment.

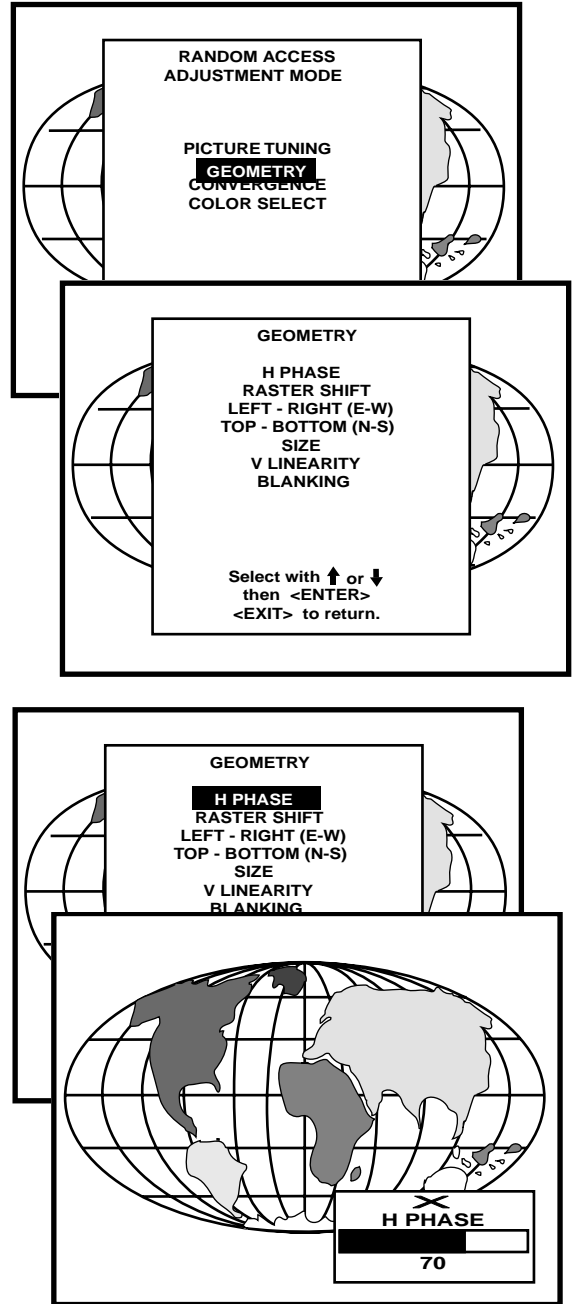

ENTER continues to geometry menu.

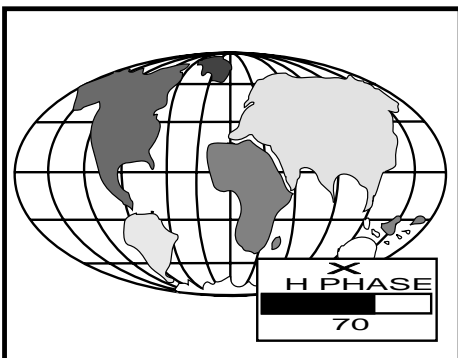

Push the control disc to the right to correct

Push the control disc to the left to correct

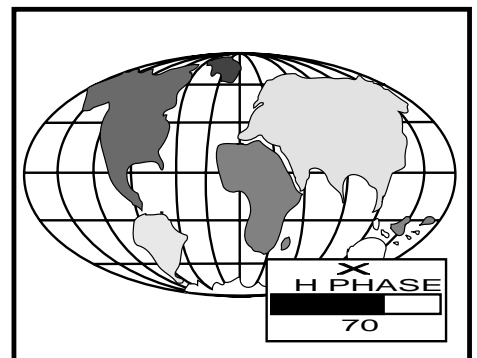

Raster Shift Adjustment

The green raster must be centered both horizontally and vertically on the center of the CRT surface. To center the green raster, look into the green lens and use the control disc to move the raster.

CAUTION

It is necessary to look into the lenses to perform these adjustments. To avoid eye discomfort while looking into the lenses, reduce the contrast and gradually increase the brightness level until the raster becomes visible on the face of the CRT.

ENTER will select green raster shift adjustment.
EXIT returns to random access adjustment mode menu.

Warning : In order to ensure maximum CRT longevity and to avoid CRT damage, do not shift the raster outside the phosphor area of the CRT.

To start the adjustment, use the control disc to highlight Raster shift and press ENTER to display the green raster on the phosphor.

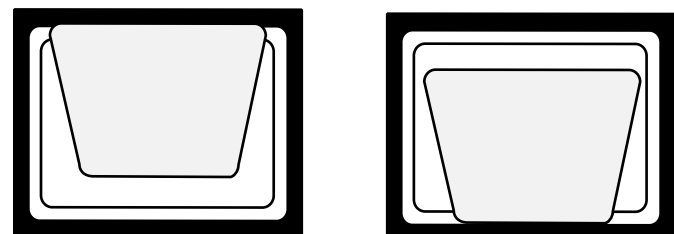
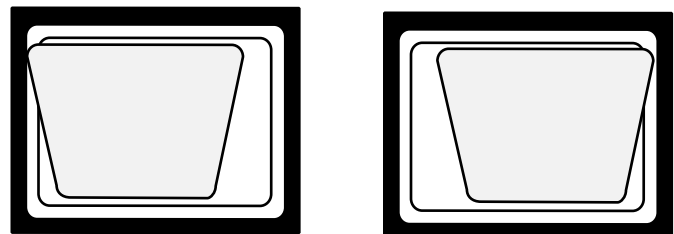
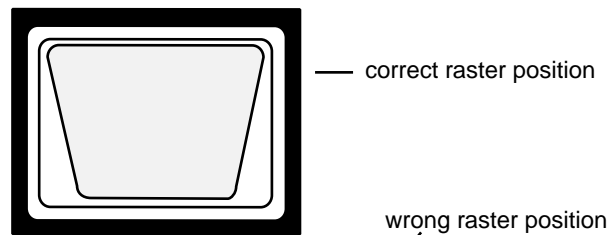
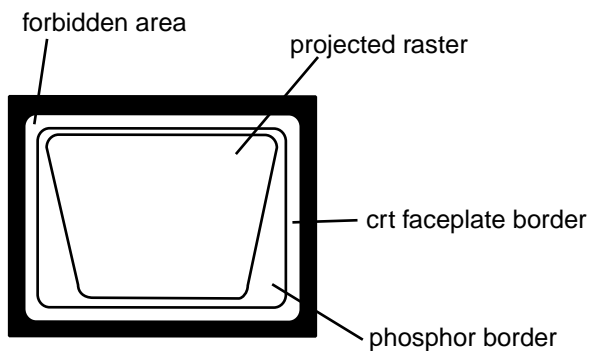
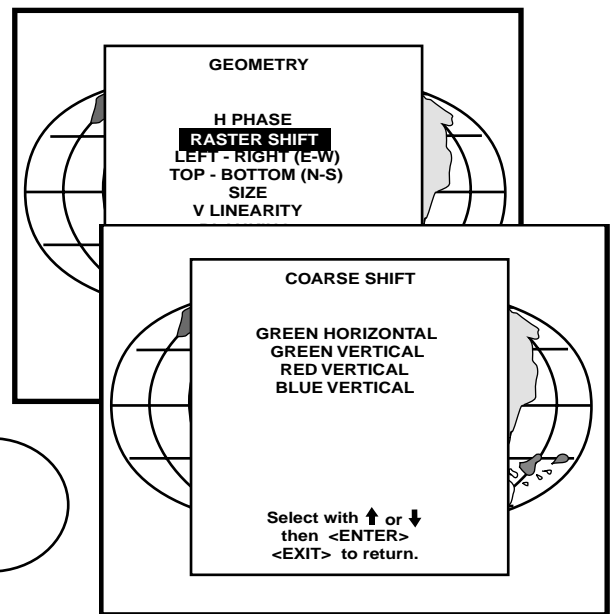

Press **EXIT** to return to the Geometry menu.

Note : Horizontal and Vertical shifts for Red and Blue should end up with a setting close to 50%. If these settings are significantly greater or lesser than 50%, contact a RUNCO authorized service technician.

Left-Right (east-west) Adjustments

Left-right and center adjustments affect only the vertical lines of the projected image.

To start up the left-right and center adjustments, follow the next procedure :
 Push the control disc up or down to highlight **LEFT-RIGHT (E/W)** on the geometry menu and then press **ENTER**.

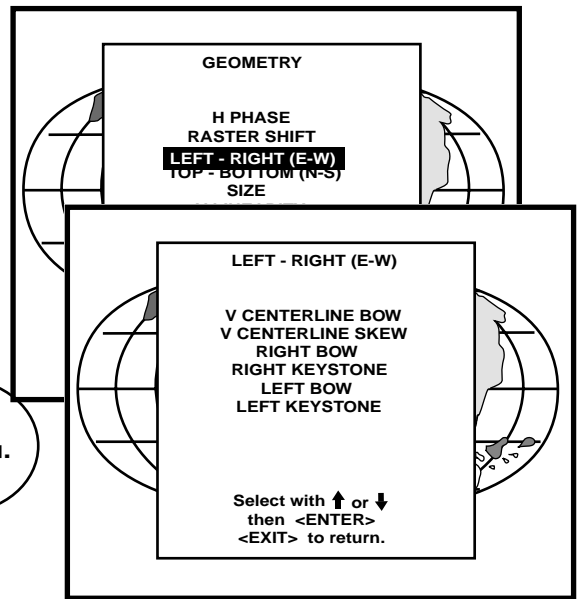

ENTER will select Left - Right adjustment menu
EXIT returns to random access adjustment mode main menu.
ADJUST returns to Operational mode

Only the green image is displayed while making left-right adjustments. The red and blue images will automatically be corrected in the same manner. Convergence corrections are automatically disabled for the duration of these adjustments.

The following adjustments can be executed

- vertical centerline bow
- vertical centerline skew
- side keystone (left - right)
- side bow (left - right)

All adjustments are indicated on the screen with the function name, a bar scale and a number between 0 and 100. Adjust the next alignments until the vertical lines are straight.
 To enter an alignment, push the control disc up or down to highlight a function and press **ENTER** to activate this function. Press **EXIT** to return.

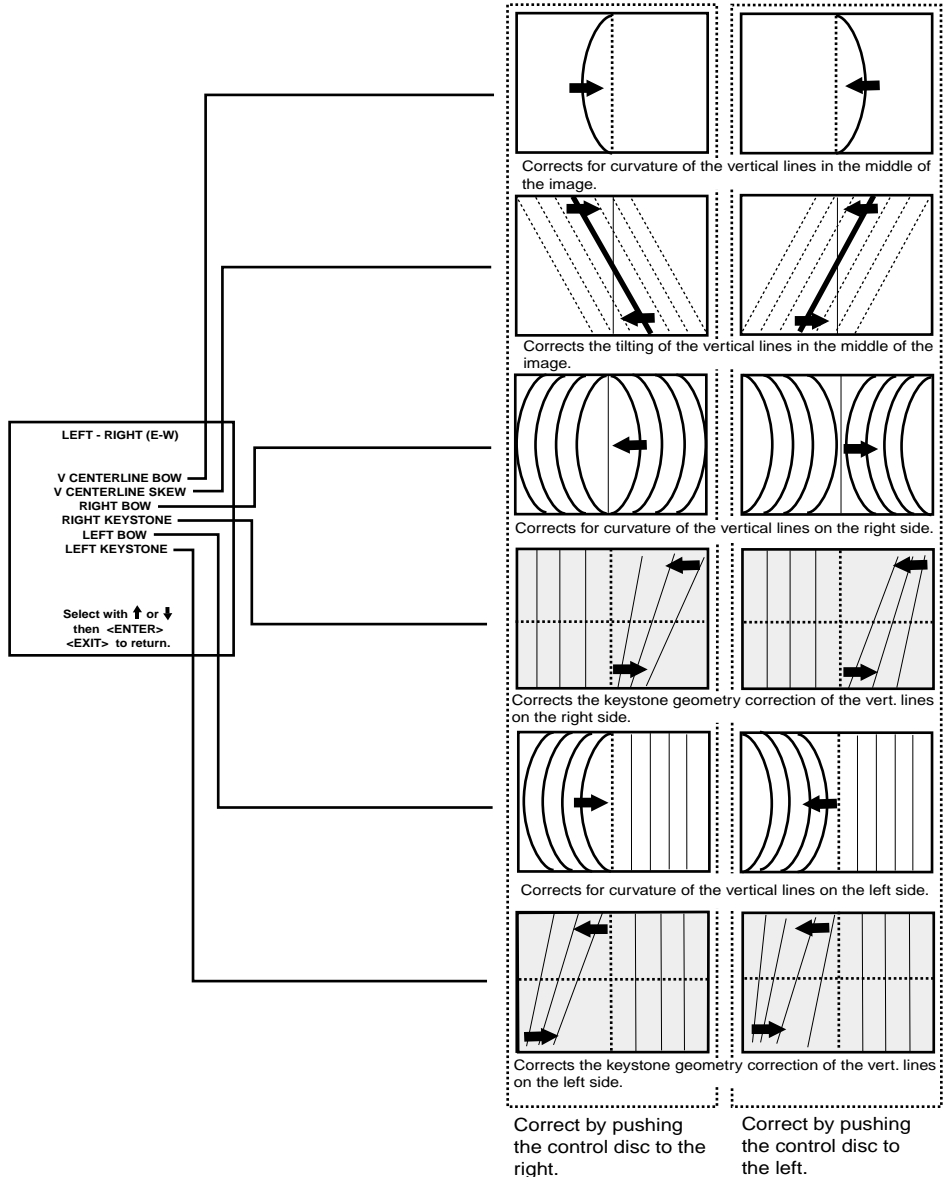

Correct by pushing the control disc to the right.

Correct by pushing the control disc to the left.

Seagull correction

Use this correction only if, after adjusting the vertical lines with the side bow or side keystone, still a 'S' deformation is visible on the left and the right side of the image.
The default value on the bar scale for this correction is 50.

Push the control stick forward or backward to highlight SEAGULL CORRECTION on the Left-Right menu and then press ENTER.

Eliminate the deformation by pushing the control stick to the left or to the right until a straight line is obtained.

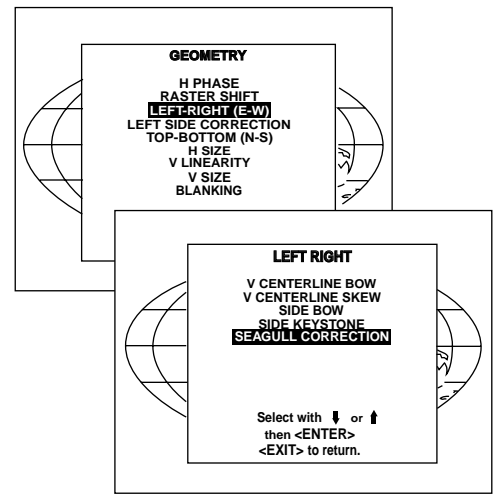
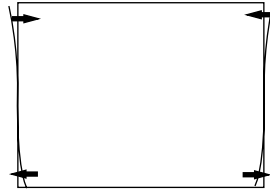

Left Side Correction

Left side corrections affect only the vertical lines of the set up pattern. Only the green image is displayed while making the left side adjustments. The red and blue images will automatically be corrected in the same manner.

Convergence corrections are automatically disabled for the duration of these adjustments.

Look only to the left side of the image while adjusting these fine tunings (bow and keystone). Before starting the left side correction, insure that the side bow and keystone adjustments are done prior to these fine adjustments!

The following adjustments can be executed:

- Left keystone
- Left bow

Push the control stick forward or backward to highlight LEFT SIDE CORRECTION on the geometry menu and then press ENTER.

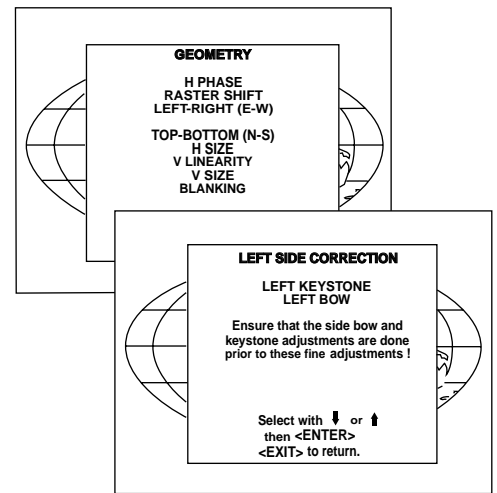

ENTER will select the Left Side Correction menu.
EXIT will return to the random access adjustment menu.
ADJUST returns to operational mode.

All adjustments are indicated on the screen with the function name, a bar scale and a number between 0 and 100.
Adjust the next alignments until the vertical lines on the left side are straight.

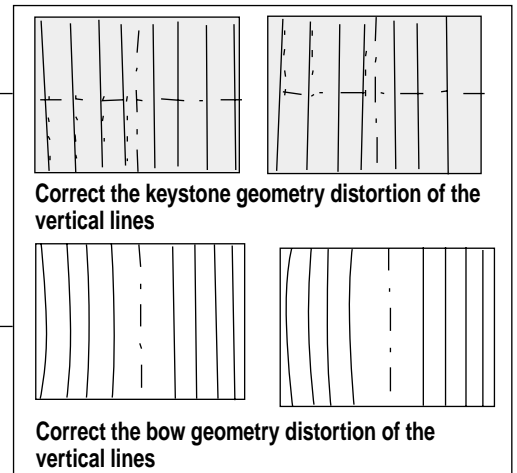
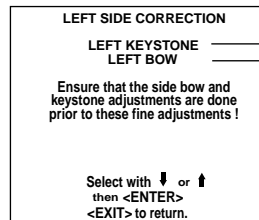

Correct by pushing the control stick to the right

Correct by pushing the control stick to the left

To enter an alignment, push the control stick forward or backward to highlight a function and press ENTER to activate this function.
Press EXIT to return.

Top-Bottom (north-south) Adjustments

Top-Bottom and center adjustments affect only the horizontal lines of the projected image. To start up the Top-Bottom and center corrections, follow the next procedure :

Push the control disc up or down to highlight **TOP-BOTTOM (N/S)** on the geometry menu and then press **ENTER**.

Only the green image is displayed while making top-bottom adjustments. The red and blue images will automatically be corrected in the same manner. Convergence corrections are automatically disabled for the duration of these adjustments.

The following adjustments can be executed

- Horizontal centerline bow
- Horizontal centerline skew
- Top bow
- Top keystone
- Bottom bow
- Bottom keystone

All adjustment are indicated on the screen with the function name, a bar scale and a number between 0 and 100.

Adjust the next alignments until the vertical lines are straight.

To enter an alignment, push the control disc up or down to highlight a function and press **ENTER** to activate this function.

Press **EXIT** to return.

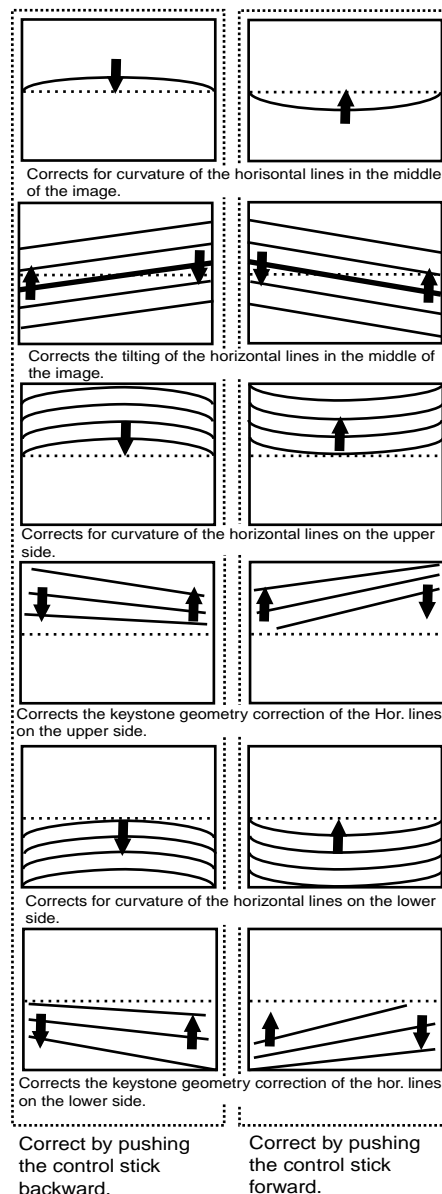
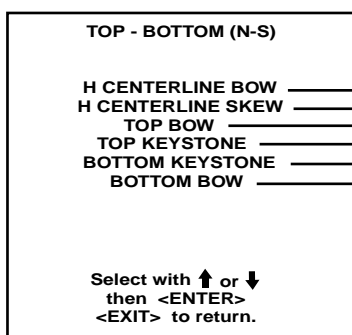
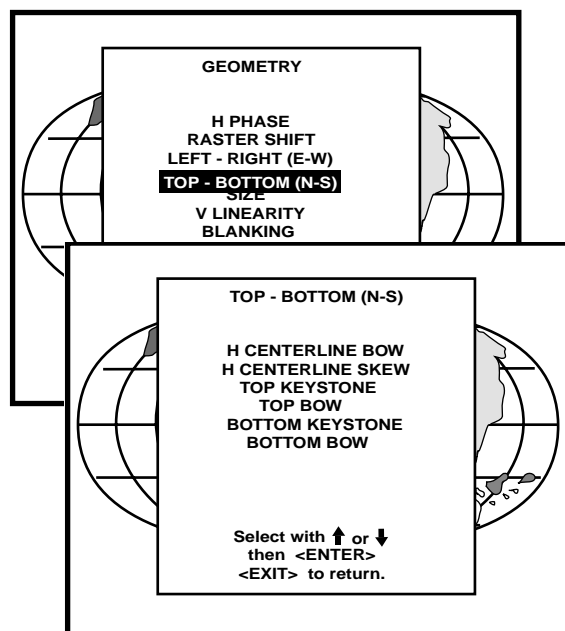

Size Adjustment

Push the control disc up or down to highlight *SIZE* on the Geometry menu and then press **ENTER**.

ENTER will select size adjustment.
EXIT returns to random access adjustment mode menu.
ADJUST returns to operational mode.

Adjust the horizontal size by pushing the control disc to the right or to the left until the exact image width is obtained.
 Adjust the vertical size by pushing the control disc up or down until the exact image height is obtained.

Note :
 - If the internal # pattern was selected, this pattern remains on the screen.
 - If the unlocked pattern was selected, the external source will be displayed.
 A bar scale and a numeric indicator help to gauge the size adjustment.

EXIT will return to Geometry.

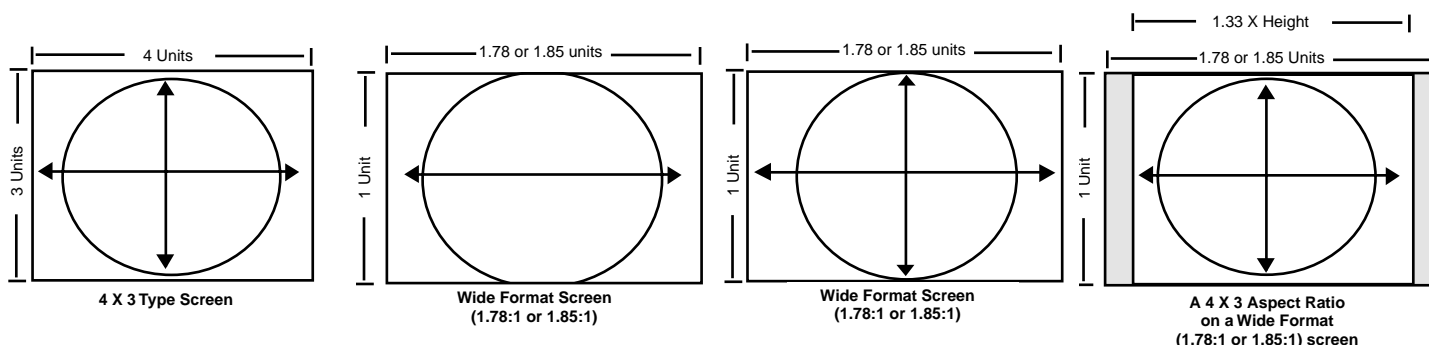
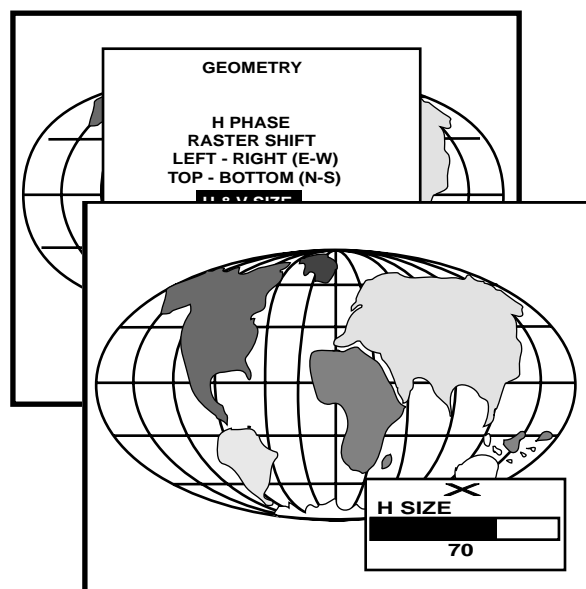

4 X 3 - Use horizontal size to make image fit width of screen, then use vertical size to make image fill height (circle is round). On a wide format (1:78:1 or 1.85) screen, adjust width of image 1.33 X the height of the screen. Adjust the vertical size to fill the height.

WS - Use horizontal size to fill width of screen, then use vertical size to make circle round (use blanking to crop excess image top and bottom.) This is not necessary if you are using a 4 X 3 format screen.

ANA - Use horizontal size to fill width of screen, then use vertical size to fill height of a 16 X 9 screen (circle is nor round). Alternative: Use Anamorphic test pattern on test disc, then adjust sizing to make anamorphic circle round. This is good to use when converging an anamorphic image onto a 4 X 3 screen.

Vertical Linearity Adjustment

The vertical linearity adjustment function corrects for vertical nonlinearities which extend from the center of the image to the top and bottom of the image.

Push the control disc up or down to highlight *V LINEARITY* on the Geometry menu and then press **ENTER**.

ENTER will select vertical linearity adjustment.
EXIT returns to random access adjustment mode menu.
ADJUST returns to operational mode.

Adjust the vertical linearity with the control disc until the distances between the horizontal lines of the set up pattern are equal from top to bottom.

EXIT will return the Geometry menu.

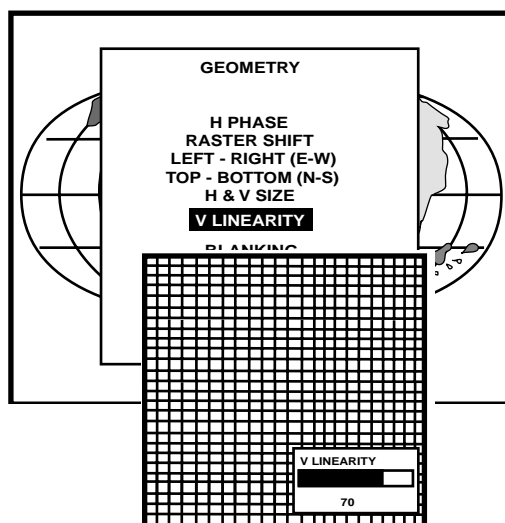
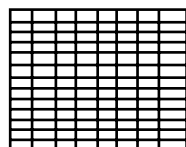

Blanking Adjustments

Blanking adjustments affect only the edges of the projected image and are used to frame the projected image on to the screen and to hide or black out unwanted information (or noise). A 0% on the bar scale indicates no blanking.

To start up the Blanking adjustments, follow the next procedure :

Push the control disc up or down to highlight *BLANKING* on the Geometry menu and the press **ENTER**.

The following blanking corrections are possible :

- Top blanking
- Bottom blanking
- Left blanking
- Right blanking

Therefore :

- If the internal # pattern was selected, this pattern remains on the screen.
- If the genlocked pattern was selected, the external source will be displayed.

Adjust the next blanking alignments until the image is correctly framed or the unwanted information is blanked out.

To enter a blanking alignment, push the control disc up or down to highlight a function and press **ENTER** to activate this function.

Press **EXIT** to return.

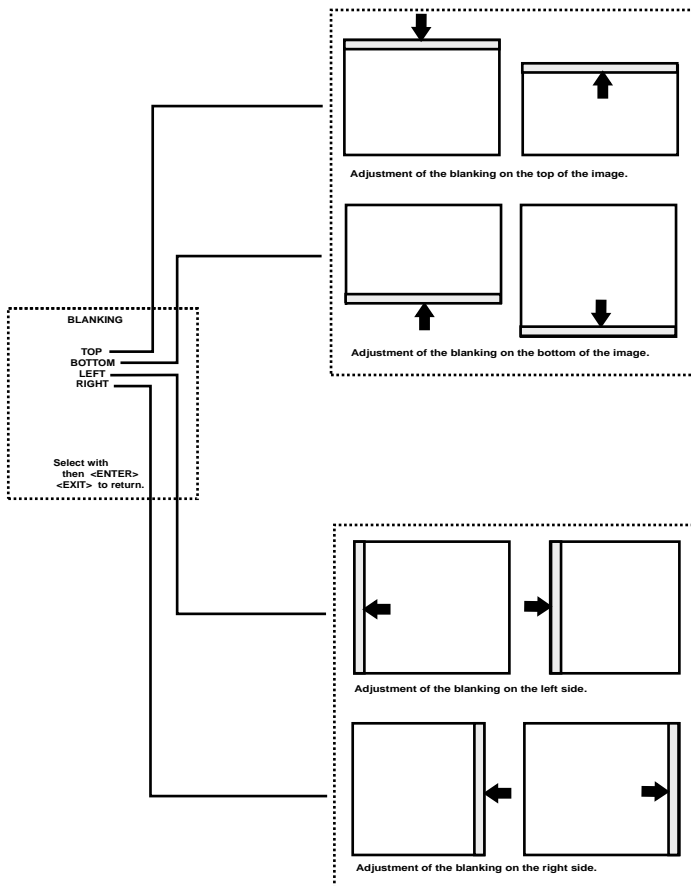
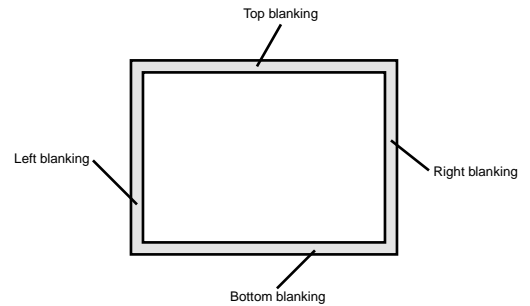
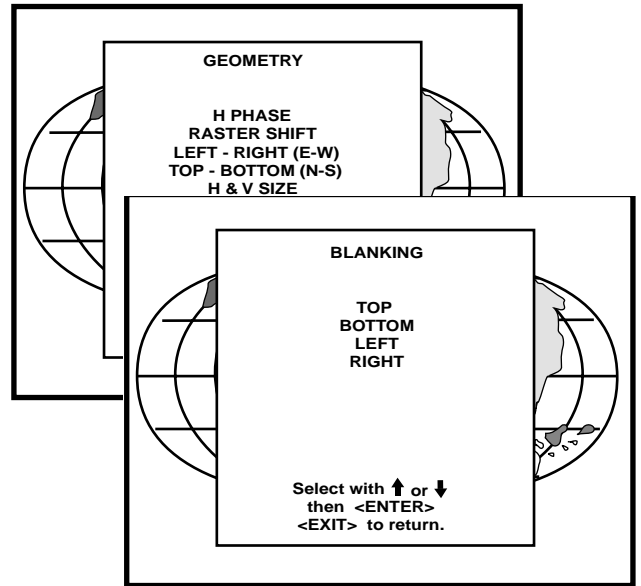

Convergence Adjustment

Convergence adjustments affect both the horizontal and vertical lines of the setup pattern. These adjustments are performed on the red image while superimposed on the green image and then on the blue image while superimposed on the green image. Start with the coarse convergence adjustments and finalize with the fine convergence adjustment.

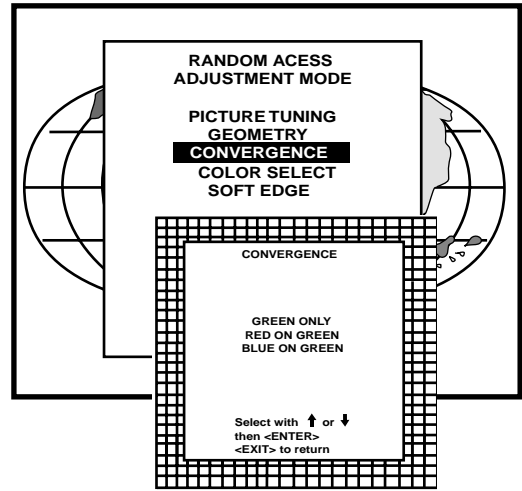

The screen area is divided into 25 areas.

Coarse Convergence Adjustments

Highlight 'Red on Green' under the coarse convergence item and press **ENTER**. The coarse convergence menu will be displayed. The following items are possible:

- * Horizontal sides: adjust the vertical lines, within a certain area, on both sides without influencing the lines on the middle of the image.
 - * Vertical corners: adjust the horizontal lines in the four corners, within a certain area, without influencing the middle of the image.
- Repeat for 'blue on green'

25	23	9	15	17
24	22	8	14	16
5	4	1	2	3
20	18	6	10	12
21	19	7	11	13

Horizontal sides

Highlight "Horizontal lines" and press ENTER to start the adjustment. To make a coarse adjustment of the red or blue vertical lines in ZONE 3 and 5 simultaneously.



Hint

* Look to the outside edges of the image and adjust until the red or the blue vertical lines are on the green lines or as close as possible to the green lines.

* During these adjustments, the horizontal convergence adjustments in ZONES 2, 3, 4, and 5 will be set to midposition (barscale 50)

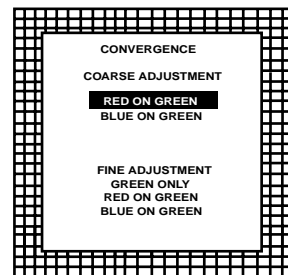
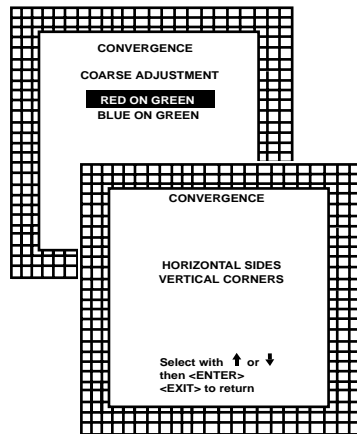

Vertical corners

Highlight 'Vertical corners' and press **ENTER** to start the adjustment.

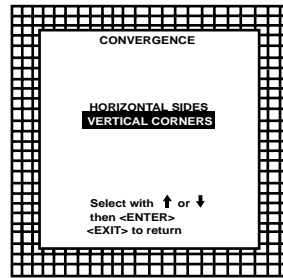
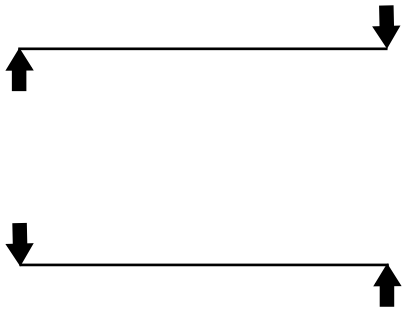

To make a coarse adjustment of the red or blue horizontal lines in zone 10, 14, 18 and 22 simultaneously.

Hint:

- Adjust until the red or the blue horizontal lines are on the green lines or as close as possible to the green lines.
- During these adjustments, the horizontal convergence adjustments in zones 10 to 25 will be set to midposition (barscale 50)

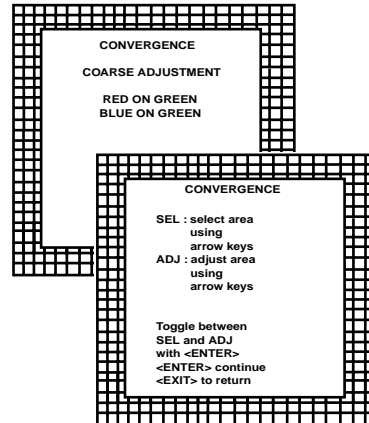

Fine Convergence Adjustments

Use these controls after coarse convergence adjustment to optimize the convergence of the red and blue image on the green image.

Use the control disk to make horizontal or vertical convergence adjustments in the selected zone and then press **ENTER** to move the box to another zone or **EXIT** to return to convergence menu.

ENTER toggles arrow keys between zone selection and zone adjustment.

EXIT returns to convergence menu.

Note: The green convergence adjustments can be added as an option. When these are available, always start with 'green only'. This option will also be indicated on the convergence menu.

Highlight first 'Green only' when available with the control disk and press **ENTER** to display the convergence adjustment menu. Continue with red on green and blue on green.

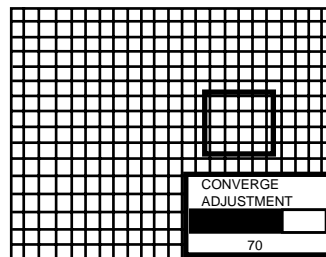

Starting up the Service mode.

Use the control stick to highlight 'Service' and then press **ENTER**.

Some items in the Service mode are password protected (when the password function is active). Enter your password to continue. All other password protected items are now also available if you stay in the adjustment mode.

ENTER continues to the Service Mode main menu.
EXIT returns to the Operational mode.

The service items are combined in two service menus. To switch from the first to the second menu or vice versa, push the control stick forward or backward to select 'more...'

Overview flowchart 'Service' mode.

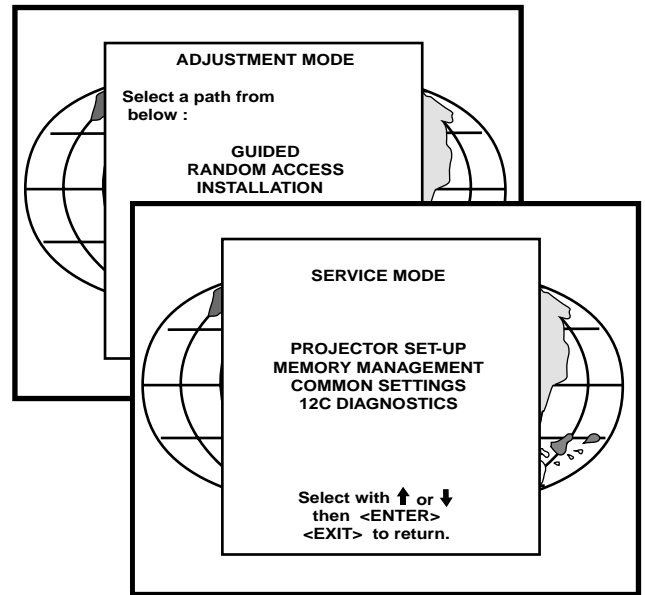

Overview flowchart 'Service' mode

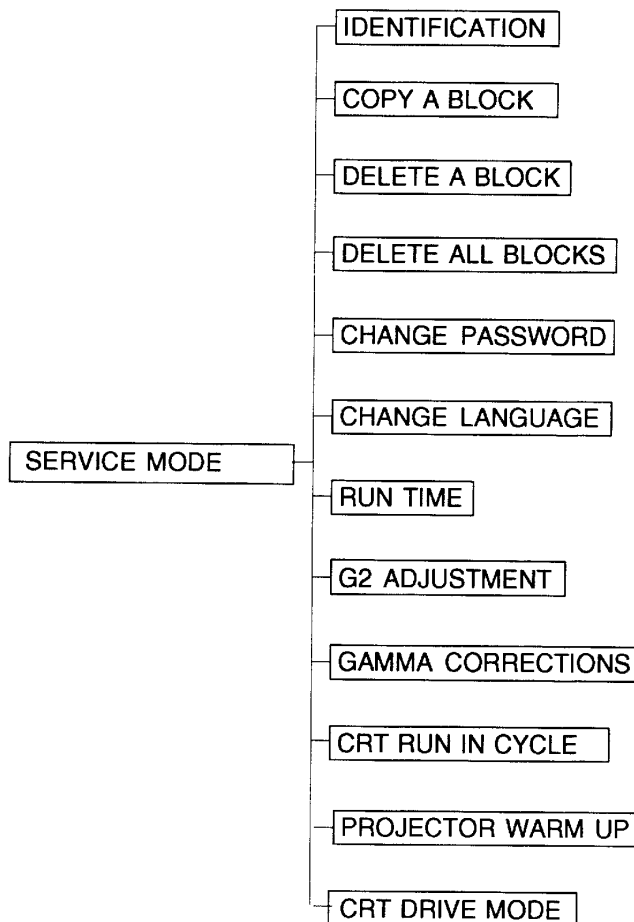

Identification

Highlight 'Identification' with the control disc and press **ENTER**.

**ENTER will start the selected item.
EXIT returns to the Service mode menu.**

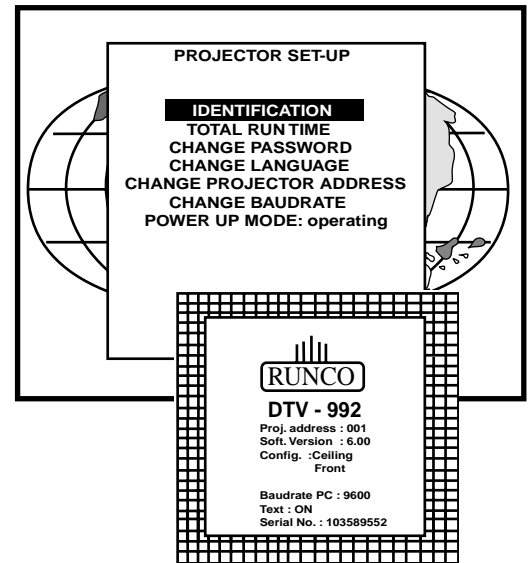

The 'Identification' screen gives information concerning :

- Projector address. To change the address of your projector, contact a qualified service technician.
- Software version.
- Configuration.
 - Possible installations :
 - * Front-ceiling
 - * Front-table
 - * Rear-ceiling
 - * Rear-table
- Baud rate PC : transfer speed for communication with an IBM PC (or compatible) or MAC. The baud rate of the projector must be the same as the baud rate of the connected computer. When there is a difference, contact a qualified service technician to make the appropriate changes.
- Text ON/OFF
 - Indicates in operational mode if the bar scale and number indicator will be displayed and if warnings and failures will be displayed.
 - ON : displayed
 - OFF : not displayed

The status can be changed by pressing the 'TEXT' key once on the RCU.
- Serial no. : indicates the fabrication number of the projector. This number can be useful when calling for technical assistance.

Copy a block

The copy a block function copies the settings of a selected block into the active block.
Highlight *copy a block* with the control disc and press **ENTER**.

**ENTER will select the highlighted item.
EXIT returns to the Path Selection main menu.
ADJUST returns to the Operational mode.**

To copy the settings of a closed block to the block you are working on (active block), use the control disc to select a block.
All existing settings will be overwritten with the new settings.

Press **ENTER** to copy the selected block. A confirmation screen will be displayed.

If you are certain you wish to copy the contents of the selected block into the active block, press **ENTER**.

**ENTER displays a confirmation screen.
EXIT returns to the Service Mode main menu.**

EXIT cancels the copy procedure and returns without copying the block.

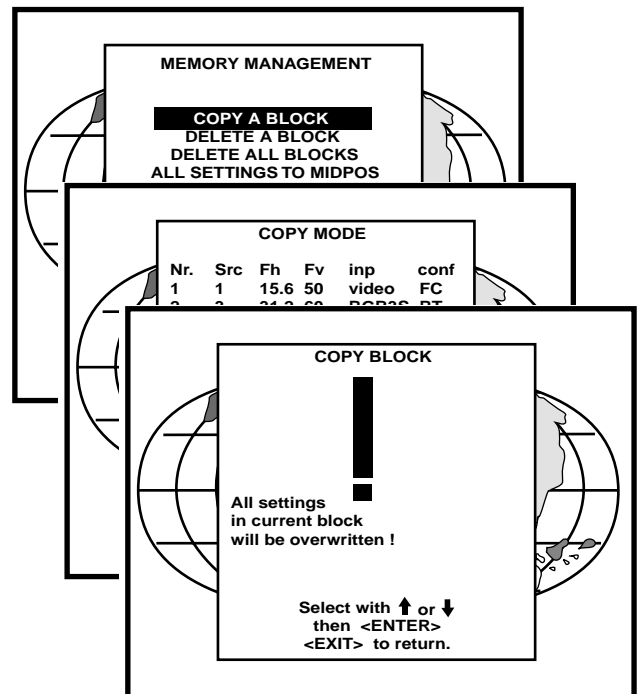

Deletion of blocks

This item is password protected.
 The delete function is used to clear all data (settings) from an adjustment block.

A delete can be given :

- block by block
- or
- for all blocks.

Deleting block by block

The 'delete a block' function deletes the settings of a selected block.

ENTER will select the pointed item.
EXIT returns to the Path Selection main menu.
ADJUST returns to the Operational mode.

Highlight 'Delete a block' with the control disc and press **ENTER**.

Push the control disc up or down to select the desired adjustment block.

ENTER displays the confirmation menu.
EXIT returns to the Service Mode main menu.

Press **ENTER** to delete the selected adjustment block. A confirmation menu will be displayed.

ENTER will delete the selected block.

EXIT cancels the deletion procedure and returns to the Service mode main menu.

ENTER gives a confirmation message before deleting.
EXIT returns to the Path Selection main menu.

Deletion of all blocks

Highlight 'delete all blocks' with the control disc and press **ENTER**.

If you are certain you wish to delete all blocks, press **ENTER** to confirm, otherwise press **EXIT** to return.

Once **ENTER** is pressed, all block headers and adjustment settings are permanently removed and cannot be restored.

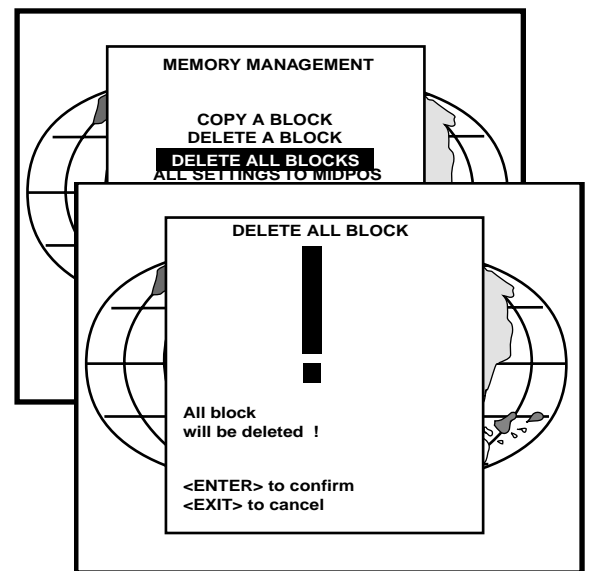
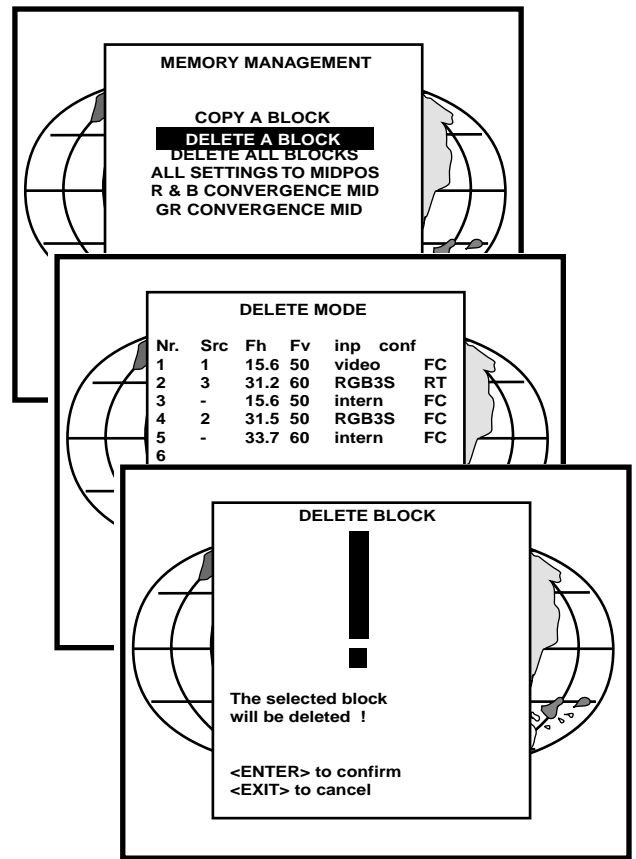

Change password

This item is password protected.
Highlight 'Change Password' with the control disc and press **ENTER**.

ENTER gives a confirmation message before deleting.
EXIT returns to the Path Selection main menu.

The current password is displayed. The new password must consist of 4 digits between 0 and 9. Push the control disc to the left or to the right to select the digits to be changed. Use the numeric keys to enter the new digits.

Press **ENTER** to save the new password. Before saving the new password, a confirmation screen will be displayed.

Press **EXIT** to return to the Projector Set-up menu without saving the new password.

When the displayed password is correct, press **ENTER** to save.

If not correct, press **EXIT** to cancel the saving.

ENTER saves the entered password.
EXIT returns without saving.

Change Language

The 'Change Language' function offers the possibility to change the language of the screen menus to :

- English
- Spanish
- French
- German

Highlight 'Change Language' with the control disc and press

ENTER saves the entered password.
EXIT returns without saving.

ENTER.

Push the control disc up or down to select the desired language and press **ENTER** to change the language.

Total Run Time

Highlight 'Total Run Time' with the control disc and press **ENTER** to display the amount of time the projector has played since its first start up at the factory.

ENTER gives the selected item.
EXIT returns to Service mode menu.
ADJUST returns to the Operational mode.

Note : all projectors leave the factory after a burn-in period of approximately 100 hours.

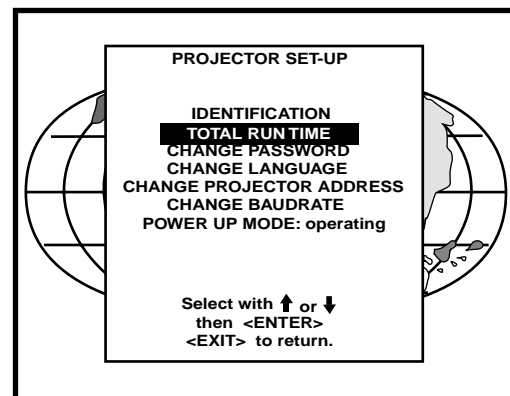
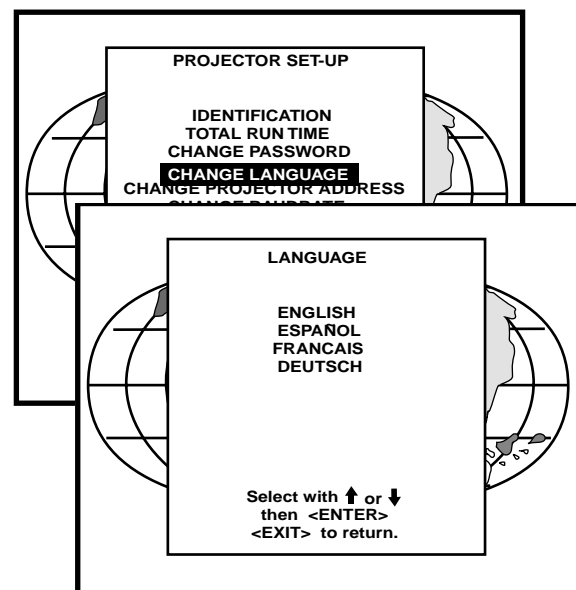
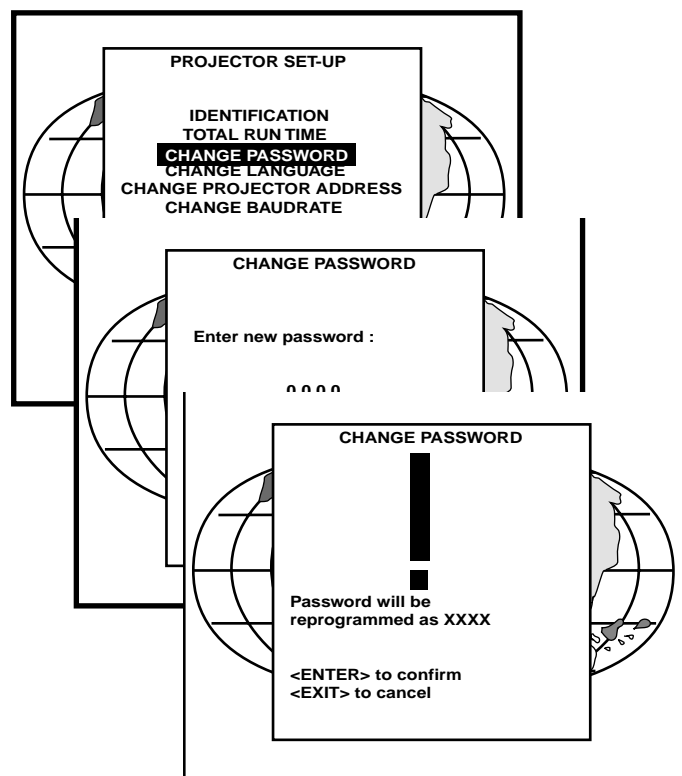

All settings to midposition

Item is password protected.
 Highlight 'All settings to midposition' with the control disc and press **ENTER** to set all settings to their midposition. A confirmation menu will be displayed first.

**ENTER displays a Confirmation screen.
 EXIT returns to the Service menu.**

ENTER will set all settings to their midposition. **EXIT** cancel the operation to set all settings to their midposition.

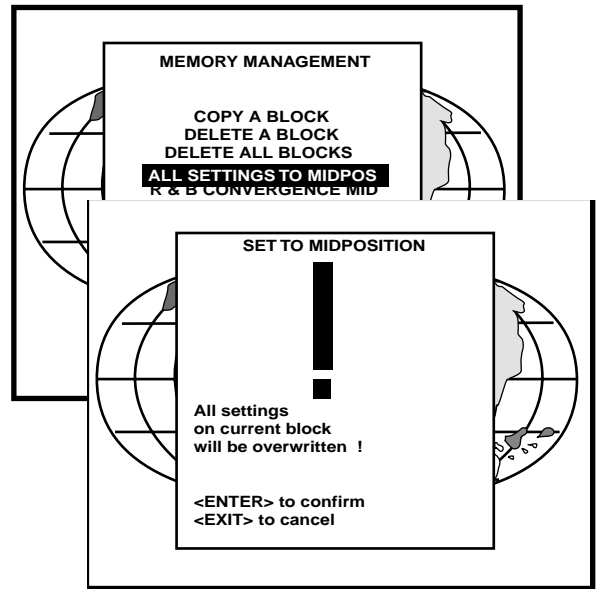

Undo all settings to midpos

When "all settings to midpos" is selected, all settings are set to their midposition. To cancel this action, select 'Undo all settings to midpos' by pushing the control disc up or down and press **ENTER**. 'Undo all settings to Midposition' is displayed in the Memory management menu instead of 'All settings to midposition' when this latter is pressed.

An undo is possible as long as the projector is playing on the same source (= same adjustment block) even when some adjustments as geometry or convergence are already readjusted. When undo is pressed all settings are reset to the previous settings.

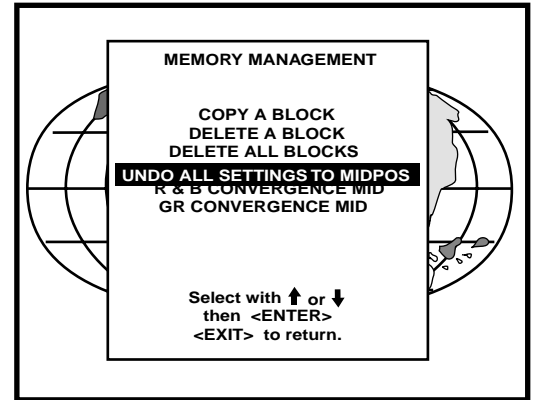

R & B convergence mid

Item is password protected.
 Highlight 'R & B convergence mid' with the control disc and press **ENTER** to set all convergence settings to their midposition. A confirmation screen will be displayed first.

ENTER sets the convergence settings to their midposition. **EXIT** cancels the procedure to set the convergence settings to their midposition.

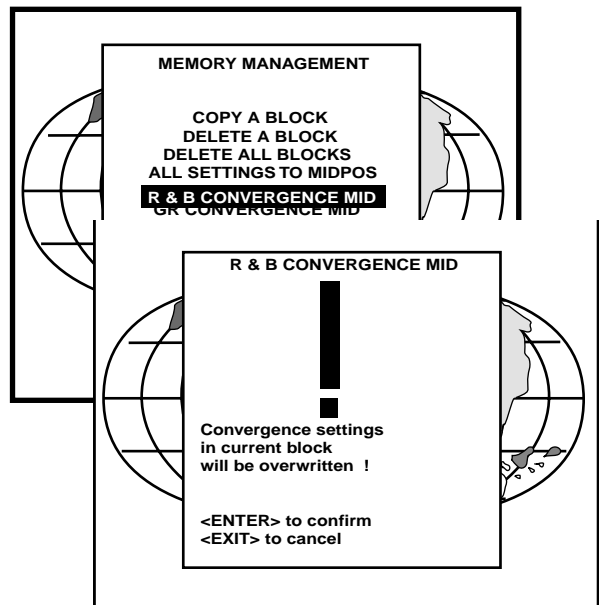

Undo R & B convergence mid

When "R & B convergence mid" is selected, all convergence settings are set to their midposition. To cancel this action, select 'Undo R & B convergence mid' by pushing the control disc up or down and press **ENTER**. 'Undo R & B convergence mid' is displayed in the Memory management menu instead of 'R & B convergence mid' when this latter is pressed.

An undo is possible as long as the projector is playing on the same source (= same adjustment block) even when some adjustments are already readjusted. When undo is pressed all settings are reset to the previous settings.

Dynamic Astigmatism (spot shape adjustment)

The spot shape adjustments correct the spot shape in 8 different areas on the screen and that for the three colors separately. The spot shape is adjusted according to the axial axes and the diagonal axes when using the arrow keys on the RCU.

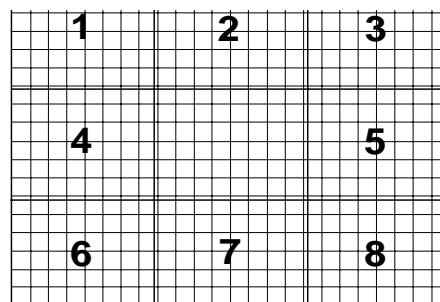

These adjustments have to be done on a dot pattern (e.g. the internally generated pattern) with standard line frequency (15 kHz). The adjustment values are stored in the EEPROM and remain the same for all frequencies.

Follow the next procedure:

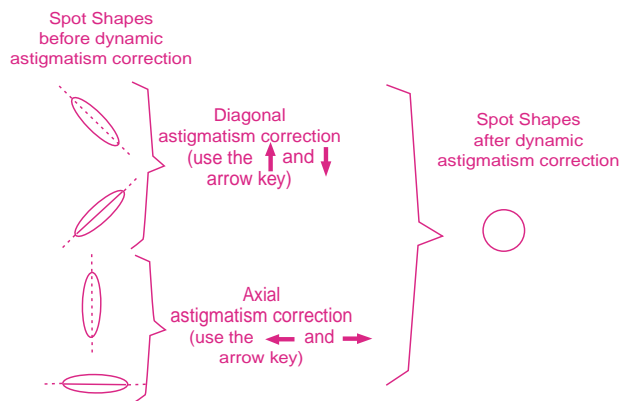

Highlight 'Dyn. Astigmatism' by pushing the joy stick forward or backward and press **ENTER** to select.

EXIT returns to the path selection main menu.

Select the source type, selected source or genlock pattern, by highlighting the color for which the spot shape has to be corrected and press **ENTER**.
e.g. when selecting RED under 'on genlocked pattern', the projector switches to a genlocked pattern.

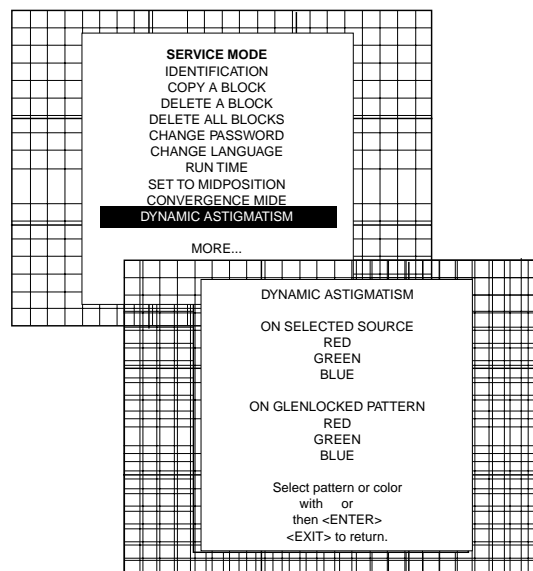

Press **ENTER** to continue adjustment. Increase the contrast level using the Contrast Control to near maximum. Using that "+" Sharpness Key, defocus the image until the dots are large and easily visible. Press **ENTER** to continue to SEL.

SEL : select the adjustment area on the screen where the spot shape has to be corrected.
Use the arrow keys to select one of the 8 areas. Press **ENTER** to continue to ADJ.

ADJ : adjust the spot shape in the axial or diagonal direction when using the arrow keys for the selected area. Adjust until the spot shape is circular.

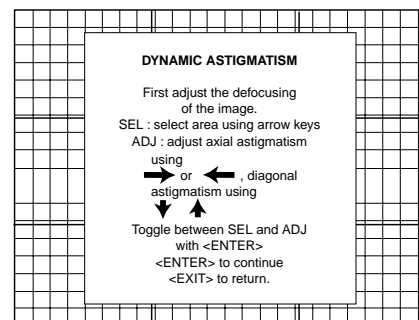

G2 Adjustment

Item is password protected.
 Highlight 'G2 adjust' with the control disc and press **ENTER** to continue.
 A safety notice will be displayed on the screen as it is necessary to open the top cover to adjust the G2.

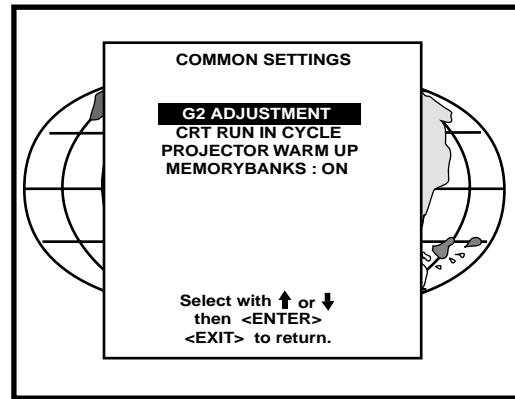

ENTER selects the G2 adjustment.
EXIT returns to the Common settings menu.
ADJUST returns to the Operational mode.

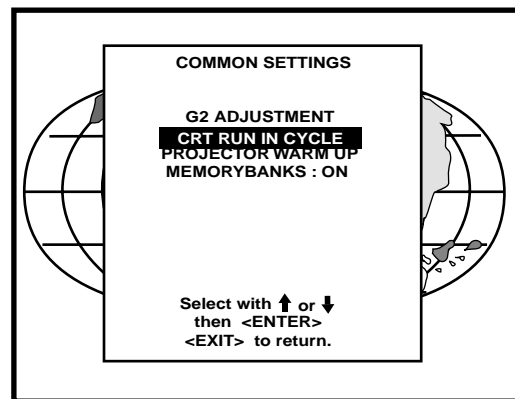

'G2 adjustment should be performed by RUNCO personnel, or RUNCO authorized dealers'.
 If you are qualified, press **ENTER** to continue. If not qualified, press **EXIT** to return to the Common settings menu. Further description of the G2 adjustment is given in the Installation manual.

CRT run in cycle

The CRT run in cycle option can only be activated when memory blocks on an internal # pattern are available. When one or more such blocks are available, a flashing white image (5 sec on, 5 sec off) is generated and that for 5 minutes on the first internal block. In the next 5 minutes, a second internal block will be used to generate the flashing white image. The image will also be shifted in a vertical way to prevent a CRT burn in. To quit the CRT run in cycle option, press **EXIT**.

Highlight 'CRT run in cycle' with the control disc and press **ENTER** to start.
ENTER selects the CRT run in cycle option.
EXIT returns to the Path Selection main menu.

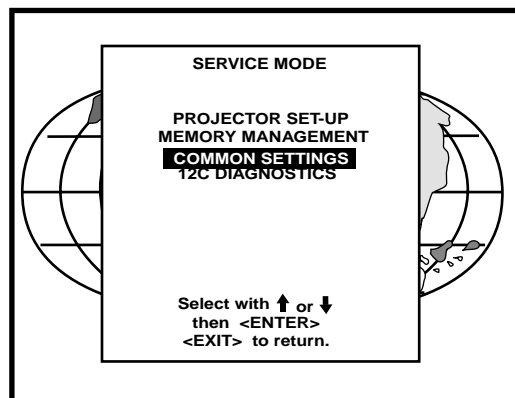

Projector warm up

Highlight 'Projector warm up' by pushing the control disc up or down and press **ENTER** to select the projector warm up menu.

The ON/OFF option can be toggled with the **ENTER** key.

When in the ON position (and the CRT run in cycle is OFF), the projector can start up with a warm up period of 20 minutes. During the start up a warm up menu will be displayed. This menu offers the possibility to skip the warm up period anyway by pressing the **EXIT** key and offers the possibility to adjust the horizontal and vertical amplitude of the white image with the control disc. During this warm up period, a full white image is shifted on the CRT faceplate to avoid a burn in.

Every 30 seconds a text box will be displayed on another place on the screen with the remaining time to go.

When **EXIT** is pressed during this warm up period, the warm up menu will be redisplayed with the remaining time indication. Press another time **EXIT** to interrupt the warm up cycle.

When the warm up option is OFF, when switching on the projector, it starts immediately with the projection of the selected source.

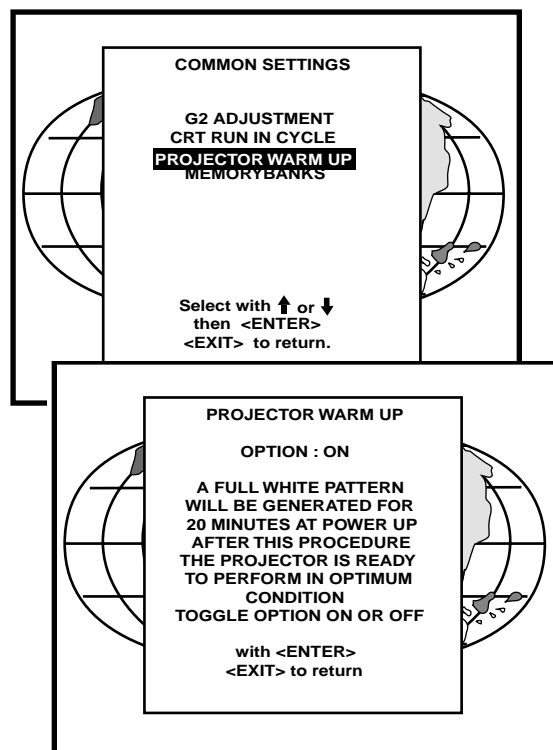

CRT Drive Mode

The projector CRT's can be driven with the normal current (normal mode), a lower current (economic mode) or with a higher current (boost mode).

To change the drive mode, highlight 'CRT drive mode' by pushing the control stick forward or backward and press ENTER to display the CRT drive mode menu.

To change the boost mode, push the control stick forward or backward to select a display mode and press ENTER to select.

The following modes are available:

- normal
- economic : lower drive current to the CRT's, the lifetime of the CRT's will enlarge but the light output will reduce.
- temporary boost: higher drive current to the CRT's, the lifetime of the CRT's will shorten but the light output will be higher. This situation is temporary, when restarting the projector, the drive mode is automatically set to normal.
- permanent boost: higher drive current to the CRT's, the lifetime of the CRT's will shorten but the light output will be higher. This setting will be saved in the EEPROM. When restarting the projector, it will start up in boost mode.

A warning, permanent BOOST mode in use, will be displayed to inform the user.

When text is on, this warning will be repeated every time a new source is selected.

<p>SOURCE 01 Fh= 15.6 kHz Fv= 050 Hz</p>	<p>When selecting a new source, information about this source will be displayed on the screen. Source number, horizontal and vertical frequencies of the displayed source.</p>	<p>WARNING: source not available</p>	<p>The input is a valid input but the source is not connected to the input terminals or the input source is switched off.</p>
<p>SOURCE 01 Fh= 15.6 kHz Fv= 050 Hz</p>	<p>Announcement of the selected source.</p>	<p>WARNING: invalid key entry</p>	<p>When a wrong key is pressed on the RCU.</p>
<p>enter password xxxx</p>	<p>Message to enter your password. Password contains 4 digits.</p>	<p>WARNING: invalid code entry</p>	<p>Message when the entered pass word is wrong.</p>
<p>text on</p>	<p>These messages will be displayed on the screen when pushing the <TEXT> key. Text ON : the <i>'bar scale indication'</i> will be enabled during the change of an analog control in the <i>'operational mode'</i>+ all warnings and failures will be displayed.</p>	<p>WARNING: end of adjust range</p>	<p>End of adjustment range.</p>
<p>text off</p>	<p>Text OFF : the <i>'barnacle indication'</i> will be disabled during the change of an analog control in the <i>'operational mode'</i>s all warnings and failures will not be displayed.</p>	<p>WARNING: input no longer available</p>	<p>Message will be displayed when the input source is no longer available. The following message then appears: <i>'check input signal or select new source'</i>.</p>
<p>PROJECTOR ADDRESS: 003</p>	<p>Indication of the projector ad dress when activating the <i>'AD DRESS'</i> button on the RCU with a pencil or other small object.</p>	<p>check input signal or select new source</p>	<p>This message will be displayed after the message <i>'input no longer available'</i>. It asks to check the connections between the source and the projector or to check if the source is switched on.</p>

WARNING: invalid frequency input	The entered frequency or applied frequency of the source is out of the projector's range.	FAILURE RWI communication error	Hardware failure. Call a qualified service technician.
WARNING: default settings loaded in the E2PROM	Adjustment settings are lost. Re load using Projector Control Software via PC or MAC (if this option is available), or readjust image.	FAILURE EYE-Q communication error	Communication error between EYE-Q and the projector. Call a qualified service technician.
table is deleted	Message to inform that selected table is deleted. This message will be followed by <i>confirm message?</i> on which the user has to answer.	WAIT starting up EYE-Q	Message during the start up of the EYE-Q. Message will disappear when the EYE-Q is ready to accept commands.
FAILURE invalid RWI soft version	Wrong software version in your projector. Call for technical support.		
FAILURE 1²C error addr. : 7FH3	Hardware failure. Call a qualified service technician for repair.		
FAILURE short circuit on 1²C bus	Hardware failure. Call a qualified service technician for repair.		

SPECIFICATIONS

DTV-992		DTV-992 ULTRA	
Scan Rate:	15—75 KHz (horizontal) 37—200 Hz (vertical)	Scan Rate:	15—110 KHz (horizontal) 37—200 Hz (vertical)
Bandwidth:	75 mHz	Bandwidth:	120 mHz
CRTs:	8 High performance with Electromagnetic focus	CRTs:	8 High performance with Electromagnetic focus
Lenses:	Fully color corrected and filtered HD-8 lenses	Lenses:	Fully color corrected and filtered HD-8 lenses
Optical Resolution:	10 line pairs/mm	Optical Resolution:	10 line pairs/mm
Inputs:	Component/RGB	Inputs:	Component/RGB
Color Balance:	3200K, 5400K, 6500K, 9300K, Custom	Color Balance:	3200K, 5400K, 6500K, 9300K, Custom
Convergence Memories:	32	Convergence Memories:	32
Light Output:	1250 lumens/230 ANSI	Light Output:	1250 lumens/230 ANSI
Picture Size:	5—20 ft. wide	Picture Size:	5—20 ft. wide
Throw Distance:	1.33 x width (widescreens) 1.40 x width (4:3 screens)	Throw Distance:	1.33 x width (widescreens) 1.40 x width (4:3 screens)
Video Standards:	NTSC, PAL, SECAM, NTSC 4.43	Video Standards:	NTSC, PAL, SECAM, NTSC 4.43
Configurations:	Front or Rear, Floor or Ceiling	Configurations:	Front or Rear, Floor or Ceiling
Contrast Ratio:	100:1	Contrast Ratio:	100:1
Convergence:	Dynamic geometry, 25 point zone	Convergence:	Dynamic geometry, 25 point zone
Power input:	115 VAC, 50/60 Hz	Power input:	115 VAC, 50/60 Hz
Power Consumption:	500 W	Power Consumption:	500 W
Environment:	32—104° F (0—40°C)	Environment:	32—104° F (0—40°C)
Humidity:	0—90%, non-condensing	Humidity:	0—90%, non-condensing
Storage:	10—122° F (-12—50°C)	Storage:	10—122° F (-12—50°C)
Cabinet Dimensions:	Width: 23.25 in./590.55 mm Depth: 43 in./1092.20 mm Height: 14.25 in./361.95 mm	Cabinet Dimensions:	Width: 23.25 in./590.55 mm Depth: 43 in./1092.20 mm Height: 14.25 in./361.95 mm
Weight:	156 lbs. (70.76 kg)	Weight:	156 lbs. (70.76 kg)
Safety Regulations:	Complies with: UL, FCC Class B, CE, C-Tick	Safety Regulations:	Complies with: UL, FCC Class B, CE, C-Tick

RS 232 Control

By far, the most accurate way to control or integrate the DTV-992 / 992 ULTRA into a home theater system is by RS 232 control. In this section, you will find hardware configuration and how to format the control data, command strings and examples.

Hardware Configuration

RS232 Connector 9PIN D-SUB PC-AT TYPE. Projector has female type.

To establish communications with the projector, the following conditions must be made:

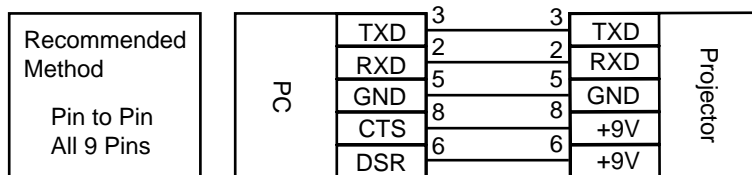

PIN OUTS FOR 9 PIN

1:	CD	Carrier Detect
2:	RXD	Receive Data
3:	TXD	Transmit Data
4:	DTR	Data Term Ready
5:	GND	Signal Ground
6:	DSR	Data Set Ready
7:	RTS	Request To Send
8:	CTS	Clear To Send
9:		Ring Indicator

NOTE: All wires are straight through. DO NOT cross PINS 2 to 3 as in a null modem configuration.

Alternatively, the connections can be made as follows (absolute minimum of wires):

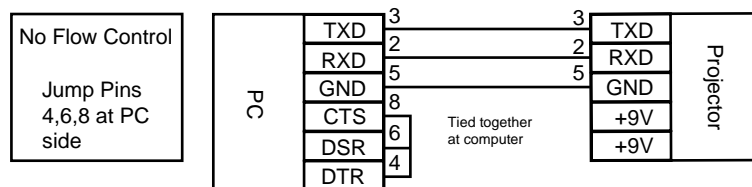

The Protocol Necessary For Communications:

8 Data Bits, No Parity, 1 Stop Bit

Baud Rate is selectable between 8 rates at the projector up to 9600 Baud (9600 is default).

NOTE: Some automation systems may only use/require pins 3, 2, 5 be connected.

How to format the control data

Every command sent to the projector is a group of 9 bytes that is called a record. Even a simple ON command is sent as a record. Below is an explanation of the syntax of a record. It is not necessary to memorize the syntax since the next section contains a chart of strings that work with any DTV-992 / 992 ULTRA and can be entered directly into most automation systems to control all the functions of the projector.

Sending a RECORD (single instruction)

A RECORD consists of 9 bytes of information in the following order:

STX, OFFS, ADR, CMD, DAT1, DAT2, DAT3, DAT4, CHKS

Where:

STX	- 02H	Make projector(s) listen for its (their) unique address.
OFFS	- (1-255)	Offset you choose so that none of the data or CMDs - 02H (STX). Normally set the offset to 0.
ADRe	- (1-255)	Number corresponding to projector's unique address (see dip switch setting). If you are unsure of your projector's address, set this to 0. It will talk to your projector regardless of its address.
CMDe	- (1-255)	The command to be sent to the projector (see list of commands). See command list for all possible functions.
DAT1e	- (1-255)	Additional data to be sent (set to 0 if not used)
DAT2e	- (1-255)	Additional data to be sent (set to 0 if not used)
DAT3e	- (1-255)	Additional data to be sent (set to 0 if not used)
DAT4e	- (1-255)	Additional data to be sent (set to 0 if not used)
CHKSe	- (ADR + CMD + DAT1 + DAT2 + DAT3 + DAT4) mod 256 - add everything and keep only 2 right most digits	

Note: Bytes from **ADR** to **CHKS** are shown in bold with the suffix 'e' to indicate the offset is added before sending the byte.

Example string to send to the projector with address 3 to turn it on/off

In decimal values

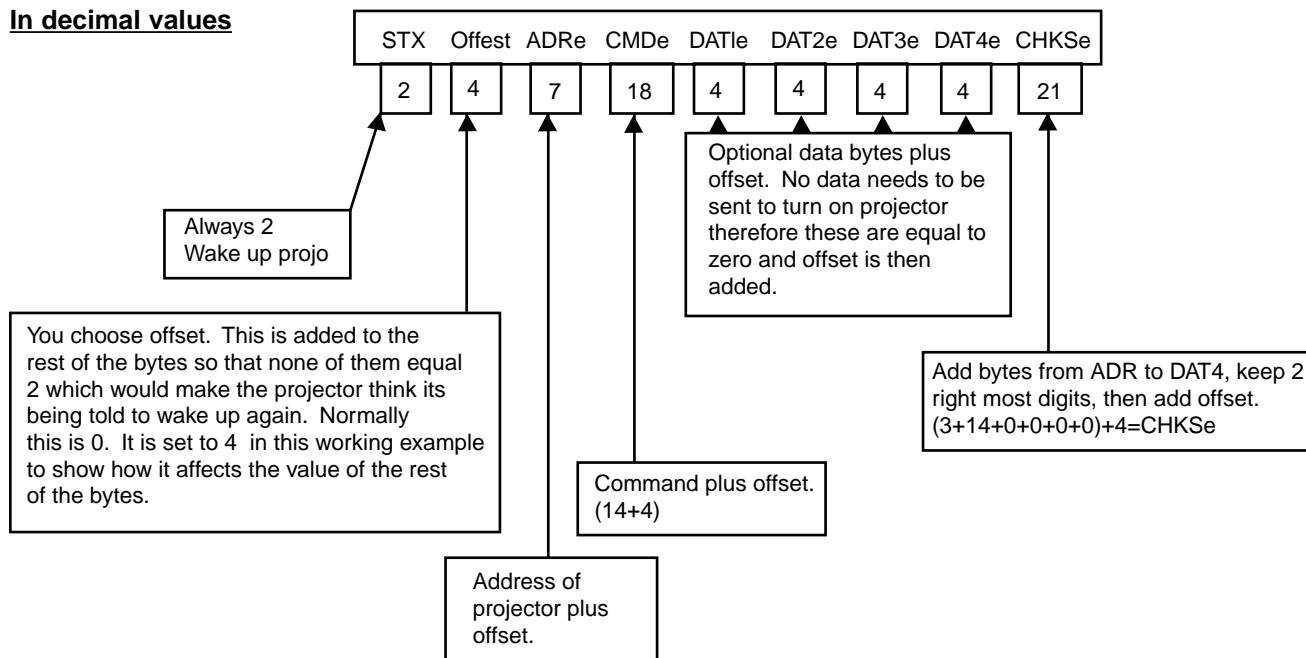

COMMAND CODE LIST

Transmitting the following codes is the same as using the keys of the IR remote.

ENTER	07h	(7)	Enter button	CUR_UP	21h	(33)	Cursor up
EXIT	08h	(8)	Exit button	CUR_DN	22h	(34)	Cursor down
ADJUST	09h	(9)	Adjust button	CUR_RI	23h	(35)	Cursor right
TEXT	0Dh	(13)	Menus On/Off	CUR_LE	24h	(36)	Cursor left
* STDBY	0Eh	(14)	Power On/Off	CON_UP	28h	(37)	Contrast +
NUM_0	10h	(16)	} Numeric Keypad	CON_DN	29h	(38)	Contrast -
NUM_1	11h	(17)		BRI_UP	2Ah	(42)	Brightness +
NUM_2	12h	(18)		BRI_DN	2Bh	(43)	Brightness -
NUM_3	13h	(19)		SAT_UP	2Ch	(44)	Color +
NUM_4	14h	(20)		SAT_DN	2Dh	(45)	Color -
NUM_5	15h	(21)		HUE_UP	2Eh	(46)	Tint +
NUM_6	16h	(22)		HUE_DN	2Fh	(47)	Tint -
NUM_7	17h	(23)		SHA_UP	36h	(54)	Sharpness +
NUM_8	18h	(24)		SHA_DN	37h	(55)	Sharpness -
NUM_9	19h	(25)					

* The STDBY is a toggle for power ON/Off. If discreet Power On of Power Off commands are necessary please see the chart of example strings.

* Decimal Value in ().

COMMAND	BYTE 1	BYTE 2	BYTE 3	BYTE 4	BYTE 5	BYTE 6	BYTE 7	BYTE 8	BYTE 9
POWER ON/OFF	\$02	\$00	\$00	\$0E	\$00	\$00	\$00	\$00	\$0E
POWER ON	\$02	\$00	\$00	\$51	\$0A	\$00	\$00	\$01	\$5C
POWER OFF	\$02	\$00	\$00	\$51	\$0A	\$00	\$00	\$00	\$5B
ENTER	\$02	\$00	\$00	\$07	\$00	\$00	\$00	\$00	\$07
EXIT	\$02	\$00	\$00	\$08	\$00	\$00	\$00	\$00	\$08
ADJUST	\$02	\$00	\$00	\$09	\$00	\$00	\$00	\$00	\$09
TEXT ON/OFF	\$02	\$00	\$00	\$0D	\$00	\$00	\$00	\$00	\$0D
CURSOR UP	\$02	\$00	\$00	\$21	\$00	\$00	\$00	\$00	\$21
CURSOR DOWN	\$02	\$00	\$00	\$22	\$00	\$00	\$00	\$00	\$22
CURSOR LEFT	\$02	\$00	\$00	\$24	\$00	\$00	\$00	\$00	\$24
CURSOR RIGHT	\$02	\$00	\$00	\$23	\$00	\$00	\$00	\$00	\$23
BUTTON 0	\$02	\$00	\$00	\$10	\$00	\$00	\$00	\$00	\$10
BUTTON 1	\$02	\$00	\$00	\$11	\$00	\$00	\$00	\$00	\$11
BUTTON 2	\$02	\$00	\$00	\$12	\$00	\$00	\$00	\$00	\$12
BUTTON 3	\$02	\$00	\$00	\$13	\$00	\$00	\$00	\$00	\$13
BUTTON 4	\$02	\$00	\$00	\$14	\$00	\$00	\$00	\$00	\$14
BUTTON 5	\$02	\$00	\$00	\$15	\$00	\$00	\$00	\$00	\$15
BUTTON 6	\$02	\$00	\$00	\$16	\$00	\$00	\$00	\$00	\$16
BUTTON 7	\$02	\$00	\$00	\$17	\$00	\$00	\$00	\$00	\$17
BUTTON 8	\$02	\$00	\$00	\$18	\$00	\$00	\$00	\$00	\$18
BUTTON 9	\$02	\$00	\$00	\$19	\$00	\$00	\$00	\$00	\$19
CONTRAST +	\$02	\$00	\$00	\$28	\$00	\$00	\$00	\$00	\$28
CONTRAST -	\$02	\$00	\$00	\$29	\$00	\$00	\$00	\$00	\$29
BRIGHTNESS +	\$02	\$00	\$00	\$2A	\$00	\$00	\$00	\$00	\$2A
BRIGHTNESS -	\$02	\$00	\$00	\$2B	\$00	\$00	\$00	\$00	\$2B
COLOR +	\$02	\$00	\$00	\$2C	\$00	\$00	\$00	\$00	\$2C
COLOR -	\$02	\$00	\$00	\$2D	\$00	\$00	\$00	\$00	\$2D
TINT +	\$02	\$00	\$00	\$2E	\$00	\$00	\$00	\$00	\$2E
TINT -	\$02	\$00	\$00	\$2F	\$00	\$00	\$00	\$00	\$2F
SHARPNESS +	\$02	\$00	\$00	\$36	\$00	\$00	\$00	\$00	\$36
SHARPNESS -	\$02	\$00	\$00	\$37	\$00	\$00	\$00	\$00	\$37

The \$ sign indicates a hex value and may not be required by your automation system. Remember that each command requires 9 bytes be sent to the projector. For example, to send a power on command from a Phast Landmark Control system, enter the following string precisely as printed:

\$02,\$00,\$00,\$51,\$0A,\$00,\$00,\$00,\$01,\$5C

Use no spaces between the commas.



EYE-Q™ Autoconvergence

OVERVIEW

The EYE-Q™ auto-convergence system allows for faster and more accurate convergence when used by the installer upon initial installation. The EYE-Q™ system also allows the end-user to perform occasional convergence touch ups without having to learn the complex convergence procedure using the TOUCH-UP option in the EYE-Q™ menu. By doing so, the end-user can be assured that the image quality is always at its best.

To work correctly, the installer must complete geometry (setting green only) for one source which is the reference geometry. Every memory that is auto-converged after that will use the same geometry as the reference. In most applications, however, multiple aspect ratios are to be converged, each with its own unique geometry. In this case, the geometry for each aspect ratio needs to be completed first, the EYE-Q™ will converge the red and blue colors to the green for each aspect ratio.

The last step is for the installer to touch-up the convergence using the fine convergence using the fine convergence adjustments for the red and the blue. The EYE-Q™ is typically 95% accurate when doing a FULL AUTOCONVERGENCE adjustment, depending on screen size and how well the initial EYE-Q™ setup was performed.

THE QUICK GUIDE to using the EYE-Q™ system:

- Do geometry for the current memory bank (see geometry section)
- Focus the lens in EYE-Q™ SETUP menu
- Center the camera in EYE-Q™ SETUP menu
- Set blanking for each edge. See GEOMETRY section.
- Select AUTO-CONVERGENCE then ALIGN on current source from the EYE-Q™ menu

If all five steps were completed successfully, the projector will have already begun to converge red and blue automatically at this time. Please read further for detailed instructions of each adjustment.

Easy-to-use, high precision automatic convergence system

Various options on the menu offer you the solution for your own individual needs:

Align: convergence starts for the current image situation

Align from mid-position: convergence starts from mid-position.

Touch-up: convergence starts when the source switches or after a user-defined time: alignment of static convergence is almost invisible for the audience.

Easy-to-use, high precision automatic geometry system

Various options on the menu offer a comprehensive solution to your geometry requirements:

Quick auto-picture: aligns geometry within 45 seconds.

Full auto-picture: aligns geometry very accurately followed by auto convergence. This option offers a very powerful adjustment tool.

Note: Must have a reference geometry set up first for these options.

Compact, built-in system

A very compact, monochrome CCD camera

Use of Sub-Pixel Resolution Techniques, a state-of -the -art proprietary Digital Signal Processing System.

Preparing your EYE-Q™

When the lens of the EYE-Q™ is covered with the lens protection cap, ensure to remove this cap first before starting the adjustment procedure for the EYE-Q™.

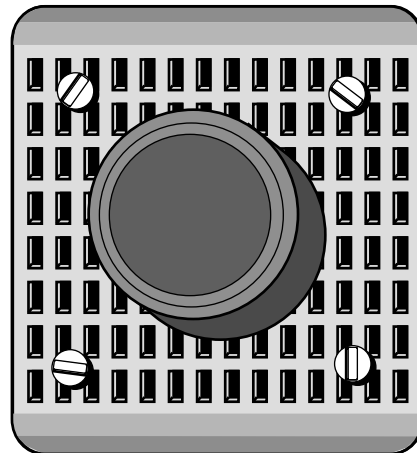

ON- SCREEN OPERATING INSTRUCTIONS

ACCESS TO EYE-Q™ ON-SCREEN MENUS

After the EYE-Q™ unit has been correctly installed in the projector, press the <ADJUST> button on the RCU (Remote Control Unit) or the local keypad of the projector to enter the 'Adjustment mode'

(please refer to the projector Owner's Manual). The EYE-Q™ path will be displayed in the menu:

Highlight EYE-Q™ by pushing the ▲ or ▼ keys of the control disc (on RCU).

Press the <ENTER> button to enter the EYE-Q™ menu.

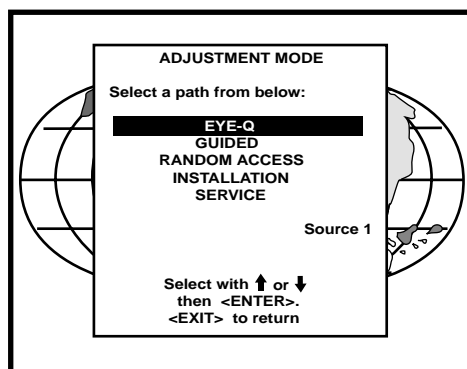

EYE-Q™ MENU

The EYE-Q™ menu will be displayed after the path EYE-Q™ is selected. Six items are available:

TOUCHUP.

AUTOCONVERGENCE.

QUICKAUTOPICTURE.

FULLAUTOPICTURE.

EYE-Q™ SETUP.

EYE-Q™ DIAGNOSTICS.

Choose *EYE-Q™ SETUP* first to carry out the *SETUP* procedures.

Use *EYE-Q™ DIAGNOSTICS* to check whether the EYE-Q™ is functioning normally.

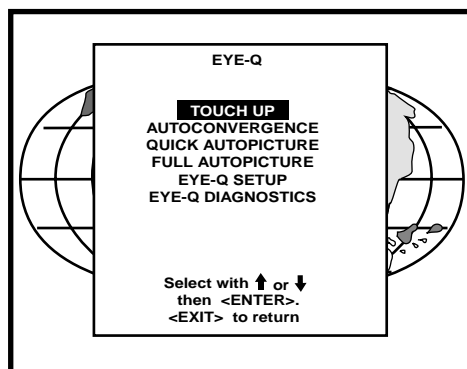

EYE-Q™ SETUP

The EYE-Q™ SETUP procedure needs to be done only once after projector is correctly installed or whenever the projector is reinstalled in another position.

To enter the EYE-Q™ SETUP menu:

Highlight EYE-Q™ by pushing the ▲ or ▼ keys of the control disc.

Press the <ENTER> button to set the correct projector configuration.

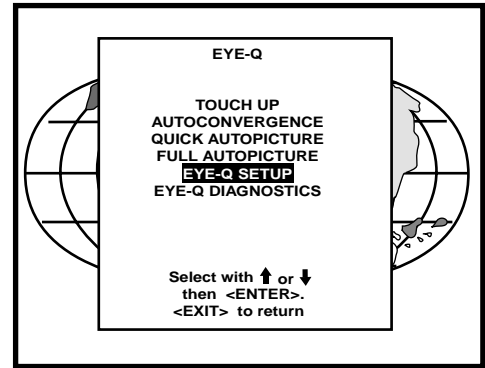

Setting the Configuration

When using a rear screen projector, this option must be set to rear. Follow the steps described below to set the right configuration:

Highlight FRONT (or REAR) by pushing the ▲ or ▼ keys of the control disc.

Press the <ENTER> button to set the correct projector configuration.

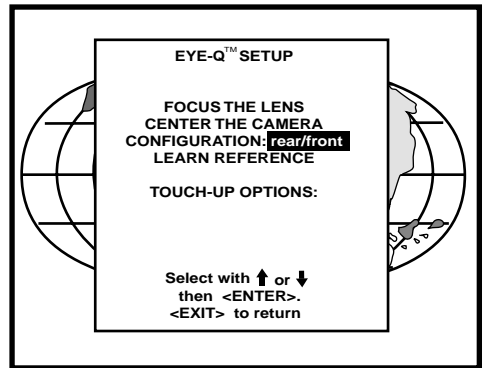

The EYE-Q™ SETUP menu provides you with easy to use methods to focus the camera lens and to center the camera.

Please pay attention while doing it, as a properly focused camera lens and correctly centered camera are prerequisites for a perfect automatic convergence.

FOCUSING THE CAMERA LENS

The lens of the camera must be focused properly on the projection screen. Follow the steps described below:

In the EYE-Q™ SETUP menu, highlight **FOCUS THE LENS** by pushing the up or down keys of the control disc.

Press the **<ENTER>** button to start up the process.

A pattern of horizontal alternating green/black bars will be projected onto the screen, together with a textbox. Inside the box, the text "CAMERA FOCUS" indicates the item subject to adjustment and under the text, a numeric bar scale (from 0 to 99) will visualize the correction.

To obtain a correctly focused camera, turn the lens until maximum readout. The value of the stabilized maximum readout will be in the range between 60 and 90, depending on ambient light.

In rear projection, the maximum value can be less than 60 dependent on ambient light.

After finishing the correction, press the **<EXIT>** button to return to the EYE-Q™ menu

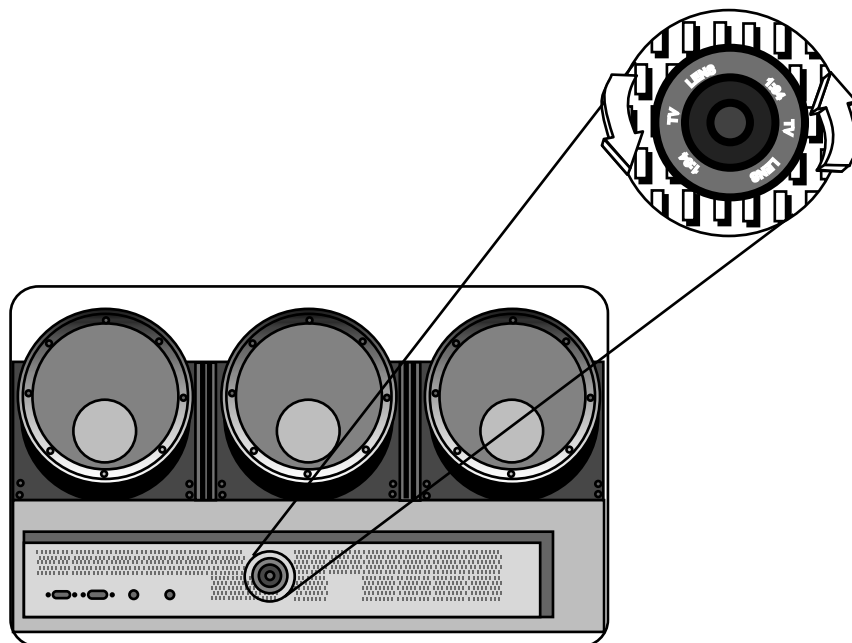
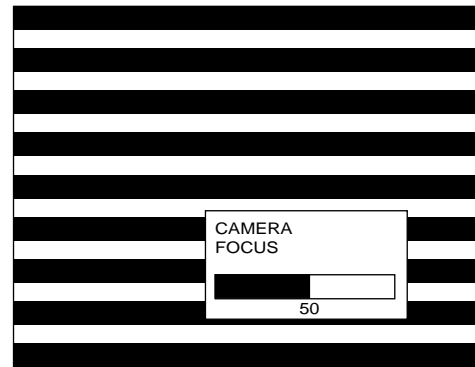
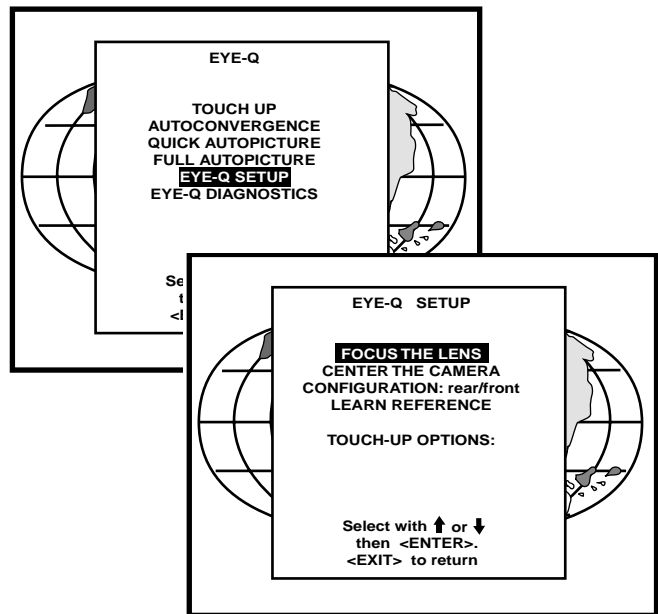

CENTERING THE CAMERA

The camera must be centered in middle of the projection screen. Follow the steps described below:

Highlight CENTER CAMERA by pushing the up or down keys of the control disc.

Press the <ENTER> button to start up the process.

Note: It is critical that the green raster of the presently selected source is centered on the CRT faceplate. Otherwise, the camera will not be centered properly.

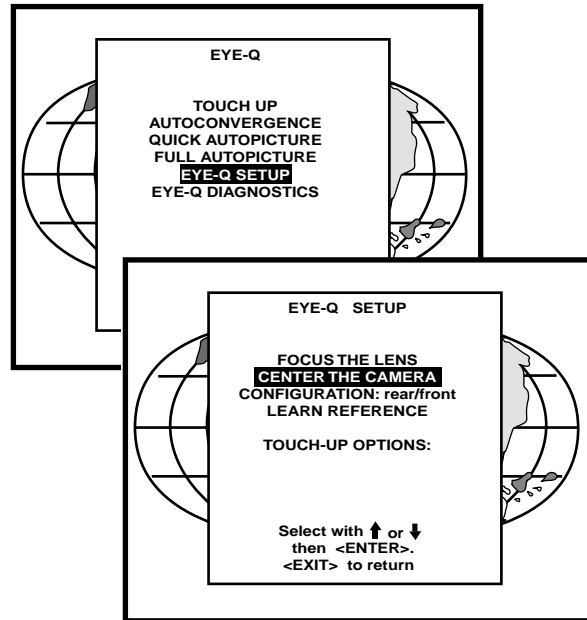

CENTERING THE CAMERA HORIZONTALLY

One vertically centered green bar will be projected onto the screen, together with a text box. Inside the box, the text of "CAMERA ALIGNMENT HORIZONTAL" indicates the item subject to adjustment and a symmetrical bar scale (from -50 to +50) under text.

If the indicated value below the bar scale is not equal to zero (i.e. the black highlight is not in the middle of the bar scale), the camera is not centered horizontally. Follow the steps below to center the camera horizontally:

Turn the knob situated on the upper-right corner of the camera clockwise or counter clockwise until the highlight is in the middle of the bar scale (i.e. the indicated value becomes zero);

Press the <ENTER> button to continue with the camera vertical centering.

Note: An easy way to remember the H+V adjustments is: The knob located up/down from the fixed screw is vertical adjustment. The knob located left/right from the fixed screw is horizontal adjustment.

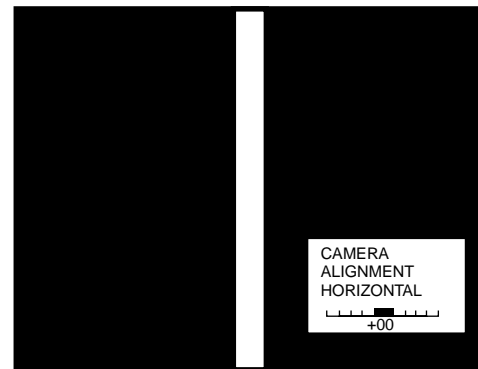

**Fixed screw
No Adjustment**

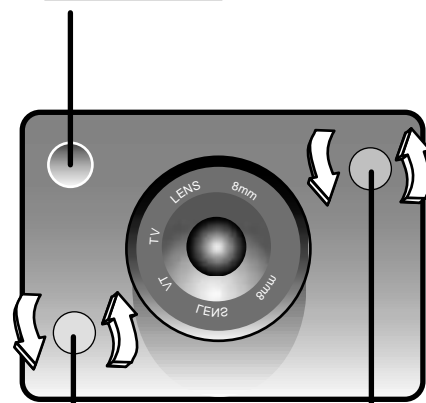

**Knob for centering
the camera vertically**

**Knob for centering
the camera
horizontally**

CENTERING THE CAMERA VERTICALLY

One horizontally centered green bar will be projected onto the screen, together with a text box. Inside the box, the text of "CAMERA ALIGNMENT VERTICAL" indicates the item subject to adjustment and a symmetrical bar scale (from -50 to +50) under the text.

If the indicated value below the bar scale is not equal to zero (i.e. the black highlight is not in the middle of the bar scale), the camera is not centered vertically. Follow the steps below to center the camera vertically:

Turn the knob situated on lower-left corner of the camera clockwise or counter clockwise until the highlight is in the middle of the bar scale (i.e. the indicated value becomes zero).

After finishing the vertical centering, press the <ENTER> button to return to the EYE-QTM menu.

When installed in a retro projector, the centering procedure is not necessary and not possible as the camera mounting is fixed.

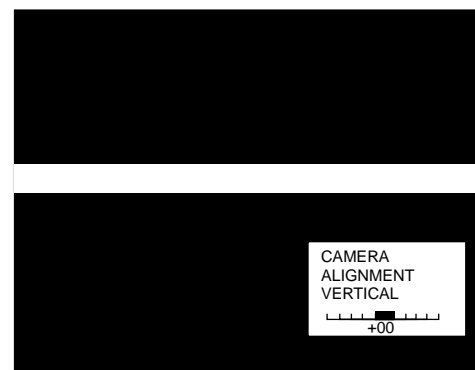

SET TOUCH-UP OPTIONS

For convergence purpose, the screen is divided into 25 areas. Every area has its unique number from 1 to 25. Touch-up adjust the Area No. 1. This adjustment is also called the "static convergence".

The Touch-up can be set on Source or on Timer. Touch-up on Source means when switching from one source to another, the static convergence will be carried automatically.

Touch-up on Timer means whenever the user-defined period of time has elapsed the static convergence will be adjusted automatically.

Touch-up is an option the customer can use periodically after a final install is complete. This will insure image quality is at its best.

TOUCH-UP ON SOURCE ON/OFF

Follow the steps below to set the option ON/OFF:

Push up or down keys of the control disc to highlight ON SOURCE SWITCH: off;

Press the <EXIT> button to return to the EYE-Q™ menu.

25	23	9	15	17
24	22	8	14	16
5	4	1	2	3
20	18	6	10	12
21	19	7	11	13

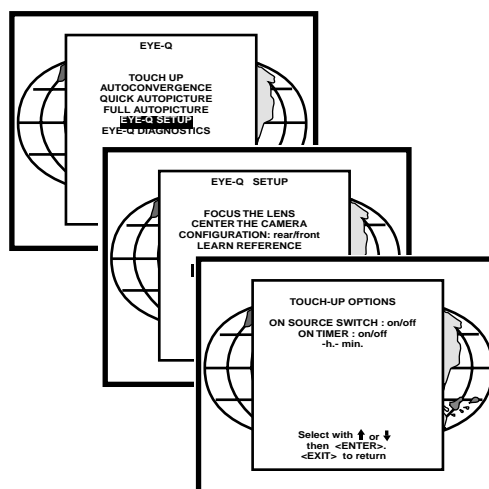

TOUCH-UP ON TIMER

This option allows the static convergence to be carried out automatically after a user-defined time, which can be programmed in hours and/or minutes.

To program the touch-up on Timer:

Push up or down keys of the control disc to highlight ON TIMER: off;

Press the <ENTER> button to switch it to ON and the preset time will be displayed;

Press the <TEXT> button to enter the TOUCH-UP TIMER menu;

Push left or right keys of the control disc to highlight the digit to be changed;

Use the numeric keys to enter a desire value;

Press the <ENTER> button to confirm and the EYE-Q™ SETUP menu will return on the screen; or press the <EXIT> button to leave the preset value untouched and return to the EYE-Q™ SETUP menu.

Press the <EXIT> button to return to the EYE-Q™ menu.

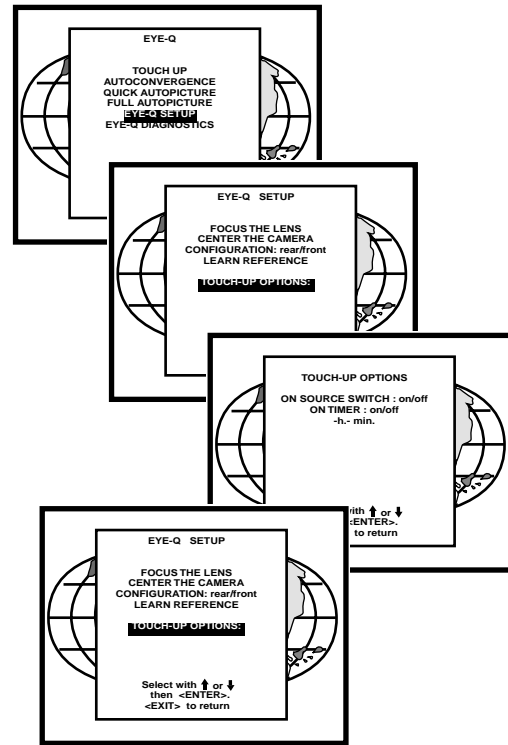

When one adjust geometry by hand, a reference screen and a reference pattern are required. There are a lot of possibilities for a reference pattern screen. A test pattern for a video test disc is normally used. See geometry section of manual for more information. Once a selection of a reference screen and a reference pattern is made, adjusting geometry is only a matter of converging these two elements.

EYE-Q™ requires a reference for adjusting geometry. The simplest way to have a reference screen is to adjust one source by hand, which then serves as a reference for all other sources. After adjusting a source, the reference is learned by EYE-Q™ and stored in non-volatile memory. Having this Reference Source in memory EYE-Q™ can adjust all other sources to have the same geometry as the Reference Source.

REFERENCE SOURCE

Before any geometric adjustment can be done, the user Must learn a Reference Source. This process is ONLY DONE ONCE since the Reference will be stored in non-volatile memory. If however, the projector is moved from its position, then the Learn Reference procedure must be repeated. After learning a Reference do not touch the camera (for focusing and centering).

If using multi-aspect ratios, a Reference Geometry must be done for each aspect ratio.

ADJUSTING OTHER SOURCES

Once a Reference Source is in memory, other sources are aligned with the same geometry as the Reference Source. If no Reference Source is learned, the resulting geometry will be unpredictable.

LEARNING A REFERENCE

Learning a reference needs only to be done when the EYE-Q is setting up Geometry for the green. In typical applications, green geometry is completed manually and EYE-Q is used to autoconverge red + blue colors to the green.

Adjust one Reference Source with perfect geometry. This source can have either horizontal or vertical frequency. Remember that other sources will have the same geometry as this Reference Source. This means that if a source has 4:3 aspect ratio, all sources will be adjusted with a 4:3 aspect ratio and the same horizontal and vertical amplitudes.

Follow the steps below to select:

Enter in the Adjustment Mode and select EYE-Q™ by pushing up or down keys of the control disc. Now select SETUP using the up or down keys, finally select LEARN REFERENCE.

EYE-Q™ will now project the Reference Source with horizontal green line inserted at the top region and a horizontal green line inserted at the bottom region of the image.

Pushing the up or down keys of the control disc adjust the horizontal green line at the top until it matches the top edge of the Reference Source perfectly, then press <ENTER>.

Using the up or down keys of the control disc adjust the horizontal green line at the bottom until it matches the bottom edge of the Reference Source perfectly, then press <ENTER>.

Now EYE-Q™ projects the Reference Source with a vertical green line inserted at the left and a vertical green line inserted at the right.

Pushing the up or down keys of the control disc changes the position of the vertical green lines simultaneously; they are being shifted symmetrically inward and outward with respect to the scan of the projector.

Use left or right keys of the control disc to change the phase of the Reference Source. Use both (up or down) or (left or right) so that the green vertical lines perfectly match the right-left edges of the reference image, then press <ENTER> (this will initiate the learning procedure).

NOTE: If you had to use the left and right arrow keys to adjust the phase, this means that the phase of the Reference Source was originally not adjusted correctly. Hence the Reference Source may now fall short of the physical screen. To avoid this, re-adjust the **Horizontal Raster Shift** (in the Random Access Adjustment mode, refer to Owner Manual) so that the Reference source falls on the physical screen and repeat the Learn Reference selection.

Do not adjust the phase when repeating the Learn Reference procedure.

Pressing <EXIT> will interrupt the Learn Reference procedure if required.

WHAT IS BEING MEASURED BY EYE-Q™

Using the borderlines define above, EYE-Q™ knows exactly when the image starts and stops with respect to time scale. EYE-Q™ is now able to project lines at the edges. Using the border lines left and right, EYE-Q™ projects three vertical thick green lines at positions 5, 50 and 95%. Using the border lines top and bottom, EYE-Q™ projects three horizontal thick lines at positions 5, 50 and 95%. EYE-Q™ then calculates the intercepts of the three vertical and three horizontal lines resulting in nine points. These nine points are the reference points for other geometry sources and are stored into memory.

NOTE: "DELETE ALL BLOCKS" in the Service menu does not delete the Reference source parameters.

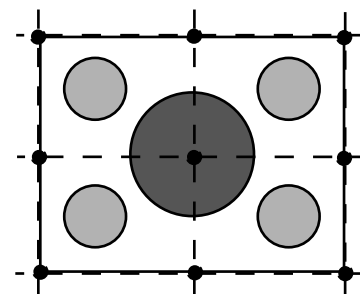
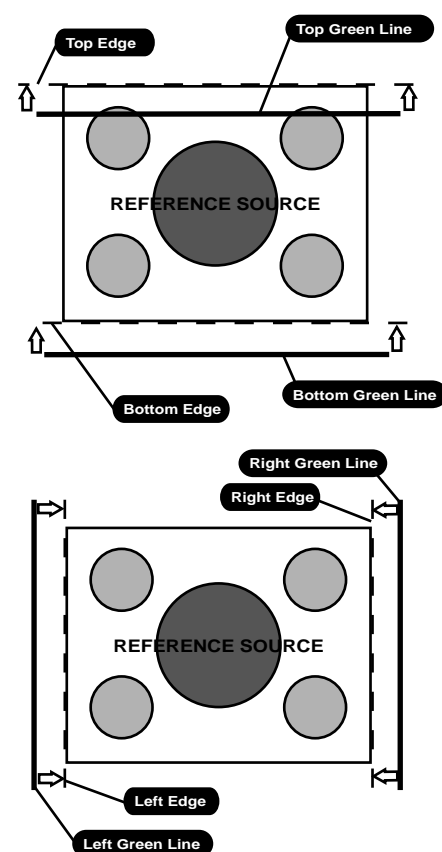
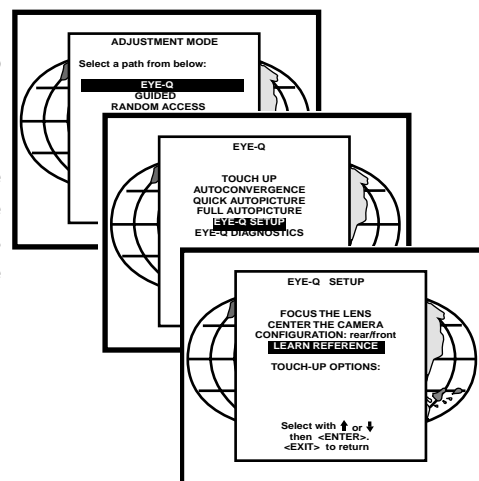

TOUCH UP AND AUTOCONVERGENCE

ADJUSTING SCREEN SIZE

In case the projection screen is not greater than the desired size or the screen has a frame around it (i.e. projection impossible outside the frame), the following blanking adjustments have to be done before starting the automatic convergence:

When using a video source: adjust the top, bottom, left and right blanking until the whole projected image of video is just still visible;

When using a screen with a frame: adjust the top, bottom, left and right blanking until the whole projected image is just still visible.

So that the selected screen area after blanking adjustments corresponds with the projected image size. In this way, the screen size is set correctly to ensure the successful convergence.

NOTE:

For blanking adjustments, please refer to the Projector Setup Manual.

To enter the AUTOCONVERGENCE menu:

Highlight AUTOCONVERGENCE by pushing up or down keys of the control disc;

Press the <ENTER> button.

The AUTOCONVERGENCE menu allows the automatic convergence either on the currently selected source or on all sources (all filled memory blocks of the projector).

ON CURRENT SOURCE

the on current source includes three options, the first of which is selectable in the iris menu:

Touch Up EYE-Q™

Align

Align from midposition

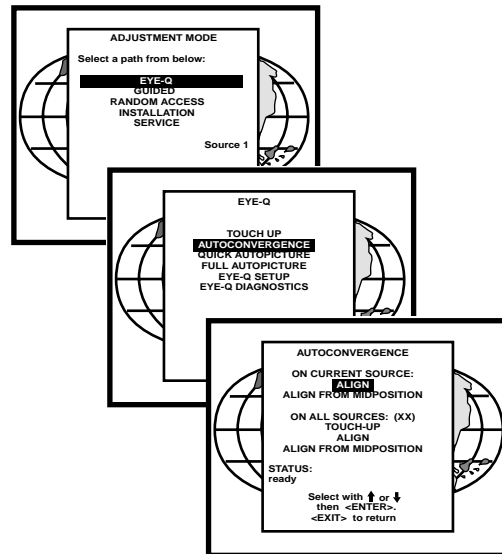
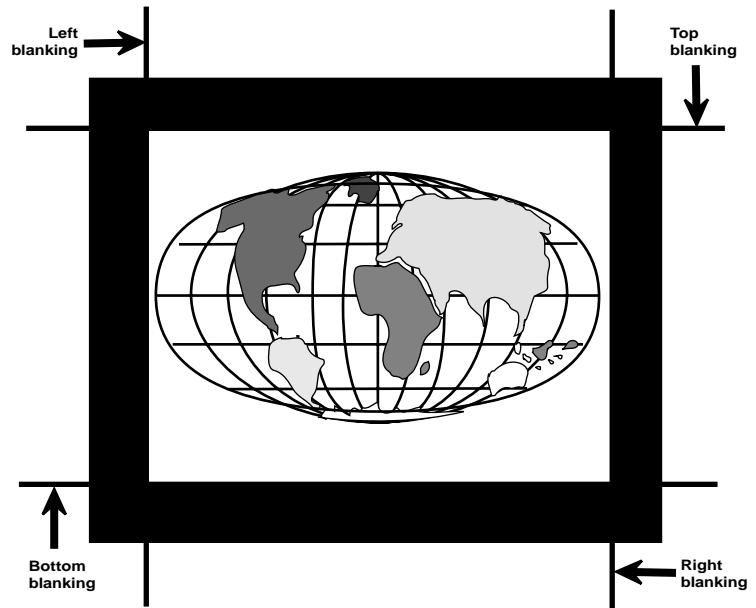

TOUCH-UP

When TOUCH-UP is selected, only the static convergence of the currently selected source will be carried out automatically. Follow the steps below to select:

Highlight TOUCH-UP by pushing up or down keys of the control disc;

Press the <ENTER> button to start up the static convergence.

If the process is successfully completed, the projector will return to image display of the current source.

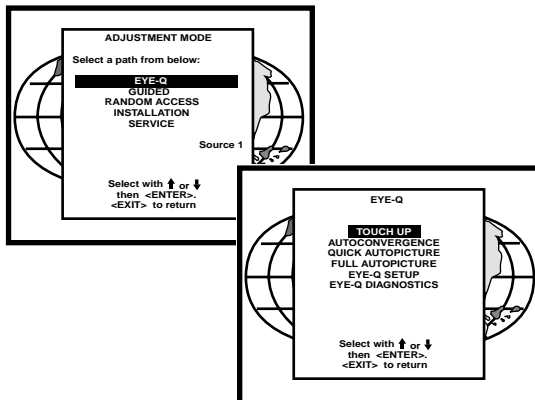

ALIGN ON CURRENT SOURCE

When ALIGN is selected, the automatic convergence on the current memory bank will be carried out automatically, starting from the existing settings.

By projecting alternately red and blue line, 25 convergence areas are aligned to the green pattern.

Follow the steps below to select:

Highlight ALIGN below ON CURRENT SOURCE by pushing up or down keys of the control disc;

Press the <ENTER> button to start up the automatic convergence of the entire screen.

If the process is successfully completed, the projector will return to image display of the current source.

Use this option when the convergence is close to proper alignment.

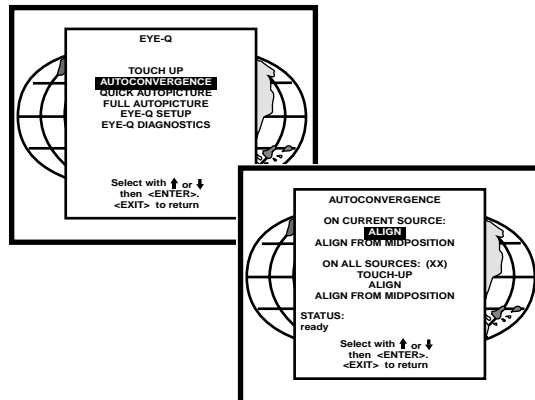

ALIGN FROM MIDPOSITION ON CURRENT SOURCE

When ALIGN FROM MIDPOSITION is selected, the automatic convergence on the current source will be carried out automatically, but starting from the mid-position settings.

By projecting alternately red and blue lines, 25 convergence areas are aligned to the green pattern.

Follow the steps below to select:

Highlight ALIGN FROM MIDPOSITION by pushing up or down keys of the control disc;

Press the <ENTER> button to start up the automatic convergence of the entire screen.

If the process is successfully completed, the projector will return to image display of the current source.

Use this option when the convergence is far from proper alignment.

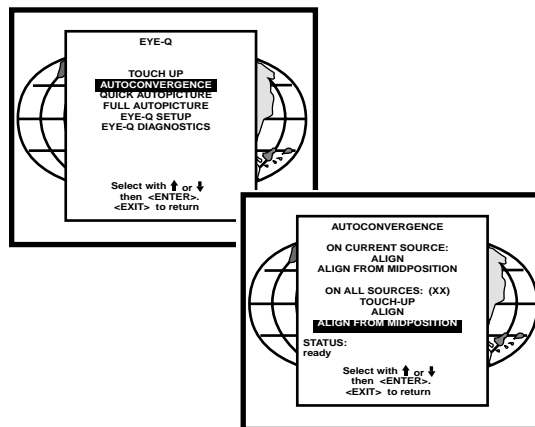

ON ALL SOURCES

The “On all sources” functions as the “On current source.” It includes also three options:

Touch-up

Align

Align from mid-position

The difference is that the convergences will be carried out on all sources of the projector, i.e. all available memory banks of the projector. The total number of sources is displayed between the brackets.

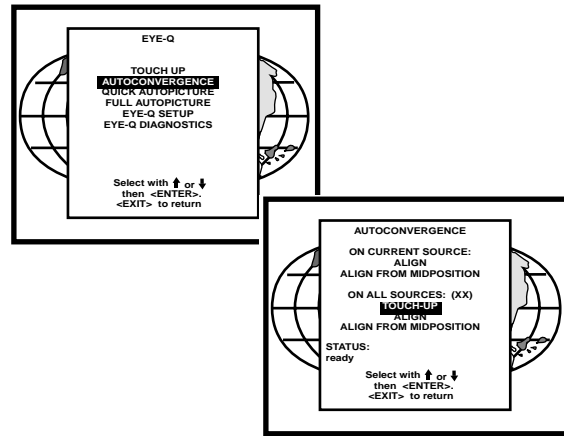

TOUCH-UP ON ALL SOURCES

When TOUCH-UP below ON ALL SOURCES by pushing up or down keys of the control disc;

Press the <ENTER> button to start up the static convergence.

The process will repeat for as many times as the total number of the sources until all sources are perfectly aligned.

If the process will repeat for as many times as the total number of the sources until all sources are perfectly aligned.

If the process is successfully completed, the projector will return to image display of the current source.

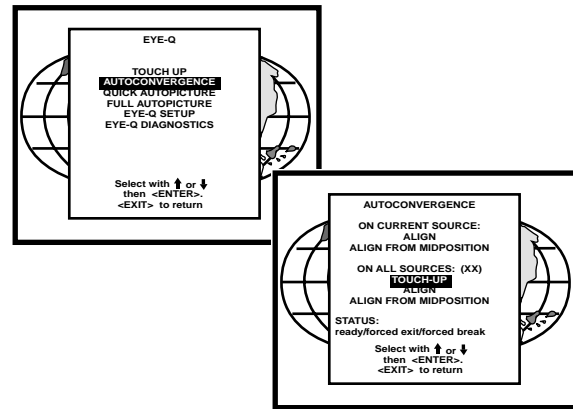

ALIGN ON ALL SOURCES

When ALIGN is selected, the automatic convergence on all sources will be carried out automatically, starting from the existing settings.

By projecting alternately red and blue lines, 25 convergence areas are aligned to the green pattern. The process will repeat for as many times as the total number of the sources until all sources are perfectly aligned.

Follow the steps below to select:

Highlight ALIGN below ON ALL SOURCES by pushing up or down keys of the control disc;

Press the <ENTER> button to start up the automatic convergence of the entire screen.

If the process is successfully completed, the projector will return to image display of the current source.

Use this option when the convergence is close to proper alignment.

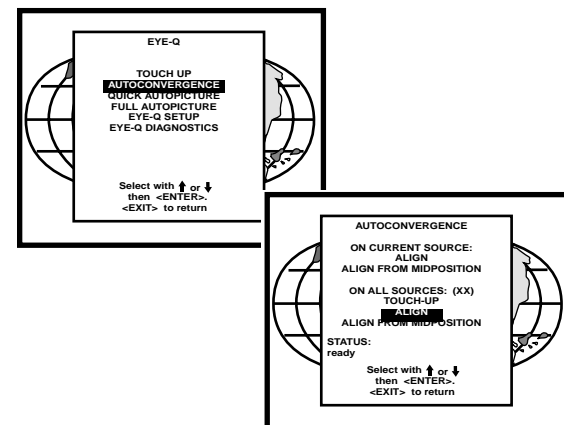

ALIGN FROM MIDPOSITION ON ALL SOURCES

When ALIGN FROM MIDPOSITION is selected, the automatic convergence on all sources will be carried out automatically, but starting from the midposition settings.

By projecting alternately red and blue lines, 25 convergence areas are aligned to the green pattern. The process will repeat for as many times as the total number of the sources until all sources are perfectly aligned.

Follow the steps below to select:

Highlight ALIGN FROM MIDPOSITION below ON ALL SOURCES by pushing up or down keys of the control disc;

Press the <ENTER> button to start up the automatic convergence of the entire screen.

If the process is successfully completed, the projector will return to image display of the current source.

Use this option when the convergence is far from proper alignment.

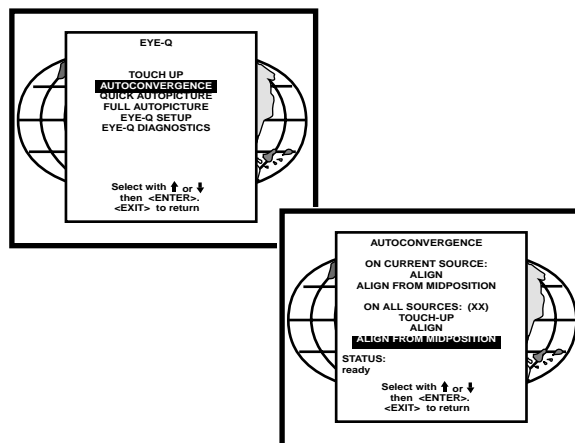

INTERRUPTING THE AUTOMATIC CONVERGENCE PROCESS

The process of the above-mentioned automatic convergence can be interrupted at any moment by pressing the <EXIT> button.

After the <EXIT> button is pressed, the projector will leave the automatic convergence process and a message will be displayed informing of the action:

Status: Forced<EXIT>

ERROR MESSAGES

The status line in the AUTOCONVERGENCE menu gives three possible messages:

Ready: before automatic convergence starts;

Forced<EXIT>: when interrupting the process;

Forced break: error message.

Error messages are displayed when the automatic convergence is not successfully completed.

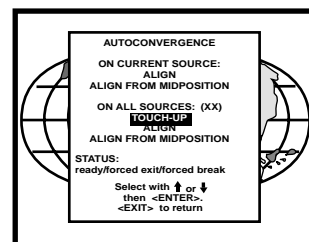
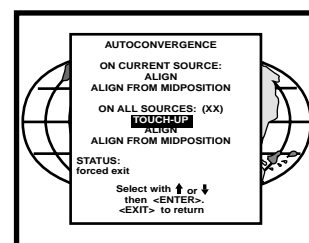

NO PATTERN ERROR

After starting up the automatic convergence, the projector will start to calculate and locate 5 horizontal and 5 vertical lines which are used to divide the screen into 25 areas.

If the projector does not succeed in finding the pattern, it will try two times. If the two attempts fail, the projector will quit the process and display the Error menu.

The AUTOCONVERGENCE selection will be followed by the error window displaying the following possibilities.

Error occurred, please check:

- the lens cap is removed
- the lens of the camera is correctly focused;
- the camera is correctly centered;
- if hardware problems exist, do diagnostics;
- the ambient light is too high;
- the blanking adjustments are correct;

Press the <ENTER> button to start EYE-Q™ diagnostics (refer to page for full details on EYE-Q™ diagnostics, please note that this option may vary in selection with different projectors).

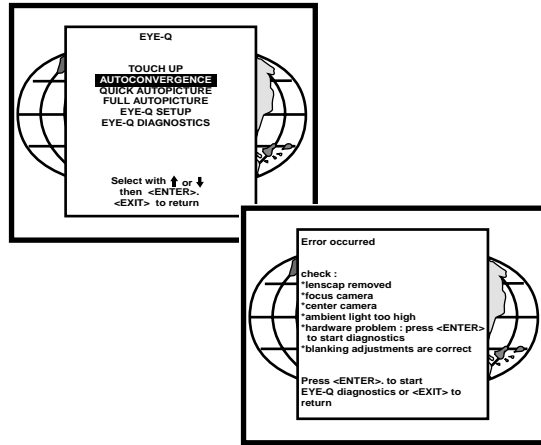

STATUS REPORTING FORCED BREAK

After starting up the automatic convergence, if unexpected trouble such as the interruption of source input occurs, the projector will quit the process and display the AUTOCONVERGENCE menu on the screen.

The status line in the AUTOCONVERGENCE menu will display the following message:

Status: **Forced break**

The possible causes of such an error:

The source is disconnected during the convergence:
On the screen a message "Source not available" will be displayed and projector waits until the source is reconnected or selected;

Switching sources during the convergence:
After the source is available again, the AUTOCONVERGENCE menu will be displayed the status line reporting "Forced Break."

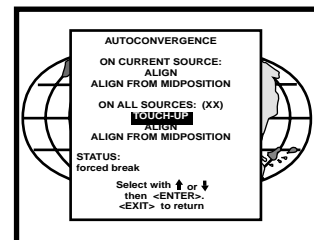

EYE-Q™ DIAGNOSTICS

This option allows a check-up of the EYE-Q™

NOTE: Most errors that occur during the LEARN REFERENCE procedure or the beginning of the AUTOCONVERGENCE procedure are caused by one of the following:

- Lens cap not removed
- Lens focus not performed properly
- Camera focus not performed properly
- Ambient light is too high
- Reference not learned properly
- Blanking not set properly—must set blanking to each edge of screen border
- If all else fails, run the diagnostics.

To start up the EYE-Q™ Diagnostics:

Highlight EYE-Q™ by pushing up or down keys of the control disc;

Press the <ENTER> button.

After the <ENTER> button is pressed, the EYE-Q™ DIAGNOSTICS menu will be displayed and the Tests start instantly.

It includes check-ups on four items:

- Interface Test;
- Generic Test;
- Sync Test;
- Ram Test.

After completing each test, the status report will give the test result:

- Pass; or
- Failed plus the error number.

During the Interface Test, the following messages will be displayed one after another on the screen:

- Ready and Config Test;
- Ready and Config OK;
- Config Ackn. Test;
- Config Ackn. OK;
- Full Config Test;
- Full Config OK;
- Interface Test OK.

In case of failures, the error message will be shown:

- FAILED... Error 01; or
- FAILED... Error 02; or
- FAILED... Error 03;.

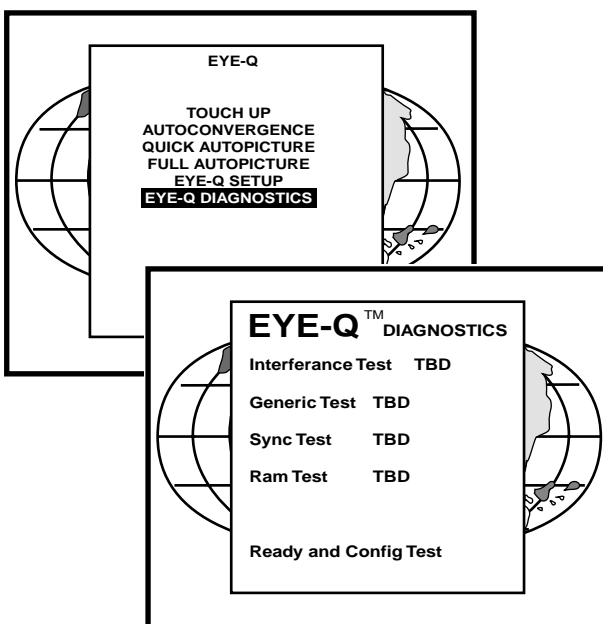

During the Generic Test, the following messages will be displayed one after another on the screen:

- Config for Generic;
- Config for Generic OK;
- Chipselects Test;
- Chipselects OK;
- Addressability Test;
- Addressability OK;
- Crystal and Reset Test;
- Crystal and Reset OK;
- Generic Test OK

In case of failures, the error message will shown:

FAILED... Error 11; or
FAILED... Error 12; or
FAILED... Error 13; or
FAILED... Error 14; or
FAILED... Error 15.

During the Sync Test, the following messages will displayed one after another on the screen:

Config for Sync;
Config for sync OK;
Horizontal Sync Test;
Horizontal Sync OK;
Vertical Sync Test;
Vertical Sync OK;
Frame and Field Test;
Frame and Field OK;
Sync Test OK.

In case of failures, the error message will be shown:

FAILED... Error 21; or
FAILED... Error 22; or
FAILED... Error 23; or
FAILED... Error 24; or
FAILED... Error 25; or
FAILED... Error 26; or
Sync Test Error 27
No syncs found
Check Camera & Cabling.

During the Ram Test, the following messages will displayed one after another on the screen:

Config for Ram;
Config for Ram OK;
Ram Data Line Test;
Ram Data Lines OK;
Ram Address Lines Test;
Ram Address Lines OK;
Ram Full Content Test;
Ram Full Content OK;
Ram Test OK

In case of failures, the error message will be shown:

FAILED... Error 31; or
FAILED... Error 32; or
FAILED... Error 33; or
FAILED... Error 34.

If all the tests are successful, the EYE-EYE-Q™ menu will be as follows:
Press the <EXIT> button to return to the EYE-™

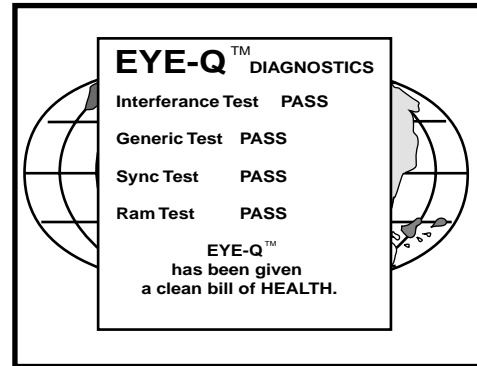

RUMA-003700 rev 10-00



THE WORLD'S FINEST HOME THEATER PRODUCTS™

2900 Faber Street
Union City, CA 94587
510-324-7777 Fax: 510-324-9300

Free Manuals Download Website

<http://myh66.com>

<http://usermanuals.us>

<http://www.somanuals.com>

<http://www.4manuals.cc>

<http://www.manual-lib.com>

<http://www.404manual.com>

<http://www.luxmanual.com>

<http://aubethermostatmanual.com>

Golf course search by state

<http://golfingnear.com>

Email search by domain

<http://emailbydomain.com>

Auto manuals search

<http://auto.somanuals.com>

TV manuals search

<http://tv.somanuals.com>