



---

# OWNER'S OPERATING MANUAL

---



## DTV-1101

*DTV Capable CRT Projector*



**THE WORLD'S FINEST HOME THEATER PRODUCTS™**



<b>Table of contents</b> .....	<b>i</b>
<b>Runco Limited Warranty</b> .....	<b>ii</b>
<b>Safety Instructions</b> .....	<b>1-1</b>
On safety .....	1-1
On installation .....	1-2
On servicing .....	1-2
On cleaning .....	1-2
On repacking .....	1-2
On illumination .....	1-2
<b>Location and Functions of Controls</b> .....	<b>2-1</b>
Rear panel terminology .....	2-1
Front panel terminology .....	2-1
Control panel terminology .....	2-2
a. The Local Keypad .....	2-2
b. RCU control panel terminology .....	2-2
<b>Connections</b> .....	<b>3-1</b>
AC Power (mains) Cord Connection .....	3-1
Power Check .....	3-1
Switching On/Off .....	3-1
Signal Input Connection to the Projector .....	3-2
Connecting a RGB Analog source to port 3 .....	3-3
Connecting a RGB Analog source to port 4/5 .....	3-3
Connecting a Component Video source to port 4/5 .....	3-4
<b>Controlling</b> .....	<b>4-1</b>
Battery Installation in the RCU .....	4-1
How to use your RCU .....	4-2
Projector Address .....	4-2
How to display a projector address .....	4-3
How to program an address into the RCU .....	4-3
Input Selection .....	4-3
Analog Picture Controls .....	4-3
Controlling Chained Projectors .....	4-4
<b>Start up of the Adjustment Mode</b> .....	<b>5-1</b>
Adjustment Mode .....	5-1
<b>Random Access Adjustment Mode</b> .....	<b>6-1</b>
Starting-Up the Random Access Adjustment mode .....	6-1
Overview 'Random Access Adjustment' mode .....	6-1
Selecting Setup Pattern .....	6-3
Internal Cross Hatch Pattern .....	6-3
Random Access Adjustment mode selection menu .....	6-4
Picture Tuning .....	6-4
Color Balance .....	6-4
Sync Fast/Slow Adjustment .....	6-5
Peaking .....	6-5
Clamp Tuning .....	6-5
Color Select .....	6-6
Focusing .....	6-7
Focusing Color Select .....	6-7
Blue On Source .....	6-7
Geometry Adjustments .....	6-8
Horizontal Phase Adjustment .....	6-8
Raster Shift Adjustment .....	6-9
Left-Right (east-west) Adjustments .....	6-10
Seagull Correction .....	6-11
Left Side Correction .....	6-11
Top-Bottom (north-south) Adjustments .....	6-12
Seagull Correction .....	6-13
Horizontal Size Adjustment .....	6-13
Vertical Linearity Adjustment .....	6-14
Vertical Size Adjustment .....	6-14
Blanking Adjustments .....	6-15
Convergence Adjustment .....	6-16
Course Convergence Adjustment .....	6-16
Fine Convergence Adjustment .....	6-17

Table of Contents

---

<b>Service Mode</b> .....	<b>7-1</b>
Starting up the Service mode .....	7-1
Overview flowchart 'Service' mode .....	7-1
Identification .....	7-2
Copy a Block .....	7-2
Deletion of Blocks .....	7-3
Deleting Block by Block .....	7-3
Deletion of All Blocks .....	7-3
Change Password .....	7-4
Change Language .....	7-4
Run Time .....	7-4
Set to Midposition .....	7-5
Undo Midposition .....	7-5
Convergence Mid .....	7-5
Undo Convergence Mid (position) .....	7-5
Dynamic Astigmatism (spot shape adjustment) .....	7-6
G2 Adjust .....	7-7
Gamma Corrections .....	7-7
CRT Run in Cycle .....	7-7
Projector Warm Up .....	7-8
CRT Drive Mode .....	7-8
Memory Banks .....	7-9
<b>Messages, Warnings, and Failures</b> .....	<b>8-1</b>
<b>Specifications</b> .....	<b>9-1</b>

Congratulations on your purchase of a Runco video product and welcome to the Runco family! We believe Runco produces the world's finest home theater products. With proper installation, setup, and care, you should enjoy many years of unparalleled video performance. Please read this consumer protection plan carefully and retain it with your other important documents.

This is a "LIMITED WARRANTY" as defined by the U.S. Consumer Product Warranty and Federal Trade Commission Improvement Act.

**WHAT IS COVERED UNDER THE TERMS OF THIS WARRANTY:**

**SERVICE LABOR:** Runco will pay for service labor by an approved Runco service center when needed as a result of manufacturing for a period of one (1) year from the effective date of the warranty (warranty effective date).

**PARTS:** Runco will provide new or rebuilt replacement parts for the parts that fail due to defects in materials or workmanship for a period of one (1) year from the effective date of the warranty. Such replacement parts are then subsequently warranted for the remaining portion (if any) of the original warranty period.

**WHAT IS NOT COVERED UNDER THE TERMS OF THIS WARRANTY:**

This warranty only covers failure due to defects in materials and workmanship that occur during normal use and does not cover normal maintenance. This warranty does not cover cabinets or any appearance item; any damage to laser discs; failures resulting from accident, misuse, abuse, neglect, mishandling, misapplication, faulty or improper installation or setup adjustments, improper maintenance, alteration, improper use of any input signal; damage due to lighting or power line surges, spikes and brownouts; damage that occurs during shipping or transit; or damage that is attributed to acts of God. In the case of remote control units, damage resulting from leaking, old, damaged, or improper batteries is also excluded from coverage under this warranty.

**CAUTION: DAMAGE RESULTING DIRECTLY OR INDIRECTLY FROM IMPROPER INSTALLATION OR SETUP IS SPECIFICALLY EXCLUDED FROM COVERAGE UNDER THIS WARRANTY. IT IS IMPERATIVE THAT INSTALLATION AND SETUP WORK BE PERFORMED ONLY BY AN AUTHORIZED RUNCO DEALER TO PROTECT YOUR RIGHTS UNDER THIS WARRANTY. THIS WILL ALSO ENSURE THAT YOU ENJOY THE FINE PERFORMANCE YOUR RUNCO PRODUCT IS CAPABLE OF PROVIDING WHEN INSTALLED AND CALIBRATED BY RUNCO AUTHORIZED PERSONNEL.**

**RIGHTS, LIMITS, AND EXCLUSIONS:**

Runco limits its obligations under any implied warranties under state laws to a period not to exceed the warranty period. There are no express warranties. Runco also excludes any obligation on its part for incidental or consequential damages related to the failure of this product to function properly. Some states do not allow limitations on how long an implied warranty lasts, and some states do not allow the exclusion or limitation of incidental or consequential damages, so the above limitations or exclusions may not apply to you. This warranty gives you specific legal rights, and you may also have other rights that vary from state to state.

**EFFECTIVE WARRANTY DATE:**

This warranty begins on the date of original purchase. For your convenience, keep the original bill of sale as evidence of the purchase date.

**IMPORTANT: WARRANTY REGISTRATION:**

Please fill out and mail your warranty registration card. It is imperative that Runco know how to reach you promptly as we should discover a safety problem or product update for which you must be notified.

**TO OBTAIN SERVICE — CONTACT YOUR RUNCO DEALER**

Repairs made under the terms of the limited warranty covering your Runco International video product will be performed at the location of the product, during usual working hours, providing location of product is within normal operating distance from a Runco Authorized Service Center. If, solely in Runco's judgement, location of product to be repaired is beyond normal operating distance of the closest Runco Authorized Service Center, it is the owner's responsibility to arrange for shipment of the product for repair. These arrangements must be made through the selling Runco dealer. If this is not possible, contact Runco directly for a return authorization number and shipping instructions. Runco will return product transportation prepaid in the United States, unless no product defect is discovered. In that instance, shipping costs will be the responsibility of the owner.

**ADDITIONAL INFORMATION:**

To locate the name and address of the nearest Runco authorized service location, or for additional information about this warranty, please call, write, or visit our web site:

**CUSTOMER SERVICE DEPARTMENT  
RUNCO INTERNATIONAL**

2463 Tripaldi Way  
Hayward, CA 94545  
(510) 293-9154  
FAX (510) 293-0201  
www.runco.com



# 1

## SAFETY INSTRUCTIONS

### Notice on Safety

This equipment is built in accordance with the requirements of the international safety standards EN60950, UL 1950 and CSA C22.2 No.950, which are the safety standards of information technology equipment including electrical business equipment.

These safety standards impose important requirements on the use of safety critical components, materials and isolation, in order to protect the user or operator against risk of electrical shock and energy hazard, and having access to live parts.

Safety standards also impose limits to the internal and external temperature rises, radiation levels, mechanical stability and strength, enclosure construction and protection against the risk of fire.

Simulated single fault condition testing ensures the safety of the equipment to the user even when the equipment's normal operation fails.

### Installation Instructions

**Before operating this equipment, please read this manual thoroughly and retain it for future reference.**

**Installation and preliminary adjustments should be performed by qualified Runco personnel or by authorized Runco service dealers.**

### OWNER'S RECORD

The part number and serial number are located at the back side of the projector. Record these numbers in the spaces provided below. Refer to them whenever you call your Runco dealer regarding this product.

**PART NUMBER :**

**SER. NUMBER :**

**DEALER :**

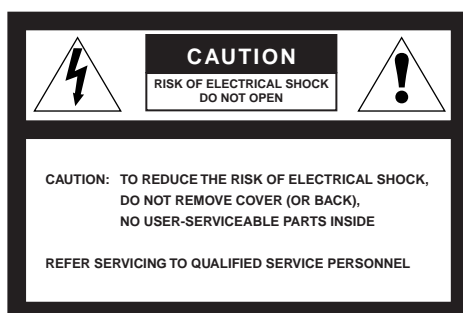

The lightning flash with an arrowhead within a triangle is intended to tell the user that parts inside this product may cause a risk of electrical shock to persons.



The exclamation point within a triangle is intended to tell the user that important operating and/or servicing instructions are included in the technical documentation for this equipment.

**WARNING  
TO PREVENT FIRE OR ELECTRICAL SHOCK  
HAZARD, DO NOT EXPOSE THIS EQUIPMENT**

### Federal Communication Commission (FCC Statement)

This equipment has been tested and found to comply with the limits of a class B digital device, pursuant to Part 15 of the FCC Rules. These limits are designed to provide reasonable protection against harmful interference when the equipment is operated in a commercial environment. This equipment generates, uses, and can radiate radio frequency energy and, if not installed and used in accordance with the instruction manual, may cause harmful interference to radio communications. Operation of this equipment in a residential area is likely to cause harmful interference, in which case, the user will be required to correct the interference at his own expense.

Instructions to the user :

If this equipment does cause interference to radio or television reception, the user may try to correct the interference by one or more of the following measures :

- Re-orient the receiving antenna for the radio or television.
- Relocate the equipment with respect to the receiver.
- Plug the equipment into a different outlet so that the equipment and receiver are on different branch circuits.
- Fasten cables connectors to the equipment by mounting screws.

*Note :*

*The use of shielded cables is required to comply within the limits of Part 15 of FCC rules and EN55022.*

- All the safety and operating instructions should be read before using this unit.
- The safety and operating instructions manual should be retained for future reference.
- All warnings on the equipment and in the documentation manuals should be followed.
- All instructions for operating and use of this equipment must be followed precisely.

### On Safety

1. This product should be operated from an AC power source. This projector may be connected to an IT-power system.

The operating voltage specification is located on the serial number sticker.

Consult your dealer to switch over from 230 VAC to 120 VAC or from 120 VAC to 230 VAC.

If you are not sure of the type of AC power available, consult your dealer or local power company.

2. This product is equipped with a 3-wire grounding plug, a plug having a third (grounding) pin. This plug will only fit into a grounding-type power outlet. This is a safety feature. If you are unable to insert the plug into the outlet, contact your electrician to replace your obsolete outlet. Do not defeat the purpose of the grounding-type plug.

**WARNING FOR THE CUSTOMERS:** THIS APPARATUS MUST BE GROUNDED (EARTHED) via the supplied 3 conductor AC power cable. (If the supplied power cable is not the correct one, consult your dealer.)

### A. Mains lead (Power cord) with CEE 7 plug:

The wires of the mains lead are colored in accordance with the following code.

Green and yellow: earth (safety earth)  
Blue: neutral  
Brown: line (live)

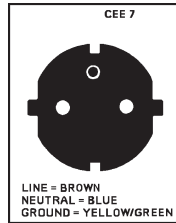

### B. Power cord with ANSI 73.11 plug:

The wires of the power cord are colored in accordance with the following code.

Green and yellow: ground  
White: neutral  
Black: line (live)

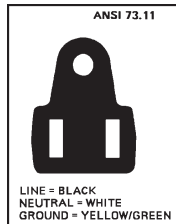

3. Do not allow anything to rest on the power cord. Do not locate this product where persons will walk on the cord.

To disconnect the cord, pull it out by the plug. Never pull the cord itself.

4. If an extension cord is used with this product, make sure that the total of the ampere ratings on the products plugged into the extension cord does not exceed the extension cord ampere rating. Also make sure that the total of all products plugged into the wall outlet does not exceed 15 amperes.

5. Never push objects of any kind into this product through cabinet slots as they may touch dangerous voltage points or short out parts that could result in a risk of fire or electrical shock.

Never spill liquid of any kind on the product. Should any liquid or solid object fall into the cabinet, unplug the set and have it checked by qualified service personnel before resuming operations.

6. Lightning - For added protection for this video product during a lightning storm, or when it is left unattended and unused for long periods of time, unplug it from the wall outlet. This will prevent damage to the projector due to lightning and AC power-line surges.

## On Installation

1. Do not place this equipment on an unstable cart, stand, or table. The product may fall, causing serious damage to it.

2. Do not use this equipment near water.

3. Slots and openings in the cabinet and the back or bottom are provided for ventilation. To ensure reliable operation of the product and to protect it from overheating, these openings must not be blocked or covered. The openings should never be blocked by placing the product on a bed, sofa, rug, or other similar surface. This product should never be placed near or over a radiator or heat register. The projector should not be placed in a built-in installation or enclosure unless proper ventilation is provided.

4. Do not block the projector cooling fans or free air movement under and around the projector. Loose papers or other objects may not be nearer to the projector than 4" on any side.

## On Servicing

Do not attempt to service this product yourself, as opening or removing covers may expose you to dangerous voltage potentials and risk of electrical shock!

Refer all servicing to qualified service personnel.

**Unplug this product from the wall outlet and refer servicing to qualified service personnel under the following conditions:**

- A. When the power cord or plug is damaged or frayed.
- B. If liquid has been spilled into the equipment.
- C. If the product has been exposed to rain or water.
- D. If the product does not operate normally when the operating instructions are followed.  
Note: Adjust only those controls that are covered by the operating instructions since improper adjustment of the other controls may result in damage and will often require extensive work by a qualified technician to restore the product to normal operation.
- E. If the product has been dropped or the cabinet has been damaged.
- F. If the product exhibits a distinct change in performance, indicating a need for service.

**Replacement parts** - When replacement parts are required, be sure the service technician has used original Runco replacement parts or authorized replacement parts which have the same characteristics as the Runco original part. Unauthorized substitutions may result in degraded performance and reliability, fire, electrical shock or other hazards. Unauthorized substitutions may void warranty.

**Safety check** - Upon completion of any service or repairs to this projector, ask the service technician to perform safety checks to determine that the product is in proper operating condition.

## On Cleaning

**Unplug this product from the wall outlet before cleaning. Do not use liquid cleaners or aerosol cleaners. Use a damp cloth for cleaning.**

- To keep the cabinet looking brand-new, periodically clean it with a soft cloth. Stubborn stains may be removed with a cloth lightly dampened with mild detergent solution. Never use strong solvents, such as thinner or benzine, or abrasive cleaners, since these will damage the cabinet.

- To ensure the highest optical performance and resolution, the projection lenses are specially treated with an anti-reflective coating, therefore, avoid touching the lens. To remove dust on the lens, use a soft dry cloth. Do not use a damp cloth, detergent solution, or thinner.

## On Repacking

Save the original shipping carton and packing material; they will come in handy if you ever have to ship your equipment. For maximum protection, repack your set as it was originally packed at the factory.

## On Illumination

In order to obtain the best quality for the projected image, it is essential that the ambient light be kept to an absolute minimum.

When installing the projector and screen, care must be taken to avoid exposure to ambient light directly on the screen. Avoid adverse illumination on the screen from direct sunlight or fluorescent lighting fixtures.

The use of controlled ambient lighting, such as an incandescent spotlight or a dimmer, is recommended for proper room illumination. Where possible, care should also be taken to ensure that the floors and walls of the room in which the projector is to be installed are non-reflecting, dark surfaces. Brighter surfaces will tend to reflect and diffuse the ambient light and hence reduce the contrast of the projected image on the screen.



# 2

## LOCATION AND FUNCTION OF CONTROLS

### REAR PANEL TERMINOLOGY

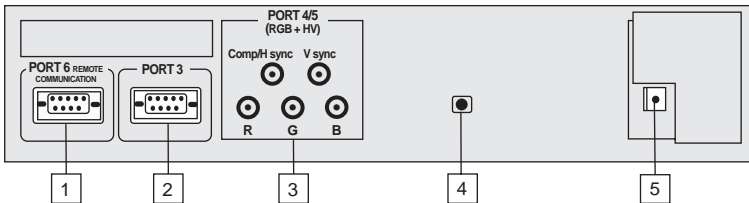

- 1 Communication Port**  
\* Not used.
- 2 Port 3**  
RGB Analog Input (9 pin female sub D connector): allows a character generator, microcomputer, etc. having analog RGB outputs to be connected to the projector.
- 3 Port 4/5 RGB-S Input (5x BNC connector):**  
*RGB-Input:* allows a character generator, microcomputer, video camera, etc. having analog RGB output to be connected to the projector.

Line inputs:    - signals RED-GREEN-BLUE  
                     - COMPOSITE sync signal  
                     - Tri level sync signal (option)
- 4 Projector Mode:** indicates the status of the projector.

  - unlit: mains (power) switch is not pressed.
  - lit: mains (power) switch is pressed and the indicated color shows the projector mode:
  - Green: operational mode of the projector.
  - Red: standby mode of the projector.

Important: projector ("Operational" or "Standby") mode is defined during the installation of the projector. (Refer to a qualified technician for change).
- 5 Power Switch:** press the switch to turn the projector ON.

Depending on the hardware set-up of the projector during installation, the projector will switch to 'Standby' or to 'Operational' mode. If in standby, the standby LED will light up.

### FRONT PANEL TERMINOLOGY

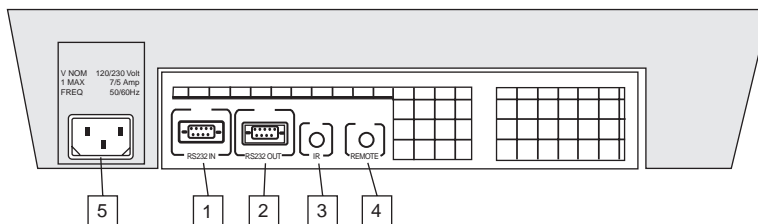

- 1 RS 232 Input Port**  
Connection between the projector and an IBM PC (or compatible) or MAC (RS422) for remote computer control and data communication.
- 2 RS 232 Output Port**  
RS 232 Output Port allows a communication link for PC or MAC to the next projector in a series of projector.
- 3 IR Sensor**  
Receiver for control signals transmitted from the RCU.
- 4 IR Remote**  
Connector for remote input for hard wired remote control
- 5 AC Power Input**

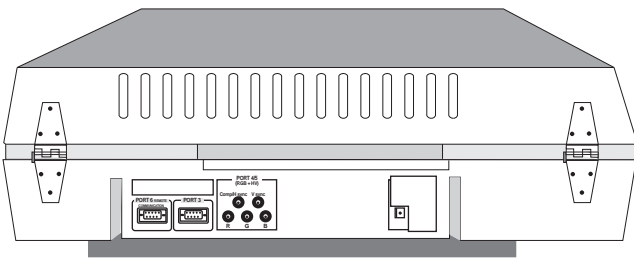

## Control Panel Terminology

### a. The Local Keypad (built in RCU)

#### Gaining Access

The local keypad is built into the rear of the projector. Push once on the door cover and it will open. It is possible to turn it 90°. This local keyboard has the same functions as the Remote Control Unit (RCU).

### b. RCU Control Panel Terminology

This remote control includes a battery powered infrared (IR) transmitter that allows the user to control the projector remotely. This remote control is used for source selection, control, adaptation and set-up. It includes automatic storing of :

- picture controls (Brightness, Sharpness...)
- picture geometry adjustments
- convergence adjustments

Other functions of the remote control are:

- switching between standby and operational modes
- switching to "pause" (picture mute)
- direct access to all connected sources
- variable adjustment speed: when pushing continuously on the control stick or the picture keys, the adjustment will be executed in an accelerated fashion.

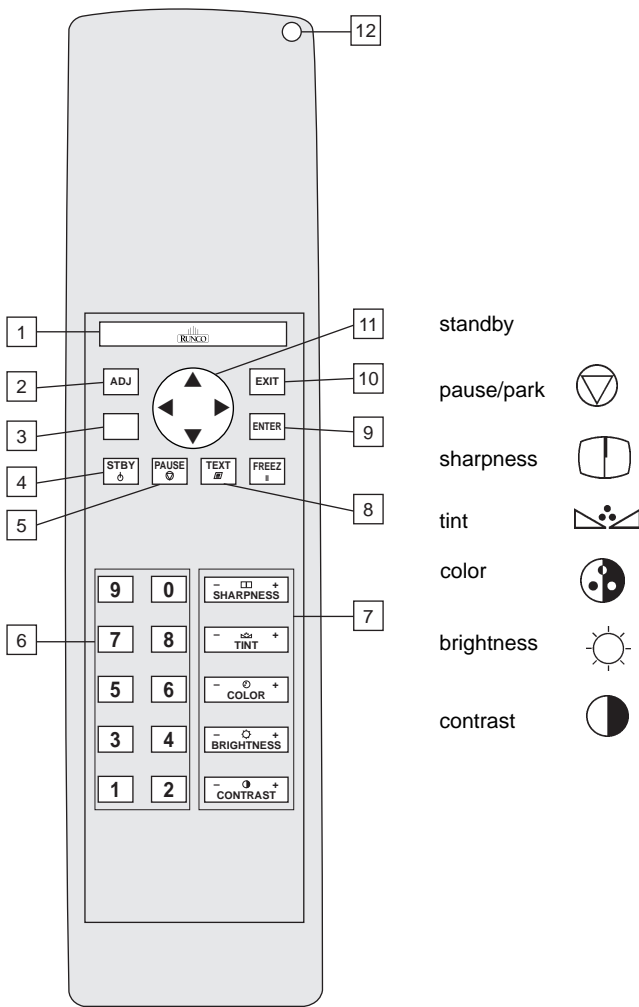

- 1 Backlight Key:** when activated, all keys will be lit up and visible in the dark.
- 2 ADJ.:** adjust key, to enter or exit the adjustment mode.
- 3 Address Key (recessed):** to enter the address of the projector (between 0 and 9). Press the address key, followed by pressing one digit button between 0 and 9. When programmed with address 0, the remote will talk to all projectors regardless of their address. See page 4-2 on Setting Projector Address.
- 4 STBY (standby):**
  - to initiate remote power up operation
  - to put the projector in standby
- 5 Pause:** to mute, press PAUSE. The image will disappear but full power will be retained for immediate restarting.
- 6 Digit Buttons:** direct aspect ratio selection.
- 7 Picture Controls:** use these buttons to obtain the desired level (see also 'Controlling') for each picture function.
- 8 TEXT:** when adjusting one of the image controls during a meeting, the displayed bar scale can be removed by pressing 'TEXT' key first. To re-display the bar scale on the screen, press 'TEXT' key again. 'TEXT' key is only active in the operational mode. When 'TEXT' is off, no warning message will be displayed.
- 11 Control Disk:** to make menu selections when in the adjustment mode. Also allows to increment or decrement an adjustment in the adjustment mode.
  - control disk up = up arrow in the menus
  - control disk down = down arrow in the menus
  - control disk to the right = arrow to the right on the menus
  - control disk to the left = arrow to the left on the menus
- 12 RC Operating Indication:** lights up when a button on the remote control is pressed. (This is a visual indicator to check the operation of the remote control)

- 9 ENTER:** to start up the adjustment mode or to confirm an adjustment or selection in the adjustment mode.
- 10 EXIT:** to leave the adjustment mode or to scroll upwards when in the adjustment mode.

## 3

## CONNECTIONS

### AC Power (mains) Cord Connection

Use the supplied power cord to connect your projector to the wall outlet. Plug the female power connector into the male connector at the front side of the projector.

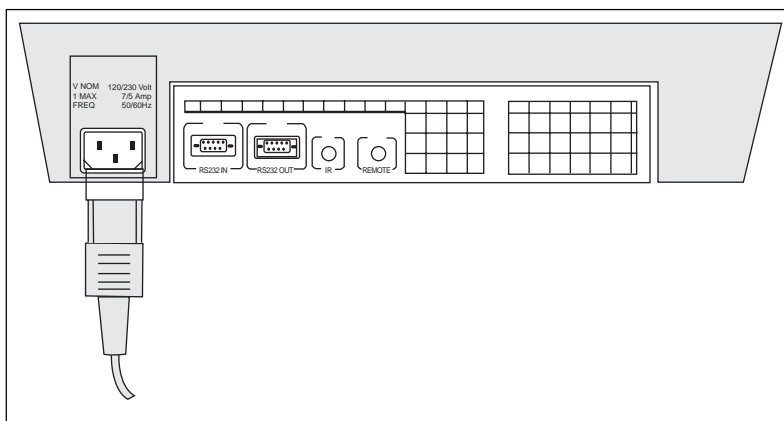

### Power Check

Power voltage indication is on the sticker on the rear side of the projector. The power voltage is indicated by the serial number sticker.

#### Warning !

Check if the indicated power voltage corresponds to that of the wall outlet.

If the wall outlet voltage is different, call a qualified technician for power adaptation of the projector.

### Switching On/Off

The main power to the projector is switched ON and OFF using the power (mains) switch ON/OFF.

Pressed: ON

Not pressed: OFF

The projector can start now in the 'operational mode' (image displayed) or in the 'standby mode', depending on the position of the 'power up' dip switch on the controller unit. This DIP switch must be set during installation by a qualified technician. If you want to change this startup mode, call a qualified technician.

Standby indication lamp:

no light: projector switched off

green color: projector in Operational mode

red color: projector is in Standby mode

When starting up the projector with the power switch or via the standby key, the projector can start up in two ways if the "CRT Run in Cycle" option is switched OFF:

- full white image (projector warm up) or
- immediately image display.

Your choice of starting can be set in the Service Mode.

**Start Up with Full White Image.**

If no action is taken, a white image will be displayed for 20 minutes. This white image will be shifted on the faceplate of the CRT to avoid a CRT burn in. During this warm-up period, it is possible to interrupt this white image projection by pressing the EXIT key.

If **EXIT** is pressed, the remaining warm-up period will be skipped.

During the warm-up period, every 30 seconds a text box with the remaining time will be displayed on the screen for 2 seconds. This text box will be displayed every time in another place.

**Signal Input Connection to the Projector**

- RGB/Component

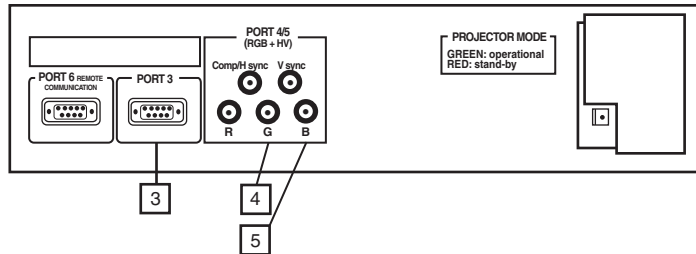

Port No	Projector input
3	RGB <sup>1</sup>
4/5	RGB/Component

<sup>1</sup> Input signal : R, G and B with automatic sync detection between separate sync (separate composite sync or with separate Horizontal and Vertical sync) or sync on green (composite sync).

## Connecting a RGB Analog Source to Port 3

Connect your RGB source via an interface to Port 3. Always use an interface when a computer and local monitor have to be connected to the projector.

RGB analog input with automatic sync detection. (Separate H and V sync inputs, with composite sync input or with sync signals on green)

Pin configuration D9 connector of the Analog input:

- 1 not connected
- 2 ground RGBS
- 3 RED
- 4 GREEN
- 5 BLUE
- 6 ground RGBS
- 7 ground RGBS
- 8 Hor/comp. sync
- 9 Vert. sync

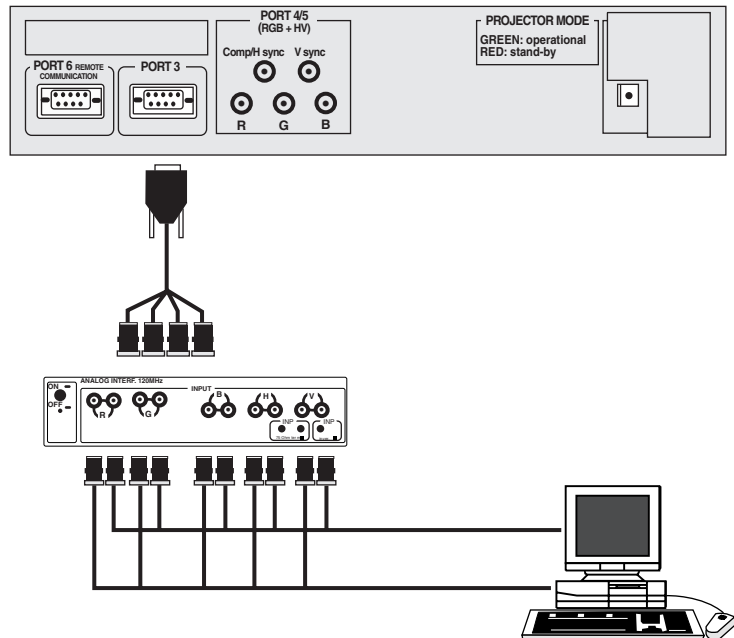

## Connecting a RGB or Component Source to Port 4/5

RGB analog input terminals with separate H and V sync inputs, with composite sync input or with sync signals on green (automatic sync detection), or component (Y, Pb, Pr) sources from a DTV Decoder, etc.

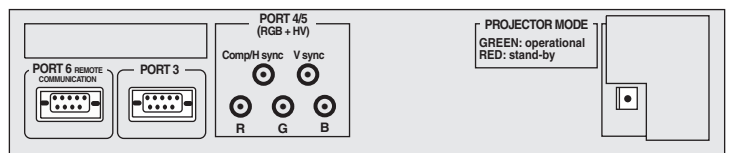

## Connecting a Component Video Source to Port 4/5

A component video source can be connected to the projector via the Port 4/5. The projector detects automatically where the sync signal is located.

To select the component video input, select **component** from the source selection menu.

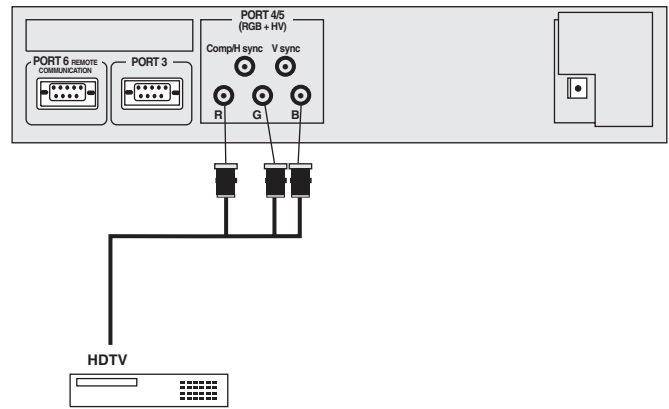

## 4

## CONTROLLING

**Caution:** Do not display a stationary image with full brightness and contrast for longer than 20 minutes, otherwise you risk damage to the CRTs.

### Battery Installation in the RCU

A new battery has been packaged inside the plastic bag with the power cord. Before using the RCU, install the battery first.

Remove the battery cover on the backside of the RCU by pushing the indicated handle a little to the bottom of the RCU. Lift the top side of the cover at the same time (fig. 1).

Insert the new 9V battery (type 6F22S or equivalent; alkaline batteries are recommended) in the lower compartment and connect the battery to the contact plate.

Insert the battery into the lower compartment and put the cover back.

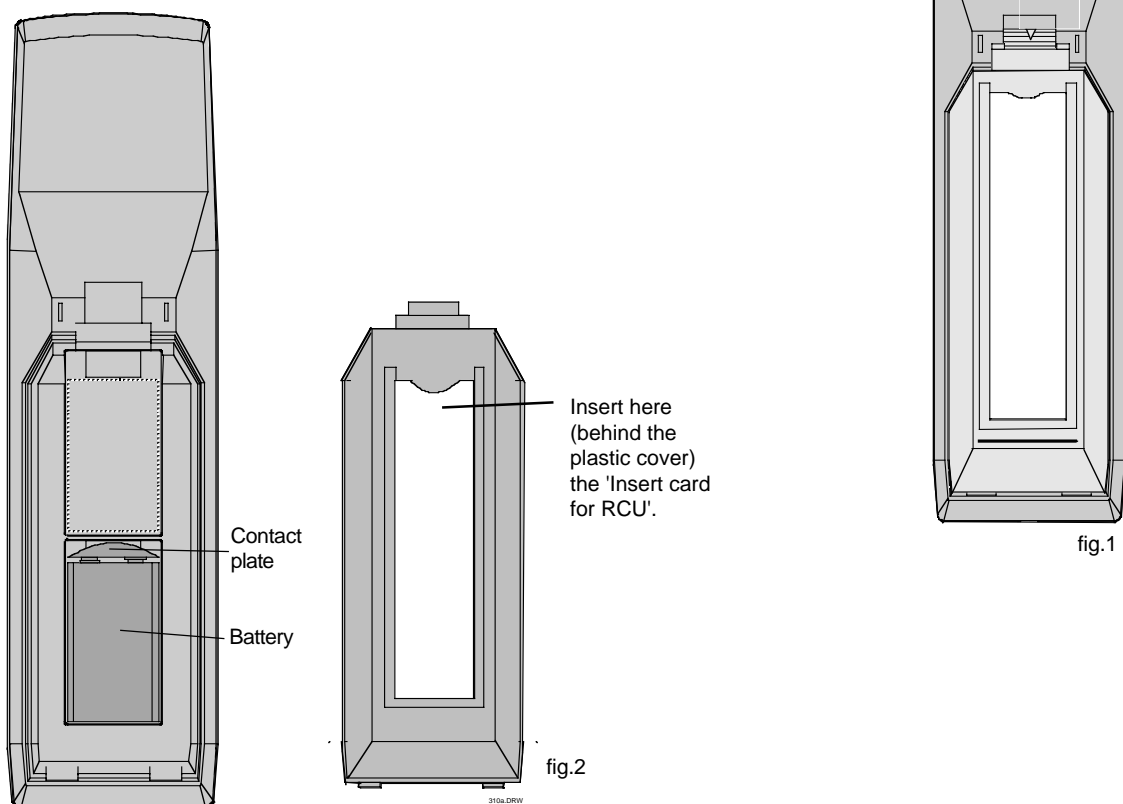

The Runco DTV-1101 can be controlled with  
a. the RCU  
b. the built-in RCU (local keypad)

The procedure and results of controlling the projector with either of these RCU options is essentially the same.

### How to Use Your RCU

- a) Point the front of the RCU towards the reflective screen surface.
- b) Point the front of the RCU towards one of the IR sensors in the projector.

When using the wireless remote control, make sure you are within the effective operating distance (30m, 100ft in a straight line). The remote control unit will not function properly if strong light strikes the sensor window or if there are obstacles between the remote control unit and the projector's IR sensor.

IR Receiver Locations on the Projector:

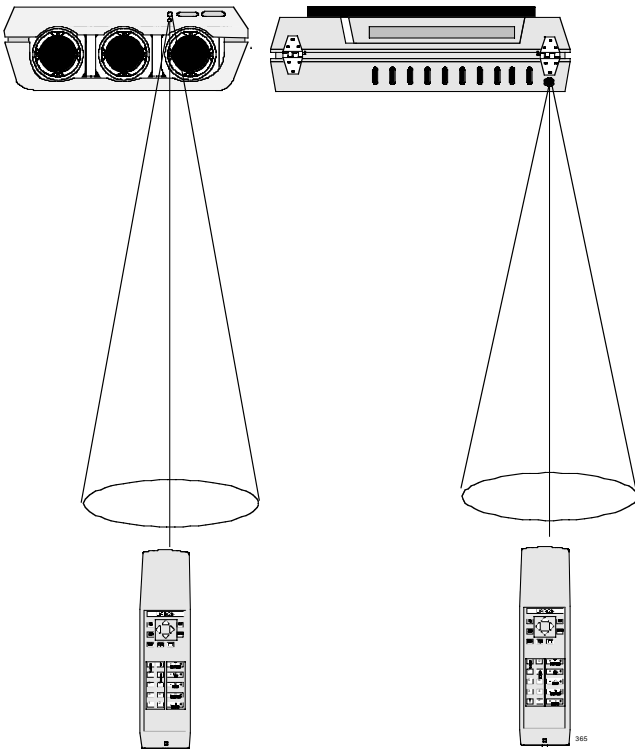

### Projector Address

#### a. Software set up of the projector address

See 'Change Projector Address' in Chapter 2, 'Service Mode'. Every projector requires an individual address between 0 and 255, which is set in the Service mode. Only projectors with addresses between 0 and 9 can be controlled with the RCU.

#### b. How to control the projector

The projector's address may be set to any value between 0 and 255. When the address is set, the projector can be controlled with:

- the RCU for addresses between 1 and 9.
- computer, e.g. IBM PC (or compatible), Apple MAC, etc. for addresses between 0 and 255.

Note: Address '0' is a universal address. A projector will respond to an RCU set to an address of '0' regardless of what address is set in the projector itself.

#### c. Using Your RCU

Before using your RCU, it is necessary to enter the projector address into the RCU (only when that address is between 1 and 9). The projector with the corresponding address will listen to that specific RCU.

When address '0' (zero address) is programmed into the RCU, every projector - without exception - will listen to the commands given by this RCU.



## How to Display a Projector Address

Press the ADDRESS key (recessed key on the RCU) with a pencil. The projector's address will be displayed in a 'text box'. This text box will disappear after a few seconds.

To continue using your RCU, it is necessary to enter the same address with the digit buttons (address between 0 and 9). For example, if the Address Key displays projector address 003, then press the '3' digit button on the RCU to set the RCU's address to match the projector's address.

## How to Program an Address into the RCU

Press the ADDRESS key (recessed key on the RCU) with a pencil and enter the address with the digit buttons. This address can be any digit between 0 and 9.

When programming '0' (zero address), the RCU will control a projector regardless of the projector's address. This feature allows multiple projectors with different addresses to be controlled by a single RCU.

## Input Selection

To select an input (source), press **ADJ** on the remote control, then highlight **SOURCE SELECTION** and press enter. Then, highlight the desired source and press enter.

When a valid and available source is selected, there will be information displayed on the screen about that source (if 'Text' is on). This information includes:

- source number
- horizontal frequency
- vertical frequency

When the entry is a non-valid source number, a warning appears on the screen: *'input not available'*. When a valid source number is selected, the projector will display this source or it will wait until the source becomes available. A message *'source not available'* will be displayed for a short time.

## Analog Picture Controls

The analog picture controls can be adjusted with the RCU. The control keys are located on the lower right side of the key panel of the RCU and indicated with the name of the control and an icon.

When an analog picture control is pressed, a text box with bar scale and the function name of the control, e.g. 'brightness...' appears on the screen (only if 'TEXT' is on). The length of the bar scale indicates the current memorized setting for this source. The bar scale changes as the + or - buttons of the control are pressed.

### Brightness Control

A correct *'brightness'* setting is important for good image reproduction. Adjust the brightness with the + button and - button (RCU) until the darkest parts of the picture appear black.

A bar scale gives a visual indication on the screen of the current brightness setting while pressing on the above indicated keys. If the bar scale is not visible on the screen, press the 'TEXT' key once and retry the keys indicated above. The bar scale will increase when pressing on the + button (higher brightness) and will decrease when pressing on the - button (lower brightness).

### Contrast Control

A correct *'contrast'* setting is important for good image reproduction. Adjust the contrast to the level you prefer, according to room lighting conditions. If the Contrast Control is too low, the picture will be too dim. If it is set too high, the picture may be too bright and not sharp.

A bar scale gives a visual indication on the screen of the current contrast setting while pressing the + or - buttons (RCU). If the bar scale is not visible on the screen, press the 'TEXT' key once and retry the keys indicated above. The bar scale will increase when pressing on the + button (higher contrast) and will decrease when pressing on the - button (lower contrast).

## Controlling Chained Projectors

Projectors can be controlled individually as well as in a group.

For individual control, see previous pages.

For group control of the projectors, see Input Selection and Analog Picture Control.

Program the 'zero address' into any RCU. Press on the address key and key in the address ('0') with the numeric keys on the RCU itself. Once address '0' is pressed, all projectors will be controlled together until a new address is entered on the RCU. It is possible to have a common input selection and a common analog picture control. Once a new address is entered, only the projector with that specific address will follow the new instructions.

## 5

## START UP OF THE ADJUSTMENT MODE

## Adjustment Mode

All picture geometry and convergence adjustments are made while in the '*Adjustment Mode*'. Press the ADJUST key to enter the '*Adjustment Mode*'.

You are now in the '*Adjustment mode*'. The **Control disk** is used to make menu selections and also vertical and horizontal adjustments. The **ENTER** and **EXIT** keys are used to move forward and backward through the menu structure. The **ADJUST** key can be used to terminate the adjustment mode while any path selection menu is displayed.

When an adjustment menu is displayed on the screen and no action is taken within the first 5 minutes, the projector will automatically reduce the brightness and contrast to a level so that the stationary image cannot damage the tubes.

There are 6 possible paths to follow once in the '*Adjustment Mode*.' They are :

**SOURCE SELECTION** - Provides the selection of either RGB, Component, RGB Tri-level or Component Tri-level sources.

**INSTALLATION** - Installation should be selected if the projector has been relocated and/or a different screen size is desired. When selecting 'Installation', the user or operator will be warned to call a qualified technician to perform the installation procedure (see example of projected warning on the next page).

**GUIDED** - Guided should be selected if the user intends to perform a complete alignment of the projected image. All of the necessary geometry and convergence adjustments are made in a predetermined sequence.

**RANDOM ACCESS** - Random Access should be selected if the user intends to make only a few adjustments.

**SERVICE** - Service should be selected if the user intends to delete blocks, change password, select service adjustments, or get set-up information.

**EYE-Q** - This selection will access the EYE-Q menu.

While in Guided or Random Access Adjustment Modes, the user may use an external source, an internally generated genlocked pattern, or an internally generated multifrequency cross hatch pattern as a setup pattern.

## Warning during the start up of the installation mode

Some items in the Adjustment Mode are password protected. While selecting such an item, the projector asks you to enter your password. (Password protection is only available when the password DIP switch on the controller module is in the ON position. Contact a Runco authorized technician when no password is requested during the adjustment procedure and password protection is desired.) Your password contains 4 digits.

Enter the digits with the numeric keys on the RCU.

Example: 2 3 1 9

For each digit entered, a 'X' will appear on the screen under the displayed text '*enter password*'. When your password is correct, you will have access to the 'Adjustment item'. When the entered password is wrong, the message '*Wrong password !!!*' will be displayed. The projector will stay on the previously selected item.

Factory programmed password:

**0000**

Once the password is correctly entered, all other password protected items are accessible without re-entering your password. When re-entering the Adjustment Mode, it will be necessary to enter your password again when selecting a password protected item.



# 6

## RANDOM ACCESS ADJUSTMENT MODE

### Starting Up the Random Access Adjustment Mode

Push the control disk up or down to highlight "RANDOM ACCESS" and then press **ENTER**.

Some items in the Random Access Mode are password protected (when the password function is enabled). Enter your password to continue. All other password protected items are now also available if you stay in the Adjustment Mode.

**ENTER** continues to Setup Pattern Selection  
**EXIT** returns to Operational Mode

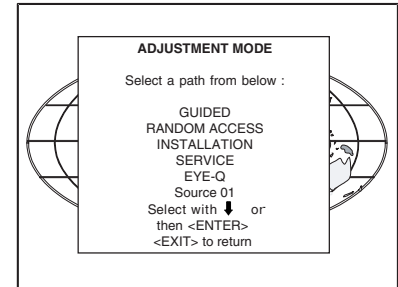
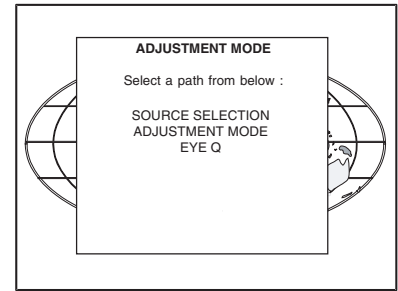

### Overview 'Random Access Adjustment' Mode

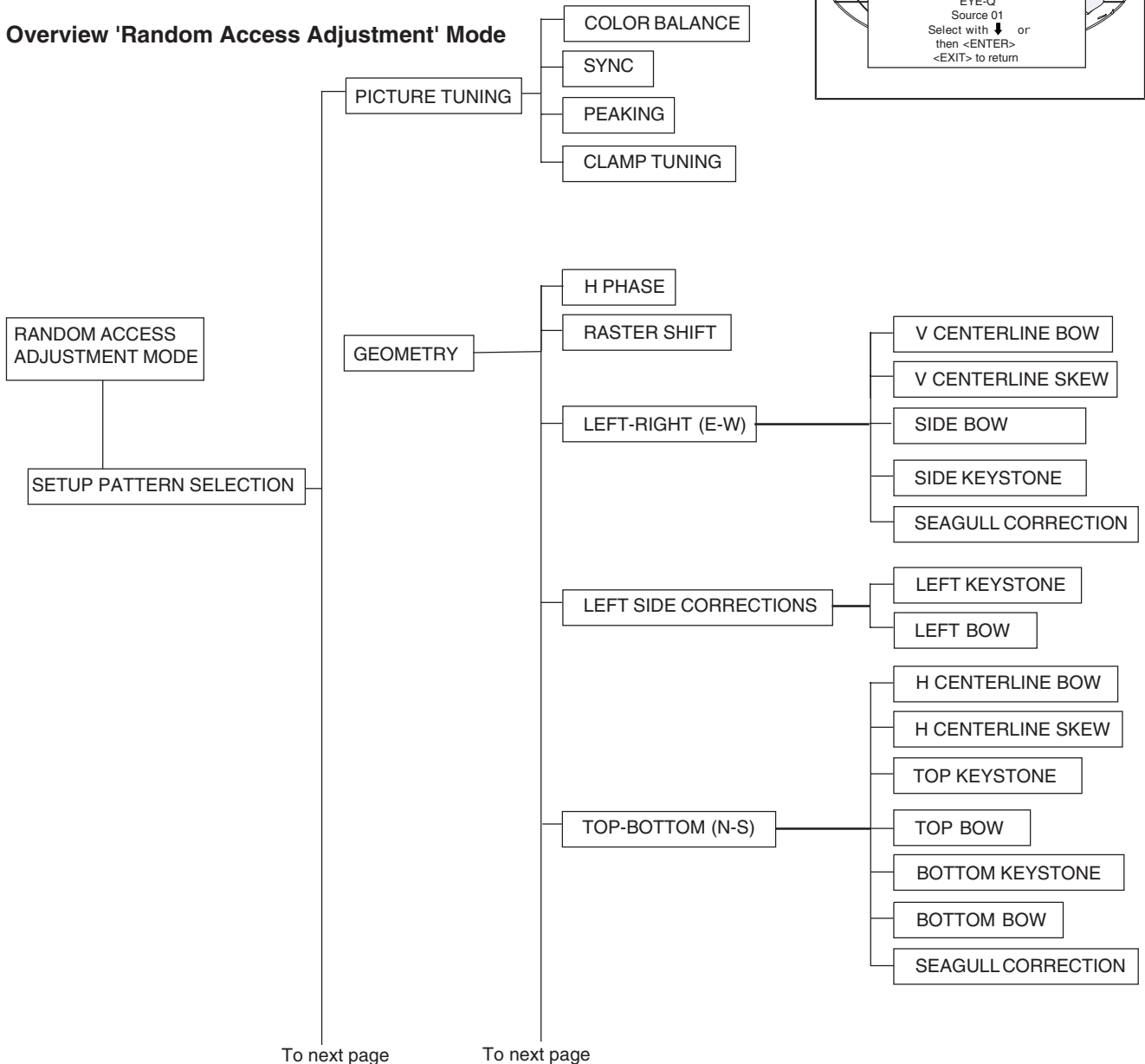

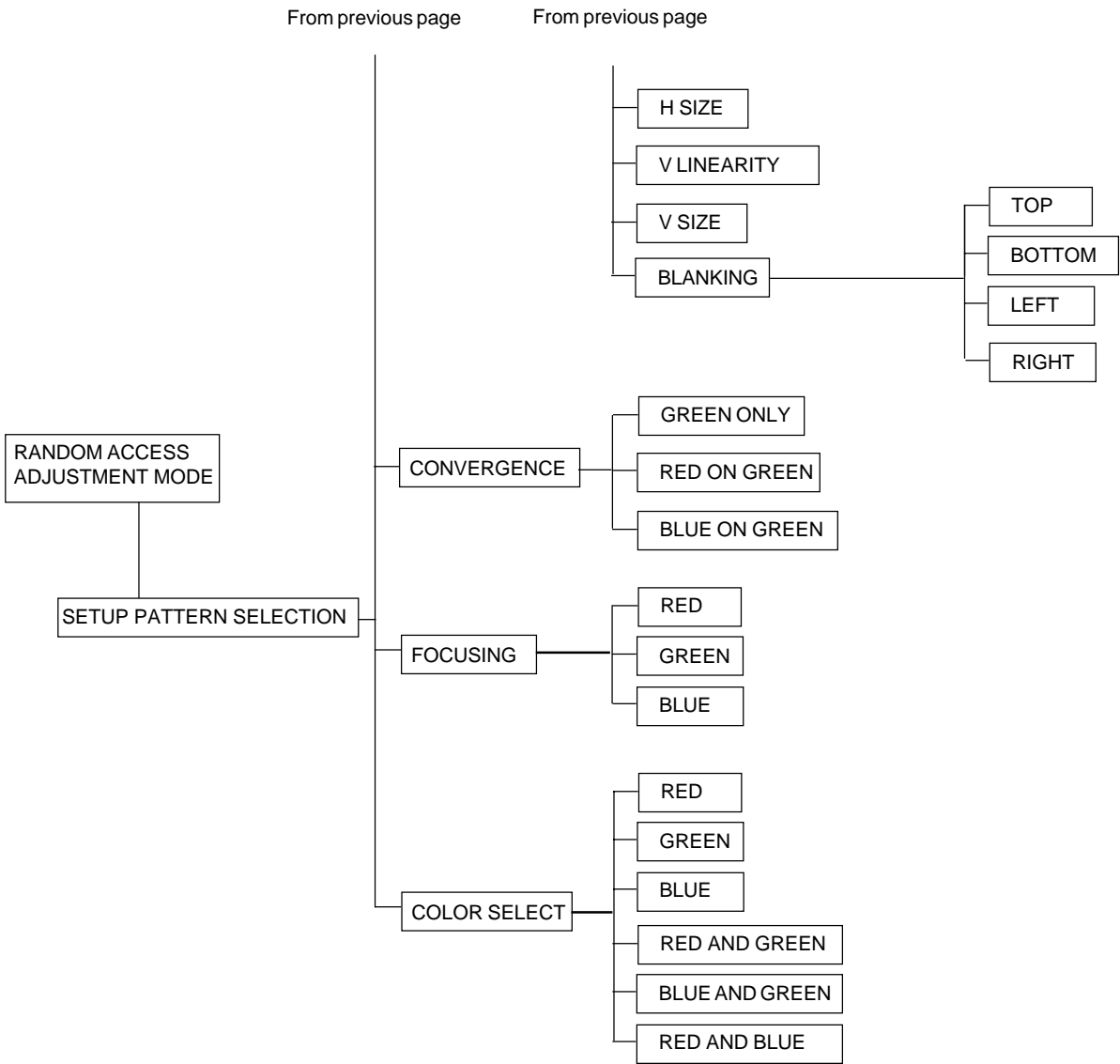

### Selecting Setup Pattern

If an external source is connected to the projector, this menu will be displayed. Push the control disk up or down to highlight the desired setup pattern and then press **ENTER**.

*Genlocked pattern: internally generated crosshatch pattern, based on the scan rate of the external source.*

*Internal # pattern: internally generated crosshatch pattern and locked on internal generated sync signals (no external source necessary).*  
**ENTER** continues to Random Access Adjustment Mode or Internal # Pattern Selection.

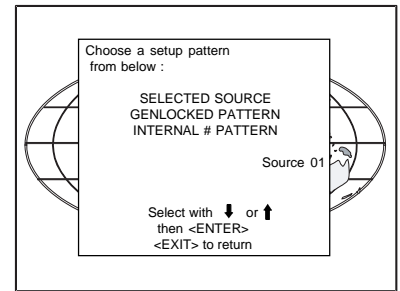

**EXIT** returns to Path Selection Menu  
**ADJUST** returns to Operational Mode  
 If no external source is connected to the projector, the Internal Crosshatch Pattern Menu will be displayed.

*Note: The menus in this manual are created to demonstrate when an external source is connected to one of the inputs and when the 'Genlocked Pattern' is selected.*

### Internal Crosshatch Pattern

The Internal # Pattern Menu will be displayed if the Internal Crosshatch Pattern has been selected or if no source is connected to the projector.

The table below lists the 8 fixed factory preset frequencies available. Another 8 blocks are custom programmable.

Push the control disk up or down to highlight the desired crosshatch frequency. Push the control disk to the left and to the right to scroll to another page. Press **ENTER** if the desired block is selected.

kHz/Hz	
15.6/50	PAL/SECAM
15.7/60	NTSC
31.2/50	EDTV
31.5/60	IDTV
31.2/50	HDTV EUREKA
31.5/60	HDTV ATV
33.7/60	HDTV HISION
15.8/60	EGA 1
61.0/76	VGA 1,2
35.5/87	VGA 4
48.5/60	SUPER VGA 1
44.2/70	SUPER VGA 2
61.0/76	SUPER VGA 3
72.1/67	SUPER VGA 4

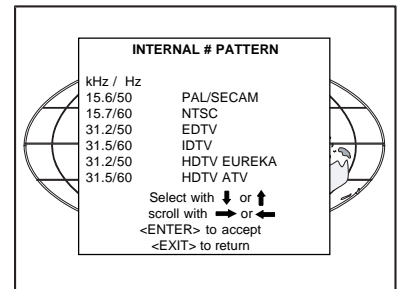

**ENTER** continues to the Random Access Adjustment Mode  
**EXIT** returns to the Setup Pattern Selection Menu

## Random Access Adjustment Mode Selection Menu

This is the main menu for the Random Access Adjustment Mode. Through this menu, the following adjustments and features are accessible:

- Picture Tuning
  - Sync Slow/Fast
  - Color Balance
- Focusing
- Geometry
- Convergence
- Color Select

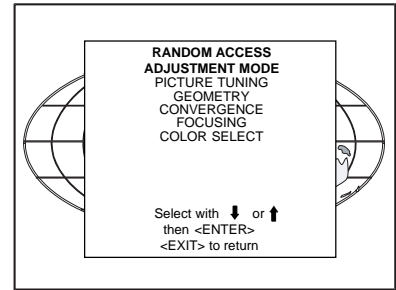

## Picture Tuning

Highlight *Picture Tuning* by pushing the control disk up or down and press **ENTER**. The Picture Tuning Menu will be displayed. Depending on the input source, the Picture Tuning Menu will display different items.

For RGB and Component sources:

- Color Balance
- Sync Slow/Fast
- Peaking
- Clamp Tuning

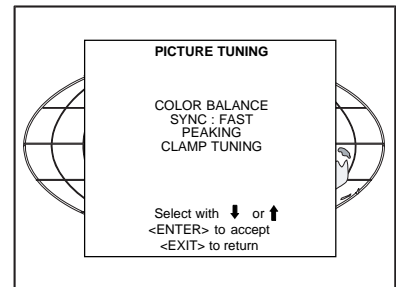

## Color Balance

The Color Balance function is used to select or adjust the color temperature of white used by the projector. The Color Balance can be adjusted in two different ways:

- Fixed color balance. You have the choice between 3200 K (reddish), 5400 K, 6500 K (white) or 9300 K (bluish).
- Custom white and black balance.

### Fixed Color Balance

Highlight one of the 4 preprogrammed color temperatures with the control disk and press **ENTER** to display the desired color balance.

### Custom Color Balance

Select Custom Red & Blue Gain with the control disk and press **ENTER** to start the adjustment. Push the control disk up or down to adjust the Red Gain and push the control disk to the left or to the right to adjust the Blue Gain. A bar scale indicates the amount of adjustment. Select custom Green Gain with the control disk and press **ENTER** to start the adjustment. Push the control disk up or down to adjust the Green Gain.

Select Custom Red & Blue Cut-off with the control disk and press enter to start the adjustment. Push the control disk up or down to adjust the Red Cut-off and push the control disk to the left or to the right to adjust the Blue Cut-off. Select custom Green Cut-off with the control disk and press enter to start the adjustment. Push the control disk up or down to adjust the Red Cut-off.

**EXIT** returns to the Picture Tuning Menu.

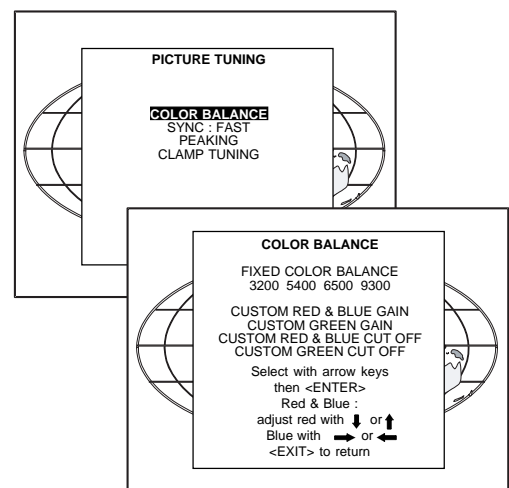



## Sync Fast/Slow Adjustment

The sync function is used to minimize horizontal jittering or tearing at the top to the displayed image. Highlight *SYNC* by pushing the control disk up or down and press **ENTER** to toggle between *FAST* and *SLOW*.

Note: *SYNC* is normally used in the *SLOW* position.

**ENTER** will toggle Sync between FAST and SLOW  
**EXIT** will return to the Random Access Adjustment Menu

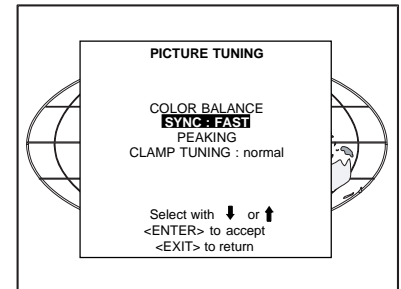

## Peaking

Peaking improves the contours in an projected image. Highlight

*PEAKING* by pushing the control disk up or down and press **ENTER** to display the Peaking Menu.

During the creation of new settings for a RGB source, the corresponding peaking is switched on as default. For frequencies between :

- 15 kHz — 45 kHz: Low frequency peaking
- 45 kHz — 85 kHz: Mid frequency peaking
- 85 kHz — 135 kHz: High frequency peaking

If another peaking is desired, use the control disk to highlight 'low', 'mid', or 'high' frequency or to switch off the peaking.

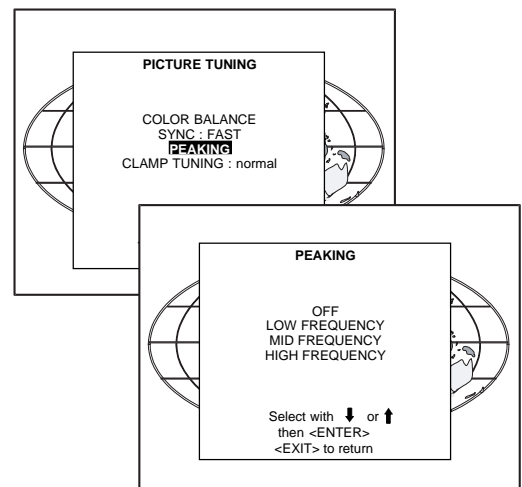

## Clamp Tuning

Highlight *CLAMP TUNING* by pushing the control disk up or down and press **ENTER** to toggle between *NORMAL* and *RESTORATION*.

Select Normal: - for all standard sources and all sources with a backporch > 0.8μs  
 - for sources with noise and spikes in the signal

Select Restoration:  
 - for standard sources with a backporch between 0.4 μs and 0.8 μs  
 - for sources with sync separate or sync on Green

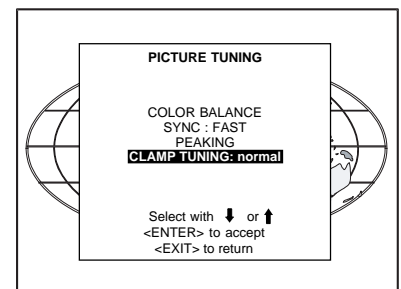

## Color Select

Highlight *COLOR SELECT* by pushing the control disk up or down and press **ENTER** to display the Color Select Menu.

**ENTER** continues to the Color Select Menu  
**EXIT** will return to Internal Crosshatch Selection or Setup Pattern Selection Menu  
**ADJUST** returns to Operational Mode

Use the control disk to highlight a color (CRT) or combination of colors to display the projected image in that specific color. To select a new color, press **ENTER**. The Color Selection Menu will appear again on the screen. To terminate the color select procedure, press **EXIT**.

**ENTER** continues with the selected color or color combination  
**EXIT** returns to the Random Access Main Menu

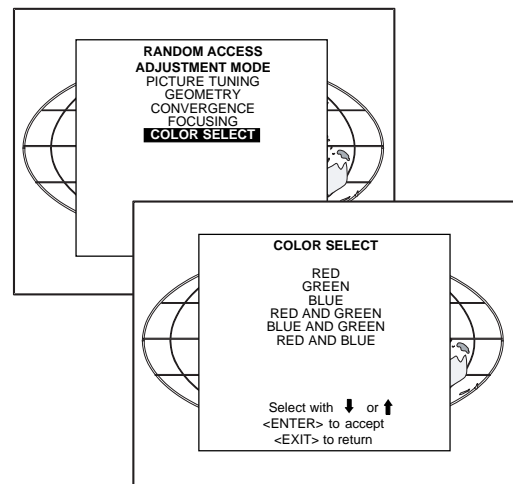

## Focusing

Before starting the focusing adjustment, be sure the lenses are correctly focused. Push the control disk up or down to select *FOCUSING* and press **ENTER**.

**ENTER** continues to the Focusing (Color Select) Menu.  
**EXIT** returns to Internal Crosshatch Selection or Setup Pattern Selection Menu.

**ADJUST** returns to Operational Mode.

### Focusing Color Select

The focusing has to be done for the three colors separately. Therefore, start by selecting Green by pushing the control disk up or down and adjust Midpoint, Top, Bottom, Left, and Right Focusing. Return to this Focusing (Color Select) Menu and continue with Red and Blue. Repeat for both colors Midpoint, Top, Bottom, Left, and Right focusing.

**ENTER** selects the Focusing Menu for the selected color.  
**EXIT** returns to the Random Access Main Menu.

### Midpoint Focusing

Push the control disk up or down to select midpoint and press **ENTER** continue with the midpoint focusing. Adjust by pushing the control disk to the left or to the right until the center of the image is sharp. Press **ENTER** to return to the Focusing Menu.

### Top Image Focusing

The same procedure has to be repeated as for the midpoint focusing. Push the control disk up or down and press **ENTER** to continue to the top focusing. Push the control disk to the left or to the right to adjust the top focusing. Adjust until the upper part of the image is sharp. **ENTER** to return to the Green Focusing Menu.

### Bottom Image Focusing

The same procedure has to be repeated as for the midpoint focusing. Push the control disk up or down to select bottom and press **ENTER** to continue to the bottom focusing. Push the control disk up or down to adjust the bottom focusing. Adjust until the lower part of the image is sharp. **ENTER** to return to the Green Focusing Menu.

### Left Image Focusing

The same procedure has to be repeated as for the midpoint focusing. Push the control disk up or down to select LEFT and press **ENTER** to continue to the left focusing. Push the control disk up or down to adjust the left focusing. Adjust until the left part of the image is sharp. **ENTER** to return to the Green Focusing Menu.

### Right Image Focusing

The same procedure has to be repeated as for the midpoint focusing. Push the control disk up or down to select RIGHT and press **ENTER** to continue to the right focusing. Push the control disk to the left or to the right to adjust the right focusing. Adjust until the right part of the image is sharp. **ENTER** to return to the Green Focusing Menu. When on the Green Focusing Menu, press **EXIT** to return to the Focusing (Color Select) Menu and continue with the other colors.

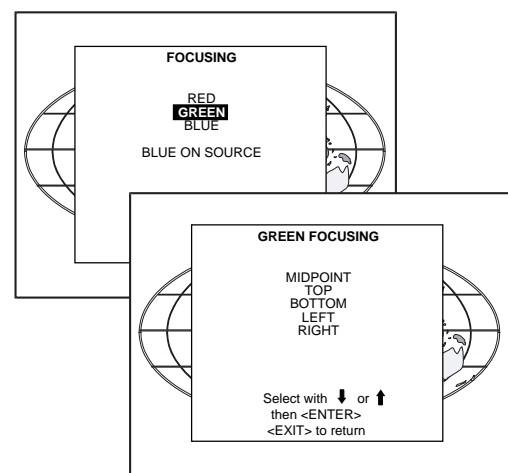
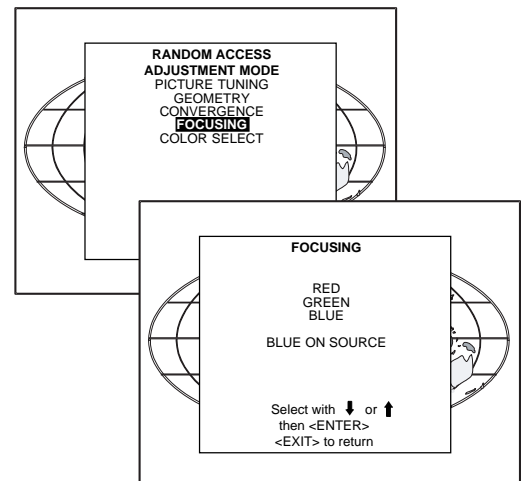

### Blue on Source

If after focusing the three colors a discoloring on a normal image is still visible, select *Blue On Source* on the Focusing Menu and repeat the above steps for Midpoint, Top, Bottom, Left, and Right focusing. Press **EXIT** to return to Focusing Menu.

## Geometry Adjustments

The geometry adjustments have to be done only on the green image. These adjustments are automatically implemented for the other color images: Left-right (EW) and Top-Bottom Corrections, Blanking, Horizontal Amplitude, Vertical Amplitude, Vertical Linearity, and Horizontal Phase.

Highlight *GEOMETRY* by pushing the control disk up or down and press **ENTER** to display the Geometry Menu.

**ENTER** will display Geometry Menu  
**EXIT** will return to Internal Crosshatch Selection or Setup Pattern Selection Menu  
**ADJUST** returns to Operational Mode

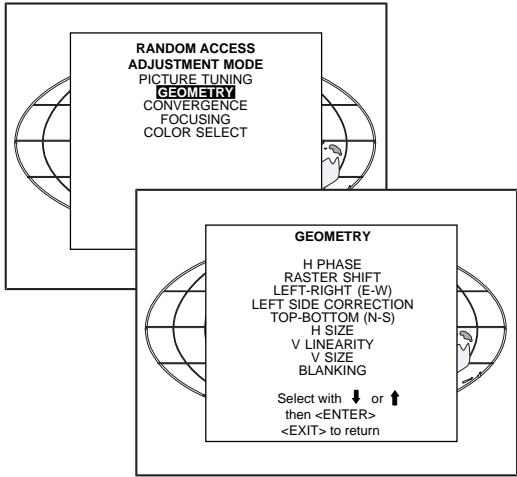

Within the Geometry Adjustment Menu, the following adjustments are available:

- Horizontal Phase (not for internal # pattern)
- Raster Shift
- Left-Right Corrections
- Left Side Corrections
- Top-Bottom Corrections
- Horizontal Size
- Vertical Linearity
- Vertical Size
- Blanking

The convergence corrections are disabled during geometry corrections. The blanking corrections are only enabled during the blanking adjustments.

### Horizontal Phase Adjustment

Push the control disk up or down to highlight *H PHASE* on the Geometry Menu and then press **ENTER**.

*Note: No horizontal phase adjustment is available on the internal # pattern.*

For external sources:

If the raster shift is correctly adjusted, the H Phase text box is projected in the middle of the raster. At that moment, the "><" icon indicates the middle of the raster. Adjust the H Phase control until the middle of the projected image is equal with the middle of the >< icon.

*Note:*

*- if the genlocked pattern was selected, the external source will be displayed.*

A bar scale and a number indicator (between 0 and 100) on the screen will give a visual indication of the horizontal phase adjustment.

**ENTER** continues to Geometry Menu

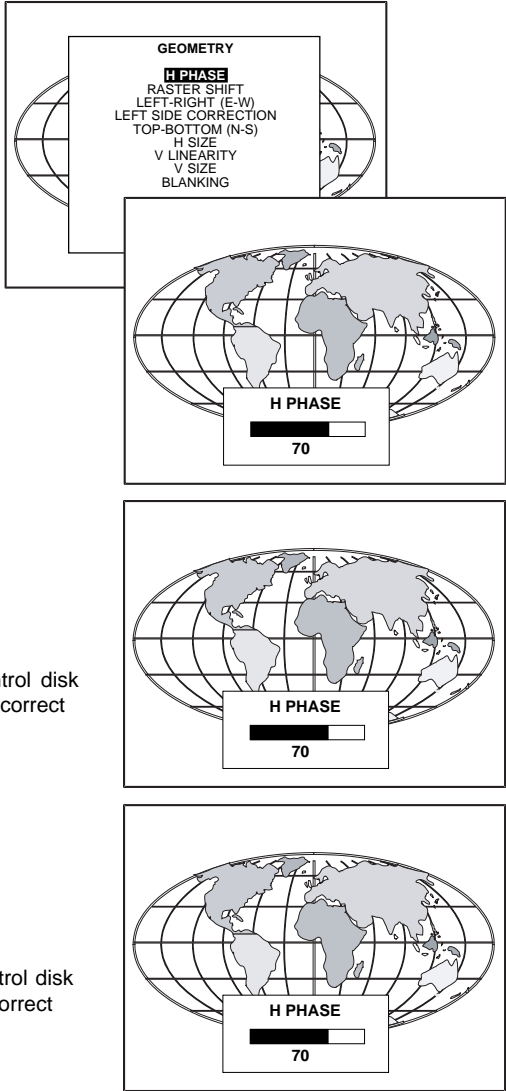

Push the control disk to the right to correct

Push the control disk to the left to correct

### Raster Shift Adjustment

The green raster must be centered both horizontally and vertically on the center of the CRT surface. To center the green raster, look into the green lens and use the control disk to move the raster.

**CAUTION:**

*It is necessary to look into the lenses to perform these adjustments. To avoid eye discomfort while looking into the lenses, reduce the contrast and gradually increase the brightness level until the raster becomes visible on the face of the CRT.*

**ENTER** will select Green Raster Shift Adjustment  
**EXIT** returns to Random Access Adjustment Mode Menu

**Warning:** In order to ensure maximum CRT longevity and to avoid CRT damage, do not shift the raster outside the phosphor area of the CRT.

To start the adjustment, use the control disk to highlight Raster Shift and press **ENTER** to display the green raster on the phosphor.

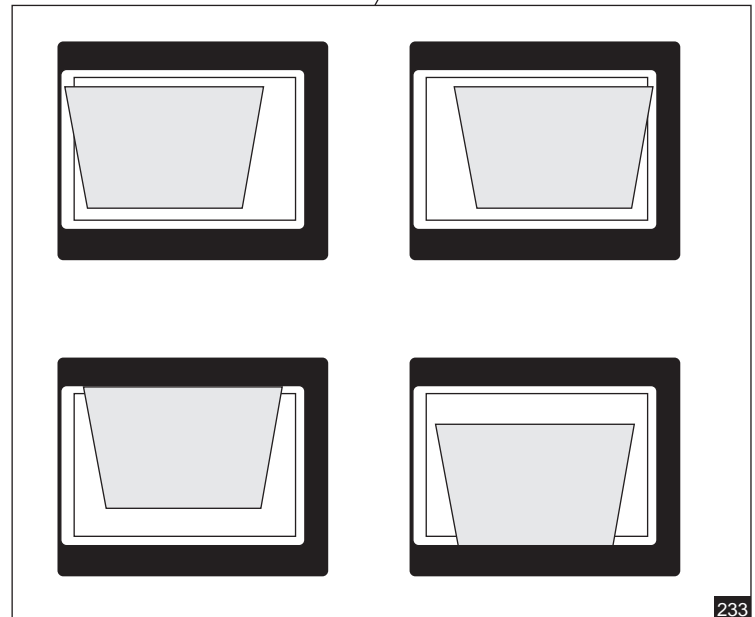
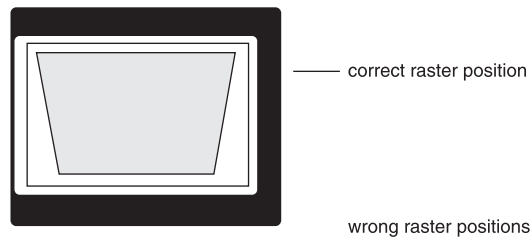
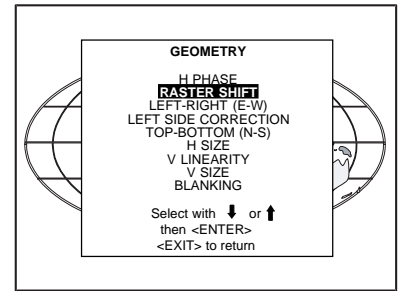

Press **EXIT** to return to the Geometry Menu.

*Note: Horizontal and Vertical shifts for Red and Blue should end up with a setting close to 50%. If these settings are significantly greater or lesser than 50%, then contact a Runco authorized service technician.*

### Left-Right (East-West) Adjustments

Left-right adjustments affect only the vertical lines of the projected image. Only the green image is displayed while making left-right adjustments. The red and blue images will automatically be corrected in the same manner. Convergence corrections are automatically disabled for the duration of these adjustments.

The following adjustments can be executed:

- Vertical Centerline Bow
- Vertical Centerline Skew
- Side Bow
- Side Keystone
- Seagull Correction

Push the control disk up or down to highlight *LEFT-RIGHT (E/W)* on the Geometry Menu and then press **ENTER**.

**ENTER** will select Left-Right Adjustment Menu  
**EXIT** returns to Random Access Adjustment Mode Main Menu.  
**ADJUST** returns to Operational Mode

The **WARNING**: "Use this correction to adjust the right side of the image" appears on the screen when selecting 'Side Bow' or 'Side Keystone'. When the right side is correctly adjusted, use 'Left Side Correction' to correct the left side of the image.

All adjustments are indicated on the screen with the function name, a bar scale and a number between 0 and 100. Adjust the next alignments until the vertical lines are straight. For side bow and side keystone, look only to the right side of the image. To enter an alignment, push the control disk up or down to highlight a function and press **ENTER** to activate this function. Press **EXIT** to return.

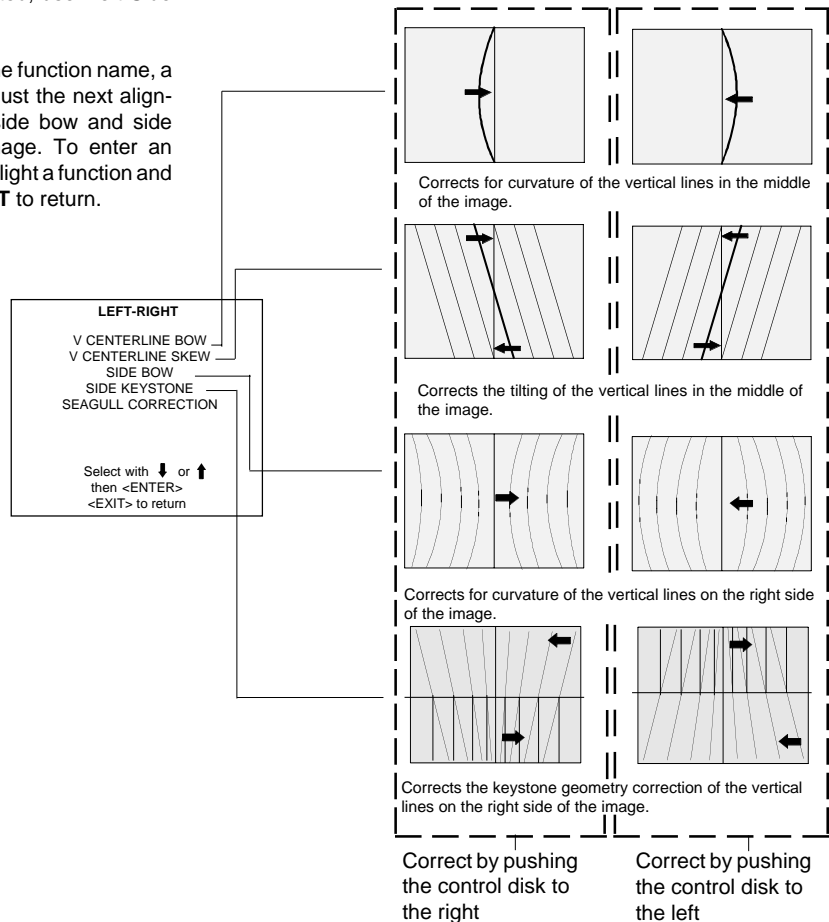
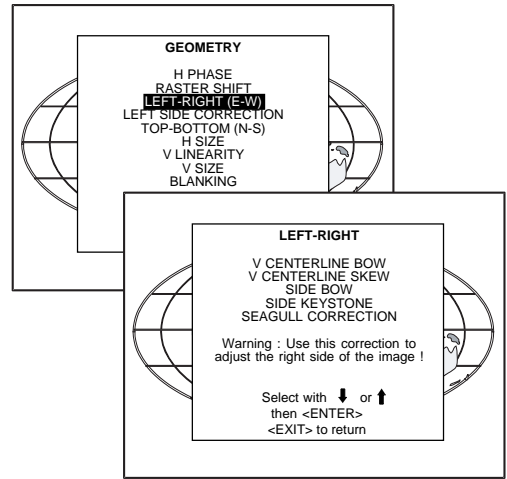

### Seagull Correction

Use this correction only if, after adjusting the vertical lines with the side bow or side keystone, an 'S' deformation is still visible on the left and the right side of the image. The default value on the bar scale for this correction is 50.

Push the control disk up or down to highlight *SEAGULL CORRECTION* on the Left-Right Menu and then press **ENTER**.

Eliminate the deformation by pushing the control disk to the left or to the right until a straight line is obtained.

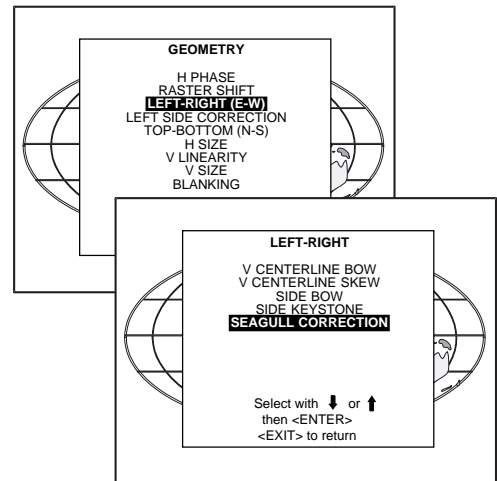

### Left Side Correction

Left side corrections affect only the vertical lines of the set up pattern. Only the green image is displayed while making the left side adjustments. The red and blue images will automatically be corrected in the same manner.

Convergence corrections are automatically disabled for the duration of these adjustments.

Look only to the left side of the image while adjusting these fine tunings (bow and keystone). **Before starting the left side correction, ensure that the side bow and keystone adjustments are done prior to these fine adjustments!**

The following adjustments can be executed:

- Left keystone
- Left bow

Push the control disk up or down to highlight *LEFT SIDE CORRECTION* on the Geometry Menu and then press **ENTER**.

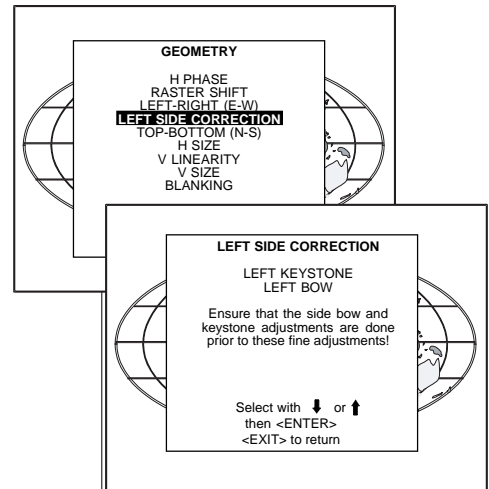

**ENTER** will select the Left Side Correction Menu.  
**EXIT** will return to the Random Access Adjustment Menu.  
**ADJUST** returns to Operational Mode.

All adjustments are indicated on the screen with the function name, a bar scale, and a number between 0 and 100. Adjust the next alignments until the vertical lines on the left side are straight.

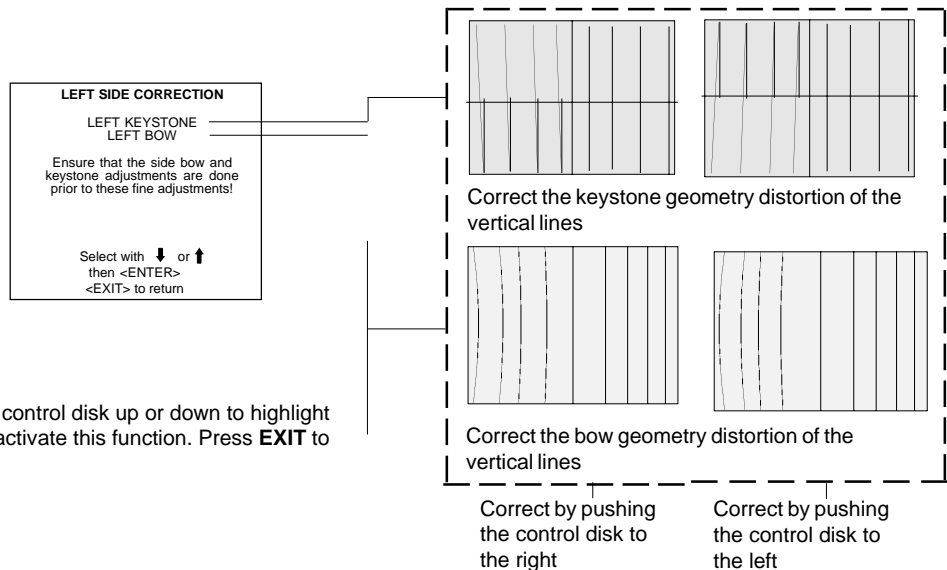

To enter an alignment, push the control disk up or down to highlight a function and press **ENTER** to activate this function. Press **EXIT** to return.

### Top-Bottom (North-South) Adjustments

Top-Bottom and center adjustments affect only the horizontal lines of the projected image. To start up the Top-Bottom and center corrections, follow the next procedure:

Push the control disc up or down to highlight *TOP-BOTTOM (N/S)* on the Geometry Menu and then press **ENTER**.

Only the green image is displayed while making top-bottom adjustments. The red and blue images will automatically be corrected in the same manner. Convergence corrections are automatically disabled for the duration of these adjustments.

The following adjustments can be executed:

- horizontal centerline bow
- horizontal centerline skew
- top bow
- top keystone
- bottom bow
- bottom keystone
- seagull correction

All adjustments are indicated on the screen with the function name, a bar scale, and a number between 0 and 100.

Adjust the next alignments until the vertical lines are straight. To enter an alignment, push the control disc up or down to highlight a function and press **ENTER** to activate this function. Press **EXIT** to return.

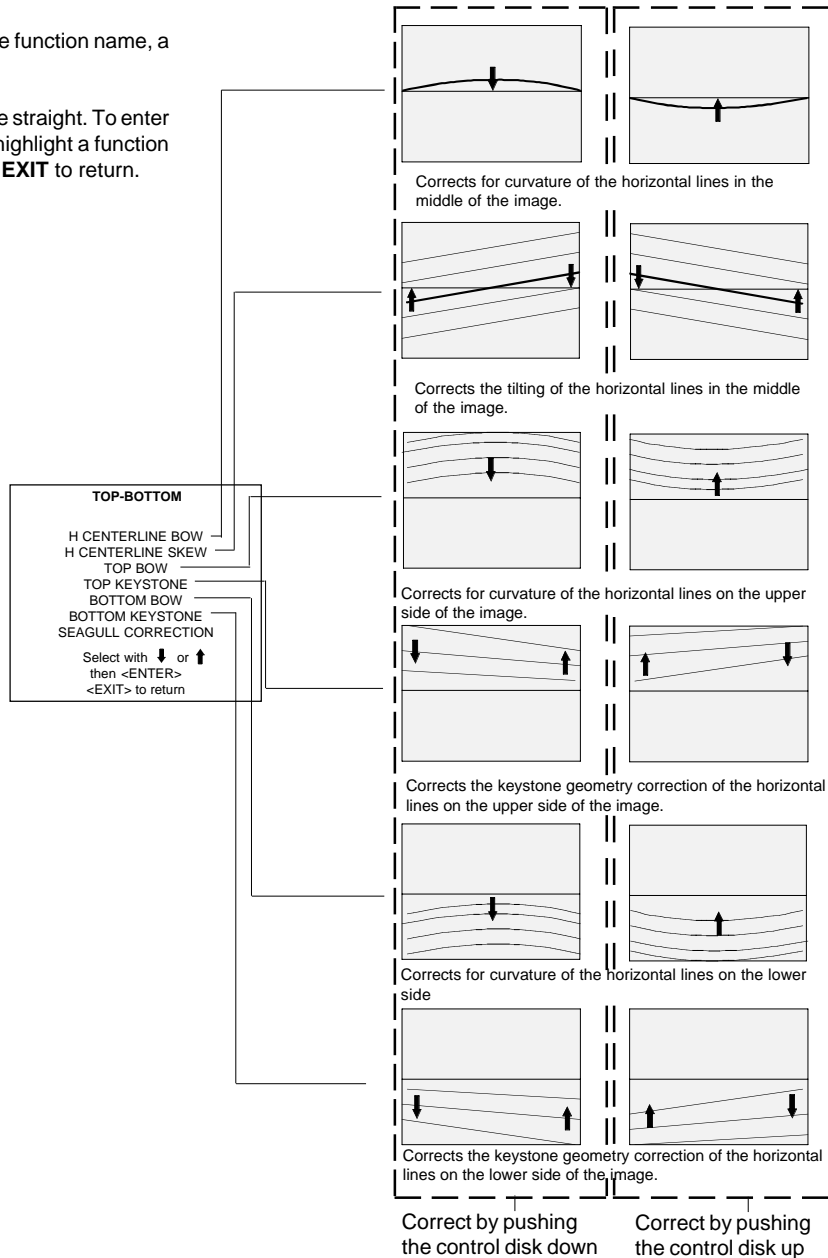
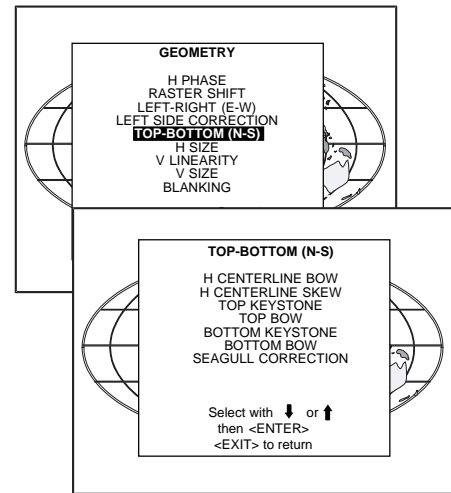



### Seagull Correction

Use this correction after the image has been adjusted with top and bottom bow and keystone. If a deformation is still visible (like a seagull) on top and bottom of the image, proceed to the seagull correction. Due to interaction, it is possible that the top and bottom bow will have to be readjusted after adjusting the seagull correction to obtain an improved image. The default value on the bar scale of this correction is 50.

Push the control disk up or down to select the 'Seagull Correction' and press **ENTER** to select. Eliminate the deformation by pushing the control disk upwards or downwards until a straight line is obtained. **ENTER** will return to Top-Bottom Adjustment Menu. **EXIT** will return to Geometry Menu.

### Horizontal Size Adjustment

Push the control disk up or down to highlight *H SIZE* on the Geometry Menu and then press **ENTER**.

**ENTER** will select horizontal size adjustment  
**EXIT** returns to Random Access Adjustment Mode Menu  
**ADJUST** returns to Operational Mode

Adjust the horizontal size by the control disk to the right or to the left until the exact image width is obtained.

**Note:**

- if the internal # pattern was selected, this pattern remains on the screen.
- if the genlocked pattern was selected, the external source will be displayed.

A bar scale and a numeric indicator help to gauge the horizontal size adjustment.

**EXIT** will return to the Geometry Menu.

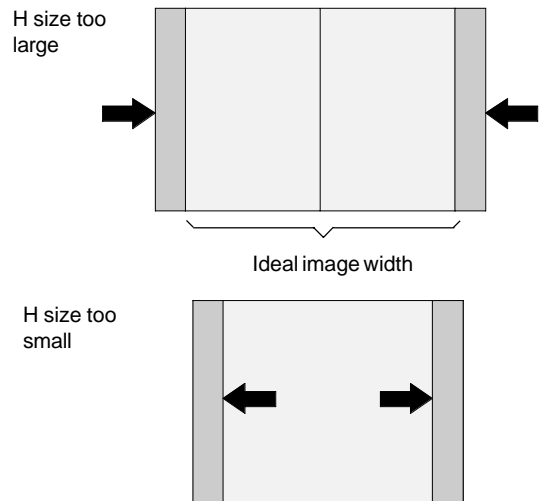
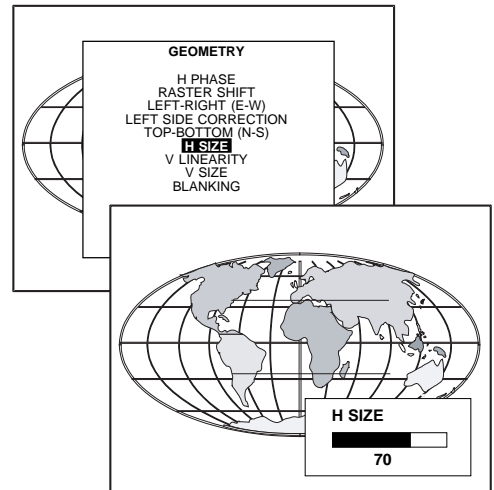
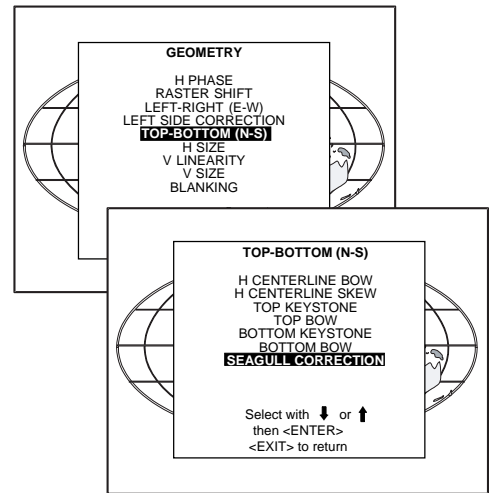

### Vertical Linearity Adjustment

The vertical linearity adjustment function corrects for vertical non-linearities that extend from the center of the image to the top and bottom of the image. Push the control disk up or down to highlight *V LINEARITY* on the Geometry Menu and then press **ENTER**.

**ENTER** will select Vertical Linearity Adjustment  
**EXIT** returns to Random Access Adjustment Mode Menu  
**ADJUST** returns to Operational Mode

Adjust the vertical linearity with the control disk until the distances between the horizontal lines of the set up pattern are equal from top to bottom.

**EXIT** will return to the Geometry Menu.

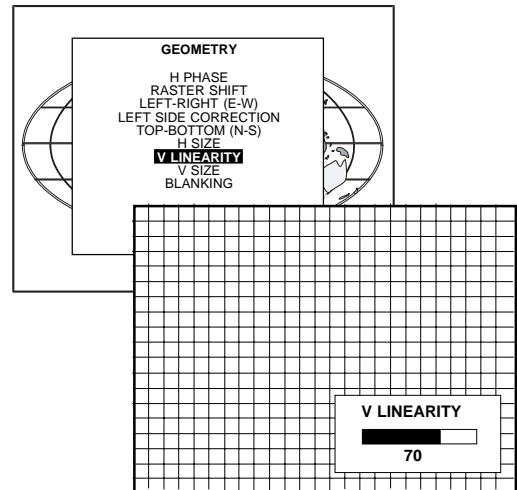

### Vertical Size Adjustment

Push the control disk up or down to highlight *V SIZE* on the Geometry Menu and then press **ENTER**.

**ENTER** will select Vertical Size Adjustment  
**EXIT** returns to Random Access Adjustment Mode Menu  
**ADJUST** returns to Operational Mode

Adjust the vertical size by pushing the control disk up or down until the correct image height is obtained.

Note :

- if the internal # pattern was selected, this pattern remains on the screen.
- if the genlocked pattern was selected, the external source will be displayed.

A bar scale and a numeric indicator will give a visual indication of the vertical size adjustment.

**EXIT** will return to the Geometry Menu.

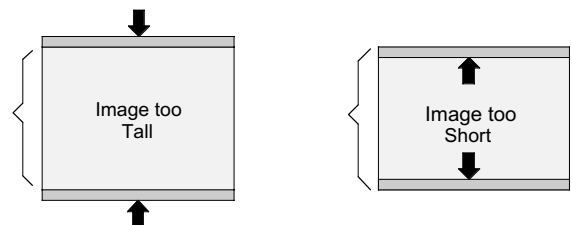
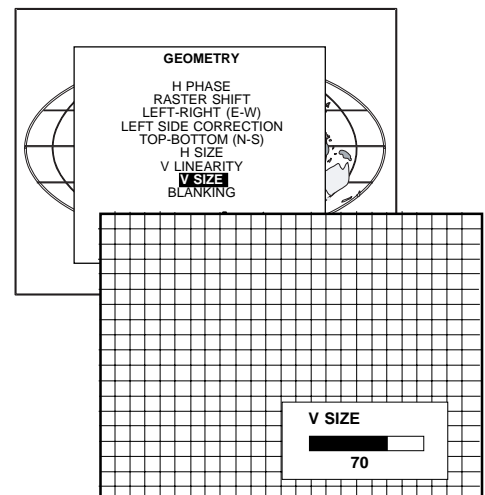

## Blanking Adjustments

Blanking adjustments affect only the edges of the projected image and are used to frame the projected image on to the screen and to hide or black out unwanted information (or noise). A 0% on the bar scale indicates no blanking.

To start up the Blanking adjustments, follow the next procedure:

Push the control disk up or down to highlight *BLANKING* on the Geometry Menu and then press **ENTER**.

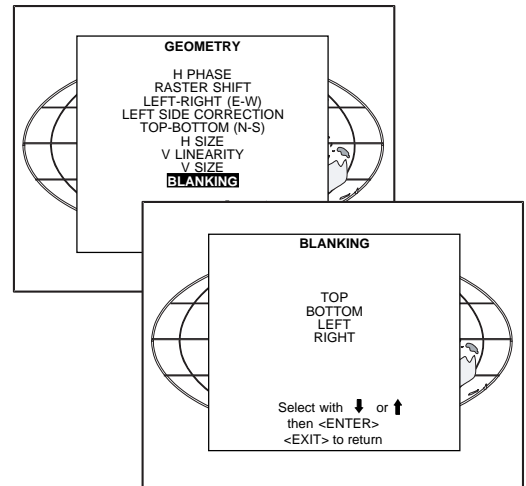

The following blanking corrections are possible:

- top blanking
- bottom blanking
- left blanking
- right blanking

Therefore:

- if the internal # pattern was selected, this pattern remains on the screen.
- if the genlocked pattern was selected, the external source will be displayed.

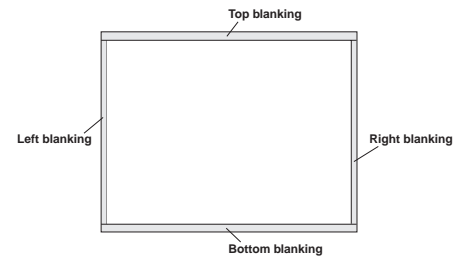

Adjust the next blanking alignments until the image is correctly framed or the unwanted information is blanked out. To enter a blanking alignment, push the control disk up or down to highlight a function and press **ENTER** to activate this function.

Press **EXIT** to return.

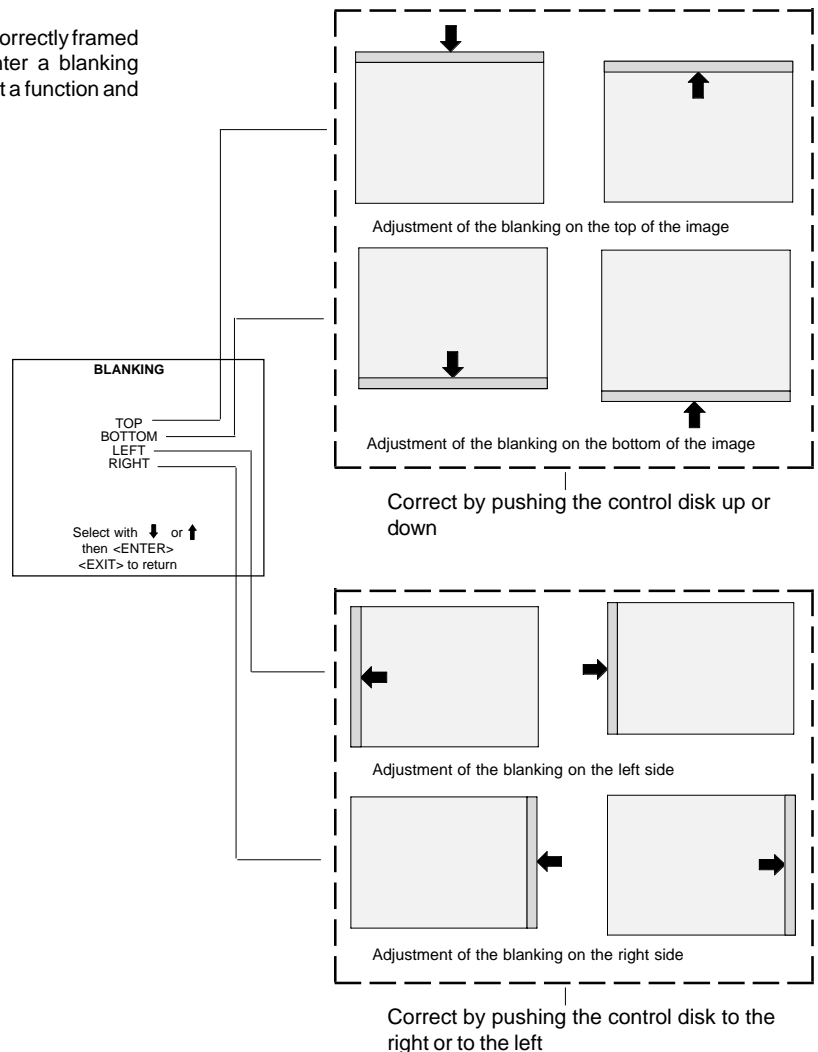

### Convergence Adjustment

Convergence adjustments affect both the horizontal and vertical lines of the setup pattern. These adjustments are performed on the red image while superimposed on the green image and then on the blue image while superimposed on the green image. Start with the Coarse Convergence Adjustments and finalise with the Fine Convergence Adjustments.

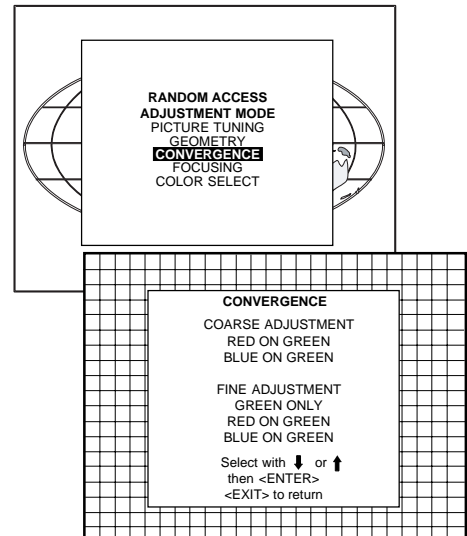

The screen area is divided into 25 areas.

25	23	9	15	17
24	22	8	14	16
5	4	1	2	3
20	18	6	10	12
21	19	7	11	13

### Coarse Convergence Adjustment

Highlight 'Red on Green' under the Coarse Convergence item and press **ENTER**. The Coarse Convergence menu will be displayed.

The following items are possible:

- Horizontal sides: adjust the vertical lines, within a certain area, on both sides without influencing the lines on the middle of the image.
  - Vertical corners: adjust the horizontal lines in the four corners, within a certain area, without influencing the middle of the image.
- Repeat for 'Blue on Green.'

#### Horizontal Sides

To make a coarse adjustment of the red or blue vertical lines in zone 3 and 5 simultaneously, highlight 'Horizontal lines' and press **ENTER** to start the adjustment.

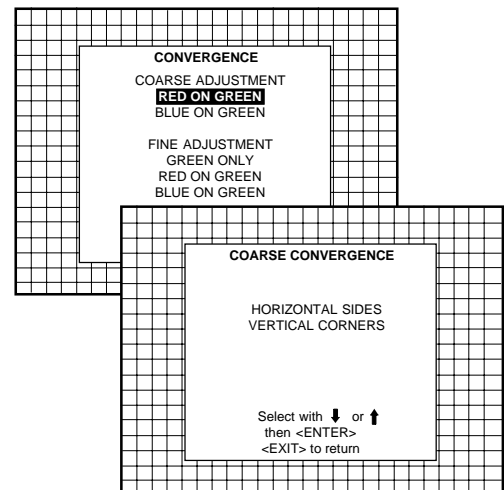

Hint :

- look to the end of scan and adjust until the red or the blue vertical lines are on the green lines or as close as possible to the green lines.
- during these adjustments, the horizontal convergence adjustments in zones 2, 3, 4, and 5 will be set to midposition (barscale 50).

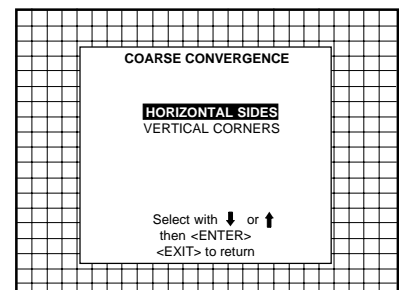

Vertical Corners

To make a coarse adjustment of the red or blue horizontal lines in zone 10, 14, 18, and 22 simultaneously, highlight 'Vertical Corners' and press **ENTER** to start the adjustment.

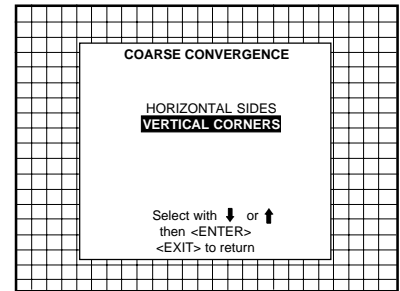
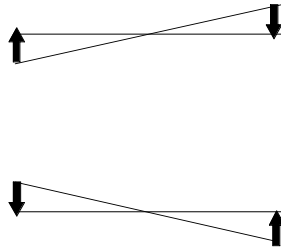

Hint :

- Adjust until the red or the blue horizontal lines are on the green lines or as close as possible to the green lines.
- During these adjustments, the horizontal convergence adjustments in zones 10 to 25 will be set to midposition (barscale 50).

Fine Convergence Adjustment

Use these controls after the Coarse Convergence Adjustments to optimize the convergence of the red and blue image on the green image.

Use the control disk to make horizontal or vertical convergence adjustments in the selected zone and then press **ENTER** to move the box to another zone or **EXIT** to return to the Convergence Menu. **ENTER** toggles arrow keys between zone selection and zone adjustment .

**EXIT** returns to Convergence Menu.

Highlight first 'Green Only' when available with the control disk and press **ENTER** to display the Convergence Adjustment Menu. Continue with red on green and blue on green.

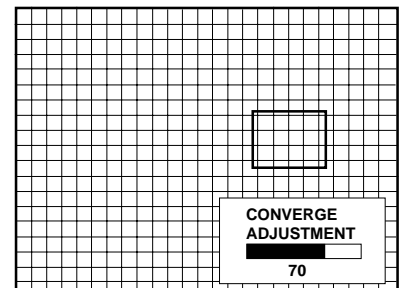
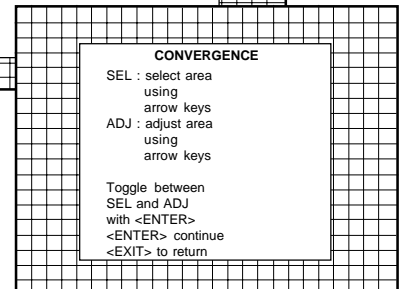
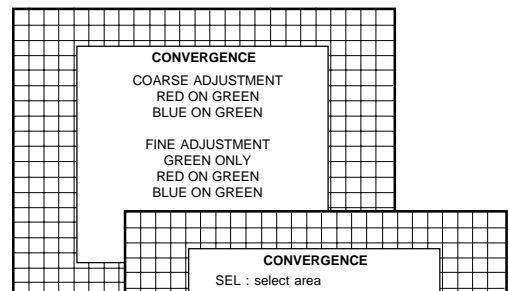



# 7

## SERVICE MODE

### Starting up the Service Mode

Use the control disk to highlight 'Service' and then press **ENTER**.

Some items in the Service Mode are password protected (when the password function is active). Enter your password to continue. All other password protected items will now also be available if you stay in the Adjustment Mode.

**ENTER** continues to the Service Mode Main Menu.  
**EXIT** returns to the Operational Mode.

The service items are combined in two service menus. To switch from the first to the second menu or vice versa, push the control disk up or down to select 'More...'

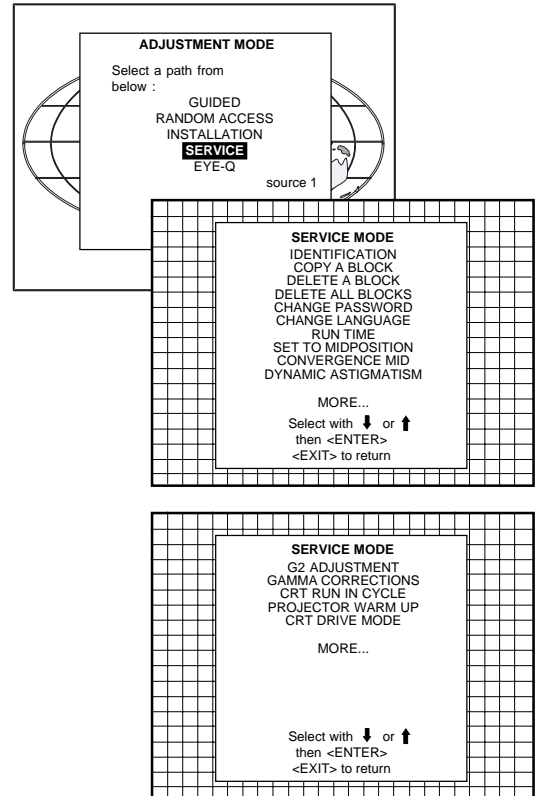

### Overview Flowchart 'Service' Mode

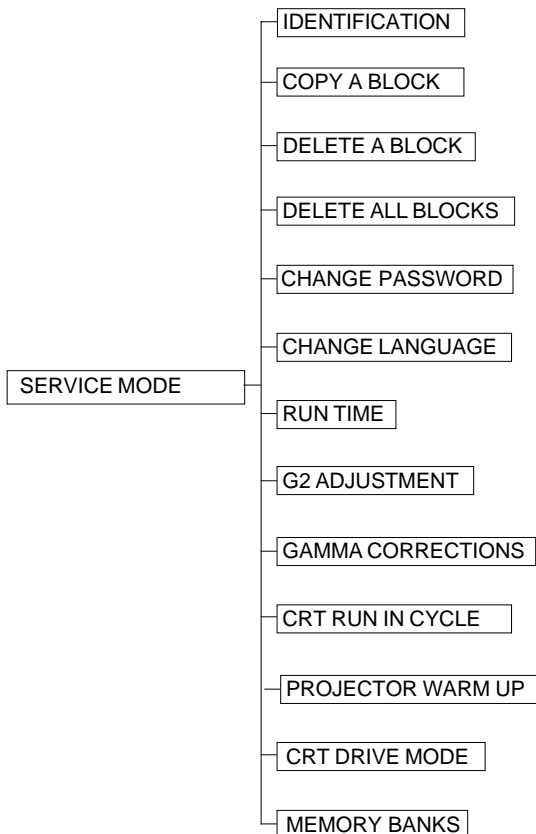

## Identification

Highlight 'Identification' with the control disk and press **ENTER**.

The 'Identification' screen gives information concerning:

- projector address, to change the address of your projector, contact a qualified service technician.
- software version
- configuration
  - possible installations:
    - \* front-ceiling
    - \* front-table
    - \* rear-ceiling
    - \* rear-table
- baud rate PC: transfer speed for communication with an IBM PC (or compatible) or MAC. The baud rate of the projector must be the same as the baud rate of the connected computer. When there is a difference, contact a qualified service technician to make the appropriate changes.
- Text: indicates in operational mode if the bar scale and number indicator will be displayed and if warnings and failures will be displayed.

ON: displayed  
OFF: not displayed

The status can be changed by pressing the 'TEXT' key once on the RCU.

- Serial no.: indicates the fabrication number of the projector. This number can be useful when calling for technical assistance.

## Copy a Block

The Copy A Block function copies the settings of a selected block into the active block. Highlight *Copy A Block* with the control disk and press **ENTER**. **ENTER** will select the highlighted item.

To copy the settings of a closed block to the block you are working on (active block), use the control disk to select a block. All existing settings will be overwritten with the new settings.

Press **ENTER** to copy the selected block. A confirmation screen will be displayed.

If you are certain you wish to copy the contents of the selected block into the active block, press **ENTER**. **EXIT** cancels the copy procedure and returns without copying the block.

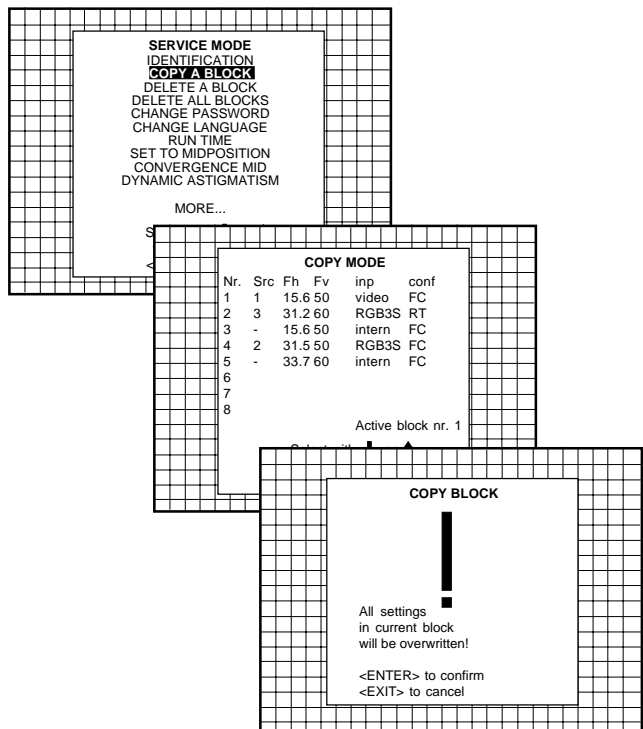
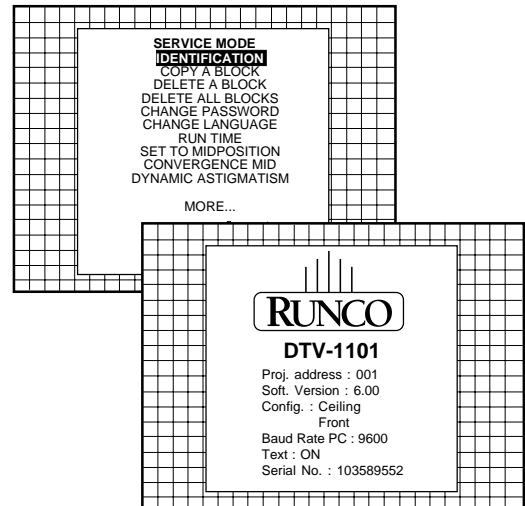



## Deletion of Blocks

This item is password protected.

The delete function is used to clear all data (settings) from an adjustment block.

A delete can be given:

- block by block
- or
- for all blocks

### Deleting Block by Block

The delete a block function deletes the settings of a selected block. Highlight 'Delete A Block' with the control disk and press **ENTER**.

Push the control disk up or down to select the desired adjustment block. Press **ENTER** to delete the selected adjustment block. A confirmation menu will be displayed.

**ENTER** will delete the selected block. **EXIT** cancels the deletion procedure and returns to the Service Mode Main Menu.

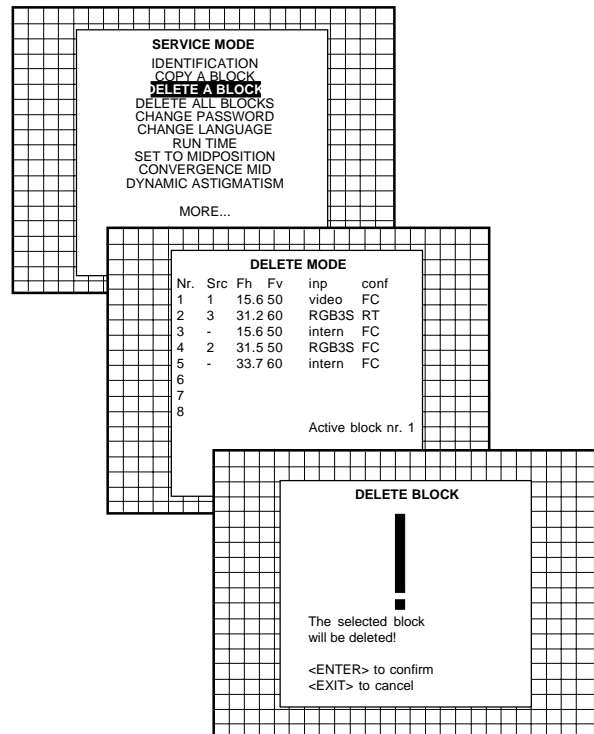

### Deletion of all Blocks

Highlight 'Delete All Blocks' with the control disk and press **ENTER**. **ENTER** gives a confirmation message before deleting.

If you are certain you wish to delete all blocks, press **ENTER** to confirm. Otherwise, press **EXIT** to return. Once **ENTER** is pressed, all block headers and adjustment settings are permanently removed and cannot be restored.

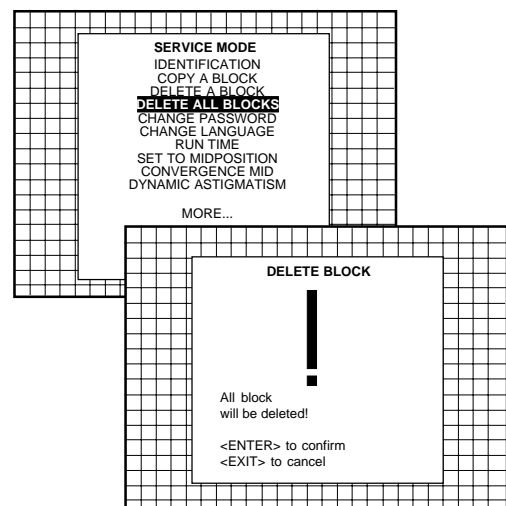

### Change Password

This item is password protected. Highlight 'Change Password' with the control disk and press **ENTER**.

The current password is displayed. The new password must consist of 4 digits between 0 and 9. Push the control disk to the left or to the right to select the digits to be changed. Use the numeric keys to enter the new digits.

Press **ENTER** to save the new password. Before saving the new password, a confirmation screen will be displayed. Press **EXIT** to return to the Service Menu without saving the new password.

When the displayed password is correct, press **ENTER** to save. If it is not correct, press **EXIT** to cancel the saving.

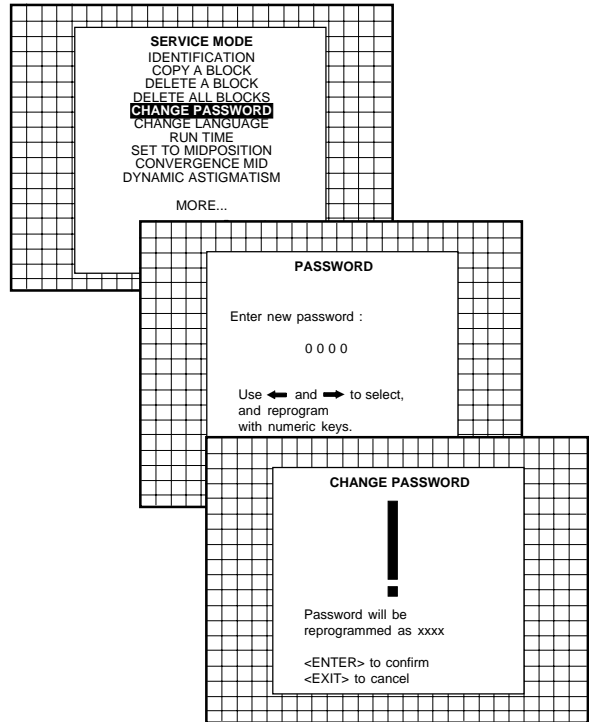

### Change Language

The 'Change Language' function offers the possibility to change the language of the screen menus to:

- English
- Spanish
- French
- German

Push the control disk up or down to highlight 'Change Language' and press **ENTER** to select the language menu. Push the control disk up or down to select the desired language and press **ENTER** to change the language.

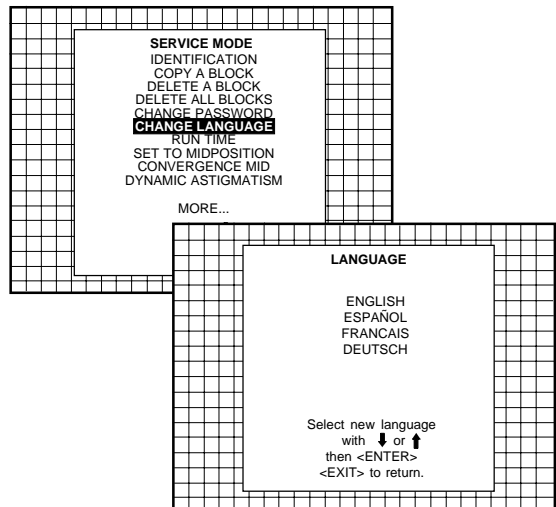

### Run Time

Highlight 'Run Time' with the control disk and press **ENTER** to display the amount of time the projector has played since its first start up at the factory.

*Note: all projectors leave the factory after a burn-in period of approximately 100 hours.*

Press **EXIT** to return the Service Mode Menu.

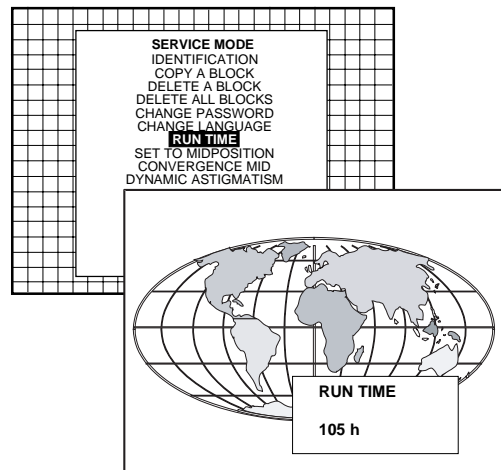

### Set to Midposition

This item is password protected. Highlight 'Set to Midposition' with the control disk and press **ENTER** to set all settings to their midposition. A confirmation menu will be displayed first.

**ENTER** will set all settings to their midposition. **EXIT** will cancel the operation to set all settings to their midposition.

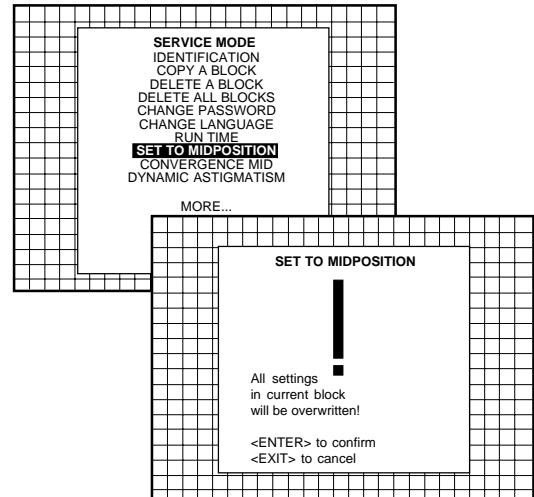

### Undo Midposition

When 'Set to Midposition' is selected, all settings are set to their midposition. To cancel this action, select 'Undo Midposition' by pushing the control disk up or down and press **ENTER**. 'Undo Midposition' is displayed in the Service Mode instead of 'Set to Midposition' when the latter is pressed.

An undo is possible as long as the projector is playing on the same source (= same adjustment block) even when some adjustments, such as geometry or convergence, are already readjusted. When undo is pressed, all settings are reset to the previous settings.

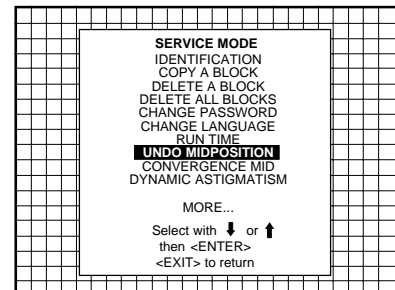

### Convergence Mid

This item is password protected. Highlight 'Convergence Mid' with the control disk and press **ENTER** to set all convergence settings to their midposition. A confirmation screen will be displayed first.

**ENTER** sets the convergence settings to their midposition. **EXIT** cancels the procedure to set the convergence settings to their midposition.

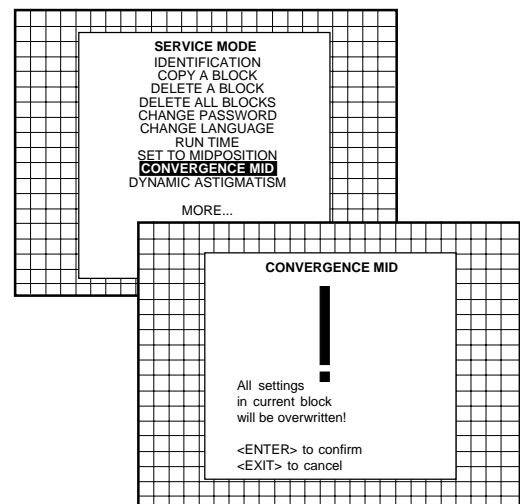

### Undo Convergence Mid (Position)

When 'Convergence Mid' is activated, all convergence settings are set to their midposition. To cancel this action, select 'Undo Convergence Mid' by pushing the control disk up or down and press **ENTER**. 'Undo Convergence Mid' is displayed in the service mode menu instead of 'Convergence Mid' when this latter is activated.

An 'undo' is possible:

- as long as the projector is operating on the same source (= same adjustment block) even when some convergence adjustments are already readjusted

AND

- 'Set to Midposition' is not yet selected.

When undo is pressed, all convergence settings are reset to the previous settings.

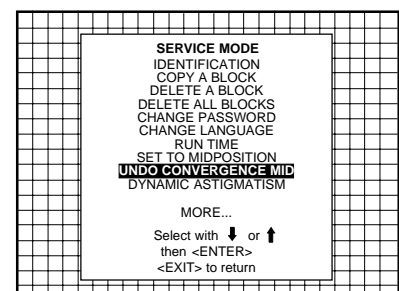

## Dynamic Astigmatism (Spot Shape Adjustment)

The spot shape adjustments correct the spot shape in 8 different areas on the screen and for the three colors separately. The spot shape is adjusted according to the axial axes and the diagonal axes when using the arrow keys on the RCU.

These adjustments have to be done on a dot pattern (e.g. the internally generated pattern) with standard line frequency (15 kHz). The adjustment values are stored in the EEPROM and remain the same for all frequencies.

Follow this procedure:

Highlight 'Dynamic Astigmatism' by pushing the joy disk up or down and press **ENTER** to select. **EXIT** returns to the Path Selection Main Menu.

Select the source type (selected source or genlock pattern) by highlighting the color for which the spot shape has to be corrected and press **ENTER**. (e.g. when selecting RED under 'On Genlocked Pattern', the projector switches to a genlocked pattern.)

Press **ENTER** to continue adjustment. Increase the contrast level using the Contrast Control to near maximum. Using the "+" Sharpness Key, defocus the image until the dots are large and easily visible. Press **ENTER** to continue to SEL.

SEL: select the adjustment area on the screen where the spot shape has to be corrected. Use the arrow keys to select one of the 8 areas. Press **ENTER** to continue to ADJ.

ADJ: adjust the spot shape in the axial or diagonal direction when using the arrow keys for the selected area. Adjust until the spot shape is circular.

Use the up and down arrow keys for the diagonal astigmatism adjustment and the left and right arrow keys for the axial astigmatism adjustment. Press **ENTER** to continue selecting a new area. The adjustment direction (axial or diagonal) and adjustment value are given in a text box on the screen. When all areas are adjusted, press **EXIT** to return to the Service Main Menu.

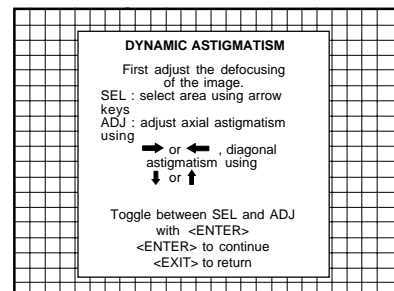
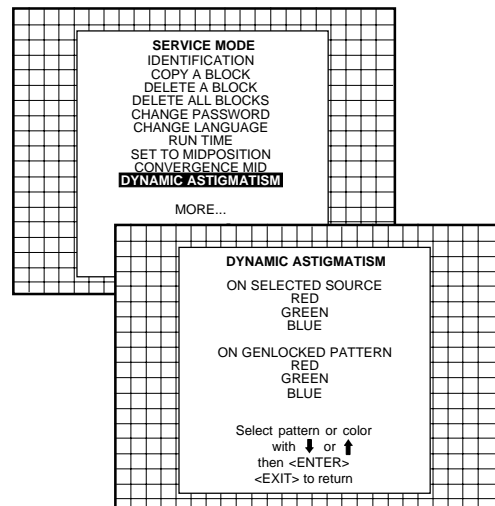
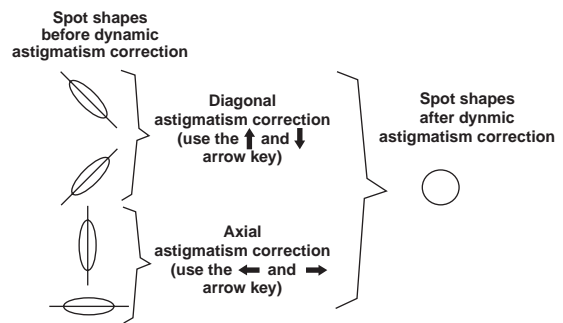
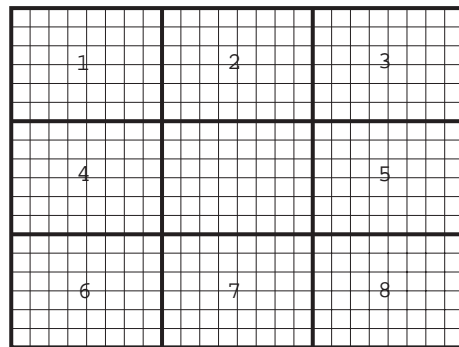

## G2 Adjust

This item is password protected. Highlight '*G2 Adjust*' with the control disk and press **ENTER** to continue. A safety notice will be displayed on the screen since it is necessary to open the top cover to adjust the G2.

**G2 adjustment should be performed by Runco personnel or Runco authorized dealers.**

If you are qualified, press **ENTER** to continue. If not qualified, press **EXIT** to return to the Service Mode Main Menu.

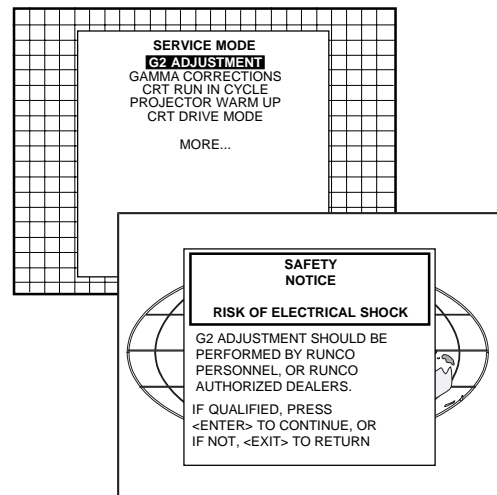

## Gamma Corrections

This item is password protected. Highlight '*Gamma Corrections*' with the control disk and press **ENTER** to continue. A warning will be displayed on the screen as there is a risk of incorrect adjustment of the projector.

If you are qualified, press **ENTER** to continue. If not qualified, press **EXIT** to return to the Service Mode Main Menu.

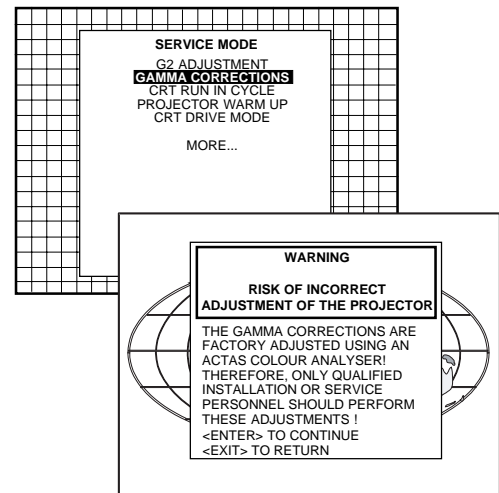

## CRT Run in Cycle

The CRT Run in Cycle option can only be activated when memory blocks on an internal # pattern are available. When one or more such blocks are available, a flashing white image (5 sec on, 5 sec off) will be generated or 5 minutes on the first internal block. In the next 5 minutes, a second internal block will be used to generate the flashing white image. The image will also be shifted in a vertical way to prevent a CRT burn in. To quit the CRT Run in Cycle option, press **EXIT**.

Highlight '*CRT Run in Cycle*' with the control disk and press **ENTER** to start.

If a memory block adjusted on an internal # pattern is available, the CRT Run in Cycle will start when pressing **ENTER**. If no such block is available, the projector cannot run the CRT Run In Option and leaves the Adjustment Mode.

If you still want to run CRT Run In Cycle, first create a memory block on an internal # pattern and restart the CRT Run In Option.

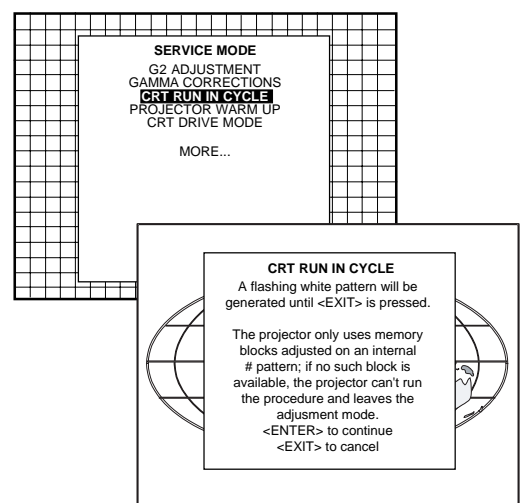

## Projector Warm-Up

Highlight 'Projector Warm-Up' by pushing the control disk up or down and press **ENTER** to select the Projector Warm-Up Menu.

The ON/OFF option can be toggled with the **ENTER** key.

When in the ON position (and the CRT Run in Cycle is OFF), the projector can start up with a warm-up period of 20 minutes. During the start up a warm-up menu will displayed. This menu offers the possibility to skip the warm-up period anyway by pressing the **EXIT** key and offers the possibility to adjust the horizontal and vertical amplitude of this white image with the control disk. During this warm-up period, a full white image is shifted on the CRT faceplate to avoid a burn in.

Every 30 seconds, a text box will be displayed on another place on the screen with the remaining time to go.

When **EXIT** is pressed during this warm-up period, the warm-up menu will be redisplayed with the remaining time indication. Press another time **EXIT** to interrupt the warm-up cycle.

When the warm-up option is OFF, when switching on the the projector, it starts immediately with the projection of the selected source.

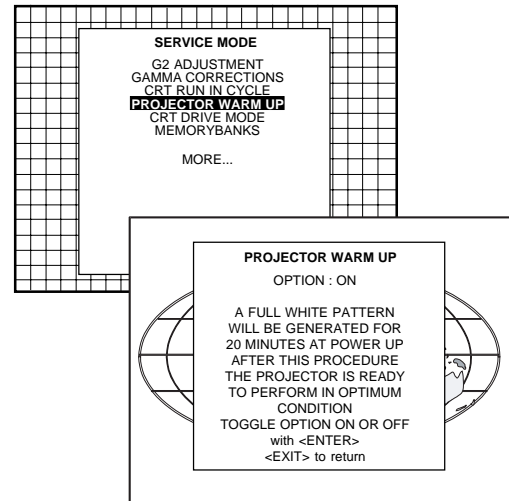

## CRT Drive Mode

The projector CRT's can be driven with the normal current (normal mode) or a lower current (economic mode).

To change the drive mode, highlight 'CRT Drive Mode' by pushing the control disk up or down and press **ENTER** to display the CRT Drive Mode Menu.

To change the boost mode, push the control disk up or down to select a display mode and press **ENTER** to select.

The following modes are available:

- normal
- economic: lower drive current to the CRTs. The lifetime of the CRTs will increase but the light output will reduce.

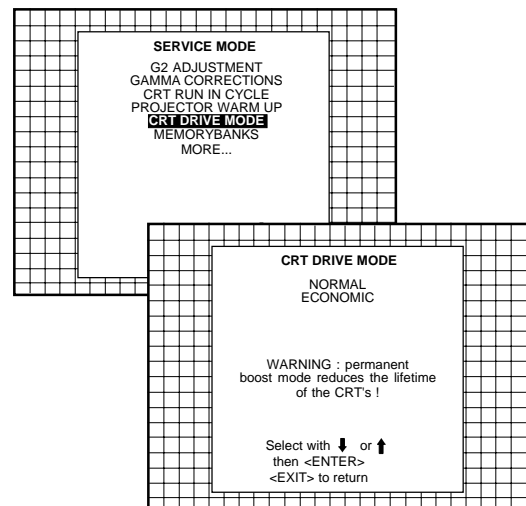

## Memory Banks

This function allows the creation of various aspect ratios while the horizontal scan rate stays the same.

If this feature is ON, then the unit will have the capability of having eight (8) separate aspect ratios within the same frequency (there are a total of 32 separate memories if all eight memory banks are used. For example, then a total of 4 frequencies can be input [4 freqs x 8 memory banks = 32]). To create different memories, clear all the menus from the screen (press "exit" until the screen is clear). Then, press "ENTER." A box will appear in the bottom right hand corner indicating in which memory bank the unit is (i.e., MEMORY BANK: 1.): Next, press a number (1—8) representing to which memory bank the new screen size will be assigned. The new memory bank number will be displayed. To ensure the new memory is saved, perform any convergence function on the new memory.

This function is intended for customers with a need for various aspect ratios, especially those with widescreens. From the Runco factory, three (3) memory banks are assigned for each frequency:

Memory Bank 1: 3:4 (1:1.33)

Memory Bank 2: widescreen (1:1.78 or 1.85)

Memory Bank 3: Anamorphic

If this feature is OFF, then each of the 32 memories will be scan rate dependent. In other words, each of the 32 memories MUST have a different frequency. This is especially useful for use with computers and their different resolutions.

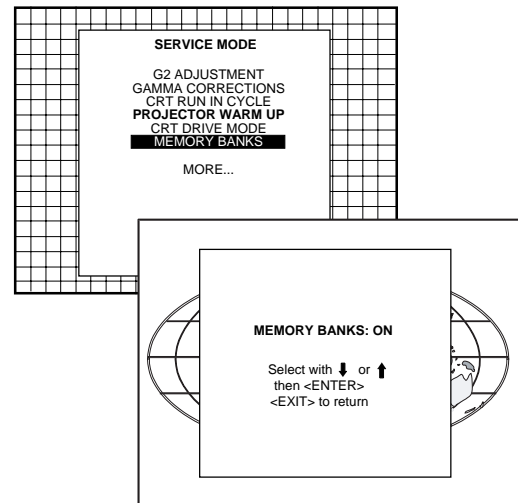





# 8

## MESSAGES, WARNINGS AND FAILURES

<p><b>INPUT 05</b> Fh= 31.5 kHz Fv= 60 Hz</p>	<p>When selecting a new source, information about this source will be displayed on the screen. Source number, horizontal, and vertical frequencies of the displayed source.</p>	<p><b>WARNING :</b>  <b>invalid code entry</b></p>	<p>Message when the entered password is wrong.</p>
<p><b>SOURCE 05</b></p>	<p>Announcement of the selected source.</p>	<p><b>WARNING :</b>  <b>end of adjustment range</b></p>	<p>End of adjustment range.</p>
<p><b>enter password</b> x x x x</p>	<p>Message to enter your password. Password contains 4 digits.</p>	<p><b>WARNING :</b> <b>input no longer available</b></p>	<p>Message will be displayed when the input source is no longer available. The following message then appears: '<i>check input signal or select new source</i>'.</p>
<p><b>text on</b></p>	<p>These messages will be displayed on the screen when pushing the TEXT key.</p>	<p><b>WARNING :</b> <b>invalid frequency input</b></p>	<p>The entered frequency or applied frequency of the source is out of the projector's range.</p>
<p><b>text off</b></p>	<p>Text OFF : the '<i>Bar Scale Indication</i>' will be disabled during the change of an analog control in the '<i>Operational Mode</i>' + all warnings and failures will not be displayed.</p>	<p><b>table is deleted</b></p>	<p>Message to inform that selected table is deleted. This message will be followed by '<i>confirm message</i>', which the user has to answer.</p>
<p><b>PROJECTOR ADDRESS :</b> <b>003</b></p>	<p>Indication of the projector address when activating the '<i>ADDRESS</i>' button on the RCU with a pencil or other small object.</p>	<p><b>FAILURE</b>  <b>12C error addr.: 7FH</b></p>	<p>Hardware failure. Call a qualified service technician for repair.</p>
<p><b>WARNING :</b>  <b>source not available</b></p>	<p>The input is a valid input but the source is not connected to the input terminals or the input source is switched off.</p>	<p><b>FAILURE</b> <b>short circuit on I2C bus</b></p>	<p>Hardware failure. Call a qualified service technician for repair.</p>
<p><b>WARNING :</b>  <b>invalid key entry</b></p>	<p>When a wrong key is pressed on the RCU.</p>	<p><b>FAN FAILED</b> <b>Projector will switch off</b></p>	<p>Message when one of the fans is not working anymore. Projector switches to stand-by.</p>



## 9

## SPECIFICATIONS

<b>Scan Frequency:</b>	Horizontal: 15-75 kHz autolock Vertical: 37-155 Hz	<b>Safety Regulations:</b>	Complies with: UL, FCC Class B, CE, C-Tick
<b>Retrace Time:</b>	Horizontal: 2.5 S Vertical: 200 S	<b>Environment:</b>	32-104° F (0-40° C)
<b>Bandwidth:</b>	120 MHz (-3 dB)	<b>Humidity:</b>	0-90% non-condensing
<b>CRT:</b>	9-inch, high brightness, high definition liquid coupled tubes with electromagnetic focus	<b>Storage:</b>	10-122° F (-12-50° C)
<b>Lenses:</b>	Super high definition, fully color corrected F1.15 lenses	<b>Cabinet Dimensions:</b>	Width: 31 in./787.40 mm Depth: 46.25 in./1174.75 mm Height: 14 in./355.60 mm
<b>Optical Resolution:</b>	HD-120 lenses 12 line pairs per mm 1250 TV lines	<b>Weight:</b>	204 lbs./92.53 kg
<b>Video Resolution:</b>	1250 TV lines	<b>Included Accessories:</b>	Remote control, AC power cord, and Owner's Operating Manual
<b>Video Inputs:</b>	RGB: 5-BNC analog (RGB H/V) or Component (R-Y, Y, B-Y)		Call the factory for more specific information on export specifications.
<b>Color Balance:</b>	Four user selectable settings: 3200 K, 5400 K, 6500 K, 9300 K. All settings can be customized.		Specifications are subject to change without notice.
<b>Input Memories:</b>	32 separate memories with 8 memories per scan frequency and one-touch aspect ratio control		
<b>Internal Setup Pattern:</b>	Crosshatch		
<b>Light Output:</b>	1250 lumens peak/240 ANSI		
<b>Picture Size:</b>	90-300 in. (4:3) diagonal		
<b>Throw Distance:</b>	1.38 x width (widescreen) 1.45 x width (standard 4:3)		
<b>Aspect Ratios:</b>	8 accessible from remote control including: 1.33 (standard), 1.85:1 (widescreen), and Anamorphic		
<b>Configuration:</b>	Front or rear, floor or ceiling mount		
<b>Contrast Ratios:</b>	100:1 (JIS Method) 20:1 (HDTV Method)		
<b>High Voltage:</b>	32.7 kV		
<b>Convergence:</b>	Digital zone convergence with 25 individual zones		
<b>Convergence Limits:</b>	Less than 0.2% of vertical height		
<b>Power Input:</b>	110 VAC, 50/60 Hz (220V Export model)		
<b>Power Consumption:</b>	590 W		



RUMA-003800 rev 10-00



**THE WORLD'S FINEST HOME THEATER PRODUCTS™**

2463 Tripaldi Way  
Hayward, CA 94545  
510-293-9154 Fax: 510-293-0201

## Free Manuals Download Website

<http://myh66.com>

<http://usermanuals.us>

<http://www.somanuals.com>

<http://www.4manuals.cc>

<http://www.manual-lib.com>

<http://www.404manual.com>

<http://www.luxmanual.com>

<http://aubethermostatmanual.com>

Golf course search by state

<http://golfingnear.com>

Email search by domain

<http://emailbydomain.com>

Auto manuals search

<http://auto.somanuals.com>

TV manuals search

<http://tv.somanuals.com>