

Site Code: 15A.12.11.104



17 Litre Manual Microwave

Instruction Manual



Model Number: RHM1708-G

Please read these instructions carefully and
keep them for future reference

For Customer Services & Spare Parts please call

0845 209 7461

Opening times: Monday – Friday
8am – 6pm

Contents

	Page
About this microwave oven	1
Important Safety instructions.....	2
Microwave oven Installation.....	4
Feature diagram.....	5
Control panel.....	6
Operation instructions.....	7
Cleaning and care.....	8
Problem solving.....	9
Important utensil information.....	9
Connection to the mains supply.....	10
Non-rewireable mains plug.....	10

About this microwave oven

Microwaves are high-frequency electromagnetic waves similar to radio waves. While radio waves may vary in length from one metre to many kilometres, microwaves are very short (less than 12.5 centimetres). Microwaves do not make any heat themselves but only cause water molecules in food to vibrate. This vibration produces heat that cooks the food. This is why your food will come out of the microwave piping hot, when your utensils inside the oven stay much cooler. The microwaves do not stay in the air or in the food when you open the microwave oven door.

The microwave oven will work using an ordinary household electrical socket. Inside the microwave oven is the magnetron, which turns the electrical energy into microwaves. Microwaves cannot go through metal, so the inside of the oven is lined with metal. The door is lined with a fine metal mesh which stops microwaves getting through. This means that when the microwave oven door is shut, there is no possibility that microwaves can be released. This is why the microwave oven has been made so that it will not work when the door is open.

Before you use your microwave oven

- 1 Remove all the packaging, some microwave ovens may have a blue film blue film on the outer casing, if so, please remove this. Do not remove the small piece of card from the right hand side of the cavity wall. This is called a wave-guide cover and allows the microwaves to pass through to cook the food.
- 2 Check the oven after unpacking for any visual damage such as:
 - a misaligned door
 - damage to the door
 - dents or holes in the door window and screen
 - dents in the inside
 - If you can see any damage **do not** use the oven

This microwave oven weighs approximately 10.5kg so you must put it on a horizontal surface that is strong enough to support this weight.

The oven must be placed away from high temperatures and steam.

Do not put anything on the top of the microwave oven.

Only use the accessories supplied by the manufacturer.

Do not use the oven when the oven is empty.

Important Safety instructions

- Do not use the oven for any reason other than preparing food, such as for drying clothes, paper or any other non-food items, or for sterilizing purposes.
- Do not use the oven when it is empty. This could damage the oven.
- Do not store anything in the oven, such as papers, cookbooks and so on.
- Do not cook any food surrounded by a membrane, such as egg yolks, potatoes, chicken livers, ready meals and so on without piercing them several times with a fork.
- Eggs in their shell and whole hard-boiled eggs should not be heated in microwave ovens since they may explode, even after microwave heating has ended
- Never put any objects into the openings on the outer case.
- Never remove parts from the oven such as the feet, screws and so on.
- You should use microwave utensils only in line with these instructions.
- Do not try to deep-fry foods in this oven.
- When heating food in plastic or paper containers, keep an eye on the oven due to the possibility of ignition
- Heat from the contents of a container may be transmitted to the container itself, so please be careful when removing it from the oven. Please remember that the food or liquid inside will be releasing some steam or will be spitting. Never cover any container fully, always leave a gap for the steam to escape.
- Microwave heating of beverages can result in delayed eruptive boiling, Therefore care must be taken when handling the container.
- Cooking utensils may become hot because of heat transferred from the heated food. This is especially true if plastic wrap has been covering the top and handles of the utensil. You may need oven gloves to handle the utensil.
- The contents of feeding bottles and baby food jars shall be stirred or shaken and the temperature checked before consumption, in order to avoid burns.
- Always test the temperature of cooked food, never eat or drink food or liquid straight from the oven, allow it to stand for a few minutes and stir to distribute the heat evenly.
- Food containing a mixture of fat and water (for example, stock) should stand for 30 to 60 seconds in the oven after it has been turned off. This is to allow the mixture to settle and to prevent it from bubbling when a spoon is placed in it, or a stock cube is added.
- When heating or cooking food or liquid, remember that there are certain foods (such as Christmas puddings, jam and mincemeat) which heat up very quickly.
- When heating or cooking food that contain a lot of fat or sugar, do not use plastic containers.
- Always have the glass tray and turntable support in place when using the oven.
- Do not cook food directly on the glass tray. Put food on a suitable plate or in a bowl before putting it in the oven.
- Keep the waveguide cover clean at all times. Wipe the oven interior with a soft damp cloth after each use. If you leave grease or fat anywhere in the cavity it may overheat, smoke or even catch fire when next using the oven.

To reduce the risk of fire in the oven cavity:

- Do not overcook food
- Do not leave the microwave unattended while you are using it
- Remove wire twist-ties from bags before putting the bag in the oven.
- If materials inside the oven catch fire, keep the oven door closed, turn the oven off at the wall switch, or shut the power off at the fuse or circuit-breaker panel

WARNING: this oven must be positioned so that the plug is accessible and the plug socket is within easy reach of the power cord.

WARNING: children should not use this microwave oven.

This appliance is not intended for use by persons (including children) with reduced physical, sensory or mental capabilities, or lack of experience and knowledge, unless they have been given supervision or instruction concerning use of the appliance by a person responsible for their safety.

Children should be supervised to ensure that they do not play with the appliance.

WARNING: It is hazardous for anyone other than a trained person to carry out any service or repair operation which involves the removal of any cover which gives protection against exposure to microwave energy.

WARNING: if the door or door seals are damaged, the oven must not be operated until it has been repaired by a competent person. The door seals are located around the window on the inside of the door. These seals are not airtight, although no microwaves can be released, it is normal for small amounts of air or steam to escape when the oven is in use.

Microwave oven Installation

1. Select a level surface that provides enough space for the outlet vents.
2. A minimum clearance of 3 inches (7.5cm) is required between the oven and any adjacent walls. One side must be open. Leave a minimum clearance of 12 inches (30cm) above the oven.
3. Place the oven as far away from radios and TV's as possible. Using the oven may cause interference with the reception.
4. Plug the oven into a suitable 13 amp mains socket, make sure the voltage is the same as the rating label (do not use extension cables or mains socket adaptors).

Warning: do not install the oven over a cooker or other heat producing appliance. This will damage the oven.

Warning: liquids and other foods must not be heated in sealed containers as they are liable to explode.

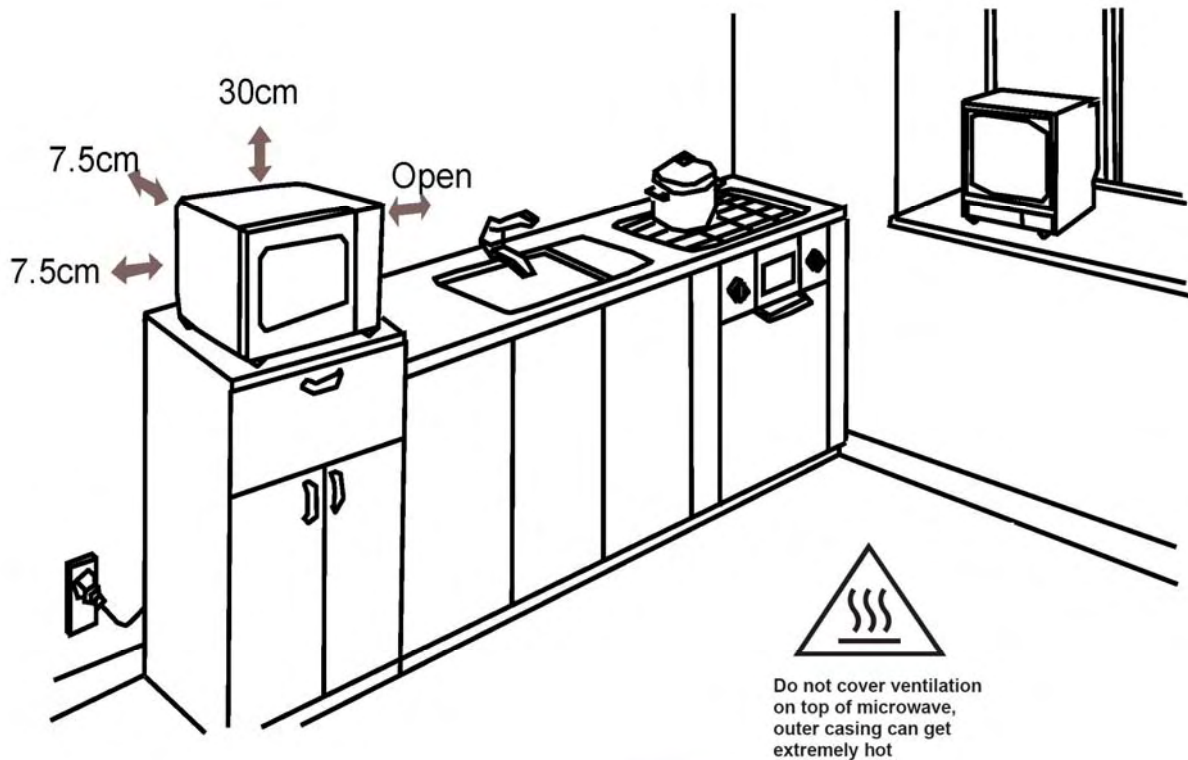

Feature diagram

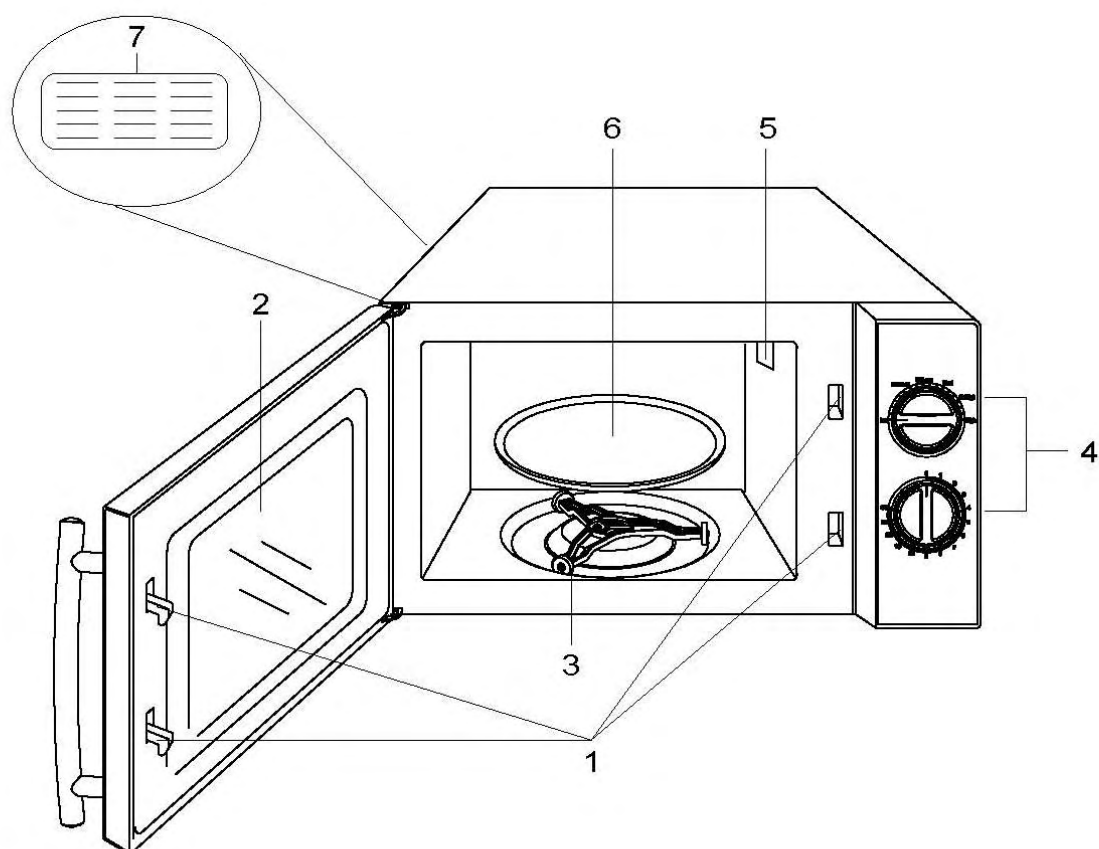

- 1 Door safety lock system
- 2 Oven window
- 3 Turntable support
- 4 Control panel
- 5 Wave guide cover (do not remove)
- 6 Glass turntable
- 7 Air vents

Control panel

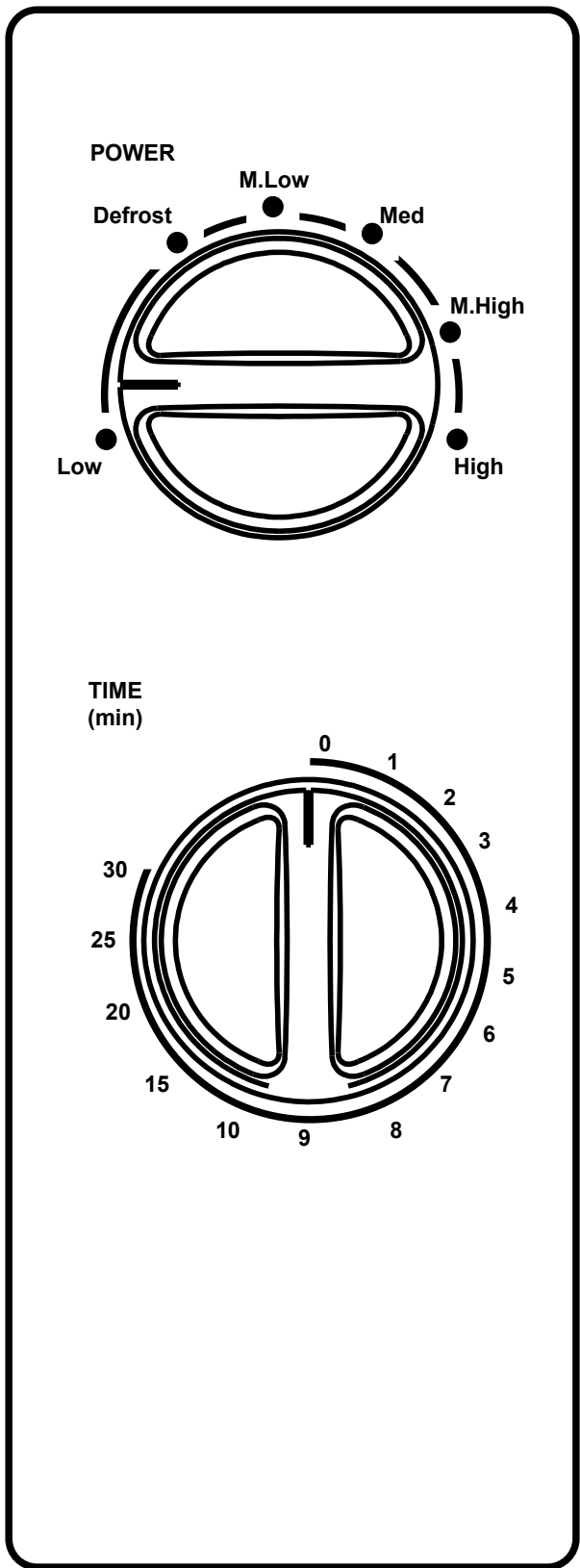

Operating instructions

Using your microwave oven

1. Put the food to be cooked or defrosted in a suitable microwave safe container, cover the food with a suitable cover or with microwave safe clingfilm (pierce with a fork).
2. Put the container into the microwave oven and close the door.
3. Choose the power level you want by turning the 'Power ' knob.
4. Choose the cooking time (in minutes) by turning the 'Timer' knob. Follow the manufacturers guidelines on the pack. The maximum time is 30 minutes (if you are choosing a time less than 2 minutes, turn the timer past 2 minutes and then return to the correct time).
5. As soon as the timer has been set the microwave will start to cook or defrost your food.
6. Cooking or defrosting can be interrupted at any time to stir or check the food progress by opening the door. The microwave oven will automatically continue with the remaining time when the door is closed.
7. After the cooking time has finished, a bell will sound and the microwave oven will automatically turn off.
8. Allow the food to stand for 30 seconds to one minute and stir before serving.

Note:operating the oven without any food in side it can cause damage to the oven.

Function	Power
Low	17%
Defrost	40%
M.Low	48%
Med	66%
M.High	85%
High	100%

Cleaning and care

- Before you clean the microwave oven, turn it off and unplug it.
- Keep the inside of the oven clean. When food or liquids stick to the oven walls, wipe with a damp cloth. We recommend that you do not use harsh detergent or abrasives.
- On the right hand side wall of the cavity is the wave guide cover, microwaves are passed through this to enable your food to cook. It is important that this wave guide cover is kept clean at all times. To do this wipe with mild detergent and water, then dry.
- You should clean the outside of the oven with a damp cloth and polish dry with a soft dry cloth. Don't allow water to seep into the ventilation openings.
- Wipe the door and window on both sides, the door seals and adjacent parts frequently with a damp cloth to remove any spills or splatters. Do not use abrasive cleaner.
- Do not allow the control panel to become wet. Clean with a soft, damp cloth. Do not use detergents, abrasives or spray-on cleaners on the control panel.
- If steam builds up inside or around the outside of the oven door, wipe with a soft cloth. This may happen when the microwave oven is used in humid conditions.
- If the inside of the oven smells, put a cup of water with the juice and skin of one lemon in a deep microwave bowl. Microwave it for three minutes, wipe the cavity walls thoroughly and then dry with a soft cloth.
- Failure to maintain the oven in a clean condition, could lead to deterioration of the surface that could adversely affect the life of the appliance and possibly result in a hazardous condition.
- Regularly clean the turntable support and oven floor. Simply wipe the bottom surface of the oven with mild detergents and water, then dry. You can wash the turntable support in soapy water.
- Regularly remove the glass tray to clean it, and wash in warm soapy water.
- When removing the roller ring from the oven, make sure you put it back properly.
- Do not remove the waveguide cover on the inside wall of the cavity.
- The oven should be cleaned regularly and any food deposits removed.

Problem solving

The microwave oven may cause interference to your radio, TV or similar equipment. If it does, you can get rid of the interference by moving the radio, TV or equipment as far away from your microwave oven as possible.

If the oven doesn't work, if the display does not appear or if the display has disappeared

- Make sure the oven is plugged in securely. If it is not, remove the plug from the socket, wait 10 seconds and plug it in again securely.
- Check the premises for a blown circuit fuse or a tripped main circuit breaker. If these seem to be working properly, test the socket with another appliance.

If the microwave power will not work

- Check to see whether the timer is set.
- Make sure the door is securely closed. Otherwise, the microwave energy will not flow into the oven.

Important utensil information

Do not use metal pans or dishes with metal handles.

- Do not use anything with a metal trim.
- Do not use paper covered wire twist-ties on plastic bags.
- Do not use melamine dishes as they contain a material which will absorb microwave energy. This may cause the dishes to crack or burn, and will slow down the cooking speed.
- Use only cookware that is approved to be used in a microwave oven.
- Do not cook using a container with a restricted opening, such as bottles, as they may explode.
- Do not heat baby bottles with the teat left on and remove if replacing the bottle back into the oven.
- Only use thermometers that are approved for microwaves ovens.

Connection to the mains supply

WARNING- THIS APPLIANCE MUST BE EARTHED

This appliance is designed to operate from a mains supply of AC230V ~ 50HZ. Check that the voltage marked on the product corresponds with your supply voltage. This product is fitted with a 13A plug complying with BS1363. If this plug is unsuitable or needs to be replaced, please note the following: Important: The wires in the mains lead are Coloured in accordance with the following code:
GREEN/YELLOW-EARTH
BLUE-NEUTRAL
BROWN-LIVE



For UK use only – Plug fitting details (where applicable):

As the colours of the wires in the mains lead of this appliance may not correspond with the coloured markings identifying the terminals in your plug, proceed as follows:

The GREEN/YELLOW wire is the EARTH and must be connected to the terminal which is marked with the letter E or by the earth symbol \oplus or coloured GREEN or GREEN/YELLOW.

The BLUE wire is the NEUTRAL and must be connected to the terminal marked with the letter N or coloured BLACK.

The BROWN wire is the LIVE wire and must be connected to the terminal marked with the letter L or coloured RED.

Always ensure that the plug cord grip is fastened correctly.

If a 13A (BS1363) fused plug is used it must be fitted with a 13amp fuse conforming to BS1362 and be BSI or ASTA approved.

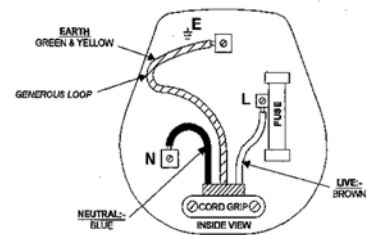

Non-rewireable mains plug

If your appliance is supplied with a non-rewireable plug fitted to the mains lead you will find that it incorporates a fuse, the value of which is indicated either on the base of the plug or on the fuse carrier. Should the fuse need replacing, you must use an ASTA approved fuse (conforming to BS1362) of the same rating. If the fuse cover is lost the plug must not be used until a replacement is obtained from an electrical supplier. If you need to remove the plug, cut it from the mains lead and dispose of it. Never attempt to re-use this plug or insert it into a socket outlet, as there is a very great risk of an electric shock.

SPECIFICATIONS:

Rated voltage:	230V~50Hz,
Operating frequency:	2,450MHz
Power output:	700W
Outside Dimensions:	452mm(W) x 360mm (D) x 262mm(H)
Oven capacity dimensions	315mm(W) x 279mm (D) x 210mm(H)
Oven Capacity:	17 Litres
Weight:Approx.	10.5kg

For Customer Service and
Spare Parts please call

0845 209 7461

Opening times:
Monday – Friday
8am until 6pm

Revision 1



This symbol is known as the 'Crossed-out wheelee bin Symbol'. When this symbol is marked on a product/batteries, it means that the product/batteries should not be disposed of with your general household waste. Only discard electrical/electronic/battery items in separate collection schemes, which cater for the recovery and recycling of materials contained within. Your co-operation is vital to make sure the success of these schemes and for the protection of the environment. For your nearest disposal facility, visit www.recycle-more.co.uk or ask in store for details.

We reserve the right due to possible changes to design to alter the instruction manual without prior notice.

For Customer Services & Spare Parts please call **0845 209 7461** Opening times: Monday – Friday 8am – 6pm

Free Manuals Download Website

<http://myh66.com>

<http://usermanuals.us>

<http://www.somanuals.com>

<http://www.4manuals.cc>

<http://www.manual-lib.com>

<http://www.404manual.com>

<http://www.luxmanual.com>

<http://aubethermostatmanual.com>

Golf course search by state

<http://golfingnear.com>

Email search by domain

<http://emailbydomain.com>

Auto manuals search

<http://auto.somanuals.com>

TV manuals search

<http://tv.somanuals.com>