

**Russound®**

## **CAM6.6X-S1/S2 System**

**6-Zone, 6-Source  
XM Receiver and UNO Smart Keypads**

**INSTRUCTION MANUAL**

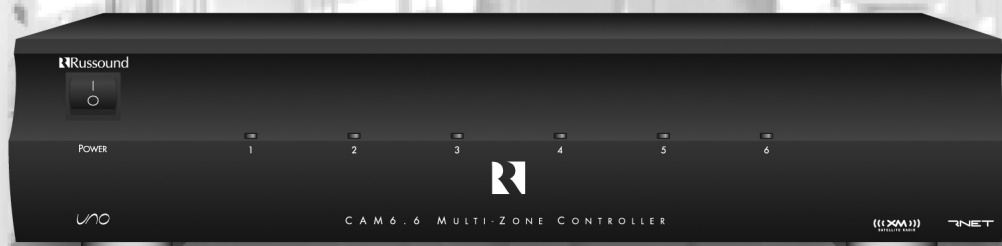

**SATELLITE  
RADIO**

# IMPORTANT SAFEGUARDS

**WARNING: TO REDUCE THE RISK OF FIRE OR ELECTRIC SHOCK, DO NOT EXPOSE THIS APPLIANCE TO RAIN OR MOISTURE.**



**CAUTION: TO REDUCE THE RISK OF ELECTRIC SHOCK, DO NOT REMOVE COVER. NO USER - SERVICEABLE PARTS INSIDE. REFER SERVICING TO QUALIFIED SERVICE PERSONNEL.**



The lightning flash with arrowhead symbol, within an equilateral triangle, is intended to alert the user to the presence of uninsulated "dangerous voltage" within the product's enclosure that may be of sufficient magnitude to constitute a risk of electric shock to persons.

The exclamation point within an equilateral triangle is intended to alert the user to the presence of important operating and maintenance (servicing) instructions in the literature accompanying the appliance.

## POWER CORD NOTICE FOR INTERNATIONAL OPERATION

For 230V, 50Hz operation please select the power cord for your area. Select the plug for your area at one end and a IEC320 connector at the other. It is not necessary to make any other changes. If you have any questions please call Russound Inc. at 1-800-638-8055 or 603-659-5170

## Safety Instructions:

1. Read Instructions - All the safety and operating instructions should be read before the appliance is operated.
2. Retain Instructions - The safety and operating instructions should be retained for future reference.
3. Heed Warnings - All warnings on the appliance in the operating instructions should be adhered to.
4. Follow Instructions - All operating and user instructions should be followed.
5. Water and Moisture - The appliance should not be used near water; for example, near a bathtub, wash-bowl, kitchen sink, laundry tub, in a wet basement, or near a swimming pool.
6. Carts and Stands - The appliance should be used only with a cart or stand that is recommended by the manufacturer. An appliance and cart combination should be moved with care. Quick stops, excessive force and uneven surfaces may cause the appliance and cart combination to overturn.
7. Wall or ceiling Mounting - The appliance should be mounted to a wall or ceiling only as recommended by the manufacturer.
8. Ventilation - The appliance should be situated so that its location or position does not interfere with its proper ventilation. For example, the appliance should not be situated on a bed, sofa, rug, or similar surface that may block the ventilation openings, or placed in a built-in installation, such as a bookcase or cabinet that may impede the flow of air through the ventilation openings.
9. Heat - The appliance should be situated away from heat sources such as radiators, heat registers, stoves, or other appliances (including amplifiers) that produce heat.



10. Power Sources - The appliance should be connected to a power supply only of the type described in the operating instructions or as marked on the appliance.
11. Grounding or Polarization - Precaution should be taken so that the grounding or polarization means of an appliance is not defeated.
12. Power Cord Protection - Power supply cords should be routed so that they are not likely to be walked on or pinched by items placed upon or against them, paying particular attention to cords at plugs, receptacles, and the point where they exit from the appliance.
13. Cleaning - The appliance should be cleaned only as recommended by the manufacturer.
14. Non-use Periods - The power cord of the appliance should be unplugged from the outlet when left unused for a long period of time.
15. Object and Liquid Entry - Care should be taken so that objects do not fall and liquids are not spilled into the enclosure through the openings.
16. Damage Requiring Service - The appliance should be serviced by qualified service personnel when:
  - A. The power supply cord or the plug has been damaged; or
  - B. Objects have fallen, liquid has been spilled into the appliance; or
  - C. The appliance has been exposed to rain; or
  - D. The appliance does not appear to operate normally; or
  - E. The appliance has been dropped or the enclosure is damaged.
17. Servicing - The user should not attempt to service the appliance beyond that described in the operating instructions. All other servicing should be referred to qualified service personnel.

## Precautions:

1. Power – WARNING: BEFORE TURNING ON THE POWER FOR THE FIRST TIME, READ THE FOLLOWING SECTION CAREFULLY. All models are designed for use with either AC120V, 60Hz or AC240, 50Hz voltages. The unit will autoswitch to either of these voltages
2. Do Not Touch The Unit With Wet Hands – Do not handle the CAM6.6 or power cord when your hands are wet or damp. If water or any other liquid enters the CAM6.6 cabinet, take the CAM6.6 to a qualified service person for inspection.
3. Location of CAM6.6 – Place the CAM6.6 in a well - ventilated location. Take special care to provide plenty of ventilation on all sides of the CAM6.6 especially when it is placed in an audio rack. If ventilation is blocked, the CAM6.6 may overheat and malfunction. Do not expose the CAM6.6 to direct sun light or heating units as the CAM6.6 internal components temperature may rise and shorten the life of the components. Avoid damp and dusty places.
4. Care – From time to time you should wipe off the front and side panels of the cabinet with a soft cloth. Do not use rough material, thinners, alcohol or other chemical solvents or cloths since this may damage the finish or remove the panel lettering.

This device complies with Part 15B of the FCC Rules. Operation is subject to the following two conditions: (1) This device may not cause harmful interference, and (2) this device must accept any interference received, including interference that may cause undesired operation.

Changes or modifications not expressly approved by Russound could void the user's authority to operate this equipment.



# TABLE OF CONTENTS



## USER SECTION

<b>Product Introduction</b> .....	6
<b>Component Guide</b>	
CAM6.6 Controller.....	7
UNO-S1 Keypad .....	8
UNO-S2 Keypad .....	9
UNO-LRC1 Remote Control .....	10
UNO-S1 Keypad Operation .....	11
UNO-S1 User Menu .....	12
UNO-S2 Keypad Operation .....	13
UNO-S2 User Menu .....	14
<b>Internal Source - XM Tuner</b>	
XM Radio Activation.....	15
XM Radio Display .....	15
XM Radio Modes .....	16-19
UNO-S1 Keypad Control.....	20
UNO-S2 Keypad Control .....	21-22
UNO-LRC1 Remote Control .....	23-24

## INSTALLER SECTION

<b>Getting Started</b>	
Unpacking .....	26
System Components .....	26
Tools Needed.....	26
System Installation Considerations.....	26
Connection Tips .....	26
<b>Wiring Instructions</b>	
Keypad Wiring.....	27
Speaker Wiring .....	27
<b>Component Guide</b>	
CAM6.6 Controller Rear Panel .....	28-29
UNO-S1 Keypad Front Panel.....	30
UNO-S1 Keypad Rear Panel .....	31
UNO-S2 Keypad Front Panel.....	32
UNO-S2 Keypad Rear Panel .....	33
<b>Keypad Installation</b>	
UNO-S1 Keypad Location and Installation .....	34
UNO-S2 Keypad Location and Installation .....	35

# TABLE OF CONTENTS

## Making Connections

UNO Keypad Port Connections .....	36
Source Audio Input Connections .....	37
Source IR Input Connections .....	37
Common IR Input Connection .....	38
Speaker Connections .....	39
Zone Fixed/Variable Audio Output .....	40
12VDC Home Theater Trigger In/Out .....	41
12VDC Mute Trigger In/Out .....	42
RNET Link In/Out .....	43
RS-232 Interface .....	44
Optional Internal Source	
XM Radio Antenna .....	45
XM Signal Strength .....	45
Initial Install Test .....	46
Programming	
System Programming Overview .....	47-48
Source Information Form .....	49
Zone Information Form .....	50
Macro Editor Form .....	51
Installation Menu	
Installation Menu Overview .....	52
Peripheral Setup .....	53-55
Source Setup .....	55-61
<b>Basic Setup</b> .....	55-56
Zone Setup .....	61-62
Controller Setup .....	62
Power Management .....	62-64
Learn IR .....	64-65
Macro Editor .....	65-66
System Info .....	66
Setup Menu Flow Charts .....	67-79

## REFERENCE SECTION

IR Device Code List .....	80-82
IR Keycode List .....	83-104
Source Names .....	105-106
Sample Configurations .....	107-110
Technical Specifications .....	111
Warranty .....	112

All trademarks are the property of their respective owners.



# USER SECTION

## **Component Guides**

Explains front panel features of the CAM6.6 controller, UNO-S1 keypad, UNO-S2 keypad and UNO-LRC1 remote control.

## **Operation**

Step-by-step outline of the system's normal operation, plus a look at adjustable features available through the User Menu.

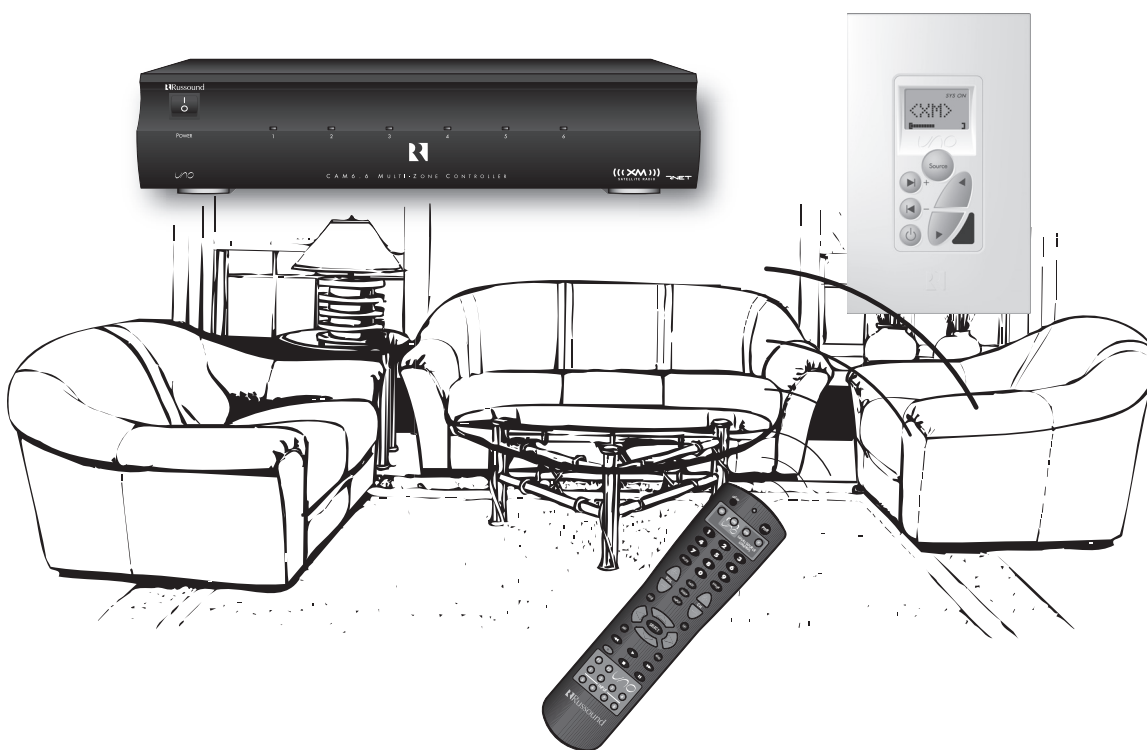

# PRODUCT INTRODUCTION

Thank you for choosing the Russound® CAM6.6X-S1/S2 System to enhance your home with distributed audio. It combines the CAM6.6 Controller Amplifier and UNO keypads into a state-of-the-art home audio system that blends seamlessly with your unique lifestyle and preferences.

Besides distributing and controlling six audio sources to six rooms (zones), your CAM6.6X-S1/S2 System offers many features that increase your enjoyment of living. Here are several that you may find particularly beneficial.

## Internal Source

The CAM6.6X Controller Amplifier includes an optional internal source - an XM satellite radio module. XM satellite radio provides over 100 channels of music, news sports, comedy, talk and entertainment. Its coast-to-coast coverage, digital quality sound and commercial-free music channels make XM radio the choice for the discriminating listener.

XM radio is a subscription-based service, and listeners can subscribe by visiting XM on the web [www.xmradio.com](http://www.xmradio.com) or by calling XM's Listener Care at 800-852-9696.

The XM tuner module can store up to 36 favorites, or memory presets. These are stored in groups of six called banks, and there are six banks. Each preset and each bank can be given a custom name of your choice.

## Favorites

The UNO-LRC1 remote and the UNO-S2 keypad's F1 and F2 buttons are preset favorites. These easy-to-set buttons make it possible to hear your favorite radio station or watch your favorite satellite channel at just the right volume in your room with just a button push. Want something new? Just re-save the Favorite with a new choice.

## Do Not Disturb

The Do Not Disturb mode prevents unwanted interruptions in your room and stops changes to your selected audio source. You may have a nursery or study that you want to keep quiet, or maybe you are watching a DVD and don't want it interrupted. Simply set the Do Not Disturb mode to "on" using the User Menu, and be free from Party Mode interaction and system-wide functions like "All On" or "All Off."

## Party Mode

Ready to set the mood? In Party Mode, you just pick the source and the sound settings and hear the music throughout all the rooms. The Master keypad simultaneously controls all the keypads in all the rooms to effortlessly select or control the components. A great benefit of the Party Mode feature is the ability to transfer the Master keypad mode to any keypad in the system. If the living room is the center of the party, use that room's keypad as Master. If the party moves to the sunroom and porch, that room's keypad can be set to Master instead.

Here at Russound we are proud to continue providing innovative and intuitive audio product solutions to the world. When you link the industry-leading CAM6.6X-S1/S2 system with Russound's commitment to its products and customers, you have truly made – "the right connection."

**CAM6.6 Controller-Front Panel**

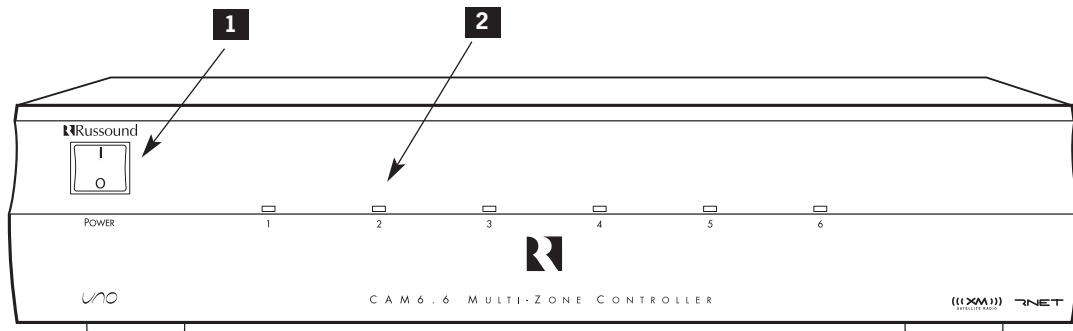

- 1** MAIN POWER SWITCH - Supplies power to the CAM6.6
- 2** ROOM LED ON/OFF INDICATORS - Indicates when a room is on (green) or off (red)





**Main Power and Zone Status**

The power switch for the CAM6.6 controller is "on" in the up position. Any active room is indicated on the front of the controller by a green LED, which shows red when the room is inactive. In most basic installations, all functions and room settings are controlled through the corresponding UNO Systems Keypads.

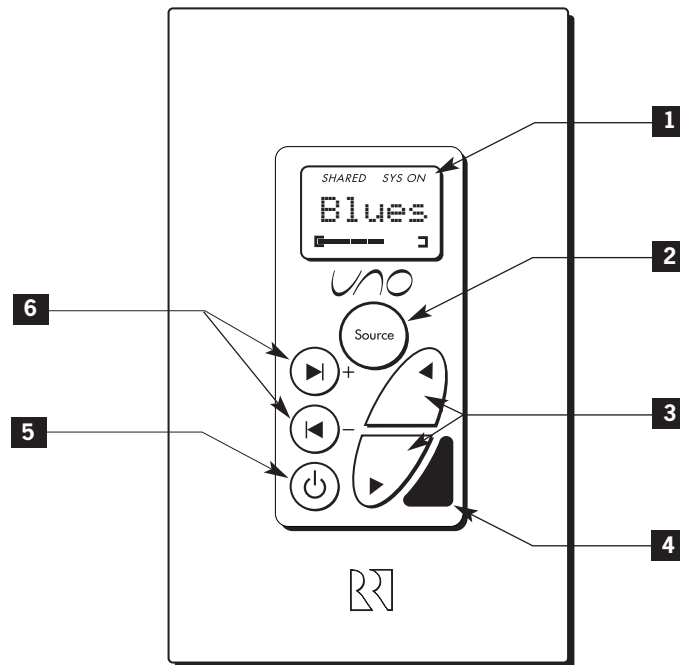
# USER COMPONENT GUIDE

## UNO-S1 Keypad-Front Panel



- 1** LCD PANEL - 5-character backlit display shows status of the room, source, volume, and more
- 2** SOURCE SELECT BUTTON - Scrolls through the sources directly connected to the CAM6.6. Press and hold brings up the USER MENU for loudness, bass, treble, etc.
- 3** VOLUME UP/DOWN BUTTONS - Raises and lowers the volume for the room
- 4** IR RECEIVER - Receives IR signals and passes them to the controller and source equipment. Also used when operating the UNO Keypad by using the UNO-LRC1 remote
- 5** POWER BUTTON - Turns room ON or OFF when pressed once, press and hold a second time will turn on or off all CAM6.6 rooms
- 6** COMMAND KEYS - Pressing the command keys controls the source equipment
  -  - **FORWARD** (press)
  -  - **DISC, CHANNEL UP** (press and hold)
  -  - **REVERSE** (press)
  -  - **DISC, CHANNEL DOWN** (press and hold)



**UNO-S2 Keypad-Front Panel**

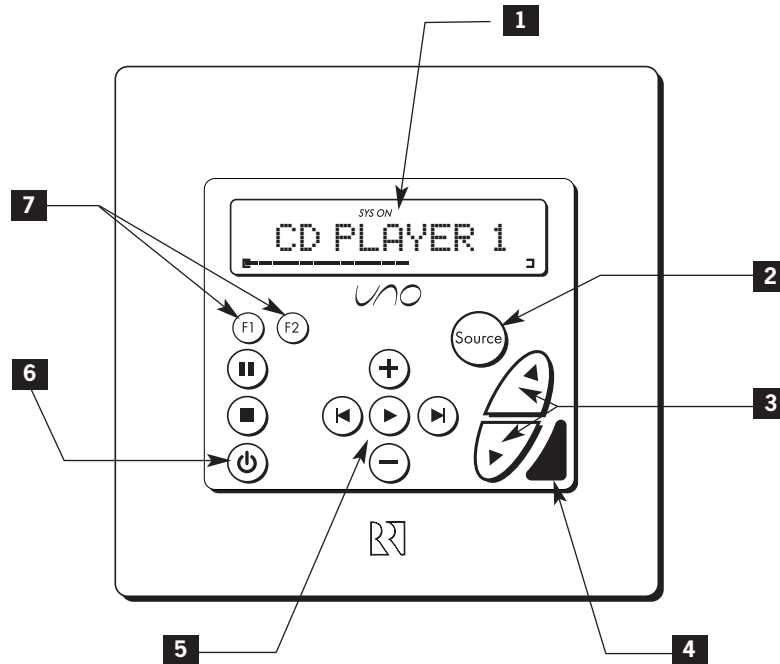

- 1** LCD PANEL - 12-character backlit display shows status of the room, source, volume, and more
- 2** SOURCE SELECT BUTTON - Scrolls through the sources directly connected to the CAM6.6. Press and hold brings up the USER MENU for loudness, bass, treble, etc.
- 3** VOLUME UP/DOWN BUTTONS - Raises and lowers the volume for the room
- 4** IR RECEIVER - Receives IR signals and passes them to the controller and source equipment. Also used when operating the UNO Keypad by using the UNO-LRC1 remote
- 5** COMMAND KEYS - Pressing the command keys controls the source equipment
  - (+)** - DISC, CHANNEL UP
  - (-)** - DISC, CHANNEL DOWN
  - (▶)** - FORWARD
  - (◀)** - REVERSE
- 6** POWER BUTTON - Turns room ON or OFF when pressed once, press and hold a second time will turn on or off all CAM6.6 rooms
- 7** F1 AND F2 BUTTONS - Selects Favorite 1 or Favorite 2 - preset user-selected favorite settings per room

# USER COMPONENT GUIDE

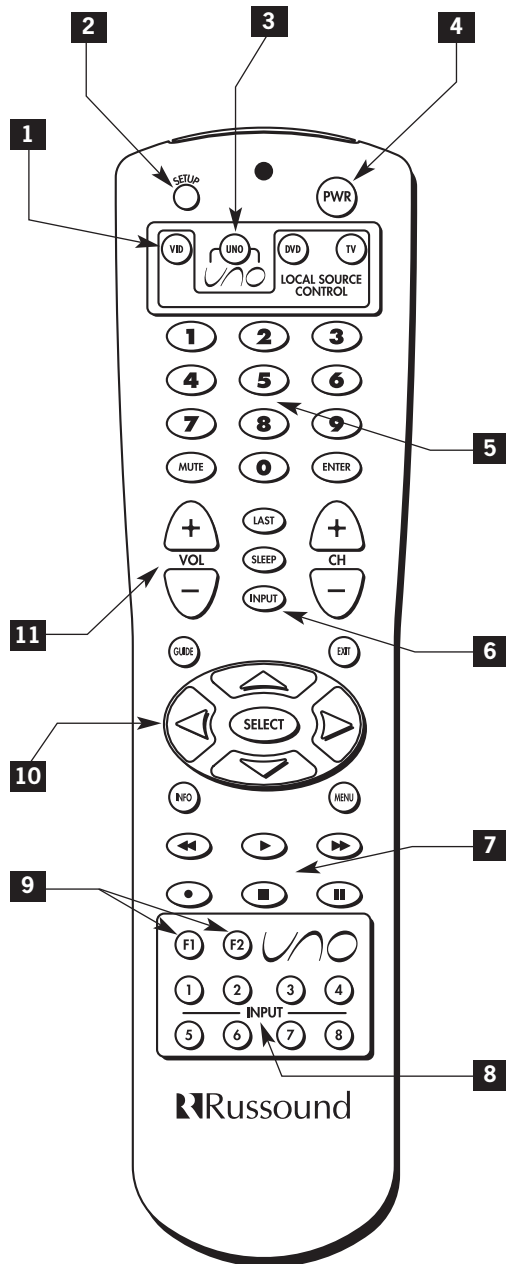

## UNO-LRC1 Remote Control





- 1** LOCAL DEVICE BUTTONS - Select local source to be controlled by UNO-LRC1.
- 2** SETUP - Use for programming UNO-LRC1 using the built-in library or by learning-in codes.
- 3** UNO SOURCE BUTTON - Selects UNO Keypad for control by UNO-LRC1.
- 4** ROOM ON/OFF - Turns room on and off while in the UNO mode.
- 5** NUMBER BUTTONS - Buttons (0-9) for direct selection of channels or tracks.
- 6** INPUT - Scrolls through sources connected to the CAM6.6 while in the UNO mode.
- 7** COMMAND KEYS - Control the source (tuner, CD player, etc.) with these buttons.
- 8** INPUT - Directly select audio sources connected to the CAM6.6 while in the UNO mode.
- 9** F1 AND F2 BUTTONS - Selects Favorite 1 or Favorite 2 preset selections.
- 10** CURSOR KEYS - Issues IR commands for source equipment, allowing movement through menus and program screens.
- 11** VOLUME UP/DOWN - Raises and lowers the volume for the room you are in.

## UNO-S1 Keypad

### Zone On/Off

Press and release  to turn on the UNO System Keypad. This also turns on the corresponding CAM6.6's room, and any presets previously assigned will be activated, including settings for bass, volume, last source selected, etc. Press and release  to turn off the UNO System Keypad. This will also put the corresponding CAM6.6's room into a standby state.



### System All On/Off

An "All On" command is issued by pressing  and holding for 3 seconds, after an initial room has been turned on. An "All Off" command can be issued to all rooms by pressing and holding  after the room has been turned off.

### System On Indicator

When the room is off, but the system is on in another room,  is illuminated by a green backlight and the "SYS ON" icon remains visible.

### Source Select Button



 scrolls through the audio source inputs. To change sources, press and release . As the sources are sequentially selected, each source's name appears on the keypad LCD panel. When a source is selected in more than one room, the "SHARED" icon will appear on all UNO Keypads using that source.  is also used to enter the

User Menu with a press and hold action. (See next page for User Menu)

### Volume Up/Down Buttons

The room's audio output is adjusted using .

### Command Keys

The command keys   allow control of the selected source at the UNO Keypad. The command keys are activated with a press and release, or press and hold to access secondary functions.





# USER

## USER MENU SETTINGS

### **UNO-S1 User Menu Operation**

The User Menu allows the user to adjust the audio properties and control functions of a particular room.









To enter or exit the User Menu, press and hold  during normal operation. The following keys are used to navigate and make changes while using the User Menu:

-  Press and hold to adjust feature setting (increment)
-  Press and hold to adjust feature setting (decrement)
-  Go to next feature.
-  Go to previous feature.
-  View current feature setting.

Note: When within the UNO-S1 User Menu, if no keys are pressed, the display will revert back to its runtime display.

### **UNO-S1 User Menu**

The following features make up the User Menu:

Bass  Treb  Loud  Bal  OnVol   
Bkgnd  DND  Party 

### **Feature and Setting:**

- 1. Bass** -10 < Bass:Flat > +10
- 2. Treb (Treble)** -10 < Treble:Flat > +10
- 3. Loud (Loudness)** (more bass, fuller sound)  
On or Off
- 4. Bal (Balance)** Left 10 < Center > Right 10
- 5. OnVol (Turn on Volume)** (default room volume level) 0 to 100 (in steps of 2)
- 6. Bkgnd (Background Color)** (keypad background light) Amber or Green or Off
- 7. DND (Do Not Disturb)** - On or Off (default)

Do Not Disturb means do not disturb this room or selected source. This stops pages from being sent to this room, stops an "All Off," "All On" or Party Mode command from affecting this room.

When another UNO Systems Keypad selects the same source, a DND message will scroll on the LCD panel, alerting the user the source is in Do Not Disturb mode.



### **8. Party (Party Mode) - Master or Off**

When in "PARTY MODE" the system is primarily controlled by a "MASTER" Keypad. Party Mode links all rooms to the same source which is selected by the Master Keypad room. Any keypad in the system can become a Master Keypad (if enabled) but only one Master Keypad may exist at a time in Party Mode. Selecting Master Keypad mode from another keypad will transfer Master Keypad control to that room and release it from the first. When the source selected in the Master Keypad room is changed then the source for all rooms changes as well. The keypad will scroll a PARTY message on the LCD panel. It will scroll a MASTR message in lieu of PARTY if Master is enabled.



Volume level changes at the Master Keypad will be reflected in all rooms in Party Mode. Non-Master zones in Party Mode can temporarily override Master Keypad volume level adjustments for their particular room preference. Master Keypad will not change Bass, Treble, or Loudness adjustments for any other rooms other than the Master Keypad room. Every other keypad will still operate its respective bass, treble, balance and loudness adjustments for that room.

## UNO-S2 Keypad

### Zone On/Off

Press and release  to turn on the UNO System Keypad. This also turns on the corresponding CAM6.6's room, and any presets previously assigned will be activated, including settings for bass, volume, last source selected, etc. Press and release  to turn off the UNO System Keypad. This will also put the corresponding CAM6.6's room into a standby state.



### System All On/Off

An "All On" command is issued by pressing  and holding for 3 seconds, after an initial room has been turned on. An "All Off" command can be issued to all rooms by pressing and holding  after the room has been turned off.

### System On Indicator

When the room is off, but the system is on in another room,  is illuminated by a green backlight and the "SYS ON" icon remains visible.

### Source Select Button







 scrolls through the six A/V source inputs. To change sources, press and release . As the sources are sequentially selected, each source's name appears on the keypad LCD panel. When a source is selected in more than one room, the "SHARED" icon will appear on all UNO Keypads using that source.

 is also used to enter the User Menu with a press and hold action. (See next page for User Menu)

### Volume Up/Down Buttons

The room's audio output is adjusted using .

### F1 and F2 Buttons

The  and  buttons are user favorite presets. These presets can be selected at any time to recall source selection, volume, and favorite channel, disk, etc. To store a favorite preset: first, adjust the room settings and select a source to be stored. Next, press and hold the desired  or  button until SAVED is displayed on the LCD panel. Now a press and release of the button will recall the favorite preset. To set a favorite numbered disk or channel, use  or  to select a disk or channel (e.g., channel 45). Wait for the keypad to show the source name, then press and hold the F1 or F2 within 15 seconds of setting the numeric selection to save the setting.

### Command Keys

The command keys allow control of the selected source at the UNO Keypad. The command keys are activated with a press and release, or press and hold to access secondary functions.





# USER





## USER MENU SETTINGS

### UNO-S2 User Menu Operation

The User Menu allows the user to adjust the audio properties and control functions of a particular room.









The following keys are used to navigate and make changes while using the User Menu:

To enter the User Menu, press and hold  during normal operation. To exit the User Menu, press and release .

-  Adjust feature setting (increment).
-  Adjust feature setting (decrement).
-  Go to next feature.
-  Go to previous feature.
-  View current feature setting.

Note: When within the UNO-S2 User Menu, if no keys are pressed, the display will revert back to its runtime display.

The following features make up the User Menu:

BASS  TREBLE  LOUDNESS  BALANCE   
 TURN ON VOL  BG COLOR  DO NOT  
DSTRB  PARTY MODE 

#### Feature and Setting:

- 1. BASS**  
-10 < Bass:Flat > +10
- 2. TREBLE**  
-10 < Treble:Flat > +10
- 3. LOUDNESS** (more bass, fuller sound)  
On or Off
- 4. BALANCE**  
Left -10 < Center > Right +10
- 5. TURN ON VOL** (default room volume level)  
0 to 100
- 6. BG COLOR** (keypad background light)  
Amber or Green or Off

#### 7. DO NOT DSTRB - On or Off (default)

Do Not Disturb means do not disturb this room or selected source. This stops pages from being sent to this room, stops an "All Off," "All On" or Party Mode command from affecting this room.

When another UNO Systems Keypad selects the same source, a DND icon will appear alerting the user the source is in Do Not Disturb mode.

#### 8. PARTY MODE - Master (Enable) or Off (Disable)

When in "PARTY MODE" the system is primarily controlled by a "MASTER" keypad. Party Mode links all rooms to the same source which is selected by the Master Keypad room. Any keypad in the system can become a Master keypad (if enabled) but only one Master Keypad may exist at a time in Party Mode. Selecting Master keypad mode from another keypad will transfer Master keypad control to that room and release it from the first. When the source selected in the Master keypad room is changed then the source for all rooms changes as well.

Volume level changes at the Master Keypad will be reflected in all rooms in Party Mode. Non-Master zones in Party Mode can temporarily override Master Keypad volume level adjustments for their particular room preference. F1 and F2 favorite presets selected from the Master Keypad will be enabled in all rooms in Party Mode. Master Keypad will not change Bass, Treble, or Loudness adjustments for any other rooms other than the Master Keypad room. Every other keypad will still operate its respective bass, treble, balance and loudness adjustments for that room.

***XM Radio Overview***

**XM Radio Activation**

XM Radio is over 100 channels of radio broadcasts with the signal delivered by satellite and (depending on location) transferred by terrestrial antennas. The radio is a subscription-based service with a monthly provider fee and an activation charge. XM radio broadcasts several channels for preview but will not broadcast the full range of channels without activation. Activation and billing are handled solely through XM Radio.

**To activate the XM tuner:**

1. Turn on the power, select the XM Tuner source, and select channel 0. The tuner's eight-character XM satellite Radio ID number will appear on the display. Write the number down to have it available when contacting XM Radio for activation. The number is also shown on the back of the unit and on the product box.
2. To subscribe, have a major credit card and your XM Radio ID number at hand and contact XM at <http://www.xmradio.com/activation> You can also activate service by calling XM Radio at 1-800-852-9696. You will be guided through the activation process step by step.
3. A complete and up-to-date full channel listing is available on the XM Radio website, [www.xmradio.com](http://www.xmradio.com).

**XM Radio Displays**

In addition to Channel and Category information, the XM tuner will broadcast operating condition messages when the following conditions occur:

<b>Display</b>	<b>Condition</b>
ANTENNA	Antenna not connected
UPDATING	Updating encryption code
LOADING	Acquiring channel audio or information
OFF AIR	Channel not in service
CH- - -	Channel (SID) no longer available
- - - - -	Corresponding Artist Name or Song Title are null (empty)
- - - - -	No channel available for the chosen category

# USER

## INTERNAL SOURCE - XM TUNER

### XM Radio Modes

#### XM Radio Modes

There are four user “modes” for selecting music on the XM Tuner:

**Preset** (default or normal)

**Category Search**

**Now Playing**











**Display Preferences.**

These modes are accessed through certain button and key presses from the tuner panel, remote controls and keypads. When choosing modes, if no choice is made after 20 seconds, the tuner will time out by showing EXIT and return to tuner display and Preset mode.

#### For all XM Modes

The chart below outlines the button presses for various XM tuner functions *outside* of the XM modes.

**If the UNO-S1 button operation is not specifically mentioned, use the UNO-LRC1 to transmit commands through the UNO-S1.**

	UNO-S1	UNO-S2	UNO-LRC1
<b>All User Modes</b>			
Operating Mode Toggle			   
Exit Current Mode			 
Signal Strength		 Hold	 Hold

#### Operating Mode Toggle

This button press accesses the three XM modes. The three modes will appear in order: Category Search, Now Playing and Display Preferences.

#### Exit Current Mode

This button press returns the XM tuner to Preset (default) mode.

#### Signal Strength

This button press and hold accesses the Signal Strength mode. Depending on the signal, the following will be displayed:

GOOD SIGNAL	Signal strength good
MARGINAL SIG	Signal strength marginal
POOR SIGNAL	Signal strength poor
NO SIGNAL	Loss of signal

Press the appropriate button again to exit Signal Strength Mode.



***XM Radio Modes***

**Preset (default) Mode**

This is the normal operating mode of the XM tuner for channel up and down, bank selection and memory presets.

**Next Preset**

This button press accesses the next saved preset (6 presets for each bank) in the chosen bank.

**Previous Preset**

This button press accesses the previous saved preset in the chosen bank

**Next Bank**

This button press accesses the next bank (total of 6 banks).

**Previous Bank**

















This button press accesses the previous bank.

**Channel Up**

This button press accesses the next active channel up from the current channel.

**Channel Down**

This button press accesses the next active channel down from the current channel.

	UNO-S1	UNO-S2	UNO-LRC1
<b>Preset Mode</b>			
Next Preset			
Previous Preset			
Next Bank		 Hold	 Hold
Previous Bank		 Hold	 Hold
Channel Up	 Hold		
Channel Down	 Hold		

# USER

## INTERNAL SOURCE - XM TUNER

### XM Radio Modes

#### Category Search Mode (1.CAT SEARCH)

XM Radio is organized by Channel Category (e.g., Rock, Country, News). Within each category is a series of channels (e.g., Top Tracks, Bluegrass Junction, XM Classics). Channel selection in this mode is refined to scrolling only those channels in the selected category.

#### Next Category

This button press accesses the next category from the current category.

#### Previous Category



















This button press accesses the previous category from the current category.

#### Category Channel Up

This button press accesses the next channel up within the selected category.

#### Category Channel Down

This button press accesses the next channel down within the selected category.

	UNO-S1	UNO-S2	UNO-LRC1
<b>Category Search Mode</b>			
Next Category			 
Previous Category			 
Category Channel Up	 Hold		 
Category Channel Down	 Hold		 

**XM Radio Modes**

**Now Playing Mode (2.NOW PLAYNG)**

This mode displays information about the current XM selection. Appropriate button presses access the next or previous information item.

**NAME:**











Displays the artist's name, feature name or program name (news, talk, sports).

**TITLE:**

Displays the song title or program title.

**CATEGORY:**

Displays the current category.

	UNO-S1	UNO-S2	UNO-LRC1
<b>Now Playing Mode</b>			
Next Info Item			 
Previous Info Item			 

**Display Preference Mode (3.DISPLY PREF)**

This mode allows you to choose how XM channel information will be displayed on the keypad and tuner. Appropriate button presses access the next or previous preference item.

*Note: For any display configuration, the artist's name and song title will scroll before the display returns to the designated display format.*

**Channel Number (CH NUMBER:)**













This selection displays the channel number only (e.g., XM070, XM103).

**Channel Name (CH NAME:)**

This selection displays the channel name only (e.g., ESPN Radio, Real Jazz).

**Channel Number and Name (:#:CH NAME:)**

This selection displays the channel number and name (e.g., 64:The Groove, 121:Fox News).

	UNO-S1	UNO-S2	UNO-LRC1
<b>Display Preference Mode</b>			  
Next Display Preference			 
Previous Display Preference			 

# USER

## INTERNAL SOURCE - XM TUNER

### ***UNO-S1 Keypad Control***



#### **UNO-S1 Keypad Control of Tuner**

##### **Selecting the tuner**

On the UNO-S2 keypad, press  to select the XM Tuner by choosing the tuner's preassigned source number (1).

##### **Selecting the desired channel**

Press and hold  and  to activate manual

channel selection. Once active, press  or  to scroll through channels. The channel will scroll twice on the keypad then stop and display the channel display format's first five characters.

**If an XM radio tuner operation does not specifically refer to an UNO-S1 button operation, use the UNO-LRC1 remote control to transmit commands through the UNO-S1.**

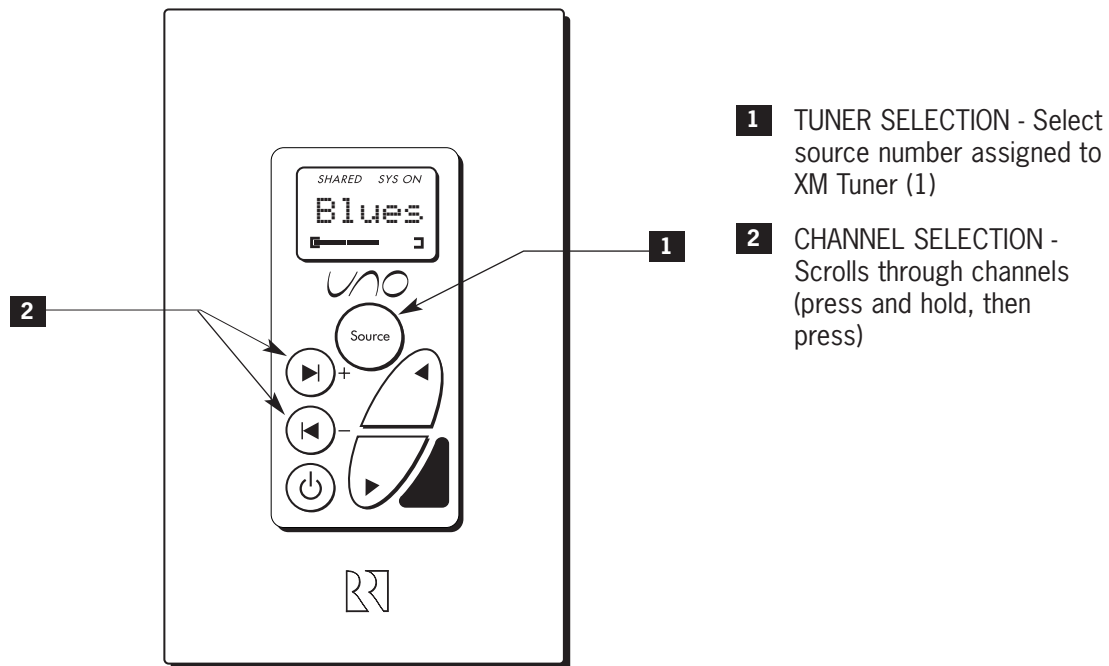

***UNO-S2 Keypad Control***

**UNO-S2 Keypad Control of Tuner**

**Selecting the tuner**

On the UNO-S2 keypad, press  to select the XM Tuner by choosing the tuner's preassigned source number (1).





**Selecting a Mode**

Push  to toggle between XM modes.

**Exiting a Mode**



Press  to exit XM mode selection menu.

**Selecting the desired channel**



Use  and  for manual channel selection. The channel will appear on the keypad. To move quickly through the channels, press and hold either  or  for more than 1.5 seconds.

**Signal Strength Mode**



To check XM signal strength, press and hold

 then release. The display shows the signal strength rating. To exit, press  again.

**Selecting a Bank**

To select a bank, press and hold  for bank up or  for bank down. The bank's name will be temporarily displayed on the UNO-S2.

**Recalling a Memory Preset**

Press  and  to scroll through the memory presets for the selected bank. This procedure will step through all of the presets in the current bank, then loop back to start at the first one. Only configured presets will be displayed.

**Mute**

Press  to mute/unmute the tuner audio output.

# USER INTERNAL SOURCE - XM TUNER

## UNO-S2 Keypad Control

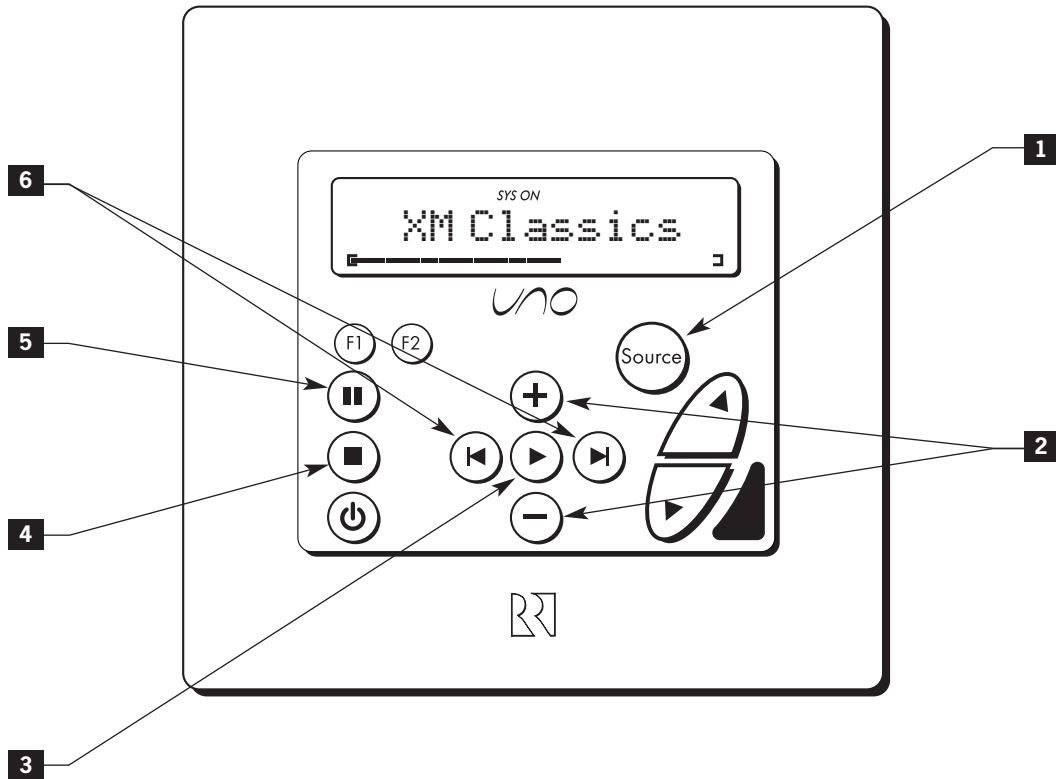

**1** TUNER SELECTION - Select source number assigned to XM TUNER (1)

**2** TUNE UP/DOWN - Used for manual channel selection

**3** SELECT - XM operating mode toggle

**4** SEEK - (press) Exit current XM mode

**4** SCAN - (press and hold) XM Signal Strength mode toggle

**5** MUTE - Mutes/unmutes tuner audio output

**6** BANK SELECT - Used for bank selection (press and hold)



**6** MEM UP/DOWN - Scrolls through memory preset stations (press)

**UNO-LRC1 Remote Control of Tuner**



**Selecting the tuner**

To select the XM tuner, push  and choose the source number preassigned to the XM Tuner (1), or use the UNO numeric source inputs at the bottom of the UNO-LRC1.



**Selecting a Mode**

Push ,  or  to toggle between XM operating modes.





**Exiting a Mode**

Press  or  to exit XM operating mode menu.

**Signal Strength mode**

Press and hold  and release. The display shows the signal strength rating. To exit press .

**Selecting the desired channel**



Use the Channel  and  or  and  for manual tuning. To move quickly through the channels, press and hold the button for more than 1.5 seconds. To directly select a channel, enter the one-, two- or three-digit channel.

**Recall Last Channel**

Press the  button to recall the last channel selected.

***UNO-LRC1 Remote Control***



**Selecting a Bank**

To select a bank, press and hold  for bank up or  for bank down.

**Setting a Memory Preset**

To set a memory preset, tune to the desired channel, then press and hold the appropriate number key (1-6) for the preset. When the memory preset is saved, the appropriate preset number (M1 through M6) and **SAVED** will be temporarily displayed on the UNO-S2.

**Recalling a Memory Preset**

Press  and  to scroll through a loop of all the memory presets for the currently selected bank. Only configured presets will be displayed.

**Mute**

Press the  button to mute/unmute the tuner audio output.

# USER INTERNAL SOURCE - XM TUNER

## UNO-LRC1 Remote Control

**UNO SELECTION** - UNO must be the selected source for control of the CAM6.6 and any connected components. Select UNO before sending UNO-LRC1 remote commands.

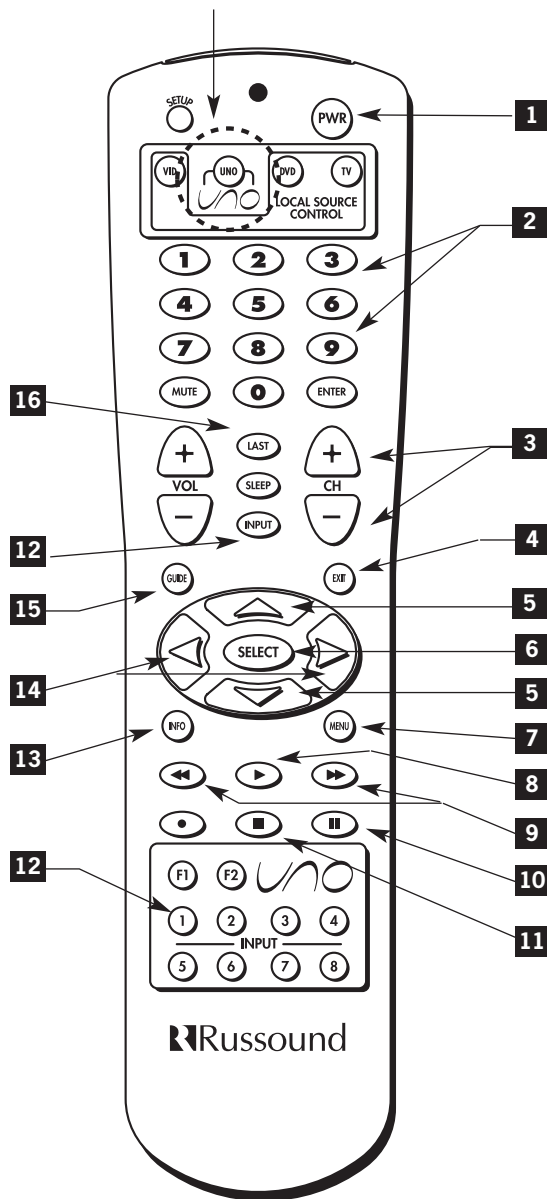

- 1** POWER - Power managed by CAM6.6
- 2** NUMERIC INPUT - Number buttons for direct input of channel, preset, bank (press). Memory preset save (press and hold)
- 3** TUNE UP/DOWN - Incrementally scrolls through channels
- 4** EXIT - Exit XM operating mode
- 5** TUNE UP/DOWN - Incrementally scrolls through channels
- 6** SELECT - XM Operating mode toggle
- 7** MENU - XM Operating mode toggle
- 8** PLAY - XM Operating mode toggle
- 9** BANK UP/DOWN - Used for bank selection (press and hold)
- 9** MEM UP/DOWN - Scrolls through memory presets for selected bank (press)
- 10** MUTE - Mutes/unmutes tuner audio output
- 11** SCAN - Exit XM Operating mode
- 12** TUNER SELECTION - Select source number assigned to XM Tuner (1)
- 13** INFO - XM Now Playing mode toggle
- 14** SEEK UP/DOWN - Next/previous preset, category, info item, display preference
- 15** GUIDE - XM Category Search mode toggle
- 16** LAST - Recalls last XM channel selected





# INSTALLER SECTION

## **Getting Started**

Includes an installation overview, including tools needed and wiring instructions.

## **Component Guides**

Reviews front and back panel features of the CAM6.6 controller and the UNO-S1 and UNO-S2 keypads.

## **Keypad Installation**

Explains UNO-S1 and UNO-S2 keypad installation and wiring.

## **Making Connections**

Details front and back panel connections of the controller and the keypad.

## **System Programming Overview**

Outlines the programming planning process, and includes information forms to complete prior to programming.

## **Installation Menu**

Explains the programming menus that set up controller, keypad, source and zone operations.

## **Setup Menu Flow Charts**

Presents the programming menus in a graphical flow chart format.

## **IR Device Codes**

A list of controller's IR device code library for source Device Code entries.

## **Key Function Codes**

A list of IR codes for each command type contained in the built-in library.

## **Source Names**

A list of Source Names available for assignment.

## **Sample Configurations**

Diagrams of various configurations using CAM6.6s and other components.

# INSTALLER

## GETTING STARTED

### Unpacking the System Components

- Keep the original carton and packing materials for future shipment or storage.
- Check for any visible signs of damage. If you encounter any concealed damage, consult your Russound dealer before proceeding to install the unit.
- Retain the sales receipt as it establishes the duration of the limited warranty and provides information for insurance purposes.

### CAM6.6X-S1/S2 System Components:

- 1 (one) CAM6.6 Controller/Amplifier
- 1 (one) UNO-S2 System Control Keypad
- 5 (five) UNO-S1 System Control Keypads
- 1 (one) UNO-LRC1 Learning/Preprogrammed Remote Control
- 6 (six) 845.1 Micro Emitters

### Tools needed for installation:

- Drill with a 1/2" x 6" drill bit
- Keyhole saw
- Flat head screwdriver (medium size)
- Phillips Screwdriver (cordless recommended)
- 110 punchdown tool (included)
- Modular RJ-45 crimper and connectors
- Pair of diagonal cutters or wire strippers
- Stud finder
- Steel wire fish tape
- Cable staples
- Double-gang electrical work box
- Single-gang electrical work boxes

### System Installation Considerations

There are several factors to consider before installing the Russound CAM6.6X-S1/S2 system:

- What are the intended listening zones?
- What system options and accessories might be required for features such as local sources, etc.?
- From where in each zone will the user prefer to control the system? Where will the keypads be located? Where will the speakers be located?
- Where will the source equipment be located? The CAM6.6 must have proper ventilation above and below for air circulation and heat dissipation. A rack-mount location may require fans and vents.

### Connection Tips

- It is recommended that the CAM6.6 and the source equipment be plugged into a dedicated 20-amp circuit with an isolated ground. A power line conditioner can reduce interference problems caused by noise found in some electrical systems.
- Disconnect all live power cords before making connections to the controller.
- Verify that all connections and polarity are correct.
- Keep all power cords away from all signal cables to prevent humming from induced noise.
- Choose reliable signal cables/patch cords.
- Label all wires with room location at both ends of the wire.

# INSTALLER WIRING INSTRUCTIONS

## CAUTION

Do not connect the controller's main power feed until all other connections have been made and verified. Live connection or removal of the keypad wiring or other wiring when the system is powered can cause communication problems in the network. Double-check terminations during each phase of the installation to prevent accidental damage. Incorrect wiring is the number one cause for non-warranty product damage.

### Keypad Wiring

For the UNO-S2 and UNO-S1 keypad, the following connections are used to terminate the CAT-5 wire to the 110 punchdown on the keypad:

<u>CAT-5 WIRE COLOR</u>	<u>TYPE</u>
Brown . . . . .	+12V
Brown/White . . . . .	+12V
Green . . . . .	Ground
Green/White . . . . .	Status In
Orange . . . . .	Ground
Orange/White . . . . .	IR Out
Blue . . . . .	COM A
Blue/White . . . . .	COM B

- To determine the amount of CAT-5 wire required for the system installation, first decide how many keypads will be used, then determine the distance between each intended keypad location to the intended CAM6.6 location. The maximum recommended wire run length is 250 feet for each UNO Keypad.

- Make sure that the entire wire path between keypads and CAM6.6 is clear and not obstructed by a floor ceiling joist, or masonry wall which can't be drilled through.
- Confirm ahead of time that you can drill an outlet hole easily and in an unobtrusive spot to connect wires with the CAM6.6.
- Label wires with keypad and room location. This simplifies CAM6.6 hook-up once the keypads and speakers are installed.

### Speaker Wiring

- Standard 16-gauge 4-conductor stranded speaker wire can be run up to to 125 feet; 14-gauge wire can be run up to 250 feet.
- When running wire, avoid locations concealing pipes, heating ducts and AC wiring in the general vicinity.
- Avoid running wires close to house electrical wiring for any distance. If you have to run them parallel, make sure to space the wires at least two feet from the AC line.

### RJ-45 Connections

The CAT-5 T568A wiring standard shown on the right is used for the RJ-45 terminations.

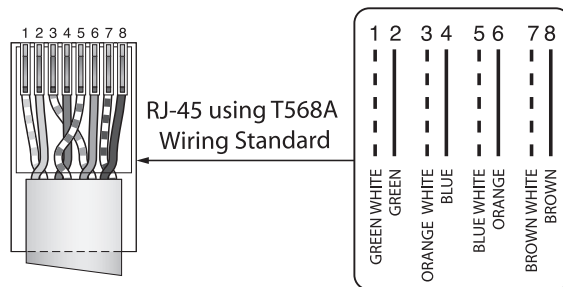

# INSTALLER COMPONENT GUIDE

## CAM6.6 Controller-Rear Panel

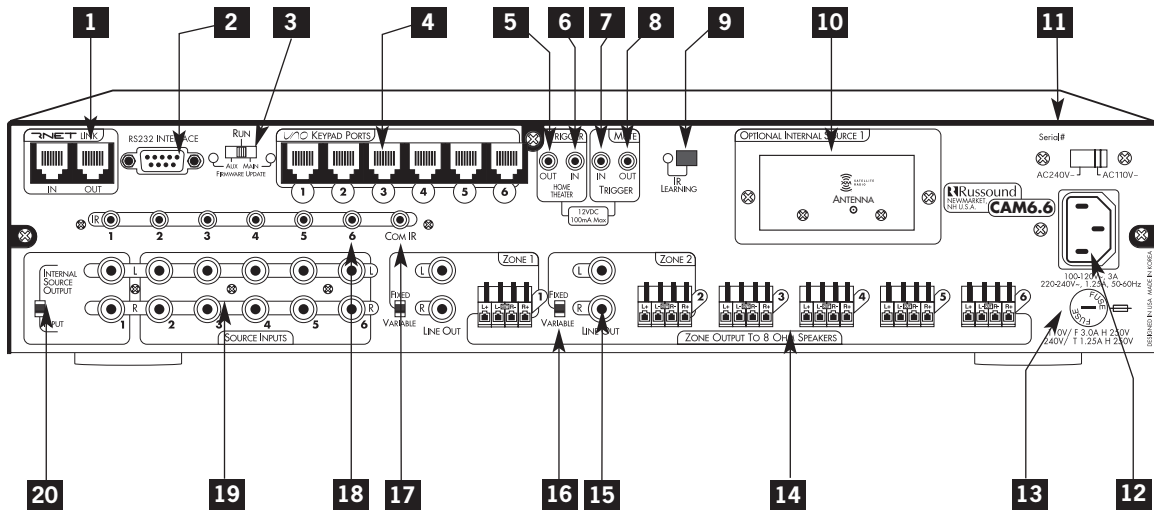

- 1** RNET LINK IN AND LINK OUT - Links multiple CAM6.6's, also links future Russound components that are RNET compatible
- 2** RS-232 INTERFACE - The RS-232 Interface allows the zones to be controlled by PC or other devices that have an RS-232 Interface. The RS-232 Interface also allows for firmware updates and programming.
- 3** AUX-MAIN RUN SWITCH - For firmware updates
- 4** UNO KEYPAD PORTS - One UNO Keypad Port for each of the six CAM6.6 Zones
- 5** 12VDC TRIGGER OUT - 12VDC 100mA Trigger Out turns on when any zone is on
- 6** HOME THEATER 12VDC TRIGGER IN - 12VDC input jack notifies the CAM6.6 that additional components are active, e.g., home theater equipment
- 7** MUTE 12VDC TRIGGER IN - Applying 12VDC to the Mute 12VDC Trigger In jack will activate Audio for assigned CAM6.6 Zones and mutes the audio
- 8** MUTE 12VDC TRIGGER OUT - Mute Trigger Out supplies 12VDC 100 mA whenever 12VDC is applied to the Mute 12VDC Trigger In
- 9** IR LEARNING WINDOW - IR receiver for learning in IR commands with confirmation LED

# INSTALLER COMPONENT GUIDE

## ***CAM6.6 Controller-Rear Panel***

- 10** OPTIONAL INTERNAL SOURCE - Factory installed optional internal source, XM radio module
- 11** AC 240V-AC 110V Switch - Switches A/C input voltage between 110VAC and 240VAC
- 12** AC 120/240 INPUT - Grounded 3-terminal plug detachable power cord connection for the CAM6.6
- 13** FUSE HOLDER - Holds a replaceable fuse for A/C input connection  
110VAC operation-F 3A H 250V, 240VAC operation-F 1.25A H 250V
- 14** SPEAKER OUTPUTS - Connect 8 Ohm speakers for each zone by using detachable color-coded modular snap connectors
- 15** AUDIO OUTPUTS - Audio line output connection
- 16** FIXED/VARIABLE SWITCH - Change line out between fixed and variable output.
- 17** COMMON IR OUTPUT - Output jack will pass all IR signals from all keypads
- 18** SOURCE IR OUTPUTS - Six source-specific IR Output jacks allow for IR control of source equipment
- 19** AUDIO INPUTS - Six sets of Audio Line Level input connections for CAM6.6 source components
- 20** OUTPUT/INPUT SWITCH - Enable Source Input 1 or enables Internal Source 1 output

# INSTALLER COMPONENT GUIDE

## UNO-S1 Keypad-Update Port

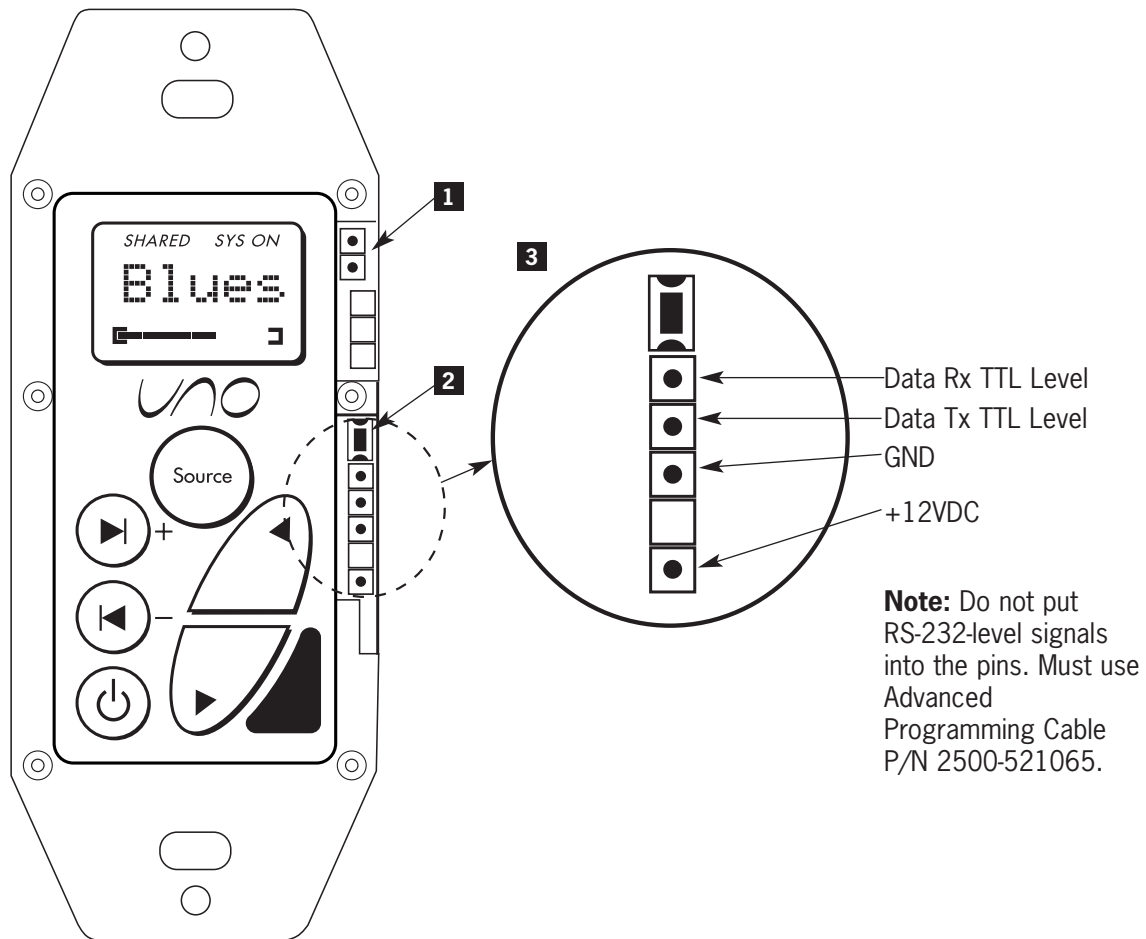

- 1** OS Update/Run Jumper -The pins are jumpered when performing an OS update on the keypad, and removed during normal operation. (Typically needed only on a keypad that has never been updated)
- 2** Setup Button - Activates information and update menus for the keypad.
- 3** OS Update Port - Used to update the UNO-S1 keypad operating system firmware. If an update is released, it will be available online through the Document Center on [www.russound.com](http://www.russound.com). Look for it in the "Firmware and Downloads" section under Multi-Zone product type. The Advanced Programming Cable is available from Russound, Part #2500-521065.

# INSTALLER COMPONENT GUIDE

## UNO-S1 Keypad-CAT-5 Connection

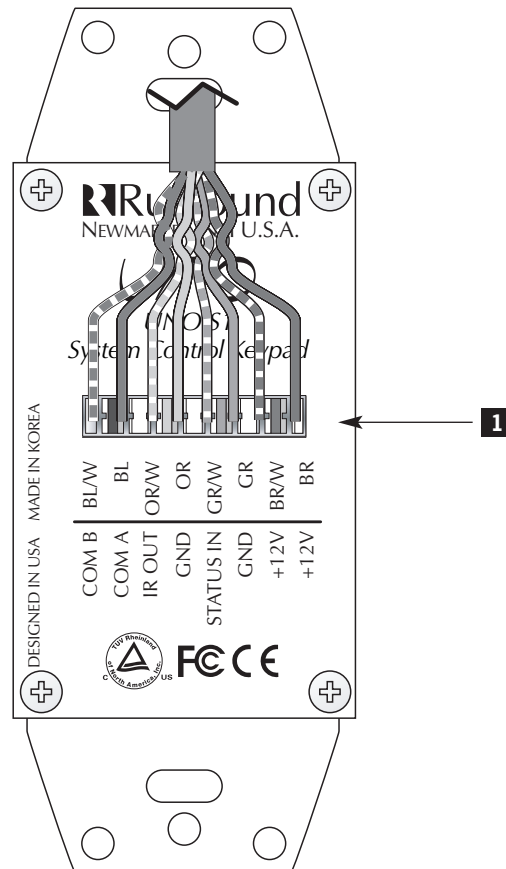

- 1** 110 PUNCHDOWN CONNECTOR - Termination for CAT-5 connection between the UNO-S1 Keypad and the CAM6.6 controller.

### CAT-5 Connection

The UNO-S1 Keypad uses a 110-punchdown terminal to provide a simple installation and strong connection for CAT-5 cable's eight conductors. Punchdown terminals require the use of a punchdown tool which has been provided with the keypad kit. Attach the CAT-5 cable to the 110-punchdown terminal on the UNO-S1 Keypad as shown, matching the conductor colors to the connection color guide. The keypad will not operate properly if the terminations deviate from the required connection order.

### Caution:

Take care when using an impact 110 punchdown tool, as this may overspread the contact points. Use of the impact tool may propel stray bits of wire and jacket into the keypad's chassis and possibly cause a short in the circuitry. Gently shake or blow air through the keypad chassis to remove stray wire before the keypad is installed into the junction box.

# INSTALLER COMPONENT GUIDE

## UNO-S2 Keypad-Update Port

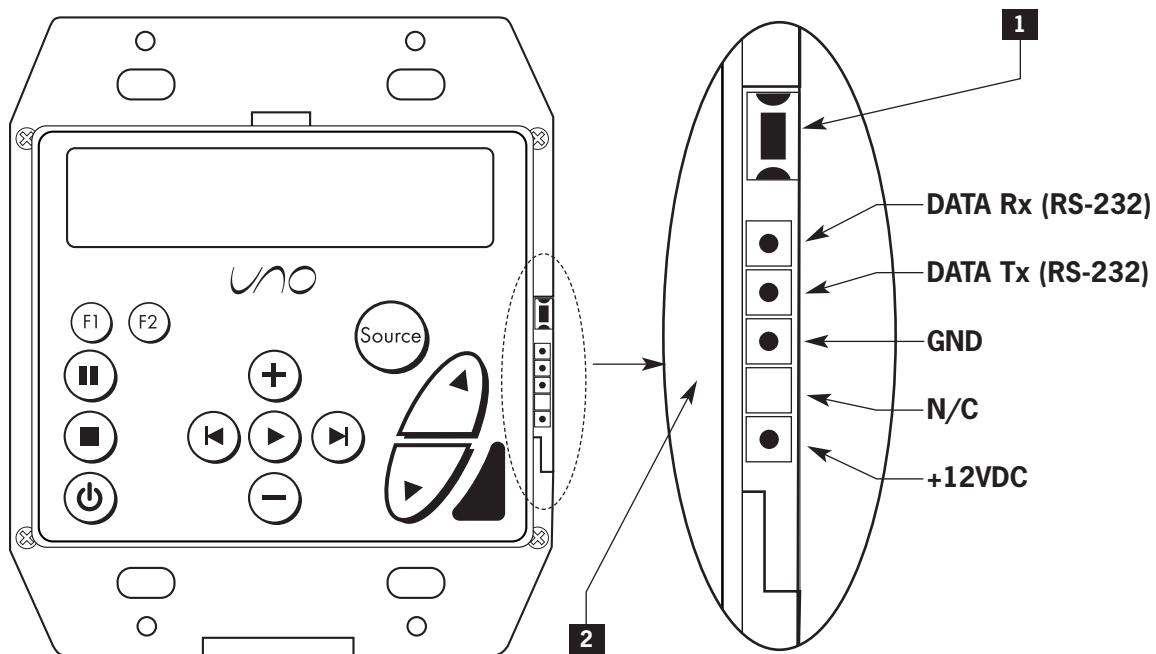

- 1** SETUP BUTTON - Activates Installer Setup Mode for the UNO-S2 keypad
- 2** OS UPDATE PORT - The OS Update Port is used to update the UNO-S2 Keypad operating system software in the future. If an update is released, it will be available online through the Document Center on [www.russound.com](http://www.russound.com). Look for it in the "Firmware and Downloads" section under Multi-Zone product type. The Programming Cable is available from Russound, Part #2500-120633.



# INSTALLER COMPONENT GUIDE

## UNO-S2 Keypad-CAT-5 Connection

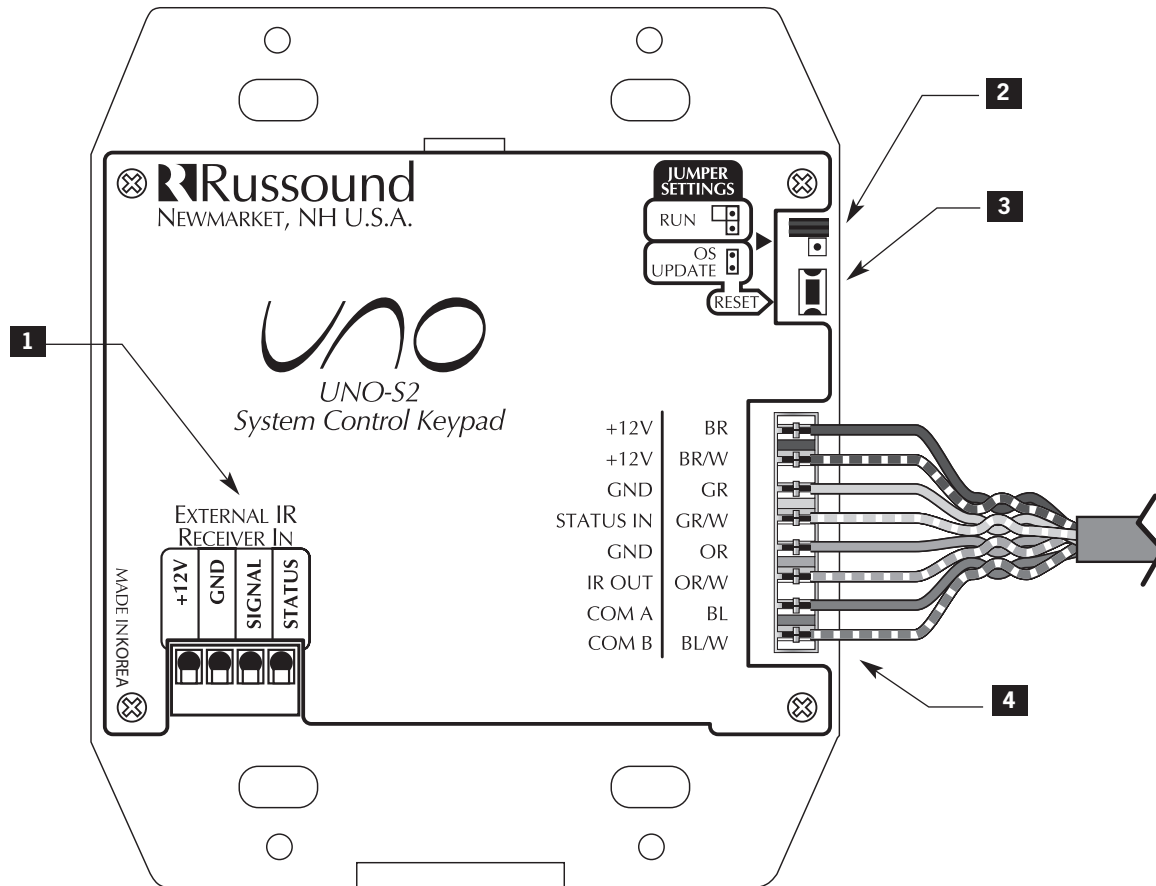

- 1** EXTERNAL IR RECEIVER IN CONNECTOR - Connection for an external IR Receiver.
- 2** OS UPDATE JUMPER - Selects "Run" or "OS Update" mode.
- 3** RESET BUTTON - Reset whenever changing from RUN to OS update
- 4** 110 PUNCHDOWN CONNECTOR - Termination for CAT-5 connection between the UNO-S2 Keypad and the CAM6.6 controller.

# INSTALLER

## UNO-S1 KEYPAD-INSTALLATION

### Keypad Location

The best infrared remote performance is achieved with the keypad away from any direct sunlight, plasma TV, and low voltage lighting controls. Also consider convenience when choosing a location.

Choose a place that is easily seen from the position where a person is most likely to be located.

Check whether or not you can route the wire to the location you have chosen.

### Keypad Installation

To install a single-gang keypad, you will need to use a UL/CSA approved plastic single-gang electrical box.

Route CAT-5 wire to the junction box from the CAM6.6.

Use the supplied 110 punchdown tool to connect each wire to its corresponding color labeled on the punchdown terminal.

Ensure jumper settings on keypads are in the run positions.

Mount the keypad in the electrical box and attach the cover plate. Repeat the steps until all keypads are installed.

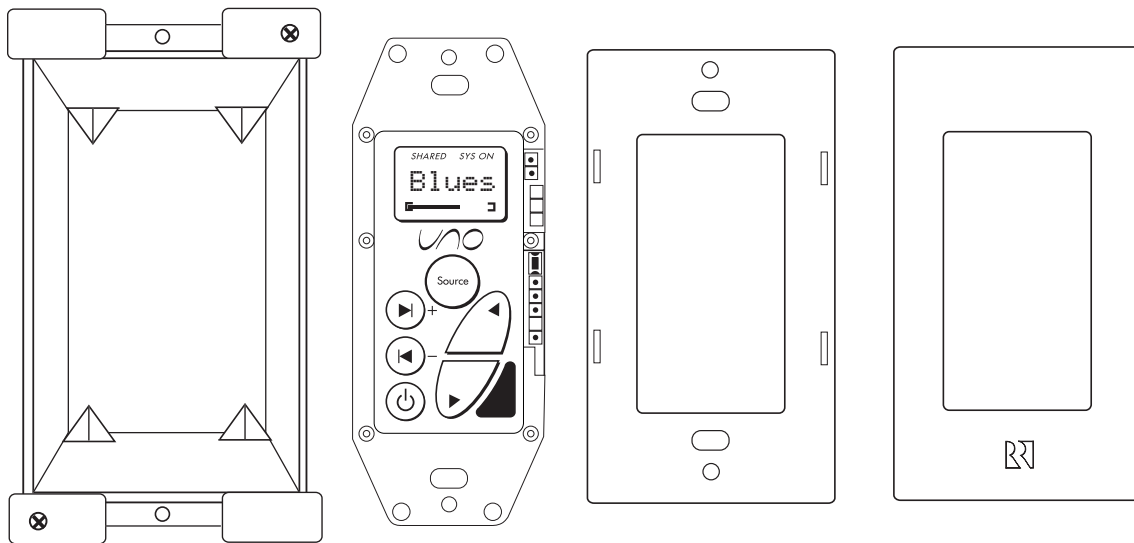

**Junction Box**

**UNO-S1**

**Back Plate**

**Cover Plate**

# INSTALLER

## UNO-S2 KEYPAD-INSTALLATION

### Keypad Location

#### Keypad Installation

To install a double-gang keypad, you will need to use a UL/CSA approved plastic double-gang electrical box.

Route CAT-5 wire to the junction box from the CAM6.6.

Use the supplied 110 punchdown tool to connect each wire to its corresponding color labeled on the punchdown terminal.

Ensure jumper settings on keypads are in the run positions.

Mount the keypad in the electrical box and attach the cover plate. Repeat the steps until all keypads are installed.

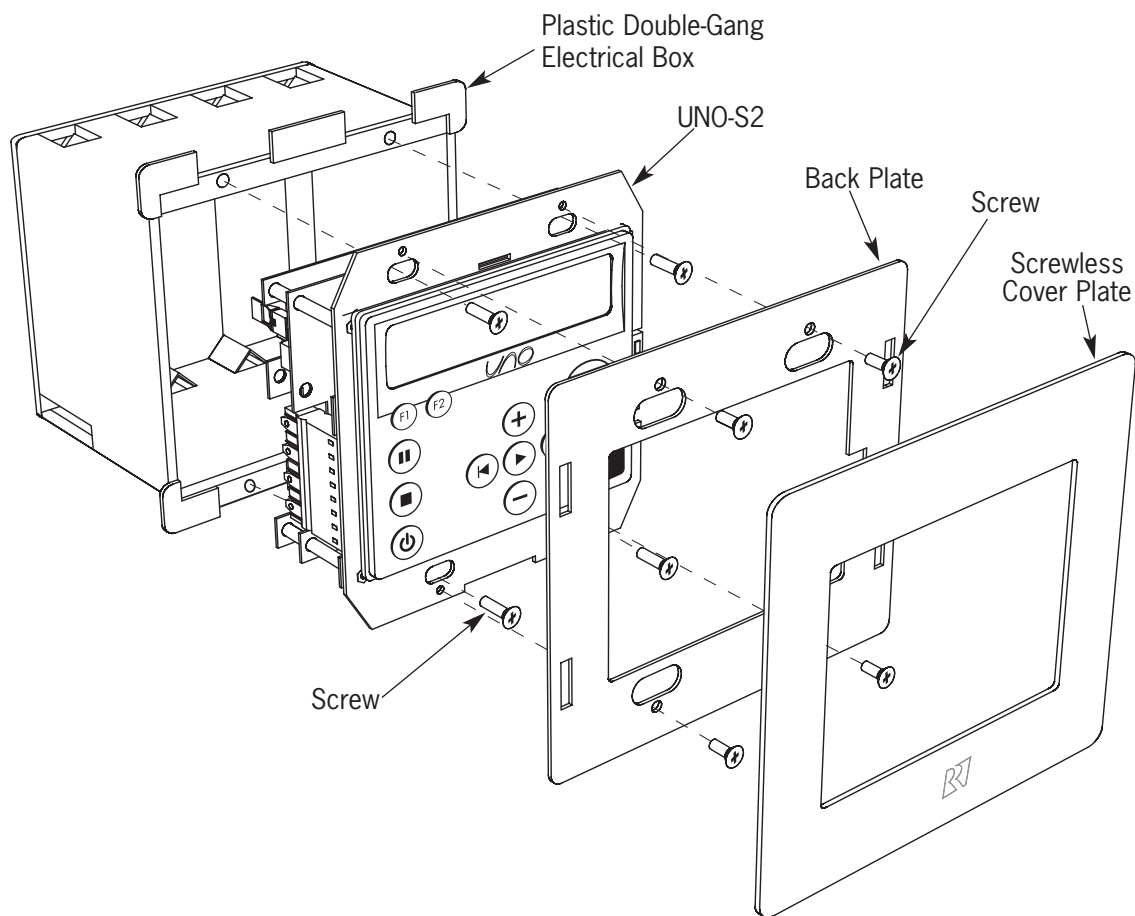

# INSTALLER

## MAKING CONNECTIONS

### UNO Keypad Port Connection

The UNO System Keypad Ports are located on the back of the CAM6.6 in the top left of center. Connections made at the UNO Keypad Ports are made using CAT-5 T568A RJ-45 wire configuration. CAT-5 is color-coded for ease of installation. For a clean installation when wiring from an UNO System Keypad Port use an RJ-45 CAT-5 patch cable to connect from the keypad port to an RJ-45 Wall Plate (optional). Using the same

CAT-5 T568A RJ-45 wiring configuration, use CAT-5 from the RJ-45 Wall Plate to the keypad. If using more than one keypad on a zone, connect a SA-ZX3 UNO System Keypad Splitter (optional) directly to the UNO System Keypad Port instead of going through the wall plate. Always use the CAT-5 T568A RJ-45 wire configuration when wiring any of the UNO System Keypad Ports.

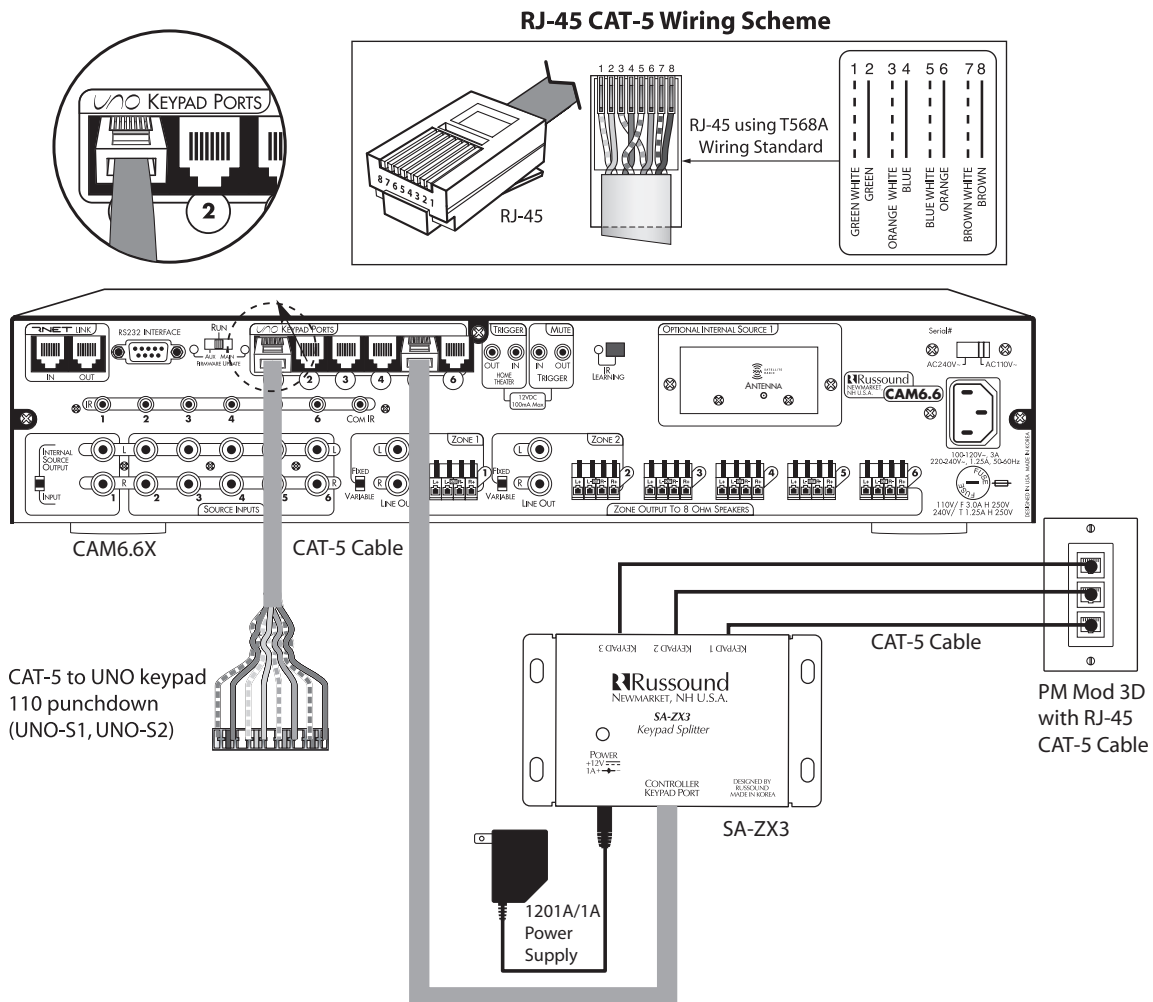

# INSTALLER MAKING CONNECTIONS

## Source Audio and IR Input Connections

### Source Audio Connections

The CAM6.6 supports up to six audio sources. The Source Inputs are located at the back panel. The Source 1 input serves a dual purpose. If the CAM6.6 optional internal source is used, the Source 1 inputs are not available, and the switch next to it is set to "Internal Source Output." If the Optional Internal Source is not installed, or if you want to utilize the Source 1 inputs, set the switch to "Input" and reconfigure Source 1 in the Source Setup Menu. Connect each source output using quality RCA signal cables. Connect the Left and Right Audio outputs from each source to the corresponding inputs on the CAM6.6 controller. Label each cable with the name of the selected source and the Source Audio input number located on the CAM6.6.

### Source IR Connections

Each source component has a designated IR port on the back of the CAM6.6. This IR port is directly above the Source Audio Input Connections.

1. Using an IR emitter (the Russound 845.1 is recommended), attach the end of the emitter with the 1/8" plug to the IR emitter port above the source input.
2. Remove the adhesive back at the other end of the emitter and attach the emitter over the source component's IR window.
3. In order to control this source component with IR, the source must be selected at the keypad receiving the command.

### CAM6.6 with Optional Internal Source - XM satellite radio

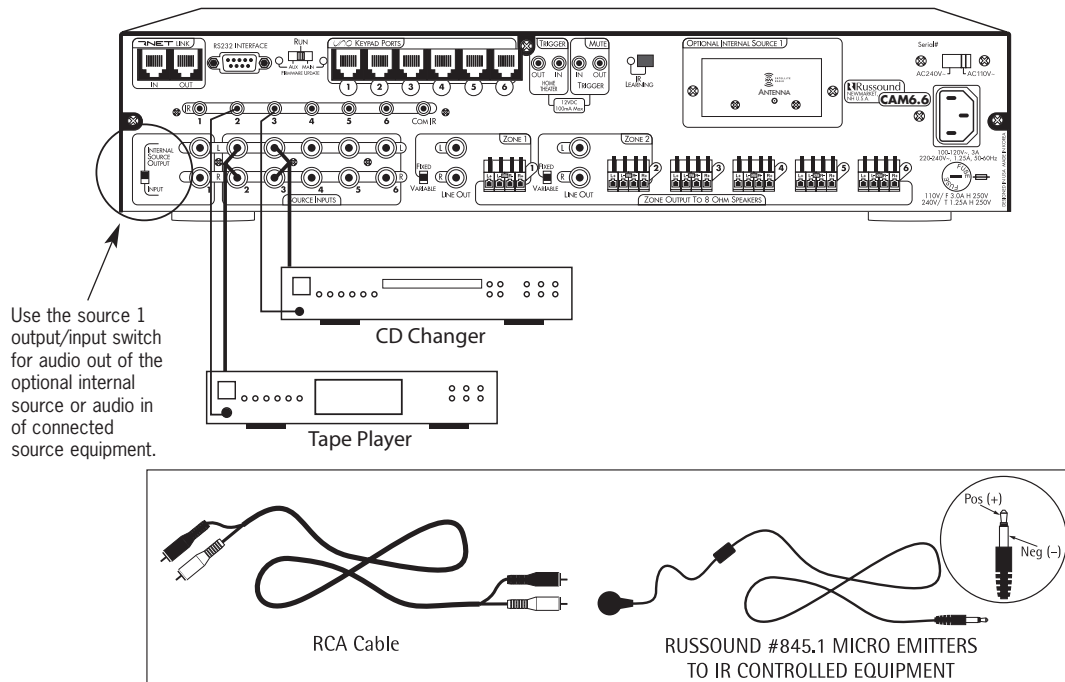

# INSTALLER

## MAKING CONNECTIONS

### Common IR Connection

#### Common IR Connections

The Common IR jack on the rear of the CAM6.6 allows control of any source equipment without that source being selected on the keypad. The connection for the COM IR jack is made using an

IR emitter with a 1/8" plug. The Russound 845.1 single IR emitter is recommended, or use an IR connecting block such as the Russound 857 which allows multiple units to be controlled through the COM IR Port.

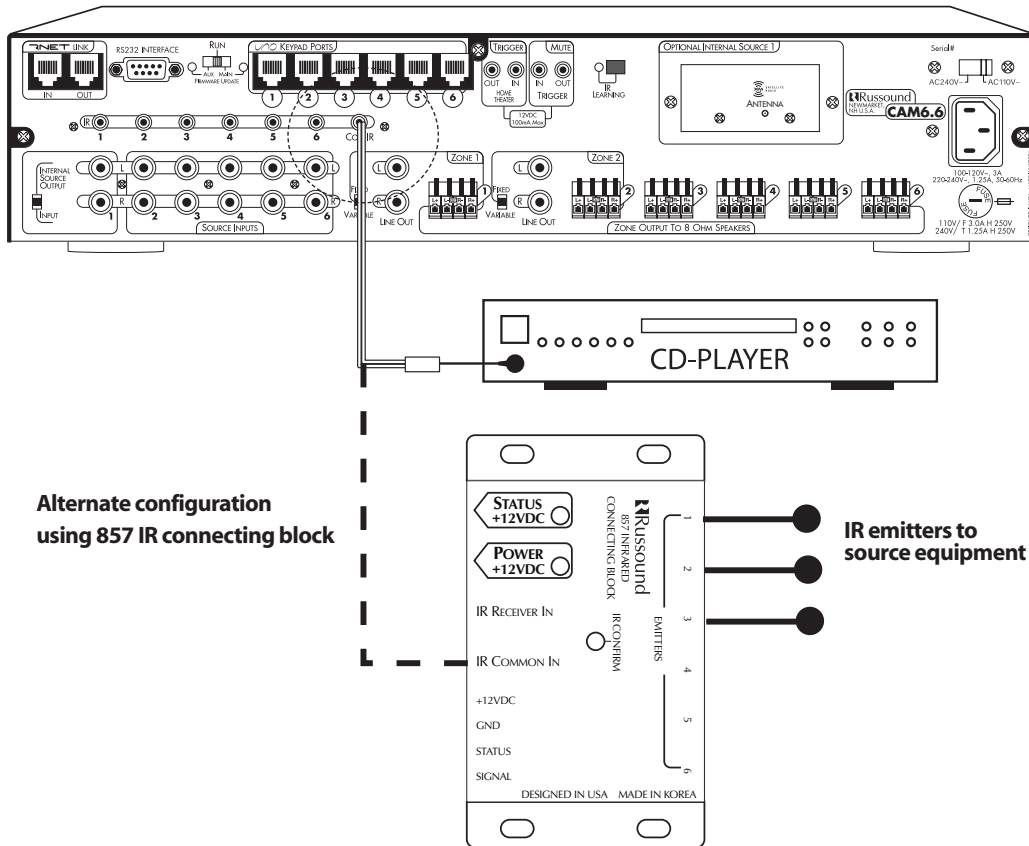
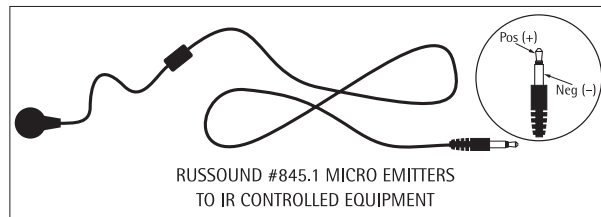

# INSTALLER MAKING CONNECTIONS

## Speaker Connections

The speakers are connected to the CAM6.6 using modular snap connectors. Each of these color-coded connectors is designated for the speaker set of a particular amplified zone. To avoid confusion, connect one zone speaker set at a time starting with Zone 1, taking care to keep zone and speaker wire identities straight. Note: An 8 Ohm minimum speaker is required for each amplified output.

1. Pull the speaker wire conductors apart so they're separated for the first two inches from their ends.
2. Using a wire stripper, remove 1/4 inch of insulation from each conductor. Twist the strands in each conductor into tight spirals.
3. Remove the modular four-color connector for Zone 1. The color code is as follows:

- WHITE -- L+ (left channel positive)**
- GREEN -- L- (left channel negative)**
- BLACK -- R- (right channel negative)**
- RED -- R+ (right channel positive)**

Lift the black lever for each connection until it locks open and insert the proper speaker wire, matching channel and polarity for all four wires. Snap the lever down. Insert the modular connector into its designated output on the back of the CAM6.6.

4. Complete the same steps for the remaining zones. Label each set of speaker wires with the zone and location.

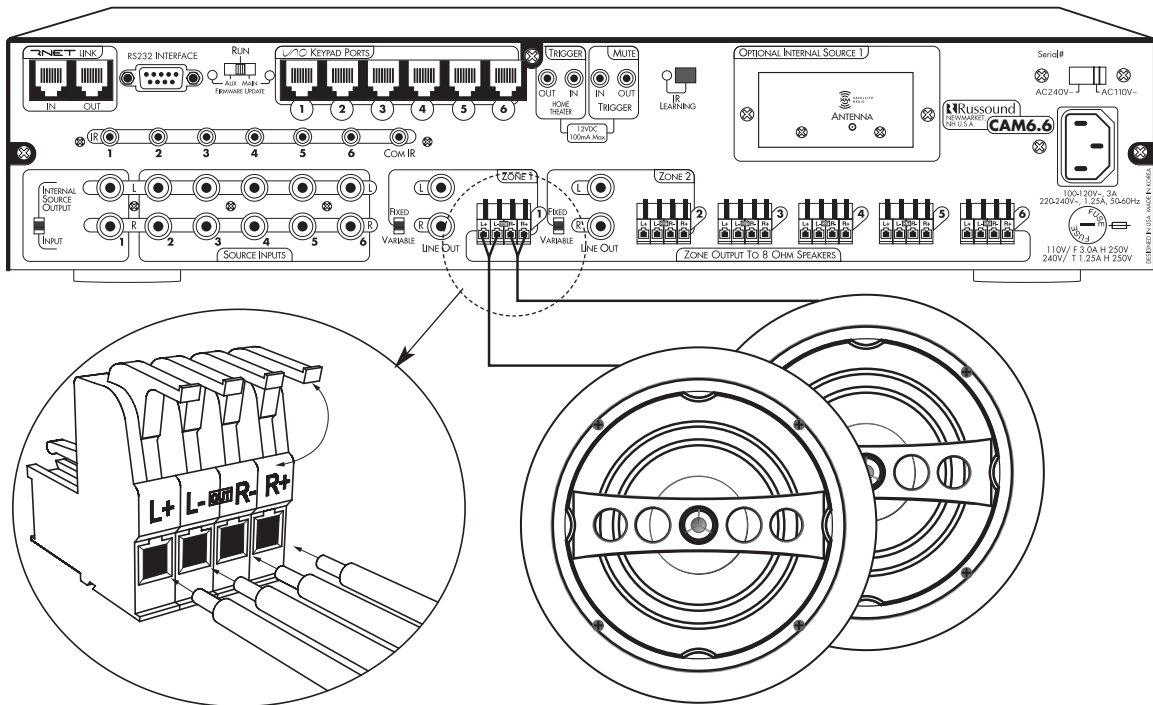

# INSTALLER

## MAKING CONNECTIONS

### Zone Fixed/Variable Audio Outputs

The CAM6.6 has two Zone Audio outputs, on Zone 1 and Zone 2. Each of these zone audio output connections features a stereo line out RCA connection plus a switch to allow for either a fixed or a variable line level output. When set to Variable, the keypad volume level affects this output. In the Fixed position, keypad volume level will not change the output level.

The fixed or variable audio outputs can be used if additional amplification is desired (e.g., Russound DPA-1.2 two-channel amplifier). Use quality RCA signal cables to ensure a constant quality audio signal.

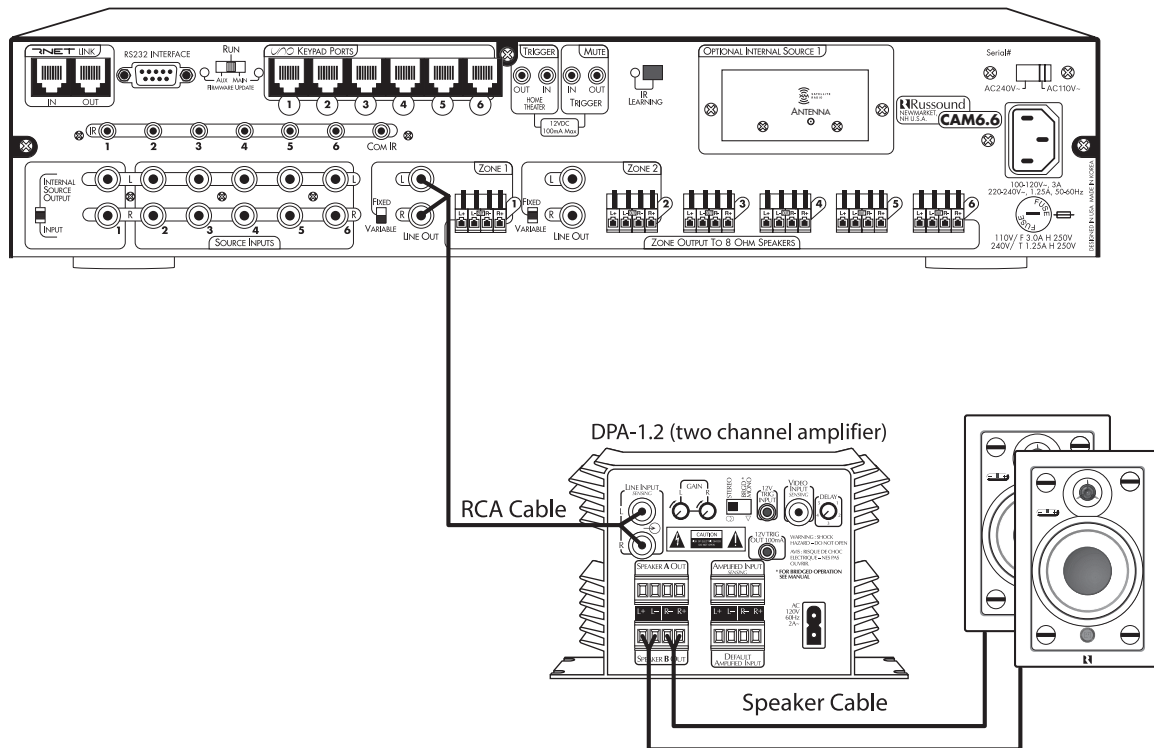



# INSTALLER MAKING CONNECTIONS

## 12VDC Home Theater Trigger In

This 12VDC Trigger input is used to control Power Management of the audio sources possibly being shared with a home theater system. When the last zone on the CAM6.6 is turned off, 12VDC presence to the trigger input will prevent the sources that are on from being turned off. The connections for the trigger are made using a two-conductor cable with 1/8" male mini-plug. The tip is positive (+) and the sleeve is negative (-).

## 12VDC Home Theater Trigger In/Out

### 12VDC 100mA Trigger Out

The 12VDC 100mA trigger out can be used to engage any 12VDC trigger device or component such as the Russound ACT-1 triggered outlet. The connections for the trigger out are made using a two-conductor cable with 1/8" male mini-plug jacks at each end. The tip is positive (+) and sleeve is negative (-).

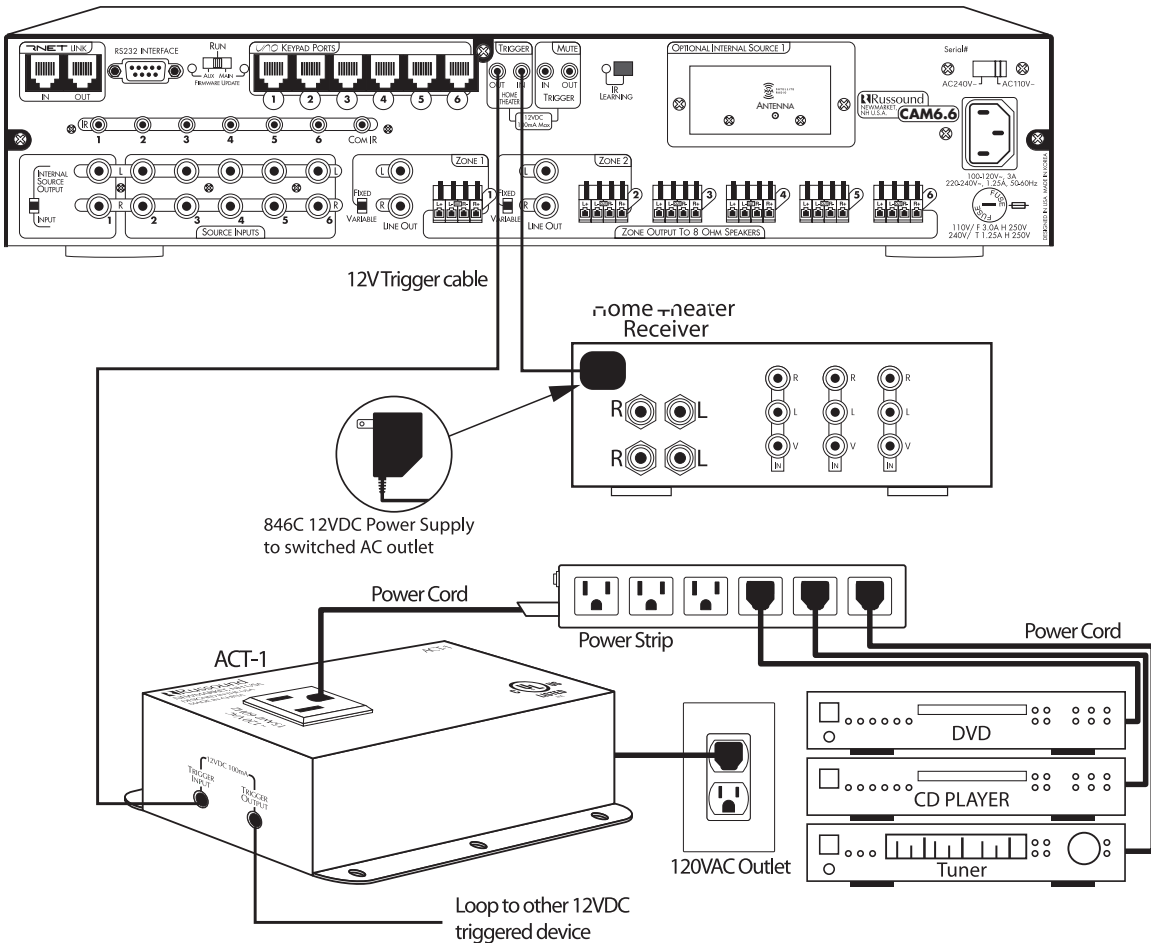

# INSTALLER

## MAKING CONNECTIONS

### 12VDC Mute Trigger In/Out

#### 12VDC Mute Trigger In

When 12VDC is applied to the Mute Trigger In, the system will fully mute any source connected to the Source Audio Input. The connections for the trigger are made using a two-conductor cable with 1/8" male mini-plug jacks. The tip is positive (+) and sleeve is negative (-). This allows for the connection of an external or muting device. The CAM6.6 can be programmed to mute audio for one or all zones as preferred when the 12VDC is applied.

#### 12VDC Mute Trigger Out

Mute Trigger Out 12VDC output is used for triggering an external amplifier, muting device or other component dependent on the Mute Trigger In 12VDC. The connections for the output are made using a two-conductor cable with 1/8" male mini-plug jacks at each end. The tip is positive (+) and sleeve is negative (-). The default setting for the Mute Trigger Out provides 12VDC whenever 12VDC is applied to the Mute Trigger In.

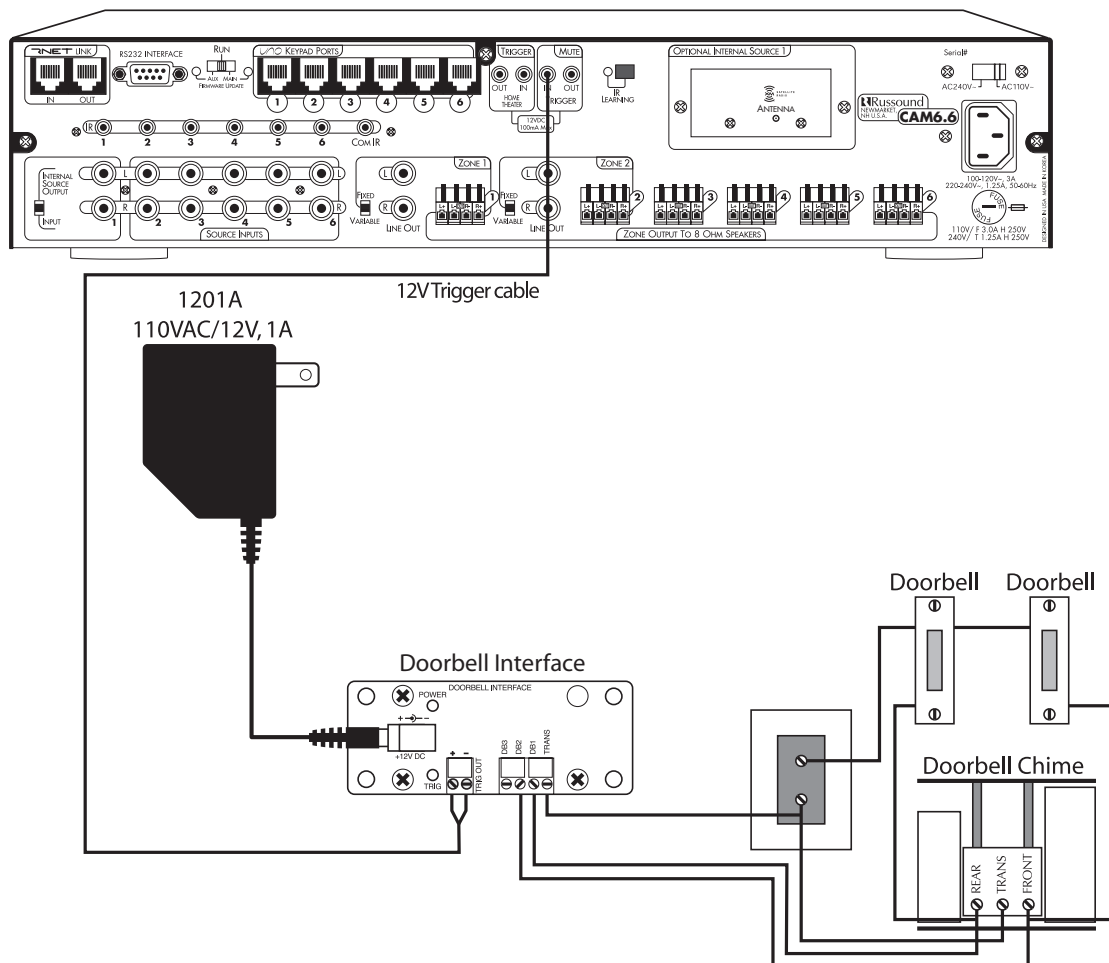

# INSTALLER MAKING CONNECTIONS

## RNET Link In and Link Out

The RNET Link In and Link Out is used to connect two or more CAM6.6 or CAV6.6 controllers. The connection is made using a CAT-5 patch cable from the Link Out of the master CAM6.6 and into the Link In of the next controller. Along with RNET data signals, the RNET Link In and Link Out jack passes the six source IR signals. These are only for source-specific IR remote repeating, not codes initiated from the controller's internal IR library. The CAT-5 patch cable should not exceed 18 inches in length to avoid potential cross-talk between the source-specific IR repeating signal lines.

The RNET Link In and Link Out is also used to connect the CAM6.6 to other Russound products with RNET.

*Note: If two or more CAM6.6 or CAV6.6 controllers will be connected using the RNET Link In and Link Out ports, each controller must have a unique Controller ID prior to being connected through the RNET ports. The Controller ID assignment must be performed during the Controller Setup section of the Installation menu.*

### RJ-45 CAT-5 Wiring Scheme

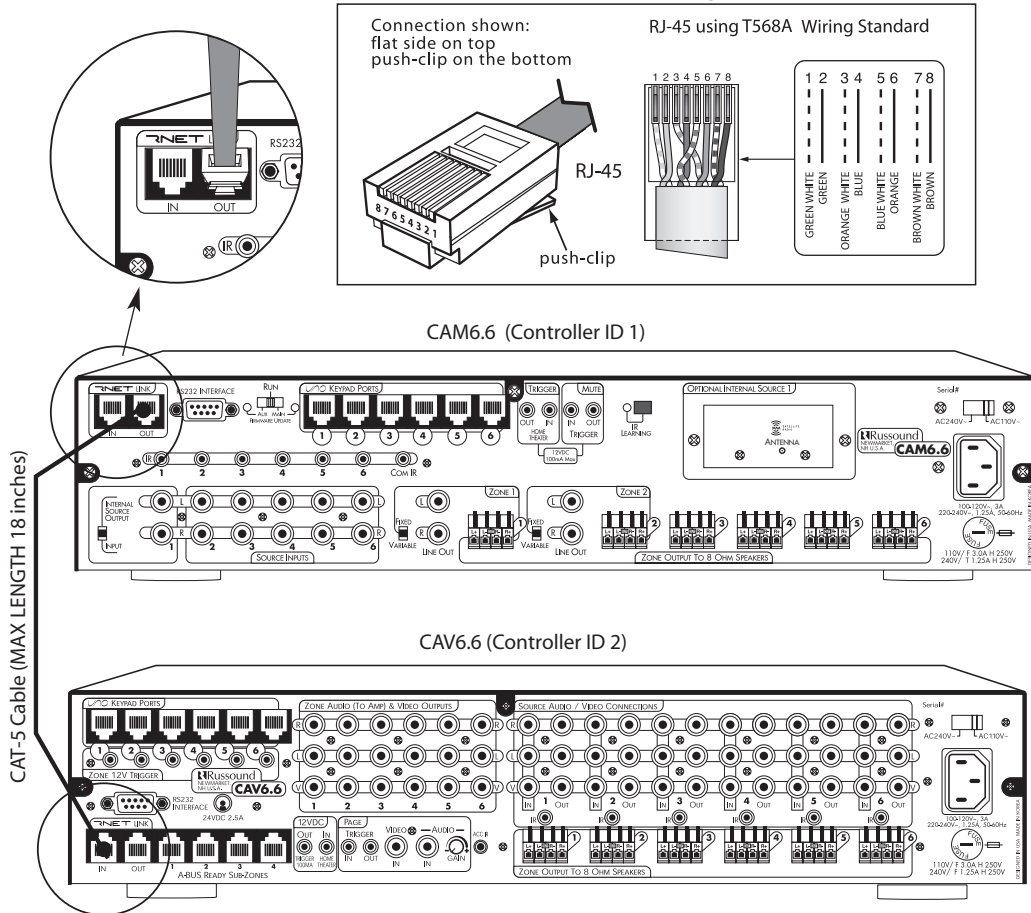

# INSTALLER

## MAKING CONNECTIONS

### RS-232 Interface

The CAM6.6 supports RS-232 communication with various third party automation systems or PC for programming of the controller. The RS-232 com port is located on the back of the CAM6.6 and uses a DB-9 cable connection. For

RS-232 protocol and the backup PC application, see the Document Center at [www.russound.com](http://www.russound.com). Look for the Technical Documents under Multi-source/Multi-room products.

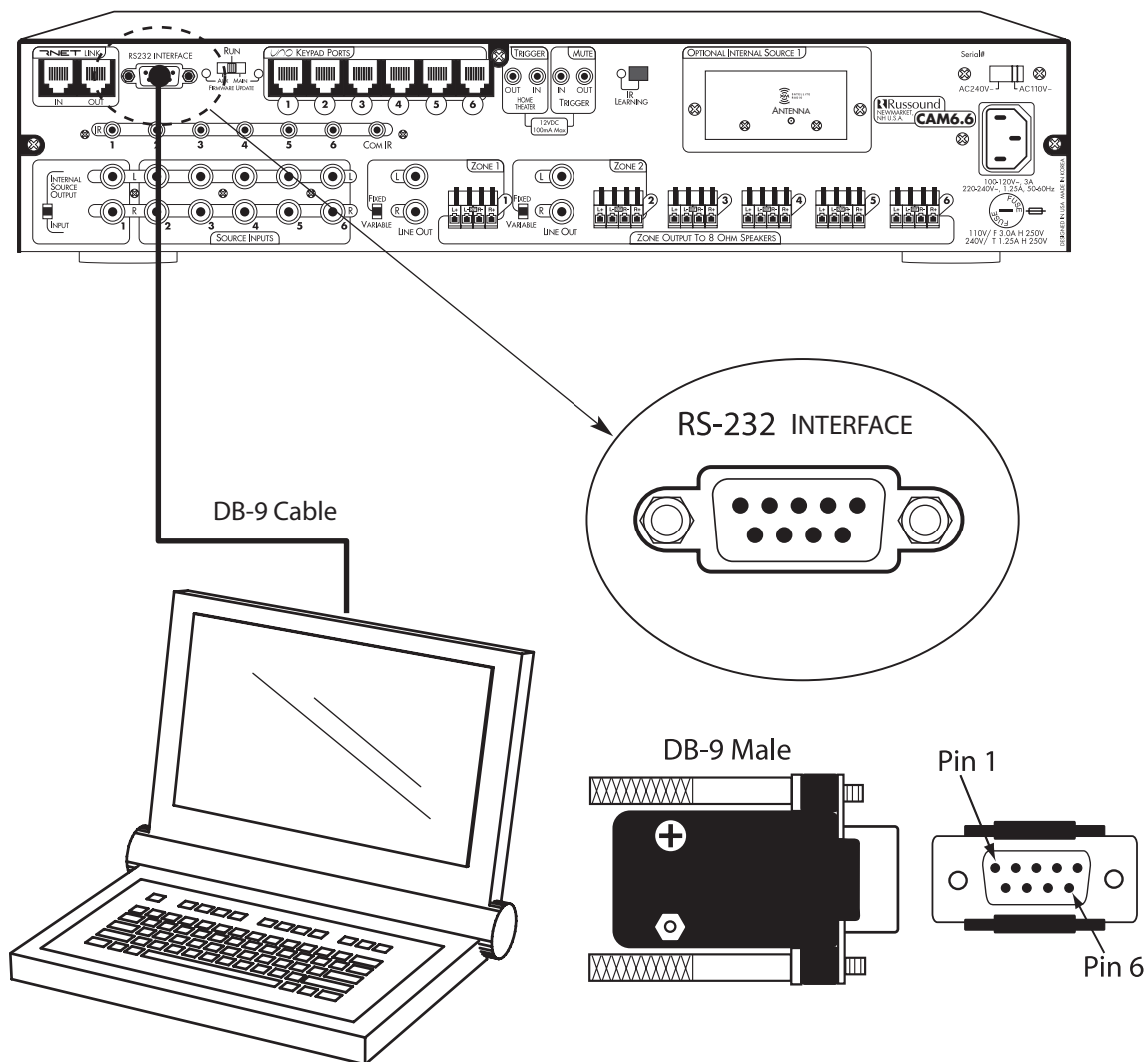

# INSTALLER MAKING CONNECTIONS

## Optional Internal Source - XM Tuner Antennas

### XM Antenna

Connect the included XM antenna for XM reception to the back panel of the XM module. The antenna comes with 20 feet of cable. If this length is not sufficient, there are aftermarket antenna kits available for custom lengths. Position the antenna near a south-facing window to receive the best signal from a satellite or terrestrial signal.

The antenna may also be attached to an external wall by sliding the slots on the back of the antenna onto four screws mounted on an exterior wall. Establish the best receiving position for the antenna before attaching it to the wall.

### XM Signal Strength Mode

To test the XM reception, turn the unit on. When the XM radio is powered for the first time, the XM service will start playing XM Channel 1, a preview/promotional channel. Verify that Channel 1 is playing by viewing the channel number on the keypad display. Enter Signal Strength Mode by pressing and holding the Stop button on the UNO-S2 keypad. The display shows one of the following:

**GOOD SIGNAL** Signal strength good  
**MARGINAL SIG** Signal strength marginal  
**POOR SIGNAL** Signal strength poor  
**NO SIGNAL** Loss of signal

Adjust the antenna until **GOOD SIGNAL** is displayed. Press Stop to exit Signal Strength Mode.

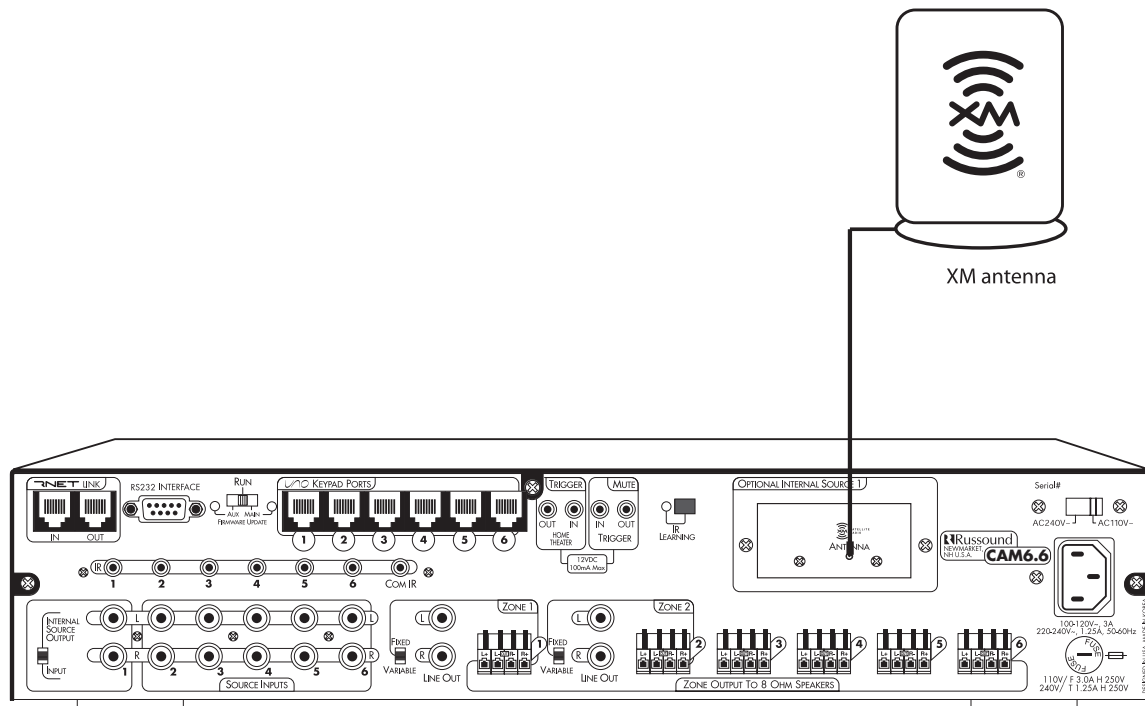

# **R** INSTALLER INITIAL INSTALL TEST

Before proceeding to the system programming section, it's important to conduct an initial test to determine that the hardware components are working properly.

- 1.** Connect the speaker wires from Zone #3 to the CAM6.6 Zone #3 speaker output connectors.
- 2.** Connect an UNO-S1 or UNO-S2 keypad to Keypad Port #3 on the rear of the CAM6.6.
- 3.** Connect a source to the Source #3 Input on the CAM6.6 using RCA Audio patch cables.
- 4.** Plug a supplied 845.1 IR emitter into the Source #3 IR Output Jack and adhere the emitter end to the source equipment's IR window.
- 5.** Plug in the main power cords for the CAM6.6 and the source.
- 6.** Turn on the main power switch on the CAM6.6 and the source.
- 7.** Manually command the source to provide audio or use the source remote control.
- 8.** Press the power button on the UNO-S1 or UNO-S2 keypad and select Source #3.

Congratulations – you should now hear the source through the speakers in Zone #3.

If there is no sound, follow these diagnostic steps:

- 1.** Check the source to see that it is operating properly.
- 2.** Check the RCA Audio cable connections from the source to the Source #3 Input on the CAM6.6.
- 3.** Check the speaker connections and verify that they are correct and are connected to the Zone #3 speaker outputs.
- 4.** Check to see that the keypad is connected to the Zone #3 Keypad Port and verify the CAT-5 is properly terminated at both ends.

If none of these steps produce successful results, call Russound Tech Support for further assistance.

# INSTALLER

## SYSTEM PROGRAMMING OVERVIEW

This manual includes items that are designed to assist in the programming process.

### **Forms (Pages 49-51)**

Three blank reproducible forms are included as planning tools when determining sources, settings and zone preferences. The Source and Zone Information forms and the Macro Editor form should be completed before programming, and referred to during the Installation Menu process. This speeds up programming time and reduces missed or incorrect entries. These forms also serve as system reference documents if future troubleshooting is needed.

### **IR Device Codes (Pages 80-82)**

This list of command type IR device codes reflects the built-in IR codes in the CAM6.6 library. During programming, these codes will be entered for each source at the "Device Code" prompt. If a code is not listed for a source, the Learn IR procedure is available to learn in and centrally store IR codes. *(Note: Device codes for Phono, DAT and Tape are Learned Only)*

### **Key Functions (Pages 83-104)**

This list of key functions identifies what IR codes are supported for each command type (source) by the built-in library. "Learned Only" indicates that this function is not supported and must be learned into the CAM6.6. This list of key functions reflects the different available key functions associated with what you see on the LCD panel when performing the Key Configuration procedure in the Installation Menu. The list of functions corresponds with the command types above (e.g., Tuner, CD player, etc.).

### **Source Names (Pages 105-106)**

A list of assignable Source Names is provided for advance selection and source form completion before programming.

### **Flow Charts (Pages 67-79)**

Installation Menu flow charts provide a graphical representation of the programming process.

### **Installation Menu (Pages 52-66)**

The Installation Menu provides the step-by-step complete programming procedure for the keypad and the controller.

Although you can begin programming at any point within the Installation Menu, the following sequence is recommended for initial installations, as it progresses from the most basic requirements to the more advanced features.

#### **1. Controller Setup (CTRLR SETUP) (Page 62)**

This procedure sets the controller ID number within the system. This number must be manually set when multiple CAM6.6's are linked through RNET within one system. This procedure is not necessary for systems with only one CAM6.6.

#### **2. Number of Sources (# of Sources/SOURCE SETUP) (Page 61)**

This procedure sets the number of sources used in the system. This prevents the user from selecting a source input that is not used.

# INSTALLER

## SYSTEM PROGRAMMING OVERVIEW

### **3. Basic Setup (SOURCE SETUP) (Pages 55-56)**

This procedure is mandatory to set up each source for keypad source control and is the cornerstone of the programming process.

### **4. Peripheral Setup (Pages 53-55) (FOR OPTIONAL INTERNAL SOURCE)**

This procedure provides setup and naming procedures for the XM tuner. It includes assigning a custom name to a memory preset or bank.

### **5. Learn IR (Page 64-65)**

This procedure is used when the source-specific IR code is not found in the built-in IR code library. This allows IR commands to be learned into the system and centrally stored.

### **6. Macro Editor (Page 65-66)**

This procedure compiles multiple IR keycodes to be initiated by a single button press. One macro can have up to 10 commands, including other macros, and up to 132 macros can be entered.

### **7. Source Volume Trim (SOURCE SETUP) (Page 58)**

This procedure matches audio output signals for all sources for seamless switching.

### **8. Numeric IR (SOURCE SETUP) (Pages 58-60)**

This procedure sets up control of a source that supports direct numeric commands.

### **9. Key Configuration (SOURCE SETUP) (Pages 57-58)**

This procedure customizes individual key functions on a per-zone basis for source control.

### **10. Power Management (Pages 62-64)**

This function incorporates IR macro commands to automatically control the power state of the sources when the system is in use or when a home theater is sharing sources.

### **11. Zone Volume Trim (ZONE SETUP) (Page 61)**

This procedure limits the maximum volume allowed in a zone, regardless of keypad volume adjustment.

### **12. System On Enable (SYSON ENABLE/ZONE SETUP) (Page 61)**

This feature allows a zone to join or opt out of an "all on" command.

### **13. Party Enable (ZONE SETUP) (Page 62)**

This feature allows a zone to join or opt out of Party Mode participation.

### **14. Master Enable (ZONE SETUP) (Page 62)**

This feature allows a zone the option of becoming a Master keypad in Party Mode.

### **15. Mute Enable (ZONE SETUP) (Page 62)**

This feature enables a zone to allow or to mute audio.



## Source Information Form

	Source 1	Source 2	Source 3	Source 4	Source 5	Source 6
Source Name	<XM>					
Manufacturer	Russound					
Model #	N/A					
IR Command Type *	Peripheral					
IR Device Code (learned or 4-digit)	N/A					
Numeric IR (Y or N)	N					
Highest Number	N/A					
Auto Play (Y or N)	N					
Source Volume Trim (dB) -16dB<0dB						
Source Select Command						
Power Mgmt Power On Command	N/A					
Power Off Command	N/A					

\* IR Command Type, e.g., Cable, DVD, Tuner, CD, etc.

## Zone Information Form

Zone Number	Zone Name	Zone Volume Trim -16dB <-> 0dB	System On Enable	Party Mode Enable	Master Keypad Enable	Mute Enable
<b>1</b>			Y N	Y N	Y N	Y N
<b>2</b>			Y N	Y N	Y N	Y N
<b>3</b>			Y N	Y N	Y N	Y N
<b>4</b>			Y N	Y N	Y N	Y N
<b>5</b>			Y N	Y N	Y N	Y N
<b>6</b>			Y N	Y N	Y N	Y N

(Default setting is bolded)

*Macro Editor Form*

Macro ID Number		Macro ID Number	
Macro Name		Macro Name	
Command 1		Command 1	
Command 2		Command 2	
Command 3		Command 3	
Command 4		Command 4	
Command 5		Command 5	
Command 6		Command 6	
Command 7		Command 7	
Command 8		Command 8	
Command 9		Command 9	
Command 10		Command 10	

# INSTALLER

## INSTALLATION MENU OVERVIEW

There are three item types in the installation menu:

**Menu Item (m)** – Acts as a folder that holds procedures and/or feature parameters.

**Procedure (p)** – A sequence of feature parameters to perform a guided operation, such as configuring an UNO key. Once you begin a procedure, the system will prompt for the needed information to complete the task.

**Feature (f)** – The actual parameters (settings) that will change the system configuration.

The following keys on the **UNO-S2** keypad are used to navigate and make changes while using the installation menus:

 To enter the Installation Menu, press and release the Setup Button (located on the keypad's right side) while in normal operating mode. The Setup Button is used to “back out” of the Installation Menu one level at a time. If you are performing a procedure, the Setup Button brings you back to the beginning of the procedure. Once you have reached the top level of the Installation Menu, pressing the Setup Button brings you back to normal operating mode.

 *Adjust feature setting (increment).*

 *Adjust feature setting (decrement).*

 *Go to next menu / procedure / feature.* Not available while performing a procedure.

 *Go to previous menu / procedure / feature.* Not available while performing a procedure.

 *Enter menu / begin procedure / show current feature setting.* While performing a procedure, it is also used to advance to the next sequential feature setting once the current feature has been viewed or adjusted.

### UNO-S1 Keypad Five-Character Display

The UNO-S1 keypad abbreviates information as necessary to appear in its five-character display. In the following menu procedures, the UNO-S1 five-character abbreviation is shown in parentheses underneath the 12-character version.

# INSTALLER INSTALLATION MENU

The following items make up the Installation Menu:

PERIPH SETUP (PerSu) Ⓜ SOURCE SETUP (SrcSu) Ⓜ ZONE SETUP (ZonSu) Ⓜ  
CTRLR SETUP (CtlSu) Ⓜ POWER MGT (PwMgt) Ⓜ LEARN IR (LrnIR) Ⓜ  
MACRO EDITOR (MacEd) Ⓜ SYSTEM INFO (SInfo) Ⓜ

## **PERIPH SETUP (PerSu)**

Peripheral Setup allows the CAM6.6's optional internal source to be configured.

The following items can be found in the PERIPH SETUP menu:

MEM NAME (MemNm) Ⓜ BANK NAME (BnkNm) Ⓜ CONTROLLER ID (CtlId) Ⓜ DIAGNOS-  
TICS (Diags) Ⓜ FACTORY INIT (FInit) Ⓜ SYSTEM INFO (SInfo) Ⓜ

### **MEM NAME (MemNm)**

*NOTE: A memory preset must be created and saved before it can be named. Once it is saved, the preset's Tuner #, Bank # and Memory # must be entered in the following procedure.*

This procedure accesses a name entry field to enter a custom name for a memory preset. **See Periph Setup - Flow Chart page 67**

- 1. BANK # –** (Bank#) Select the BANK # of the memory preset.
- 2. MEMORY # –** (Mem #) Select the MEMORY # of the preset to be named.
- 3. MEMORY NAME –** (MemNm) Use the up/down keys to select a character and left/right keys to change a character position. A blinking cursor indicates the placement of the character being entered. Names can be from 1 to 12 characters in length.

### **BANK NAME (BnkNm)**

This procedure accesses a name entry field to enter a custom name for each of the tuner's six banks. **See Periph Setup - Flow Chart page 67**

- 1. BANK # –** (Bank#) Select the BANK # of the memory preset.

# INSTALLER INSTALLATION MENU

- 2. BANK NAME –** (BnkNm) Use the up/down keys to select a character and left/right keys to change a character position. A blinking cursor indicates the placement of the character being entered. Names can be from 1 to 12 characters in length.

## **CONTROLLER ID (Ctlld)**

This procedure is used to identify the controller(s) that the tuner will respond to. **See Periph Setup - Flow Chart page 68**

- 1. Controller:# –** (Ctlld) Select controller ID of controller that will control tuner.
- 2. All controllers –** (All) Select if all controllers in system can control the tuner.

## **DIAGNOSTICS (Diags)**

This procedure is for factory use only. **See Periph Setup - Flow Chart page 68**

## **FACTORY INIT (Flnit)**

*NOTE: This procedure returns the tuner to its factory settings and erases all user settings.*

This procedure allows the erasure of all programmed settings and returns them to the factory default settings. **See Periph Setup - Flow Chart 68**

- 1. Are you sure? –** (Sure?) Confirmation of YES or NO is required to proceed. A NO selection returns to the top of the Factory Initialization menu. A YES selection begins the initialization.
- 2. Please Wait –** Message shows during the initialization process.
- 3. Cycle Power –** When initialization is complete, cycle power to the unit.

## **SYSTEM INFO (SInfo)**

System Info shows the tuner's manufacturing build properties. **See Periph Setup - Flow Chart 68**

**BUILD TIME (BTime)** (▶) **BUILD DATE (BDate)** (▶) **VERSION (Ver)** (▶)

# INSTALLER INSTALLATION MENU

- 1. BUILD TIME**  
(BTime) Displays the firmware Build Time of the tuner.
- 2. BUILD DATE**  
(BDate) Displays the firmware Build Date of the tuner.
- 3. VERSION**  
(Ver) Displays the firmware version of the tuner.

## **SOURCE SETUP (SrcSu)**

Source Setup allows the system's sources to be configured.

The following items can be found in the SOURCE SETUP menu:

- BASIC SETUP (BasSu)** (▶) **KEY CONFIG (KeyCf)** (▶) **SOURCE NAMES (SrcNm)** (▶)
- SRC VOL TRIM (SrcVT)** (▶) **NUMERIC IR (NumIR)** (▶) **SRC SEL CMD (SrcSC)** (▶)
- # OF SOURCES (#Srcs)** (▶)

### **BASIC SETUP (BasSu)**

*NOTE: The BASIC SETUP procedure should be performed for each source before proceeding to other source setting changes.*

*NOTE: If the CAM6.6 has an optional internal source installed, it is pre-configured as Source 1, with source name <XM> and command type Peripheral.*

This procedure uses built-in source "templates" to quickly and easily configure the source settings needed for basic operation of the source component. Before performing BASIC SETUP, connect the source components to the CAM6.6 as outlined in the Source Connections section. Also be sure that all sources are powered on. **See Basic Setup - Flow Chart 69**

- 1. SOURCE NUM** –  
(Src #) Select the source to be configured.
- 2. SOURCE NAME** –  
(Name) Select the name for the source (e.g., DVD, Aux 2, Jazz, etc.).
- 3. COMMAND TYPE** –  
(CmdTp) Select the type of command template (e.g., CD, TV, etc.). Selecting the command type template will tell the CAM6.6 how to configure the key's command and text for the source component.

# INSTALLER

## INSTALLATION MENU

- a. Selected: Learned IR**  
(LrnIR)
- i. LEARNED SRC –**  
(LnSrc)
- ii. TEMPLATE TYP –**  
(TType)
- b. Selected: Unassigned**  
(Unasg)
- c. All Other Selections:**
- 4. DEVICE CODE –**  
(DevCd)
- 5. TEST IR? –**  
(TstIR)
- 6. SUCCESS? –**  
(OK?)
- 7. USE NUM IR? –**  
(NumIR)
- 8. HIGHEST NUM –**  
(High#)
- 9. AUTO PLAY? –**  
(AtoPI)
- 10. SAVE CHANGES? –**  
(Save?)
- Choose Learned IR if the pre-programmed IR code library does not support the source component.
- Select the learned source bank to be assigned to the source component. (See Learning IR procedure for instructions on how to learn IR codes.)
- Select the template type to define what type of source component is being used. (This will tell the CAM6.6 how to configure the key commands and text for the source component if it is a learned source.) Procedure advances to USE NUM IR? (step 7).
- The template for the selected source is cleared. (All key assignments and other source settings will be erased.) Procedure advances to SAVE CHANGES (step 10)
- Procedure advances to DEVICE CODE (step 4)
- Enter source component code number listed in this manual's Reference section.
- If "Yes" is selected, the CAM6.6 sends a power command to the source component. If "No" is selected, the procedure advances to USE NUM IR? (step 7)
- If the power to the source component was turned off, select "Yes" otherwise select "No." By selecting "No" the Procedure returns to DEVICE CODE (step 4) to allow selection of another code number from the provided list.
- Indicates the source component has numeric scrolling, such as multi-disc CD player (See NUMERIC IR Setup Procedure for advanced settings or more information). "No" advances menu to AUTO PLAY (step 9).
- Enter the highest possible number; for example, a 100-disc CD player would have a max number of 100.
- "Yes" tells the CAM6.6 to issue a PLAY command whenever the source is selected for listening. This option is skipped if the source type (COMMAND TYPE) chosen does not have a PLAY command associated with it.
- Select "yes" to save changes. Procedure returns to SOURCE NUM to allow configuration of another source.



## **KEY CONFIG (KeyCf)**

Key Configuration defines zone-specific key functions for each source. **See Key Config. - Flow Chart page 70**

- |   |   |
|---|---|
| <b>1. ZONE NUM</b> –<br>(Zone#)             | Select the zone the key will be configured for. Changes are made for that zone only; default setting is “All Zones.”              |
| <b>2. SOURCE NUM</b> –<br>(Src #)           | Select the source the key will be configured for.   |
| <b>3. SELECT A KEY</b> –<br>(SelKy)         | Using ⊕ or ⊖, select the keypad key to be configured.   |
| <b>4. KEY TYPE</b> –<br>(KeyTp)             | Either “Key Press,” “Key Hold” or “Both” will activate the command.   |
| <b>5. KEY NAME</b> –<br>(KeyNm)             | Name that appears on the keypad display when the command is activated.  |
| <b>6. COMMAND TYPE</b> –<br>(CmdTp)         | Select the type of source command (e.g., CD, TV, etc.).   |
| <b>a. Selected: Learned IR</b> –<br>(LrnIR) | Choose Learned IR if the pre-programmed IR code library does not support the source component.                                    |
| <b>i. LEARNED SRC</b> –<br>(LnSrc)          | Select the learned source bank to be assigned to the source component. Procedure advances to KEY FUNCTION (step 8)                |
| <b>b. Selected: Unassigned</b><br>(Unasg)   | The key configuration is cleared. Procedure advances to SAVE CHANGES (step 9)   |
| <b>c. Selected: Default</b><br>(Deflt)      | Default selects the same device type and device code previously setup in BASIC SETUP. Procedure advances to KEY FUNCTION (step 8) |
| <b>d. Selected: Macro:</b>                  | <b>(To build macros, see Macro Editor page 65)</b>  |
| <b>i. MACRO</b> -<br>(Macro)                | Macro loads a series of commands which are processed when activated.  |
| <b>ii. MACRO ID</b> –<br>(MacID)            | Enter the macro ID number. Menu advances to SAVE CHANGES (step 9)   |
| <b>e. All Other Selections:</b>             | Procedure advances to DEVICE CODE (step 7)  |
| <b>7. DEVICE CODE</b> –<br>(DevCd)          | Enter source component code number listed in this manual’s Reference section.   |
| <b>8. KEY FUNCTION</b> –<br>(KeyFn)         | Select a function for the button.   |

# INSTALLER

## INSTALLATION MENU

- 9. SAVE CHANGES? –** Select “yes” to save changes. Procedure advances to ZONE NUM  
(Save?) (step 1)

### **SOURCE NAMES (SrcNm)**

This procedure allows the installer to customize the source names for the sources attached to the CAM6.6. **See Source Names/Vol Trim - Flow Chart page 71**

- 1. SOURCE NUM –** Select the source number this name will be assigned to.  
(Src #)
- 2. SOURCE NAME –** Select the name. SOURCE NUM will reappear on the LCD panel;  
(Name) repeat the instructions for each source to be labeled.

### **SRC VOL TRIM (SrcVT)**

This procedure allows the installer to adjust the output level of an individual source. The output volume is adjustable by 16dB. At 0dB (-3dB default setting), the volume is at max output; at -16dB the volume is at the lowest setting possible for that source only. **See Source Names/Vol Trim - Flow Chart page 71**

- 1. SOURCE NUM –** Select the source number this level will be set for.  
(Src #)
- 2. TRIM LEVEL –** 0 dB is max output volume, -16 dB is lowest setting.  
(Trim)

### **NUMERIC IR (NumIR)**

Numeric IR allows the installer to program source specific number functions (Channel 12, Disk 89, etc.). **See Numeric IR - Flow Chart page 72**

- 1. SOURCE NUM –** Select the source number this function will be configured for.  
(Src #)
- 2. USE NUM IR? –** Tells the system whether the source component has numeric  
(NumIR) scrolling, such as 100-disc CD player. A selection of “no” disables Numeric IR and advances to SAVE CHANGES
- 3. HIGHEST NUM –** Enter the highest possible number; for example, the 100-disc CD  
(High#) player would have a max number of 100.

# INSTALLER INSTALLATION MENU

- 4. NUMERIC TEXT –**  
(NmTxt) Select Numeric descriptive text.
- 5. PREFIX CMD –**  
(Prefix) Tells the system whether a command will be issued prior to the selection of the numerical value (e.g., *Disc 1,2*). If “no,” procedure advances to SUFFIX CMD (step 9)
- 6. COMMAND TYPE –**  
(CmdTp) Select the type of command (e.g., CD, TV, etc.).
- a. Selected: Learned IR**  
(LrnIR) Choose Learned IR if the pre-programmed IR code library does not support the source component.
  - i. LEARNED SRC –**  
(LnSrc) Select the learned source bank to be assigned to the source component. Procedure advances to KEY FUNCTION (step 8)
    - b. Selected: Unassigned**  
(Unasg) The numeric IR Prefix command is cleared. Procedure advances to SUFFIX CMD (step 9)
    - c. Selected: Default**  
(Deflt) Default selects the same device type and device code previously setup in BASIC SETUP. Procedure advances to KEY FUNCTION (step 8)
    - d. Selected: Macro:**  
      - i. MACRO -**  
(Macro) **(To build macros, see Macro Editor page 65)**  
Macro loads a series of commands which are processed when activated.
      - ii. MACRO ID –**  
(MacID) Enter the macro ID number. Menu advances to SUFFIX CMD (step 9)
    - e. All Other Selections:**  
Procedure advances to DEVICE CODE (step 7)
- 7. DEVICE CODE –**  
(DevCd) Source component code for IR control.
- 8. KEY FUNCTION –**  
(KeyFn) Select a function (Disc, etc.).
- 9. SUFFIX CMD –**  
(Suffix) Tells the system whether a command will be issued after the selection of the numerical value (e.g., *1, 2 Enter*). If “no,” procedure advances to SAVE CHANGES (step 13)
- 10. COMMAND TYPE –**  
(CmdTp) Select the type of source command (e.g., CD, TV, etc.).
- a. Selected: Learned IR**  
(LrnIR) Choose Learned IR if the pre-programmed IR code library does not support the source component.

# INSTALLER

## INSTALLATION MENU

- i. **LEARNED SRC** – (LnSrc) Select the learned source bank to be assigned to the source component. Procedure advances to KEY FUNCTION (step 12)
  - b. **Selected: Unassigned** (Unasg) The numeric IR Suffix command is cleared. Procedure advances to SOURCE NUM (step 1)
  - c. **Selected: Default** (Deflt) Default selects the same device type and device code previously setup in BASIC SETUP. Procedure advances to KEY FUNCTION (step 12)
  - d. **Selected: Macro:**
    - i. **MACRO** - (Macro) **(To build macros, see Macro Editor page 65)** Macro loads a series of commands which are processed when activated.
    - ii. **MACRO ID** – (MacID) Enter the macro ID number. Menu advances to SAVE CHANGES (step 13)
  - e. **All Other Selections:** Procedure advances to DEVICE CODE (step 11)
- 11. **DEVICE CODE** – (DevCd) Source component code for IR control.
- 12. **KEY FUNCTION** – (KeyFn) Select a function (Enter, Play, etc.).
- 13. **SAVE CHANGES?** – (Save?) Select “yes” to save the changes.

### SRC SEL CMD (SrcSC)

This procedure permits a command to be sent to the source component when the source component is initially selected. **See Source Select Command & # Of Sources - Flow Chart page 73**

- 1. **SOURCE NUM** – (Src #) Select the source number this command will be configured for.
- 2. **COMMAND TYPE** – (CmdTp) Select the type of source command (e.g., CD, TV, etc.).
  - a. **Selected: Learned IR** (LrnIR) Choose Learned IR if the pre-programmed IR code library does not support the source component.
    - i. **LEARNED SRC** – (LnSrc) Select the learned source bank to be assigned to the source component. Procedure advances to KEY FUNCTION (step 4)
    - b. **Selected: Unassigned** (Unasg) The source select command is cleared. Procedure advances to SAVE CHANGES (step 5)

# INSTALLER INSTALLATION MENU

- c. **Selected: Default**  
(Deflt) Default selects the same device type and device code previously setup in BASIC SETUP. Procedure advances to KEY FUNCTION (step 4)
- d. **Selected: Macro:**  
  - i. **MACRO** -  
(Macro) **(To build macros, see Macro Editor page 65)**  
Macro loads a series of commands which are processed when activated.
  - ii. **MACRO ID** -  
(MacID) Enter the macro ID number. Menu advances to SAVE CHANGES (step 5)
- e. **All Other Selections:** Procedure advances to DEVICE CODE (step 3)
- 3. **DEVICE CODE** -  
(DevCd) Source component code for IR control.
- 4. **KEY FUNCTION** -  
(KeyFn) Select a function (Play, Enter, etc.).
- 5. **SAVE CHANGES?** -  
(Save?) Select "yes" to save the changes.

## **# OF SOURCES (#Srcs)**

At this field it is necessary to enter the number of sources used in the CAM6.6 system (1 to 6). This limits the sources displayed on the keypad in the normal running mode when the source button is pressed, but also limits source selections in the configuration menus. **See Source Select Command & # Of Sources - Flow Chart page 73**

## **ZONE SETUP (ZonSu)**

NOTE: This procedure should be performed using the keypad installed in the zone to be configured. **See Zone Setup - Flow Chart page 74**

Zone Setup allows the installer to adjust properties of the UNO Keypad controlled CAM6.6 zone. This series of menus allows the system's zones to be configured for these properties:

**ZON VOL TRIM (ZonVT) (▶) SYSON ENABLE (SysOn) (▶) PARTY ENABLE (PtyEn) (▶)**  
**MASTER ENABL (MstEn) (▶) MUTE ENABLE (MutEn) (▶)**

- 1. **ZON VOL TRIM** -  
(ZonVT) This feature allows the installer to adjust the output volume to each zone. -16 dB (lowest) to 0 dB (max)(-3dB default).
- 2. **SYSON ENABLE** -  
(SysOn) This feature is either disabled or enabled. If disabled (default), an All On command activated from another zone will not turn on the

# INSTALLER INSTALLATION MENU

disabled zone. If enabled, an All On command activated from another zone will turn on the enabled zone.

- 3. PARTY ENABLE -**  
(PtyEn)

This feature is either disabled or enabled. If disabled, Party Mode activation from another zone will not affect the disabled zone. If enabled (default), the zone will participate with Party Mode.
- 4. MASTER ENABLE -**  
(MstEn)

This feature is either disabled or enabled. If disabled, the zone cannot host a master keypad during Party Mode. If enabled (default), the zone has the option of hosting the Master keypad.
- 5. MUTE ENABLE -**  
(MutEn)

This feature is either disabled or enabled. It allows the option of enabling or disabling muting in a zone. If disabled, the zone will not mute. If enabled (default), the zone will be muted when a mute signal is received.

## **CTRLR SETUP (Ctld)**

Controller Setup is the basic configuration of the controller. This setup menu selects the options for Controller ID and Factory Initialization. **See *Controller Setup - Flow Chart page 75***

- 1. CONTROLLER ID -**  
(Ctld)

This defines the Controller ID for this system. The default is 1 but when multiple controllers are used, each additional controller ID must be sequential and unique and be set before being connected to the system. Note that the system must be restarted before the controller will assume the new ID.
- 2. FACTORY INIT -**  
(Flnit)

**WARNING: This procedure returns the controller to its original settings - use with discretion.**

Factory Initialization allows the installer to erase all programmed settings and returns the settings to the factory default settings. All settings including source equipment IR commands will need to be reentered. An “Are you sure?” prompt and a “no” response allows the installer to cancel the reset; a “yes” at the prompt will load factory/default settings.

## **POWER MANAGEMENT (PwMgt)**

The CAM6.6 is capable of managing the power state of the connected source equipment. The power management is configured on a source-by-source basis.

# INSTALLER INSTALLATION MENU

All sources that have power management enabled are initialized by a “POWER ON” command/ macro. Power management is initialized when the first keypad is turned on or when the home theater trigger input has 12VDC present. The 12VDC trigger output is turned on when the first zone is turned on.

All sources that have power management enabled are turned off by the “POWER OFF” command after all zones have been turned off, with a timeout of five minutes. The 12VDC trigger output is turned off one minute after that. This timeout is postponed for as long as the home theater trigger input has 12VDC present. **See Power Management - Flow Chart page 76**

- 1. SOURCE NUM –** (Src #) Select the source number this feature will be configured for.
- 2. POWER ON CMD –** (OnCmd) Tells the controller to turn on the selected source equipment (by SOURCE NUMBER) when any of the UNO System Keypads is turned on. If “no,” procedure advances to POWER OFF CMD (step 6)
- 3. COMMAND TYPE –** (CmdTp) Select the type of source command (e.g., CD, TV, etc.).
  - a. Selected: Learned IR** (LrnIR) Choose Learned IR if the pre-programmed IR code library does not support the source component.
    - i. LEARNED SRC –** (LnSrc) Select the learned source bank to be assigned to the source component. Procedure advances to KEY FUNCTION (step 5)
    - b. Selected: Unassigned** (Unasg) The Power On command is cleared. Procedure advances to POWER OFF CMD (step 6)
    - c. Selected: Default** (Deflt) Default selects the same device type and device code previously setup in BASIC SETUP. Procedure advances to KEY FUNCTION (step 5)
    - d. Selected: Macro:**
      - i. MACRO -** (Macro) **(To build macros, see Macro Editor page 65)** Macro loads a series of commands which are processed when activated.
      - ii. MACRO ID –** (MacID) Enter the macro ID number. Menu advances to POWER OFF CMD (step 6)
    - e. All Other Selections:** Procedure advances to DEVICE CODE (step 4)
  - 4. DEVICE CODE –** (DevCd) Source component code for IR control.
  - 5. KEY FUNCTION –** (KeyFn) Select a function (Play, Enter, etc.).

# INSTALLER INSTALLATION MENU

- 6. POWER OFF CMD –** (OfCmd) Tells the controller to turn off the selected source equipment (by SOURCE NUMBER) when the last of the UNO System Keypads is turned off. If “no,” procedure advances to SAVE CHANGES (step 10)
- 7. COMMAND TYPE –** (CmdTp) Select the type of source command (e.g., CD, TV, etc.).
- a. Selected: Learned IR** (LrnIR) Choose Learned IR if the pre-programmed IR code library does not support the source component.
  - i. LEARNED SRC –** (LnSrc) Select the learned source bank to be assigned to the source component. Procedure advances to KEY FUNCTION (step 9)
  - b. Selected: Unassigned** (Unasg) The Power Off command is cleared. Procedure advances to SAVE CHANGES (step 10)
  - c. Selected: Default** (Deflt) Default selects the same device type and device code previously setup in BASIC SETUP. Procedure advances to KEY FUNCTION (step 9)
  - d. Selected: Macro:**
    - i. MACRO –** (Macro) **(To build macros, see Macro Editor page 65)** Macro loads a series of commands which are processed when activated.
    - ii. MACRO ID –** (MacID) Enter the macro ID number. Menu advances to SAVE CHANGES (step 10)
  - e. All Other Selections:** Procedure advances to DEVICE CODE (step 8)
- 8. DEVICE CODE –** (DevCd) Source component code for IR control.
- 9. KEY FUNCTION –** (KeyFn) Select Keypad function.
- 10. SAVE CHANGES? –** (Save?) Select “yes” to save the changes.

## LEARN IR (LrnIR)

This procedure allows IR commands to be learned into the system and be centrally stored in the main controller to let the system access the same IR codes that operate the source equipment.

NOTE: IR codes must be learned in by pointing the remote at the CAM6.6's REAR panel IR receiver only. **See Learn IR - Flow Chart page 77**

- 1. LEARNED SRC –** (LnSrc) Select the source (Source 1-6 and Miscellaneous Learned IR (Misc)) whose commands will be learned into the controller.



# INSTALLER INSTALLATION MENU

- 2. KEY FUNCTION –**  
(KeyFn) Select the function to be learned or deleted.
- 3. LEARN/DELETE –**  
(Ln/Dl) Select Learn IR Now or Delete IR. If Learn IR Now, a “USE REMOTE” prompt appears. Point the learning remote at the controller’s IR window. If Delete IR, procedure returns to LEARNED SRC (step 1)
- 4. TEST IR? –**  
(TstIR) If “yes,” sends the learned command to the source component to test the IR. If the component responds, the IR test was a success. If the component does not respond the Code was not learned properly. If “no,” menu goes back to LEARNED SRC (step 1)
- 5. SUCCESS? -**  
(OK?) Asks if the IR test was a success  
  
IF YES - If the test was a success, specify “yes” and proceed to KEY FUNCTION (step 2)  
IF NO - If the test was a failure, specify “no” and LEARN/DELETE (step 3) reappears on the display allowing another code to be learned in.

## MACRO EDITOR (MacEd)

This procedure is used to create a sequence of commands that are launched with one key touch or other event. Up to 132 macros can be created for the system, and each macro can contain up to 10 commands including other macros and delays. **See Macro Editor - Flow Chart page 78**

- 1. MACRO ID –**  
(MacID) Number of Macro up to 132 including any previously named macros.
- 2. MACRO NAME –**  
(MacNm) Name of Macro (optional).
- 3. COMMAND NUM –**  
(Cmd#) Number of Command up to 10.
- 4. COMMAND TYPE –**  
(CmdTp) Select the type of source command (e.g., CD, TV, etc.).
  - a. Selected: Learned IR**  
(LrnIR) Choose Learned IR if the pre-programmed IR code library does not support the source component.
    - i. LEARNED SRC –**  
(LnSrc) Select the learned source bank to be assigned to the source component. Procedure advances to KEY FUNCTION (step 6)

# INSTALLER INSTALLATION MENU

- b. Selected: Unassigned**  
(Unasg) Selected command and subsequent commands are cleared. Procedure advances to COMMAND NUM (step 3)
- c. Selected: Default**  
(Deflt) Default selects the same device type and device code previously setup in BASIC SETUP. Procedure advances to KEY FUNCTION (step 6)
- d. Selected: Macro:**
  - i. MACRO -**  
(Macro) A macro can “call” another macro if a sequence of more than 10 commands is needed.
  - ii. MACRO ID –**  
(MacID) Enter the macro ID number. Menu advances to COMMAND NUM (step 3)
- e. Selected: Delay**  
(Delay) Enter a 1- to 60-second delay time to postpone delivery of the next command in the macro. Procedure advances to COMMAND NUM (step 3)
- f. All Other Selections:** Procedure advances to DEVICE CODE (step 5)
- 5. DEVICE CODE –**  
(DevCd) Source component code for IR control.
- 6. KEY FUNCTION –**  
(KeyFn) Select a function (Play, etc.).

## SYSTEM INFO (SInfo)

System Info allows the installer to view the controller’s manufacturing build properties.  
**See System Info - Flow Chart page 79**

- #CONTROLLERS (#Ctls) ▶ BUILD TIME (BTime) ▶ BUILD DATE (BDate) ▶ VERSION (Ver) ▶**
- 1. #CONTROLLERS**  
(#Ctls) Displays the number of CAM6.6 controllers in the system.
  - 2. BUILD TIME**  
(BTime) Displays the Software Build Time of the controller.
  - 3. BUILD DATE**  
(BDate) Displays the Software Build Date of the controller.
  - 4. VERSION**  
(Ver) Displays the software version of the CAM6.6.

# Installation Menu

## Peripheral Setup: Memory Name, Bank Name

**CAUTION:** Changes within the Installation Menu can affect proper operation and should be performed by qualified personnel

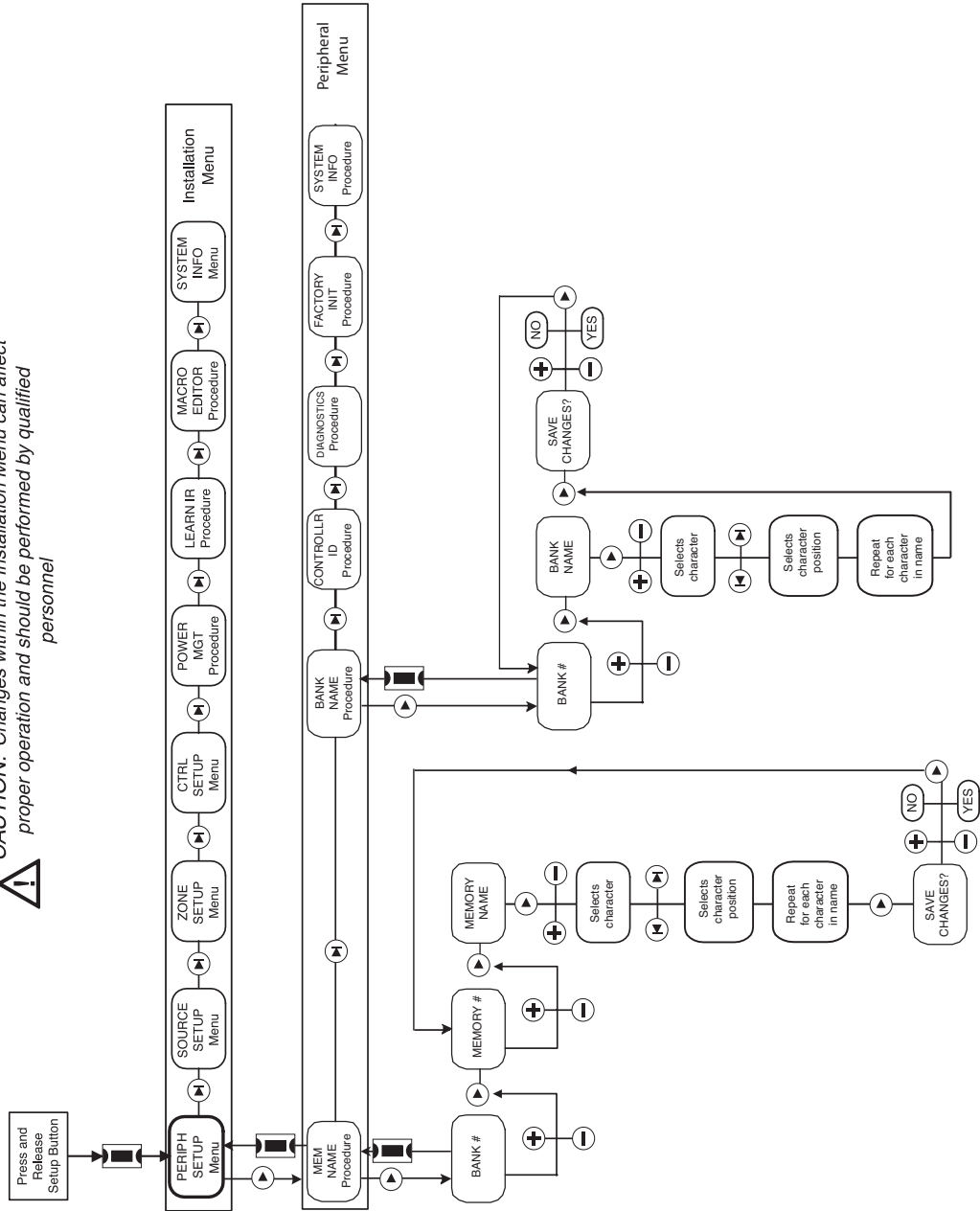

# INSTALLER SETUP MENU FLOW CHARTS

# INSTALLER

## SETUP MENU FLOW CHARTS

### Installation Menu

Peripheral Setup: Controller ID, Diagnostics,  
Factory Init, System Info

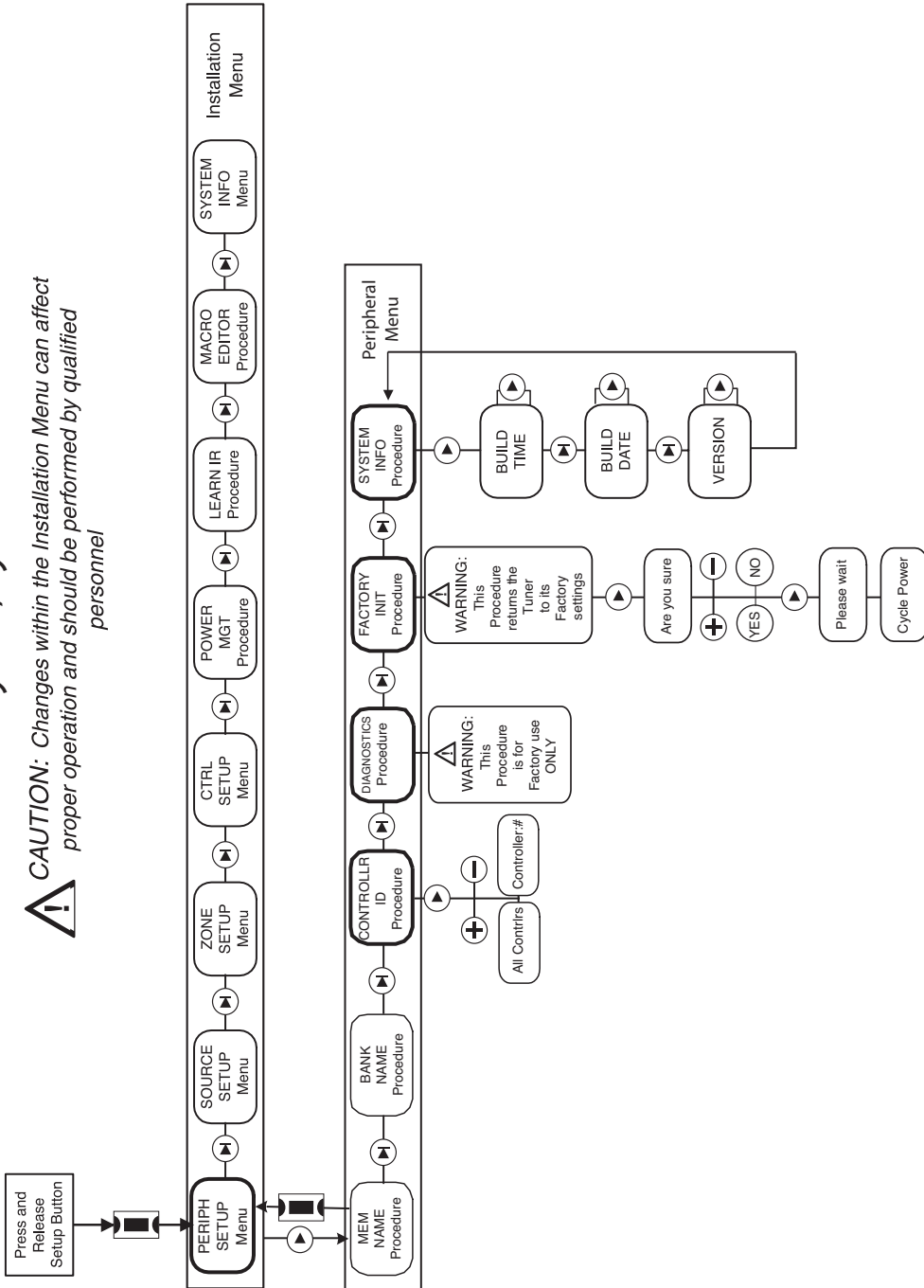

## Installation Menu

### Source Setup: Basic Setup

**⚠ CAUTION:** Changes within the Installation Menu can affect proper operation and should be performed by qualified personnel

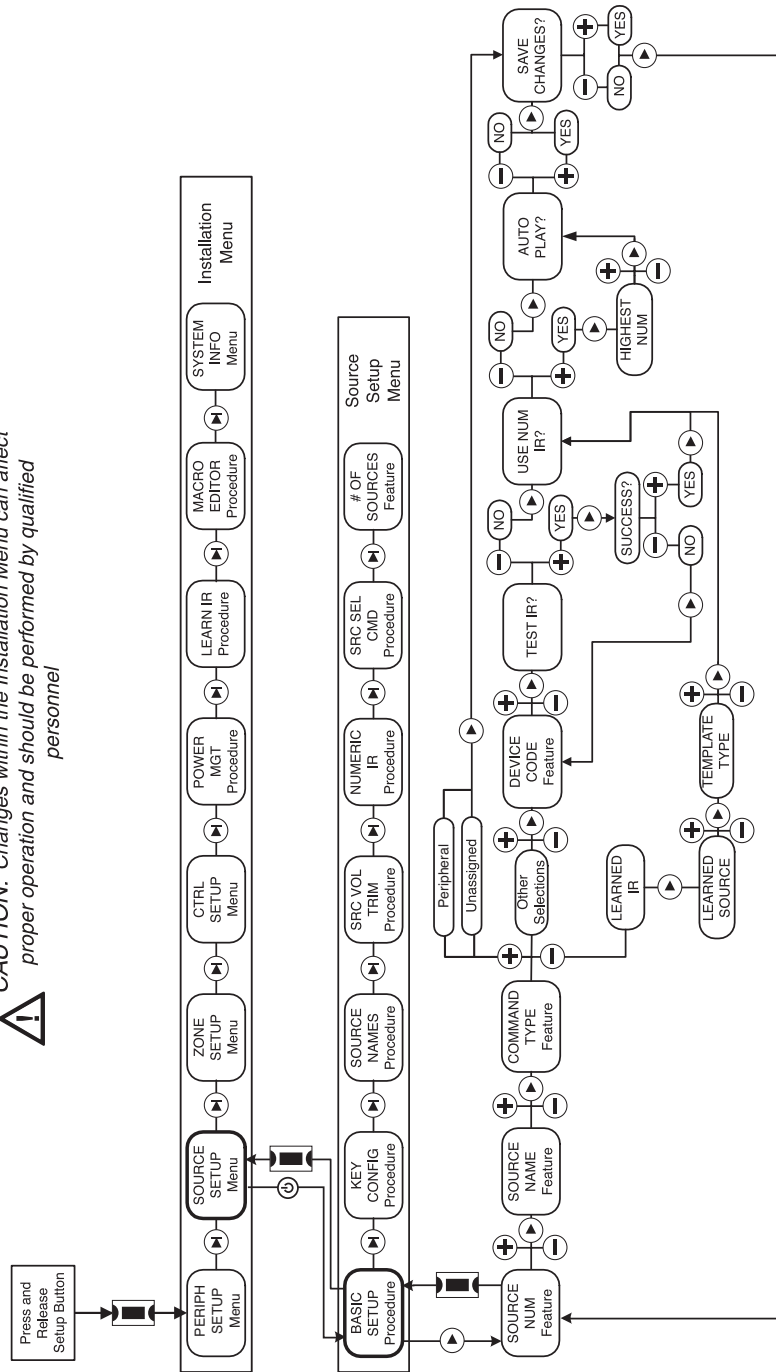

# INSTALLER SETUP MENU FLOW CHARTS

## Installation Menu

### Source Setup: Key Configuration

**CAUTION:** Changes within the Installation Menu can affect proper operation and should be performed by qualified personnel

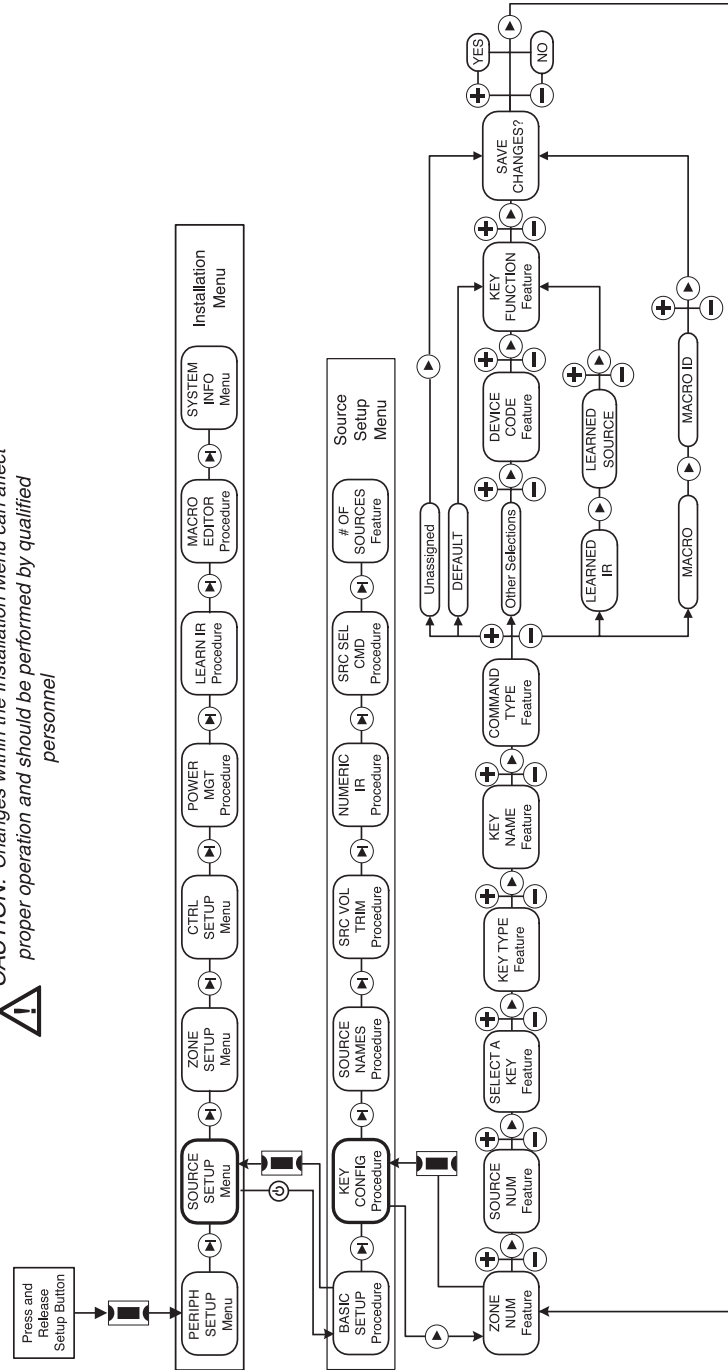

## Installation Menu

### Source Setup: Source Names/Vol Trim

**!** CAUTION: Changes within the Installation Menu can affect proper operation and should be performed by qualified personnel

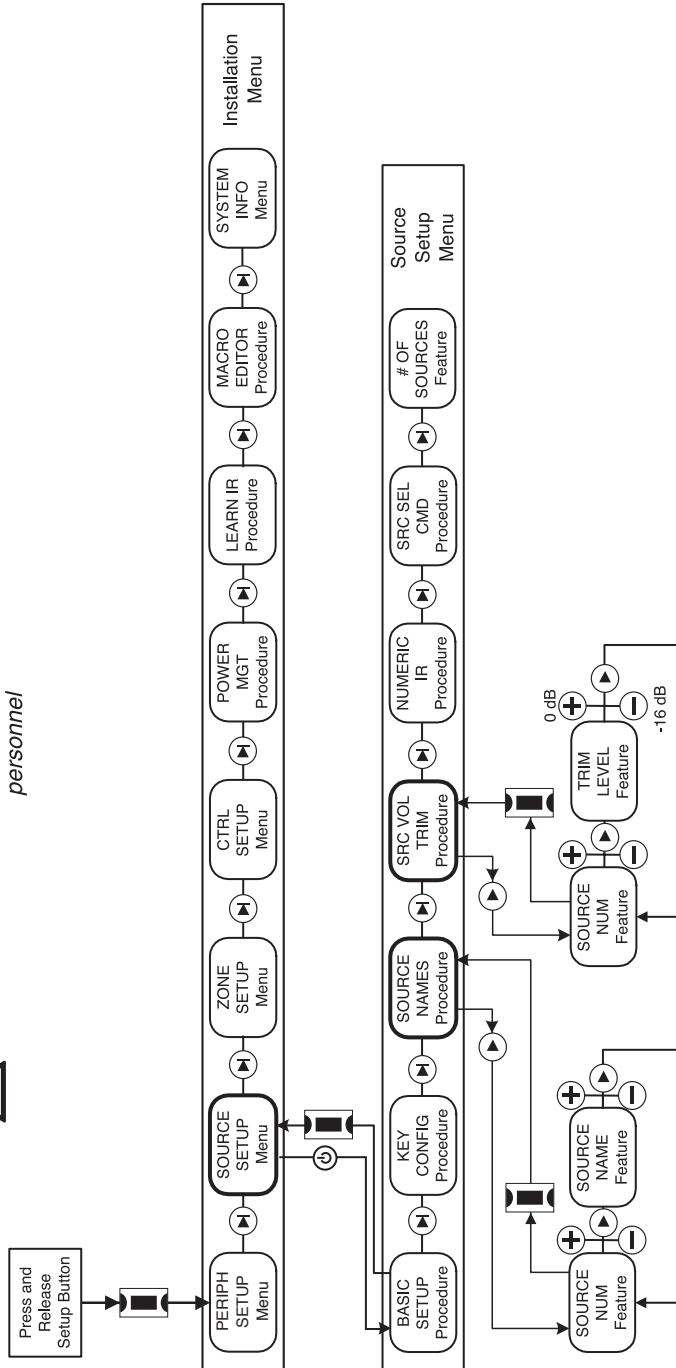

# INSTALLER SETUP MENU FLOW CHARTS

## Installation Menu

### Source Setup: Numeric IR

**CAUTION:** Changes within the Installation Menu can affect proper operation and should be performed by qualified personnel

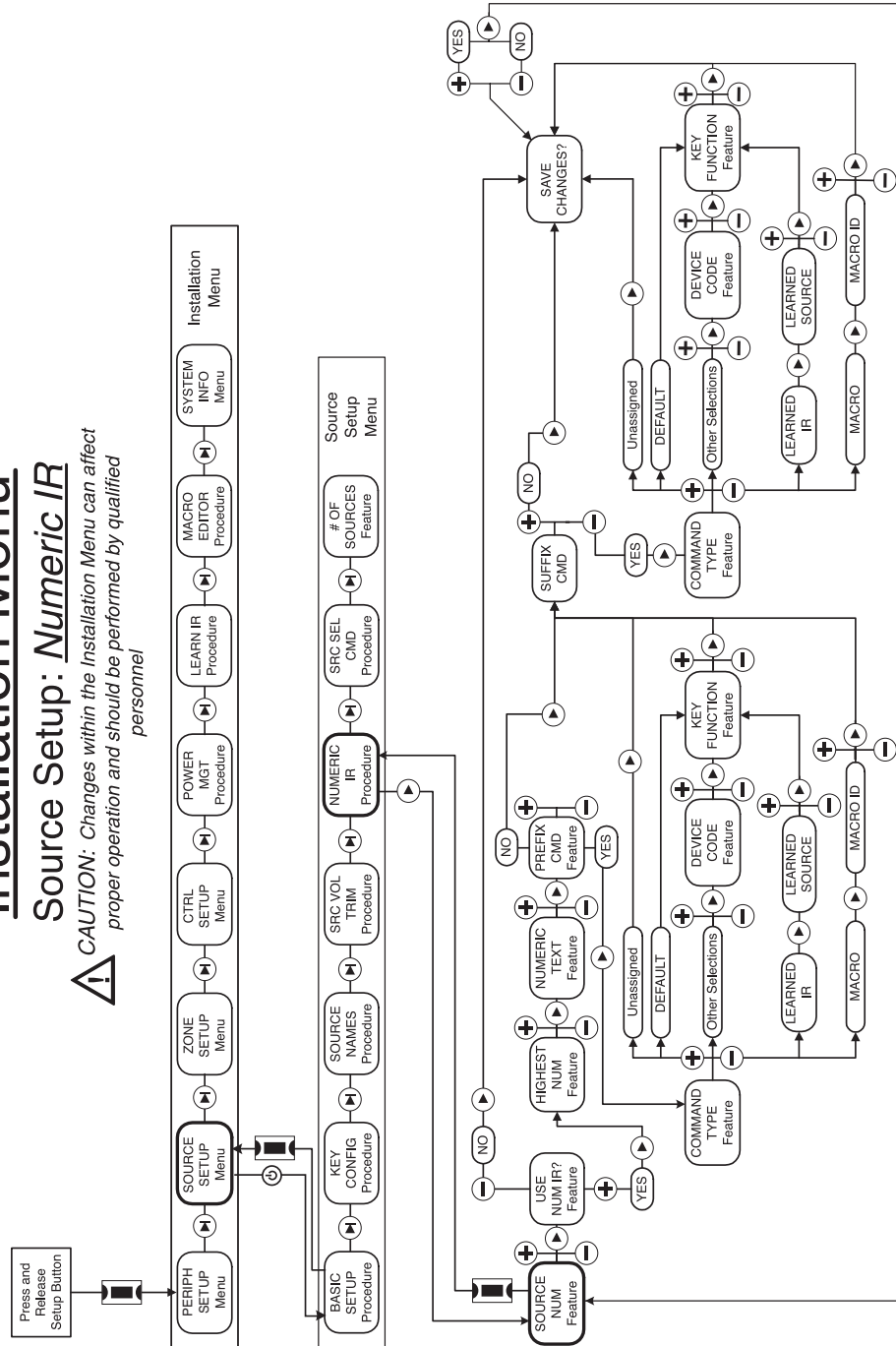



# Installation Menu

## Source Setup: Source Select Command & # Of Sources

**⚠ CAUTION:** Changes within the Installation Menu can affect proper operation and should be performed by qualified personnel

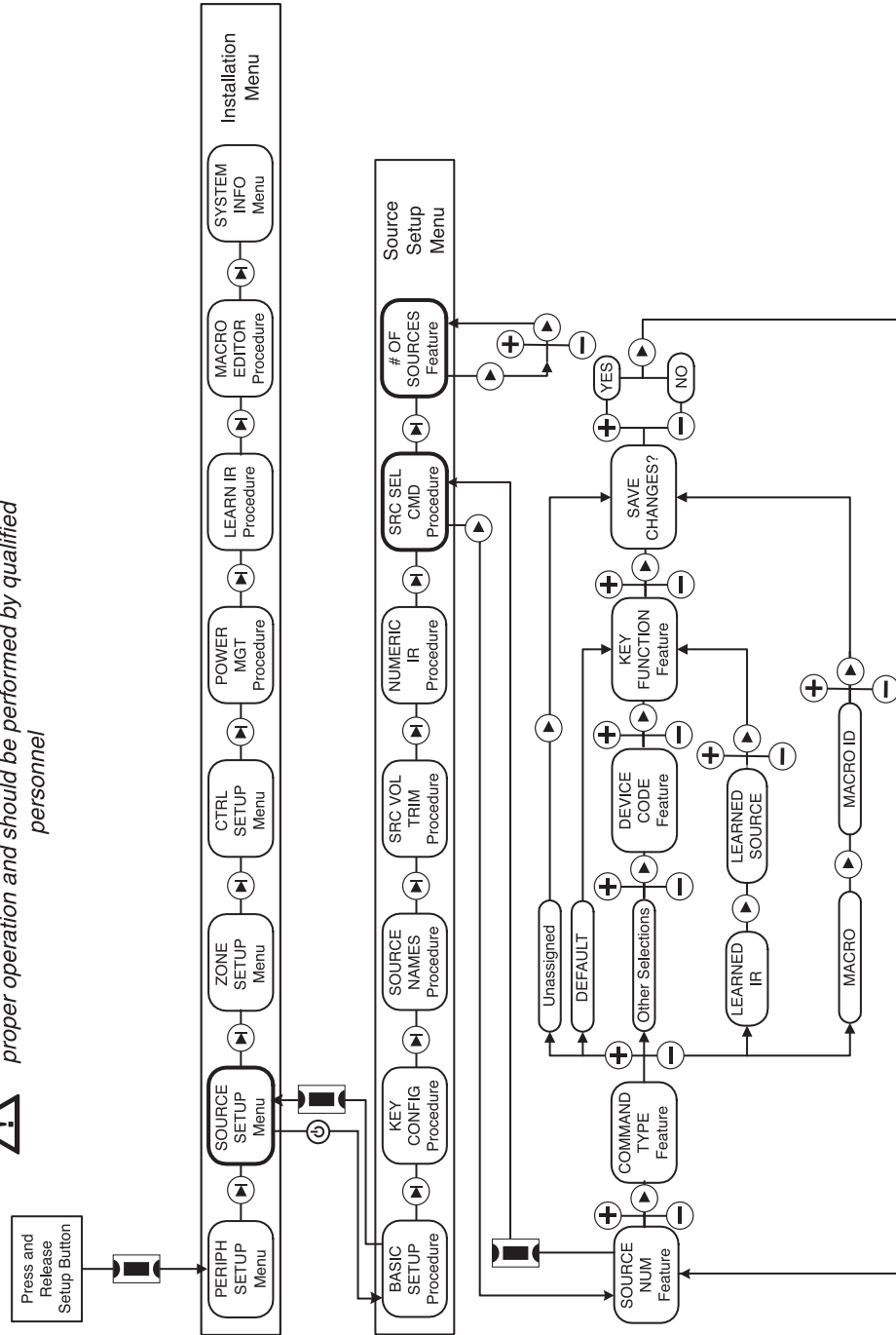

# INSTALLER SETUP MENU FLOW CHARTS

## Installation Menu Zone Setup

**CAUTION:** Changes within the Installation Menu can affect proper operation and should be performed by qualified personnel

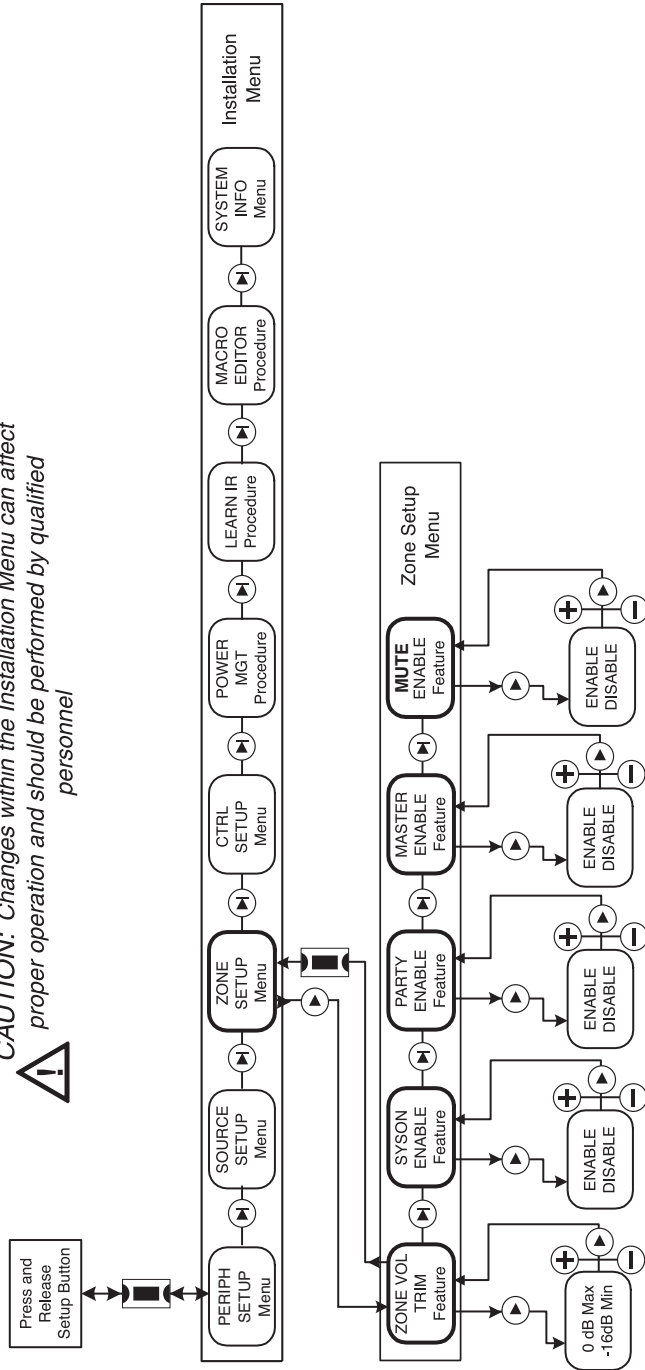

## Installation Menu Controller Setup

**CAUTION:** Changes within the Installation Menu can affect proper operation and should be performed by qualified personnel

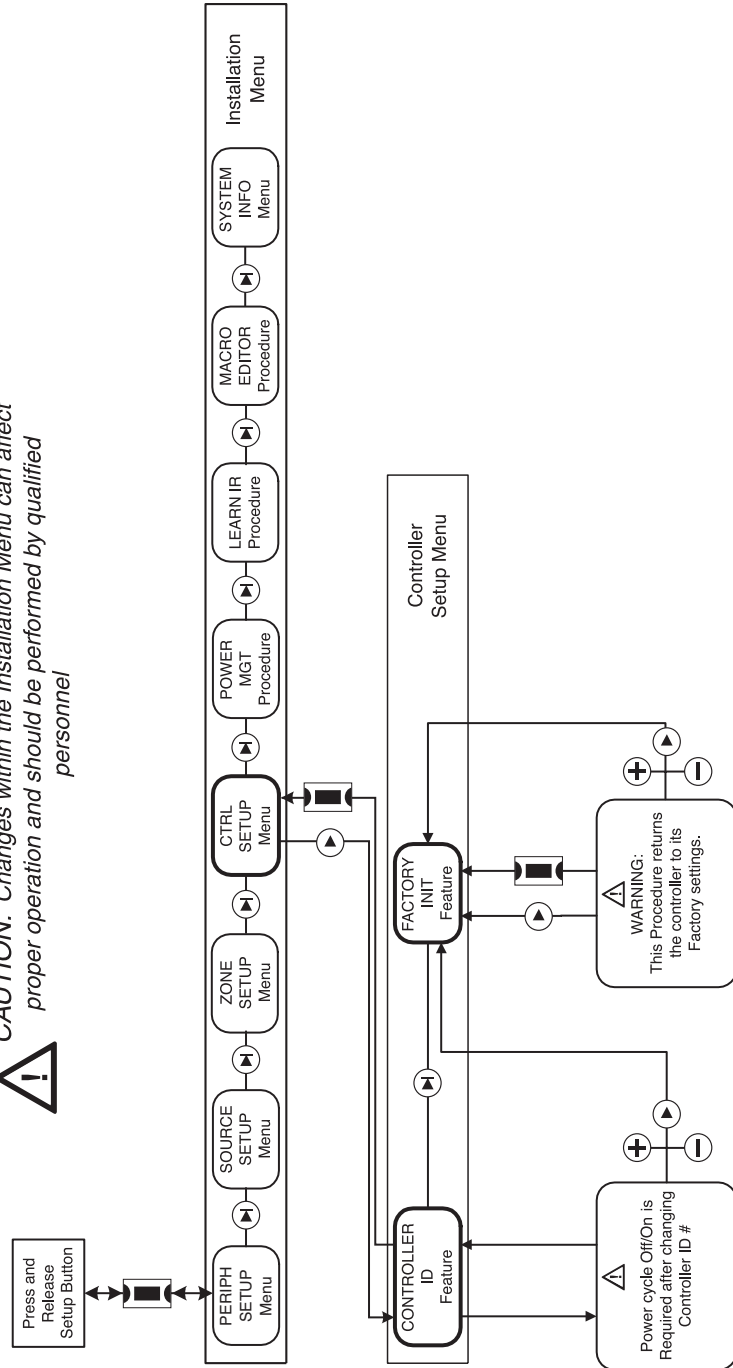

# INSTALLER SETUP MENU FLOW CHARTS

## Installation Menu

### Power Management

**CAUTION:** Changes within the Installation Menu can affect proper operation and should be performed by qualified personnel

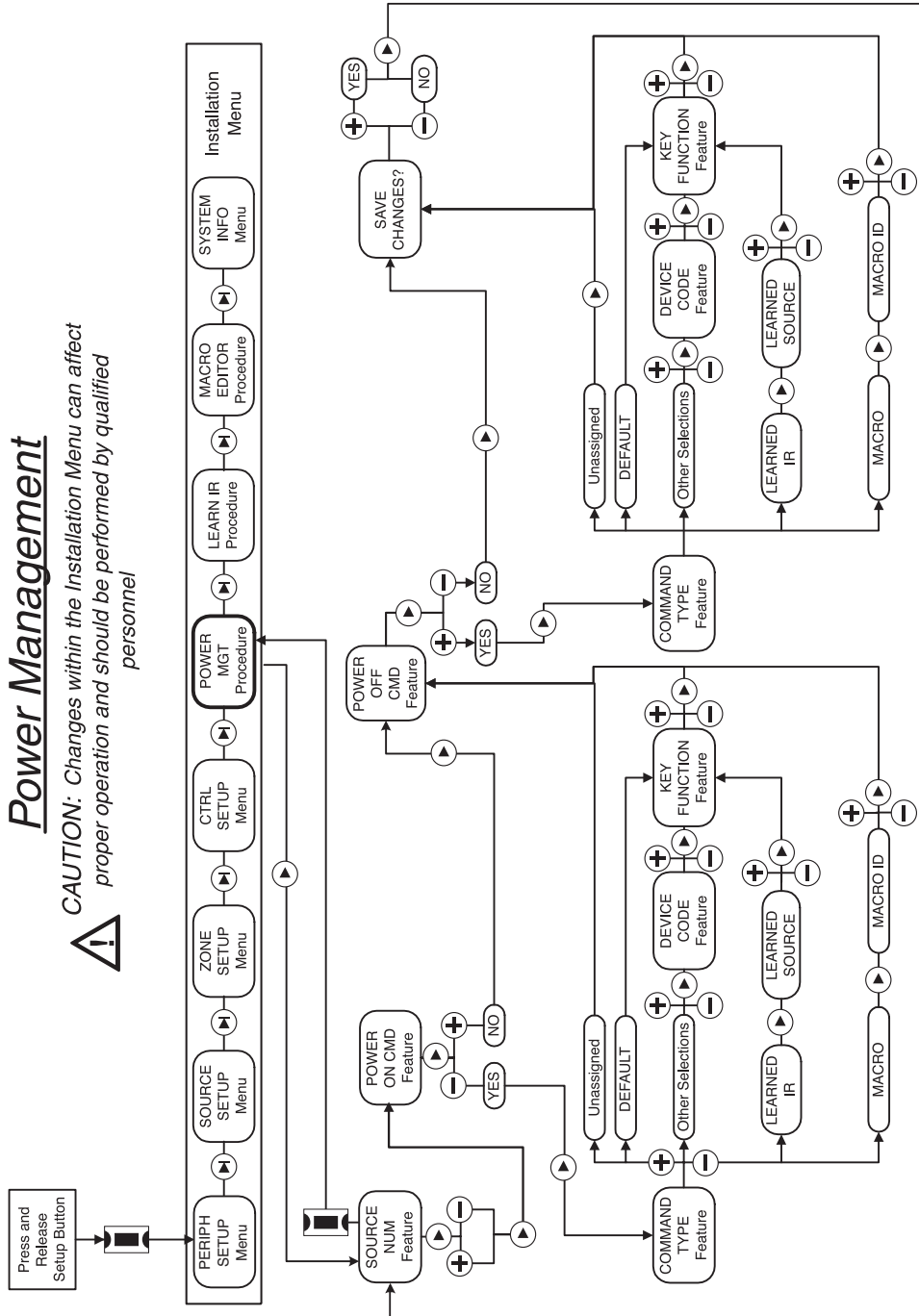

# Installation Menu

## Learn IR

**CAUTION:** Changes within the Installation Menu can affect proper operation and should be performed by qualified personnel

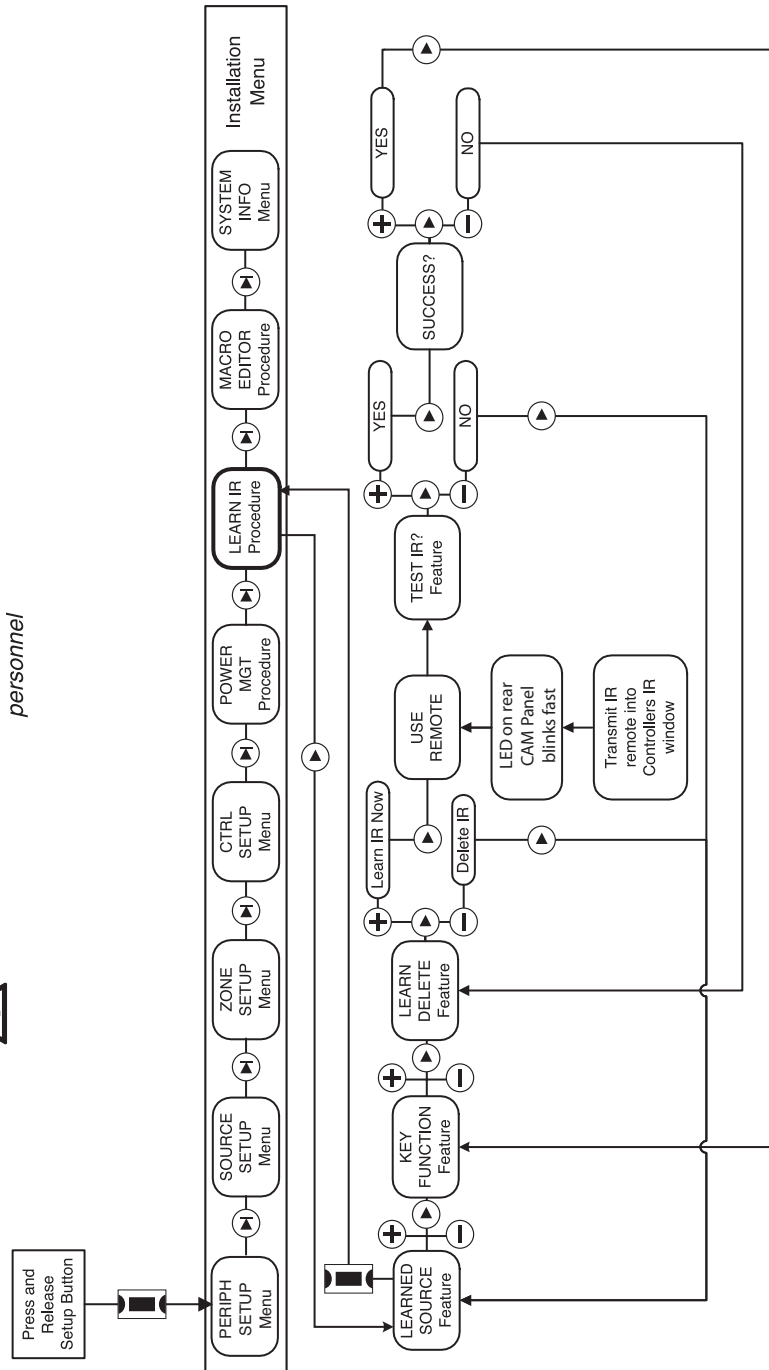

# INSTALLER SETUP MENU FLOW CHARTS

# INSTALLER SETUP MENU FLOW CHARTS

## Installation Menu Macro Editor

**⚠ CAUTION:** Changes within the Installation Menu can affect proper operation and should be performed by qualified personnel

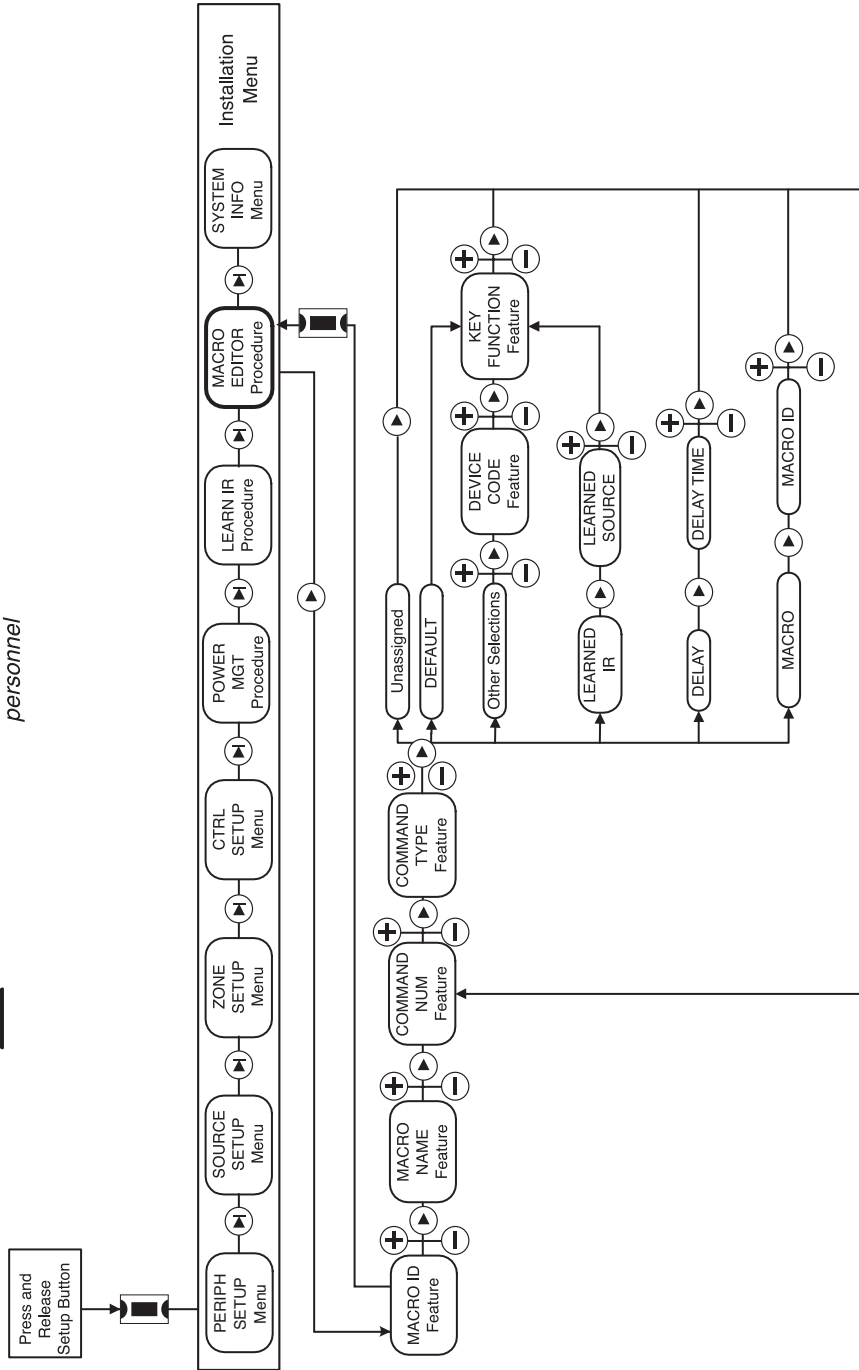

# Installation Menu

## System Info Menu

**⚠ CAUTION:** Changes within the Installation Menu can affect proper operation and should be performed by qualified personnel

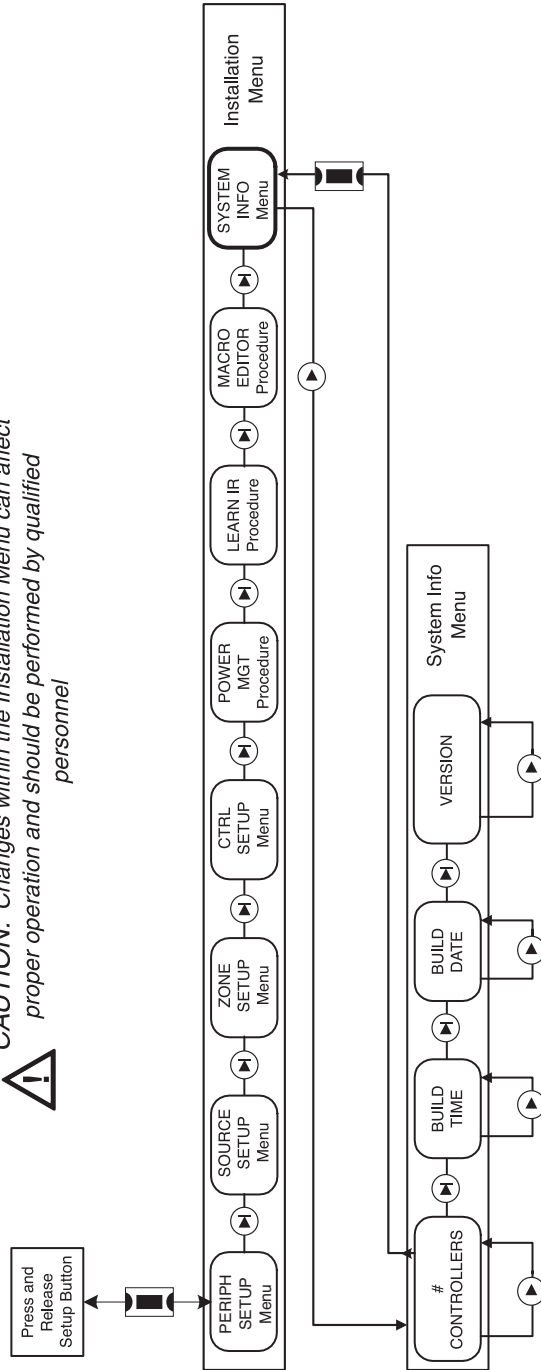

# INSTALLER IR CODES

## Device Codes for TVs:

AOC	0030, 0019
Admiral	0093, 0463
Advent	0761
Aiko	0092
Aiwa	0701
Akai	0030
Alaron	0179
America Action	0180
Ampro	0751
Anam	0180
Apex Digital	0748, 0765, 0767
Audiovox	0451, 0180, 0092, 0623
Baysonic	0180
Belcor	0019
Bell & Howell	0154, 0016
Bradford	0180
Brockwood	0019
Broksonic	0236, 0463
CXC	0180
Candle	0030, 0056
Carnivale	0030
Carver	0054
Celebrity	0000
Changhong	0765
Cineral	0451, 0092
Citizen	0060, 0030, 0056, 0092
Concerto	0056
Contec	0180
Craig	0180
Crosley	0054
Crown	0180
Curtis Mathes	0047, 0747, 1147, 1347, 0054, 0154, 0051, 0451, 0093, 0060, 0030, 0056, 0145, 0166, 0016, 0702, 0466
Daewoo	0451, 0019, 0092, 0623
Daytron	0019
Denon	0145
Dumont	0017, 0019
Dwin	0720, 0774
Electroband	0000
Emerson	0154, 0236, 0463, 0180, 0178, 0179, 0019, 0623
Envision	0030
Fisher	0154
Fujitsu	0179, 0683
Funai	0180, 0179, 0171
Futuretech	0180
GE	0047, 0747, 1147, 1347, 0051, 0451, 0093, 0178, 0021
Gibraltar	0017, 0030, 0019
GoldStar	0030, 0178, 0056, 0019
Gradiente	0053, 0056
Grunpy	0180, 0179
Hallmark	0178
Harley Davidson	0179
Harman/Kardon	0054
Harvard	0180
Havermy	0093
Hitachi	0056, 0145, 0016
Infinity	0054
Inteq	0017
JBL	0054
JCB	0000
JVC	0053
KEC	0180

KTV	0180, 0030
Kenwood	0030, 0019
Konka	0628, 0632, 0638, 0703, 0707
LG	0056
LXI	0047, 0747, 0054, 0154, 0156, 0178
Logik	0016
Luxman	0056
MGA	0150, 0030, 0178, 0019
MTC	0060, 0030, 0056, 0019
Magnavox	0054, 1254, 0030, 0179, 1454
Majestic	0016
Marantz	0054, 0030
Matsushita	0250
Megatron	0178, 0145
Memorex	0154, 0250, 0463, 0150, 0178, 0179, 0056, 0016
Midland	0047, 0747, 0017, 0051
Minutz	0021
Mitsubishi	0093, 0150, 0178, 0019
Motorola	0093
Multitech	0180
NAD	0156, 0178, 0166
NEC	0030, 0056, 0019
NTC	0092
Nikko	0030, 0178, 0092
Onwa	0180
Optimus	0154, 0250, 0166
Optonica	0093
Orion	0236, 0463, 0179
Panasonic	0051, 0250
Penney	0047, 0747, 1347, 0156, 0051, 0060, 0030, 0178, 0021, 0056, 0019
Philco	0054, 0463, 0030, 0145, 0019
Philips	0054, 1454
Pilot	0030, 0019
Pioneer	0166, 0679
Portland	0019, 0092
Princeton	0717
Prism	0051
Proscan	0047, 0747
Proton	0178, 0466
Pulsar	0017, 0019
Quasar	0051, 0250
RCA	0047, 0747, 1047, 1147, 1247, 1347, 1447, 0090, 0051, 0093, 0019, 0679
Radio Shack	0047, 0747, 0154, 0180, 0030, 0178, 0056, 0019
Realistic	0154, 0180, 0030, 0178, 0056, 0019
Runco	0017, 0030, 0603
SSS	0180, 0019
Sampo	0030
Samsung	0060, 0030, 0178, 0056, 0019, 0702, 0766
Sansei	0451
Sansui	0463
Sanyo	0154
Scimitsu	0019
Scotch	0178
Scott	0236, 0180, 0178, 0179, 0019
Sears	0047, 0747, 0054, 0154, 0156, 0178, 0179, 0056, 0171
Semivox	0180
Semp	0156
Sharp	0093, 0688, 0689
Shogun	0019

Signature	0016
Sony	0000, 1100
Soundesign	0180, 0178, 0179
Squareview	0171
Starlite	0180
Supreme	0000
Sylvania	0054, 0030, 0171
Symphonic	0171, 0180
TMK	0178, 0056
TNCi	0017
Tandy	0093
Technics	0051, 0250
Technol Ace	0179
Techwood	0051, 0056
Teknika	0054, 0180, 0150, 0060, 0179, 0056, 0019, 0092, 0016
Telefunken	0056, 0702
Toshiba	0154, 0156, 0060, 1256
Vector Research	0030
Victor	0053
Vidikron	0054
Vidtech	0178, 0019
Wards	0054, 0030, 0178, 0021, 0179, 0056, 0019, 0016
Waycon	0156
White Westinghouse	0463, 0623
Yamaha	0030, 0019, 0769
Zenith	0017, 0463, 0092, 0016

## Device Codes for Cable:

ABC	0003, 0008, 0014, 0017
Americast	0899
Bell & Howell	0014
Bell South	0899
Director	0476
General Instrument	0003, 0476, 0810, 0276
GoldStar	0144
Hamilin	0009, 0273
Jerrold	0003, 0012, 0014, 0276, 0476, 0810
Memorex	0000
Motorola	0476, 1106, 0276, 0810
Pace	0237
Panasonic	0000, 0107
Paragon	0000
Philips	0305, 0317
Pioneer	0144, 0877, 0533, 1877
Pulsar	0000
Quasar	0000
Regal	0273, 0279
Runco	0000
Samsung	0144
Scientific Atlanta	0008, 0477, 0877, 0017, 1877
Sony	1006
Starcom	0003
Supercable	0276
Tocom	0012
Torx	0003
Toshiba	0000
Zenith	0525, 0000, 0899

## Device Codes for Video Acc:

AOL	1061
Magnavox	1818
Mitsubishi	1002
Panasonic	1120



# INSTALLER IR CODES

Philips	1818, 1061
Pioneer	1010
Princeton	0113, 0295
Samsung	1190, 1204
Sensory Science	1126
Sharp	1010
Sony	0850

## Device Codes for SAT/DSS:

AlphaStar	0772
Chaparral	0216
Crossdigital	1109
Echostar	0775, 1005
Expressvu	0775
GE	0566
GOI	0775
General Instrument	0869
HTS	0775
Hitachi	0819
Hughes Net. Sys.	0749, 1142, 1749
JVC	0775
Magnavox	0724, 0722
Memorex	0724
Mitsubishi	0749
Motorola	0869
Next Level	0869
Panasonic	0247, 0701
Paysat	0724
Philips	0724, 0722, 1142, 0749, 1076, 1749
Proscan	0392
RCA	0566, 0143, 0855, 0392
RadioShack	0869
Samsung	1109
Sony	0639
Star Choice	0869
Toshiba	0749, 0790, 1749
Uniden	0724, 0722
Zenith	0856, 1856

## Device Codes for VCRs:

Admiral	0048, 0209
Adventura	0000
Aiko	0278
Aiwa	0037, 0000
Akai	0041
America Action	0278
American High	0035
Asha	0240
Audiovox	0037
Beaumarck	0240
Bell & Howell	0104
Broksonic	0184, 0121, 0209, 0002, 1479
CCE	0072, 0278
Calix	0037
Canon	0035
Carver	0081
Cineral	0278
Citizen	0037, 0278, 1278
Colt	0072
Craig	0037, 0047, 0240, 0072
Curtis Mathes	0035, 0060, 0760, 0162, 0041, 1035
Cybernex	0240
Daewoo	0045, 0278, 1278
Denon	0042

Dynatech	0000
Electrohome	0037
Electrohome	0037
Emerex	0032
Emerson	0037, 0184, 0000, 0121, 1278, 1479, 0043, 0209, 0002, 0278, 0479
Fisher	0047, 0104
Fuji	0035
Funai	0000
GE	0035, 0060, 0760, 0048, 0240, 1035, 1060, 0807
Garrard	0000
Go Video	0432
GoldStar	0037, 0038, 1237
Gradiente	0000
HI-Q	0047
Harley Davidson	0000
Harman/Kardon	0081, 0038
Harwood	0072
Hitachi	0000, 0042, 0041
Hughes Net. Sys.	0042
JVC	0067, 0041
Jensen	0041
KEC	0037, 0278
KLH	0072
Kenwood	0067, 0041, 0038
Kodak	0035, 0037
LXI	0037
Lloyd's	0000
Logik	0072
MEI	0035
MGA	0240, 0043
MGN Technology	0240
MTC	0000, 0240
Magnasonic	0278, 1278
Magnavox	0035, 0039, 0081, 0000, 0149, 0563, 1781
Magnin	0240
Marantz	0035, 0081
Marta	0037
Matsushita	0035, 0162, 0454
Memorex	0035, 0037, 1037, 0048, 0039, 0047, 0162, 1162, 1262, 0000, 0240, 0104, 0209, 0454, 0479, 1237
Minolta	0042
Mitsubishi	0048, 0067, 0043, 0807
Motorola	0035, 0048
Multitech	0000, 0072
NEC	0067, 0104, 0041, 0038
Nikko	0037
Noblex	0240
Olympus	0035
Optimus	0037, 0048, 1048, 0162, 1062, 1162, 1262, 0104, 0454, 0432
Orion	0184, 0209, 0002, 0479, 1479
Panasonic	0035, 0225, 0162, 1062, 1035, 1162, 1262, 0454, 0616
Penney	0035, 0037, 0042, 0240, 0038, 1035, 1237
Pentax	0042
Philco	0035, 0209, 0479
Philips	0035, 0081, 1081, 1181, 0618
Pilot	0037
Pioneer	0067
Polk Audio	0081
Profitronic	0240
Proscan	0060, 0760, 1060

Protec	0072
Pulsar	0039
Quasar	0035, 0162, 1162, 0454, 1035
RCA	0035, 0060, 0760, 0048, 1035, 1060, 0807, 0149, 0042, 0240
Radio Shack	1037, 0000
Radix	0037
Randex	0037
Realistic	0035, 0037, 0048, 0047, 0000, 0104
ReplayTV	0614, 0616
Runco	0039
STS	0042
Samsung	0045, 0240
Sanky	0048, 0039
Sansui	0000, 0067, 0209, 0041, 0479, 1479
Sanyo	0047, 0240, 0104
Scott	0184, 0045, 0121, 0043
Sears	0035, 0037, 0047, 0000, 0042, 0104, 1237
Semp	0045
Sharp	0048, 0807, 0848
Shintom	0072
Shogun	0240
Singer	0072
Sonic Blue	0614
Sony	0035, 0032, 1032, 0000, 0636, 1232
Sylvania	0035, 0081, 0000, 0043, 1781
Symphonic	0000
TMK	0240
Tatung	0041
Teac	0000, 0041
Technics	0035, 0162
Teknika	0035, 0037, 0000
Thomas	0000
Tivo	0618, 0636
Toshiba	0045, 0043, 0845
Totevision	0037, 0240
Unitech	0240
Vector	0045
Vector Research	0038
Video Concepts	0045
Videomagic	0037
Videosonic	0240
Villain	0000
Wards	0035, 0060, 0760, 0048, 0047, 0081, 0000, 0042, 0240, 0072, 0149
White Westinghouse	0209, 0072, 0278, 1278
XR-1000	0035, 0000, 0072
Yamaha	0038
Zenith	0039, 0000, 0209, 0479, 1479

## Device Codes for Laser Disc Players:

Aiwa	0203
Denon	0059, 0172
Funai	0203
Mitsubishi	0059
NAD	0059
Optimus	0059
Panasonic	0204
Pioneer	0059
Quasar	0204

# INSTALLER IR CODES

Realistic	0203
Sony	0201, 0193
Technics	0204

## Device Codes for DVD Players:

Aiwa	0641
Apex Digital	0672, 0755, 0794, 0795, 0796, 0797, 0830
Blue Parade	0571
Broksonic	0695
Daewoo	0784
Denon	0490, 0634
Emerson	0591
Enterprise	0591
Fisher	0670
GE	0522
Go Video	0715, 0783
Gradiente	0651
Harman/Kardon	0582, 0702
Hitachi	0573, 0664
Hiteker	0672
JBL	0702
JVC	0558, 0623, 0867
Kenwood	0534, 0682
Konka	0711, 0719, 0720, 0721
Koss	0651
Lasonic	0798
Magnavox	0503, 0675
Malata	0782
Marantz	0539
Microsoft	0522
Mitsubishi	0521
Onkyo	0503, 0627
Oritron	0651
Panasonic	0490, 0632
Philips	0503, 0539, 0646, 0854
Pioneer	0525, 0571, 0632
Princeton	0674
Proscan	0522
RCA	0522, 0571, 0822, 1022
Rowa	0823
Sampo	0698
Samsung	0573, 0820
Sansui	0695
Sanyo	0670
Sharp	0630
Sherwood	0633
Sony	0533, 1533
Sylvania	0821
Technics	0490
Techwood	0692
Theta Digital	0571
Toshiba	0503, 0695, 1045
Urban Concepts	0503
Yamaha	0490, 0545, 0817
Zenith	0503, 0591

## Device Codes for Tuner/Amp:

ADC	0531
Aiwa	1089, 1405, 0158, 1388
Alco	1390
Anam	1609
Apex Digital	1257
Audiotronic	1189
Audiovox	1390
Bose	1229

Capetronic	0531
Carver	1089, 1189
Denon	1104, 1160, 1360
JBL	1306
JVC	0074
KLH	1390
Kenwood	1313, 1027, 1570, 1569, 0027
Koss	1366
MCS	0039
Magnavox	1089, 1189, 0531
Marantz	1089, 1189, 0039
Musicmagic	1089
Onkyo	0135, 0842, 1298
Optimus	1023, 0531
Panasonic	1518, 0039, 1288
Philips	1089, 1189, 1269, 1283
Pioneer	0014, 0531, 1023
Proscan	1254
Quasar	0039
RCA	1023, 1254, 0531, 1390, 1609
Samsung	1295
Sansui	1089
Sherwood	1653
Sony	1058, 1158, 1258, 0158
Stereophonics	1023
Sunfire	1313
Technics	1308, 1309, 1518, 0039
Thorens	1189
Venturer	1390
Victor	0074
Wards	0014, 0158
Yamaha	0176, 1176

## Device Codes for Amp and Misc. Audio:

Aiwa	0010, 0159
GE	0078
Harman/Kardon	0892
Jerrold	0520, 0459
JVC	0331
Left Coast	0892
Marantz	0892
Optimus	0395
Philips	0892
Polk Audio	0892
Realistic	0395
Scientific Atlanta	0460
Sony	0010, 0159
Soundesign	0078
Starcom	0459
Victor	0331
Wards	0078
Yamaha	0354

## Device Codes for CD Players:

Aiwa	0157
California Audio Labs	0029
Carver	0157, 0179
Classic	1297
DKK	0000
DMX Electronics	0157
Denon	0873
Emerson	0305
Fisher	0179
GPX	1296

Genexxa	0032, 0305
Harman/Kardon	0157, 0173
Hitachi	0032
JVC	0072, 1294
Kenwood	0826, 0626, 0028, 0037, 0681
Koss	1317
Krell	0157
LXI	0305
Linn	0157
MCS	0029
Magnavox	0157, 0305
Marantz	0626, 0029, 0157
Miro	0000
Mission	0157
NSM	0157
Onkyo	0868
Optimus	1063, 0032, 0000, 0179, 0305, 0037
Panasonic	0029
Philips	0626, 0157
Pioneer	1063, 0032, 0305, 1062
Polk Audio	0157
Proton	0157
QED	0157
Quasar	0029
RCA	0179, 0305, 0032, 1062
Realistic	0179
Rotel	0157
SAE	0157
Sansui	0157, 0305
Sanyo	0179
Scott	0305
Sears	0305
Sharp	0861, 0037
Sherwood	1067
Sonic Frontiers	0157
Sony	0490, 0000, 0100
TDK	1208
Technics	0029
Victor	0072
Wards	0157
Yamaha	0888, 1292

## Device Codes for Home Control:

Audio Access	0154
Cableshare	0537
Comfortex	0400
Da-Lite	0780
Elero	0434
Evergo	0059
GE	0240
Gewa	0095
Holmes	1215
Hunter Douglas	0433
Lightolier	0184, 1204, 1205, 1206
Lite Touch	0084
Lutron	0597, 0318, 1239, 1597
One For All	0167
RadioShack	0240
Russound	1232, 1233
Sanyo	0336
Security System	0167
Somfy	0780
Universal X10	0167
X10	0167

# INSTALLER KEY CODES TV (HDTV)

KEY FUNCTION	UNO-S1	TV (HDTV)	KEY FUNCTION	UNO-S1	TV (HDTV)
1	1	Digit 1	Pause	Pause	Learned Only
2	2	Digit 2	Record	Recrd	Learned Only
3	3	Digit 3	Menu	Menu	Menu (Picture)
4	4	Digit 4	Menu Up	MenuU	Menu Up, Adjust Up
5	5	Digit 5	Menu Dn	MenuD	Menu Dn, Adjust Dn
6	6	Digit 6	Menu Left	MenuL	Menu Left
7	7	Digit 7	Menu Right	MenuR	Menu Right
8	8	Digit 8	Select	Sel	Menu Select
9	9	Digit 9	Exit	Exit	Exit, Cancel
0	0	Digit 0	Display	Displ	Display, OSD, Info
Volume Up	VolUp	Volume Up	Guide	Guide	Guide
Volume Down	VolDn	Volume Down	Page Up	PageU	Adjust up
Mute	Mute	Mute	Page Down	PageD	Adjust Down
Channel Up	Ch Up	Channel Up	Disk	Disk	Learned Only
Channel Dn	Ch Dn	Channel Down	Plus 10	Pls10	+100
Power	Power	Power On/Off	Open/Close	Op/Cl	Learned Only
Enter	Enter	Channel Enter	Random	Randm	Learned Only
Prev Channel	PrvCh	Last Channel	Track Fwd	TkFwd	Learned Only
TV/Video	TVVid	Learned Only	Track Rev	TkRev	Learned Only
TV/VCR	TVVCR	Learned Only	Sur On/Off	SurOn	Surround On/Off
A/B	A / B	Learned Only	Sur Mode	SurMd	Learned Only
TV/DVD	TVDVD	Learned Only	Surround Up	SurUp	Learned Only
TV/LD	TV LD	Learned Only	Surround Dn	SurDn	Learned Only
Input	Input	TV/Video	PIP	PIP	Learned Only
TV/DSS	TVDSS	Learned Only	PIP Move	PIP M	PIP Move
Play	Play	Learned Only	PIP Swap	PIP S	PIP Swap
Stop	Stop	Learned Only	Program	Progm	Learned Only
Search Fwd	SrchF	Learned Only	Sleep	Sleep	Learned Only
Search Rev	SrchR	Learned Only	On	On	On, Power On/Off

# INSTALLER

## KEY CODES

### TV (HDTV)

KEY FUNCTION	UNO-S1	TV (HDTV)	KEY FUNCTION	UNO-S1	TV (HDTV)
Off	Off	Off, Power On/Off	PIP Chan Up	PIPCU	PIP Channel Up
11	11	Learned Only	PIP Chan Dn	PIPCD	PIP Channel Down
12	12	Learned Only	Input 1	In 1	VID1,Video,TVp1
13	13	Learned Only	Input 2	In 2	VID2,TVp2
14	14	Learned Only	Input 3	In 3	VID3,TVp3
15	15	Learned Only	Input 4	In 4	VID4,TVp4
16	16	Learned Only	Input 5	In 5	VID5,AV1,VCR,BNC
Bright	Brght	Learned Only	Input 6	In 6	VID6,AV2,VDP,DVD,DVI
Dim	Dim	Learned Only	Input 7	In 7	TV, Component
Close	Close	Learned Only	Input 8	In 8	CAB,SAT,S-Video
Open	Open	Learned Only	Input 9	In 9	AV, Tuner
Halt	Halt	Learned Only	Input 10	In 10	AUX, RGB
AM/FM	AM/FM	Learned Only			
Cue	Cue	Learned Only			
Disk Up	DiskU	Learned Only			
Disk Down	DiskD	Learned Only			
Info	Info	Learned Only			
External Src	ExtSr	External Antenna			
Live/Intro	Intro	Learned Only			
Menu	Menu	Menu (Audio)			
Back	Back	Back			
Fav Channel	FavCh	Favorite			
Display Fmt	DFrmt	Fmt,Wide,16:9,Aspct			
SAP	SAP	SAP, CC			
Slow	Slow	Learned Only			
PIP On	PIPOn	PIP ON			
PIP Off	PIPOf	PIP OFF			
PIP Freeze	PIPFr	PIP Freeze			
PIP Input	PIPIn	PIP Input			

# INSTALLER KEY CODES CABLE

KEY FUNCTION	UNO-S1	CABLE	KEY FUNCTION	UNO-S1	CABLE
1	1	Digit 1	Pause	Pause	Pause
2	2	Digit 2	Record	Recrd	Record
3	3	Digit 3	Menu	Menu	Menu, Settings
4	4	Digit 4	Menu Up	MenuU	Menu Up
5	5	Digit 5	Menu Dn	MenuD	Menu Down
6	6	Digit 6	Menu Left	MenuL	Menu Left
7	7	Digit 7	Menu Right	MenuR	Menu Right
8	8	Digit 8	Select	Sel	Menu Select
9	9	Digit 9	Exit	Exit	Exit, Cancel
0	0	Digit 0	Display	Displ	Info, Display, OSD
Volume Up	VolUp	Volume Up	Guide	Guide	Guide
Volume Down	VolDn	Volume Down	Page Up	PageU	Page Up
Mute	Mute	Mute	Page Down	PageD	Page Down
Channel Up	Ch Up	Channel Up	Disk	Disk	Learned Only
Channel Dn	Ch Dn	Channel Down	Plus 10	Pls10	+100
Power	Power	Power On/Off	Open/Close	Op/Cl	Learned Only
Enter	Enter	Channel Enter	Random	Randm	Learned Only
Prev Channel	PrvCh	Last Channel	Track Fwd	TkFwd	Quick Skip, Advance
TV/Video	TVVid	Learned Only	Track Rev	TkRev	Instant Replay
TV/VCR	TVVCR	Learned Only	Sur On/Off	SurOn	Day Down
A/B	A / B	Learned Only	Sur Mode	SurMd	Learned Only
TV/DVD	TVDVD	Learned Only	Surround Up	SurUp	Learned Only
TV/LD	TV LD	Learned Only	Surround Dn	SurDn	Learned Only
Input	Input	Bypass, A/B	PIP	PIP	Learned Only
TV/DSS	TVDSS	Learned Only	PIP Move	PIP M	Learned Only
Play	Play	Play	PIP Swap	PIP S	Learned Only
Stop	Stop	Stop	Program	Progm	Learned Only
Search Fwd	SrchF	Fast Forward	Sleep	Sleep	Learned Only
Search Rev	SrchR	Rewind	On	On	On, Power On/Off

# INSTALLER

## KEY CODES

### CABLE

KEY FUNCTION	UNO-S1	CABLE	KEY FUNCTION	UNO-S1	CABLE
Off	Off	Off, Power On/Off	PIP Chan Up	PIP CU	Learned Only
11	11	Learned Only	PIP Chan Dn	PIP CD	Learned Only
12	12	Learned Only	Input 1	In 1	A, VID1, Video, TVp1
13	13	Learned Only	Input 2	In 2	B, VID2, TVp2
14	14	Learned Only	Input 3	In 3	C, VID3, TVp3
15	15	Learned Only	Input 4	In 4	VID4, TVp4
16	16	Learned Only	Input 5	In 5	VID5, AV1, VCR, BNC
Bright	Brght	Learned Only	Input 6	In 6	VID6, AV2, VDP, DVD, DVI
Dim	Dim	Learned Only	Input 7	In 7	TV, Component
Close	Close	Learned Only	Input 8	In 8	CAB, SAT, S-Video
Open	Open	Learned Only	Input 9	In 9	AV, Tuner
Halt	Halt	Learned Only	Input 10	In 10	AUX, RGB
AM/FM	AM/FM	Learned Only			
Cue	Cue	Learned Only			
Disk Up	DiskU	Learned Only			
Disk Down	DiskD	Learned Only			
Info	Info	Learned Only			
External Src	ExtSr	External AV Source			
Live/Intro	Intro	Return to Live			
Menu	Menu	PPV (Wink)			
Back	Back	Back			
Fav Channel	FavCh	Favorite			
Display Fmt	DFrmt	Help			
SAP	SAP	Day Up			
Slow	Slow	Learned Only			
PIP On	PIPOn	Learned Only			
PIP Off	PIPOf	Learned Only			
PIP Freeze	PIPFr	Learned Only			
PIP Input	PIPIn	Learned Only			

## INSTALLER KEY CODES VIDEO ACC

KEY FUNCTION	UNO-S1	VIDEO ACC	KEY FUNCTION	UNO-S1	VIDEO ACC
1	1	Digit 1	Pause	Pause	Pause
2	2	Digit 2	Record	Recrd	Record
3	3	Digit 3	Menu	Menu	Menu, Home
4	4	Digit 4	Menu Up	MenuU	Menu Up
5	5	Digit 5	Menu Dn	MenuD	Menu Dn
6	6	Digit 6	Menu Left	MenuL	Menu Left
7	7	Digit 7	Menu Right	MenuR	Menu right
8	8	Digit 8	Select	Sel	Menu Select
9	9	Digit 9	Exit	Exit	Exit, Cancel, Go
0	0	Digit 0	Display	Displ	Info, Display, OSD
Volume Up	VolUp	Volume Up	Guide	Guide	Guide, View
Volume Down	VolDn	Volume Down	Page Up	PageU	Page Up, Scroll Up
Mute	Mute	Mute	Page Down	PageD	Page Dn, Scroll Dn
Channel Up	Ch Up	Channel Up	Disk	Disk	Learned Only
Channel Dn	Ch Dn	Channel Down	Plus 10	Pls10	+100. +10
Power	Power	Power On/Off	Open/Close	Op/Cl	Learned Only
Enter	Enter	Channel Enter	Random	Randm	Learned Only
Prev Channel	PrvCh	Last Channel	Track Fwd	TkFwd	Skip Up, Next
TV/Video	TVVid	Learned Only	Track Rev	TkRev	Skip Dn, Previous
TV/VCR	TVVCR	Learned Only	Sur On/Off	SurOn	Learned Only
A/B	A / B	Learned Only	Sur Mode	SurMd	Learned Only
TV/DVD	TVDVD	Learned Only	Surround Up	SurUp	Learned Only
TV/LD	TV LD	Learned Only	Surround Dn	SurDn	Learned Only
Input	Input	TV/Video, DTV	PIP	PIP	Learned Only
TV/DSS	TVDSS	Learned Only	PIP Move	PIP M	PIP Move
Play	Play	Play	PIP Swap	PIP S	PIP Swap
Stop	Stop	Stop	Program	Progm	Learned Only
Search Fwd	SrchF	Fast Forward	Sleep	Sleep	Learned Only
Search Rev	SrchR	Rewind	On	On	On, Power On/Off

# INSTALLER

## KEY CODES

### VIDEO ACC

KEY FUNCTION	UNO-S1	VIDEO ACC	KEY FUNCTION	UNO-S1	VIDEO ACC
Off	Off	Off, Power On/Off	PIP Chan Up	PIP CU	PIP Channel Up
11	11	Learned Only	PIP Chan Dn	PIP CD	PIP Channel Down
12	12	Learned Only	Input 1	In 1	VID1, Video, TVp1
13	13	Learned Only	Input 2	In 2	VID2, TVp2
14	14	Learned Only	Input 3	In 3	VID3, TVp3
15	15	Learned Only	Input 4	In 4	VID4, TVp4
16	16	Learned Only	Input 5	In 5	VID5, AV1, VCR, BNC
Bright	Brght	Learned Only	Input 6	In 6	VID6, AV2, VDP, DVD, DVI
Dim	Dim	Learned Only	Input 7	In 7	TV, Component
Close	Close	Learned Only	Input 8	In 8	CAB, SAT, S-Video
Open	Open	Learned Only	Input 9	In 9	AV, Tuner
Halt	Halt	Learned Only	Input 10	In 10	AUX, RGB
AM/FM	AM/FM	Learned Only			
Cue	Cue	Learned Only			
Disk Up	DiskU	Learned Only			
Disk Down	DiskD	Learned Only			
Info	Info	Learned Only			
External Src	ExtSr	Ext. Antenna, Web			
Live/Intro	Intro	Learned Only			
Menu	Menu	Setup, Prgrm, Options			
Back	Back	Learned Only			
Fav Channel	FavCh	Favorites			
Display Fmt	DFrmt	Fmt, Wide, 16:9, Aspct			
SAP	SAP	Language, MTS			
Slow	Slow	Learned Only			
PIP On	PIPOn	PIP ON			
PIP Off	PIPOf	PIP OFF			
PIP Freeze	PIPFr	PIP Freeze			
PIP Input	PIPIn	PIP Input			



# INSTALLER KEY CODES SAT/DSS

KEY FUNCTION	UNO-S1	SAT/DSS	KEY FUNCTION	UNO-S1	SAT/DSS
1	1	Digit 1	Pause	Pause	Pause
2	2	Digit 2	Record	Recrd	Record
3	3	Digit 3	Menu	Menu	Menu (PVR, Tivo)
4	4	Digit 4	Menu Up	MenuU	Menu Up
5	5	Digit 5	Menu Dn	MenuD	Menu Down
6	6	Digit 6	Menu Left	MenuL	Menu Left
7	7	Digit 7	Menu Right	MenuR	Menu Right
8	8	Digit 8	Select	Sel	Menu Select
9	9	Digit 9	Exit	Exit	Exit, Cancel
0	0	Digit 0	Display	Displ	Info, Display, OSD
Volume Up	VolUp	Volume Up	Guide	Guide	Guide
Volume Down	VolDn	Volume Down	Page Up	PageU	Page Up, ThumbsUp
Mute	Mute	Mute	Page Down	PageD	Page Dn, ThumbsDn
Channel Up	Ch Up	Channel Up	Disk	Disk	Learned Only
Channel Dn	Ch Dn	Channel Down	Plus 10	Pls10	+100
Power	Power	Power On/Off	Open/Close	Op/Cl	Learned Only
Enter	Enter	Channel Enter	Random	Randm	Learned Only
Prev Channel	PrvCh	Last Channel	Track Fwd	TkFwd	Quick Skip, Advance
TV/Video	TVVid	Learned Only	Track Rev	TkRev	Instant Replay
TV/VCR	TVVCR	Learned Only	Sur On/Off	SurOn	Learned Only
A/B	A / B	Learned Only	Sur Mode	SurMd	Learned Only
TV/DVD	TVDVD	Learned Only	Surround Up	SurUp	Learned Only
TV/LD	TV LD	Learned Only	Surround Dn	SurDn	Learned Only
Input	Input	TV/DSS/SAT	PIP	PIP	Learned Only
TV/DSS	TVDSS	Learned Only	PIP Move	PIP M	Learned Only
Play	Play	Play	PIP Swap	PIP S	Learned Only
Stop	Stop	Stop	Program	Progm	Learned Only
Search Fwd	SrchF	Fast Forward	Sleep	Sleep	Learned Only
Search Rev	SrchR	Rewind	On	On	On, Power On/Off

# INSTALLER

## KEY CODES

### SAT/DSS

KEY FUNCTION	UNO-S1	SAT/DSS
Off	Off	Off, Power On/Off
11	11	Learned Only
12	12	Learned Only
13	13	Learned Only
14	14	Learned Only
15	15	Learned Only
16	16	Learned Only
Bright	Brght	Learned Only
Dim	Dim	Learned Only
Close	Close	Learned Only
Open	Open	Learned Only
Halt	Halt	Learned Only
AM/FM	AM/FM	Learned Only
Cue	Cue	Learned Only
Disk Up	DiskU	Learned Only
Disk Down	DiskD	Learned Only
Info	Info	Learned Only
External Src	ExtSr	External AV Source
Live/Intro	Intro	Return to Live
Menu	Menu	Menu (DTV)
Back	Back	Back
Fav Channel	FavCh	Favorite
Display Fmt	DFrmt	Fmt,Wide,16:9,Aspct
SAP	SAP	Alt/Audio,Lang.,CC
Slow	Slow	Slow
PIP On	PIPOn	Learned Only
PIP Off	PIPOf	Learned Only
PIP Freeze	PIPFr	Learned Only
PIP Input	PIPIn	Learned Only

KEY FUNCTION	UNO-S1	SAT/DSS
PIP Chan Up	PIPCU	Learned Only
PIP Chan Dn	PIPCD	Learned Only
Input 1	In 1	VID1,Video,TVp1
Input 2	In 2	VID2,TVp2
Input 3	In 3	VID3,TVp3
Input 4	In 4	VID4,TVp4
Input 5	In 5	VID5,AV1,VCR,BNC
Input 6	In 6	VID6,AV2,VDP,DVD,DVI
Input 7	In 7	TV, Component
Input 8	In 8	CAB,SAT,S-Video
Input 9	In 9	AV, Tuner
Input 10	In 10	AUX, RGB

# INSTALLER KEY CODES VCR

KEY FUNCTION	UNO-S1	VCR
1	1	Digit 1
2	2	Digit 2
3	3	Digit 3
4	4	Digit 4
5	5	Digit 5
6	6	Digit 6
7	7	Digit 7
8	8	Digit 8
9	9	Digit 9
0	0	Digit 0
Volume Up	VolUp	Volume Up
Volume Down	VolDn	Volume Down
Mute	Mutte	Mute
Channel Up	Ch Up	Channel Up
Channel Dn	Ch Dn	Channel Down
Power	Power	Power On/Off
Enter	Enter	Channel Enter
Prev Channel	PrvCh	Last Channel
TV/Video	TVVid	Learned Only
TV/VCR	TVVCR	Learned Only
A/B	A / B	Learned Only
TV/DVD	TVDVD	Learned Only
TV/LD	TV LD	Learned Only
Input	Input	TV/VCR
TV/DSS	TVDSS	Learned Only
Play	Play	Play
Stop	Stop	Stop
Search Fwd	SrchF	Fast Forward
Search Rev	SrchR	Rewind

KEY FUNCTION	UNO-S1	VCR
Pause	Pause	Pause
Record	Recrd	Record
Menu	Menu	Menu (PVR,Tivo)
Menu Up	MenuU	Menu Up
Menu Dn	MenuD	Menu Down
Menu Left	MenuL	Menu Left
Menu Right	MenuR	Menu Right
Select	Sel	Menu Select
Exit	Exit	Exit, Cancel
Display	Displ	Display, OSD, Info
Guide	Guide	Guide,VCR+,Prgrm
Page Up	PageU	Thmubs Up
Page Down	PageD	Thmubs Down
Disk	Disk	Learned Only
Plus 10	Pls10	+100
Open/Close	Op/Cl	Learned Only
Random	Randm	Learned Only
Track Fwd	TkFwd	QuickSkip/Adv,Indx TrkUp
Track Rev	TkRev	Instnt Rplay,Indx Trk Dn
Sur On/Off	SurOn	Learned Only
Sur Mode	SurMd	Learned Only
Surround Up	SurUp	Learned Only
Surround Dn	SurDn	Learned Only
PIP	PIP	Learned Only
PIP Move	PIP M	Learned Only
PIP Swap	PIP S	Learned Only
Program	Progm	Learned Only
Sleep	Sleep	Learned Only
On	On	On, Power On/Off

# INSTALLER

## KEY CODES

### VCR

KEY FUNCTION	UNO-S1	VCR	KEY FUNCTION	UNO-S1	VCR
Off	Off	Off, Power On/Off	PIP Chan Up	PIP CU	Learned Only
11	11	Learned Only	PIP Chan Dn	PIP CD	Learned Only
12	12	Learned Only	Input 1	In 1	VID1, Video, TVp1
13	13	Learned Only	Input 2	In 2	VID2, TVp2
14	14	Learned Only	Input 3	In 3	VID3, TVp3
15	15	Learned Only	Input 4	In 4	VID4, TVp4
16	16	Learned Only	Input 5	In 5	VID5, AV1, VCR, BNC
Bright	Brght	Learned Only	Input 6	In 6	VID6, AV2, VDP, DVD, DVI
Dim	Dim	Learned Only	Input 7	In 7	TV, Component
Close	Close	Learned Only	Input 8	In 8	CAB, SAT, S-Video
Open	Open	Learned Only	Input 9	In 9	AV, Tuner
Halt	Halt	Learned Only	Input 10	In 10	AUX, RGB
AM/FM	AM/FM	Learned Only			
Cue	Cue	Learned Only			
Disk Up	DiskU	Learned Only			
Disk Down	DiskD	Learned Only			
Info	Info	Learned Only			
External Src	ExtSr	Input Select			
Live/Intro	Intro	Return to Live, Auto Track			
Menu	Menu	Menu			
Back	Back	Clear			
Fav Channel	FavCh	Replay Zones, Indx Mark			
Display Fmt	DFrmt	Record Speed			
SAP	SAP	SAP, CC			
Slow	Slow	Slow			
PIP On	PIPOn	Learned Only			
PIP Off	PIPOf	Learned Only			
PIP Freeze	PIPFr	Learned Only			
PIP Input	PIPIn	Learned Only			

# INSTALLER KEY CODES LASER DISC

KEY FUNCTION	UNO-S1	LASER DISC	KEY FUNCTION	UNO-S1	LASER DISC
1	1	Digit 1	Pause	Pause	Pause
2	2	Digit 2	Record	Recrd	Learned Only
3	3	Digit 3	Menu	Menu	Menu, Program
4	4	Digit 4	Menu Up	MenuU	Menu Up
5	5	5Digit 5	Menu Dn	MenuD	Menu Down
6	6	6Digit 6	Menu Left	MenuL	Menu Left
7	7	Digit 7	Menu Right	MenuR	Menu Right
8	8	Digit 8	Select	Sel	Menu Select
9	9	Digit 9	Exit	Exit	Exit, Cancel
0	0	Digit 0	Display	Displ	Display, OSD, Info
Volume Up	VolUp	Volume Up	Guide	Guide	Learned Only
Volume Down	VolDn	Volume Down	Page Up	PageU	Disk Skip, Disk Up
Mute	Mute	Mute	Page Down	PageD	Disk Down
Channel Up	Ch Up	Learned Only	Disk	Disk	Learned Only
Channel Dn	Ch Dn	Learned Only	Plus 10	Pls10	+10
Power	Power	Power On/Off	Open/Close	Op/Cl	Learned Only
Enter	Enter	Learned Only	Random	Randm	Learned Only
Prev Channel	PrvCh	Repeat	Track Fwd	TkFwd	Chapter/Skip Up
TV/Video	TVVid	Learned Only	Track Rev	TkRev	Chapter/Skip Down
TV/VCR	TVVCR	Learned Only	Sur On/Off	SurOn	Audio
A/B	A / B	Learned Only	Sur Mode	SurMd	Learned Only
TV/DVD	TVDVD	Learned Only	Surround Up	SurUp	Learned Only
TV/LD	TV LD	Learned Only	Surround Dn	SurDn	Learned Only
Input	Input	TV,LD,Input Select	PIP	PIP	Learned Only
TV/DSS	TVDSS	Learned Only	PIP Move	PIP M	Learned Only
Play	Play	Play	PIP Swap	PIP S	Learned Only
Stop	Stop	Stop	Program	Progm	Learned Only
Search Fwd	SrchF	Chapter/Skip Up	Sleep	Sleep	Learned Only
Search Rev	SrchR	Chapter/Skip Dn	On	On	On, Power On/Off

# INSTALLER

## KEY CODES

### LASER DISC

KEY FUNCTION	UNO-S1	LASER DISC	KEY FUNCTION	UNO-S1	LASER DISC
Off	Off	Off, Power On/Off	PIP Chan Up	PIP CU	Learned Only
11	11	Learned Only	PIP Chan Dn	PIP CD	Learned Only
12	12	Learned Only	Input 1	In 1	VID1, Video, TVp1
13	13	Learned Only	Input 2	In 2	VID2, TVp2
14	14	Learned Only	Input 3	In 3	VID3, TVp3
15	15	Learned Only	Input 4	In 4	VID4, TVp4
16	16	Learned Only	Input 5	In 5	VID5, AV1, VCR, BNC
Bright	Brght	Learned Only	Input 6	In 6	VID6, AV2, VDP, DVD, DVI
Dim	Dim	Learned Only	Input 7	In 7	TV, Component
Close	Close	Learned Only	Input 8	In 8	CAB, SAT, S-Video
Open	Open	Learned Only	Input 9	In 9	AV, Tuner
Halt	Halt	Learned Only	Input 10	In 10	AUX, RGB
AM/FM	AM/FM	Learned Only			
Cue	Cue	Learned Only			
Disk Up	DiskU	Learned Only			
Disk Down	DiskD	Learned Only			
Info	Info	Learned Only			
External Src	ExtSr	Ext AV Src, CDV, VCD, Karaoke			
Live/Intro	Intro	Intro, Search, Scan			
Menu	Menu	Learned Only			
Back	Back	Learned Only			
Fav Channel	FavCh	Mark			
Display Fmt	DFrmt	Learned Only			
SAP	SAP	Subtitle, CC			
Slow	Slow	Slow			
PIP On	PIPOn	Learned Only			
PIP Off	PIPOf	Learned Only			
PIP Freeze	PIPFr	Learned Only			
PIP Input	PIPIn	Learned Only			

# INSTALLER KEY CODES DVD

KEY FUNCTION	UNO-S1	DVD	KEY FUNCTION	UNO-S1	DVD
1	1	Digit 1, Traack 1	Pause	Pause	Pause
2	2	Digit 2, Track 2	Record	Recrd	Record
3	3	Digit 3, Track 3	Menu	Menu	Disk Menu
4	4	Digit 4, Track 4	Menu Up	MenuU	Menu Up
5	5	Digit 5, Track 5	Menu Dn	MenuD	Menu Dn
6	6	Digit 6, Track 6	Menu Left	MenuL	Menu Left
7	7	Digit 7, Track 7	Menu Right	MenuR	Menu right
8	8	Digit 8,Track 8	Select	Sel	Menu Select
9	9	Digit 9, Track 9	Exit	Exit	Exit, Cancel, Return
0	0	Digit 0, Track 10	Display	Displ	Display, OSD, Info
Volume Up	VolUp	Volume Up	Guide	Guide	Title
Volume Down	VolDn	Volume Down	Page Up	PageU	Disk Skip, Disk Up
Mute	Mute	Mute	Page Down	PageD	Disk Down
Channel Up	Ch Up	Channel Up	Disk	Disk	Learned Only
Channel Dn	Ch Dn	Channel Down	Plus 10	Pls10	+100. +10
Power	Power	Power On/Off	Open/Close	Op/Cl	Learned Only
Enter	Enter	Channel Enter	Random	Randm	Learned Only
Prev Channel	PrvCh	Last Channel,Repeat	Track Fwd	TkFwd	Chapter/Skip Up
TV/Video	TVVid	Learned Only	Track Rev	TkRev	Chapter/Skip Down
TV/VCR	TVVCR	Learned Only	Sur On/Off	SurOn	Audio, Language
A/B	A / B	Learned Only	Sur Mode	SurMd	Learned Only
TV/DVD	TVDVD	Learned Only	Surround Up	SurUp	Learned Only
TV/LD	TV LD	Learned Only	Surround Dn	SurDn	Learned Only
Input	Input	TV/DVD,Input Select	PIP	PIP	Learned Only
TV/DSS	TVDSS	Learned Only	PIP Move	PIP M	Learned Only
Play	Play	Play	PIP Swap	PIP S	Learned Only
Stop	Stop	Stop	Program	Progm	Learned Only
Search Fwd	SrchF	Fast Forward	Sleep	Sleep	Learned Only
Search Rev	SrchR	Rewind	On	On	On, Power On/Off

# INSTALLER

## KEY CODES

### DVD

KEY FUNCTION	UNO-S1	DVD	KEY FUNCTION	UNO-S1	DVD
Off	Off	Off, Power On/Off	PIP Chan Up	PIP CU	Learned Only
11	11	Learned Only	PIP Chan Dn	PIP CD	Learned Only
12	12	Learned Only	Input 1	In 1	VID1, Video, TVp1
13	13	Learned Only	Input 2	In 2	VID2, TVp2
14	14	Learned Only	Input 3	In 3	VID3, TVp3
15	15	Learned Only	Input 4	In 4	VID4, TVp4
16	16	Learned Only	Input 5	In 5	VID5, AV1, VCR, BNC
Bright	Brght	Learned Only	Input 6	In 6	VID6, AV2, VDP, DVD, DVI
Dim	Dim	Learned Only	Input 7	In 7	TV, Component
Close	Close	Learned Only	Input 8	In 8	CAB, SAT, S-Video
Open	Open	Learned Only	Input 9	In 9	AV, Tuner
Halt	Halt	Learned Only	Input 10	In 10	AUX, RGB
AM/FM	AM/FM	Learned Only			
Cue	Cue	Learned Only			
Disk Up	DiskU	Learned Only			
Disk Down	DiskD	Learned Only			
Info	Info	Learned Only			
External Src	ExtSr	External AV Source			
Live/Intro	Intro	Intro, Search, Scan			
Menu	Menu	Setup Menu			
Back	Back	Clear			
Fav Channel	FavCh	Mark			
Display Fmt	DFrmt	Format Wide, Zoom, Aspect			
SAP	SAP	Subtitle, CC			
Slow	Slow	Slow			
PIP On	PIPOn	Learned Only			
PIP Off	PIPOf	Learned Only			
PIP Freeze	PIPFr	Learned Only			
PIP Input	PIPIn	Learned Only			



# INSTALLER KEY CODES RECEIVER

KEY FUNCTION	UNO-S1	RECEIVER	KEY FUNCTION	UNO-S1	RECEIVER
1	1	Digit 1	Pause	Pause	Pause
2	2	Digit 2	Record	Recrd	Record
3	3	Digit 3	Menu	Menu	Disk menu, Menu
4	4	Digit 4	Menu Up	MenuU	Menu Up, Adjust Up
5	5	Digit 5	Menu Dn	MenuD	Menu Dn, Adjust Dn
6	6	Digit 6	Menu Left	MenuL	Menu Left
7	7	Digit 7	Menu Right	MenuR	Menu Right
8	8	Digit 8	Select	Sel	MenuS elect, Continue
9	9	Digit 9	Exit	Exit	Exit, Cancel
0	0	Digit 0	Display	Displ	Display, OSD, Info
Volume Up	VolUp	Volume Up	Guide	Guide	Title
Volume Down	VolDn	Volume Down	Page Up	PageU	Adjust Up
Mute	Mute	Mute	Page Down	PageD	Adjust Down
Channel Up	Ch Up	Preset Up	Disk	Disk	Learned Only
Channel Dn	Ch Dn	Preset Down	Plus 10	Pls10	Band, FM/AM
Power	Power	Power On/Off	Open/Close	Op/Cl	Learned Only
Enter	Enter	5.1, Prologic	Random	Randm	Random
Prev Channel	PrvCh	Last Channel, Repeat	Track Fwd	TkFwd	Skip Up
TV/Video	TVVid	Learned Only	Track Rev	TkRev	Skip Down
TV/VCR	TVVCR	Learned Only	Sur On/Off	SurOn	Srrd Mode/On Off,Aduo Lang
A/B	A / B	Learned Only	Sur Mode	SurMd	Learned Only
TV/DVD	TVDVD	Learned Only	Surround Up	SurUp	Learned Only
TV/LD	TV LD	Learned Only	Surround Dn	SurDn	Learned Only
Input	Input	DVD/Tuner,Input Select	PIP	PIP	Learned Only
TV/DSS	TVDSS	Learned Only	PIP Move	PIP M	Learned Only
Play	Play	Play	PIP Swap	PIP S	Learned Only
Stop	Stop	Stop	Program	Progm	Learned Only
Search Fwd	SrchF	Fast Forward	Sleep	Sleep	Learned Only
Search Rev	SrchR	Rewind	On	On	On, Power On/Off

# INSTALLER KEY CODES RECEIVER

KEY FUNCTION	UNO-S1	RECEIVER
Off	Off	Off, Power On/Off
11	11	Learned Only
12	12	Learned Only
13	13	Learned Only
14	14	Learned Only
15	15	Learned Only
16	16	Learned Only
Bright	Brght	Learned Only
Dim	Dim	Learned Only
Close	Close	Learned Only
Open	Open	Learned Only
Halt	Halt	Learned Only
AM/FM	AM/FM	Learned Only
Cue	Cue	Learned Only
Disk Up	DiskU	Learned Only
Disk Down	DiskD	Learned Only
Info	Info	Learned Only
External Src	ExtSr	External AV Source
Live/Intro	Intro	Intro,Search,Scan
Menu	Menu	Menu
Back	Back	Clear
Fav Channel	FavCh	Mark
Display Fmt	DFrmt	FormatWide,Zoom,Aspect
SAP	SAP	Learned Only
Slow	Slow	Slow
PIP On	PIPOn	Learned Only
PIP Off	PIPOf	Learned Only
PIP Freeze	PIPFr	Learned Only
PIP Input	PIPIn	Learned Only

KEY FUNCTION	UNO-S1	RECEIVER
PIP Chan Up	PIP CU	Learned Only
PIP Chan Dn	PIP CD	Learned Only
Input 1	In 1	CD
Input 2	In 2	Tuner
Input 3	In 3	DVD, LD
Input 4	In 4	VCR, VID1
Input 5	In 5	VID5,AV1,VCR,BNC
Input 6	In 6	TV, VID2
Input 7	In 7	LD, VID3
Input 8	In 8	AUX, VID4
Input 9	In 9	DAT, Cable
Input 10	In 10	Phono SAT

# INSTALLER KEY CODES AMP/MISC AUDIO

KEY FUNCTION	UNO-S1	AMP/MISC AUDIO	KEY FUNCTION	UNO-S1	AMP/MISC AUDIO
1	1	Digit 1	Pause	Pause	Pause
2	2	Digit 2	Record	Recrd	Record
3	3	Digit 3	Menu	Menu	Menu, Program
4	4	Digit 4	Menu Up	MenuU	Menu Up, Adjust Up
5	5	Digit 5	Menu Dn	MenuD	Menu Dn, Adjust Dn
6	6	Digit 6	Menu Left	MenuL	Menu Left
7	7	Digit 7	Menu Right	MenuR	Menu Right
8	8	Digit 8	Select	Sel	Menu Select, Cont
9	9	Digit 9	Exit	Exit	Exit, Cancel
0	0	Digit 0	Display	Displ	Display, OSD, Info
Volume Up	VolUp	Volume Up	Guide	Guide	Learned Only
Volume Down	VolDn	Volume Down	Page Up	PageU	Adjust Up
Mute	Mute	Mute	Page Down	PageD	Adjust Down
Channel Up	Ch Up	Preset Up	Disk	Disk	Learned Only
Channel Dn	Ch Dn	Preset Down	Plus 10	Pls10	Band, FM/AM
Power	Power	Power On/Off	Open/Close	Op/Cl	Learned Only
Enter	Enter	5.1, Prologic	Random	Randm	Learned Only
Prev Channel	PrvCh	Repeat	Track Fwd	TkFwd	Skip Up
TV/Video	TVVid	Learned Only	Track Rev	TkRev	Skip Down
TV/VCR	TVVCR	Learned Only	Sur On/Off	SurOn	Srrd Mode/On Off,Aduo Lang
A/B	A / B	Learned Only	Sur Mode	SurMd	Learned Only
TV/DVD	TVDVD	Learned Only	Surround Up	SurUp	Learned Only
TV/LD	TV LD	Learned Only	Surround Dn	SurDn	Learned Only
Input	Input	Bypass,Input Slct	PIP	PIP	Learned Only
TV/DSS	TVDSS	Learned Only	PIP Move	PIP M	Learned Only
Play	Play	Play	PIP Swap	PIP S	Learned Only
Stop	Stop	Stop	Program	Progm	Learned Only
Search Fwd	SrchF	Fast Forward	Sleep	Sleep	Learned Only
Search Rev	SrchR	Rewind	On	On	On, Power On/Off

# INSTALLER

## KEY CODES

### AMP/MISC AUDIO

KEY FUNCTION	UNO-S1	AMP/MISC AUDIO	KEY FUNCTION	UNO-S1	AMP/MISC AUDIO
Off	Off	Off, Power On/Off	PIP Chan Up	PIPCU	Learned Only
11	11	Learned Only	PIP Chan Dn	PIPCD	Learned Only
12	12	Learned Only	Input 1	In 1	CD
13	13	Learned Only	Input 2	In 2	Tuner
14	14	Learned Only	Input 3	In 3	DVD, LD
15	15	Learned Only	Input 4	In 4	TAPE, MD
16	16	Learned Only	Input 5	In 5	VCR, VID1
Bright	Brght	Learned Only	Input 6	In 6	TV, VID2
Dim	Dim	Learned Only	Input 7	In 7	LD, VID3
Close	Close	Learned Only	Input 8	In 8	AUX, VID4
Open	Open	Learned Only	Input 9	In 9	DAT, Cable
Halt	Halt	Learned Only	Input 10	In 10	Phono, SAT
AM/FM	AM/FM	Learned Only			
Cue	Cue	Learned Only			
Disk Up	DiskU	Learned Only			
Disk Down	DiskD	Learned Only			
Info	Info	Learned Only			
External Src	ExtSr	External AV Source			
Live/Intro	Intro	Intro,Search,Scan			
Menu	Menu	Learned Only			
Back	Back	Clear			
Fav Channel	FavCh	Learned Only			
Display Fmt	DFrmt	Learned Only			
SAP	SAP	Learned Only			
Slow	Slow	Learned Only			
PIP On	PIPOn	Learned Only			
PIP Off	PIPOf	Learned Only			
PIP Freeze	PIPFr	Learned Only			
PIP Input	PIPIn	Learned Only			

# INSTALLER KEY CODES CD

KEY FUNCTION	UNO-S1	CD	KEY FUNCTION	UNO-S1	CD
1	1	Digit 1, Track 1,Dsc1	Pause	Pause	Pause
2	2	Digit 2, Track 2,Dsc2	Record	Recrd	Record
3	3	Digit 3, Track 3,Dsc3	Menu	Menu	Disk, Edit
4	4	Digit 4, Track 4,Dsc4	Menu Up	MenuU	Menu Up
5	5	Digit 5, Track 5,Dsc5	Menu Dn	MenuD	Menu Down
6	6	Digit 6, Track 6,Dsc6	Menu Left	MenuL	Menu Left
7	7	Digit 7, Track 7,Dsc7	Menu Right	MenuR	Menu Right
8	8	Digit 8,Track 8,Dsc8	Select	Sel	Menu Select, Cont
9	9	Digit 9, Track 9,Dsc9	Exit	Exit	Exit, Cancel
0	0	Digit 0, Trck10,Dsc10	Display	Displ	Display, OSD, Info
Volume Up	VolUp	Volume Up	Guide	Guide	Group,Magazine
Volume Down	VolDn	Volume Down	Page Up	PageU	Disk Skip, Disk Up
Mute	Mute	Mute	Page Down	PageD	Disk Down
Channel Up	Ch Up	Learned Only	Disk	Disk	Learned Only
Channel Dn	Ch Dn	Learned Only	Plus 10	Pls10	+10, +100
Power	Power	Power On/Off	Open/Close	Op/Cl	Learned Only
Enter	Enter	Set	Random	Randm	Learned Only
Prev Channel	PrvCh	Repeat	Track Fwd	TkFwd	Skip Up
TV/Video	TVVid	Learned Only	Track Rev	TkRev	Skip Down
TV/VCR	TVVCR	Learned Only	Sur On/Off	SurOn	Learned Only
A/B	A / B	Learned Only	Sur Mode	SurMd	Learned Only
TV/DVD	TVDVD	Learned Only	Surround Up	SurUp	Learned Only
TV/LD	TV LD	Learned Only	Surround Dn	SurDn	Learned Only
Input	Input	DVD/Tuner Input Select	PIP	PIP	Learned Only
TV/DSS	TVDSS	Learned Only	PIP Move	PIP M	Learned Only
Play	Play	Play	PIP Swap	PIP S	Learned Only
Stop	Stop	Stop	Program	Progm	Learned Only
Search Fwd	SrchF	Fast Forward	Sleep	Sleep	Learned Only
Search Rev	SrchR	Rewind	On	On	On, Power On/Off

# INSTALLER KEY CODES CD

KEY FUNCTION	UNO-S1	CD
Off	Off	Off, Power On/Off
11	11	Learned Only
12	12	Learned Only
13	13	Learned Only
14	14	Learned Only
15	15	Learned Only
16	16	Learned Only
Bright	Brght	Learned Only
Dim	Dim	Learned Only
Close	Close	Learned Only
Open	Open	Learned Only
Halt	Halt	Learned Only
AM/FM	AM/FM	Learned Only
Cue	Cue	Learned Only
Disk Up	DiskU	Learned Only
Disk Down	DiskD	Learned Only
Info	Info	Learned Only
External Src	ExtSr	CD/CDR/MD, Input Select
Live/Intro	Intro	Intro, Search, Scan
Menu	Menu	Menu, Program
Back	Back	Track, Clear
Fav Channel	FavCh	Finalize, Index
Display Fmt	DFrmt	Learned Only
SAP	SAP	Learned Only
Slow	Slow	Learned Only
PIP On	PIPOn	Learned Only
PIP Off	PIPOf	Learned Only
PIP Freeze	PIPFr	Learned Only
PIP Input	PIPIn	Learned Only

KEY FUNCTION	UNO-S1	CD
PIP Chan Up	PIP CU	Learned Only
PIP Chan Dn	PIP CD	Learned Only
Input 1	In 1	CD
Input 2	In 2	Tuner
Input 3	In 3	DVD, LD
Input 4	In 4	Tape, MD
Input 5	In 5	VCR, VID1
Input 6	In 6	TV, VID2
Input 7	In 7	LD, VID3
Input 8	In 8	AUX, VID4
Input 9	In 9	DAT, Cable
Input 10	In 10	Phono, SAT

# INSTALLER KEY CODES HOME CONTROL

KEY FUNCTION	UNO-S1	HOME CONTROL	KEY FUNCTION	UNO-S1	HOME CONTROL
1	1	Digit 1	Pause	Pause	Pause
2	2	Digit 2	Record	Recrd	Record
3	3	Digit 3	Menu	Menu	Menu
4	4	Digit 4	Menu Up	MenuU	Menu Up, Mode
5	5	Digit 5	Menu Dn	MenuD	Menu Dn, Timer
6	6	Digit 6	Menu Left	MenuL	Menu Left, Oscillate
7	7	Digit 7	Menu Right	MenuR	Menu Right, Speed
8	8	Digit 8	Select	Sel	Menu Select, Light
9	9	Digit 9	Exit	Exit	Exit, Cancel
0	0	Digit 0	Display	Displ	Learned Only
Volume Up	VolUp	Volume Up	Guide	Guide	Learned Only
Volume Down	VolDn	Volume Down	Page Up	PageU	Learned Only
Mute	Mute	Mute	Page Down	PageD	Learned Only
Channel Up	Ch Up	Bright, Raise Up	Disk	Disk	Learned Only
Channel Dn	Ch Dn	Dim, Lower Down	Plus 10	Pls10	Learned Only
Power	Power	Power On/Off	Open/Close	Op/Cl	Learned Only
Enter	Enter	Learned Only	Random	Randm	Learned Only
Prev Channel	PrvCh	Learned Only	Track Fwd	TkFwd	Learned Only
TV/Video	TVVid	Learned Only	Track Rev	TkRev	Learned Only
TV/VCR	TVVCR	Learned Only	Sur On/Off	SurOn	Learned Only
A/B	A / B	Learned Only	Sur Mode	SurMd	Learned Only
TV/DVD	TVDVD	Learned Only	Surround Up	SurUp	Learned Only
TV/LD	TV LD	Learned Only	Surround Dn	SurMd	Learned Only
Input	Input	Home, Source	PIP	PIP	Learned Only
TV/DSS	TVDSS	Learned Only	PIP Move	PIP M	Learned Only
Play	Play	Play	PIP Swap	PIP S	Learned Only
Stop	Stop	Stop	Program	Progm	Learned Only
Search Fwd	SrchF	Fast Forward, Open	Sleep	Sleep	Learned Only
Search Rev	SrchR	Rewind, Close	On	On	On, Power On/Off

# INSTALLER

## KEY CODES

### HOME CONTROL

KEY FUNCTION	UNO-S1	HOME CONTROL	KEY FUNCTION	UNO-S1	HOME CONTROL
Off	Off	Off, Power On/Off	PIP Chan Up	PIP CU	Learned Only
11	11	Learned Only	PIP Chan Dn	PIP CD	Learned Only
12	12	Learned Only	Input 1	In 1	Source/Scene 1
13	13	Learned Only	Input 2	In 2	Source/Scene 2
14	14	Learned Only	Input 3	In 3	Source/Scene 3
15	15	Learned Only	Input 4	In 4	Source/Scene 4
16	16	Learned Only	Input 5	In 5	Source/Scene 5
Bright	Brght	Learned Only	Input 6	In 6	Source/Scene 6
Dim	Dim	Learned Only	Input 7	In 7	Source/Scene 7
Close	Close	Learned Only	Input 8	In 8	Source/Scene 8
Open	Open	Learned Only	Input 9	In 9	Source/Scene 9
Halt	Halt	Learned Only	Input 10	In 10	Source/Scene 10
AM/FM	AM/FM	Learned Only			
Cue	Cue	Learned Only			
Disk Up	DiskU	Learned Only			
Disk Down	DiskD	Learned Only			
Info	Info	Learned Only			
External Src	ExtSr	External Source			
Live/Intro	Intro	Learned Only			
Menu	Menu	Learned Only			
Back	Back	Learned Only			
Fav Channel	FavCh	Learned Only			
Display Fmt	DFrmt	Learned Only			
SAP	SAP	Learned Only			
Slow	Slow	All On			
PIP On	PIPOn	Learned Only			
PIP Off	PIPOf	Learned Only			
PIP Freeze	PIPFr	Learned Only			
PIP Input	PIPIn	Learned Only			



## INSTALLER SOURCE NAMES

UNO-S1	UNO-S2	UNO-S1	UNO-S2	UNO-S1	UNO-S2
Aux	AUX		CustomName3	DVD 3	DVD Player 3
Aux 1	AUX 1		CustomName4	FDoor	Front Door
Aux 2	AUX 2		CustomName5	Hers	Her Music
Blues	Blues		CustomName6	His	His Music
Cable	Cable		CustomName7	www.	Intrnet Radio
Cbl 1	Cable 1		CustomName8	Jazz	Jazz
Cbl 2	Cable 2		CustomName9	Kids	Kids Music
Cbl 3	Cable 3		CustomName10	LD	Laser Disk
CDCh	CD Changer	Dance	Dance Music	MSvr	Media Server
CDCh1	CD Changer 1	DigCb	Digitl Cable	MSvr1	Media Svr 1
CDCh2	CD Changer 2	DSS	DSS Receiver	MSvr2	Media Svr 2
CDCh3	CD Changer 3	DSS 1	DSS 1	MSvr3	Media Svr 3
CD	CD Player	DSS 2	DSS 2	MiniD	Mini Disk
CD 1	CD Player 1	DSS 3	DSS 3	Misc	Misc Lrnd IR
CD 2	CD Player 2	DVDCh	DVD Changer	Mood	Mood Music
CD 3	CD Player 3	DVDC1	DVD Changr1	MornM	MorningMusic
Class	Classical	DVDC2	DVD Changr2	MP3	MP3
Compr	Computer	DVDC3	DVD Changr3	Oldes	Oldies
Cntry	Country	DVD	DVD Player	Pop	Pop
	CustomName1	DVD 1	DVD Player 1	RDoor	Rear Door
	CustomName2	DVD 2	DVD Player 2	Relig	Religious

# INSTALLER

## SOURCE NAMES

UNO-S1	UNO-S2	UNO-S1	UNO-S2
RepTV	Replay TV	Tun 1	Tuner 1
Rock	Rock	Tun 2	Tuner 2
Sat	Satellite	Tun 3	Tuner 3
Sat 1	Satellite 1	TV	TV
Sat 2	Satellite 2	VCR	VCR
Sat 3	Satellite 3	VCR 1	VCR 1
SatRd	Sat Radio	VCR 2	VCR 2
Src 1	Source 1	<XM>	<<<XM>>>
Src 2	Source 2	XM 1	XM 1
Src 3	Source 3	XM 2	XM 2
Src 4	Source 4	XM 3	XM 3
Src 5	Source 5	XM	XM Radio
Src 6	Source 6		
Src 7	Source 7		
Src 8	Source 8		
Spcl	Special		
Tape	Tape		
Tape1	Tape 1		
Tape2	Tape 2		
TiVo	TIVO		
Tuner	Tuner		

# SAMPLE CONFIGURATIONS MULTIPLE CONTROLLERS WITH ONE TUNER

Sharing a single CAM6.6X (internal tuner) with multiple controllers

This arrangement can support up to six CAM6.6 units for up to 36 zones/6 sources. Each additional CAM6.6 must have an incremental Controller ID # and RNET link. Audio from the source tuner can be split if used for all controllers.

### CAM6.6X -

Controller Setup Menu: Controller ID = 1

Peripheral Setup Menu: Controller ID = All Controllers  
Output/Input Switch = Internal Source Output  
RCA cable connected to Source 1

### CAM6.6 (no tuner installed) -

Controller Setup Menu: Controller ID = 2  
Source Setup Menu: Basic Setup Procedure:  
Source # = 1; Source Name = Tuner;  
Command Type = Peripheral

Output/Input Switch = Input  
RCA cable connected to Source 1

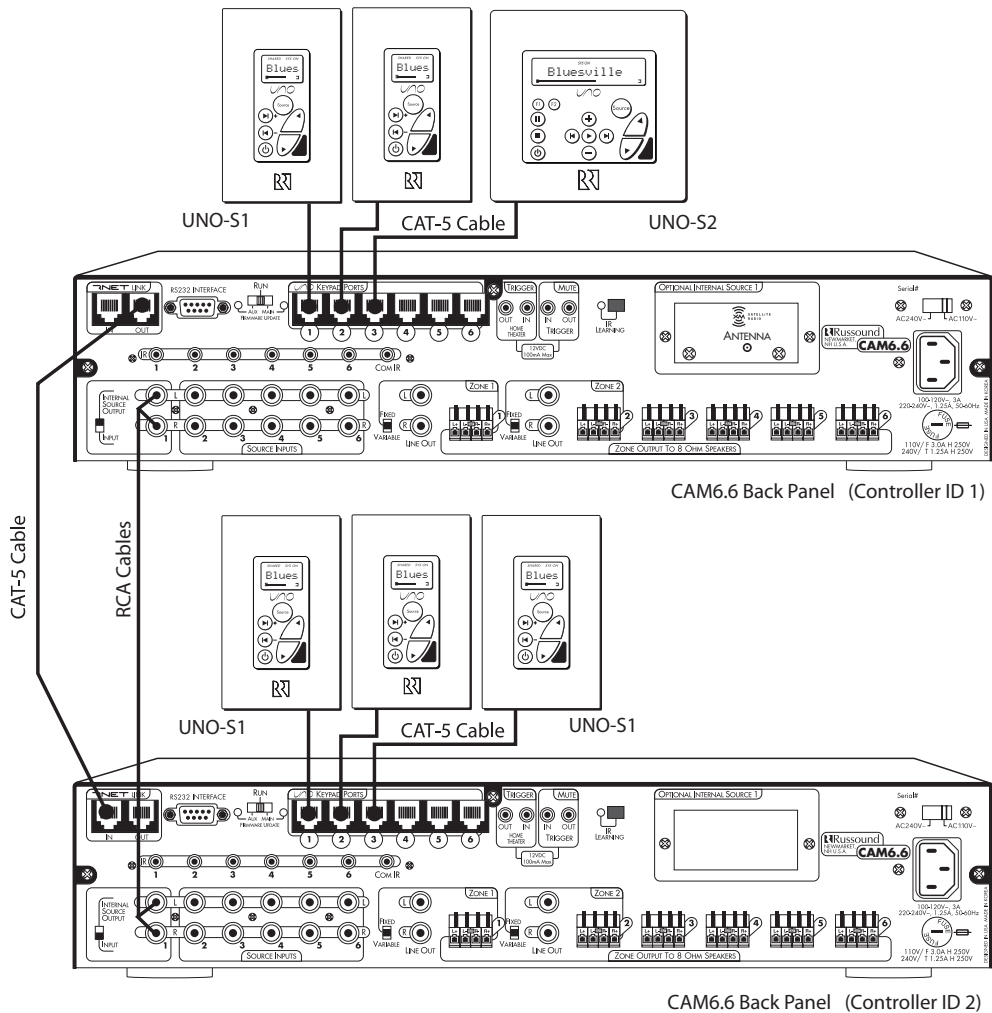

# SAMPLE CONFIGURATIONS

## MULTIPLE CONTROLLERS WITH TWO TUNERS

System with two CAM6.6X (internal tuner) controllers

The configuration below is suitable for 7-12 zones that will have access to the tuner in the controller to which its keypad is connected only. Built-in tuners are always Source 1 and cannot be changed. If you have more than one internal tuner, you must set each tuner to its specific Controller ID number. If you want each controller to have access to dual tuners, a suggested solution is to use an ST2 Dual Tuner with two CAM6.6s as shown on the next page.

**CAM6.6X (1) -**

Controller Setup Menu: Controller ID = 1  
Peripheral Setup Menu: Controller ID = 1

**CAM6.6X (2) -**

Controller Setup Menu: Controller ID = 2  
Peripheral Setup Menu: Controller ID = 2

A CAT-5 patch cable is use to connect the RNET Link Out of Controller 1 to the RNET Link In of Controller 2.

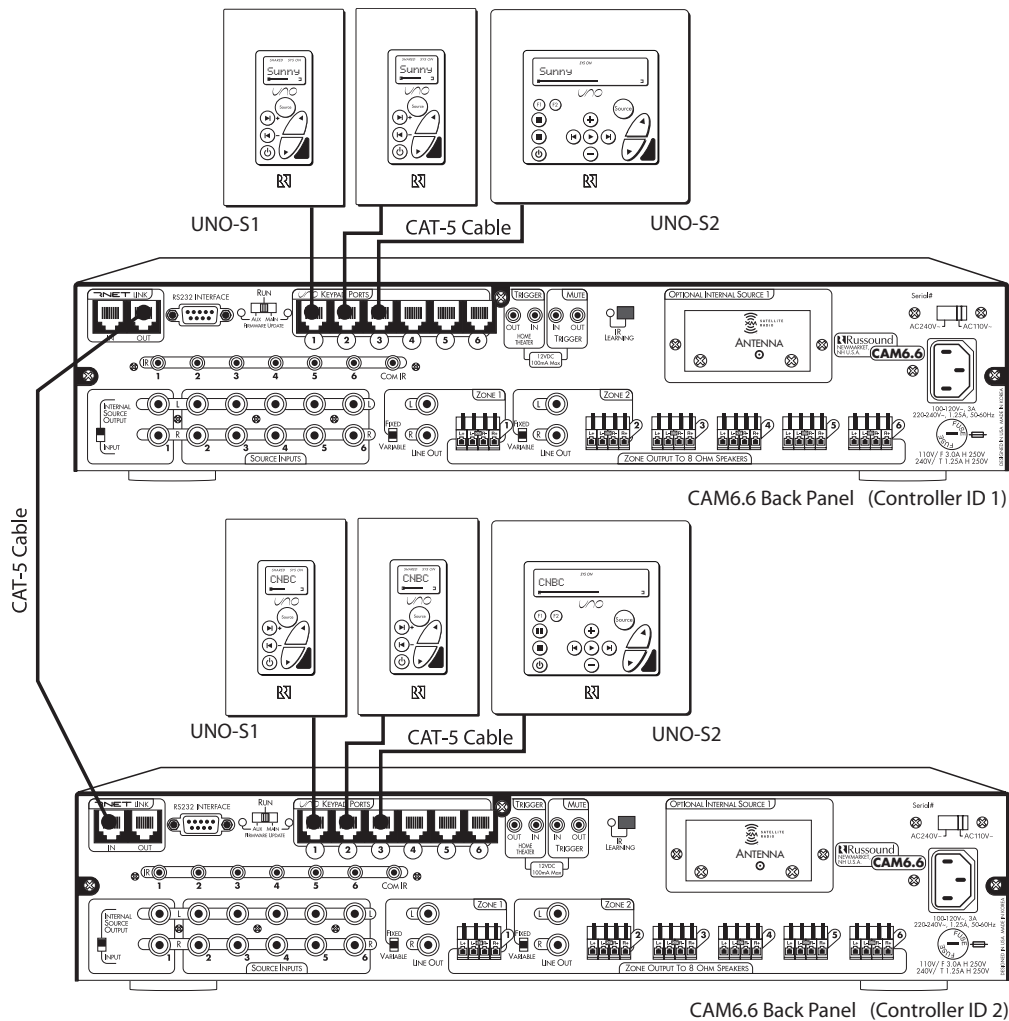

## SAMPLE CONFIGURATIONS MULTIPLE CONTROLLERS WITH THREE TUNERS

*Sharing an ST2 Dual Tuner with multiple CAM6.6 controllers (with and without tuners)*

The configuration below is suitable for 7 to 12 zones that can access the ST2 Dual Tuner and the CAM6.6X tuner. This configuration uses RCA "Y" cables from the ST2 Tuner source outputs to connect to both CAM6.6 source inputs.

### **CAM6.6X -**

Controller Setup Menu: Controller ID = 1  
 Peripheral Setup Menu: Controller ID = All Controllers  
 Source Setup Menu: Basic Setup Procedure:  
 Source # = 2; Source Name = XM;  
 Command Type = Peripheral  
 Source # = 3; Source Name = AM/FM;  
 Command Type = Peripheral  
 Output/Input Switch = Internal Source Output  
 RCA cable connected from Source 1 audio output on CAM6.6X (1) to Source 1 input on CAM6.6 (2)  
 RCA cable connected from ST2 Tuner 1 audio output

to Source 2 input on CAM6.6X (1)  
 RCA cable connected from ST2 Tuner 2 audio output to Source 3 input on CAM6.6X (1)

### **CAM6.6 (no tuner installed) -**

Controller Setup Menu: Controller ID = 2  
 Source Setup Menu: Basic Setup Procedure:  
 Source # = 1; Source Name = Tuner;  
 Command Type = Peripheral  
 Source # = 2; Source Name = XM;  
 Command Type = Peripheral  
 Source # = 3; Source Name = AM/FM;  
 Command Type = Peripheral  
 Output/Input Switch = Input  
 RCA cable connected from Source 1 audio output on CAM6.6X (1) to Source 1 input on CAM6.6 (2)  
 RCA cable connected from ST2 Tuner 1 audio output to Source 2 input on CAM6.6 (2)  
 RCA cable connected from ST2 Tuner 2 audio output to Source 3 input on CAM6.6 (2)

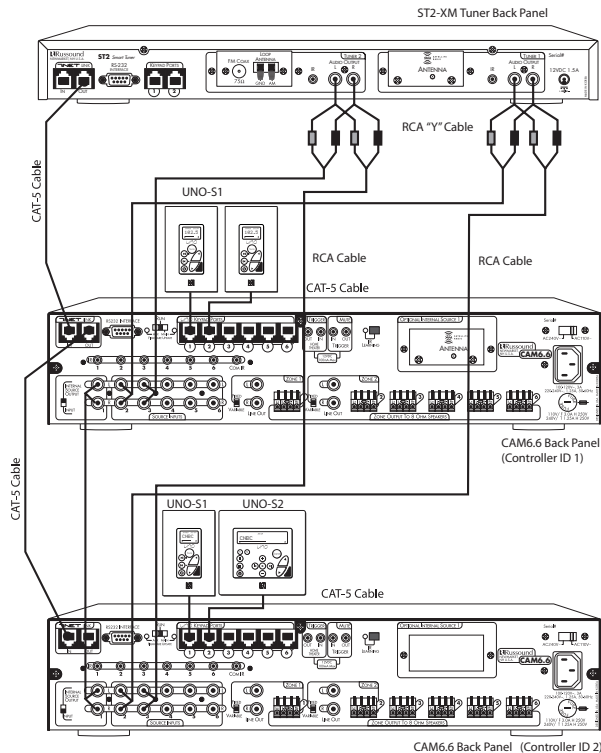

# SAMPLE CONFIGURATIONS

## MULTIPLE CONTROLLERS WITH ST2 DUAL TUNER

Sharing an ST2 Dual Tuner with multiple CAM6.6 controllers (no built-in tuners)

This configuration is suitable for 7 to 12 zones that can all access the ST2 Dual Tuner. This configuration uses RCA "Y" cables from the ST2 Tuner source outputs to connect to both CAM6.6 source inputs.

### CAM6.6 (no tuner installed) -

Controller Setup Menu: Controller ID = 1  
 Source Setup Menu: Basic Setup Procedure:  
 Source # = 1; Source Name = Tuner 1;  
 Command Type = Peripheral  
 Source # = 2; Source Name = Tuner 2;  
 Command Type = Peripheral  
 Output/Input Switch = Input  
 RCA cable connected from ST2 Tuner 1 audio output

to Source 1 input on CAM6.6 (1)  
 RCA cable connected from ST2 Tuner 2 audio output  
 to Source 2 input on CAM6.6 (1)

### CAM6.6 (no tuner installed) -

Controller Setup Menu: Controller ID = 2  
 Source Setup Menu: Basic Setup Procedure:  
 Source # = 1; Source Name = Tuner 1;  
 Command Type = Peripheral  
 Source # = 2; Source Name = Tuner 2;  
 Command Type = Peripheral  
 Output/Input Switch = Input  
 RCA cable connected from ST2 Tuner 1 audio output  
 to Source 1 input on CAM6.6 (1)  
 RCA cable connected from ST2 Tuner 2 audio output  
 to Source 2 input on CAM6.6 (2)

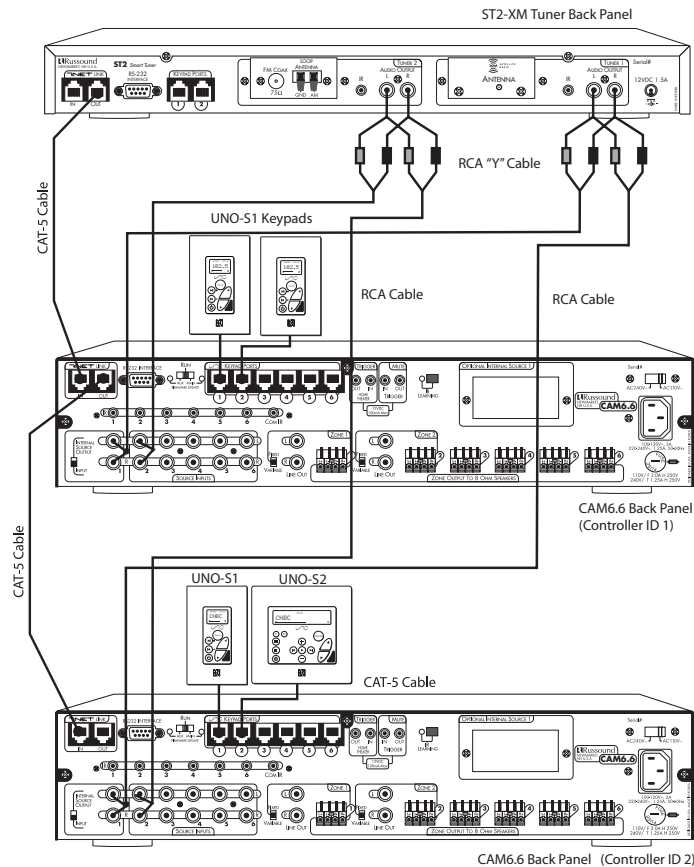

## TECHNICAL SPECIFICATIONS



Dimensions:	17"W x 12"D x 3.5"H (43 x 30.5 x 9 cm)
Weight:	18 lbs. (8.1 kg)
Power Supply:	110 or 240 VAC
Fuse Rating:	110V input; F3A H 250V US and Canada 240V input; T1.25A H 250V Europe
Frequency Response:	20Hz-20kHz +/- 1dB
Watts per channel:	20 Watts RMS into 8 Ohms
THD+N:	<0.05%
Signal to Noise Ratio:	>88dB
Audio Source Inputs:	6 (including internal tuner)
Input Impedance:	50 kohm
Audio Zone Outputs:	6 Speaker Level (8 ohms) (2 Line level)
Max Source Audio Input:	2.2 Vrms
Max Zone Variable Line Audio Output:	2.2 Vrms
Max Zone Fixed Line Audio Output:	2.2 Vrms
Trigger Outputs:	1 Common. 12VDC 100mA
Trigger Inputs:	1 Home Theater 12VDC Max

### **XM**

XM Band:	2332.5 - 2345 MHz
XM Antenna:	50-ohm SMB connection

It is prohibited to copy, decompile, disassemble, reverse engineer, or manipulate any technology incorporated in receivers compatible with the XM Satellite Radio system. Furthermore, the AMBE® voice compression software included in this product is protected by intellectual property rights including patent rights, copyrights, and trade secrets of Digital Voice Systems, Inc. The user of this or any other software contained in an XM radio is explicitly prohibited from attempting to copy, decompile, reverse engineer, or disassemble the object code, or in any way convert the object code into human-readable form. The software is licensed solely for use within this product.

## WARRANTY & REPAIR

The Russound CAM6.6 is fully guaranteed against all defects in materials and workmanship for two (2) years from the date of purchase. During this period, Russound will replace any defective parts and correct any defect in workmanship without charge for either parts or labor.

For this warranty to apply, the unit must be installed and used according to its written instructions. If service is necessary, it must be performed by Russound. The unit must be returned to Russound at the owner's expense and with prior written permission. Accidental damage and shipping damage are not considered defects, nor is damage resulting from abuse or from servicing by an agency or person not specifically authorized in writing by Russound.

This Warranty does not cover:

- Damage caused by abuse, accident, misuse, negligence, or improper installation or operation
- Power surges and lightning strikes
- Normal wear and maintenance
- Products that have been altered or modified
- Any product whose identifying number, decal, serial number, etc. has been altered, defaced or removed

Russound sells products only through authorized Dealers and Distributors to ensure that customers obtain proper support and service. Any Russound product purchased from an unauthorized dealer or other source, including retailers, mail order sellers and online sellers will not be honored or serviced under existing Russound warranty policy. Any sale of products by an unauthorized source or other manner not authorized by Russound shall void the warranty on the applicable product.

Damage to or destruction of components due to application of excessive power voids the warranty on those parts. In these cases, repairs will be made on the basis of the retail value of the parts and labor. To return for repairs, the unit must be shipped to Russound at the owner's expense, along with a note explaining the nature of service required. Be sure to pack the unit in a corrugated container with at least three (3) inches of resilient material to protect the unit from damage in transit.

Before returning a unit for repair, call Russound at (603) 659-5170 for a Return Authorization number. Write this number on the shipping label and ship to:

Russound  
ATTN: Service  
5 Forbes Road  
Newmarket, NH 03857

Due to continual efforts to improve product quality as new technology and techniques become available, Russound/FMP, Inc. reserves the right to revise system specifications without notice.











# Russound®

Russound  
5 Forbes Road, Newmarket, NH 03857  
tel 603.659.5170 • fax 603.659.5388  
e-mail: [tech@russound.com](mailto:tech@russound.com)  
[www.russound.com](http://www.russound.com)

28-0112 10/07/04

Copyright © 2004 Russound®. All rights reserved.

## Free Manuals Download Website

<http://myh66.com>

<http://usermanuals.us>

<http://www.somanuals.com>

<http://www.4manuals.cc>

<http://www.manual-lib.com>

<http://www.404manual.com>

<http://www.luxmanual.com>

<http://aubethermostatmanual.com>

Golf course search by state

<http://golfingnear.com>

Email search by domain

<http://emailbydomain.com>

Auto manuals search

<http://auto.somanuals.com>

TV manuals search

<http://tv.somanuals.com>