

Operator's manual **M48 Pro M53 S Pro**

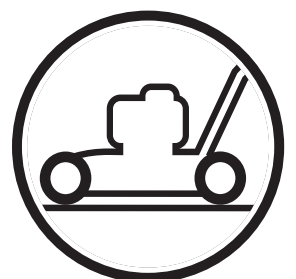

Please read the operator's manual carefully and make sure you understand the instructions before using the machine.

English

KEY TO SYMBOLS

Key to symbols

WARNING! The machine can be a dangerous tool if used incorrectly or carelessly, which can cause serious or fatal injury to the operator or others.



Please read the operator's manual carefully and make sure you understand the instructions before using the machine.



Always wear:

- Approved hearing protection



Never use the machine if persons, especially children or pets, are in the immediate vicinity.



Watch out for thrown objects and ricochets.



Warning: rotating cutter. Keep hands and feet clear.



This product is in accordance with applicable EC directives.



Noise emission to the environment according to the European Community's Directive. The machine's emission is specified in chapter Technical data and on label.



The engine is stopped.



Drive position



Neutral

Other symbols/decals on the machine refer to special certification requirements for certain markets.

Always wear protective gloves.

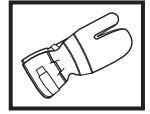

Regular cleaning is required.

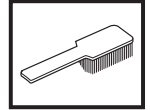

Visual check.



The ignition lead should always be removed from the spark plug before repair, cleaning or maintenance work.

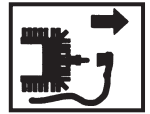

Switch off the engine by releasing the engine brake handle before carrying out any checks or maintenance.

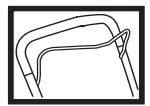

Steps before using a new lawn mower

- Please read the operator's manual carefully.
- Check that the cutting equipment is correctly fitted and adjusted. See instructions under the heading Assembly.
- Fill with fuel and oil in the engine. A container with sufficient oil quantity is supplied with the machine. See the instructions under the heading fuel handling.



WARNING! Under no circumstances may the design of the machine be modified without the permission of the manufacturer. Always use genuine accessories. Non-authorized modifications and/or accessories can result in serious personal injury or the death of the operator or others.



WARNING! A lawn mower is a dangerous tool if used carelessly or incorrectly and can cause serious, even fatal injuries. It is extremely important that you read and understand the contents of this operator's manual.



WARNING! Long-term inhalation of the engine's exhaust fumes can represent a health hazard.

Husqvarna AB has a policy of continuous product development and therefore reserves the right to modify the design and appearance of products without prior notice.

CONTENTS

Contents

KEY TO SYMBOLS

Key to symbols	2
Steps before using a new lawn mower	2

CONTENTS

Contents	3
----------------	---

SAFETY INSTRUCTIONS

Personal protection	4
Machine's safety equipment	4
Checking, maintaining and servicing the machine's safety equipment	5
General safety precautions	6
General working instructions	8

WHAT IS WHAT?

What is what on the lawn mower? M48 Pro.....	10
What is what on the lawn mower? M53 S Pro	11

ASSEMBLY

Fitting the handlebar	12
Dismantling and assembling the cutter	12

FUEL HANDLING

Fuel	13
------------	----

STARTING AND STOPPING

Starting and stopping	14
-----------------------------	----

MAINTENANCE

Maintenance	16
Air filter	16
Spark plug	16
Muffler	16
Cutter	17
Changing the oil	17
Lubrication of the cutting height adjustment	17
Drive and gearbox	18
Daily maintenance	18
Weekly maintenance	18
Monthly maintenance	18

TECHNICAL DATA

Technical data	19
EC-declaration of conformity	20

SAFETY INSTRUCTIONS

Personal protection



WARNING! You must use personal protection whenever you use the machine.

- Hearing protection



- Gloves must be worn when required, for example when fitting, inspecting or cleaning cutting attachments.



- Always wear heavy, long pants. Do not wear shorts, sandals or go barefoot.

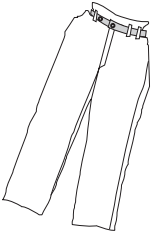

- Wear sturdy, non-slip boots or shoes.



Generally clothes should be close-fitting without restricting your freedom of movement.

Machine's safety equipment

This section describes the machine's safety equipment, its purpose, and how checks and maintenance should be carried out to ensure that it operates correctly. See the "What is what?" section to locate where this equipment is positioned on your machine.



WARNING! Never use a machine that has faulty safety equipment! Carry out the inspection, maintenance and service routines listed in this section.

- Cutting cover and protective cover

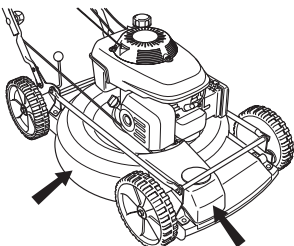

- Engine brake handle

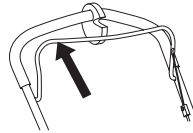

- Vibration damping system

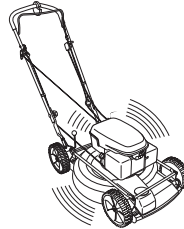

- Muffler

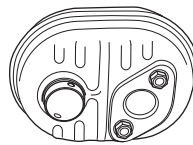

- Cutting equipment



Cutting cover and protective cover

On lawn mower M53 S Pro there is a protective cover mounted over the drive's gearbox.

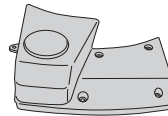

The protective cover is designed to reduce the risk of crush injuries and to catch a broken drive belt.

The cutting cover is designed to reduce vibration and to reduce the risk of cuts.

Engine brake handle

The engine brake is designed to stop the engine. When the grip on the engine brake handle is released the engine should stop.

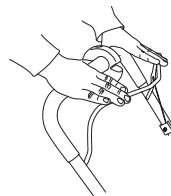

On lawn mower M53 S Pro the engine brake handle should also disengage the drive.

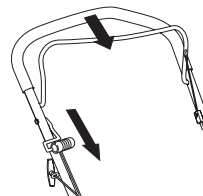

SAFETY INSTRUCTIONS

Vibration damping system

Your machine is equipped with a vibration damping system that is designed to minimize vibration and make operation easier.

The handlebar system's steel tube and the cutting cover are designed to minimise the vibrations from the engine.

This model also has a vibration damper fitted on the handlebar unit to further reduce vibrations.

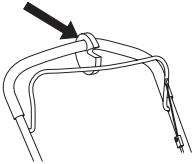

The machine's vibration damping system reduces the transfer of vibration between the engine unit/cutting equipment and the machine's handle unit.



WARNING! Overexposure to vibration can lead to circulatory damage or nerve damage in people who have impaired circulation. Contact your doctor if you experience symptoms of overexposure to vibration. These symptoms include numbness, loss of feeling, tingling, pricking, pain, loss of strength, changes in skin colour or condition. These symptoms normally appear in the fingers, hands or wrists.

Muffler

The muffler is designed to keep noise levels to a minimum and to direct exhaust fumes away from the user.



WARNING! The exhaust fumes from the engine are hot and may contain sparks which can start a fire. Never start the machine indoors or near combustible material!

In areas with a hot, dry climate there is a high risk of fires. These areas are sometimes controlled by legislation and requirements that among other things the muffler must be equipped with an approved type of spark arrestor mesh.

For mufflers it is very important that you follow the instructions on checking, maintaining and servicing your machine.



WARNING! The muffler gets very hot in use and remains so for a short time afterwards. Do not touch the muffler if it is hot!

Checking, maintaining and servicing the machine's safety equipment

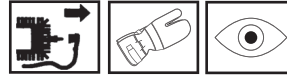

WARNING! All servicing and repair work on the machine requires special training. This is especially true of the machine's safety equipment. If your machine fails any of the checks described below you must contact your service agent. When you buy any of our products we guarantee the availability of professional repairs and service. If the retailer who sells your machine is not a servicing dealer, ask him for the address of your nearest service agent.

Checking the cutting cover and protective cover

Make sure the cutting cover is not damaged and that there are no visible defects such as cracks.

Check that the protective cover is undamaged and that it is properly secured.

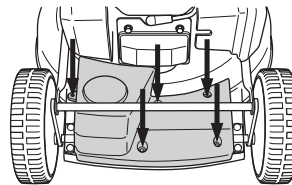

Checking the brake trigger

Place the lawn mower on firm, flat surface and start it. Make sure that the cutter cannot come into contact with the ground or other objects. See the instructions under the heading Start and stop.

Apply full throttle and then release the brake handle.

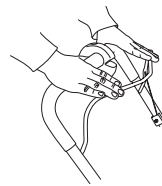

The engine brake should always be adjusted so that the engine stops within 3 seconds.

On lawn mower M53 S Pro the engine brake handle should also disengage the drive. Start the machine and engage the drive by moving the clutch lever towards you.

Apply full throttle and then release the brake handle. The engine should stop and the drive should disengage.

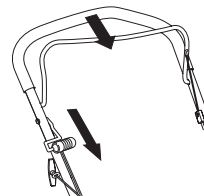

SAFETY INSTRUCTIONS

Vibration damping system

Check regularly that the vibration damping element is free from cracks.



The handlebar system's steel tube and the cutting cover are designed to minimise the vibrations from the engine. Make sure the cutting cover is not damaged and that there are no visible defects such as cracks.

Muffler

Never use a machine that has a faulty muffler.

Regularly check that the muffler is securely attached to the machine.

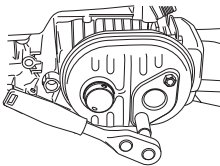

Cutting equipment

This section describes how to choose and maintain your cutting equipment in order to:

- Reduces machine vibration.
- Obtain maximum cutting performance.
- Extend the life of cutting equipment.

Make sure the cutter does not hit foreign objects such as stones, roots or the like. This can make the cutter dull and bend the engine shaft. Always ensure the cutter is well ground and balanced correctly. See also instructions under the heading Maintenance.

Check the cutting attachment for damage or cracks. A damaged cutting attachment should always be replaced.

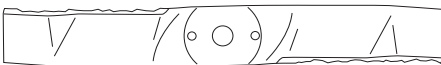

Also check that the cutter bolt is undamaged and that the engine shaft is not bent.

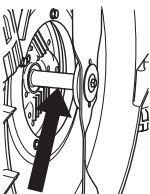

The washer and cup spring should always be replaced when changing the cutter or cutter bracket.



WARNING! Never use a machine with faulty safety equipment. The machine's safety equipment must be checked and maintained as described in this section. If your machine fails any of these checks contact your service agent to get it repaired.

General safety precautions

- A lawn mower is only designed to mow lawns. The only accessories you can use with this engine unit are the cutters we recommend in the Technical data chapter.
- Never use the machine if you are tired, if you have drunk alcohol, or if you are taking medication that could affect your vision, your judgement or your co-ordination.

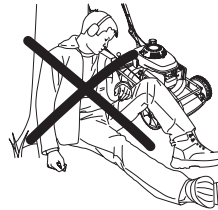

WARNING! Running an engine in a confined or badly ventilated area can result in death due to asphyxiation or carbon monoxide poisoning.

- You must use personal protection whenever you use the machine. See the instructions under the heading Personal protection.
- Never use a machine that has been modified in any way from its original specification.

Never use any accessories other than those recommended in this manual. See instructions under the headings Cutting equipment and Technical data.



WARNING! A faulty cutting attachment may increase the risk of accidents.

- Never use a machine that is faulty. Carry out the checks, maintenance and service instructions described in this manual. Some maintenance and service measures must be carried out by trained and qualified specialists. See instructions under the heading Maintenance.

SAFETY INSTRUCTIONS

Before use:

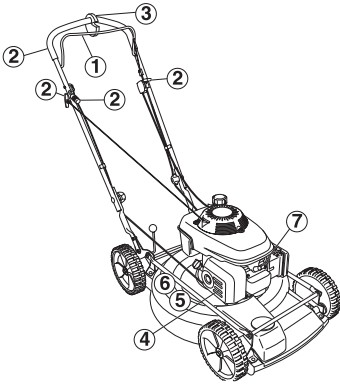

- 1 Check that the engine brake works correctly and is undamaged. See the instructions under the heading Checking the braking effect.
- 2 Check that all handles and controls are undamaged and free of oil.
- 3 Check that the anti vibration system works and is not damaged.
- 4 Check that the muffler is securely attached and not damaged.
- 5 Check that all parts of the lawn mower are tightened correctly and that they are not damaged or missing.
- 6 Check that the cutter is undamaged and not cracked. Replace the cutter if necessary.
- 7 Clean the air filter. Replace if necessary.

Starting



WARNING! Long-term inhalation of the engine's exhaust fumes can represent a health hazard.

- Never start a lawn mower unless the cutters and all covers are fitted correctly.
- Never start the machine indoors. Exhaust fumes can be dangerous if inhaled.
- Observe your surroundings and make sure that there is no risk of people or animals coming into contact with the cutting equipment.



- Place the lawn mower on firm, flat surface and start it. Make sure that the cutter cannot come into contact with the ground or other objects.
- Never twist the starter cord around your hand.

See the instructions under the heading Start and stop.

Fuel safety



(Refuelling/Storage.)



WARNING! Fuel and fuel vapour are highly inflammable. Take care when handling fuel and engine oil. Bear in mind the risk of fire, explosion and inhaling fumes.

- Never refuel the machine while the engine is running.
- Always ensure there is adequate ventilation when refuelling and filling oil.
- Move the machine at least 3 m from the refuelling point before starting it.

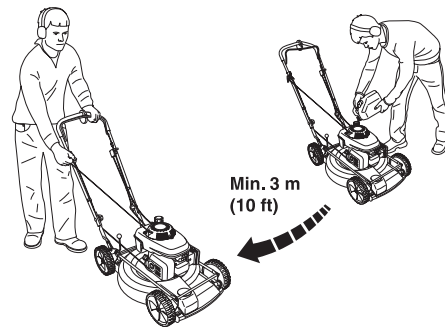

- Never start the machine:
 - 1 If you have spilt fuel or engine oil on the machine. Wipe off the spill and allow the remaining fuel to evaporate.
 - 2 If you spill fuel or engine oil on yourself or your clothes. Change your clothes.
 - 3 If the machine is leaking fuel. Check regularly for leaks from the fuel cap and fuel lines.

Transport and storage

- The fuel and engine oil tanks should be emptied before longer periods of storage or when transporting the lawn mower. Ask where you can dispose of surplus fuel and engine oil at your local petrol station.
- Always store the lawn mower and fuel so that any leakage or vapours do not risk coming into contact with sparks or naked flames. For example, electrical machines, electric motors, relays/switches, boilers, or the like.
- Always store fuel in an approved container designed for that purpose.

SAFETY INSTRUCTIONS

General working instructions



WARNING! This section describes basic safety precautions for working with the lawn mower. This information is never a substitute for professional skills and experience. If you get into a situation where you feel unsure about how to progress, stop and seek expert advice. Contact your dealer, service agent or an experienced lawn mower user. Avoid all usage which you consider to be beyond your capability

Basic safety rules

- Look around you:
 - To ensure that people, animals or other things cannot affect your control of the machine.
 - To make sure that none of the above might come into contact with the cutting equipment.
- Branches, twigs, stones, etc. should be removed from the lawn before you start to mow. Make sure the cutter does not hit foreign objects such as stones, roots or the like. This can make the cutter dull and bend the engine shaft.
- Never lift up the lawn mower or carry it around when the engine is running. If you must lift the lawn mower, first switch off the engine and disconnect the ignition lead from the spark plug.

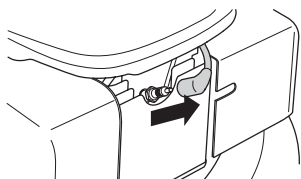

- Do not use the machine in bad weather, such as dense fog, heavy rain, strong wind, intense cold, etc. Working in bad weather is tiring and often brings added risks, such as icy ground.
- Make sure you can move and stand safely. Check the area around you for possible obstacles (roots, rocks, branches, ditches, etc.) in case you have to move suddenly. Take great care when working on sloping ground.
- The lawn mower should not be used on inclines greater than 15 degrees. Inclines that are too great can result in fuel leakage
- The engine should be switched off when moving over ground that is not to be mowed. For example, gravel paths, stone, shingle, asphalt, etc.

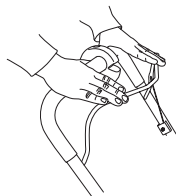

- The brake handle must never be permanently anchored in handle when the machine is running.

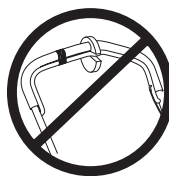

Follow the instructions above, but do not use a lawn mower in a situation where you cannot call for help in case of an accident.

Basic mowing technique



WARNING! Make sure that your hands and feet do not come near the cutting attachment when the engine is running.

General

- Mowing slopes can be dangerous. Do not use the lawn mower on very steep slopes.
- The lawn mower should not be used on inclines greater than 15 degrees. Inclines that are too great can result in fuel leakage
- On sloping ground you should work along the slope. It is much easier to work along a slope than it is to work up and down it.
- Branches, twigs, stones, etc. should be removed from the lawn before you start to mow.

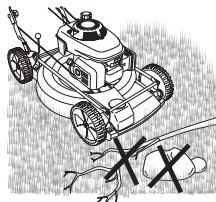

- Never lift up the lawn mower or carry it around when the engine is running. If you must lift the lawn mower, first switch off the engine and disconnect the ignition lead from the spark plug.
- Make sure the cutter does not hit foreign objects such as stones, roots or the like. This can make the cutter dull and bend the engine shaft. A bent axle gives imbalance and heavy vibration, which results in a great risk of the cutter becoming loose.

If any foreign object is hit or if vibrations occur stop the machine immediately. Disconnect the HT lead from the spark plug. Check that the machine is not damaged. Repair any damage.
- Never mow more than 1/3 of the length of the grass. This especially applies during dry periods. Mow first with the cutting height set high. Then check the result and lower to an appropriate height. If the grass is really long, drive slowly and mow twice if necessary.

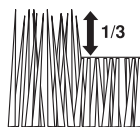

SAFETY INSTRUCTIONS

- Never run with the machine when it is running. You should always walk with the lawn mower.

Cutting height



Shut down the engine before changing the cutting height.

The cutting height adjustment is spring assisted. The cutting height can be adjusted in five different steps.

M53 S PRO

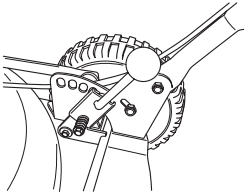

M48 PRO

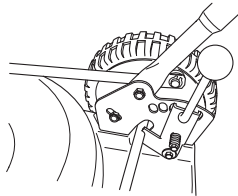

Do not set the cutting height too low as there is a risk that the cutters might hit slopes with unevenness.

Adjusting the cutting height

Shut down the engine before changing the cutting height.

Set the cutting height using the cutting height control on the right-hand side of the lawn mower.

On lawn mowers with the type designation M48 Pro, proceed as follows:

- To raise the cutting height move the lever to the left and then forward.

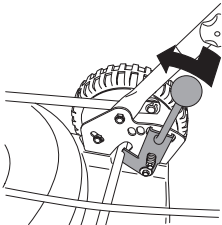

- To lower the cutting height move the lever to the left and then backward.

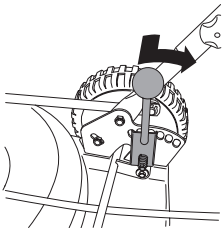

On lawn mowers with the type designation M53 S Pro, proceed as follows:

- To lower the cutting height move the lever to the left and then forward.

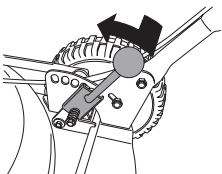

- To raise the cutting height move the lever to the left and then backward.

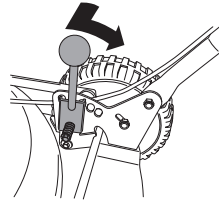

Do not set the cutting height too low as there is a risk that the cutters might hit slopes with unevenness.

WHAT IS WHAT?

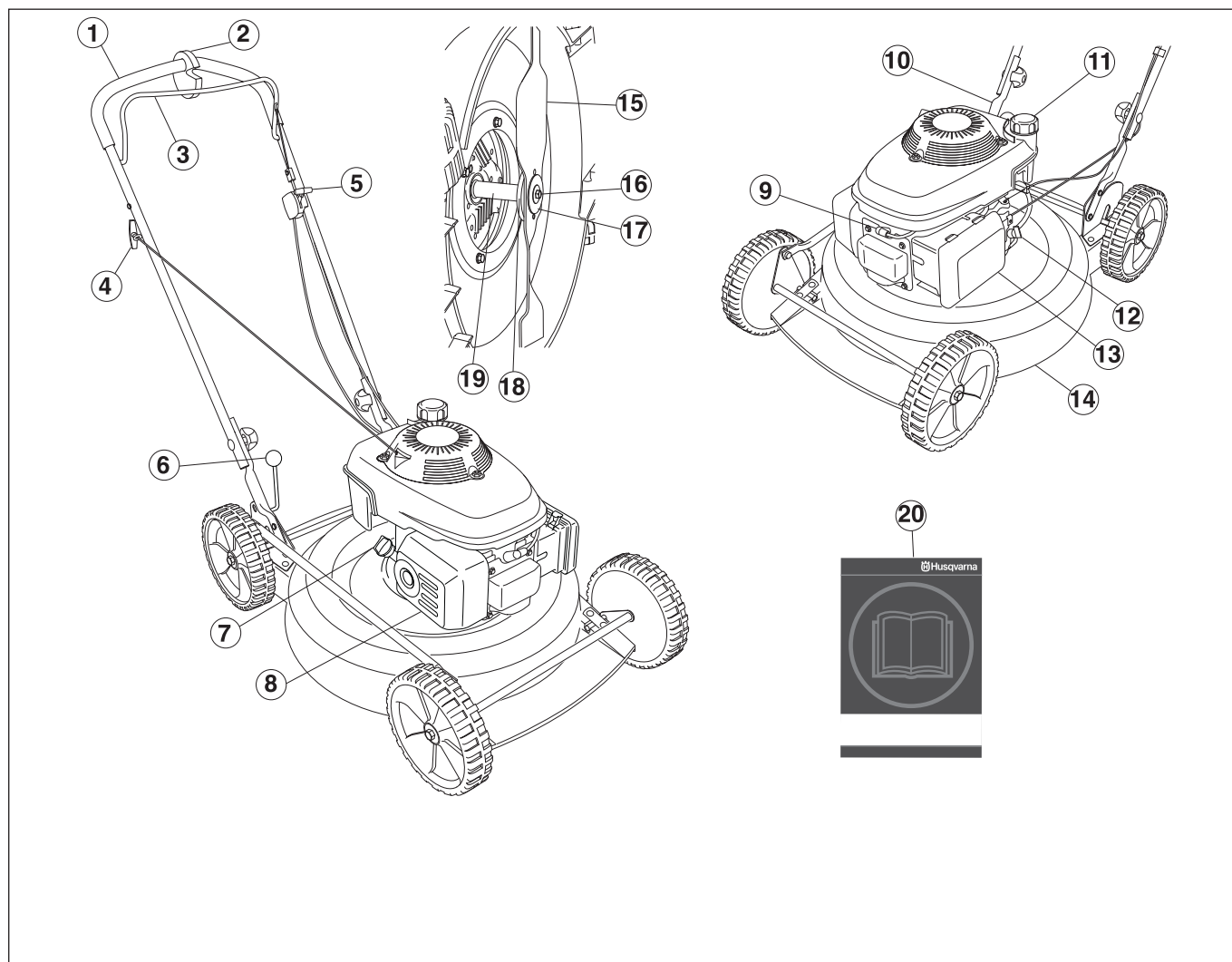

What is what on the lawn mower?

M48 Pro

- | | | | |
|---|--------------------------------|----|--------------------------|
| 1 | Handle / handlebar | 10 | Lower handlebar |
| 2 | Vibration damper | 11 | Oil tank |
| 3 | Engine brake handle | 12 | Fuel tap |
| 4 | Starter handle | 13 | Air filter |
| 5 | Throttle control/choke control | 14 | Cutting cover |
| 6 | Cutting height control | 15 | Cutter/cutting equipment |
| 7 | Fuel tank | 16 | Cutter bolt |
| 8 | Muffler | 17 | Cup spring |
| 9 | Spark plug | 18 | Cutter bracket |
| | | 19 | Engine shaft |
| | | 20 | Operator's manual |

WHAT IS WHAT?

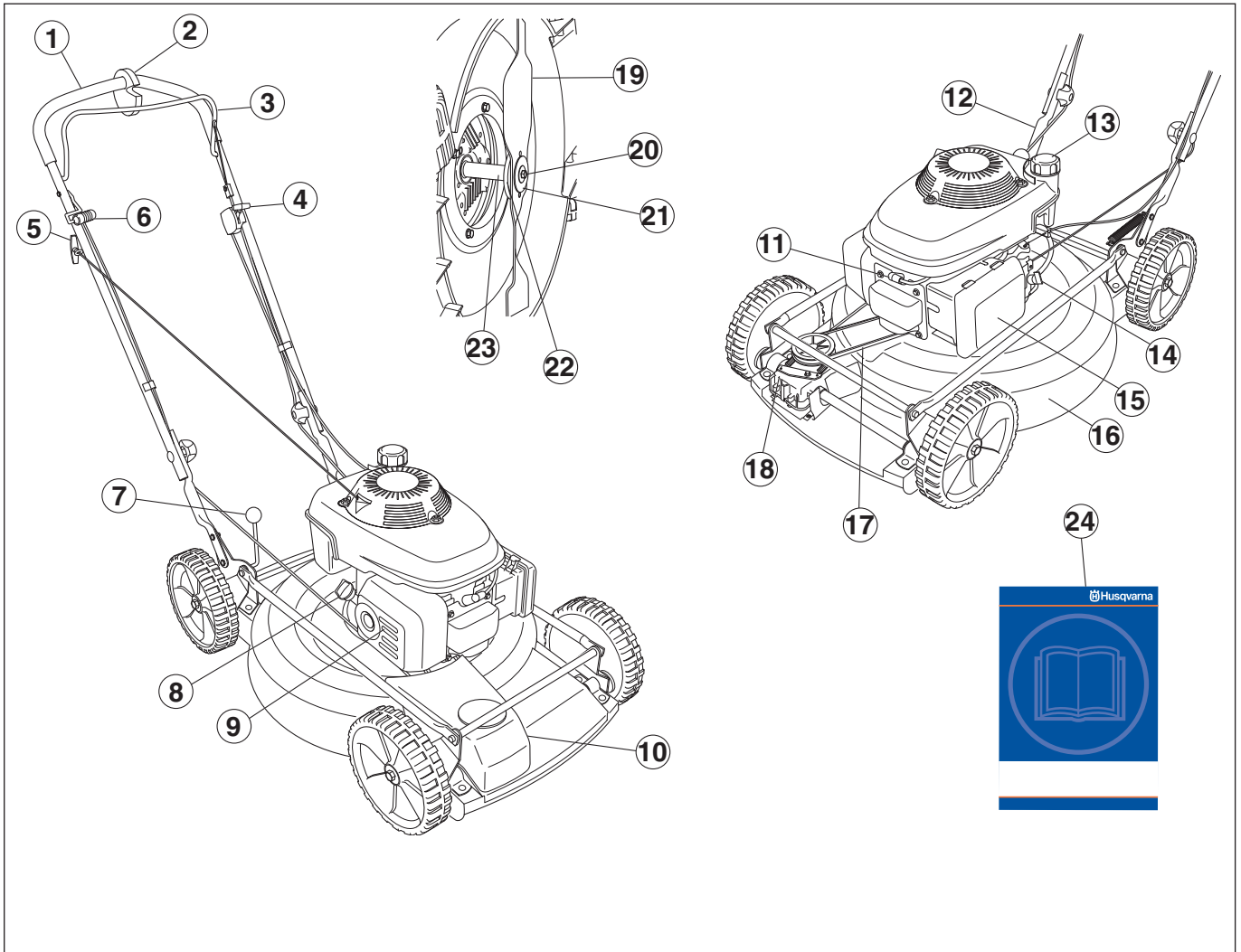

What is what on the lawn mower?

M53 S Pro

- | | | | |
|----|--------------------------------|----|--------------------------|
| 1 | Handle / handlebar | 12 | Lower handlebar |
| 2 | Vibration damper | 13 | Oil tank |
| 3 | Engine brake handle | 14 | Fuel tap |
| 4 | Throttle control/choke control | 15 | Air filter |
| 5 | Starter handle | 16 | Cutting cover |
| 6 | Clutch lever | 17 | Drive belt |
| 7 | Cutting height control | 18 | Gear housing |
| 8 | Fuel tank | 19 | Cutter/cutting equipment |
| 9 | Muffler | 20 | Cutter bolt |
| 10 | Protective cover | 21 | Cup spring |
| 11 | Spark plug | 22 | Cutter bracket |
| | | 23 | Engine shaft |
| | | 24 | Operator's manual |

ASSEMBLY

Fitting the handlebar

Take care not to damage the cables and wires when you fold up the handlebar.

M48 Pro

Lift up the handlebar until the handlebar's upper tubular construction comes directly opposite to the handlebar's lower section. Tighten the knob correctly.

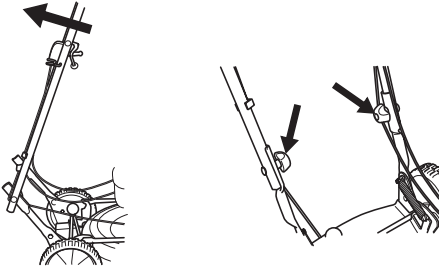

M53 S Pro

Fold up the upper section of the handlebar by:

- 1 Fold in the engine brake handle towards the handlebar.

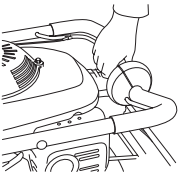

- 2 Lift up the handlebar until the handlebar's upper tubular construction comes directly opposite to the handlebar's lower section. Tighten the knob correctly.

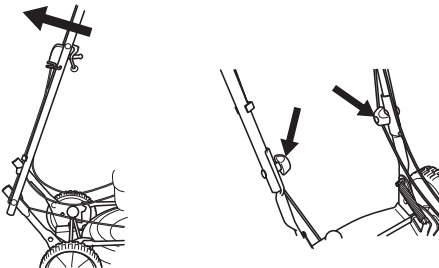

Dismantling and assembling the cutter



WARNING! Always wear heavy-duty gloves when servicing and maintaining the cutting equipment. The cutters are very sharp and cuts can occur very easily.

The ignition lead should always be removed from the spark plug before repair, cleaning or maintenance work.

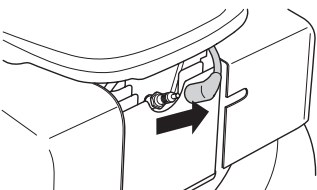

Always empty the fuel tank before you place the lawn mower on its side.

Dismantling

- Unscrew the bolt holding the cutter.

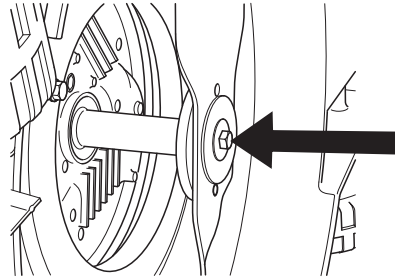

- Remove bolt, washer and cup spring.
- Remove the cutter.

Assembly

- Position the cutter so that the cutting edge faces in the direction of rotation.

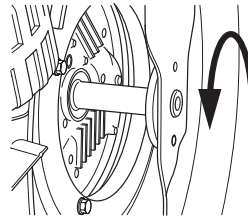

- Fit the cup spring, make sure it centres correctly on the engine shaft.

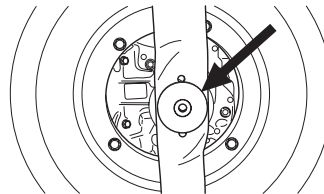

- Fit the washer and tighten the bolt correctly. The bolt should be tightened with a torque of 45-60 Nm.

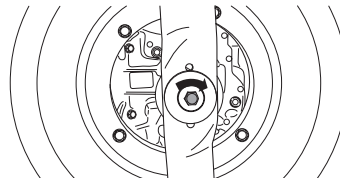

FUEL HANDLING

Fuel



WARNING! Always ensure there is adequate ventilation when handling fuel.

Petrol

- Use good quality unleaded or leaded petrol.
- Use fuel with a low octane grade.
- If the machine is not used for some time the fuel tank should be emptied and cleaned.

Engine oil

Check the oil level before starting the lawn mower. A too low oil level can cause serious damage to the engine.

- For the best result and function use HUSQVARNA four-stroke oil.
- If HUSQVARNA four-stroke oil is not available, you may use another four-stroke oil of good quality. Contact your dealer when selecting oil. In general SAE 30 is recommended.
- Never use oil intended for two-stroke engines.

Check the oil level before starting the lawn mower. A too low oil level can cause serious damage to the engine.

Oil level

The lawn mower should stand on flat ground when you check the oil level. Ensure the ignition lead has been removed from the spark plug before you open the oil filler cap.

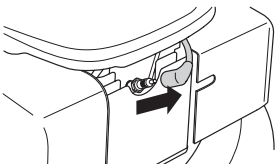

Unscrew the oil filler cap and check the oil level on the dipstick fitted to the cover.

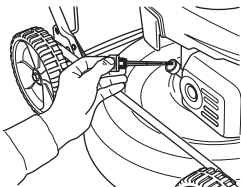

The oil filler cap must be completely screwed down to give a correct picture of the oil level.

If the oil level is low, fill using engine oil up to the upper level on the dipstick.

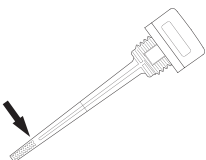

Only use recommended engine oil. See the Technical data section.

Fuelling



WARNING! Taking the following precautions, will lessen the risk of fire:

Do not smoke or place hot objects near fuel.

Always shut off the engine before refuelling.

When refuelling, open the fuel cap slowly so that any excess pressure is released gently.

Tighten the fuel cap carefully after refuelling.

Always move the machine away from the refuelling area before starting.

Always remove the ignition lead from the spark plug before refuelling.

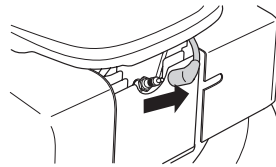

Clean around the fuel cap. Clean the fuel and oil tank regularly. The fuel filter should be changed at least once a year. Contamination in the tanks causes malfunction.

Always move the machine about 3 metres from the refuelling position before starting.

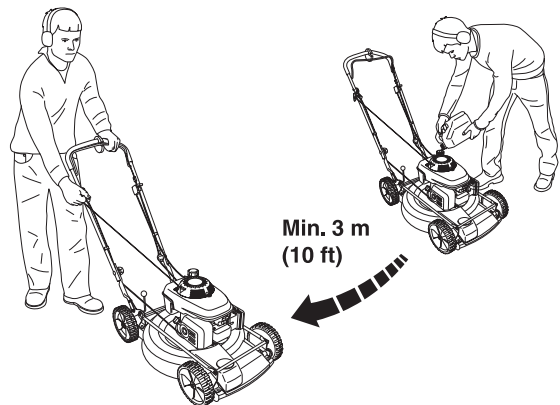

STARTING AND STOPPING

Starting and stopping



WARNING! Note the following before starting:

Do not start a lawn mower unless the cutter and all covers are fitted correctly. Otherwise the cutter could come loose and cause personal injuries.

Always move the machine away from the refuelling area before starting.

Place the machine on a flat surface. Ensure the cutting attachment cannot come into contact with any object.

On the M53 S Pro model disengage the drive on the wheel by moving the clutch lever forward.

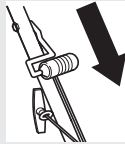

Keep people and animals well away from the working area.

Cold engine

Ensure the ignition lead sits correctly on the spark plug.

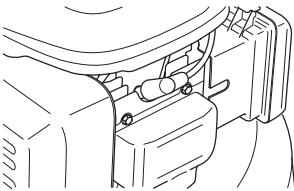

Starting: Open the fuel tap.

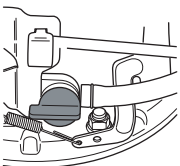

Choke: Set the throttle control in the choke position.

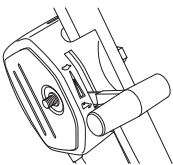

Warm engine

Use the same starting procedure as for a cold engine, but do not set the throttle control in the choke position.

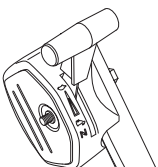

Starting

On the M53 S Pro model disengage the drive on the wheel by moving the clutch lever forward.

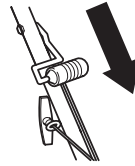

Pull the engine brake handle against the upper handlebar with your left hand.

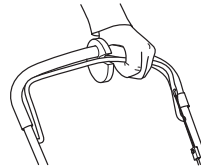

Grip the starter handle, slowly pull out the cord with your right hand until you feel some resistance (the starter pawls grip), now quickly and powerfully pull the cord.

Never twist the starter cord around your hand.



Disengage the choke position with the throttle control when the engine is warm.

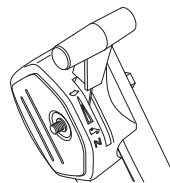

CAUTION! Do not pull the starter cord all the way out and do not let go of the starter handle when the cord is fully extended. This can damage the machine.



STARTING AND STOPPING

Drive

The model M53 S Pro is a self-propelled machine with the drive on the front wheels.

To use the drive on the wheel pull the clutch lever towards you.

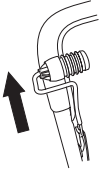

Stopping

Set the throttle control in the idling position.

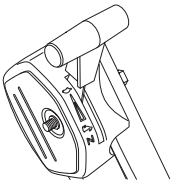

Stop the engine by releasing the engine brake handle.

On model M53 S Pro the drive is also disengaged when you release the engine brake handle.

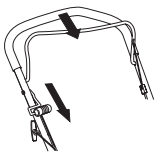

Close the fuel tap.

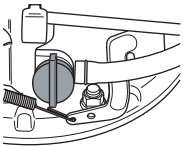

MAINTENANCE

Maintenance

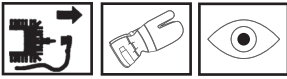

WARNING! Make sure the cutting attachment has stopped before cleaning, carrying out repairs or an inspection. Disconnect the HT lead from the spark plug.

Air filter



The air filter must be regularly cleaned to remove dust and dirt in order to avoid:

- Carburettor malfunctions
- Starting problems
- Loss of engine power
- Unnecessary wear to engine parts.
- Excessive fuel consumption.

Clean the air filter daily, or more often in demanding conditions.

The air filter is dismantled once the air filter cover has been lifted off. Press in the catches on the top of the air filter cover and lower the cover.

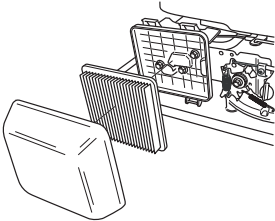

Remove the air filter and check that it is undamaged. Replace with a new air filter if you believe it to be defective.

Clean the filter by knocking the filter carefully against a hard surface and blowing with compressed air from inside. Never brush the dirt away. Replace the air filter if it is very dirty.

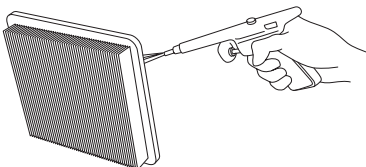

An air filter that has been in use for a long time cannot be cleaned completely. The filter must therefore be replaced with a new one at regular intervals. **A damaged air filter must always be replaced.**

When reassembling, make sure that the filter completely seals against the filter holder.

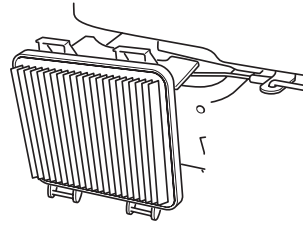

Spark plug



WARNING! The muffler gets very hot in use and remains so for a short time afterwards. Do not touch the muffler if it is hot!

If the machine is low on power, difficult to start or runs poorly at idle speed: always check the spark plug first before taking any further action. If the spark plug is dirty, clean it and check that the electrode gap is 0.7-0.8 mm. The spark plug should be replaced after about a month in operation or earlier if necessary.

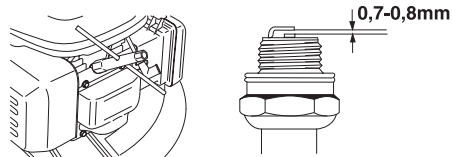

CAUTION! Always use the recommended spark plug type! Use of the wrong spark plug can damage the piston/cylinder.

Muffler



The muffler is designed to reduce the noise level and to direct the exhaust gases away from the operator. The exhaust gases are hot and can contain sparks, which may cause fire if directed against dry and combustible material.

Regularly check that the muffler is securely attached to the machine.

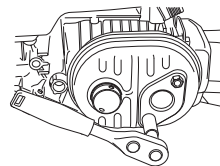

Never use a machine that has a faulty muffler.



MAINTENANCE

Cutter

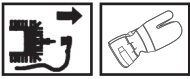

WARNING! Always wear heavy-duty gloves when repairing the cutting attachment. The blades are very sharp and can easily cause cuts.

It is important to have a sharp and correctly balanced cutter. Loosen the bolt holding the cutter and leave the cutter at a service workshop at least once a year for grinding and balancing. An appropriate time to do this is after the mowing season has finished.

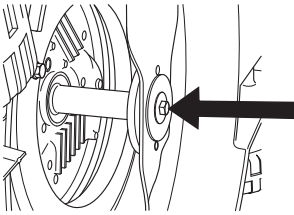

If the cutter or cutter bracket need to be changed you must replace the cutter bolt, washer and cup spring at the same time.

The bolt should be tightened with a torque of 45-60 Nm when you fit the cutter again. See instructions under the heading Assembly.

If the cutter hits foreign objects such as stones, roots or the like the cutter will slip against the cutter bracket. This may mean that the contact surface of the cutter bracket appears slightly worn, which is completely normal. This is a safety device, which reduces the risk of the engine shaft becoming bent.

Changing the oil



The engine oil should be changed each year and every 25 working hours.

When changing the oil proceed as follows::

- Disconnect the HT lead from the spark plug.

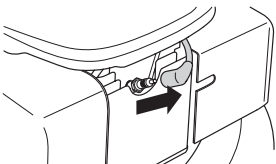

- Empty the fuel tank
- Close the fuel tap.

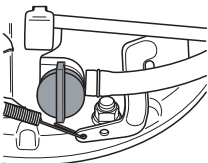

- Unscrew the oil filler cap.

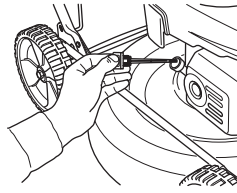

- Drain the oil by tipping the engine so that the oil runs out through the filler pipe.

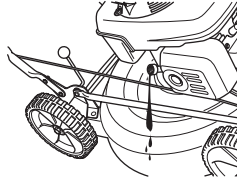

- Ask where you can dispose of surplus engine oil at your local petrol station.
- Fill with new engine oil of a good quality. See the Technical data section.
- Check the oil level with the dipstick on the oil filler cap. The oil filler cap must be completely screwed down to give a correct picture of the oil level.

If the oil level is low, fill using engine oil up to the upper level on the dipstick.

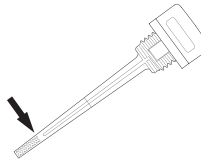

- Screw on the oil filler cap.

Lubrication of the cutting height adjustment

The mechanical parts of the cutting height system should be lubricated regularly (once a week). Lubricate the cutting height system with a few drops of oil.

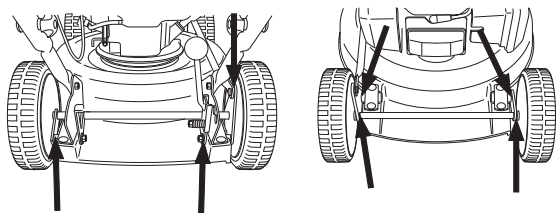

MAINTENANCE

Drive and gearbox

M53 S Pro

Ensure the wheels and wheel axles are clean and free from leaves, grass, etc. It is also important to keep clean around the drive gearbox.

- Remove the protective cover by unscrewing the screws.

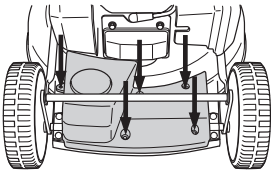

- Now guide the protective cover out under the stay and over the drive axle.

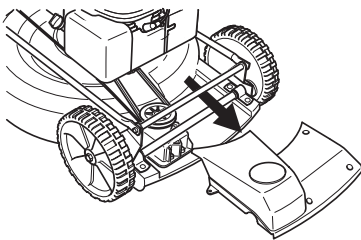

- Clean the gearbox with a brush. Also check that the drive belt and belt pulley are undamaged, for example, no cracks.

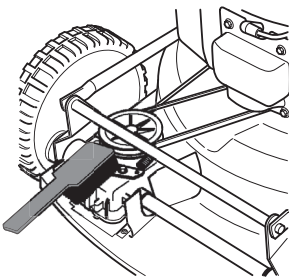

Below you will find some general maintenance instructions.

Daily maintenance

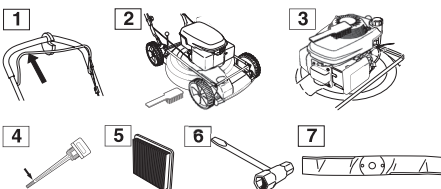

- Check that the engine brake handle works safely.
- Brush leaves, grass and the like off of the lawn mower.
- Clean the air intake on the starter. Check the starter and starter cord.
- Check the oil level.
- Clean the air filter. Replace if necessary.
- Check that nuts and screws are tight.
- Check the cutting attachment. Never use blades that are dull, cracked or damaged.

Weekly maintenance

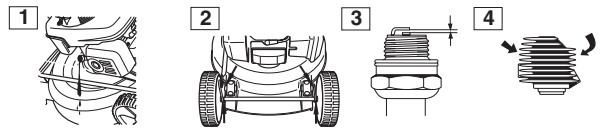

- Change the engine oil.
- Lubricate the cutting height system
- Clean the spark plug. Check that the electrode gap is 0.7-0.8 mm.
- Clean the cooling fins on the cylinder.

Monthly maintenance

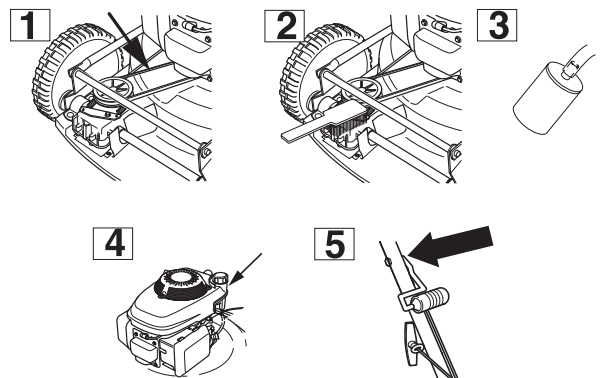

- Check that drive belt is not damaged and is not visibly defective.
- Clean the gearbox.
- Check the fuel filter and the fuel hose. Replace if necessary.
- Clean the inside of the fuel tank.
- Lubricate the drive control.

TECHNICAL DATA

Technical data

	M48 Pro	M53 S Pro
Engine		
Cylinder displacement, cm ³	160	160
Cylinder bore, mm	64	64
Stroke, mm	50	50
Power, kW	4,1	4,1
Ignition system		
Type of ignition system	Transistor	Transistor
Spark plug	NGK - BPR6ES	NGK - BPR6ES
Electrode gap, mm	0,7 - 0,8	0,7 - 0,8
Fuel and lubrication system		
Fuel tank capacity, litre	1,1	1,1
Oil tank capacity, litre	0,55	0,55
Engine oil	Service classification SG - SJ; SAE 10W -30	Service classification SG - SJ; SAE 10W -30
Weight		
Lawn mower with empty tanks, kg	30,3	35,4
Noise emissions		
(see note 1)		
Sound power level, measured dB(A)	94	96
Sound power level, guaranteed L _{WA} dB(A)	95	97
Vibration levels		
(see note 2)		
Handle left, m/s ²	3,6	3,5
Handle right, m/s ²	3,5	3,8
Cutting equipment		
Cutting system	BioClip	BioClip
The cutting height can be adjusted in five different steps, mm.	28-65	28-65
Cutting width, cm	48	53
Cutter	Fixed	Fixed
Drive		
Speed, km/h	----	4,5

Note 1: Noise emissions in the environment measured as sound power (L_{WA}) in conformity with EC directive 2000/14/EC.

Note 2: Vibrations measured according to EN836 : 1997/A2:2001

TECHNICAL DATA

EC-declaration of conformity

(Applies to Europe only)

Höors Plåt, Box 76, SE-243 22 Höör, Sweden, tel: +46-413-29600, declares under sole responsibility that the lawn mowers **Husqvarna M48 Pro and M53 S Pro** from the serial numbers 030600001 and onwards comply with the requirements of the COUNCIL'S DIRECTIVE:

of May 3, 1989 "relating to electromagnetic compatibility" **89/336/EEC**, and applicable supplements.

of May 8, 2000 "relating to the noise emissions in the environment" **2000/14/EC**.

of June 22, 1998 "relating to machinery" **98/37/EC**.

For information relating to noise emissions, see the chapter Technical data.

The following standards have been applied: EN836:1997

Notified body: **0404, SMP Svensk Maskinprovning AB**, Fyrisborgsgatan 3, SE-754 50 Uppsala, Sweden, has compiled conformity assessment Report No. **01/901/020** - M48 Pro, **01/901/022** - M53 S Pro in accordance with Directive 2000/14/EC, Annex VI.

Höör January 3, 2003



Lennart Molin, Development manager



1140249-26



We hope you find the links below useful. For further gardening information visit
www.GardenResources.co.uk

Blower Vacs	Brush cutters	Brushcutters	Chainsaws	Chain saws
Cultivators	Cylinder lawn mowers	Cylinder mowers	Echo chainsaws	Echo Strimmers
Electric chainsaws	Fertiliser spreaders	Garden blowers	Garden rollers	Garden shredders
Garden tractors	Garden vacuums	Hayter lawn mowers	Hedge cutters	Hedgecutters
Hover mowers	Husqvarna chainsaws	Kawasaki brush cutters	Kawasaki trimmers	Lawn mowers
Lawn scarifiers	Lawn tractors	Leaf blowers	Leaf vacuums	Petrol chainsaws
Petrol hedge cutters	Ride on lawn mowers	Ride on mowers	Rotary mowers	Rotavators
Ryobi trimmers	Scarifiers	Strimmers	Westwood lawn tractors	Westwood ride on mowers
Westwood tractors	Brush Cutters	Brushcutters	Blower Vacs	Chain Saws
Chainsaws	Cultivators	Cylinder Lawn Mowers	Echo Chainsaws	Echo Strimmers
Electric Chainsaws	Fertiliser Spreaders	Garden Blowers	Garden Rollers	Lawn Rollers
Garden Shredders	Garden Tractors	Garden Vacuums	Hayter Lawn Mowers	Hedge Cutters
Hedgecutters	Hover Mowers	Husqvarna Chainsaws	Kawasaki Brush Cutters	Kawasaki Strimmers
Lawn Mowers	Scarifiers	Lawn Tractors	Leaf Blowers	Leaf Vacuums
Petrol Chainsaws	Petrol Hedge Cutters	Ride on Lawn Mowers	Ride on Mowers	Rotary Mowers
Rotovators	Ryobi Strimmers	Garden Patio Heaters	Outdoor Patio Heaters	Gas Patio Heaters
Patio Heaters	Patio Heater Covers	Garden Heaters	Greenhouse Heaters	Green House Heaters
Gas Greenhouse Heaters	Stainless Steel Patio Heaters	Table Top Patio Heaters	Patio Heaters UK	Patio Heaters with Covers
Christmas Gardening Gifts	Garden Tractors	Ride on Lawn Mowers	Ride on Mowers	

Also See

[Gardening Tools Direct](#), for lawn mowers, brush cutters, chainsaws
[Gardening Supply](#) for patio heaters, lawn mowers, chainsaws
[Garden Tractor](#), for lawn tractors and ride on mowers

Free Manuals Download Website

<http://myh66.com>

<http://usermanuals.us>

<http://www.somanuals.com>

<http://www.4manuals.cc>

<http://www.manual-lib.com>

<http://www.404manual.com>

<http://www.luxmanual.com>

<http://aubethermostatmanual.com>

Golf course search by state

<http://golfingnear.com>

Email search by domain

<http://emailbydomain.com>

Auto manuals search

<http://auto.somanuals.com>

TV manuals search

<http://tv.somanuals.com>