



OPERATOR'S MANUAL

5-1/2 in. CORNER CAT®

COMPACT FINISH SANDER

DOUBLE INSULATED

CFS1502

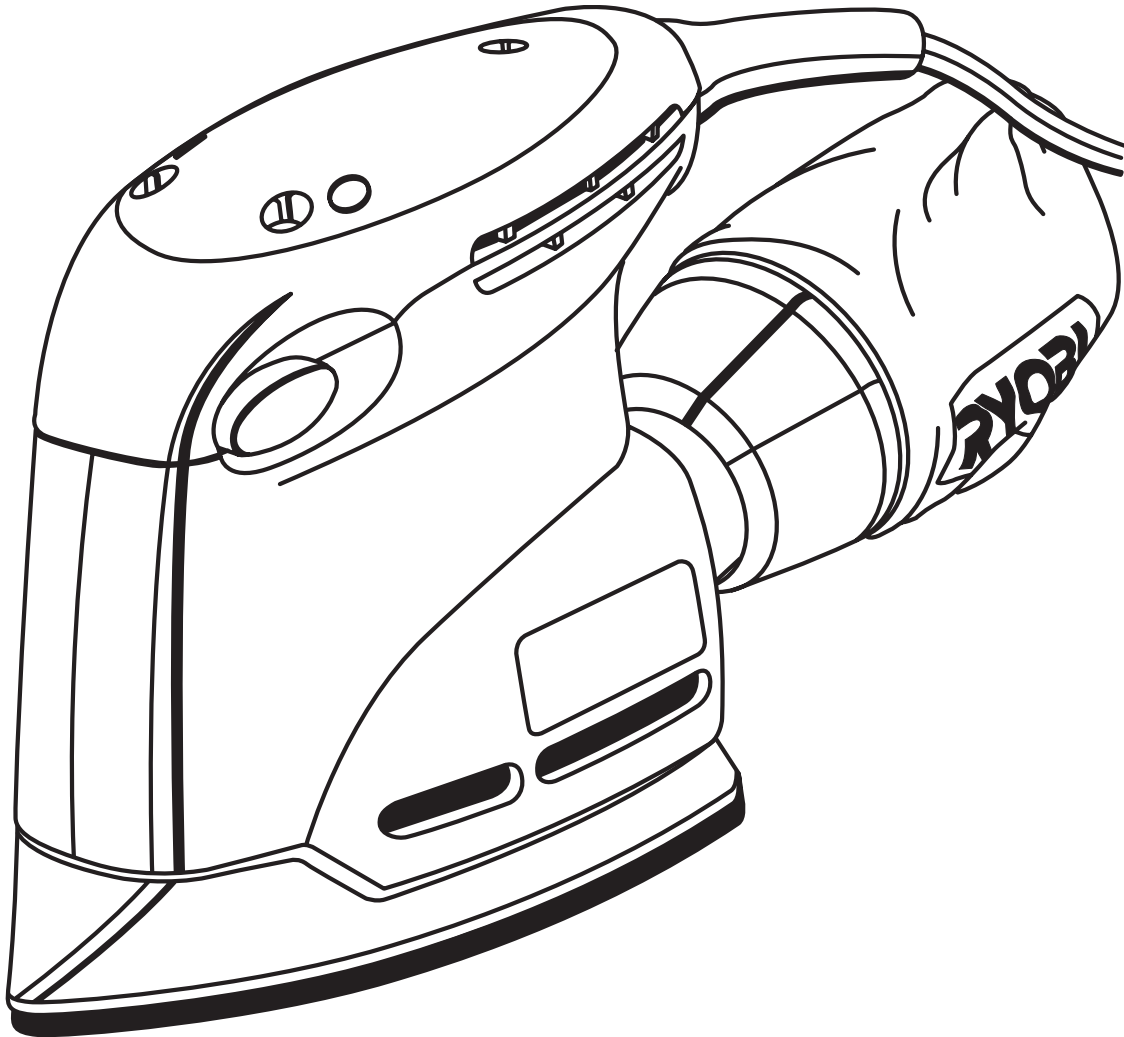

Your Corner Cat® sander has been engineered and manufactured to Ryobi's high standard for dependability, ease of operation, and operator safety. When properly cared for, it will give you years of rugged, trouble-free performance.

⚠ WARNING: To reduce the risk of injury, the user must read and understand the operator's manual before using this product.

Thank you for buying a Ryobi product.

SAVE THIS MANUAL FOR FUTURE REFERENCE

TABLE OF CONTENTS

■ Introduction	2
■ General Safety Rules	3-4
■ Specific Safety Rules	4
■ Symbols	5-6
■ Electrical	7
■ Features	8
■ Assembly	9
■ Operation	9-12
■ Maintenance	13
■ Parts Ordering / Service	14

INTRODUCTION

This tool has many features for making its use more pleasant and enjoyable. Safety, performance, and dependability have been given top priority in the design of this product making it easy to maintain and operate.

GENERAL SAFETY RULES



WARNING:

Read and understand all instructions. Failure to follow all instructions listed below, may result in electric shock, fire and/or serious personal injury.

SAVE THESE INSTRUCTIONS

WORK AREA

- **Keep your work area clean and well lit.** Cluttered benches and dark areas invite accidents.
- **Do not operate power tools in explosive atmospheres, such as in the presence of flammable liquids, gases, or dust.** Power tools create sparks which may ignite the dust or fumes.
- **Keep bystanders, children, and visitors away while operating a power tool.** Distractions can cause you to lose control.

ELECTRICAL SAFETY

- **Double insulated tools are equipped with a polarized plug (one blade is wider than the other). This plug will fit in a polarized outlet only one way. If the plug does not fit fully in the outlet, reverse the plug. If it still does not fit, contact a qualified electrician to install a polarized outlet. Do not change the plug in any way.** Double insulation eliminates the need for the three-wire grounded power cord and grounded power supply system.
- **Avoid body contact with grounded surfaces such as pipes, radiators, ranges, and refrigerators.** There is an increased risk of electric shock if your body is grounded.
- **Don't expose power tools to rain or wet conditions.** Water entering a power tool will increase the risk of electric shock.
- **Do not abuse the cord. Never use the cord to carry the tools or pull the plug from an outlet. Keep cord away from heat, oil, sharp edges, or moving parts. Replace damaged cords immediately.** Damaged cords increase the risk of electric shock.
- **When operating a power tool outside, use an outdoor extension cord marked "W-A" or "W".** These cords are rated for outdoor use and reduce the risk of electric shock.

PERSONAL SAFETY

- **Stay alert, watch what you are doing and use common sense when operating a power tool. Do not use tool while tired or under the influence of drugs, alcohol, or medication.** A moment of inattention while operating power tools may result in serious personal injury.
- **Dress properly. Do not wear loose clothing or jewelry. Contain long hair. Keep your hair, clothing, and gloves away from moving parts.** Loose clothes, jewelry, or long hair can be caught in moving parts.

- **Avoid accidental starting. Be sure switch is off before plugging in.** Carrying tools with your finger on the switch or plugging in tools that have the switch on invites accidents.
- **Remove adjusting keys or wrenches before turning the tool on.** A wrench or a key that is left attached to a rotating part of the tool may result in personal injury.
- **Do not overreach. Keep proper footing and balance at all times.** Proper footing and balance enables better control of the tool in unexpected situations.
- **Use safety equipment. Always wear eye protection.** Dust mask, nonskid safety shoes, hard hat, or hearing protection must be used for appropriate conditions.
- **Do not wear loose clothing or jewelry. Contain long hair.** Loose clothes, jewelry, or long hair can be drawn into air vents.
- **Do not use on a ladder or unstable support.** Stable footing on a solid surface enables better control of the tool in unexpected situations.

TOOL USE AND CARE

- **Use clamps or other practical way to secure and support the workpiece to a stable platform.** Holding the work by hand or against your body is unstable and may lead to loss of control.
- **Do not force tool. Use the correct tool for your application.** The correct tool will do the job better and safer at the rate for which it is designed.
- **Do not use tool if switch does not turn it on or off.** Any tool that cannot be controlled with the switch is dangerous and must be repaired.
- **Disconnect the plug from power source before making any adjustments, changing accessories, or storing the tool.** Such preventive safety measures reduce the risk of starting the tool accidentally.
- **Store idle tools out of the reach of children and other untrained persons.** Tools are dangerous in the hands of untrained users.
- **Maintain tools with care. Keep cutting tools sharp and clean.** Properly maintained tools with sharp cutting edges are less likely to bind and are easier to control.
- **Check for misalignment or binding of moving parts, breakage of parts, and any other condition that may affect the tool's operation. If damaged, have the tool serviced before using.** Many accidents are caused by poorly maintained tools.
- **Use only accessories that are recommended by the manufacturer for your model.** Accessories that may be suitable for one tool, may become hazardous when used on another tool.
- **Keep the tool and its handle dry, clean and free from oil and grease.** Always use a clean cloth when cleaning. Never use brake fluids, gasoline, petroleum-based products, or any strong solvents to clean your tool. Following this rule will reduce the risk of loss of control and deterioration of the enclosure plastic.

GENERAL SAFETY RULES

SERVICE

- **Tool service must be performed only by qualified repair personnel.** Service or maintenance performed by unqualified personnel may result in a risk of injury.
- **When servicing a tool, use only identical replacement parts. Follow instructions in the Maintenance section of this manual.** Use of unauthorized parts or failure to follow Maintenance Instructions may create a risk of shock or injury.

SPECIFIC SAFETY RULES

- **Hold tool by insulated gripping surfaces when performing an operation where the cutting tool may contact hidden wiring or its own cord.** Contact with a “live” wire will make exposed metal parts of the cutting tool “live” and shock the operator.
- **Know your power tool. Read operator’s manual carefully. Learn its applications and limitations, as well as the specific potential hazards related to this tool.** Following this rule will reduce the risk of electric shock, fire, or serious injury.
- **Always wear safety glasses. Everyday eyeglasses have only impact-resistant lenses; they are NOT safety glasses.** Following this rule will reduce the risk of serious personal injury.
- **Protect your lungs. Wear a face or dust mask if the operation is dusty.** Following this rule will reduce the risk of serious personal injury.
- **Protect your hearing. Wear hearing protection during extended periods of operation.** Following this rule will reduce the risk of serious personal injury.
- **Inspect tool cords periodically and, if damaged, have repaired at your nearest Authorized Service Center. Constantly stay aware of cord location.** Following this rule will reduce the risk of electric shock or fire.
- **Check damaged parts. Before further use of the tool, a guard or other part that is damaged should be carefully checked to determine that it will operate properly and perform its intended function. Check for alignment of moving parts, binding of moving parts, breakage of parts, mounting, and any other conditions that may affect its operation. A guard or other part that is damaged should be properly repaired or replaced by an authorized service center.** Following this rule will reduce the risk of shock, fire, or serious injury.
- **Make sure your extension cord is in good condition. When using an extension cord, be sure to use one heavy enough to carry the current your product will draw. A wire gauge size (A.W.G.) of at least 16 is recommended for an extension cord 50 feet or less in length. A cord exceeding 100 feet is not recommended. If in doubt, use the next heavier gauge. The smaller the gauge number, the heavier the cord. An undersized cord will cause a drop in line voltage resulting in loss of power and overheating.**
- **Inspect for and remove all nails from lumber before using this tool.** Following this rule will reduce the risk of serious personal injury.
- **Save these instructions.** Refer to them frequently and use them to instruct others who may use this tool. If you loan someone this tool, loan them these instructions also.

WARNING:











Some dust created by power sanding, sawing, grinding, drilling, and other construction activities contains chemicals known to cause cancer, birth defects or other reproductive harm. Some examples of these chemicals are:

- lead from lead-based paints,
- crystalline silica from bricks and cement and other masonry products, and
- arsenic and chromium from chemically-treated lumber.

Your risk from these exposures varies, depending on how often you do this type of work. To reduce your exposure to these chemicals: work in a well ventilated area, and work with approved safety equipment, such as those dust masks that are specially designed to filter out microscopic particles.



SYMBOLS

Some of the following symbols may be used on this tool. Please study them and learn their meaning. Proper interpretation of these symbols will allow you to operate the tool better and safer.

SYMBOL	NAME	DESIGNATION/EXPLANATION
V	Volts	Voltage
A	Amperes	Current
Hz	Hertz	Frequency (cycles per second)
W	Watt	Power
min	Minutes	Time
~	Alternating Current	Type of current
==	Direct Current	Type or a characteristic of current
n_0	No Load Speed	Rotational speed, at no load
	Class II Construction	Double-insulated construction
.../min	Per Minute	Revolutions, strokes, surface speed, orbits etc., per minute
	Wet Conditions Alert	Do not expose to rain or use in damp locations.
	Read The Operator's Manual	To reduce the risk of injury, user must read and understand operator's manual before using this product.
	Eye Protection	Always wear safety goggles, safety glasses with side shields, or a full face shield when operating this product.
	Safety Alert	Precautions that involve your safety.
	No Hands Symbol	Failure to keep your hands away from the blade will result in serious personal injury.
	No Hands Symbol	Failure to keep your hands away from the blade will result in serious personal injury.
	No Hands Symbol	Failure to keep your hands away from the blade will result in serious personal injury.
	No Hands Symbol	Failure to keep your hands away from the blade will result in serious personal injury.
	Hot Surface	To reduce the risk of injury or damage, avoid contact with any hot surface.

SYMBOLS

The following signal words and meanings are intended to explain the levels of risk associated with this product.

SYMBOL	SIGNAL	MEANING
	DANGER:	Indicates an imminently hazardous situation, which, if not avoided, will result in death or serious injury.
	WARNING:	Indicates a potentially hazardous situation, which, if not avoided, could result in death or serious injury.
	CAUTION:	Indicates a potentially hazardous situation, which, if not avoided, may result in minor or moderate injury.
	CAUTION:	(Without Safety Alert Symbol) Indicates a situation that may result in property damage.

SERVICE

Servicing requires extreme care and knowledge and should be performed only by a qualified service technician. For service we suggest you return the product to your nearest **AUTHORIZED SERVICE CENTER** for repair. When servicing, use only identical replacement parts.

WARNING:

To avoid serious personal injury, do not attempt to use this product until you read thoroughly and understand completely the operator's manual. Save this operator's manual and review frequently for continuing safe operation and instructing others who may use this product.

WARNING:



The operation of any power tool can result in foreign objects being thrown into your eyes, which can result in severe eye damage. Before beginning power tool operation, always wear safety goggles, safety glasses with side shields, or a full face shield when needed. We recommend Wide Vision Safety Mask for use over eyeglasses or standard safety glasses with side shields. Always use eye protection which is marked to comply with ANSI Z87.1.

SAVE THESE INSTRUCTIONS

ELECTRICAL

DOUBLE INSULATION

Double insulation is a concept in safety in electric power tools, which eliminates the need for the usual three-wire grounded power cord. All exposed metal parts are isolated from the internal metal motor components with protecting insulation. Double insulated tools do not need to be grounded.

WARNING:

The double insulated system is intended to protect the user from shock resulting from a break in the tool's internal insulation. Observe all normal safety precautions to avoid electrical shock.

NOTE: Servicing of a tool with double insulation requires extreme care and knowledge of the system and should be performed only by a qualified service technician. For service, we suggest you return the tool to the nearest authorized service center for repair. Always use original factory replacement parts when servicing.

ELECTRICAL CONNECTION

This tool has a precision-built electric motor. It should be connected to a **power supply that is 120 volts, 60 Hz, AC only (normal household current)**. Do not operate this tool on direct current (DC). A substantial voltage drop will cause a loss of power and the motor will overheat. If the tool does not operate when plugged into an outlet, double-check the power supply.

EXTENSION CORDS

When using a power tool at a considerable distance from a power source, be sure to use an extension cord that has the capacity to handle the current the tool will draw. An undersized cord will cause a drop in line voltage, resulting in overheating and loss of power. Use the chart to determine the minimum wire size required in an extension cord. Only round jacketed cords listed by Underwriter's Laboratories (UL) should be used.

When working outdoors with a tool, use an extension cord that is designed for outside use. This type of cord is designated with "WA" on the cord's jacket.

Before using any extension cord, inspect it for loose or exposed wires and cut or worn insulation.

**Ampere rating (on tool data plate)

Cord Length	Wire Size (A.W.G.)					
	0-2.0	2.1-3.4	3.5-5.0	5.1-7.0	7.1-12.0	12.1-16.0
25'	16	16	16	16	14	14
50'	16	16	16	14	14	12
100'	16	16	14	12	10	—

**Used on 12 gauge - 20 amp circuit.

NOTE: AWG = American Wire Gauge

WARNING:

Keep the extension cord clear of the working area. Position the cord so that it will not get caught on lumber, tools or other obstructions while you are working with a power tool. Failure to do so can result in serious personal injury.

WARNING:

Check extension cords before each use. If damaged replace immediately. Never use tool with a damaged cord since touching the damaged area could cause electrical shock resulting in serious injury.

FEATURES

PRODUCT SPECIFICATIONS

Sanding Pad Length.....5-1/2 in.
Cord Length 10 ft.
Orbit Diameter..... 1/16 in.

No Load Speed 12,000/min.
Input 120 V, 60 Hz, AC only, 1 Amp
Net Weight..... 2.5 lbs.

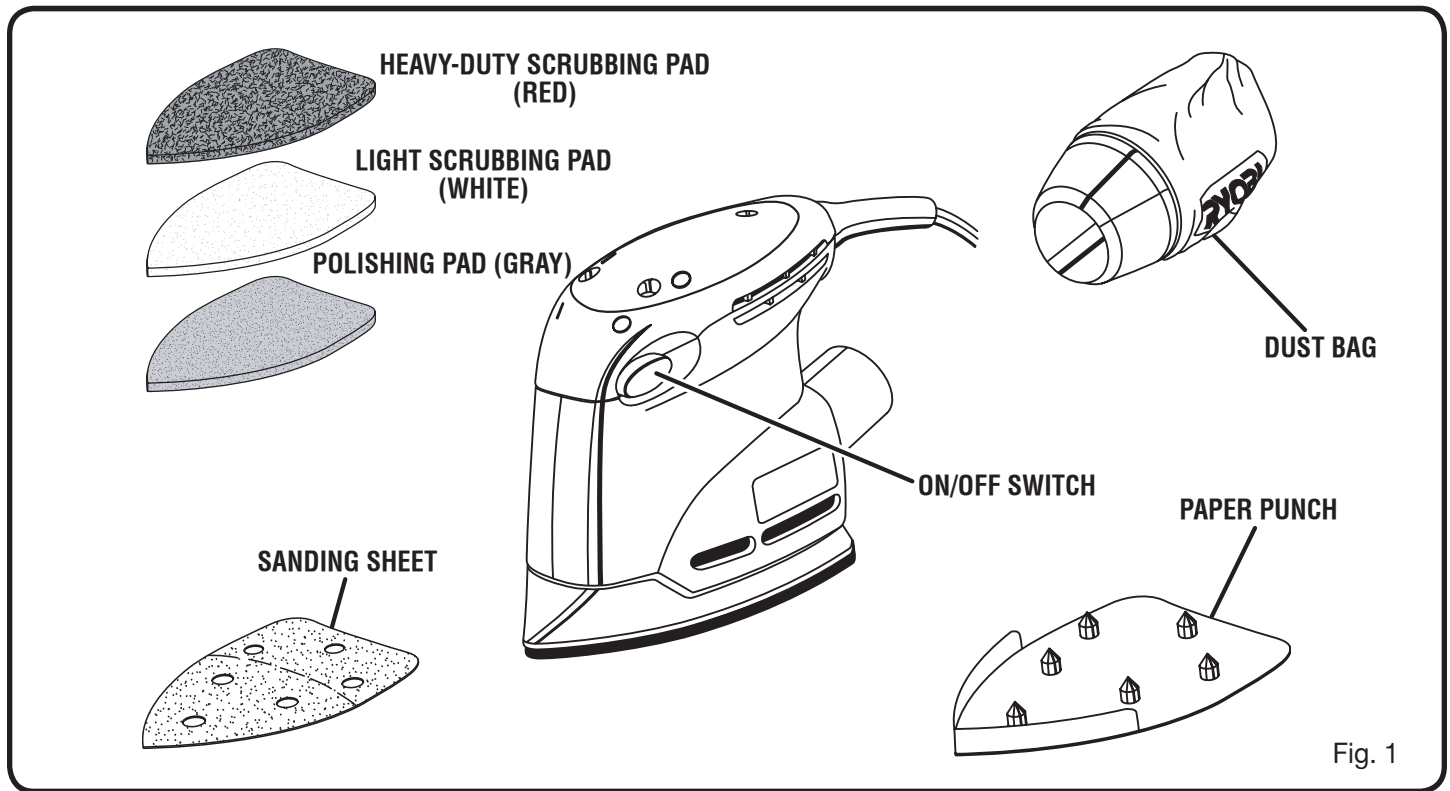

KNOW YOUR COMPACT FINISH SANDER

See Figure 1.

Before attempting to use this product, familiarize yourself with all operating features and safety rules.

ON/OFF SWITCH

This tool is equipped with a simple switch control. To turn the sander ON, push the switch to the left (|). Push the switch to the right (O) to turn the sander OFF.

QUICK CHANGE HOOK AND LOOP PAD

The hook and loop design allows for quick change of sanding sheets and scrubbing pads. It also enables you to easily clean and reuse them.

TRI-FLEX PAD DESIGN

The top two-thirds of each sanding sheet is a detachable triangle that can be rotated to extend sheet life and promote even wear.

CIRCULAR SANDING ACTION

The oscillating action of the sander produces very quick, small circular motion of the sanding pad. The motion is ideal for producing a fine finished grain or, when using the scrubbing pad, removing light rust, paint, and other build up from the work surface.

DUST BAG

The dust bag collects dust through punched holes in the sandpaper and hook and loop pad, keeping dust to a minimum.

PAPER PUNCH

The paper punch template punches sandpaper for proper fit and alignment.

GRIPZONE™ OVERMOLD TECHNOLOGY

The sander features GripZone™ overmold technology for improved comfort with a positive grip.

ASSEMBLY

UNPACKING

This product has been shipped completely assembled.

- Carefully remove the tool and any accessories from the box. Make sure that all items listed in the packing list are included.
- Inspect the tool carefully to make sure no breakage or damage occurred during shipping.
- Do not discard the packing material until you have carefully inspected and satisfactorily operated the tool.
- If any parts are damaged or missing, please call 1-800-525-2579 for assistance.

WARNING:

Do not attempt to modify this tool or create accessories not recommended for use with this tool. Any such alteration or modification is misuse and could result in a hazardous condition leading to possible serious personal injury.

PACKING LIST

5-1/2 in. Corner Cat® Compact Finish Sander
60-grit Sanding Sheet (2)
120-grit Sanding Sheet (3)
240-grit Sanding Sheet (2)
Heavy-duty Scrubbing Pad (Red)
Light Scrubbing Pad (White)
Polishing Pad (Gray)
Dust Bag
Paper Punch
Carrying Case
Operator's Manual
Warranty Registration Card

WARNING:

If any parts are missing do not operate this tool until the missing parts are replaced. Failure to hee this warning could result in possible serious personal injury.

OPERATION

WARNING:

Do not allow familiarity with tools to make you careless. Remember that a careless fraction of a second is sufficient to inflict serious injury.

WARNING:

Always wear safety goggles or safety glasses with side shields when operating power tools. Failure to do so could result in objects being thrown into your eyes resulting in possible serious injury.

WARNING:

Do not use any attachments or accessories not recommended by the manufacturer of this tool. The use of attachments or accessories not recommended can result in serious personal injury.

APPLICATIONS

You may use this tool for the purposes listed below:

- Sanding on wood surfaces.
- Removing rust from and sanding steel surfaces.
- Polishing and scrubbing porcelain and metal.

SANDING SHEET SELECTION

Selecting the correct size grit and type sanding sheet is an important step in achieving a high quality finish. Aluminum oxide, silicon carbide, and other synthetic abrasives are best for power sanding. Natural abrasives, such as flint and garnet are too soft for economical use in power sanding.

In general, coarse grit will remove the most material and finer grit will produce the best finish in all sanding operations. The condition of the surface to be sanded will determine which grit will do the job. If the surface is rough, start with a coarse grit and sand until the surface is uniform. Medium grit may then be used to remove scratches left by the coarser grit and finer grit used for finishing of the surface. Always continue sanding with each grit until surface is uniform.

Sheet/Pad	Recommended Use
Heavy scrubbing pad (Part no. CFS1501-36)	Paint and rust removal
Light scrubbing pad (Part no. CFS1501-37)	Light scrubbing and cleaning
Polishing pad (Part no. CFS1501-38)	Polishing
60-grit sanding sheet (Part no. CFS1501-33)	Coarse sanding
120-grit sanding sheet (Part no. CFS1501-34)	Light sanding
240-grit sanding sheet (Part no. CFS1501-35)	Finish sanding

OPERATION

ATTACHING HOOK AND LOOP SANDING SHEETS

See Figure 2.

- Unplug the sander.
- Align holes in hook and loop type sanding sheet with holes in pad, then carefully press fuzzy side of the sanding sheet against pad as tightly as possible.

Note: Hook and loop type sanding sheets can be reused for the life of the sanding abrasive. It is recommended that you keep the sanding sheet backing clean to provide for best adhesion. Clean the sheet and hook and loop pad by brushing lightly with a light brush.

ATTACHING THE DUST BAG

See Figure 3.

The dust bag provides a dust collection system for the sander. Sanding dust is drawn up through the holes of the sanding sheet and collected in the dust bag during sanding.

- Unplug the sander.
- Using a slight twisting motion, firmly slide dust bag assembly over blower exhaust on sander.

TURNING THE SANDER ON/OFF

See Figure 4.

While holding the tool in normal operating position,

- Push the ON/OFF switch to the left to turn sander on.
- Push the ON/OFF switch to the right to turn sander off.

OPERATING THE SANDER

See Figures 5 - 6.

⚠ CAUTION:

Keep the cord away from the sanding pad and position the cord so that it will not be caught on lumber, tools, or other objects during sanding.

- Secure the workpiece to prevent it from moving under the sander.

⚠ WARNING:

Unsecured workpieces could be thrown towards the operator, causing injury.

⚠ WARNING:

Keep your head away from the sander and sanding area. Hair could be drawn into sander causing serious injury.

- Hold the sander in front and away from you, keeping it clear of the workpiece.

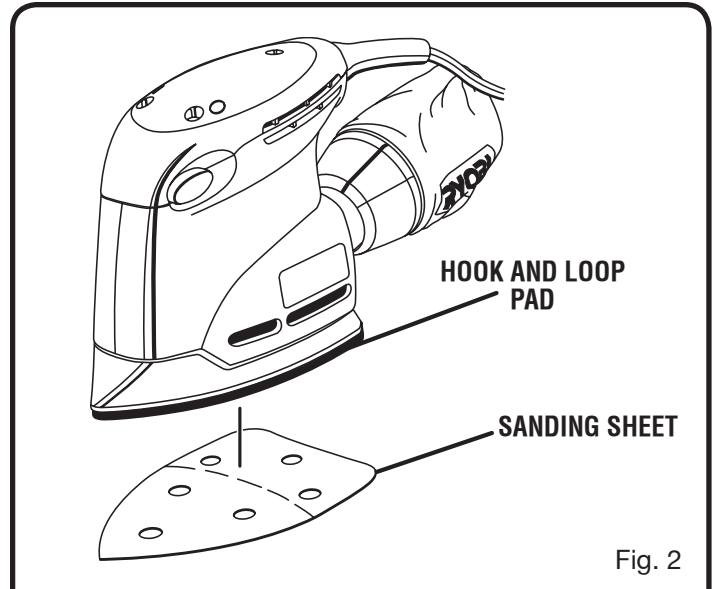

Fig. 2

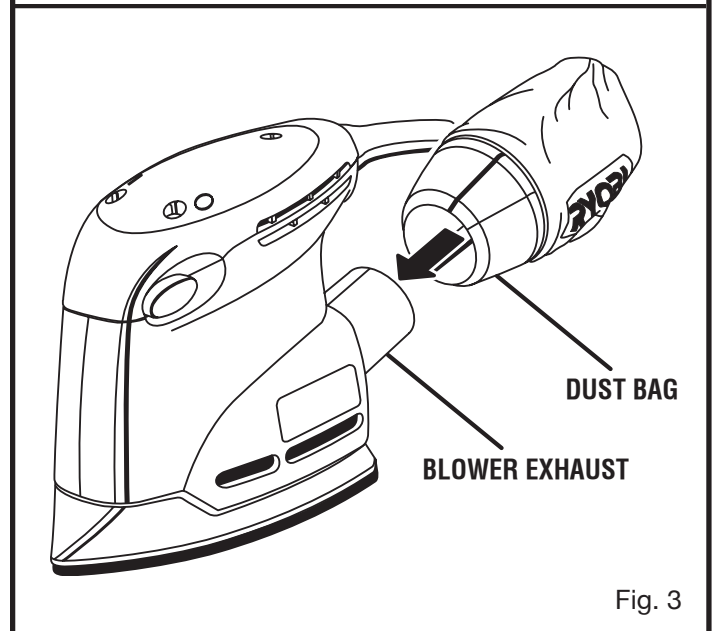

Fig. 3

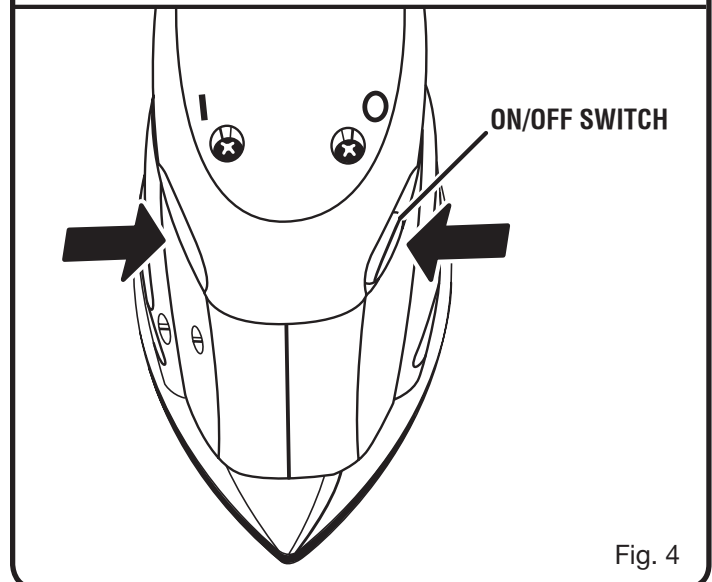

Fig. 4

OPERATION

CAUTION:

To avoid motor damage resulting from overheating, do not cover the air vents with your hand.

- Start the sander and let the motor build to its maximum speed.
- Gradually lower sander onto the workpiece so that all of the sanding disc surface is in contact with workpiece.
- Move the sander slowly across the workpiece using small, circular motions.

Do not force. The weight of the unit supplies adequate pressure to do the work. Applying additional pressure only slows the motor, rapidly wears the sanding sheet, and greatly reduces sander speed. Excessive pressure will overload the motor causing possible damage from overheating and can result in inferior work. Any finish or resin on wood may soften from the frictional heat. Do not sand on one spot too long as the sander's rapid action may remove too much material, making the surface uneven.

Extended periods of sanding may overheat the motor. If this occurs, turn the sander off and wait until the sanding sheet comes to a complete stop. Remove sander from workpiece. Remove your hand from vent area. Turn sander on and run it free without a load to cool the motor.

For detail sanding such as corners and crevices, use the tip of the sanding sheet with small, back and forth motions.

EMPTYING THE DUST BAG

See Figure 7.

For more efficient operation, empty the dust bag when it is no more than half full to permit better air flow through the bag. Always empty and clean the dust bag thoroughly upon completion of a sanding operation and before storing.

WARNING:

Collected dust from sanding surface coatings such as polyurethanes, linseed oil, etc. can self-ignite in the sander dust bag or elsewhere and cause fire. To reduce the risk of fire, empty the dust bag every 10-15 minutes while sanding. Never store or leave a sander without totally emptying its dust bag. Also follow the recommendations of the coatings manufacturers.

- Unplug the sander.

WARNING:

Failure to unplug the tool could result in accidental starting causing possible serious injury.

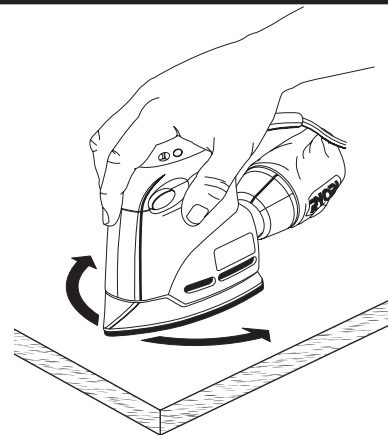

SANDING IN CIRCULAR MOTIONS

Fig. 5

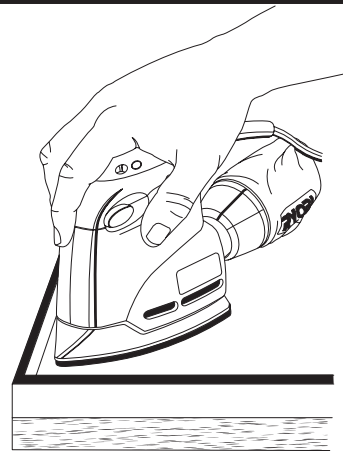

SANDING IN CORNERS

Fig. 6

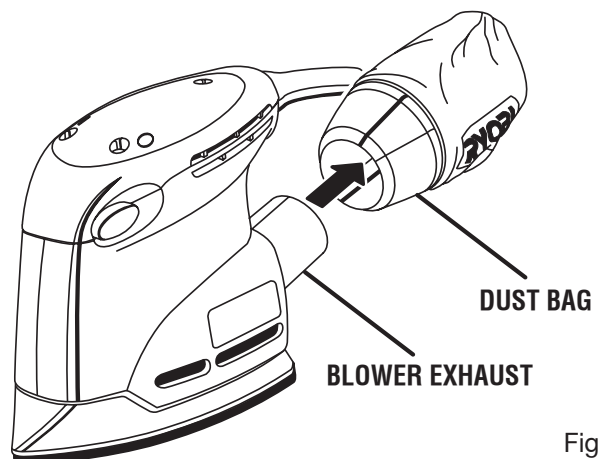

Fig. 7

- Remove the dust bag from the sander.
- Shake out the dust.
- Reattach the dust bag to the sander.

For a more thorough cleaning of the dust bag, remove dust bag from frame and shake out dust. Replace dust bag over frame then install dust bag assembly on sander.

OPERATION

CHANGING THE SANDING SHEETS AND PADS

See Figure 8.

The sander is packed with sanding sheets and pads designed for a variety of uses. To change sheet or pad, simply pull the used sheet or pad off the base and attach the desired sheet or pad by pressing the sheet or pad onto the base of the sander.

PAPER PUNCH

See Figure 9.

A paper punch template has been supplied with the sander for aligning and punching holes in sandpaper. The punched holes must align with the holes in the sander pad.

- Install sandpaper on the sander.
- Align the sander pad over the paper punch.
- Push down on the sander.

ROTATING THE SANDING SHEETS

See Figure 10.

The majority of wear in a precision sanding application occurs at the tip of the sanding sheet. The unique Tri-Flex design of the sanding sheets allows you to detach and rotate the top two thirds of each, extending the life of the sheet.

To rotate the top of the sheet, simply remove the top two thirds along the perforation. Rotate the sheet so that a clean corner is located at the tip of the base. Press the sheet firmly onto the sander pad.

NOTE: Scrubbing and polishing pads are not perforated and cannot be rotated.

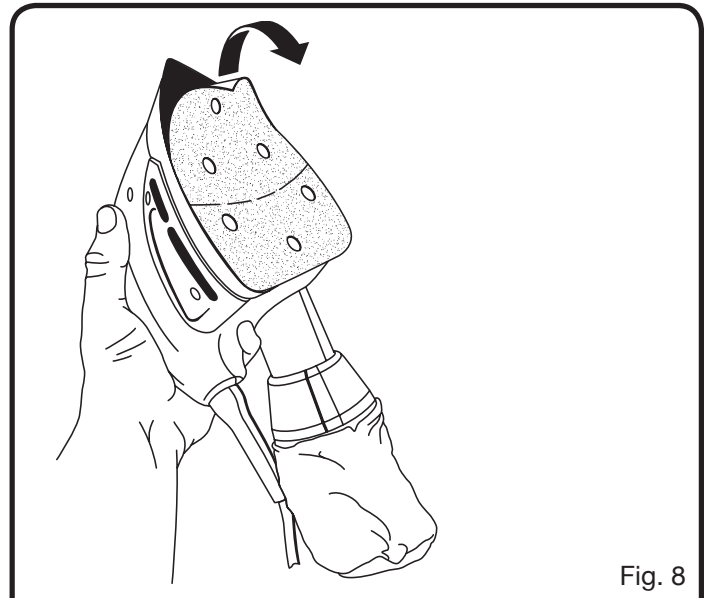

Fig. 8

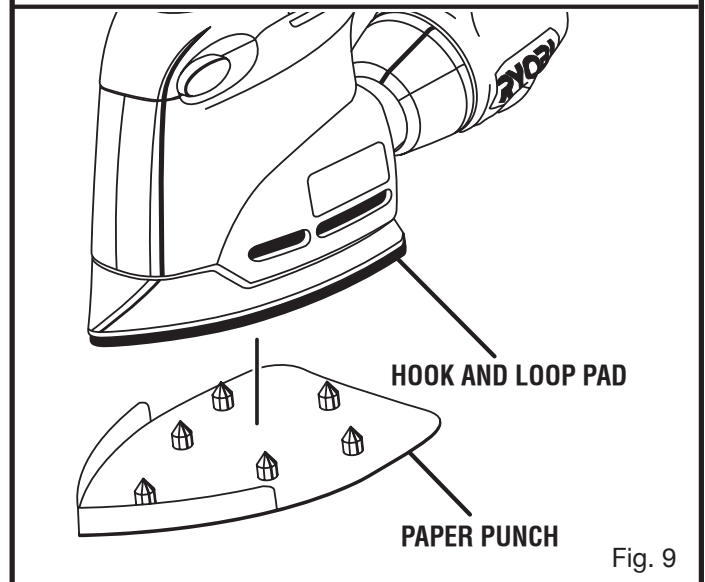

Fig. 9

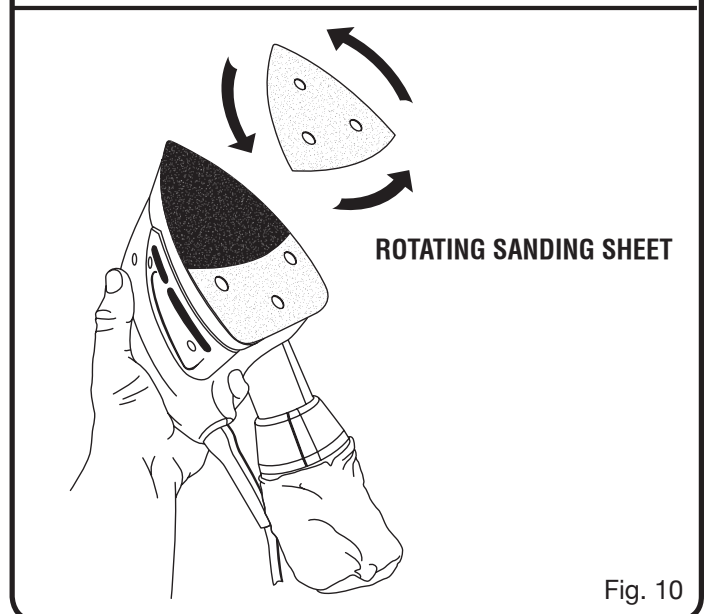

Fig. 10

MAINTENANCE

WARNING:

When servicing, use only identical Ryobi replacement parts. Use of any other parts may create a hazard or cause product damage.

WARNING:

Always wear safety goggles or safety glasses with side shields during power tool operation or when blowing dust. If operation is dusty, also wear a dust mask.

GENERAL MAINTENANCE

Avoid using solvents when cleaning plastic parts. Most plastics are susceptible to damage from various types of commercial solvents and may be damaged by their use. Use clean cloths to remove dirt, dust, oil, grease, etc.

WARNING:

Do not at any time let brake fluids, gasoline, petroleum-based products, penetrating oils, etc., come in contact with plastic parts. Chemicals can damage, weaken, or destroy plastic which may result in serious personal injury.

Electric tools used on fiberglass material, wallboard, spackling compounds, or plaster are subject to accelerated wear and possible premature failure because the fiberglass chips and grindings are highly abrasive to bearings, brushes, commutators, etc. Consequently, we do not recommend using this tool for extended work on these types of materials. However, if you do work with any of these materials, it is extremely important to clean the tool using compressed air.

LUBRICATION

All of the bearings in this tool are lubricated with a sufficient amount of high grade lubricant for the life of the unit under normal operating conditions. Therefore, no further lubrication is required.

CLEANING THE SCRUBBING PADS

To ensure longer life and optimum performance, periodically clean all residue and foreign materials from the scrubbing pads. This can be done simply by rinsing the pad with warm water until all foreign material has been washed away. After cleaning, gently squeeze the pad to remove excess water and allow pad to dry. Always store pads and sanding sheets flat in a cool, dry location.

CLEANING THE SANDING SHEETS

The sanding sheets that came with the sander are made to be re-used. Therefore, it is important that they be cleaned periodically to remove sanding residue and foreign material that can accumulate over time.

To clean sanding sheets, rub the sheets with a hard rubber block.

WARNING:

Always remove the scrubbing pad or sanding sheet from sander before cleaning. Failure to do so could cause serious personal injury.

Free Manuals Download Website

<http://myh66.com>

<http://usermanuals.us>

<http://www.somanuals.com>

<http://www.4manuals.cc>

<http://www.manual-lib.com>

<http://www.404manual.com>

<http://www.luxmanual.com>

<http://aubethermostatmanual.com>

Golf course search by state

<http://golfingnear.com>

Email search by domain

<http://emailbydomain.com>

Auto manuals search

<http://auto.somanuals.com>

TV manuals search

<http://tv.somanuals.com>