

# VX2515 VX2510

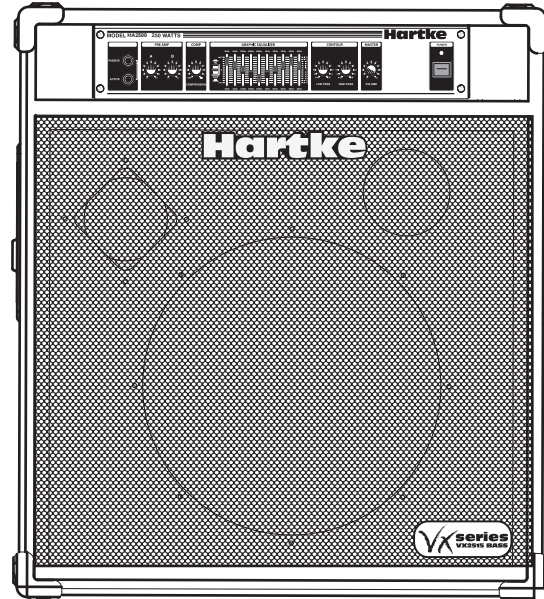
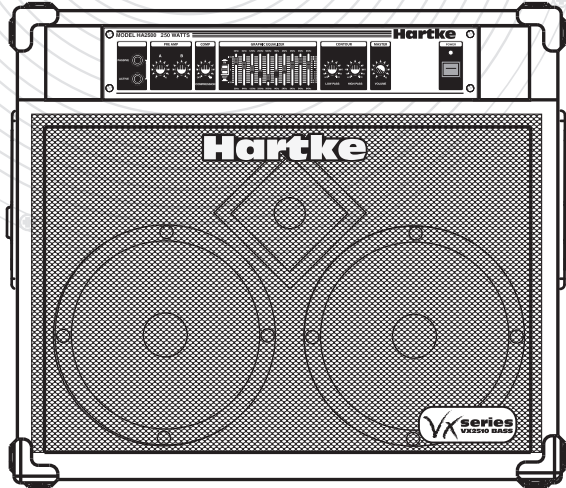

250 WATT 1 X 15" BASS COMBO  
250 WATT 2 X 10" BASS COMBO

## Owners Manual

# Hartke

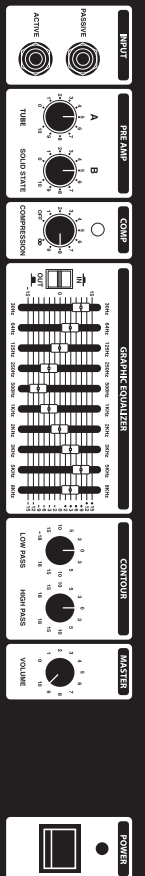



<b>Introduction</b>	<b>2</b>
<b>Features</b>	<b>3</b>
<b>Guided Tour</b>	
Front Panel	<b>4-5</b>
Rear Panel	<b>6-7</b>
<b>Setting Up and Using the VX2510 &amp; VX2515</b>	<b>8-9</b>
<b>About Equalization</b>	<b>10-11</b>
<b>About Compression</b>	<b>12</b>
<b>Appendix A: Caster Installation</b>	<b>13</b>
<b>Appendix B: Block Diagram</b>	<b>14</b>
<b>Appendix C: Changing the VX2510 &amp; VX2515 Voltage</b>	<b>15</b>
<b>Specifications</b>	<b>16</b>

Copyright 2005 - 2008, Samson Technologies Corp.

Printed June, 2008 v1.1  
Samson Technologies Corp.  
45 Gilpin Avenue  
Hauppauge, New York 11788-8816  
Phone: 1-800-3-SAMSON (1-800-372-6766)  
Fax: 631-784-2201  
[www.samsontech.com](http://www.samsontech.com)

# Introduction

Congratulations on purchasing the Hartke VX2510 & VX2515 Bass Amplifier! Although this unit is designed for easy operation, we suggest you first take some time to go through these pages so you can fully understand how we've implemented a number of unique features.

The VX2510 & VX2515 combos feature tH HA2500 amplifier providing 250 watts of power to the built-in 2-way bass speaker system. With that kind of power and Hartke's custom designed transducers, including 2 x 10-inch low frequency, working with a 1-inch high frequency compression driver in the VX2510 and a 15-inch low frequency drive unit plus 1-inch high frequency compression driver in the VX2515, these bass combos are EXTREMELY loud and punchy. In addition, the VX2510 & VX2515 offer a number of additional advanced features, including front-panel compression and graphic equalizer LED indicators, effects send and return jacks, an effects send/return balance knob, and a direct output with ground lift and pre or post EQ selection.

The VX2510 & VX2515 are optimized for use with electric bass instruments, and the front panel controls in both models are virtually identical. You'll find either to be an excellent bass amplifier for live performance use in small and medium-size venues; in addition, the VX2510 & VX2515's advanced pre-amp features makes it ideal for use in recording environments.

In these pages, you'll find a detailed description of the many features of the VX2510 & VX2515 bass amplifier, as well as a guided tour through their front and rear panels, step-by-step instructions for setting up and using each product, detailed discussions about equalization and compression, and full specifications. You'll also find a warranty card enclosed—please don't forget to fill it out and mail it so that you can receive online technical support and so we can send you updated information about these and other Hartke and Samson products in the future.

**SPECIAL NOTE:** Should your unit ever require servicing, a Return Authorization number (RA) is necessary. Without this number, the unit will not be accepted. Please call Samson Technologies at (516) 932-1062 for a Return Authorization number prior to shipping your unit. Please retain the original packing material and, if possible, return the unit in its original carton and packing materials.

# Features

The Hartke VX2510 & VX2515 bass amplifier offers all the newest concepts in bass amplification. Here are some of its main features:

- Power to spare — The VX2510 & VX2515, a full 250 watts delivered to its internal 4 ohm speaker system.
- Internal, 2-way bass speaker system including two custom design 10-inch low frequency drivers, plus 1-inch high frequency compression driver in the VX2510 and custom design 15-inch low frequency drivers, plus 1-inch high frequency compression driver in the VX2515.
- Our unique Transient Attack® circuitry which ensures that every nuance of your bass performance is reproduced faithfully.
- Two Pre-Amp input knobs, allowing custom blending of tube emulation and solid state sounds.
- Ten bands of high-quality graphic equalization, allowing you to create a broad range of tonal colors for your bass instrument. A dedicated in/out button allows you to preset an equalization curve.
- Two fully adjustable contour knobs (high pass and low pass), which provide further control over shaping your bass sound.
- A built-in compressor which not only adds real “punch” to your bass sound, but also allows you to smooth out volume differences between notes.
- Two independent inputs that accommodate both passive and active bass guitars.
- Protection relay circuitry that protects connected speakers from dangerous overloading and also prevents “thumps” when powering on or off.
- Effect loop send and return jacks that allow you to connect to professional out-board effects processors.
- An effect Balance knob which enables you to adjust the relative amount of Send (“dry”) versus Return (“wet”) effect signal being routed to the speaker outputs.
- Electronically balanced direct output that provides a means of routing signal to professional mixing consoles in both live performance and recording environments. A ground loop switch helps prevent hum or buzz from entering the signal, and a pre/post switch allows the direct signal to be derived either before or after the amp EQ section.
- Rugged construction makes the VX2510 & VX2515 eminently road-worthy.

# Guided Tour - VX2510 & VX2515 Front Panel

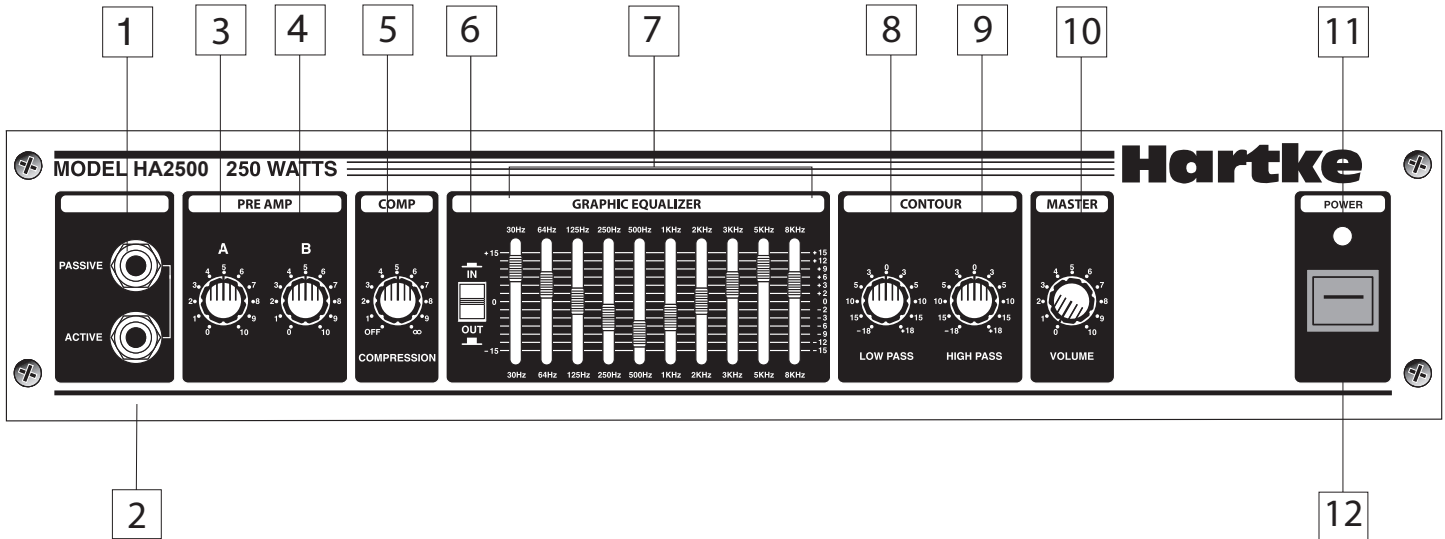

**1. Passive Input jack** - If your bass guitar has passive circuitry, connect it to the Model 2500 here. This standard, 1/4" unbalanced jack provides a high impedance (100 k Ohms) input sensitivity of 20 millivolts.

**2. Active Input jack** - If your bass guitar has active circuitry,\* connect it to the Model 2500 here. This standard, 1/4" unbalanced jack provides a high impedance (100 k Ohms) input sensitivity of 60 millivolts.

**3. Pre-Amp A (Tube Emulation) control** - This determines the amount of preamplification being provided by special circuitry which delivers the sound of a classic tube amplifier. Note that when both Pre-Amp knobs are used at equal settings, the amplifier will be twice as loud as when only one is used. Avoid setting both Pre-Amp knobs on maximum ("10"), since the result will almost always be undesirable distortion.

**4. Pre-Amp B (Solid State) control** - This determines the amount of preamplification being provided by special circuitry which delivers the sound of a solid state amplifier. Note that when both Pre-Amp knobs are used at equal settings, the amplifier will be twice as loud as when only one is used. Avoid setting both Pre-Amp knobs on maximum ("10"), since the result will almost always be undesirable distortion.

\* Bass guitars that have active circuitry normally require a battery for the circuitry to be functional.

# Guided Tour - VX2510 & VX2515 Front Panel

**5. Compression control** - This determines the amount of compression (peak signal reduction) by simultaneously adjusting both threshold and compression ratio (which ranges from 2:1 to infinity [limiting]). At the fully counterclockwise "Off" position, the circuitry is bypassed and no compression is applied (the knob clicks when set to the "Off" position). As the knob is raised clockwise (at settings from "1" to " $\infty$ ") increasing amounts of compression are applied. For more information, see the "About Compression" section on page 12 of this manual.

**6. Graphic Equalizer In/Out switch** - When pressed in (the "In" position), the Model 2500's graphic equalizer circuitry (as described in #7 below) is operational. When pressed out (the "Out" position), it is bypassed. The provision of this switch allows you to set up a custom equalization curve (an equalization "preset") with the graphic EQ sliders, which can then be activated with the press of a single button.

**7. Graphic Equalizer** - These sliders allow you to "draw" the tonal response of the system by adding 15 dB of boost or attenuation to ten different narrow-band frequency areas (30 Hz, 64 Hz, 125 Hz, 250 Hz, 500 Hz, 1 kHz, 2 kHz, 3 kHz, 5 kHz, and 8 kHz), affecting the main output signal of the Model 2500. When a slider is at its center detented ("0") position, the selected frequency area is unaffected (it is said to be flat). When a slider is moved up (above the "0" position, towards the "+15" position), the selected frequency area is boosted, and when it is moved down (below the "0" position, towards the "-15" position), the selected frequency area is attenuated. For more information, see the "About Equalization" section on pages 10 - 11 of this manual.

**8. Contour Low Pass control** - This acts as a broad-band low frequency equalizer, providing 18 dB of boost or attenuation at 100 Hz. You should generally adjust this control (and the Contour High Pass control, described in #9 below) prior to "fine-tuning" the system with the graphic equalizer (as described in #7 above). For more information, see the "About Equalization" section on pages 10 - 11 of this manual.

**9. Contour High Pass control** - This acts as a broad-band high frequency equalizer, providing 18 dB of boost or attenuation at 10 kHz. You should generally adjust this control (and the Contour Low Pass control, described in #8 above) prior to "fine-tuning" the system with the graphic equalizer (as described in #7 above). For more information, see the "About Equalization" section on pages 10 - 11 of this manual.

**10. Master Volume control** - This is the overall volume control. For best signal-to-noise ratio, keep the output of your bass at or near maximum and adjust the amp's Master Volume to the desired level.

**11. Power LED** - Lights whenever the Model 2500 is powered on.

**12. Power switch** - Use this to power the Model 2500 on or off.

# Guided Tour - VX2510 & VX2515 Rear Panel

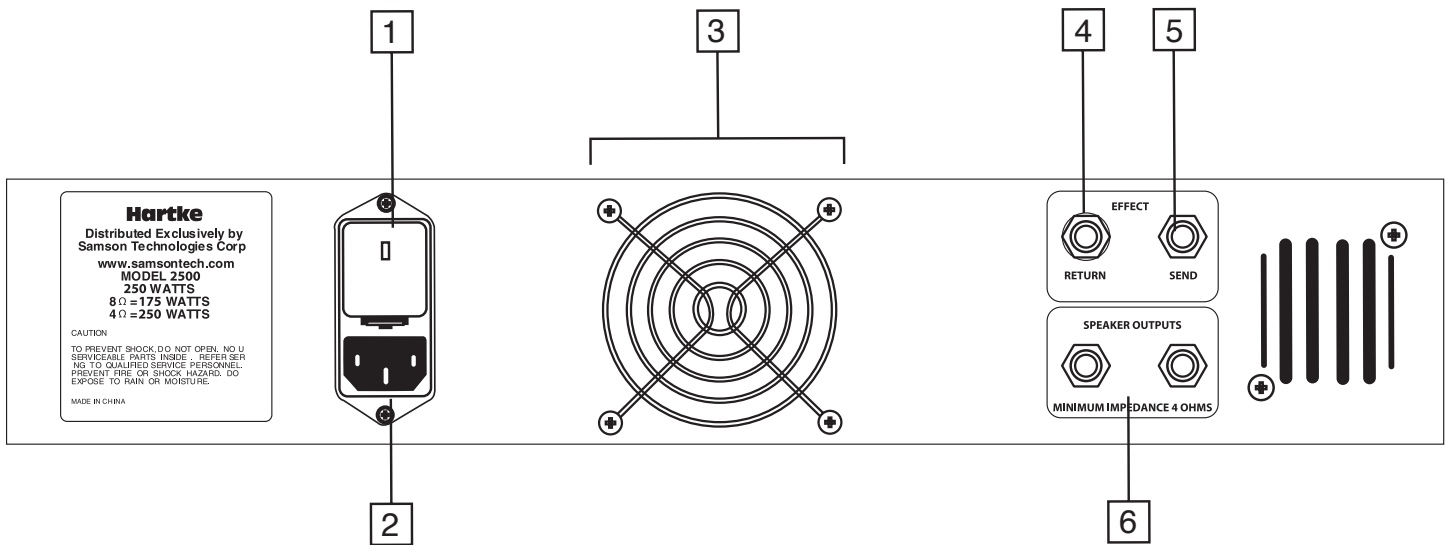

**1. Fuse sled** - This contains a fuse holder and shows the currently selected voltage rating for your Model 2500. Make sure the voltage rating is correctly set before powering up the amplifier! Fuse ratings are 10 amp for 115 vac and 6.2 amp for 230 vac. For information on how to change the voltage rating, see Appendix B on page 14.

**2. AC input** - Connect the supplied standard 3-pin "IEC" plug here.

**3. Fan** - The fan provides vital cooling to your Model 2500. Make sure that it is kept free of all obstructions and that cool, fresh air is accessible at all times. Also, try to ensure that the Model 2500 is used in a dust-free environment.

**4. Effect Return jack** - Use this 1/4" unbalanced jack to return low impedance (600 ohm) signal to the Model 2500 from a professional outboard effects processor.\*



## Guided Tour - VX 2500 Rear Panel

**5. Effect Send jack** - Use this 1/4" unbalanced jack to send low impedance (100 ohm) signal from the Model 2500 to a professional outboard effects processor such as a reverb, echo, chorus, flanger, or harmonizer device.\* Output level is approximately 0 dB to +4 dB and is post-EQ and post-compression but unaffected by the setting of the Master Volume control. You can also use the Effect Send jack to route signal to an external mixing console or amplifier with an input sensitivity of +4 dB.

**6. Speaker outputs** - The VX2510 & VX2515 internal speaker system is connected here.

*\* In-line effects (such as footpedals) intended for low signal levels should be placed between the bass and the amplifier Input and not connected with the Effect Send and Return jacks.*

*\*\* Note that the settings of the ten-band graphic equalizer will affect a "Post" Direct Out signal regardless of the position of the front panel In/Out switch.*

# Setting Up and Using the VX2510 & VX2515

Setting up your Hartke Systems VX2515/VX2510 Bass Amplifier is a simple procedure which takes only a few minutes:

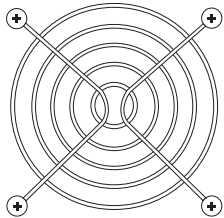

1. Remove all packing materials (save them in case of need for future service) and decide where the amplifier is to be physically placed. To avoid potential overheating problems, be sure that the rear panel is unobstructed and that there is good ventilation around the entire unit, particularly behind the rear-panel fan.

2. Locate the included casters, which are packed separately in the shipping carton, and follow the installation instructions outlined in Appendix A on page 13 of this manual.

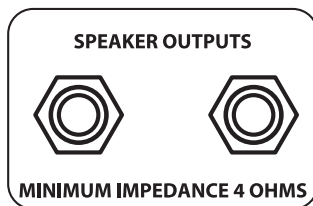

**WARNING:** Hartke amplifiers can deliver very high power levels. Driven to full power, they can damage connected loudspeakers, regardless of brand, size, or configuration. Care should be taken not to strain connected loudspeakers as this can cause permanent damage and will degrade the performance of the entire system. If you see connected loudspeakers moving excessively, turn your system down immediately or use the equalization and/or compression controls to reduce the amount of subharmonic (extremely low frequency) signal.

3. Next, connect the 3-pin AC plug into any grounded AC socket. Don't turn the amplifier on just yet, though.

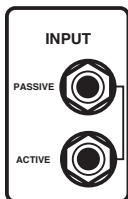

4. Use a standard music instrument cable to connect your bass to the appropriate Input jack on the front panel (if your bass has active circuitry,\* connect it to the "Active" input; if not, connect it to the "Passive" input). On the front panel of the Model VX2515/VX2510, set the Master volume control to "0" (fully counterclockwise) and set both Pre-Amp A (Tube) and B (Solid State) knobs to "5" (the twelve o'clock position). Set the Compression knob to its "Off" position (fully counterclockwise—you'll hear a click) and set both Contour knobs to their center detented "0" position. Finally, set the graphic equalizer In/Out switch to its "Out" position.

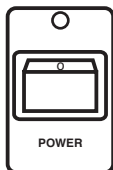

5. Press the front panel Power switch in order to turn on the amplifier. After approximately three seconds, you'll hear a click, indicating that the relay protection circuitry has completed cycling and that power to the system has been provided.

6. Set the output of your bass to maximum and then, while playing, slowly turn the Master volume control up until the desired level is achieved. If you hear distortion even at low amplifier Master volume settings, back off the output of your bass (or check for a faulty cable).

\* Bass guitars that have active circuitry normally require a battery for the circuitry to be functional.

# Setting Up and Using The VX2510 & VX2515

7. Experiment with altering the balance of the two Pre-Amp knobs, listening to the effect each has on the overall sound. Depending upon the specific instrument you are using and your personal taste, you may prefer the sound of one over the other, or you may prefer a particular blend of the two. Note that, when both are used at equal settings, the amplifier will be twice as loud as when only one is used. In step #4 on the previous page, we recommended that you begin with both knobs at their midway "5" setting, but the two Pre-Amp knobs can in fact be set to any blend you like. However, you will usually want to avoid setting both to their maximum "10" position since this setting will almost always result in undesirable distortion.

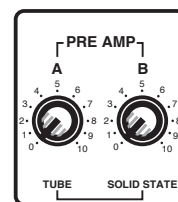

8. When you have settled on a Pre-Amp balance, the next step is to adjust the two Contour (bass and treble equalizer) controls to taste. For more information, see the "About Equalization" section on page 13 of this manual. When you get a great setting that complements your instrument and playing style, it's a good idea to write it down for future use.

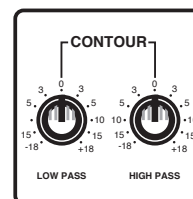

9. Next, experiment with the Model VX2515/VX2510 graphic equalizer. Begin by setting each of the ten sliders to their flat "0" center detented position. Then press in the In/Out switch (to its "In" position) so that the graphic equalizer is activated. Finally, move each slider in turn as you play your bass. For more information, see the "About Equalization" section on page 13 of this manual. Again, when you get a graphic equalization setting that complements your instrument and playing style, it's a good idea to write it down for future use.

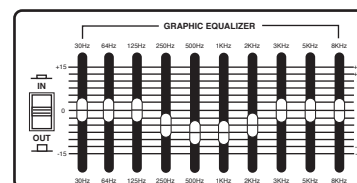

10. Now try out the Model VX2515/VX2510 compression circuitry. Activate it by turning the Compression knob clockwise from its "Off" position (you'll hear a click when it is activated). As you turn the knob clockwise, the input signal from your bass becomes more and more severely compressed—you'll hear peak signals (such as string slaps and pulls) begin to sound increasingly "squashed," relative to the lower-level signals produced by standard playing. The result will be a decreased dynamic range but an overall leveling of signal throughout the full pitch range of your instrument. For more information, see the "About Compression" section on page 15. In the Model 2500, the Compression LED will light steadily green when no compression is being applied, will go out whenever small amounts of compression are being applied and will flash or light steadily red when limiting (severe compression) is being applied.



11. If you're using an external signal processor, turn your Hartke amplifier off momentarily and then connect a standard audio cable between the Effect Send jack and your effects processor input and another standard audio cable between the Effect Return jack and your effects processor output (if required, multiple effects processors can be daisy-chained together, output to input). Then turn the amp back on and play your bass while adjusting the controls of your outboard effects processor(s). For best results, set both the input and output gain of all connected effects processor(s) to 0 dB (unity gain), so that there is no increase or decrease in level whether the effects are switched in or out.

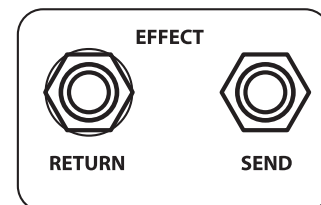

Model 2500 Effect Send/Return jacks

If you have followed all the steps above and are still experiencing difficulties, call Samson Technical Support (516-932-1062) between 9 AM and 5 PM EST.

\* For more information on the use of the Hartke 2500 effect Balance control, see page 10 in this manual.

# About Equalization

The Hartke Systems Model 2500 Bass Amplifier gives you enormous control over shaping the sound of your bass, using a process called equalization. To understand how this works, it's important to know that every naturally occurring sound consists of a broad range of pitches, or frequencies, combined together in a unique way. This blend is what gives every sound its distinctive tonal color. EQ controls allow you to alter a sound by boosting or attenuating specific frequency areas—they operate much like the bass and treble controls on your hi-fi amp, but with much greater precision. The Model 2500 provides you with two different means for equalizing your bass sound:

- Low Pass and High Pass Contour controls provide 18 dB of cut or boost in two broad frequency bands.
- A Graphic Equalizer provides 15 dB of cut or boost in ten narrow frequency bands.

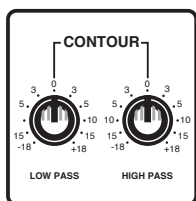

Contour controls

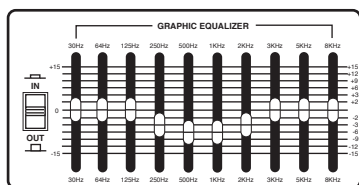

Graphic equalizer

Normally, you will adjust the two Contour controls before “fine-tuning” your EQ with the Graphic Equalizer. The Low Pass Contour control affects a broad band of frequencies with 100 Hz as the center point; similarly, the High Pass Contour control affects a broad band of frequencies with 10 kHz as the center point. When either is in its center detented position (“0”), it is having no effect. When it is moved right of center, the particular frequency area is being boosted; when it is moved left of center, the frequency area is being cut (“attenuated”). Because there is very little bass guitar energy at 10 kHz, the High Pass Contour control should be thought of as your overall “noise” control—turning it down (to the left of the “0” position) will help to eradicate hiss and buzz while having very little effect on the bass guitar signal. Similarly, the Low Pass Contour control, when set left of 0, can be used to eliminate rumble and “woofiness.”

The ten-band graphic equalizer provides ten sliders, each corresponding to a single narrow frequency band (at 30 Hz, 64 Hz, 125 Hz, 250 Hz, 500 Hz, 1 kHz, 2 kHz, 3 kHz, 5 kHz, and 8 kHz). This allows you to “draw” the desired tonal response of your system. When a slider is in its center detented position (“0”), it is having no effect. When it is moved above center (towards “+15”), the particular frequency area is being boosted; when it is moved below center (towards “-15”), the frequency area is being attenuated. We carefully selected these frequency areas because they have maximum impact on bass signals. For example, the lowest slider (30 Hz) affects the very lowest audible frequencies (in fact, most humans cannot hear below 20 Hz), while the highest four sliders (2, 3, 5, and 8 kHz) affects the “twang” of a bass string.

**WARNING: Use caution when raising the 30 Hz slider above 0 if you are operating at high volume levels (especially if Compression is not being used) since this can place undue stress on connected loudspeakers.**

# About Equalization

To find out how each graphic equalizer slider affects the sound of your particular bass, start with all ten bands flat (that is, all ten sliders at their detented “0” center position). Then, one by one, raise and lower each slider, listening carefully to the effect of each. If you don’t specifically need to utilize the ten-band graphic equalizer, bypass it by setting the In/Out switch to its “Out” position. Alternatively, you can preset a custom graphic equalization curve (for example, for a feature solo) and activate it simply by pressing the switch when needed. Note that turning all EQ controls up the same amount will have virtually the same effect as simply turning up the Master Volume; conversely, turning them all down the same amount will have virtually the same effect as turning down the Master Volume. Both approaches are pointless (after all, that’s why we gave you a Master Volume control!)

In many instances, the best way to deal with equalization is to think in terms of which frequency areas you need to attenuate, as opposed to which ones you need to boost. Be aware that boosting a frequency area also has the effect of boosting the overall signal; specifically, too much low frequency EQ boost can actually cause overload distortion or even harm a connected speaker, though the Model 2500’s compression circuitry—if on—will act to some extent to prevent this from occurring. In general, if you’re going to apply a fair amount of low frequency EQ boost, it’s a good idea to keep Compression on, if only to protect your speakers from potential damage.

The specific EQ you will apply to your bass signal is very much dependent upon your particular instrument and personal taste and playing style. However, here are a few general suggestions:

- For that super-deep reggae or Motown sound, boost low frequencies slightly while attenuating the highest ones (leave mid-range frequencies flat or slightly attenuated), as shown in the illustration on the right.
- To remove boxiness and make your instrument sound more “hi-fi,” try attenuating mid-range frequencies while leaving low and high frequency settings flat, as shown in the illustration on the right.
- For a twangy, cutting sound, try boosting the high and high mid-range frequencies, as shown in the illustration on the right (putting new round-wound strings on your bass will help a lot also!)
- Whenever you get a really good EQ setting for a particular instrument or song, write it down (you’d be amazed how easy it is to forget these things!).

Finally, as you experiment with the EQ controls of the Model 2500, don’t forget that your bass also provides EQ controls in the form of its tonal settings—this can be particularly effective in instruments that have active circuitry. Also, try various EQ settings with different Pre-Amp blends and with and without Compression. For more information, see the “About Compression” section on the following page.

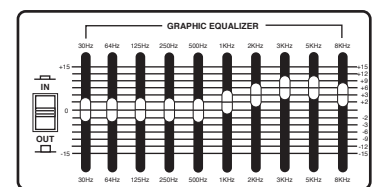
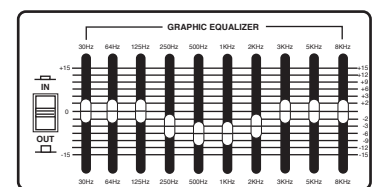
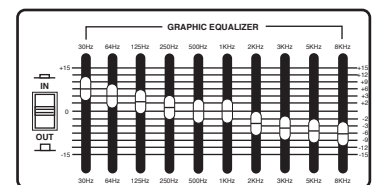

# About Compression

The dynamic range of a sound is the difference between its loudest and softest points. For example, as you play your bass, you'll probably find that some notes (for example, notes played on the upper frets of the lowest string) are considerably louder than others. The function of the Compression circuitry in the Model 2500 Bass Amplifier is to reduce overall dynamic range by automatically reducing the level of the loudest sounds you play so that they are closer in level to softer ones—the end result is that the sound “evens out” and all notes played have pretty much the same level.

The front-panel Compression control determines the amount of compression (peak signal reduction) by simultaneously adjusting both threshold and compression ratio (which ranges from 2:1 to infinity [limiting]). At the fully counterclockwise “Off” position, the circuitry is bypassed and no compression is applied (the knob clicks when set to the “Off” position). As the knob is raised clockwise (at settings from “1” to “∞”) increasing amounts of compression is applied. At the highest settings, loud sounds will not just be compressed, but limited, where the output remains virtually constant regardless of input.

The Model 2500 provides a front-panel Compression LED which acts as a useful visual indicator of the continuous activity of the compression circuitry. When lit steadily green (for example, when the Compression knob is set to “Off”), no compression is being applied. When unlit, compression is being applied to the incoming signal at a ratio of approximately 2:1. When flashing red, the compression ratio is approaching infinity (limiting is being applied). When lit steadily red, the signal is being limited. This LED “follows” the incoming signal, changing continuously as different amounts of compression and/or limiting are being applied.



VX2510 & VX2515  
Compression control and  
LED

Compression has three main uses. First, as just described, it “evens” out the notes played by your bass so that they all appear at virtually equal level. Second, it adds “punch” to a sound; since all levels are nearly the same, you can play with greater force without worrying about the loudest notes distorting. Finally, it serves to protect your loudspeakers from damage as a result of brief (transient) high output levels, as might be caused by finger-popping or other performance techniques.

Whether or not you need to use compression with your Model 2500 will be a matter of personal taste and playing style—experiment and see if you like the effect. If you usually play at low volume levels, you'll find that, even with the Compression knob turned up, the compression circuitry may have no audible effect, so it might as well be off. In general, if you don't need compression, leave it off.

# Appendix A: CASTER INSTALLATION

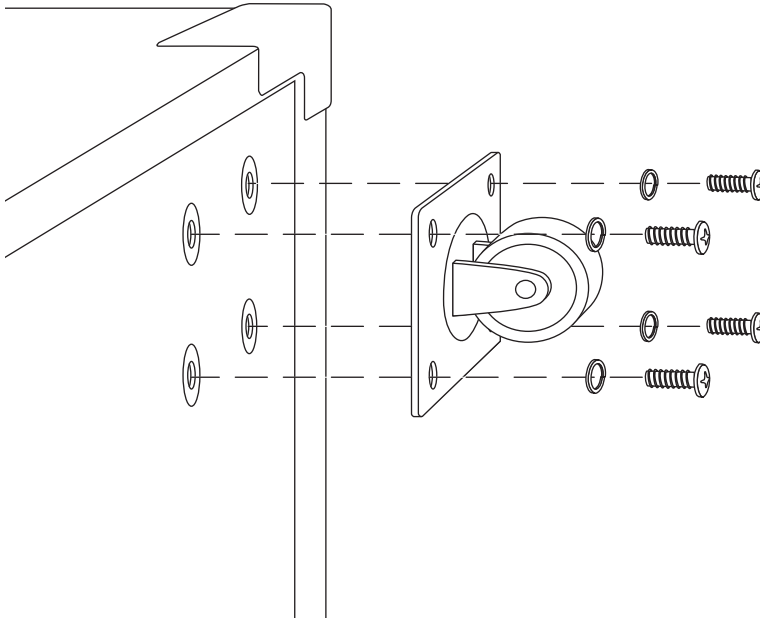

- Locate one caster and four each of the supplied screws and lock washers.
- Hold the caster in place and hand start the screws. Be careful to ensure that the screws are on the proper thread chase. DO NOT PUSH TEE NUT INTO ENCLOSURE.
- Use a screw driver to tighten the four screws. Be careful not to over tighten the screws.
- Repeat the steps above for the remaining three casters.

# Appendix B: Block Diagram

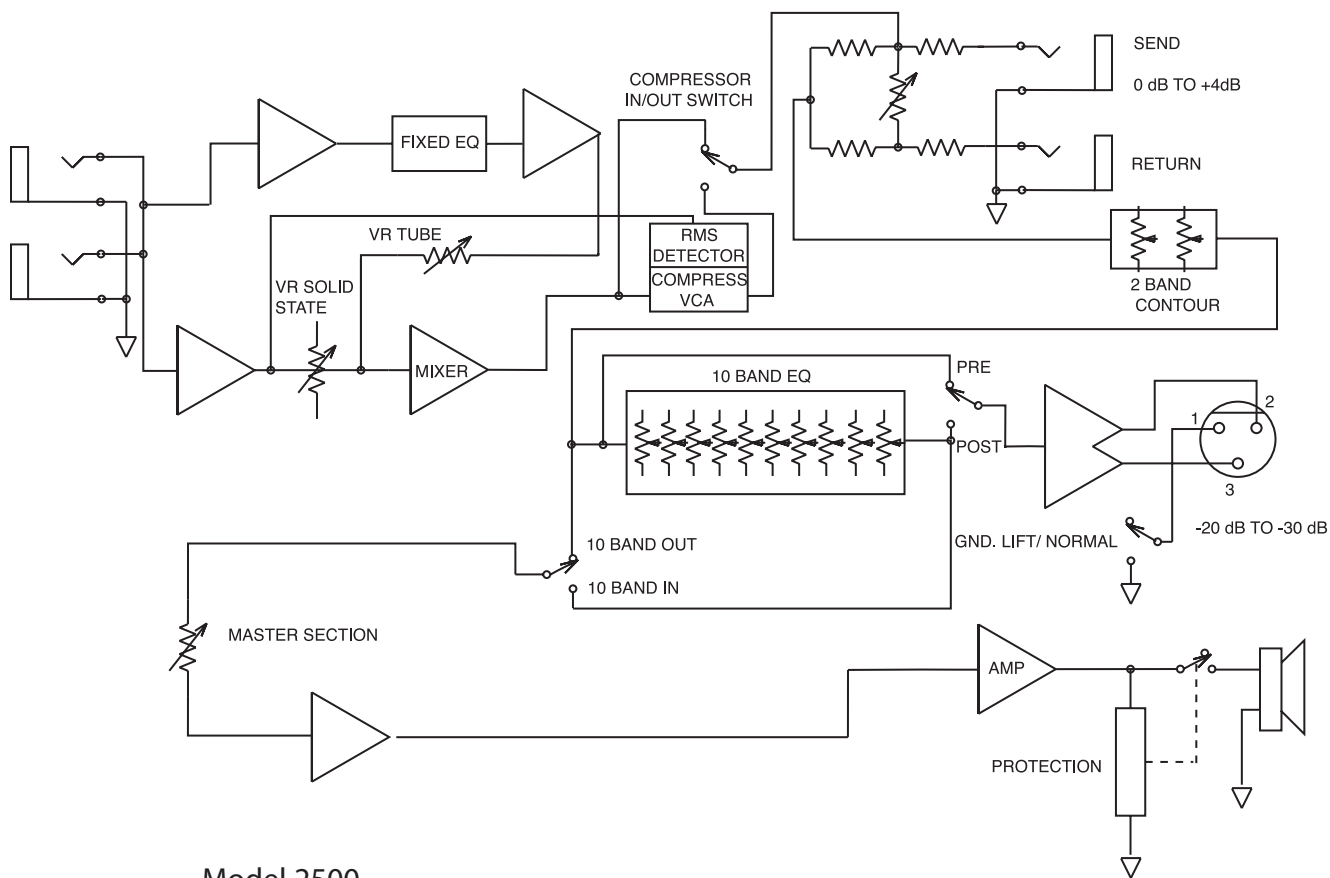

Model 2500



## Appendix C: Changing the VX2510 & VX2515 Voltage

Following are step-by-step instructions for changing the mains voltage of the Model HA2500.

**WARNING: Before carrying out this operation, remove the power cord!**

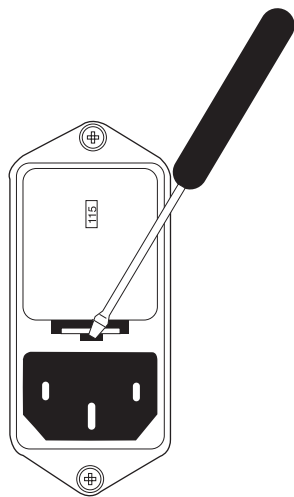

**1:** Insert a small screwdriver into the slot beneath the fuse sled and gently press in and up. The fuse sled will pop out approximately 3/8" inch.

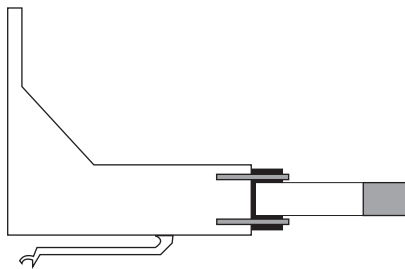

**2:** Remove fuse sled.

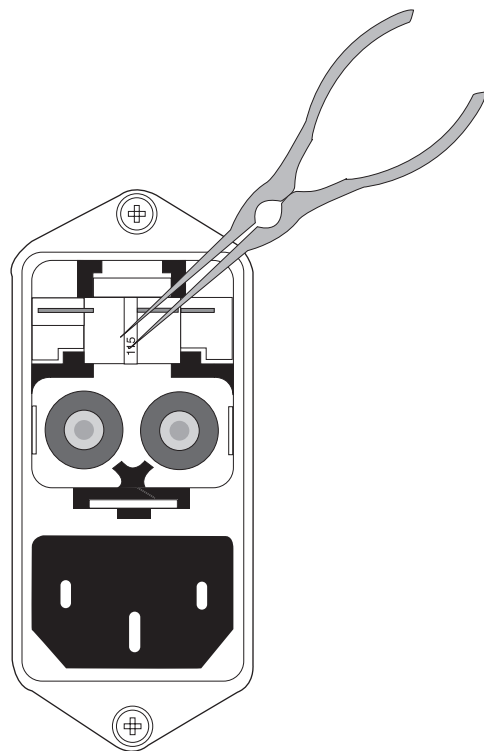

**3:** Use a small pair of needle-nose pliers to gently pull out the mains jumper.

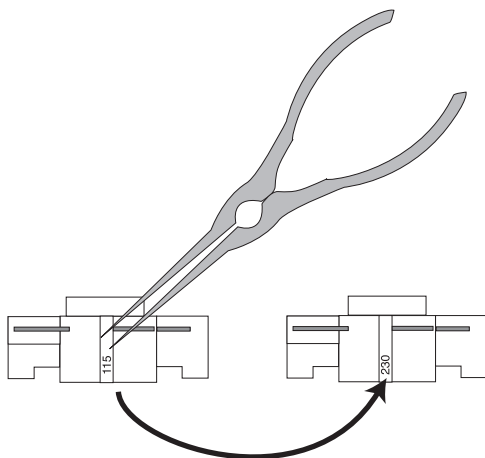
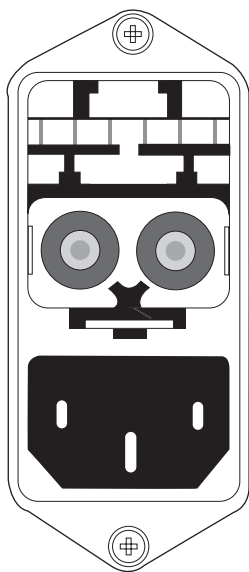

**4:** Use the needle-nose pliers to reverse the mains jumper so that the other voltage value is facing outwards, then reinsert the mains jumper. Finally, reinsert the fuse sled by gently pushing it back in until you hear a click.

**5:** Be sure that the proper voltage selection shows in the Fuse Sled window before use.

Note that the fuse sled carries two fuses—one for 115 volt operation (actually 105 - 120 volts) and another for 230 volt operation (actually 220 - 240 volts). **The position of the two fuses in the sled as well as the fuse ratings must be maintained for adequate protection.**

Fuse ratings for the Model 2500 are: 5 amp for 115 VAC and 2.5 amp for 230 VAC.

# Specifications

<b>Input Sensitivity</b>	
Passive Input	100 k Ohms 20 mv.
Active Input	100 k Ohms 60 mv.
<b>Rated Output Power</b>	250 watts @ 4 ohms
<b>Total Harmonic Distortion</b>	less than .5%
<b>Signal To Noise Ratio</b>	approx. 78 dBm
<b>Equalizer</b>	
Contour Low Pass	±18 dB @ 100 Hz
Contour High Pass	±18 dB @ 10 kHz
Ten-Band Graphic	±15 dB, center detented @ 30 Hz, 64 Hz, 125 Hz, 250 Hz, 500 Hz, 1 kHz, 2 kHz, 3 kHz, 5 kHz, 8 kHz
<b>Compression Ratio</b>	2:1 to infinity
<b>Send Output Level</b>	0 dBm
<b>Return Input Level</b>	0 dBm
<b>VX2510 Speaker System Impedance (Ohms)</b>	4 Ohms Impedance
<b>Low Frequency Drivers</b>	2-10" Special Design 8 ohm, 150 watt Speakers,
<b>High Frequency Driver</b>	1" Throat Compression Driver
<b>VX2515 Speaker System Impedance (Ohms)</b>	4 Ohms Impedance
<b>Low Frequency Drivers</b>	1-15" Special Design 4 ohm, 250 watt Speakers,
<b>High Frequency Driver</b>	1" Throat Compression Driver
<b>VX2510 Weight</b>	75 lbs. (34 kg)
<b>Dimensions</b>	Height: 29" (73.3 cm) Width: 26.5" (67.6 cm) Depth: 17.25" (43.5 cm)
<b>VX2515 Weight</b>	76.5 lbs. (34.8 kg)
<b>Dimensions</b>	Height: 30.75" (78 cm) Width: 26.5" (67.6 cm) Depth: 17.25" (43.5 cm)



Hartke  
45 Gilpin Avenue  
Hauppauge, New York 11788-8816  
Phone: 1-800-3-SAMSON (1-800-372-6766)  
Fax: 631-784-2201  
[www.hartke.com](http://www.hartke.com)

## Free Manuals Download Website

<http://myh66.com>

<http://usermanuals.us>

<http://www.somanuals.com>

<http://www.4manuals.cc>

<http://www.manual-lib.com>

<http://www.404manual.com>

<http://www.luxmanual.com>

<http://aubethermostatmanual.com>

Golf course search by state

<http://golfingnear.com>

Email search by domain

<http://emailbydomain.com>

Auto manuals search

<http://auto.somanuals.com>

TV manuals search

<http://tv.somanuals.com>