

SAMSON[®]

SM10

10-Channel Rack Mount Line Mixer

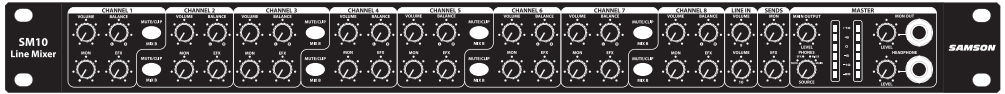

Owner's Manual

www.samsontech.com

Download from Www.Somanuals.com. All Manuals Search And Download.

Important Safety Information



AVIS
RISQUE DE CHOC ÉLECTRONIQUE -
NE PAS OUVRIR

CAUTION: TO REDUCE THE RISK OF ELECTRIC SHOCK, DO NOT REMOVE COVER (OR BACK). NO USER-SERVICEABLE PARTS INSIDE. REFER SERVICING TO QUALIFIED SERVICE PERSONNEL.



This lightning flash with arrowhead symbol within an equilateral triangle is intended to alert the user to the presence of non-insulated "dangerous voltage" within the product's enclosure that may be of sufficient magnitude to constitute a risk of electric shock.



The exclamation point within an equilateral triangle is intended to alert the user to the presence of important operating and maintenance instructions in the literature accompanying the appliance.



If you want to dispose this product, do not mix it with general household waste. There is a separate collection system for used electronic products in accordance with legislation that requires proper treatment, recovery and recycling.

Private household in the 25 member states of the EU, in Switzerland and Norway may return their used electronic products free of charge to designated collection facilities or to a retailer (if you purchase a similar new one).

For Countries not mentioned above, please contact your local authorities for a correct method of disposal.

By doing so you will ensure that your disposed product undergoes the necessary treatment, recovery and recycling and thus prevent potential negative effects on the environment and human health.

Important Safety Information

1. Read these instructions.
2. Keep these instructions.
3. Heed all warnings.
4. Follow all instructions.
5. This apparatus shall not be exposed to dripping or splashing liquid and no object filled with liquid, such as a vase, should be placed on the apparatus.
6. Clean only with a dry cloth.
7. Do not block any of the ventilation openings. Install in accordance with the manufacturer's instructions.
8. Do not install near any heat sources such as radiators, heat registers, stoves, or other apparatuses (including amplifiers) that produce heat.
9. Only use attachments/accessories specified by the manufacturer.
10. Unplug this apparatus during lightning storms or when not in use for long periods of time.
11. Do not override the intended purpose of the polarized or grounding-type plug. A polarized plug has two blades, with one wider than the other. A grounding-type plug has two blades and a third grounding prong. The wide blade, or third prong, is provided for your safety. If the provided plug does not fit your outlet, consult an electrician to replace the obsolete outlet.
12. Protect the power cord from being walked on or pinched, particularly at the prongs, convenience receptacles, the point where they exit from the apparatus.
13. Use only with the cart stand, tripod bracket, or table specified by the manufacture, or sold with the apparatus. When a cart is used, utilize caution when moving the cart/apparatus combination to avoid injury from tip-over.
14. Refer all servicing to qualified service personnel. Servicing is required if the apparatus has been damaged in any way, such as power-supply cord or plug breakage, damage due to liquid or objects falling onto the apparatus, exposure to rain or moisture, or if the apparatus does not operate normally, or has been dropped.
15. **POWER ON/OFF SWITCH:** For products with a power switch, the power switch DOES NOT break the connection from the mains.
16. **MAINS DISCONNECT:** The plug should remain readily operable. For rack-mount or installation where plug is not accessible, an all-pole mains switch with a contact separation of at least 3mm in each pole shall be incorporated into the electrical installation of the rack or building.
17. **FOR UNITS EQUIPPED WITH EXTERNALLY ACCESSIBLE FUSE RECEPTACLE:** Replace fuse with same type and rating only.
18. **MULTIPLE-INPUT VOLTAGE:** This equipment may require the use of a different line cord, attachment plug, or both, depending on the available power source at installation. Connect this equipment only to the power source indicated on the equipment rear panel. To reduce the risk of fire or electric shock, refer servicing to qualified service personnel or equivalent.



53125A

Table of Contents

Introduction.	1
Package Contents	2
Features	3
Controls and Functions.	4
Input and Output Connections.	7
SM10 Quick Start.	9
SM 10 System Setup.	12
SM10 Wiring Guide	13
Specifications.	14

Copyright 2010, Samson Technologies Corp.
v1
Samson Technologies Corp.
45 Gilpin Avenue
Hauppauge, New York 11788-8816
Phone: 1-800-3-SAMSON (1-800-372-6766)
Fax: 631-784-2201
www.samsontech.com

The Samson SM10 rack mount mixer is a versatile tool for many sound applications. The SM10 mixer features eight independent stereo line input channels, and includes two channels with XLR microphone preamps. There are also two additional line inputs with stereo 1/4" jacks and level controls that can be used to daisy-chain SM10 mixers together. The SM10 features a multitude of signal routing options, with Monitor (Pre-Fade), EFX (Post-Fade), and Mix B sends on Channels 1-8. The Master section of the SM10 features expanded monitoring capabilities. The headphone output and meter bridge can be selected to monitor the MON out, EFX out, Mix B, or Main output. There is also an extra MON output with level control for quick patching to the MON send without having to go to the rear panel. Built into a single space 19-inch rack with internal power supply, the SM10 is reliable for any installation and rugged enough to be used on the road.

In these pages, you'll find a detailed description of the features of the SM10 rack mount mixer, as well as a guide to its control panel, instructions for setup and use, and full specifications. You'll also find a warranty card enclosed. Please don't forget to fill it out and mail it in so that you can receive online technical support, and so that we can send you updated information about this and other Samson products in the future. Also, be sure to check out our website (www.samsontech.com) for information about our full product line.

With proper care, your SM10 will operate trouble-free for many years. We recommend you record your serial number in the space provided below for future reference.

Serial number: _____

Date of purchase: _____

Should your unit ever require servicing, a Return Authorization number (RA) must be obtained before shipping your unit to Samson. Without this number, the unit will not be accepted. Please call Samson at 1-800-3SAMSON (1-800-372-6766) for an RA number prior to shipping your unit. Please retain the original packing materials and if possible, return the unit in the original carton and packing materials. If you purchased your Samson product outside the United States, please contact your local distributor for warranty information and service.

Package Contents

Unpack the carton and check for all parts shown. Save the carton and packing material in case you ever move or need to send the units for service.

If any part of the product appears to be damaged, do not attempt to use it. Contact your authorized Samson dealer or local distributor.

- SM10 Mixer



- Power Cable

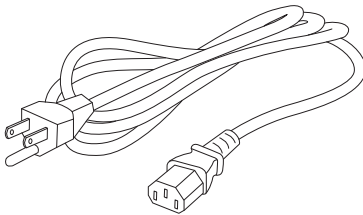

- Owner's Manual

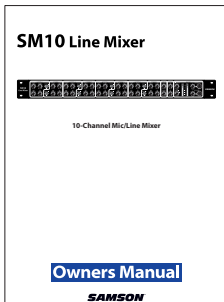



The Samson SM10 rack mount mixer is a comprehensive all-in-one solution for fixed installation, live sound, on-stage monitoring, keyboard submixer and recording applications. Here are some of its main features:

- 10 input channels – Two Mic/Line plus ten stereo line
- Low noise, discrete microphone pre-amplifiers with 48-Volt phantom power.
- Versatile signal routing via Main Mix, Mix B, Mon, EFX bus outputs, as well as mono output.
- Balance controls for each channel that allow you to blend the relative levels of stereo inputs.
- Two auxiliary sends can be used to route signals to external effects, or to create a separate mix for on-stage monitors.
- Front-panel headphone and mono output jack with dedicated level controls
- Flexible headphone and six-segment LED meter source control allows you to monitor the MON, EFX, MIX B and MAIN MIX
- Line Input Level switch for +4 dBu or -10 dBV line level input signals.
- Electronically balanced main stereo XLR and 1/4" line outputs.
- Center detents for all input controls, for use in low-light situations such as live performance.
- Single 19" rack-mount metal chassis with internal power supply, easily integrated into any existing system.
- Quality built and rugged construction ensure reliable performance from venue to venue and session to session.

Controls and Functions

The following section details each part of the SM10 controls and functions.

- 1. VOLUME** – This knob controls the volume of channel inputs and is used to continuously adjust the loudness of the various signals being blended together at the Main Outputs. There is a detent at the 12 o'clock position of the knob, which indicates unity gain.

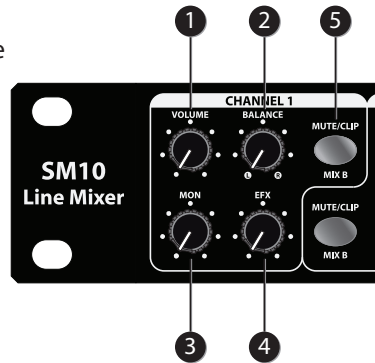

Moving the knob counterclockwise from the 12 o'clock position causes the signal to be attenuated. Moving it clockwise from the 12 o'clock position causes the signal to be boosted.

For best signal-to-noise ratio, all Volume controls for channels carrying signal should generally be kept at or near the 12 o'clock position. Channels that are unused should have their Volume controls kept fully counterclockwise at their minimum level.

- 2. BALANCE** – When the both inputs of a channel are connected, the left input signal is automatically panned hard left and the right input signal is automatically panned hard right. In this case, the Balance knob controls the relative levels of the paired input signals. When the knob is placed at its center detent position, both signals are at equal strength. When moved left of center, left input signal remains at the same strength but the right input signal is attenuated. When the knob is moved right of center, the left input signal remains at the same strength but the right input signal is attenuated.

When only the left input is connected, the Balance knob functions as a constant level Pan control, allowing you to continuously place the incoming signal anywhere in the left-right stereo field.

- 3. MON (Monitor) Send** – The MON send knob allows you to route the signal to the MON outputs. The MON send is pre-fader so the signal is unaffected by the position of the channel Volume control. These sends are usually used to create a separate mix for a monitor system. When the MON send knob is at the 12 o'clock center detent position, the signal is routed with unity.

4. EFX (Effects) Send – The EFX send knob allows you to route the signal to the EFX outputs. The EFX send is post-fader so the level of the signal is determined by the position of the channel Volume control. These sends are usually used to route signal to outboard effects devices. When the EFX send knob is at the 12 o'clock center detent position, the signal is routed with unity.

5. MUTE/CLIP/MIX B – This switch will flash RED when the channel input signal peaks. To reduce distortion, turn the Volume control counterclockwise until the clip indicator does not light during normal use. When the switch is depressed the channel's signal path is interrupted to the main mix and the channel is assigned to the MIX B bus.

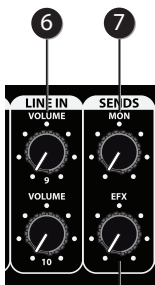

6. LINE IN VOLUME – The SM10 features two additional stereo Line Inputs (channels 9 and 10) which can be used to return the outputs of the an external effects processor, or to connect the output of any stereo line level device to the main mix.

7. MON Send – The MON signals (see #3) from input channels 1-8 are mixed together and sent to the MON Outputs. Use the MON send control to set the amount of signal being sent to the MON Output.

8. EFX SEND – The EFX signals (see #4) from input channels 1-8 are mixed together and sent to the EFX Output. Use the EFX level controls to set the amount of signal being sent to EFX Output.

9. MAIN OUTPUT LEVEL – This knob determines the final output signal level. Signals from all channels are routed here just before leaving the SM10 via its left and right Main Output jacks. The 12 o'clock center detent position of the control indicates unity gain (no level attenuation or boost).

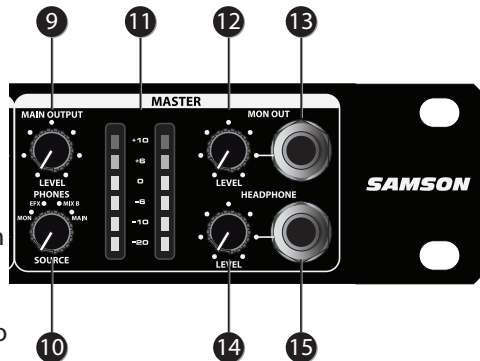

10. SOURCE Select Switch – The Source select Switch allows you to configure the Output Meter (see #11) and Headphone output (see #15) to monitor the MON, EFX, MIX B and Main Output buses.

Controls and Functions

- 11. Output Meter** – This six-segment meter shows the continuous output level of the Main Mix, MON, EFX, or MIX B, depending on the position of the SOURCE select switch (see #10). For optimum signal-to-noise ratio, adjust all levels so that program material is usually at or around 0 VU, with occasional, but not steady, excursions to the red segments.
- 12. MON OUT LEVEL** – The SM10 provides a second MON output connector carrying a mono signal of the MON mix. The MON OUT LEVEL control knob is used to set the volume of the MON OUT jack.
- 13. MON OUT Jack** – The left and right MON mix are summed together to a monaural signal and sent out this connector. The signal at the MON OUT jack follows the MON OUT LEVEL (see #12) control knob.
- 14. HEADPHONE LEVEL** – This knob sets the level of the signal sent to the HEADPHONE jack. To avoid possible damage to connected headphones, always turn this all the way off (to the fully counterclockwise position) before plugging in a pair of headphones—then raise the level slowly while listening.
- 15. HEADPHONE Jack** – Connect standard stereo headphones to this jack (via a 1/4" TRS plug) for monitoring of the MON, EFX, MIX B and Main Output buses, depending on the position of the SOURCE select switch (see #10).

Input and Output Connections

16. Mic/Line Inputs (channels 1 and 2) - Use these Combo XLR plus 1/4-inch jacks to connect a microphone or line level signal to channels 1 and 2. The XLR inputs provide 48-volt phantom power for use with condenser microphones.



17. Line Inputs - Use these balanced 1/4" jacks to connect line level sources such as synthesizers, drum machines, MP3 players, or effects processors to any of the 8 channels. When connecting monophonic (as opposed to stereo) signal sources, use the left inputs; the Balance control for that channel will then act as a constant level pan control.

18. Input Level Switch - Use this switch to independently set the sensitivity of channels 1-8 line level inputs. When the switch is in the up position the input are set to +4dBu. When the switch is depressed the input is set to -10dBv.



19. Stereo LINE IN (channels 9-10) - Two stereo 1/4-inch jacks for connecting stereo line level sources like those from the outputs of effects processors. These inputs can also be used to link multiple SM10's or to add the output from another mixer to the SM10 without taking up channel line inputs.

20. MON Output - The signals present at the MON stereo 1/4-inch output are sent from the MON send, which are fed from the input channels' MON control knobs. In a live sound situation this can be used to create a monitor mix by connecting the MON output to a power amp and monitor speaker.

21. EFX Output - The stereo 1/4-inch EFX Output is used to send a signal to an external signal processor such as a delay or reverb. The signal present at the EFX Output is sent from the EFX bus, which is fed from the input channel's EFX control knob.

Input and Output Connections

22. MAIN OUTPUTS 1/4-inch Jacks - In live performance applications, these outputs can be used to connect the SM10 to a power amp and speakers. In recording applications, these outputs are used to connect to a stereo device such as computer sound card, MP3, or hard disk recorder. The signals at the Main Outputs jacks follow the Main Output level controls.

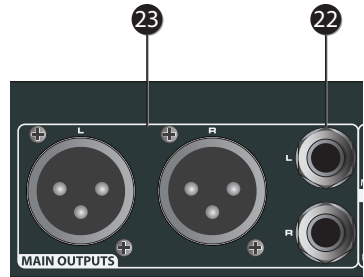

23. MAIN OUTPUTS XLR Jacks - In live performance applications, these male XLR outputs can be used to connect the SM10 to a power amp and speakers. In recording applications, these outputs can be used to connect to a stereo device such as computer sound card, MP3, or hard disk recorder. The signal at the Main Outputs jacks follow the Main Output level control.

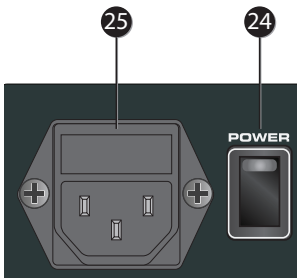

24. Power Switch – Use this switch to turn the SM10 on and off. To avoid potential damage to your speakers, turn the SM10 on before you turn on any connected power amps—and turn it off after the power amps are turned off. The switch should be in the off position when connecting the SM10 to the mains.

25. AC Inlet – Connect the supplied IEC cable here.

The following section explains the basic operation of the SM10.

CONNECTING MICROPHONES AND INSTRUMENTS

1. Remove all packing materials (save them in case of need for future service) and decide where the unit is to be physically placed—it can be mounted in any standard 19" rack (requiring one rack space), or used on a tabletop.
2. Before connecting mics or instruments, make sure that the power to all your systems components, including the SM10, are turned off. Also, make sure that the Main Output control knob is turned all the way down.
3. Connect the cable(s) to your microphone(s) and instrument(s), and insert the other end of the cable(s) firmly into the appropriate input(s) on the SM10.

NOTE: SETTING THE INPUT GAIN – When connecting a microphone to channels 1 and 2, it's a good idea to start with the Volume control turned all the way down. Slowly raise the Volume control until you see the CLIP LED turn on. Now, back the Volume control down so that the MUTE/CLIP LED only lights for a short time during the loudest input the channel will experience.

4. Switch on the power of any peripheral devices, and then power up the SM10.

NOTE: It is important to remember the Golden Rule of audio ... "LAST ON, FIRST OFF". Translated, this means that when turning on your system, you should always turn your power amplifiers or powered monitors on LAST, and when turning your system off, turn your power amps off FIRST. This helps avoid any loud pops caused by rush current at power up, which can sometimes damage loudspeakers.

5. Turn on your power amp or powered monitors and raise the level control to the manufacturers' recommended operating level.
6. Set the Main Output control of the SM10 master section to the 12 o'clock (unity) position.
7. While speaking into the mic (or playing the instrument), adjust the channel Volume control so that the "0" LED of the MAIN section peak level meter lights only occasionally.

SM10 Quick Start

SENDING AN INDEPENDENT MIX TO THE MONITOR SPEAKERS



The SM10's MON auxiliary send can be used to feed a separate set of amplifiers and loudspeakers for stage monitors. This lets you build one stereo mix for the main mix, or amplifiers and speakers facing the audience, and another stereo mix for the amplifiers and monitor speakers facing the musicians.

1. Raise the MON controls for the channels that you wish to hear from the monitor speakers.

NOTE: MON controls are “pre-fader sends,” which means they are not affected by the Volume control level settings of each channel. This allows you to create a mix for the monitors that is independent of the main left and right mix.

2. Raise the MON SEND control to adjust the level of the mixed signal from the channel MON controls until the desired level is reached at the rear panel MON Output jack.

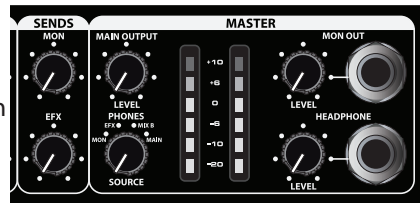

3. For added monitoring flexibility, the front panel MON Output (mono) can be connected to a powered monitor speaker. Slowly raise the MON Level control until the desired level is reached.
4. The MON mix can be monitored via headphones, by setting the PHONES SOURCE switch to MON.

NOTE: Listening to high volume levels through headphones for even a short time may damage your hearing and/or your headphones. Always turn the HEADPHONE LEVEL control all the way counterclockwise before connecting your headphones. Slowly raise the HEADPHONE LEVEL until a comfortable listening level is reached. Noise over 85 dB can cause gradual hearing loss. Learn to establish a safe listening level.

USING AN EXTERNAL EFFECT

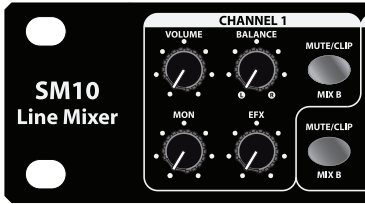

If you prefer to use an external device for effects processing, you can easily connect the unit using the SM10 EFX bus. Follow the simple steps below to interface your processor:

1. Connect the EFX OUTPUT to the input of the external effect processor.
2. Connect the outputs of the effects processor to channel 9 stereo line input.
3. Set the EFX SEND control to the 12 o'clock position.
4. Raise the EFX knobs for the channels to which you want the external effect to be applied.
5. Set the input level of the external effect so that the sound is not distorted and so that the effect's input meter does not indicate a clipped signal.
6. Use the channel 9 Volume control to adjust the level of the effects processed by the external effects device.
7. The EFX bus can be monitored via headphones, by setting the PHONES SOURCE switch to EFX.

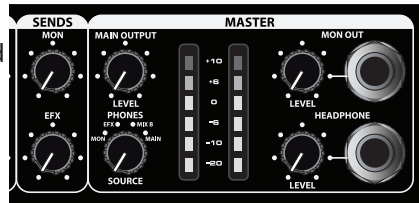

NOTE: Listening to high volume levels through headphones for even a short time may damage your hearing and/or your headphones. Always turn the HEADPHONE LEVEL control all the way counterclockwise before connecting your headphones. Slowly raise the HEADPHONE LEVEL until a comfortable listening level is reached. Noise over 85 dB can cause gradual hearing loss. Learn to establish a safe listening level.

SM10 System Setup

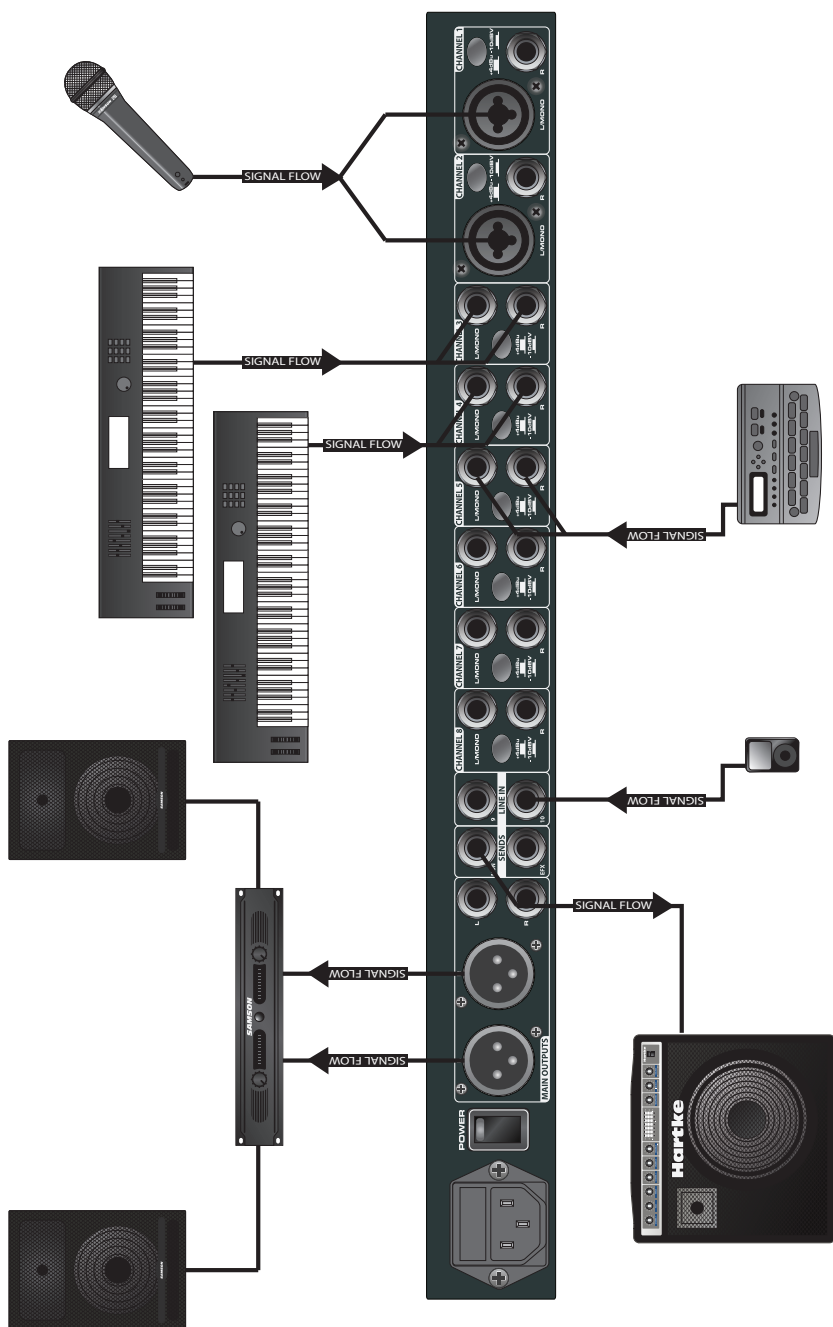

CONNECTING THE SM10

There are several ways to interface the SM10 to support a variety of applications. The SM10 features balanced inputs and outputs, so connecting balanced and unbalanced signals is possible.

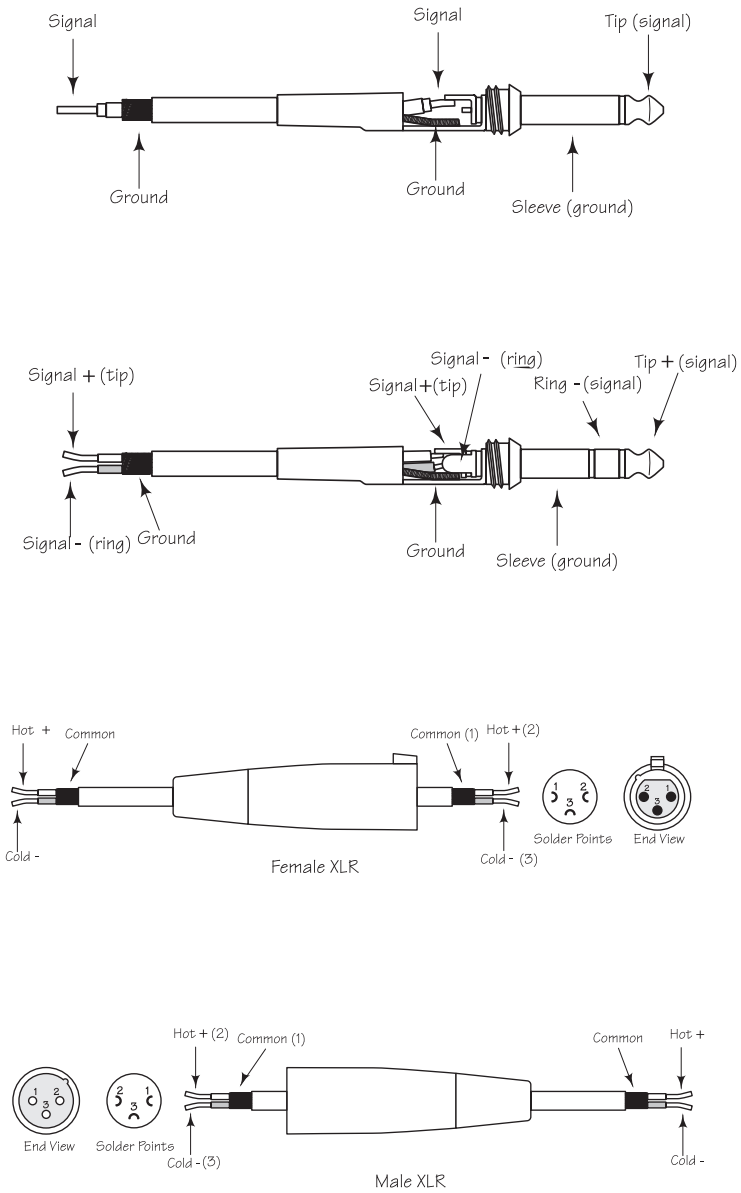

Specifications

Inputs

Microphone	XLR balanced (2)
Line	1/4" TRS balanced (Ch 1-8), 1/4" stereo (Ch 9-10)
Input Impedance	
Mic	1.5K Ohms
Line	23K Ohms (+4 dBu, Ch 1-8) 40K Ohms (-10 dBV, Ch 1-8) 20K Ohms (Ch 9-10)
Maximum Gain	
Mic	65 dB
Line	39 dB
Line Operating Level	+4 dBu / -10 dBV selectable
Maximum Input Level (1 kHz, ± 3 dB)	
Mic Input	-4 dBu
Line Input	+28 dBu
Equivalent Input Noise	-123 dBu unweighted

Outputs

Main Outputs	
Type	1/4" TRS balanced (2), XLR (2)
Output Impedance	200 Ohms Main Out
Gain Range	$-\infty$ to +15 dB
Max output level	+22 dBu
MON (Pre Fade Out)	1/4" impedance balanced mono output (front panel), Stereo MON (rear panel)
EFX (Post Fade Out)	1/4" unbalanced
Output Impedance	100 Ohms
Headphone	1/4" TRS Stereo
Output (600 Ohm load)	100 mW

System

Frequency Response	10 Hz – 23 kHz ± 1 dB
Signal-to-noise ratio	> 90 dB typical
THD	<0.01% typical
Crosstalk (1 kHz)	-70 dB between input channels -70 dB between input/output channels
Phantom Power	48 Volts DC
Power Requirements	120-240 VAC / 50-60 Hz
Dimensions	19" L x 8.25" W x 1.75" H 484mm L x 210mm W x 44.5mm H
Weight	6 lbs / 2.8 kg

SAMSON[®]

45 Gilpin Avenue

Hauppauge, New York 11788-8816

Phone: 1-800-3-SAMSON (1-800-372-6766)

Fax: 631-784-2201

www.samsontech.com

Free Manuals Download Website

<http://myh66.com>

<http://usermanuals.us>

<http://www.somanuals.com>

<http://www.4manuals.cc>

<http://www.manual-lib.com>

<http://www.404manual.com>

<http://www.luxmanual.com>

<http://aubethermostatmanual.com>

Golf course search by state

<http://golfingnear.com>

Email search by domain

<http://emailbydomain.com>

Auto manuals search

<http://auto.somanuals.com>

TV manuals search

<http://tv.somanuals.com>