

24-bit DSP
DIGITAL EFFECTS

MDR 10

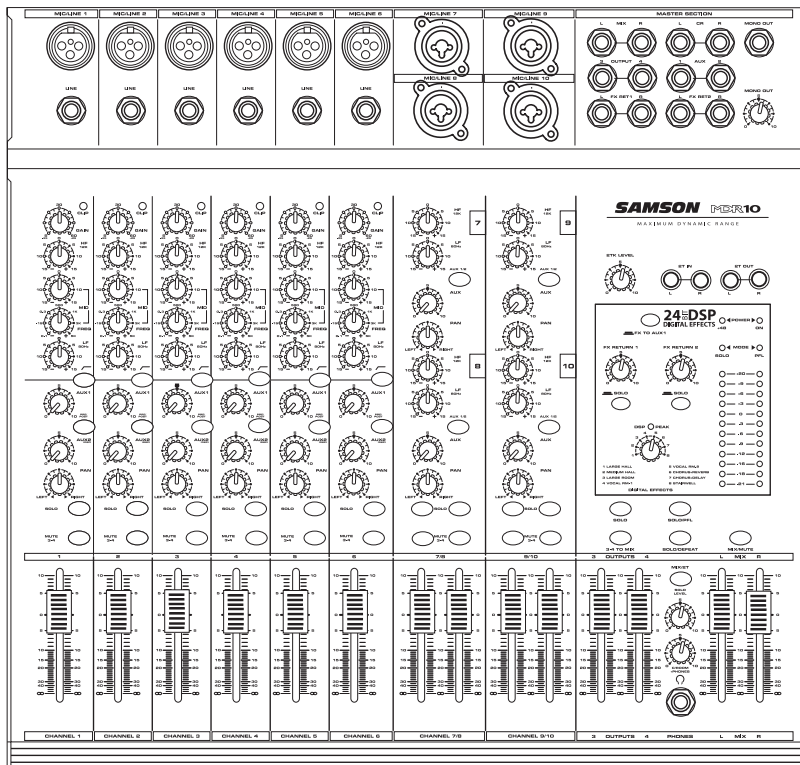

**TEN CHANNEL MIXER
WITH 24BIT DIGITAL EFFECTS**

Owners Manual

SAMSON
A U D I O

MDR Series Mixers

Safety Instructions/Consignes de sécurité/Sicherheitsvorkehrungen/Instrucciones de seguridad



WARNING: To reduce the risk of fire or electric shock, do not expose this unit to rain or moisture. To reduce the hazard of electrical shock, do not remove cover or back. No user serviceable parts inside. Please refer all servicing to qualified personnel. The lightning flash with an arrowhead symbol within an equilateral triangle, is intended to alert the user to the presence of uninsulated "dangerous voltage" within the products enclosure that may be of sufficient magnitude to constitute a risk of electric shock to persons. The exclamation point within an equilateral triangle is intended to alert the user to the presence of important operating and maintenance (servicing) instructions in the literature accompanying the product.

Important Safety Instructions

1. Please read all instructions before operating the unit.
2. Keep these instructions for future reference.
3. Please heed all safety warnings.
4. Follow manufacturers instructions.
5. Do not use this unit near water or moisture.
6. Clean only with a damp cloth.
7. Do not block any of the ventilation openings. Install in accordance with the manufacturers instructions.
8. Do not install near any heat sources such as radiators, heat registers, stoves, or other apparatus (including amplifiers) that produce heat.
9. Do not defeat the safety purpose of the polarized or grounding-type plug. A polarized plug has two blades with one wider than the other. A grounding type plug has two blades and a third grounding prong. The wide blade or third prong is provided for your safety. When the provided plug does not fit your outlet, consult an electrician for replacement of the obsolete outlet.
10. Protect the power cord from being walked on and pinched particularly at plugs, convenience receptacles and at the point at which they exit from the unit.
11. Unplug this unit during lightning storms or when unused for long periods of time.
12. Refer all servicing to qualified personnel. Servicing is required when the unit has been damaged in any way, such as power supply cord or plug damage, or if liquid has been spilled or objects have fallen into the unit, the unit has been exposed to rain or moisture, does not operate normally, or has been dropped.

ACHTUNG: Um die Gefahr eines Brandes oder Stromschlags zu verringern, sollten Sie dieses Gerät weder Regen noch Feuchtigkeit aussetzen. Um die Gefahr eines Stromschlags zu verringern, sollten Sie weder Deckel noch Rückwand des Geräts entfernen. Im Innern befinden sich keine Teile, die vom Anwender gewartet werden können. Überlassen Sie die Wartung qualifiziertem

Fachpersonal. Der Blitz mit Pfeilspitze im gleichseitigen Dreieck soll den Anwender vor nichtisolierter "gefährlicher Spannung" im Geräteinnern warnen. Diese Spannung kann so hoch sein, dass die Gefahr eines Stromschlags besteht. Das Ausrufezeichen im gleichseitigen Dreieck soll den Anwender auf wichtige Bedienungs- und Wartungsanleitungen aufmerksam machen, die im mitgelieferten Informationsmaterial näher beschrieben werden.

Wichtige Sicherheitsvorkehrungen

1. Lesen Sie alle Anleitungen, bevor Sie das Gerät in Betrieb nehmen.
2. Bewahren Sie diese Anleitungen für den späteren Gebrauch gut auf.
3. Bitte treffen Sie alle beschriebenen Sicherheitsvorkehrungen.
4. Befolgen Sie die Anleitungen des Herstellers.
5. Benutzen Sie das Gerät nicht in der Nähe von Wasser oder Feuchtigkeit.
6. Verwenden Sie zur Reinigung des Geräts nur ein feuchtes Tuch.
7. Blockieren Sie keine Belüftungsöffnungen. Nehmen Sie den Einbau des Geräts nur entsprechend den Anweisungen des Herstellers vor.
8. Bauen Sie das Gerät nicht in der Nähe von Wärmequellen wie Heizkörpern, Wärmeclappen, Öfen oder anderen Geräten (inklusive Verstärkern) ein, die Hitze erzeugen.
9. Setzen Sie die Sicherheitsfunktion des polarisierten oder geerdeten Steckers nicht außer Kraft. Ein polarisierter Stecker hat zwei flache, unterschiedlich breite Pole. Ein geerdeter Stecker hat zwei flache Pole und einen dritten Erdungsstift. Der breitere Pol oder der dritte Stift dient Ihrer Sicherheit. Wenn der vorhandene Stecker nicht in Ihre Steckdose passt, lassen Sie die veraltete Steckdose von einem Elektriker ersetzen.
10. Schützen Sie das Netzkabel dahingehend, dass niemand darüber laufen und es nicht geknickt werden kann. Achten Sie hierbei besonders auf Netzstecker, Mehrfachsteckdosen und den Kabelanschluss am Gerät.
11. Ziehen Sie den Netzstecker des Geräts bei Gewittern oder längeren Betriebspausen aus der Steckdose.
12. Überlassen Sie die Wartung qualifiziertem Fachpersonal. Eine Wartung ist notwendig, wenn das Gerät auf irgendeine Weise, beispielsweise am Kabel oder Netzstecker beschädigt wurde, oder wenn Flüssigkeiten oder Objekte in das Gerät gelangt sind, es Regen oder Feuchtigkeit ausgesetzt war, nicht mehr wie gewohnt betrieben werden kann oder fallen gelassen wurde.

ATTENTION: Pour éviter tout risque d'électrocution ou d'incendie, ne pas exposer cet appareil à la pluie ou à l'humidité. Pour éviter tout risque d'électrocution, ne pas ôter le couvercle ou le dos du boîtier. Cet appareil ne contient aucune pièce remplaçable par l'utilisateur. Confiez toutes les réparations à un personnel qualifié. Le signe avec un éclair dans un triangle prévient l'utilisateur de la présence d'une tension dangereuse et non isolée dans l'appareil. Cette tension constitue un risque d'électrocution. Le signe avec un point d'exclamation dans un triangle prévient l'utilisateur d'instructions importantes relatives à l'utilisation et à la maintenance du produit.

Consignes de sécurité importantes

1. Veuillez lire toutes les instructions avant d'utiliser l'appareil.
2. Conserver ces instructions pour toute lecture ultérieure.
3. Lisez avec attention toutes les consignes de sécurité.
4. Suivez les instructions du fabricant.
5. Ne pas utiliser cet appareil près d'une source liquide ou dans un lieu humide.
6. Nettoyez l'appareil uniquement avec un tissu humide.
7. Veillez à ne pas obstruer les fentes prévues pour la ventilation de l'appareil. Installez l'appareil selon les instructions du fabricant.
8. Ne pas installer près d'une source de chaleur (radiateurs, etc.) ou de tout équipement susceptible de générer de la chaleur (amplificateurs de puissance par exemple).
9. Ne pas retirer la terre du cordon secteur ou de la prise murale. Les fiches canadiennes avec polarisation (avec une lame plus large) ne doivent pas être modifiées. Si votre prise murale ne correspond pas au modèle fourni, consultez votre électricien.
10. Protégez le cordon secteur contre tous les dommages possibles (pincement, tension, torsion, etc.). Veillez à ce que le cordon secteur soit libre, en particulier à sa sortie du boîtier.
11. Déconnectez l'appareil du secteur en présence d'orage ou lors de périodes d'inutilisation prolongées.
12. Consultez un service de réparation qualifié pour tout dysfonctionnement (dommage sur le cordon secteur, baisse de performances, exposition à la pluie, projection liquide dans l'appareil, introduction d'un objet dans le boîtier, etc.).

PRECAUCION: Para reducir el riesgo de incendios o descargas, no permita que este aparato quede expuesto a la lluvia o la humedad. Para reducir el riesgo de descarga eléctrica, nunca quite la tapa ni el chasis. Dentro del aparato no hay piezas susceptibles de ser reparadas por el usuario. Dirija cualquier reparación al servicio técnico oficial. El símbolo del relámpago dentro del triángulo equilátero pretende advertir al usuario de la presencia de "voltajes peligrosos" no aislados dentro de la carcasa del producto, que pueden ser de la magnitud suficiente como para constituir un riesgo de descarga eléctrica a las personas. El símbolo de exclamación dentro del triángulo equilátero quiere advertirle de la existencia de importantes instrucciones de manejo y mantenimiento (reparaciones) en los documentos que se adjuntan con este aparato.

Instrucciones importantes de seguridad

1. Lea todo este manual de instrucciones antes de comenzar a usar la unidad.
2. Conserve estas instrucciones para cualquier consulta en el futuro.
3. Cumpla con todo lo indicado en las precauciones de seguridad.
4. Observe y siga todas las instrucciones del fabricante.
5. Nunca utilice este aparato cerca del agua o en lugares húmedos.
6. Limpie este aparato solo con un trapo suave y ligeramente humedecido.
7. No bloquee ninguna de las aberturas de ventilación. Instale este aparato de acuerdo a las instrucciones del fabricante.
8. No instale este aparato cerca de fuentes de calor como radiadores, calentadores, hornos u otros aparatos (incluyendo amplificadores) que produzcan calor.
9. No anule el sistema de seguridad del enchufe de tipo polarizado o con toma de tierra. Un enchufe polarizado tiene dos bornes, uno más ancho que el otro. Uno con toma de tierra tiene dos bornes normales y un tercero para la conexión a tierra. El borne ancho o el tercero se incluyen como medida de seguridad. Cuando el enchufe no encaje en su salida de corriente, llame a un electricista para que le cambie su salida anticuada.
10. Evite que el cable de corriente quede en una posición en la que pueda ser pisado o aplastado, especialmente en los enchufes, receptáculos y en el punto en el que salen de la unidad.
11. Desconecte de la corriente este aparato durante las tormentas eléctricas o cuando no lo vaya a usar durante un periodo de tiempo largo.
12. Dirija cualquier posible reparación solo al servicio técnico oficial. Deberá hacer que su aparato sea reparado cuando esté dañado de alguna forma, como si el cable de corriente o el enchufe están dañados, o si se han derramado líquidos o se ha introducido algún objeto dentro de la unidad, si esta ha quedado expuesta a la lluvia o la humedad, si no funciona normalmente o si ha caído al suelo.

Table of Contents

Introduction	2
MDR10 Features	3
Front Panel Layout	4-5
Rear Panel Layout	6
Controls and Functions	
Mono Input Channel Section	7-11
Master Section	11-13
MDR10 Input and Output Connections	14-15
Operating the MDR10	16-18
System Set-ups	19-20
MDR10 Wiring Guide	21
Specifications	22
Block Diagram	23
Notes	24

THIS DEVICE COMPLIES WITH PART 15 OF THE FCC RULES CLASS B. OPERATION IS SUBJECT TO THE FOLLOWING TWO CONDITIONS: (1) THIS DEVICE MUST NOT CAUSE HARMFUL INTERFERENCE, AND (2) THIS DEVICE MUST ACCEPT ANY INTERFERENCE RECEIVED INCLUDING INTERFERENCE THAT MAY CAUSE UNDESIRED OPERATION. SUITABLE FOR HOME OR OFFICE USE.

Copyright 2004, Samson Technologies Corp.

Printed April, 2004

Samson Technologies Corp.
575 Underhill Blvd.
P.O. Box 9031
Syosset, NY 11791-9031
Phone: 1-800-3-SAMSON (1-800-372-6766)
Fax: 516-364-3888
www.samsontech.com

Introduction

Congratulations on your purchase of the Samson MDR10 mixer! The MDR10 is a ten-channel mixer, with ten low noise microphone pre-amps, four output buses and built-in 24 BIT DSP effects processor. The MDR10 features six mono Mic/Line input channel strips with a three-band, mid-sweep equalizer plus a low cut filter for setting just the right tone on your microphones or instruments. These channels also offer two auxiliary sends that can be used for creating a monitor mix and for routing your signals to effects processors. The mono channels also feature a pan control for creating a stereo image, bus output assign switches and a 60mm fader for setting the level. In addition to the mono inputs, there are four channels set up as Stereo/Dual mono inputs with two-band equalizer, switchable aux send, balance, a utility mic input and 60 mm faders for controlling the level. Clean, clear sound reproduction with dazzling digital effects including Delay, Chorus and lush Reverb, packaged in a rugged enclosure, will ensure reliable high quality sound from performance to performance. Optimized for recording, live sound reinforcement and commercial installations; the MDR10 is an ideal mixer solution offering big sound in a compact package.

In these pages, you'll find a detailed description of the features of the MDR10 mixer, as well a description of its front and rear panels, step-by-step instructions for its setup and use, and full specifications. You'll also find a warranty card enclosed—please don't forget to fill it out and mail it in so that you can receive online technical support and so we can send you updated information about these and other Samson products in the future.

With proper care and adequate air circulation, your MDR10 will operate trouble free for many years. We recommend you record your serial number in the space provided below for future reference.

Serial number:

Date of purchase:

Should your unit ever require servicing, a Return Authorization number (RA) must be obtained before shipping your unit to Samson. Without this number, the unit will not be accepted. Please call Samson at 1-800-3SAMSON (1-800-372-6766) for a Return Authorization number prior to shipping your unit. Please retain the original packing materials and if possible, return the unit in the original carton and packing materials.

MDR10 Features

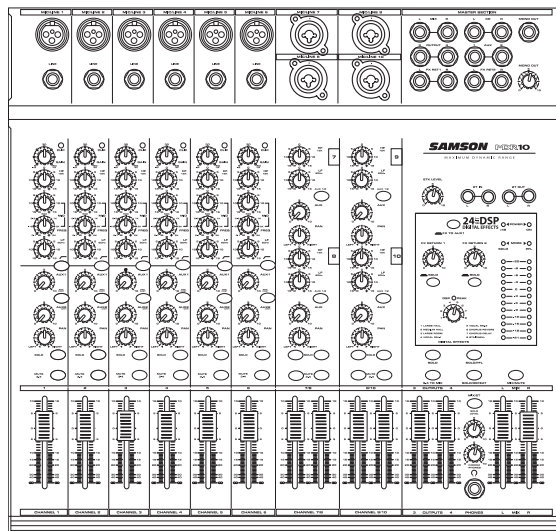

The Samson MDR10, ten channel mixer with onboard 24 BIT DSP is a comprehensive, all-in-one solution for live sound, recording, fixed installation and post production applications. Here are some of its main features:

- Ten channels – Six Mic/Line plus two Stereo/Dual inputs with mic pre's for a total of 10 microphone inputs.
- Flexible design topology ideal for live sound, recording and post production.
- On-board 24 BIT DSP (Digital Signal Processor) multi-effects processor with eight great sounding presets including REVERB, DELAY AND CHORUS.
- Flexible signal routing via the main L and R Mix, 3 / 4 bus outputs, as well as the Mono output.
- 60 mm audio taper faders on all channels and the master 3 / 4 and Mix outputs.
- 2 TK LEVEL control allows you to mix in a CD, DAT, Cassette, Computer Sound Card or Mini Disk.
- The mono inputs feature a three-band channel equalizer with 15dB of cut or boost at 80Hz, variable mid-range from 100 Hz to 5 KHz with 15dB of cut or boost and 15dB of cut or boost at 12KHz, plus a Low Cut filter at 80Hz providing precise and musical results in sound shaping.
- Two Auxiliary Sends, with Pre-Post switching on Aux 1, can be used to route signals to external effects, or to create a separate mix for on-stage monitors, or studio headphones.
- Twelve-segment LED Meter with VU ballistics displays the main MIX output, plus SOLO, PFL, Phantom and Power LED indicators.
- High quality, low noise, discrete microphone pre-amplifiers with 48-Volt phantom power, provide Maximum Dynamic Range and transparent audio.
- Advanced circuit design using discrete components and high quality, low noise op-amps carefully selected at each stage of the signal path.
- Quality built and rugged construction ensure reliable performance from venue to venue and session to session.
- Three-year extended warranty.

Front Panel Layout

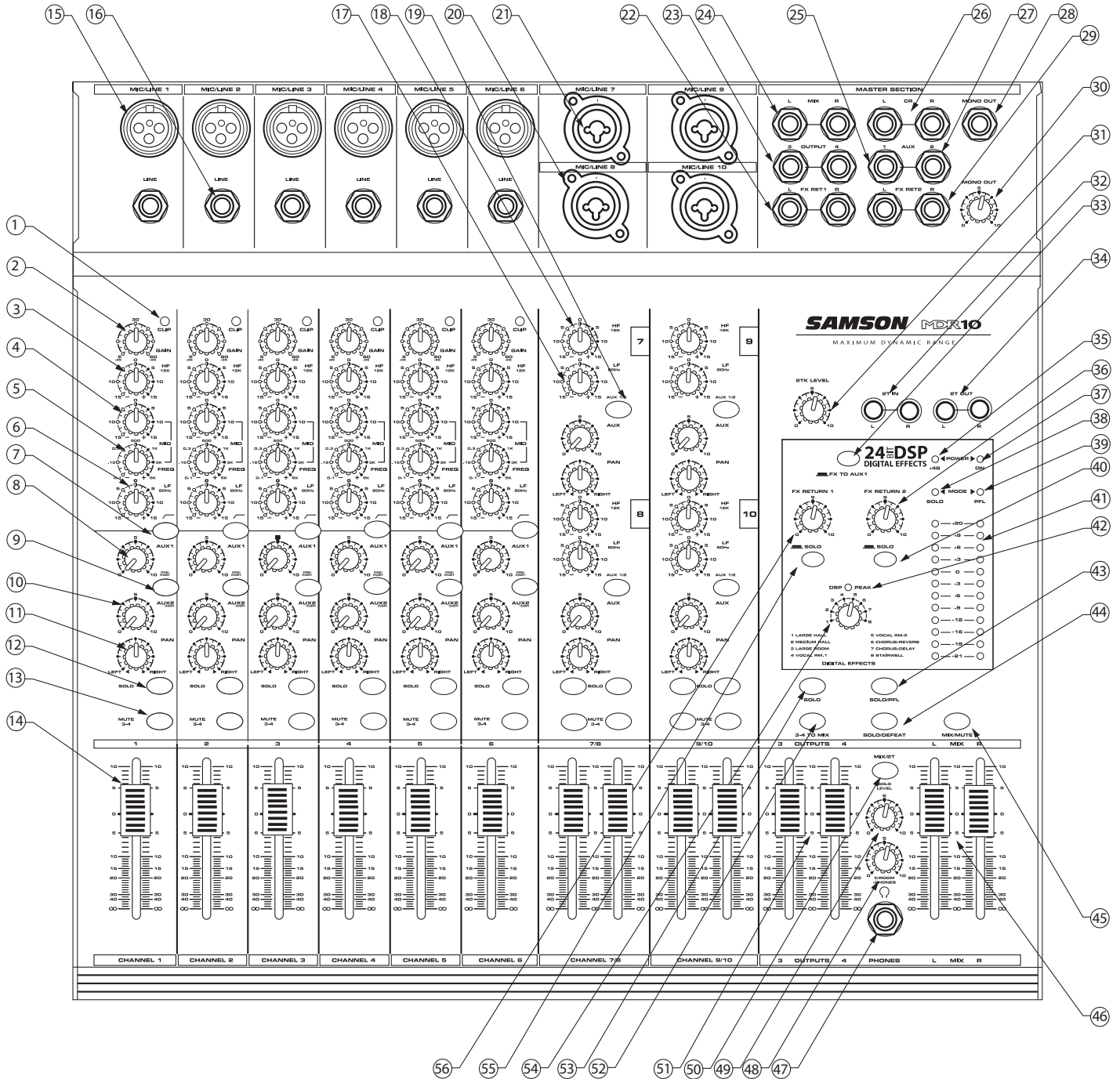

- 1 **CLIP** – Red LED will illuminate, indicating when the GAIN control has been adjusted too high.
- 2 **GAIN** – Used to set the input level of the mic pre and line input.
- 3 **HIGH FREQUENCY** - Controls the high band level of the Channel Equalizer, +/- 15 dB.
- 4 **MID CUT & BOOST** - Controls the level of mid-range, +/- 15 dB at the frequency set by the Mid Frequency control.
- 5 **MID FREQUENCY** - Used to set the center point of the mid band of the Channel Equalizer from 100 Hz to 5KHz.
- 6 **LOW FREQUENCY** - Controls the low band of the Channel Equalizer, +/- 15 dB at 80Hz.
- 7 **LOW CUT** – Bass roll off switch at 80Hz used to eliminate unwanted low end rumble and hum.
- 8 **AUX 1** – Pre fader auxiliary send that can be used with an external effects processor, or to create a cue or monitor mix.
- 9 **AUX 1 PRE/POST Switch** This LED back-lit switch is used to select the point in the audio path that the channel's signal is sent to the AUX 1 bus, either before or after the input fader.
- 10 **AUX 2/DSP** – Post fader auxiliary send connected to the internal 24 BIT DSP effect processor and can also be used with an external effects processor.

Front Panel Layout

- 11 **PAN** – Controls the channel's balance between left and right in the stereo bus.
- 12 **SOLO Switch (Input Channels)** – Back-lit LED switch used to assign the channel to the SOLO bus.
- 13 **MUTE 3/4** – LED, back-lit switch used to Mute the input channel from the Main Left and Right mix bus, and at the same time, assign the channel to the 3/4 output bus.
- 14 **FADER** – 60 mm audio taper fader provides smooth control over level changes.
- 15 **MIC INPUT** – XLR input connector for the input channel's Low-Noise Microphone pre-amp.
- 16 **LINE INPUT** – 1/4-inch TRS (TIP RING SLEEVE) input connector for the input channel's balanced Line level inputs.
- 17 **LOW FREQUENCY (Stereo Channels)** - Controls the low band of the Channel Equalizer, +/- 15 dB at 80Hz.
- 18 **HIGH FREQUENCY (Stereo Channels)** - Controls the high band of the Channel Equalizer, +/- 15 dB at 12KHz.
- 19 **AUX 1/2 Switch (Stereo Channels)** - The auxiliary send on the Dual/Mono channels can be set to either the AUX 1 or AUX 2 bus by using the back-lit, AUX1/2 switch.
- 20 **MIC LINE** – Combination Input connector for the Line or Low-Noise Microphone Inputs on the stereo channels.
- 21 **FX RET 1 (L/R Jacks)** – Balanced inputs on 1/4-inch TRS connectors for connecting external line level signal like those from external effects processors.
- 22 **3/4 OUTPUT** – Balanced outputs on 1/4-inch TRS connectors that carry the signals from the 3 and 4 mix bus.
- 23 **MIX (L R Jacks)** – Balanced outputs on 1/4-inch TRS connectors that carry the signals from the Left and Right Main mix bus.
- 24 **AUX 1** - 1/4-inch TRS output connector for Auxiliary 1.
- 25 **CONTROL ROOM** – Left and Right output connectors for connecting a monitor system.
- 26 **AUX 2**– Output connector for Auxiliary 2.
- 27 **MONO OUT** – The Left and Right main Mix outputs are summed together to a monaural signal and sent out this connector.
- 28 **FX RETURN 2 (L R Jacks)** – Balanced inputs on 1/4-inch TRS connectors for connecting external line level signals like those from external effects processors.
- 29 **MONO OUT LEVEL** – Used to set the volume of the MONO mix.
- 30 **2 TK LEVEL** - Control used to adjust the volume of the 2-track input.
- 31 **2 TRACK INPUTS** – Connect a DAT, Cassette, Mini Disk or Hard Disk Recording system.
- 32 **FX TO AUX** – When this switch is engaged, the FX RETURN 2 is sent to the AUX 1 output allowing the effects, external or internal, to be heard in the monitor mix.
- 33 **2 TRACK OUTPUTS** – Connect a DAT, Cassette, Mini Disk or Hard Disk Recording system.
- 34 **PHANTOM** – Indicates that the 48 Volt Phantom Power is on.
- 35 **FX RETURN 2 Knob** – Used to mix in level of the external effects connected to the FX RETURN 2 inputs.
- 36 **POWER** – Indicates the MDR10 is powered up.
- 37 **SOLO LED** – Indicates SOLO is selected.
- 38 **PFL LED** – Indicates the SOLO is in PFL (Pre-Fader Level) mode.
- 39 **SOLO Switch (FX RETURN 2)** – Back-lit LED switch used to assign the FX RETURN 2 to the SOLO bus.
- 40 **OUTPUT METER** - Twelve segment display with VU ballistics indicates main Mix level.
- 41 **DSP PEAK LED** - LED light illuminates when the signal sent to the internal DSP is clipped.
- 42 **SOLO/PFL Switch** – Used to change the operating mode of the SOLO bus from SOLO to PFL (Pre Fader Listen).
- 43 **SOLO DEFEAT Switch** – This global control back-lit, switch is used to disconnect all channels from the SOLO bus.
- 44 **MIX MUTE Switch** – When the switch pressed, the red LED lights indicating the Main Left and Right outputs are fully attenuated.
- 45 **MIX FADERS**- Used to control the overall volume of the Left and Right main Mix outputs.
- 46 **HEADPHONE JACK** – Connect stereo headphones here.
- 47 **C ROOM/HEADPHONE** – Adjusts the volume of the control room speakers or headphones.
- 48 **SOLO LEVEL** – A rotary control knob used to set the overall volume of the SOLO bus.
- 49 **MIX/2TK**– Switches between the main Mix and the 2 Track in the Control Room output.
- 50 **OUTPUT 3 & 4 FADERS** – Used to control the overall volume of the 3 and 4 mix outputs.
- 51 **3/4 TO MIX Switch** – When engaged, the LED lights and the input channels which are assigned to 3/4 will be mixed together with the Main Left and Right Outputs.
- 52 **SOLO Switch (3/4 Bus)** – Back-lit LED switch used to assign the 3/4 Bus to the SOLO bus.
- 53 **DSP PRE-SET SELECT Knob** – Used to switch between the 8 pre-sets of the internal DSP effects processor.
- 54 **SOLO Switch (FX RETURN 1)** – Back-lit LED switch used to assign the FX RETURN 1 to the SOLO bus.
- 55 **FX RETURN 1** – Used to mix in level of the external effects connected to the FX RETURN 1 inputs.

Rear Panel Layout

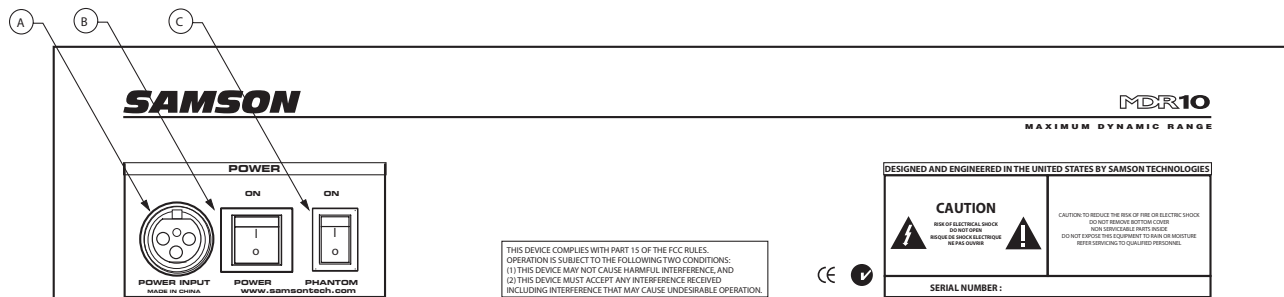

REAR PANEL

- A AC ADAPTER INLET** – Connect External AC power supply here.
- B POWER** – Switches on the MDR10's main power.
- C PHANTOM** – Engages the 48-Volt Phantom power supply to microphone pre-amps.

Controls and Functions

MONO INPUT CHANNEL SECTION

The following section details each part of the MDR10's MONO INPUT CHANNELS including the GAIN control, CLIP LED, 3-BAND EQ, AUX sends, PAN and LEVEL controls. The input channels one through six on the MDR10 feature high quality, discrete transistor pre-amps providing transparency and extended dynamic range. The inputs feature a standard XLR mic connector for microphone level signals, and a standard 1/4" phone connector, either balanced (TRS – TIP/ RING/SLEEVE) or unbalanced (TS – TIP/SLEEVE) for line level signals.

1 GAIN

The MDR10's pre-amp stage has a variable GAIN control with a range of 5 to 60dB on the MIC input and -26 to +26dB on the LINE input.

2 CLIP LED

The MDR10's MIC/LINE pre-amp also includes a CLIP LED which, when illuminated, indicates that the signal is peaking or overloading. To reduce distortion, lower the GAIN control to keep this LED from staying on.

CHANNEL EQUALIZER

The MDR10 input channels feature a 3-band, swept-mid equalizer allowing you to adjust the high, mid, and low frequencies independently on each channel. The frequency centers, range of boost or cut, and equalizer type for each band are as follows:

3 HF (HIGH FREQUENCY)

12KHz +/- 15dB shelving type The channel's frequency response is flat when the knob is in the "12:00" position. Rotating the knob towards the right will boost the corresponding frequency band by 15dB, and rotating it towards the left will cut the frequency by 15dB.

4 MID (CUT & BOOST)

The MID CUT & BOOST knob is used in conjunction with the MID FREQUENCY knob to create the tonal shape in the mid-range frequency when using the mono channel's equalizers. You can adjust the frequency on the mid-range control with the MID SWEEP knob, and use the MID CUT & BOOST to either boost or cut that frequency by plus or minus 15dB.

5 MID FREQUENCY

The MID FREQUENCY is a control enabling you enhanced capabilities in the tonal shaping of the input channel signal. Thanks to the MID FREQUENCY control, you have a variable mid-range equalizer, allowing you to pin point the exact frequency you want to boost or cut. The MID SWEEP has a "fixed Q" of two octaves (the amount, or width, of frequencies around the center point that are effected by the MID CUT & BOOST control) and can be set in a range from 100Hz to 5Khz.

6 LF (LOW FREQUENCY)

80Hz +/- 15dB shelving type The channel's frequency response is flat when the knob is in the "12:00" position. Rotating the knob towards the right will boost the corresponding frequency band by 15dB, and rotating it towards the left will cut the frequency by 15dB.

7 LOW CUT FILTER

Each of the MDR10's channels include a LOW CUT (or high pass) filter which rolls off the low frequencies from 80Hz and below at the rate of 12dB per octave.

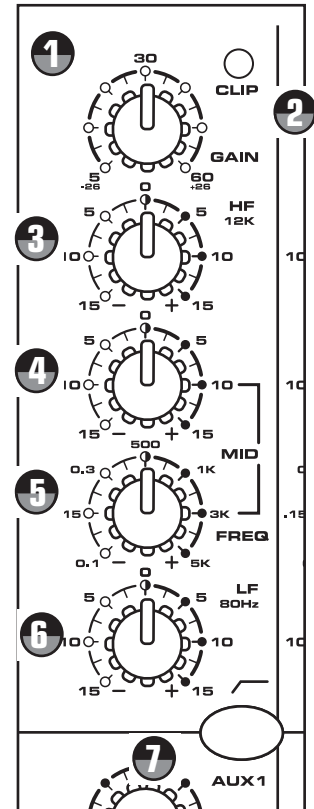

Controls and Functions

(MONO INPUT CHANNEL CONTINUED)

8 AUX 1 SEND

The MDR10 has two auxiliary sends which can be used for sending signals to the external effects devices or for creating a monitor mix. The AUX1 section is often used for a monitor mix in a live sound mixing, or for a headphone mix in a recording application. Each input channel includes an AUX 1 send which controls the amount of that channel's signal that is sent to the AUX 1 bus. The Input channel's AUX 1 sends are mixed together and are sent to the AUX 1 OUT jack.

9 AUX 1 PRE/POST switch

On channels 1 through 6, it is possible to set the Aux 1 control knob to send signal from before (PRE) or after (POST) the channel fader. Following is a description of the signal paths.

PRE FADER AUX send - If you want to use AUX 1 as a send for a monitor, set the PRE/POST switch to the up or PRE position. When AUX 1 is set to "PRE", the channel's signal will be sent directly to the AUX1 output using the channel AUX 1 control knob. In this mode the channel fader has no effect on the signal being sent from the AUX1 knob. So in a stage monitor situation, only the Aux 1 knob, and not the channel fader, control the level sent to the AUX1 output, and therefore, the overall volume of that channel in the monitors.

POST FADER AUX send - If you want to use AUX 1 as a send to an effects processor, set the PRE/POST switch to the down or POST position. In this mode the channel signal will be sent to the AUX1 output using the channel AUX 1 control knob in conjunction with the channel fader. So when using AUX 1 for a mix being sent to an effects processors, the Aux 1 knob, and the channel fader both control the overall level sent to the AUX1 output. If you are sending to a delay or reverb, when you push the channel fader up you are sending more signal to the delay or reverb. Pull the fader down and you are sending less level to the delay or reverb. Keep in mind that when the AUX 1 is in POST, the Aux send follows the fader.

10 AUX 2 / DSP Send

The MDR10 provides high quality, 24 Bit digital effects, and the level of effects can be set independently on each channel. The channel's AUX 2/DSP knob controls the amount of signal that is sent to the AUX 2/DSP bus. The signal of the AUX 2/DSP bus is routed to the internal DSP effects section for onboard signal processing. The AUX 2/DSP signal can also be sent to an external effect device connected to the AUX 2 OUT jack located in the MASTER SECTION jack field.

NOTE: The channel's AUX 2/DSP signal is sent to the AUX 2/DSP bus from a location in the signal path after the channel's LEVEL control. This is commonly referred to as a POST FADER send. This means that the amount of signal that is sent to the EFFECT bus will be affected not only by the setting of the AUX 2/DSP knob control, but it will also be affected by the setting of the LEVEL control.

11 PAN

The MDR10's PAN control is used to place or position the mono signal into the stereo main Left and Right MIX bus. You can create a stereo image by panning some input signals to the left and others to the right. The MDR10's PAN control is a Power-Pan circuit, which includes a 3dB dip in the center position. This is desirable since there's a 3dB increase in gain when the mono input signal is heard in both the Left and Right MIX bus.

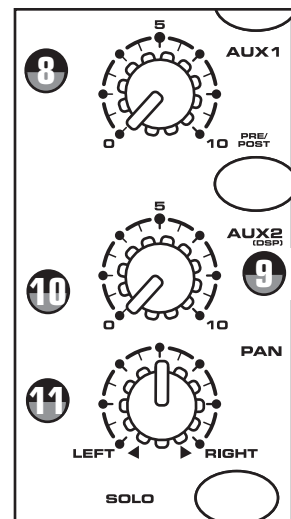

Controls and Functions

(MONO INPUT CHANNEL CONTINUED)

12 SOLO Switch

When engaged, the yellow LED illuminates, indicating the input channel is assigned to the SOLO bus. The SOLO switch has a “momentary” action that activates a logic control switch. Pressing the switch repeatedly will assign the input channel on or off the SOLO bus. You can use the SOLO LEVEL control to adjust the overall volume to the SOLO Bus.

13 MUTE 3/4 OUTPUT Switch

The 3/4 MUTE switches are used to assign the channels to either the main LEFT and RIGHT MIX bus, or the secondary, 3/4 stereo bus. Any channels that have the 3/4 switch pressed in (the LED is on) will be heard in the 3/4 outputs. If you are mixing in stereo and not connecting anything to the 3/4 outputs, you can use the 3/4 switches as mute switches to turn the channel on or off. In recording applications, you can use 3/4 switches with left and right panning to assign a channel to either the 3 or 4 bus outputs for sending to an input of a recorder. You can also mix the 3/4 bus with the LEFT and RIGHT mix bus by using the 3/4 to MIX switch, located in the master section above the 3/4 OUTPUTS faders, allowing you to subgroup channels. In this mode, you can assign channels to the 3/4 bus and use the 3/4 OUTPUT faders to sub-mix those channels. More information on the 3/4 to MIX switch can be found later in this manual.

14 FADER

The MDR10's 60mm input FADER controls the overall channel level. The input FADER features an audio taper and no detents for smooth fades.

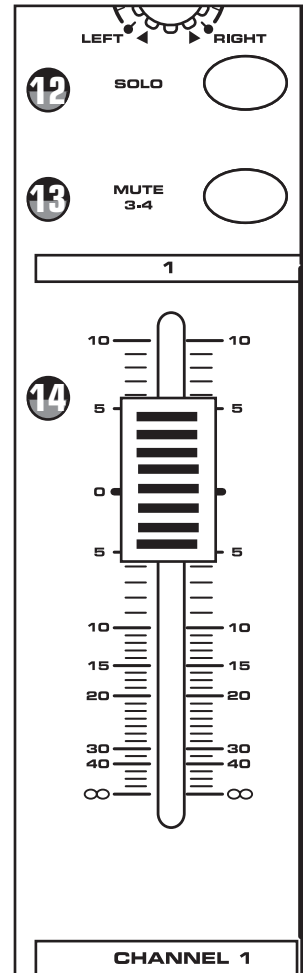

STEREO - DUAL/MONO INPUT CHANNEL SECTION

The MDR10's input channels seven through ten are STEREO or DUAL MONO. These channels can be used for stereo inputs, and since they have separate faders for left and right, they can be used as dual mono inputs. The equalizers and auxiliary are set up vertically as shown in the following diagram.

The following section details each part of the MDR10's STEREO/DUAL MONO INPUT CHANNELS including the 2-BAND EQ, AUX sends, PAN and LEVEL controls. The input channels seven through ten on the MDR10 feature high quality, discrete transistor pre-amp providing transparency and extended dynamic range. These inputs feature a “combie” (combination) connector which can accept a standard XLR mic cable for microphone level signals, or a standard 1/4" phone cable, either balanced (TRS – TIP/RING/SLEEVE) or unbalanced (TS – TIP/SLEEVE) for line level signals.

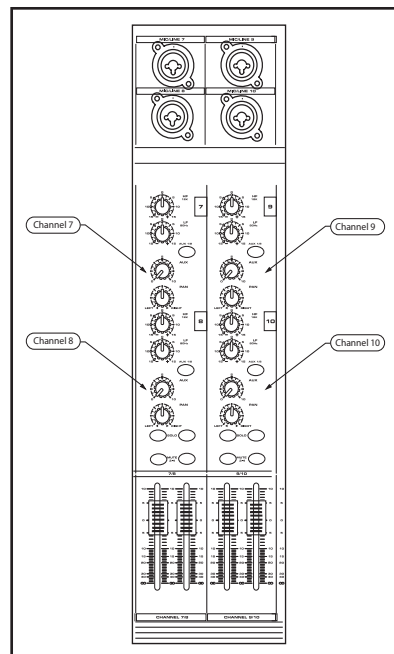

Controls and Functions

(STEREO/DUAL-MONO INPUT CHANNEL CONTINUED)

CHANNEL EQUALIZER

The MDR10 Stereo/Dual-mono input channels feature a 2-band equalizer allowing you to adjust the high and low frequencies independently on each channel. The channel's frequency response is flat when the knobs are in the "12:00" position. Rotating the knob towards the right will boost the corresponding frequency band by 15dB, and rotating it towards the left will cut the frequency by 15dB. The frequency centers, range of boost or cut, and equalizer type for each band are as follows:

15 HF (HIGH FREQUENCY)

12KHz +/- 15dB shelving type. The channel's frequency response is flat when the knobs are in the "12:00" position. Rotating the knob towards the right will boost the corresponding frequency band by 15dB, and rotating it towards the left will cut the frequency by 15dB.

16 LF (LOW FREQUENCY)

80Hz +/- 15dB shelving type. The channel's frequency response is flat when the knobs are in the "12:00" position. Rotating the knob towards the right will boost the corresponding frequency band by 15dB, and rotating it towards the left will cut the frequency by 15dB.

17 AUX 1/2 Switch

When the AUX1/2 switch is in the up position, the LED is off and the AUX send for the dual/mono channel will be assigned to AUX1. If you are using the AUX 1 for a monitor mix in a live sound application, you will be able to add the channel to the monitor mix when the switch is set to AUX1. When the AUX1/2 button is pressed down the green LED will illuminate, indicating that the Aux send will now feed the AUX 2 bus. If you are using the AUX2 bus to drive the internal, 24 BIT digital effects, you will be able to add effects to the channel when it is set to AUX2.

18 AUX Control Knob

The Aux 1/2 control knob controls the amount of signal that is sent to the AUX 1 or 2 bus depending on the position of the AUX1/2 switch as described above.

19 PAN

The MDR10's PAN control is used to place or position the stereo signal into the main Left and Right MIX bus. You can move a stereo signal's image to the left or right by setting the PAN control to the left or to the right.

20 SOLO Switch

When engaged, the yellow LED illuminates indicating the input channel is assigned to the SOLO bus. The SOLO switch has a "momentary" action that activates a logic control switch. Pressing the switch repeatedly will assign the input channel on or off the SOLO bus. You can use the SOLO LEVEL control to adjust the overall volume to the SOLO Bus.

21 MUTE 3/4 OUTPUT Switch

The MUTE 3/4 switches are used to assign the channels to the either the main LEFT and RIGHT MIX bus, or the secondary, 3/4 stereo bus. Any channels that have the 3/4 switch pressed in (the LED is on) will be heard in the 3/4 outputs. If you are only mixing in stereo and not connecting anything to the 3/4 outputs, you can use the 3/4 switches

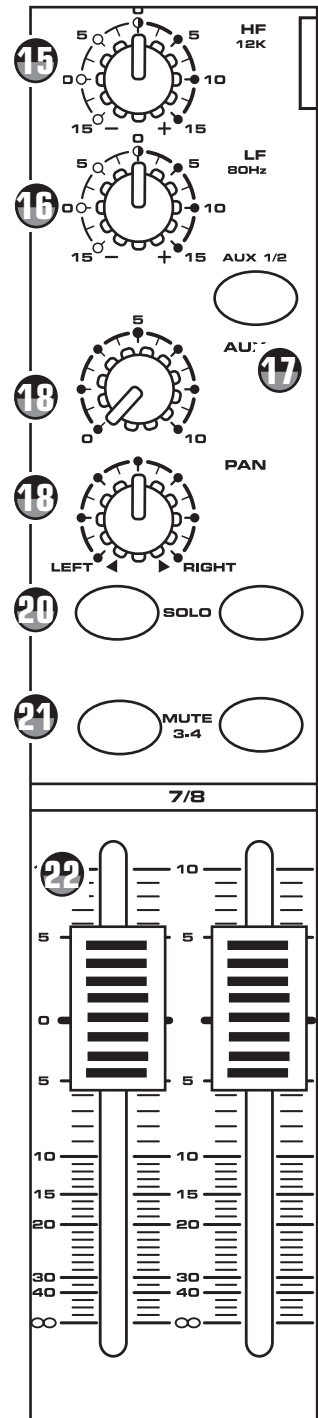

Controls and Functions

(STEREO/DUAL-MONO INPUT CHANNEL CONTINUED)

as mute switches to turn the channel on or off. In recording applications, you can use 3/4 switches with left and right panning to assign a channel to the either the 3 or 4 bus outputs for sending to an input of a recorder. You can also mix the 3/4 bus with the LEFT and RIGHT mix bus by using the 3/4 to MIX switch, located in the master section above the 3/4 OUTPUTS faders, allowing you to subgroup channels. In this mode, you can assign channels to the 3/4 bus and use the 3/4 OUTPUT faders to sub-mix those channels. More information on the 3/4 to MIX switch can be found later in this manual.

22 FADER

The MDR10's 60mm input FADER controls the overall channel level. The input FADER features an audio taper and no detents for smooth fades.

MASTER SECTION

2 TRACK INPUT AND OUTPUT

The MDR10's 2 Track section provides the connections for playback and recording for an external device such as a DAT, cassette recorder, CD or Mini Disk.

23 2T LEVEL

The 2TRK LEVEL control is used to adjust the amount of signal that is sent from the 2TK IN jacks to the Control Room or headphone outputs. For more information see the section, "Playing back a CD Using the 2 Track to MIX" on page 18 of this manual.

24 BIT DIGITAL EFFECT SECTION

The MDR10 features a built-in, 24 Bit Digital Effects processor with high quality, studio grade effects such as Delay, Chorus and Reverb. The following section describes the features of the powerful on-board DSP.

24 SELECT Switch (DIGITAL EFFECTS)

The SELECT switch allows you to select one of the eight built-in digital effects. Simply rotate the SELECT knob to choose the various effect pre-sets.

25 DSP PEAK

The DSP PEAK indicator lets you know when you are sending too much level to the internal effects processors. If the LED illuminates, turn down the signal from the channel's AUX 2 /DSP send. You may need to do this on more than one channel if you have multiple inputs sending to the internal DSP.

26 Effect Preset List

This section identifies the eight built-in DSP effects presets. Following is the effects pre-set list: 1-Large Hall, 2-Medium Hall, 3-Large Room, 4-Vocal Room 1, 5-Vocal Room 2, 6-Chorus + Reverb, 7-Chorus + Delay, 8-Stairwell

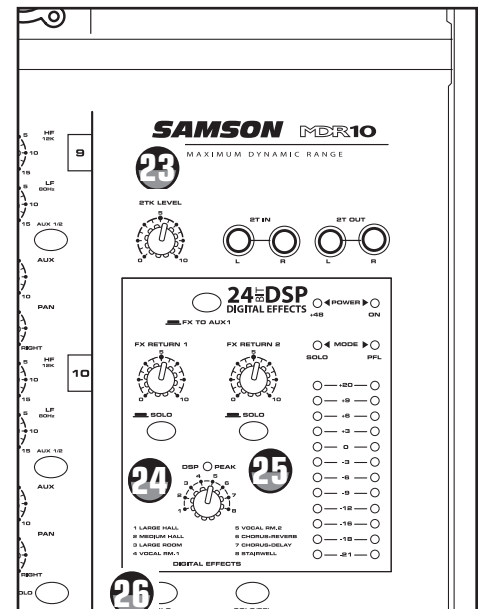

Auxiliary Returns

The MDR10 has two stereo auxiliary returns, which can be accessed via the two pairs of 1/4-inch phone jacks located on the top panel. The auxiliary returns can be used to connect any stereo line level signal, but they are primarily used to connect the output of external effects processors. The MDR10's onboard effects are internally connected to the FX RET2.

Controls and Functions

MASTER SECTION (continued)

AUXILIARY SECTION - continued

27 FX TO AUX 1

The FX TO AUX1 allows you to add the internal effects to the AUX 1/ MON send. When you press this switch, the signal from the DSP return is mixed in to the AUX 1. You can use this to add effects to your monitor mix in a live sound mix or to your headphone mix in the studio.

28 FX RETURN 1

This adjusts the amount of signal that is sent from the FX RET 1 jacks to the MAIN bus.

29 FX RETURN 2

The FX RETURN 2 adjusts the level of the signal present at the FX RET 2 jacks. This signal is summed, or mixed in to the main L/R MIX bus. When using the onboard digital effects, the FX RETURN 2 control is used to control the output level of the internal DSP effects processor which is also summed with the main L/R MIX bus.

30 SOLO Switch (FX RETURN 1)

You can listen to the FX RETURN 1 in the SOLO bus by pressing the SOLO switch located directly under the FX1 RETURN control knob. When engaged, the yellow LED illuminates indicating the FX RETURN is assigned to the SOLO bus. The SOLO switch has a “momentary” action that activates a logic control switch. Pressing the switch repeatedly will assign the input channel on or off the SOLO bus. You can use the SOLO LEVEL control to adjust the overall volume to the SOLO Bus.

31 SOLO Switch (FX RETURN 2)

You can listen to the FX RETURN 2 in the SOLO bus by pressing the SOLO switch located directly under the FX2 RETURN control knobs. When engaged, the yellow LED illuminates indicating the FX RETURN is assigned to the SOLO bus. The SOLO switch has a “momentary” action that activates a logic control switch. Pressing the switch repeatedly will assign the input channel on or off the SOLO bus. You can use the SOLO LEVEL control to adjust the overall volume to the SOLO Bus.

MASTER OUTPUT SECTION

32 SOLO PFL Switch

The SOLO PFL switch is used to change the point at which the signal is sent to the SOLO bus. In the PFL (Pre Fader Listen) position, the signal sent to the solo bus is sourced before the fader or Level control of the channel, output or return.

33 SOLO DEFEAT Switch

You can quickly turn off the SOLO bus and return to the monitoring the mix present at the LEFT and RIGHT outputs by pressing the SOLO DEFEAT switch. You can listen to any of the channels, output or FX return in the SOLO bus by pressing the SOLO DEFEAT switch again.

34 SOLO Switch (3/4 Bus Output)

You can listen to the signal from the channels assigned to 3/4 Bus Output in the SOLO bus by pressing the SOLO Switch located above the 3/4 Bus Output Faders. When engaged, the yellow LED illuminates indicating the channel is assigned to the SOLO bus. The SOLO switch has a “momentary” action, so pressing the switch repeatedly will assign the 3/4 Bus Output on or off the SOLO bus. You can use the SOLO LEVEL control to adjust the overall volume to the SOLO Bus.

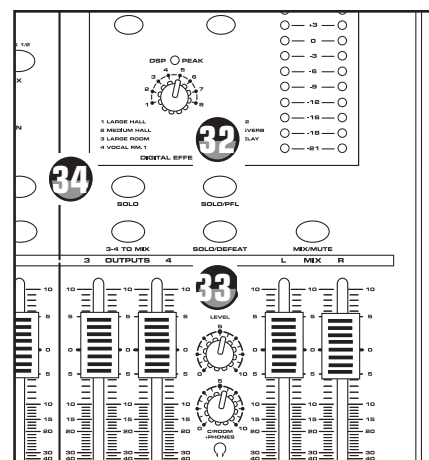
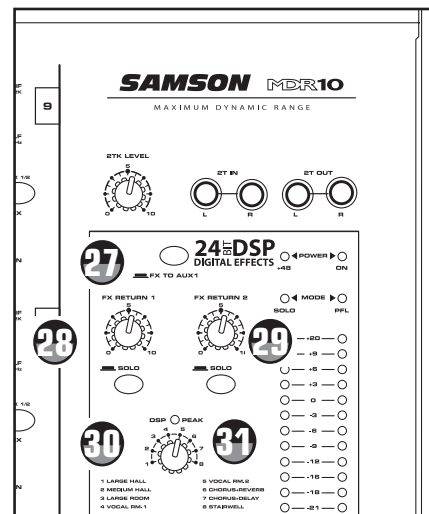

Controls and Functions

MASTER OUTPUT SECTION

35

SOLO LEVEL

You can adjust the overall volume of the SOLO bus by using the SOLO LEVEL control knob. The SOLO LEVEL is active when any SOLO button is engaged.

36

3/4 to MIX Switch

When the 3/4 to MIX switch is engaged the green LED will illuminate letting you know that the mix from the secondary, 3/4 stereo bus will be summed, or mixed together, with the main LEFT and RIGHT mix. So with the 3/4 to MIX engaged, you will hear any channels assigned to the 3/4 bus, along with the channels assigned to the LEFT and RIGHT stereo mix. This will allow you to use the 3/4 bus as a sub-group for mixing. To create a sub-group of vocals assign all the vocal channels to the 3/4 bus by pressing the 3/4 switches on those channels. Now with the 3/4 to MIX switch pressed in, you can use the 3/4 OUTPUT faders to sub-mix.

37

C/ROOM + PHONES

The C/ROOM + PHONES control is used to set the level sent to the control room outputs, and also to the headphone jack.

38

MIX/2T

The MIX/2T switch selects the signal source that you are monitoring in the CONTROL ROOM and HEADPHONE outputs. When the switch is in the up position, the signal source is from the LEFT/ RIGHT MIX bus. When the MIX/2T switch is in the down position, the signal source is from the 2 TRACK input.

39

3/4 FADERS

The 3/4 Bus faders are the over-all volume control for the 3/4 MIX bus. If the 3/4 TO MIX switch is not engaged, the 3/4 MIX faders will affect the signal that is being sent out the 3/4 OUTPUT jacks. If the 3/4 TO MIX switch is engaged, the 3/4 MIX faders will affect the signal that is being sent out the CONTROL ROOM outputs, and signal that is being sent out the MIX OUTPUT jacks.

40

MIX MUTE

When the switch pressed, the red LED will light indicating the Main Left and Right outputs are fully attenuated.

41

L MIX R FADERS

The L&R MIX faders are the over-all volume control for the MIX bus. The L&R MIX faders affects both the signal which is output to the CONTROL ROOM speakers and the line level signal which is output from the MIX OUTPUT jacks.

LED INDICATORS

42

POWER LED

The Power LED lights up to indicate that the main POWER switch, (located on the rear panel), is on and the mixer is powered-up.

43

+48V - Phantom Power LED

The +48V LED illuminates indicating that the 48 volt phantom power is applied to the microphone pre-amps enabling use with condenser microphones. The +48V LED will light up when the Phantom Power switch (located on the rear panel) is switched to the ON position.

44

SOLO LED

The SOLO LED lights up to indicate that the SOLO bus is now being heard in the Headphones and Control Room outputs.

45

PFL LED

The PFL LED lights up to indicate that the SOLO is in PFL mode.

46

Output Level Meter

The OUTPUT LEVEL METER allows you to monitor the level of the signal which is being sent to the L&R MIX OUTPUT jacks.

NOTE: To avoid distortion, adjust the L/R MIX faders LEVEL control so that the 0 indicator LED lights occasionally.

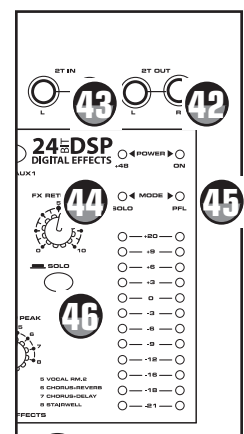
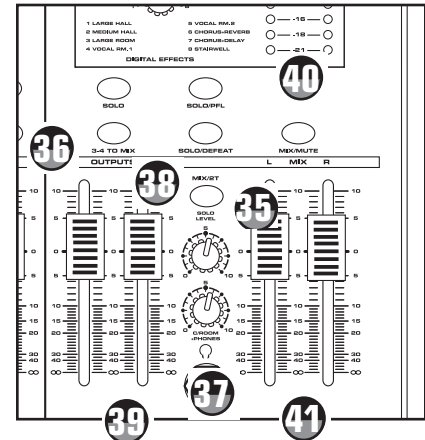

MDR10 Input and Output Connections

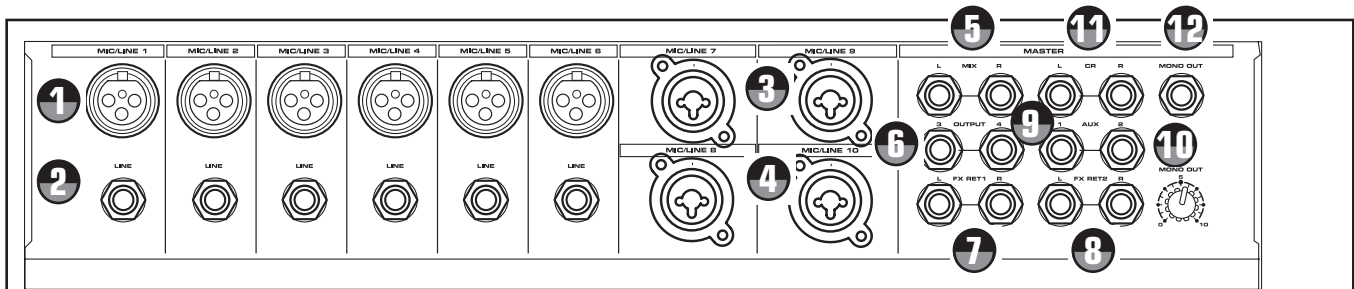

CHANNEL 1-8 MIC and LINE INPUTS

The MDR10's input channels 1 - 6 each have an XLR MIC level, Low-Z (Low Impedance) input and a 1/4-inch LINE level, Hi-Z (High Impedance) input. By using the GAIN control on channels 1- 6, you can connect a variety of signal sources from microphones and direct boxes to line level devices such as synthesizers and drum machines. All the LINE and MIC inputs are balanced. The MIC inputs are compatible with microphones with output impedances of 50~600 Ohms and the LINE inputs are compatible with line level devices of 600 Ohms.

NOTE: It is not possible to simultaneously use both the LINE and MIC inputs on the same channel (with the exception on the stereo input channels). Use only one of the inputs for the appropriate source for each channel.

Following below is a detailed description of the MDR10's input and output connectors.

1 Microphone Input - Mono Input Channels

Use these inputs to connect Low Impedance microphones and low level signals from direct boxes. The MIC inputs have a nominal operating level of -62dB through -8dB. The MIC inputs also feature +48V phantom power, allowing you to use condenser microphones. The Phantom Power switch (located on the MDR10's rear panel) enables phantom power on all the microphone inputs when set to the ON position. XLR Connector pin-out - Pin 1: Ground, Pin 2: Hot (+), Pin 3: Cold (-)

2 Line Level Input - Mono Input Channels

Use these inputs to connect line level signals from synthesizers, drum machines, effects processors or any line-level signal. The LINE inputs have a nominal operating level of -40dB through -10dB. TRS phone jacks. Connector pin-out - Sleeve: Ground, Tip: Hot (+), Ring: Cold (-)

Stereo/ Dual Mono Input Channels

The MDR10's channels 7 – 10 can be used for either two stereo inputs or four mono inputs. These channels feature a combination XLR and 1/4 inch connector, often referred to as a "combie" connector, to handle both the LINE and MIC inputs. The LINE input is located in the center of the combie connector. You can connect the outputs from devices such as synthesizers, drum machines, effects processors or any line-level signal. The LINE inputs have a nominal operating level of -27dB through +27dB. The TRS phone jacks Connector pin-out is; Sleeve: Ground, Tip: Hot (+), Ring: Cold (-). The MDR10's stereo/dual mono channels have a utility MIC input located on the combie connector. The utility MIC inputs have a nominal operating level of -40dB. The MIC inputs also feature +48V phantom power, allowing you to use condenser microphones. The Phantom Power switch (located on the MDR10's rear panel) enables phantom power on all the microphone inputs when set to the ON position. The XLR Connector pin-out is; Pin 1: Ground, Pin 2: Hot (+), Pin 3: Cold (-).

3 Left Line/Mic Input

If you want to use channels 7 and 8 as a stereo input you would connect the left side here. When using the inputs for stereo signals, be sure to set the pan knob all the way to the left to maintain the stereo balance. Of course, you can connect any mono signals here as well. Channels 9 and 10 are configured the same as 7 and 8.

4 Right Line/Mic Input

If you want to use channels 7 and 8 as a stereo input you would connect the right side here. When using the inputs for stereo signals, be sure to set the pan knob all the way to the right to maintain the stereo balance. Of course, you can connect any mono signals here as well. Channels 9 and 10 are configured the same as 7 and 8.

MDR10 Input and Output Connections

EXTERNAL OUTPUT JACKS

The MDR10 features several output connectors allowing you to interface a variety of external devices. A stereo recording device such as a cassette recorder can be connected to the 2 Track jacks, and power amplifiers can be connected to the CONTROL ROOM and MAIN output jacks.

5 LEFT/RIGHT MIX

In a live sound application the LEFT/ RIGHT MIX outputs are connected to a power amplifier or powered speakers. In a recording application, the LEFT/ RIGHT MIX outputs are used to connect a stereo device such as computer sound card, DAT, or cassette recorder.

6 3/4 OUTPUT

In a live sound application, the 3/4 bus outputs are connected to a power amplifier or powered speakers. In a recording application, the 3/4 outputs are used to connect a stereo device such as computer sound card, DAT, or cassette recorder.

7 FX RET 1 LEFT/RIGHT

The FX RET 1 LEFT/RIGHT are stereo inputs that are generally used to connect the outputs of an effects processor, but can also accept the signal from any line level source like a keyboard, recorder and even another mixer. The signal connected to the FX RET 1 LEFT/RIGHT will feed the main LEFT/RIGHT MIX bus. The overall level is controlled by the FX RETURN 1 knob located in the master section on the front panel

8 FX RET 2 LEFT/RIGHT

The FX RET 2 LEFT/RIGHT are stereo inputs that are generally used to connect the outputs of an effects processor, but can also accept the signal from any line level source like a keyboard, recorder and even another mixer. The signal connected to the FX RET 2 LEFT/RIGHT will feed the main LEFT/RIGHT MIX bus. The overall level is controlled by the FX RETURN 2 knob located in the master section on the front panel

9 AUX 1 Output

The signal present at the AUX 1 output is sent from the AUX 1 bus, which is fed from the AUX 1 send on the input channels. The AUX 1 output can be used as the MONITOR MIX bus in a live sound situation by connecting the output to a power amp and monitor speaker.

10 AUX 2 OUTPUT

The AUX 2 output is used to send a signal to an external signal processor such as a delay or reverb. The signal present at the AUX 2 output is sent from the AUX2/DSP bus, which is fed from the AUX2/DSP send on the input channels.

11 CONTROL ROOM LEFT/RIGHT

The Control Room outputs are used to connect a studio monitor system. The Control Room outputs have the same output as the L/R MIX, however, the level can be adjusted independently from the main mix using the C ROOM/HEADPHONES control.

12 MONO OUTPUT

The Left and Right Mix outputs are summed together and sent to the MONO output. The level of the Mono signal can be adjusted using the MONO OUT level control located just below the connector and used to feed a speaker zone in a fixed installation.

13 AC INLET

Connected the supplied Samson AC adapter here. Before connecting the supply, make sure that the MDR10 POWER and PHANTOM POWER switches are in the off position.

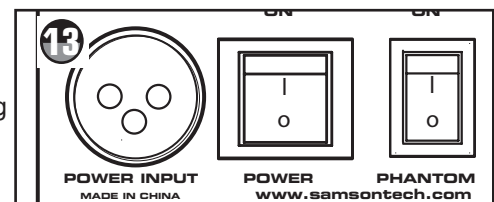

Operating the MDR10

BASIC OPERATION

The following section explains the basic operation of the MDR10.

CONNECTING MICROPHONES AND INSTRUMENTS

1. Before connecting mics or instruments, make sure that the power of all your systems components including the MDR10 is turned off. Also, make sure that the Left and Right MIX faders are turned all the way down.
2. Connect the cables to your microphones and instruments, and insert the other end of the cable firmly into the appropriate input on the MDR10.

NOTE: SETTING THE INPUT GAIN - When connecting a microphone to channels 1 through 6, it's a good idea to start with the Gain Control turned all the way down. Set the input fader to the "0" position and slowly raise the GAIN control until you see the CLIP LED turn on. Now, back the GAIN control down so that the CLIP LED only lights for a short time during the loudest input the channel will see.

3. Switch on the power of any peripheral devices, and then power up the MDR10.

NOTE: It is important to remember the Golden Rule of audio ... "**LAST ON, FIRST OFF**".

Translated, this means that when turning on your system, you should always turn your power amplifiers or powered monitors on LAST, and when turning your system off, turn your power amps off FIRST. This helps avoid any loud pops caused by rush current at power up, which can sometimes damage loudspeakers.

4. Turn on your power amp or powered monitors and raise the level control to the manufacturers' recommended operating level.
5. Set the Left and Right MIX faders in the MDR10's master section to the "0" position.
6. While speaking into the mic (or playing the instrument), adjust the channel Fader control so that the "0" LED of the MAIN section peak level meter lights occasionally.
7. You can shape the tone of each channel by adjusting the equalizer controls as desired.

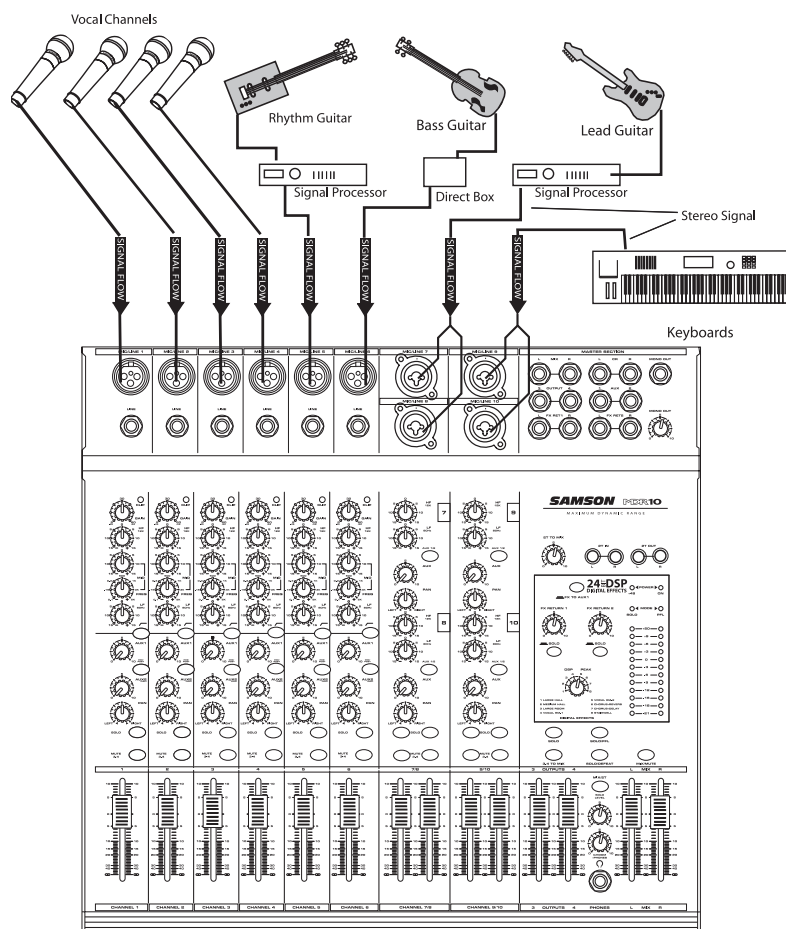

Operating the MDR10

USING THE DIGITAL EFFECTS

The MDR10 features a built-in, high quality, 24 BIT Digital Signal Processor offering studio grade effects. The DSP features clean Delay, lush Reverbs and multi-effects such as Chorus + Delay or Chorus + Reverb. The following details the operation of the internal DSP effects:

1. Connect a mic or instrument to the desired channel, and adjust the volume and equalizer to your liking.
2. Now select the desired preset on the DSP selection switch. Set the DSP selection switch to one of the following effects:

- 1 - Large Hall
- 2 - Medium Hall
- 3 - Large Room
- 4 - Vocal Room 1
- 5 - Vocal Room 2
- 6 - Chorus + Reverb
- 7 - Chorus + Delay
- 8 - Stairwell

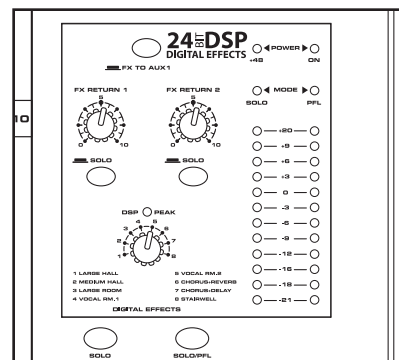

4. Once you have selected the desired effect preset, raise the AUX 2/DSP control on the channels you wish to apply the digital effect to.
5. Now use the FX RETURN 2 knob in the master section to adjust the effects return level. The FX control is the overall level control for the DSP effects processor.

NOTE: If the effect sound is distorted even though the FX RETURN 2 is turned down low, lower the AUX2/DSP controls of each channel.

SENDING AN INDEPENDENT MIX TO THE MONITOR SPEAKERS

The MDR10's AUX1 auxiliary send can be used to feed a separate set of amplifiers and loudspeakers for stage monitors. This lets you build one stereo mix for the amplifiers and speakers facing the audience and another mono mix for the amplifiers and monitor speakers facing the musicians.

1. Raise the AUX1 controls for the channels that you wish to hear from the monitor speakers.

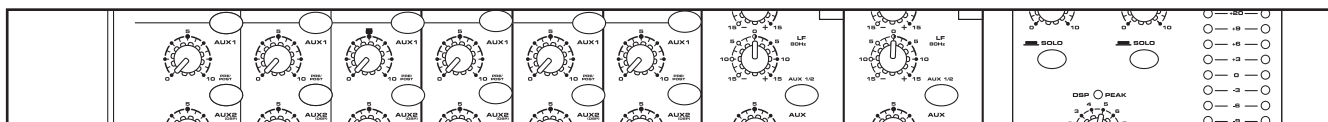

NOTE: With the Pre/Post switch in the up position, the AUX1/MON controls are "PRE-FADER SENDS", which means they are not affected by the FADER level settings of each channel. This allows you to create a mix for the monitors that is independent of the main LEFT and RIGHT MIX.

2. In order to get the most gain from your monitor mix, use an external graphic equalizer (like a Samson S curve 131) to cut out any frequencies that cause feedback.

Operating the MDR10

USING AN EXTERNAL EFFECT

If you prefer to use an external device for effects processing, you can easily connect the unit using the MDR10 EFX bus disconnecting the internal DSP. Follow the simple steps below to interface your processor:

1. Connect the AUX 2 OUTPUT to the input of the external effect processor.
2. Connect the outputs of the effect processor to the FX RETURN 2 located on the MDR10's top panel.
3. Set the L/R mix faders to the "0" position.
4. Raise the AUX 2/DSP knobs for the channels to which you want the external effect to be applied.
5. Set the input level of the external effect so that the sound is not distorted and so that the effect's input meter does not indicate a clipped signal.
6. Use the FX RETURN 2 control to adjust the level of the effects processed by the external effects device.

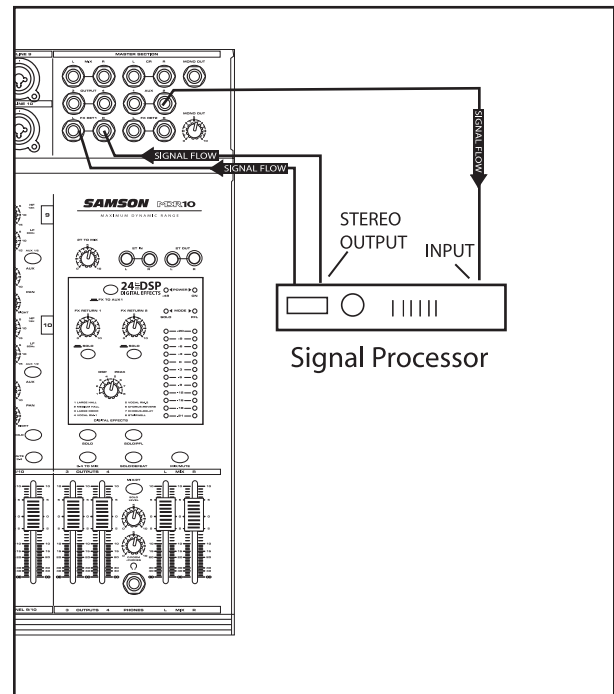

PLAYING BACK A CD USING 2TK LEVEL

The MDR10 has a dedicated input for playing back a stereo device such as a CD, Tape or Mini Disk. Below is a description of how you can play back a CD, Tape or MD using the MDR10's 2 TRACK INPUT.

1. Turn the 2TK LEVEL control and the LEFT / RIGHT MIX level control all the way down.
2. Press the MIX/2TK LEVEL button down.
3. Adjust the LEFT / RIGHT MIX faders in the master section to the "0" position.
4. Start playback on the CD, Tape or MD player, and use the 2TK LEVEL control to set the desired level.

RECORDING A MIX FROM THE MDR10

You can record the audio from the MDR10's mixer section including the MIC, LINE, TAPE IN and AUX inputs to a Cassette deck, MD, DAT or any other type of recorder using the RECORD outputs. Simply connect the MDR10's 2 TRACK OUT to the input jacks of the recorder as shown in the diagram on the right and follow the steps below.

1. Adjust the LEFT / RIGHT MIX faders in the master section to the "0" position.
2. Set a clean signal using the recorder's input level controls and meters.
3. Press RECORD.
4. Play back using as described in the previous section "PLAYING BACK A CD USING 2T TO MIX".

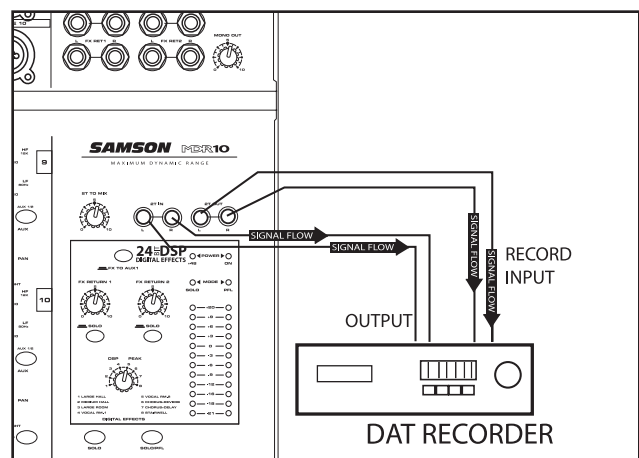

MDR10 System Set-Ups

MDR10 LIVE SOUND SET-UP

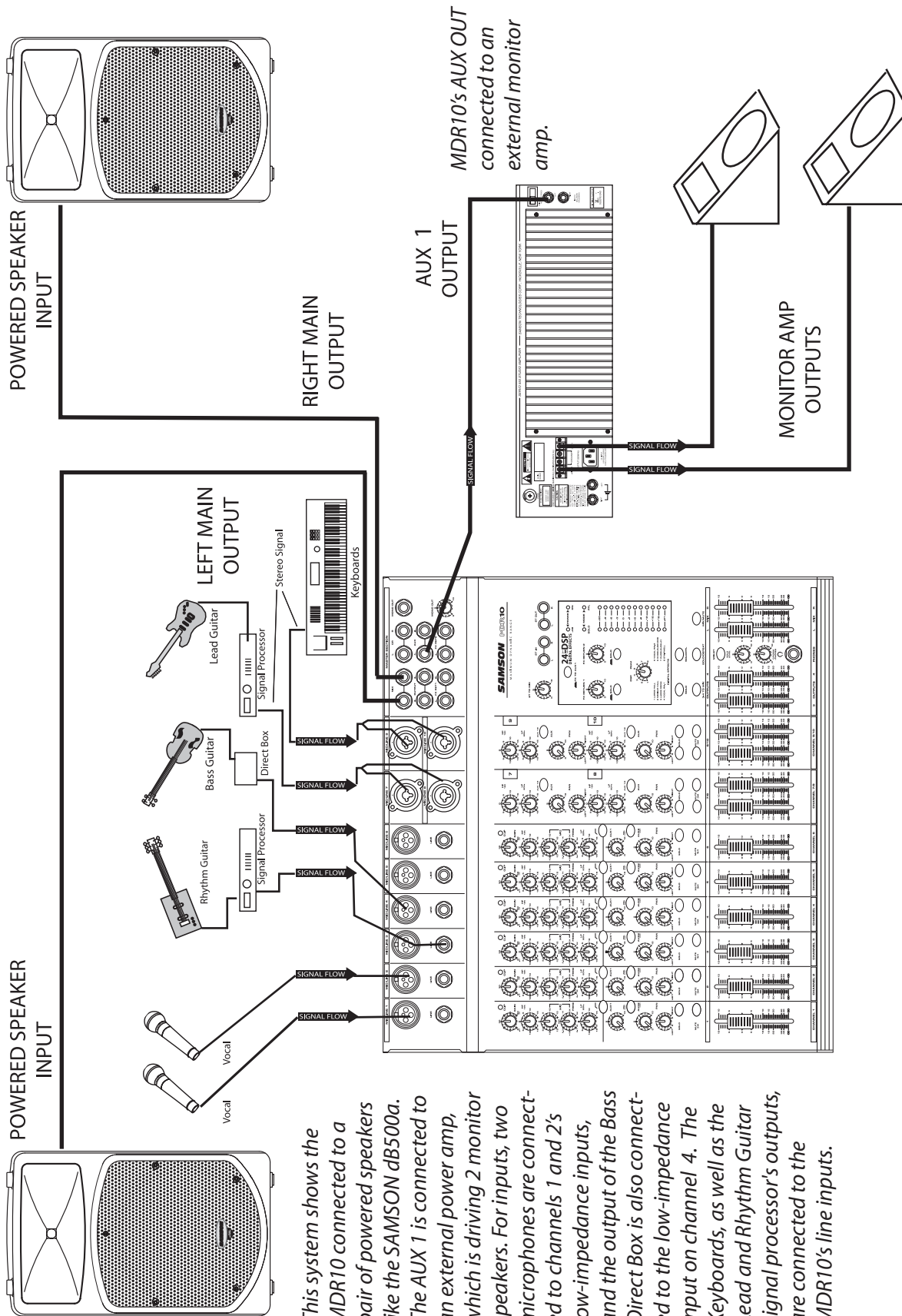

This system shows the MDR10 connected to a pair of powered speakers like the SAMSON dB500a. The AUX 1 is connected to an external power amp, which is driving 2 monitor speakers. For inputs, two microphones are connected to channels 1 and 2's low-impedance inputs, and the output of the Bass Direct Box is also connected to the low-impedance input on channel 4. The Keyboards, as well as the Lead and Rhythm Guitar signal processor's outputs, are connected to the MDR10's line inputs.

MDR10 System Set-Ups

MDR10 RECORDING SET-UP

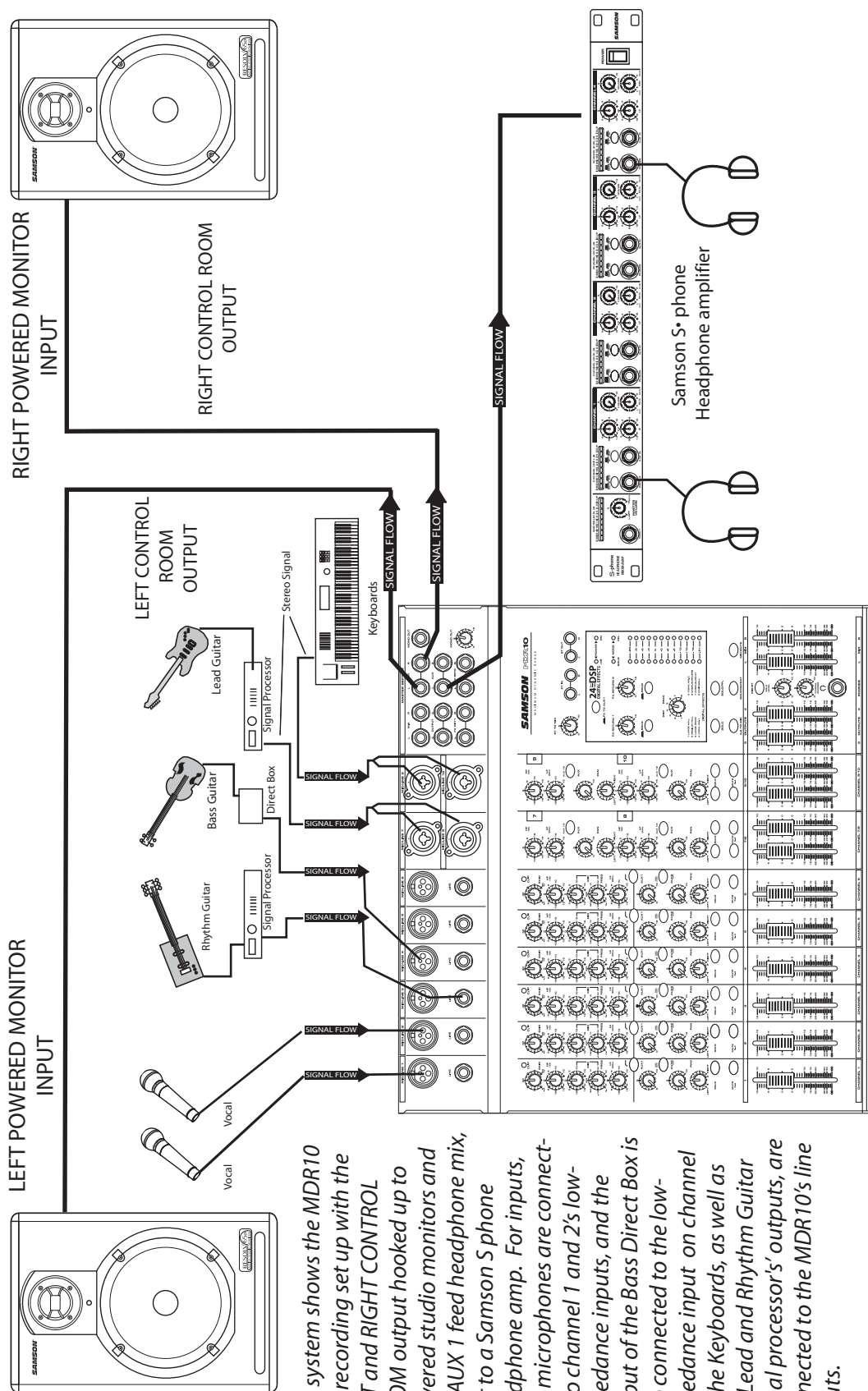

This system shows the MDR10 in a recording set up with the LEFT and RIGHT CONTROL ROOM output hooked up to powered studio monitors and the AUX 1 feed headphone mix, sent to a Samson S•phone headphone amp. For inputs, two microphones are connected to channel 1 and 2's low-impedance inputs, and the output of the Bass Direct Box is also connected to the low-impedance input on channel 4. The Keyboards, as well as the Lead and Rhythm Guitar signal processor's outputs, are connected to the MDR10's line inputs.

MDR10 Wiring Guide

CONNECTING THE MDR10

There are several ways to interface the MDR10 to support a variety of applications. The MDR10 features balanced inputs and outputs, so connecting balanced and unbalanced signals is possible.

Unbalanced 1/4" Connector

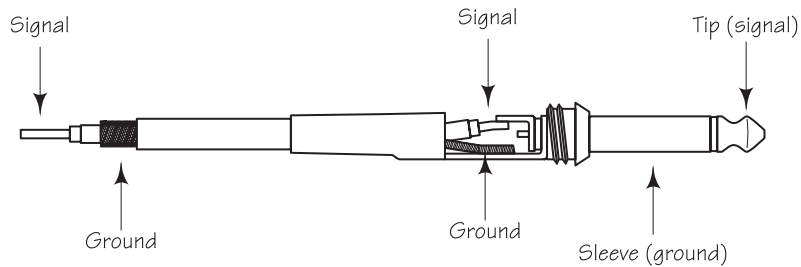

Balanced TRS 1/4" Connector

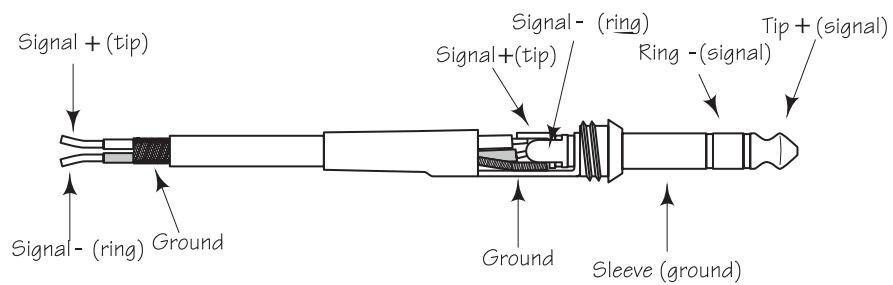

XLR Balanced Wiring Guide

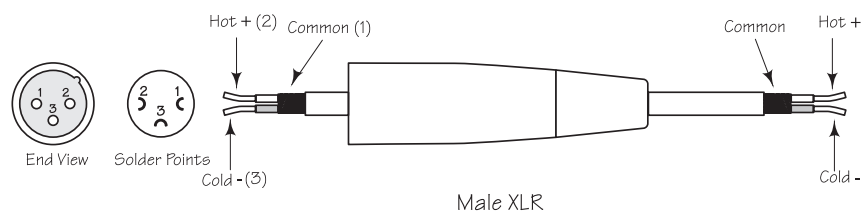
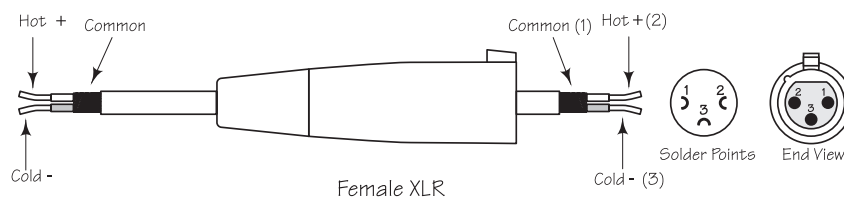

MDR10 Specifications

	Normal	Limit
Frequency Response (Trim @ Min, unity gain \pm 3 dB)		
Mic to Main	15 Hz - 54 kHz	20 Hz - 50 kHz
Line to Main	5 Hz - 70 kHz	
Aux Return to Main	5 Hz - 98 kHz	
Line to Aux Send	5 Hz - 57 kHz	
T.H.D. (Trim @ Min, +4dBu output, unity gain, 1 kHz w/30 kHz LPF)		
Mic/Line to Main (Mono Ch)	0.02%	0.05%
Line to Main (Stereo Ch)	0.02%	0.05%
Line to Aux Send	0.02%	0.05%
Equivalent Input Noise ("A" filter on, input shorted)		
Mic	-128 dB	-128 dB
Line	-104 dB	
Maximum Voltage Gain		
Mic to Main	85 dB	
Line to Main (Mono Ch)	50 dB	
Line/Tape to Main (Stereo Ch)	20 dB	
Aux Return to Main	20 dB	
Mic to Aux Send	74 dB	
Line to Aux Send (Stereo Ch)	41 dB	
Residual Noise (30 kHz LPF, all control Min)		
Main	-96 dBu	-85 dBu
Aux Send	-82 dBu	-82 dBu
Crosstalk (@ 1 kHz w/ 30 kHz LPF)		
Ch vs. Ch	75 dB	70 dB
Input vs. Output	87.5 dB	80 dB
Peak LED Sensitivity (before clipping)	3 dB	5 \pm 2dB
CLIP Indicators	Turn on: THD > 0.1%	
Headphone output (600 ohm load)	100 mW	90 mW min.
Maximum Input Level (1 kHz, \pm 3dB)		
Mic Input (Mono Ch)	-8 dBu	
Line Input (Mono Ch)	+27 dBu	
Input Channel Equalizer (\pm 2dB)		
High (shelving)	12 kHz \pm 15 dB	
Mid (peaking)	Variable 100Hz - 5 kHz \pm 15 dB	
Low (shelving)	80 Hz \pm 15 dB	
Meters	12 POINT LED METERS (-21, -18, -16, -12, -9, -6, -3, 0, +6, +9, +20)	
Internal DSP Effects	24 BIT -8 presets: 1 - Large Hall; 2 Medium Hall, 3 - Large Room; 4 - Vocal Room 1; 5 - Vocal Room 2; 6 - Chorus + Reverb; 7 - Chorus + Delay; 8 - Stairwell	
Phantom Power	+48V	
Power Requirement	110V-240V, 50/60Hz	
Power Consumption	50W	
Dimensions (W x D x H)	16.25" x 16.25" x 3.75" (41.3cm x 41.3cm x 9.5cm)	
Weight	7.5 lbs. (3.4 kg)	

MDR10 Block Diagram

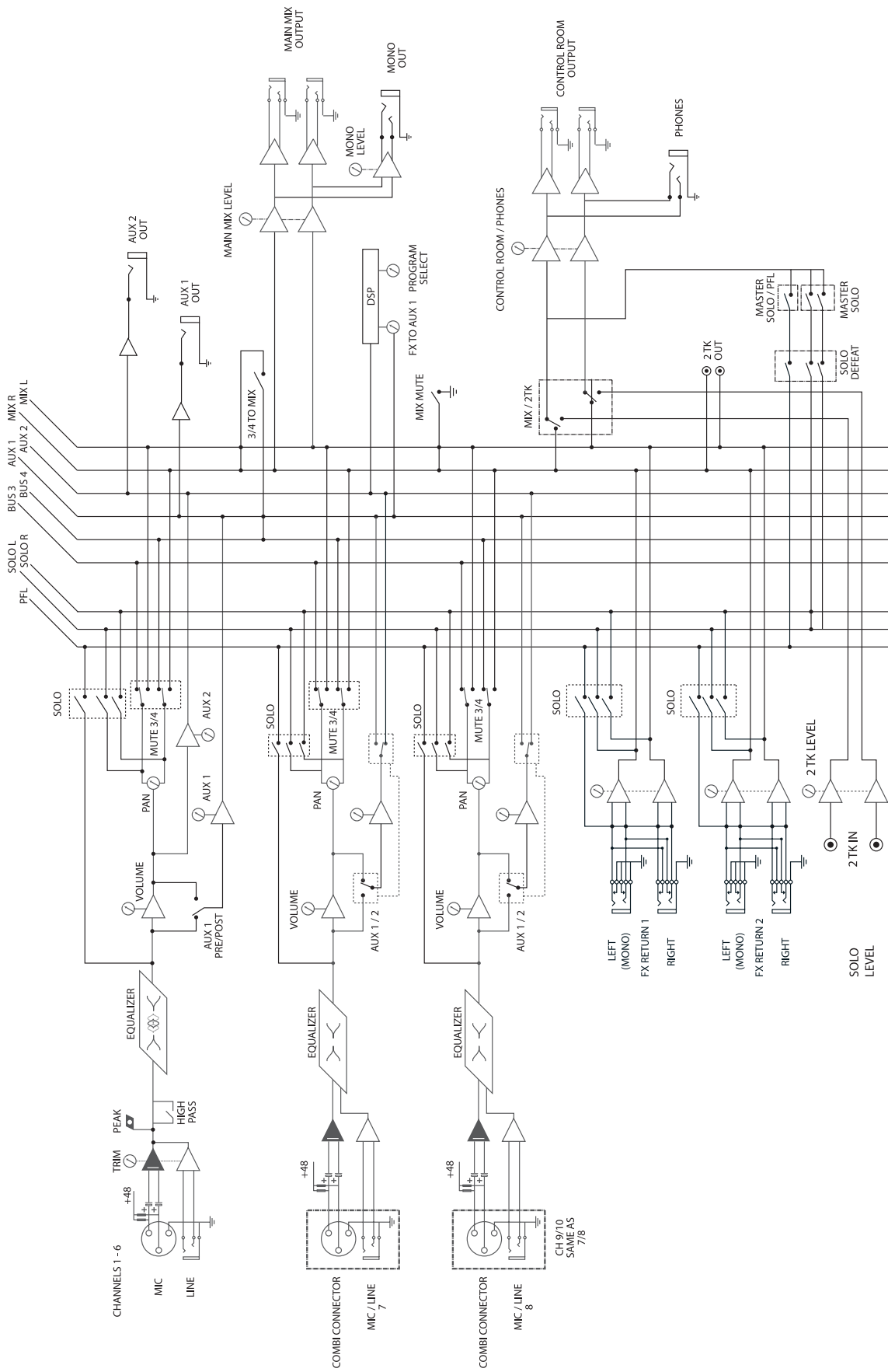

Notes

Samson Technologies Corp.
575 Underhill Blvd.
P.O. Box 9031
Syosset, NY 11791-9031
Phone: 1-800-3-SAMSON (1-800-372-6766)
Fax: 516-364-3888
www.samsontech.com

Free Manuals Download Website

<http://myh66.com>

<http://usermanuals.us>

<http://www.somanuals.com>

<http://www.4manuals.cc>

<http://www.manual-lib.com>

<http://www.404manual.com>

<http://www.luxmanual.com>

<http://aubethermostatmanual.com>

Golf course search by state

<http://golfingnear.com>

Email search by domain

<http://emailbydomain.com>

Auto manuals search

<http://auto.somanuals.com>

TV manuals search

<http://tv.somanuals.com>