

SAMSUNG

CL28A20HE

CL32A20HE

COLOR TELEVISION



**Owner's
Instructions**

Important Warranty Information Regarding Television Format Viewing

Standard screen format televisions (4:3, the aspect ratio of the screen width to height) are primarily designed to view standard format full-motion video. The images displayed on them should primarily be in the standard 4:3 ratio format and constantly moving. Displaying stationary graphics and images on screen, such as the dark top and bottom letterbox bars (wide screen pictures), should be limited to no more than 15% of the total television viewing per week.

Wide screen format televisions (16:9, the aspect ratio of the screen width to height) are primarily designed to view wide screen format full-motion video. The images displayed on them should primarily be in the wide screen 16:9 ratio format, or expanded to fill the screen if your model offers this feature, and constantly moving. Displaying stationary graphics and images on screen, such as the dark side-bars on non-expanded standard format television video and programming, should be limited to no more than 15% of the total television viewing per week.

Additionally, viewing other stationary images and text such as stock market reports, video game displays, station logos, web sites or computer graphics and patterns, should be limited as described above for all televisions. *Displaying any stationary images that exceed the above guidelines can cause uneven aging of picture tubes (CRTs) that leave subtle, but permanent burned-in ghost images in the television picture. To avoid this, vary the programming and images, and primarily display full screen moving images, not stationary patterns or dark bars.* On television models that offer picture sizing features, use these controls to view the different formats as a full screen picture.

Be careful in the selection and duration of television formats used for viewing. Uneven CRT aging as a result of format selection and use, as well as other burned-in images, is not covered by your Samsung limited warranty.

Chapter 1: Your New TV 5

List of Features	5
Accessories	5
Familiarizing Yourself with The TV	6
Front Panel Buttons	6
Side Panel Jacks	7
Rear Panel Jacks	8
Remote Control	9

Chapter 2: Installation 11

Connecting VHF and UHF Antennas	11
Antennas with 300-ohm Flat Twin Leads	11
Antennas with 75-ohm Round Leads	12
Separate VHF and UHF Antennas	12
Connecting Cable TV	12
Cable without a Cable Box	12
Connecting to a Cable Box that Descrambles All Channels	13
Connecting to a Cable Box that Descrambles Some Channels	13
Connecting a VCR	15
Connecting an S-VHS VCR	16
Connecting a Second VCR to Record from the TV	17
Connecting a DVD Player	17
Connecting a Digital TV Set-Top Box (480p/1080i)	18
Connecting a Camcorder	19
Installing Batteries in the Remote Control	20

Chapter 3: Operation 21

Turning the TV On and Off	21
Plug & Play Feature	21
Viewing the Menu and On-Screen Displays	23
Viewing the Menu	23
Viewing the Display	23
Selecting a Menu Language	24
Memorizing the Channels	25
Selecting the Video Signal-source	25
Storing Channels in Memory (Automatic Method)	26
Adding and Erasing Channels (Manual Method)	27
Changing Channels	28
Using the Channel Buttons	28
Directly Accessing Channels	28
Using the PRE-CH Button to select the Previous Channel	28
Labeling the Channels	29
Setting the Clock	30
Customizing the Picture	31
Using Automatic Picture Settings	32
Adjusting the Volume	33
Using the Mute Button	33

Chapter 3: Operation (Cont.) 34

Customizing the Sound 34
 Using Automatic Sound Settings 35
 Viewing an External Signal Source 36
 Setting the Signal Source 36
 Assigning Names to External input mode 37

Chapter 4: Special Features 38

Fine Tuning Channels 38
 LNA (Low Noise Amplifier) 39
 Changing the Color Tone 40
 Changing the Screen Size 41
 Digital Noise Reduction 42
 Tilt 43
 DNIe™ (Digital Natural Image engine) **DNIe™** 44
 Using the R.Surf Feature 45
 Viewing Picture-in-Picture 46
 Choosing a Multi-Channel Sound (MTS) Soundtrack 52
 Adjusting the Volume Automatically 53
 Setting the Surround 54
 Setting the BBE 55
 Setting the On/Off Timer 56
 Setting the Sleep Timer 57
 Setting the Preferred Volume Level and Channel 58
 Viewing Closed Captions 59
 Setting The On/Off Melody 60
 Viewing the Demonstration 61
 Using WISE LINK 62
 Switching to WISE LINK Mode 64
 Selecting Image (JPEG) Files/Music (MP3) Files 65
 Picture (JPEG) Playback 66
 Rotating the Picture (JPEG) 67
 Picture Zoom (JPEG) 68
 Music File (MP3) Playback 69
 Playback All JPEG/MP3 Files 70
 WISE LINK Menu Setup 71
 Customizing Your Remote Control 73

Chapter 5: Troubleshooting 75

Identifying Problems 75

Appendix 76

Cleaning and Maintaining Your TV 76
 Using Your TV in Another Country 76
 Specifications 76

Chapter One

YOUR NEW TV

List of Features

Your TV was designed with the latest technology. This TV is a high-performance unit that includes the following special features:

- Full Flat Screen
- Automatic timer to turn the TV on and off
- Adjustable picture and sound settings that can be stored in the TV's memory
- Automatic channel tuning for up to 181 channels
- A special filter to reduce or eliminate reception problems
- A built-in multi-channel sound decoder for stereo and bilingual listening
- Built-in, dual channel speakers
- A special sleep timer
- Picture in Picture
- DNIe™ (Digital Natural Image engine) **DNIe™**
Samsung's New Technology enables an improved image with detail, contrast and white enhancement and 3D noise reduction.
- WISE LINK is used to play JPEG files (*.jpg) and MP3 files (*.MP3) stored in the memory card on the TV.

Once you have unpacked your TV, check to make sure that you have all the parts shown here. If any piece is missing or broken, call your dealer.

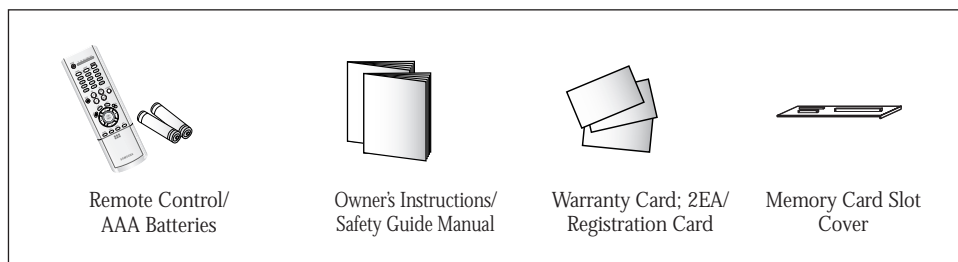

Familiarizing Yourself with The TV

Front Panel Buttons

The buttons on the front panel control your TV's basic features, including the on-screen menu. To use the more advanced features, you must use the remote control.

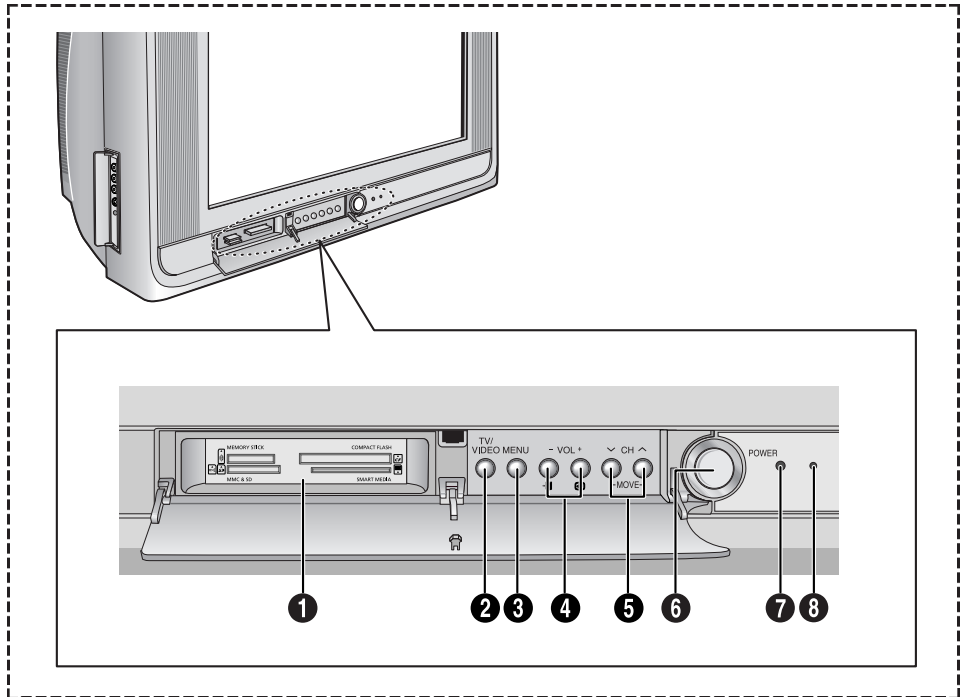

1 Memory Card Slot

Insert the memory card into the slot.

2 TV/VIDEO

Press to change between viewing TV programs and signals from other components.

3 MENU

Press to see an on-screen menu of your TV's features.

4 VOL – and + (TV mode)

Press to increase or decrease the volume. Used to adjust the selected item.

EXIT /ENTER

(Wise Link mode)

Used to move to the previous menu. Used to execute the selected item.

5 CH ∇ and CH ▲

Press to change channels.

MOVE

Used to move between items.

You can also use these buttons in the WISE LINK mode.

6 POWER

Press to turn the TV on and off.

7 Remote Control Sensor

Aim the remote control towards this spot on the TV.

8 TIMER indicator

When the TV is turned on, the TIMER indicator blinks five times. This indicator illuminates when the TIMER mode is set to the "On" position after setting the clock and either the On timer or Off timer, with the remote control. Even if the power is turned off, this indicator stays lit. (Clock must be set before using this function.)

Note: You can use the Volume button on the remote control to control the volume while in WISE LINK mode. (You cannot control the volume on the front control panel of TV.)

Side Panel Jacks

You can use the side panel jacks to connect an A/V component that is used only occasionally, such as a camcorder or video game. (For information on connecting equipment, see page 19.)

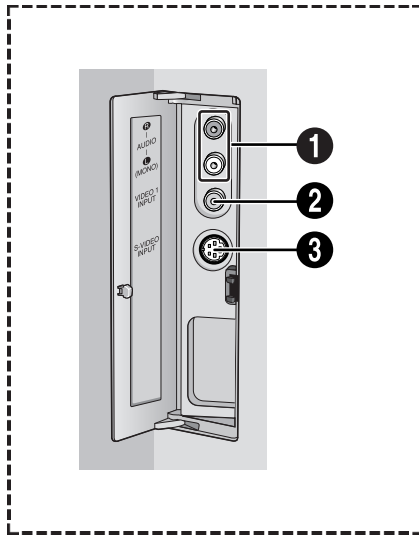

❶ AUDIO INPUT jacks

Used to connect the audio signals from a camcorder or video game.

❷ VIDEO INPUT jack

Used to connect a video signal from a camcorder or video game.

❸ SUPER VIDEO INPUT jack

S-Video signal from an S-VHS VCR or DVD player.

Note: In S-Video mode, Audio Output depends what kind of audio input source is connected to the side audio input jacks (AV1).

Rear Panel Jacks

Use the rear panel jacks to connect an A/V component that will be connected continuously, such as a VCR or a DVD player. Because there are three sets of input jacks, you can connect three different A/V components (i.e., a VCR and a DVD, 2 VCRs, etc.)

For more information on connecting equipment, see pages 11 – 18.

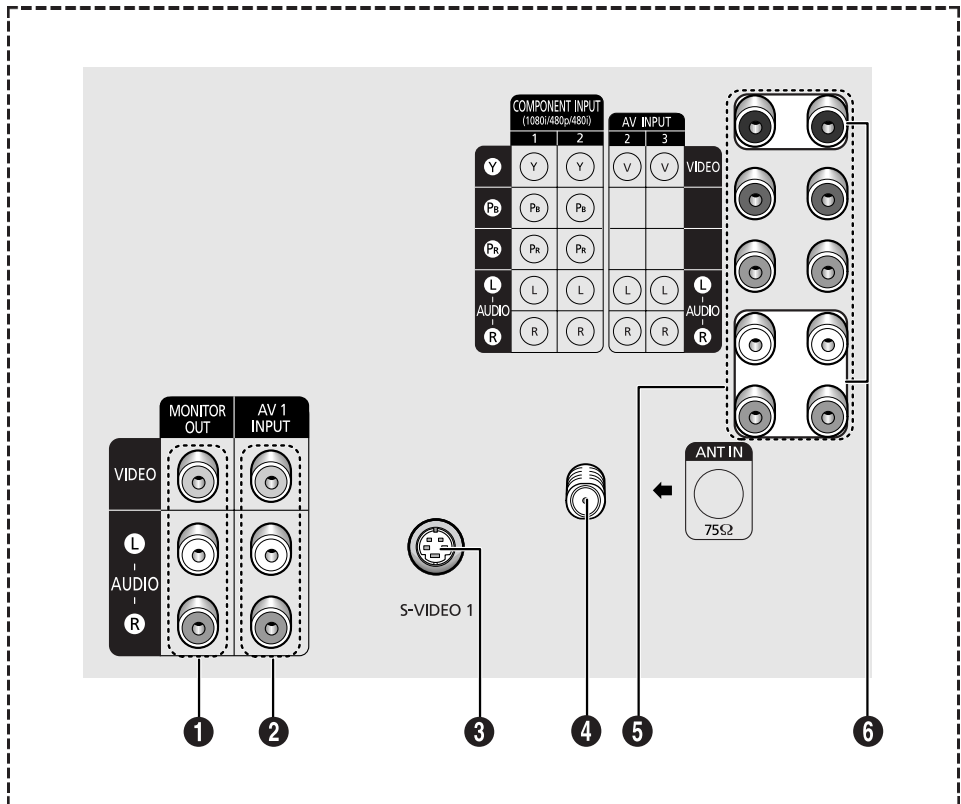

1 AUDIO-VIDEO MONITOR OUTPUT jacks

These audio-video signals are identical to A/V signals being displayed on the big screen. (Typically used as the input signals for a recording VCR.)

2, 6 VIDEO/AUDIO INPUT jacks

Video and Audio signals from VCRs, DVD players and similar devices.
 Note: The common jack of component 1 and AV2, component 2 and AV3 input jacks are exclusive relation with each other.

3 SUPER VIDEO INPUT jack

S-Video signal from an S-VHS VCR or DVD player.
 Note: In S-Video mode, Audio Output depends what kind of audio input source is connected to the side audio input jacks (AV1).

4 VHF/UHF

Connect to an antenna or to a cable TV system.

5 COMPONENT 1, 2 INPUT jacks (480i/480p/1080i)

Connect to the audio and component output jacks of a DVD player or Set-Top Box.
 Note: Only black and white signals are output from a monitor in DVD/DTV mode.

Remote Control

You can use the remote control up to about 23 feet from the TV. When using the remote, always point it directly at the TV.

You can also use your remote control to operate your Set-Top Box, VCR, DVD and cable box. See page 73 for details.

1 POWER

Turns the TV on and off.

2 S.MODE

Adjust the TV sound by selecting one of the preset factory settings (or select your personal, customized sound settings).

3 P.MODE

Adjust the TV picture by selecting one of the preset factory settings (or select your personal, customized picture settings).

4 Number buttons

Press to select channels directly on the TV.

+100

Press to select channels over 100. For example, to select channel 121, press "+100," then press "2" and "1."

5 VOL -, VOL +

Press to increase or decrease the volume.

6 MUTE

Press to temporarily cut off the sound.

7 SLEEP

Press to select a preset time interval for automatic shutoff.

8 MENU

Displays the main on-screen menu.

9 R.SURF

Press the R.SURF button to automatically return to a preferred channel after a user-preset time delay.

ROTATE

Press to rotate a JPEG image by 90 degrees.

10 W.LINK

Press to switch to or initialize the WISE LINK mode.

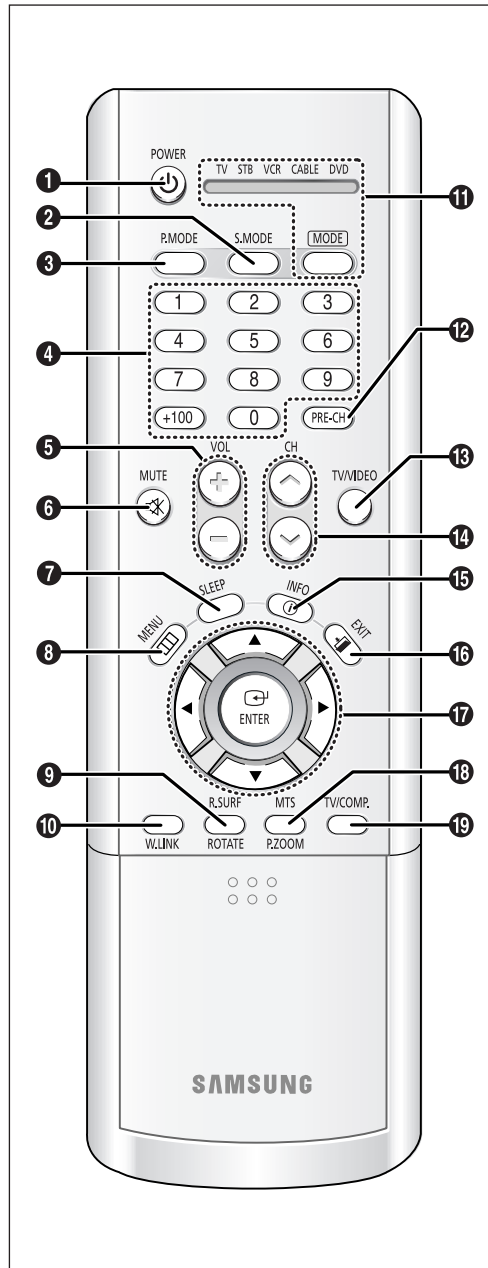

11 MODE

Selects a target device to be controlled by the Samsung remote control (i.e., TV, Set Top Box, VCR, Cable box, or DVD).

12 PRE-CH

Tunes to the previous channel.

13 TV/VIDEO

Press to display all of the available video sources (i.e., Antenna/Cable, VCR).

14 CH ^ and CH v (Channel Up/Down)

Press CH ^ or CH v to change channels.

15 INFO

Press to see the time, channel, etc., on-screen.

16 EXIT

Press to exit the menu.

17 Up, Down, Left, Right (▲, ▼, ◀, ▶) / ENTER

Press to select highlight up, down, left, or right. While using the on-screen menus, press ENTER to activate (or change) a particular item.

18 MTS (Multichannel Television Stereo)

Press to choose stereo, mono or Separate Audio Program (SAP broadcast).

P.ZOOM

Press to expand a JPEG image.

19 TV/COMP.

Press to switch the TV, COMPONENT1 or 2 mode.

Remote Control

20 P.SIZE

Press to change the screen size.

21 DNIe

Activates DNIe (Digital Natural Image engine).

22 VCR(DVD, DVR STB or Wise Link) Controls

REW (Rewind)

Press to rewind a tape in your VCR(DVD, DVR or STB).

STOP

Press this button to stop a tape during play, record, rewind or fast forward. If the button is pressed during Full-Automatic play, the function will be cancelled.

PLAY/PAUSE

Press the PLAY/PAUSE button to play back prerecorded tapes or pause the tape.

FF

Press to fast forward the tape in your VCR(DVD, DVR or STB).

23 SET

Use this button when you are setting up your remote control to operate your Set Top Box, VCR, Cable box or DVD.

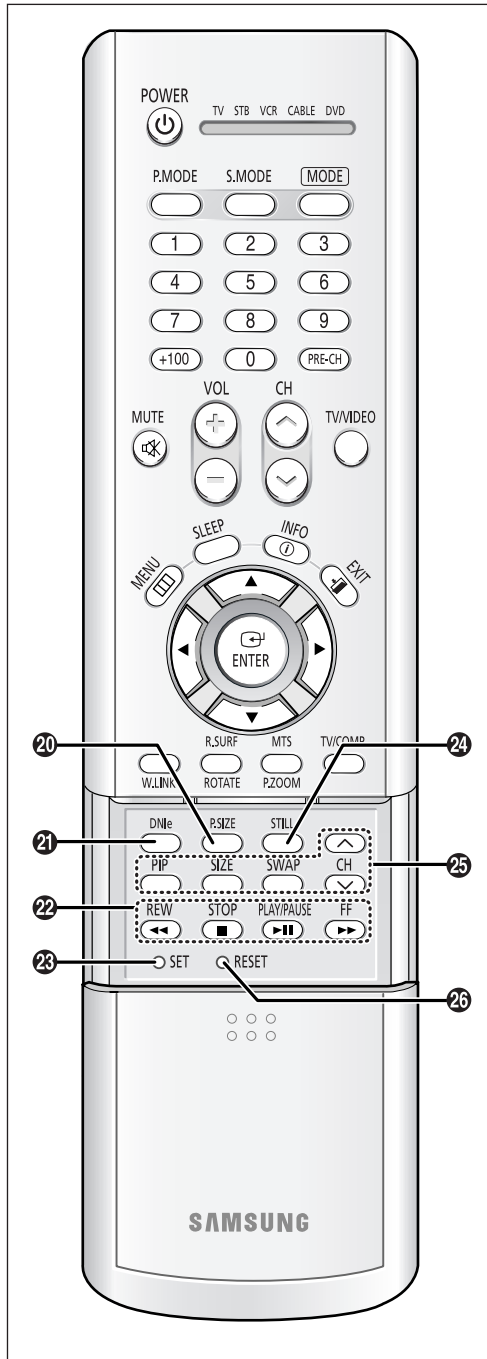

24 STILL (Main picture)

Press to stop the action during a particular scene. Press again to resume normal video. Note: The still function doesn't operate in Component 1 or 2 mode.

25 PIP Controls

PIP

Press this button to control the PIP window.

SIZE

Press to make the PIP window small, large, double window or stock ticker window.

SWAP

Exchanges the video signal that is currently displayed on the main screen with the signal in the PIP window.

CH

Displays the available channels in sequence (These buttons change channels in the PIP window only).

26 RESET

If your remote control is not functioning properly, take out the batteries and press the reset button for about 2~3 seconds. Re-insert the batteries and try using the remote control again.

Chapter Two

INSTALLATION

Connecting VHF and UHF Antennas

If your antenna has a set of leads that look like this, see “Antennas with 300-ohm Flat Twin Leads” below.

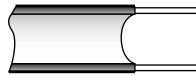

If your antenna has one lead that looks like this, see “Antennas with 75-ohm Round Leads” on next page.



If you have two antennas, see “Separate VHF and UHF Antennas” on next page.

Antennas with 300-ohm Flat Twin Leads

If you are using an off-air antenna (such as a roof antenna or “rabbit ears”) that has 300-ohm twin flat leads, follow the directions below.

1

Place the wires from the twin leads under the screws on the 300-75 ohm adaptor (not supplied). Use a screwdriver to tighten the screws.

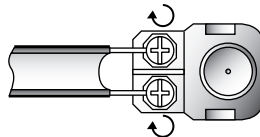

2

Plug the adaptor into the VHF/UHF terminal on the bottom of the back panel.

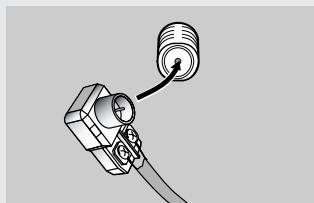

INSTALLATION

Antennas with 75-ohm Round Leads

1

Plug the antenna lead into the VHF/UHF terminal on the bottom of the back panel.

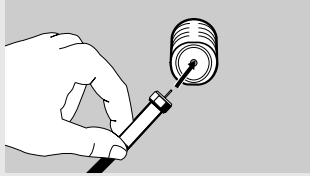

Separate VHF and UHF Antennas

If you have two separate antennas for your TV (one VHF and one UHF), you must combine the two antenna signals before connecting the antennas to the TV. This procedure requires an optional combiner-adaptor (available at most electronics shops).

1

Connect both antenna leads to the combiner.

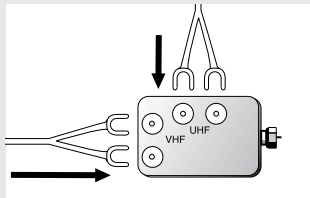

2

Plug the combiner into the VHF/UHF terminal on the bottom of the rear panel.

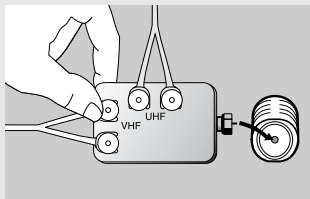

Connecting Cable TV

To connect to a cable TV system, follow the instructions below.

Cable without a Cable Box

1

Plug the incoming cable into the VHF/UHF antenna terminal on back of the TV.

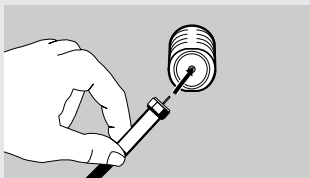

◀ Because this TV is cable-ready, you do not need a cable box to view unscrambled cable channels.

INSTALLATION

Connecting to a Cable Box that Descrambles All Channels

1
Find the cable that is connected to the ANTENNA OUT terminal on your cable box.

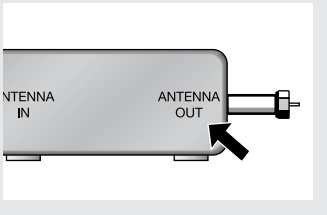

◀ This terminal might be labeled “ANT OUT”, “VHF OUT” or simply, “OUT”.

2
Connect the other end of this cable to the VHF/UHF antenna terminal on the back of the TV.

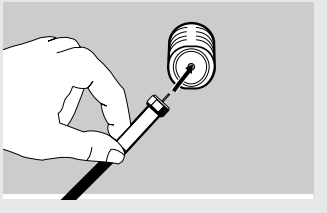

Connecting to a Cable Box that Descrambles Some Channels

If your cable box descrambles only some channels (such as premium channels), follow the instructions below. You will need a two-way splitter, an RF (A/B) switch, and four lengths of coaxial cable. (These items are available at most electronics stores.)

1
Find and disconnect the cable that is connected to the ANTENNA IN terminal on your cable box.

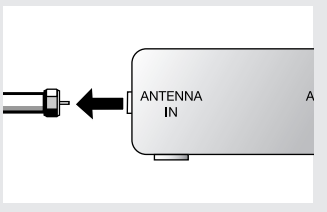

◀ This terminal might be labeled “ANT IN”, “VHF IN” or simply, “IN”.

2
Connect this cable to a two-way splitter.

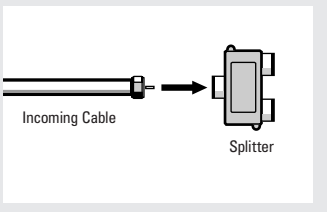

3
Connect a coaxial cable between an OUTPUT terminal on the splitter and the IN terminal on the cable box.

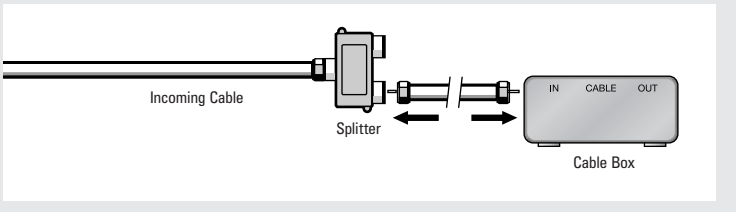

INSTALLATION

4

Connect a coaxial cable between the ANTENNA OUT terminal on the cable box and the B-IN terminal on the RF(A/B) switch.

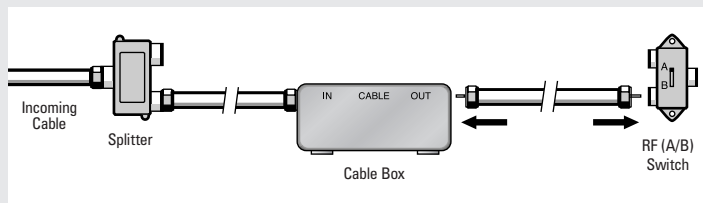

5

Connect another cable between the other OUT terminal on the splitter and the A-IN terminal on the RF (A/B) switch.

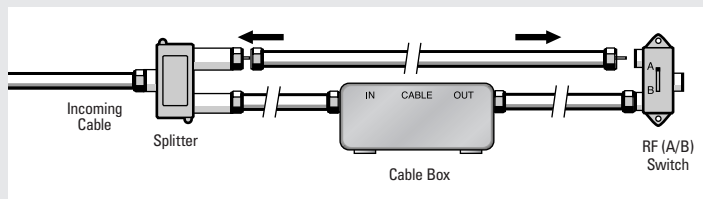

6

Connect the last coaxial cable between the OUT terminal on the RF (A/B) switch and the VHF/UHF terminal on the rear of the TV.

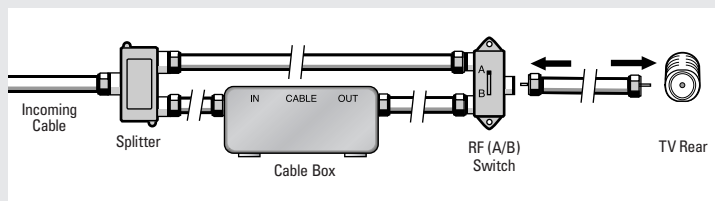

After you've made this connection, set the A/B switch to the "A" position for normal viewing. Set the A/B switch to the "B" position to view scrambled channels. (When you set the A/B switch to "B", you will need to tune your TV to the cable box's output channel, which is usually channel 3 or 4.)

Connecting a VCR

These instructions assume that you have already connected your TV to an antenna or a cable TV system (according to the instructions on pages 11-14). Skip step **1** if you have not yet connected to an antenna or a cable system.

1

Unplug the cable or antenna from the back of the TV.

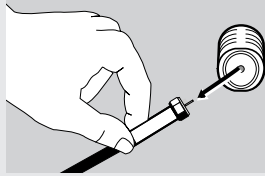

2

Connect the cable or antenna to the ANTENNA IN terminal on the back of the VCR.

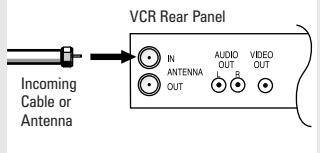

3

Connect a coaxial cable between the ANTENNA OUT terminal on the VCR and the antenna terminal on the TV.

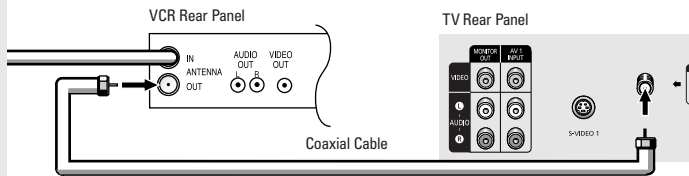

A coaxial cable is usually included with a VCR. (If not, check your local electronics store).

4

Connect a set of audio cables between the AUDIO OUT jacks on the VCR and the AUDIO jacks on the TV.

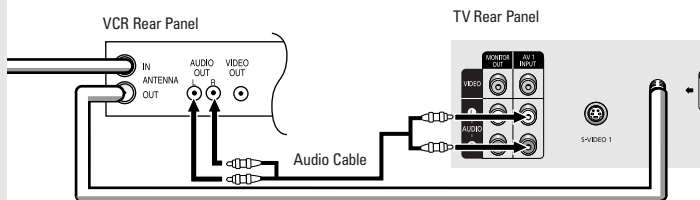

5

Connect a video cable between the VIDEO OUT jack on the VCR and the VIDEO jack on the TV.

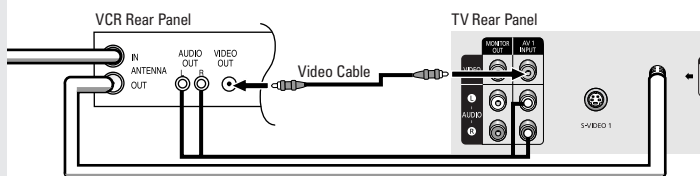

Follow the instructions in "Viewing an External Signal Source" to view your VCR tape.

INSTALLATION

Connecting an S-VHS VCR

Your Samsung TV can be connected to an S-Video signal from an S-VHS VCR. (This connection delivers a better picture as compared to a standard VHS VCR.)

1

To begin, follow steps 1–3 in the previous section to connect the antenna or cable to your VCR and your TV.

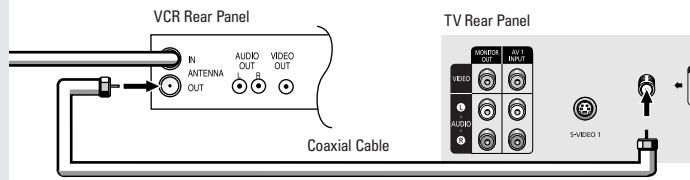

2

Connect a set of audio cables between the AUDIO OUT jacks on the VCR and the 1 AUDIO INPUT jacks on the TV.

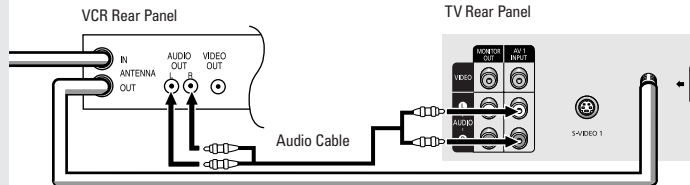

Make sure the jacks you are using are underneath the number “1.”

3

Connect an S-video cable between the S-VIDEO OUT jack on the VCR and the S-VIDEO INPUT jack on the TV.

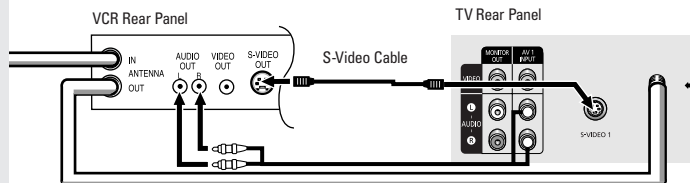

An S-video cable is usually included with an S-VHS VCR (If not, check your local electronics store.)

Connecting a Second VCR to Record from the TV

Your TV can send out signals of its picture and sound to be recorded by a second VCR. To do this, connect your second VCR as follows:

1

Connect a set of audio cables between the AUDIO OUT jacks on the TV and the AUDIO IN jacks on the VCR.

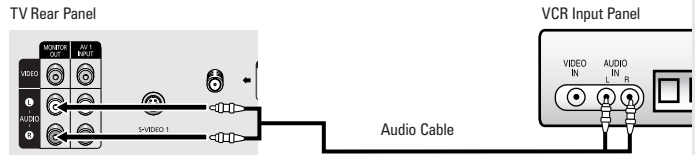

(The VCR input jacks might be either on the front or on back of the VCR.)

2

Connect a video cable between the VIDEO OUT jack on the TV and the VIDEO IN jack on the VCR.

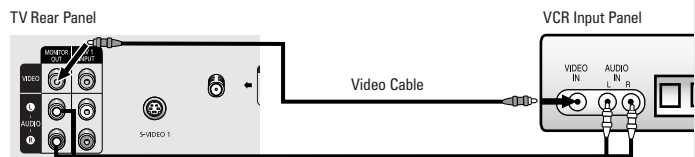

Refer to your VCR's instructions for more information about how to record using this kind of connection.

Connecting a DVD Player (480i)

The rear panel jacks on your TV make it easy to connect a DVD player to your TV.

1

Connect a set of audio cables between the COMPONENT INPUT 1 (L, R) or COMPONENT INPUT 2 (L, R) jacks on the TV and the AUDIO OUT jacks on the DVD player.

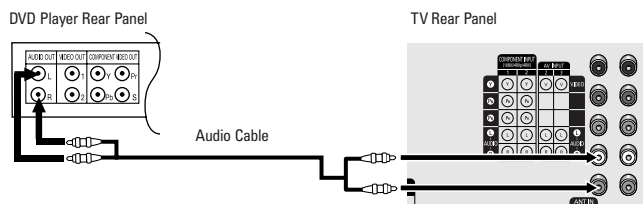

2

Connect a video cable between the COMPONENT INPUT 1 (Y, P_B, P_R) or COMPONENT INPUT 2 (Y, P_B, P_R) jacks on the TV and the COMPONENT VIDEO OUT (Y, P_B, P_R) jacks on the DVD player.

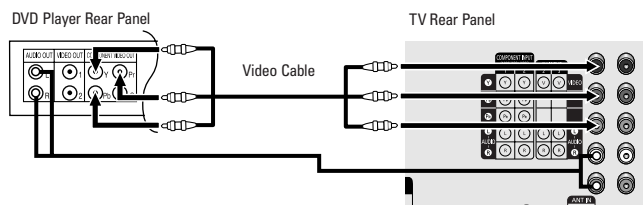

Note: For an explanation of Component video, see your DVD player's owner's manual.

Connecting a Digital TV Set-Top Box (480p/1080i)

Connecting to Y,P_B,P_R

Connect the Y, P_B, and P_R video outputs of the set-top box to their corresponding inputs on the TV. Next, connect the Left and Right audio from the set-top box to the corresponding L and R terminals on the TV. (The connections for a typical set-top box are shown below.)

1

Connect a coaxial cable between the ANTENNA OUT terminal on the Set Top Box and the antenna terminal on the TV.

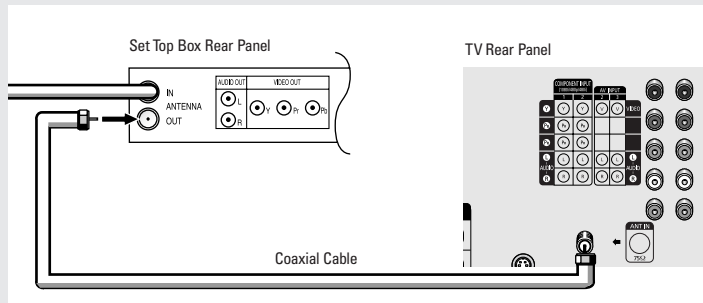

2

Connect a set of audio cables between the COMPONENT INPUT 2 (L, R) or COMPONENT INPUT 1 (L, R) jacks on the TV and the AUDIO OUT jacks on the Set Top Box.

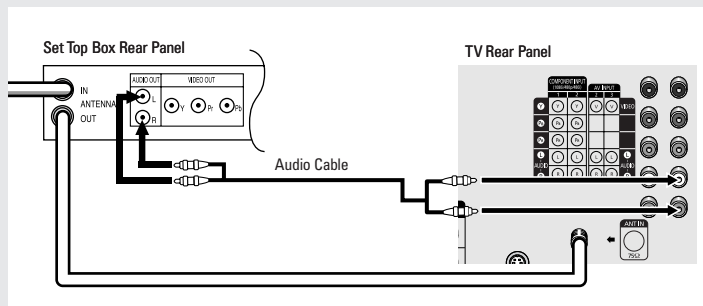

3

Connect a video cable between the COMPONENT INPUT 2 (Y, P_B, P_R) or COMPONENT INPUT 1 (Y, P_B, P_R) jacks on the TV and the VIDEO OUT (Y, P_B, P_R) jacks on the Set Top Box.

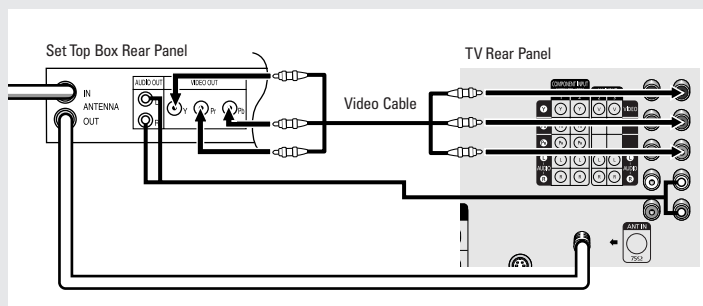

Note: For detailed information, refer to the Set Top Box instruction manual.

Connecting a Camcorder

The side panel jacks on your TV make it easy to connect a camcorder to your TV. They allow you to view the camcorder tapes without using a VCR. (Also see “Viewing an External Signal Source” on page 36).

1

Locate the A/V output jacks on the camcorder. They are usually found on the side or back of the camcorder.

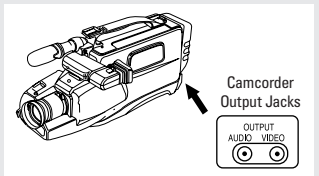

2

Connect an audio cable between the AUDIO OUTPUT jack on the camcorder and the AUDIO terminals on the side of the TV.

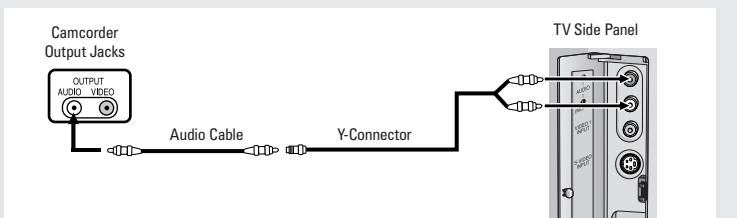

3

Connect a video cable between the VIDEO OUTPUT jack on the camcorder and the VIDEO terminal on the side of the TV.

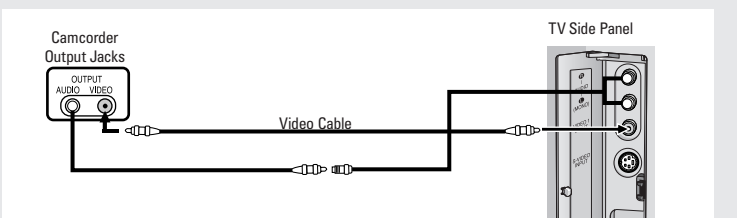

The audio-video cables shown here are usually included with a Camcorder. (If not, check your local electronics store.) If your camcorder is stereo, you need to connect a set of two cables.

Installing Batteries in the Remote Control

- 1**
Slide the cover out completely.

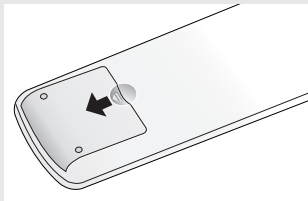

- 2**
Install two AAA size batteries.

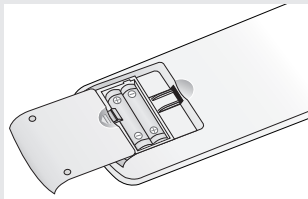

◀ Make sure to match the “+” and “-” ends of the batteries with the diagram inside the compartment.

- 3**
Replace the cover.

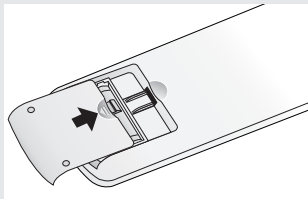

◀ Remove the batteries and store them in a cool, dry place if you won't be using the remote control for a long time.

The remote control can be used up to about 23 feet from the TV.
(Assuming typical TV usage, the batteries last for about one year.)

Chapter Three

OPERATION

Turning the TV On and Off

Press the **POWER** button on the remote control.

You can also use the **POWER** button on the front panel.

Plug & Play Feature

When the TV is initially powered On, five basic customer settings proceed automatically and subsequently: Setting the language, Video signal source, Ant. input check, Auto program and Clock.

1

Press the **POWER** button on the remote control.

The message "Plug & Play" is displayed.

It flickers for a little while and then the "Language" menu is automatically displayed.

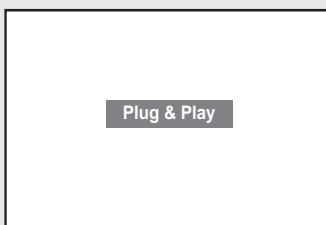

2

Press the ◀ or ▶ button to select the desired language.

Press the **MENU** button to enter the language, then the "Channel" menu is automatically displayed.

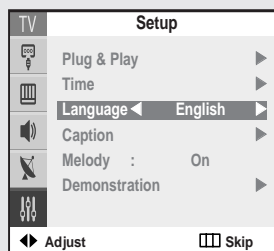

3

Press the ◀ or ▶ button to select the desired video signal source.

Press the **MENU** button to enter the video signal source, then the "Check antenna input." is automatically displayed.

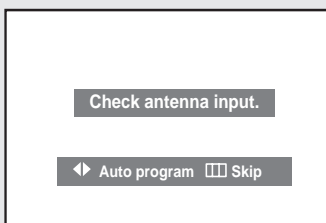
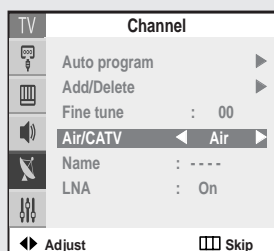

4

Make sure that the antenna is connected to the TV. And then press the ◀ or ▶ button to activate "Auto Program" or press the **MENU** button to skip. (refer to "Auto program" on page 27.)

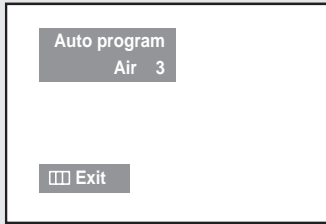

5

Press the ▶ button to move to the hour or minute. Set the hour or minute by pressing the ▲ or ▼ button. (refer to "Setting the Clock" on page 31.)

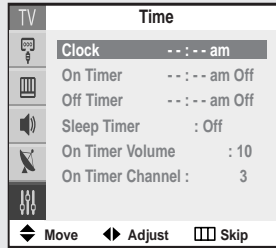

6

When you have finished, press the **MENU** button. The message "Enjoy your watching.." is displayed.

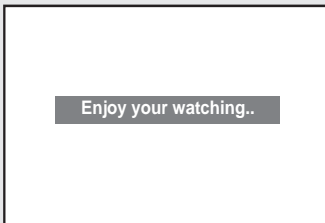

7

If you want to reset this feature
 (1) Press the **MENU** button.
 (2) Press the ▲ or ▼ button to select the "Setup", then press the **ENTER** button.
 (3) Press the **ENTER** button to select "Plug & Play".
 The message "Plug & Play" is displayed.

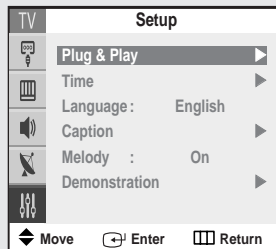

Note: Plug & Play feature doesn't work in the A/V mode.

Viewing the Menus and On-Screen Displays

Viewing the Menus

1

With the power on, press the **MENU** button.

The main menu appears on the screen. Its left side has five icons: Input, Picture, Sound, Channel and Setup.

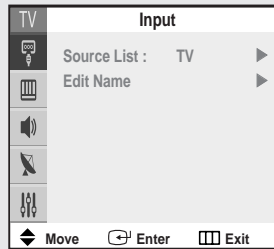

◀ The on-screen menus disappear from the screen after two minutes.

2

Use the **▲** and **▼** buttons to highlight one of the 5 icons. Then press the **ENTER** button to access the icon's sub-menu.

3

Press the **EXIT** button to exit the menu.

◀ You can also use the **MENU**, **CH** and **VOL** buttons on the control panel of the TV to make selections.

Viewing the Display

1

Press the **INFO** button.

The on-screen display shows any or all of the following: Active channel, the channel label, signal, MTS and the current time.

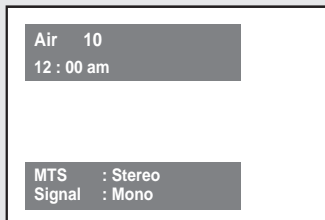

◀ The on-screen displays disappear after ten seconds.

Selecting a Menu Language

1

Press the **MENU** button to display the menu.

Press the **▲** or **▼** button to select "Setup", then press the **ENTER** button.

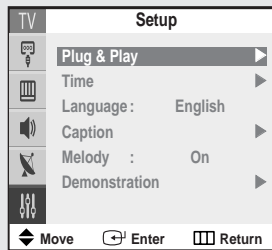

2

Press the **▲** or **▼** button to select "Language".

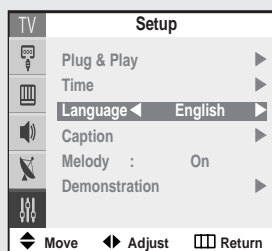

3

Press the **◀** or **▶** button to select the appropriate language: "English", "Español" or "Français".

Press the **EXIT** button to exit the menu.



Memorizing the Channels

Your TV can memorize and store all of the available channels for both “off-air” (antenna) and cable channels. After the available channels are memorized, use the CH \wedge and CH \vee buttons to scan through the channels. This eliminates the need to change channels by entering the channel digits. There are three steps for memorizing channels: selecting a broadcast source, memorizing the channels (automatic) and adding and deleting channels (manual).

Selecting the Video Signal-source

Before your television can begin memorizing the available channels, you must specify the type of signal source that is connected to the TV (i.e., an antenna or a cable system).

1

Press the **MENU** button to display the menu.

Press the \blacktriangle or \blacktriangledown button to select “Channel”, then press the **ENTER** button

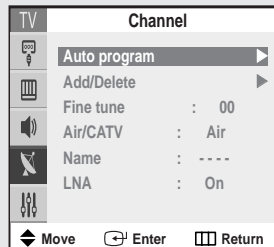

2

Press the \blacktriangle or \blacktriangledown button to select “Air/CATV”.

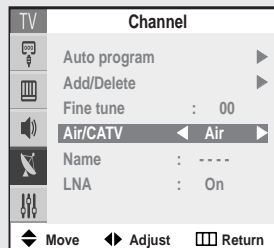

3

Repeatedly press the \blacktriangleleft or \blacktriangleright button to cycle through these choices: “Air” (antenna) “STD”, “HRC” or “IRC” (all cable TV).

Press the **EXIT** button to exit the menu.

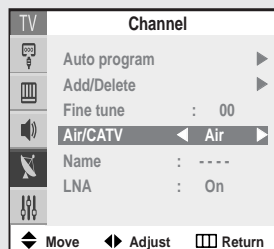

Note: STD, HRC and IRC identify various types of cable TV systems. Contact your local cable company to identify the type of cable system that exists in your particular area.

At this point the signal source has been selected. Proceed to “Storing Channels in Memory” (next page).

Storing Channels in Memory (Automatic Method)

1

First, select the correct signal source (Air, STD, HRC, IRC). See steps 1~3 on previous page.

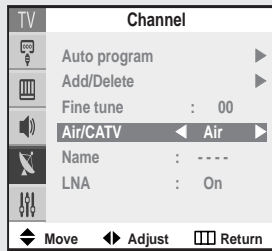

2

Press the ▲ or ▼ button to select "Auto Program".



3

Press the **ENTER** button. The TV will begin memorizing all of the available channels.

After all the available channels are stored, the channel menu reappears.

Press the **EXIT** button to exit the menu.

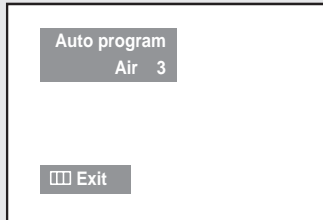

◀ The TV automatically cycles through all of the available channels and stores them in memory. This takes about one to two minutes.

Adding and Erasing Channels (Manual Method)

First, press the CH \wedge or CH \vee button or the number buttons to select the channel you want to add or delete.

1

Press the **MENU** button to display the menu.

Press the \blacktriangle or \blacktriangledown button to select "Channel", then press the **ENTER** button.

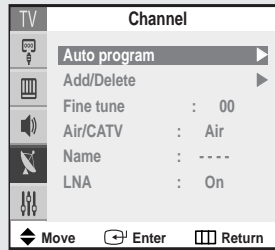

2

Press the \blacktriangle or \blacktriangledown button to select "Add/Delete", then press the **ENTER** button.

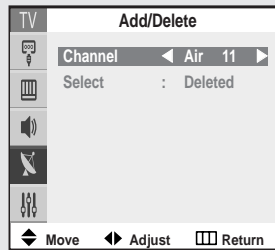

3

Press the \blacktriangleleft or \blacktriangleright button or the number buttons to select the channel you want to add or delete.

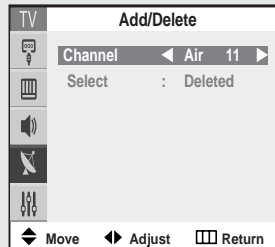

4

Press the \blacktriangle or \blacktriangledown button to select "Select", then press the \blacktriangleleft or \blacktriangleright button to select "Added" or "Deleted".

Press the **EXIT** button to exit the menu.

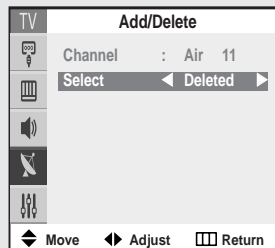

Changing Channels

Using the Channel Buttons

Press the **CH** \wedge or **CH** \vee button to change channels.

When you press **CH** \wedge or **CH** \vee , the TV changes channels in sequence. You will see all the channels that the TV has memorized. (The TV must have memorized at least three channels.) You will not see channels that were either erased or not memorized.

Directly Accessing Channels

Use the number buttons to quickly tune to any channel.

Press the number buttons to go directly to a channel. For example, to select channel 27, press "2" then "7". The TV will change channels when you press the second number.

When you use the number buttons, you can directly select channels that were either erased or not memorized.

To select a channel over 100, press the **+100** button. (For channel 122, press "+100" then "2" then "2".)

To change to single-digit channels (0-9) faster, press "0" before the single digit. (For channel "4" press "0" then "4".)

Using the PRE-CH Button to select the Previous Channel

Press the **PRE-CH** button. The TV will switch to the last channel viewed.

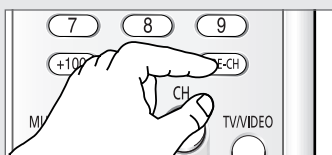

◀ To quickly switch between two channels that are far apart, tune to one channel, then use the number button to select the second channel. Then, use the **PRE-CH** button to quickly alternate between them.

Labeling the Channels

Use this feature to assign an easy-to-remember label to any channel (i.e., "CBS", "ESPN", "PBS2", "CNN1", etc.) A label consists of four fields, where each field is a letter, a number, "*", or a blank. When the INFO button is pressed, the channel label will appear next to the channel number.

1

Press the **CH** \wedge or **CH** \vee button to tune to the channel that will be labeled.

Air 11

2

Press the **MENU** button to display the menu.

Press the \blacktriangle or \blacktriangledown button to select "Channel", then press the **ENTER** button.

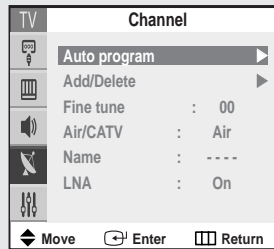

◀ Note: You cannot select "Name" in the AV mode.

3

Press the \blacktriangle or \blacktriangledown button to select "Name".
Press the \blacktriangleright button to begin labeling. The left-most field will be highlight.
(Each label has four fields. See top paragraph.)

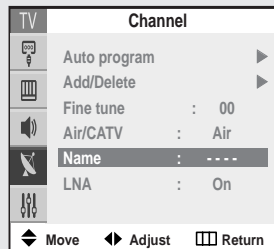

4

Press the \blacktriangle or \blacktriangledown button to select a letter, a number, "*" or a blank. (Pressing \blacktriangle or \blacktriangledown button results in this sequence: A, B,...Z, *, blank, 0, 1, ...9).

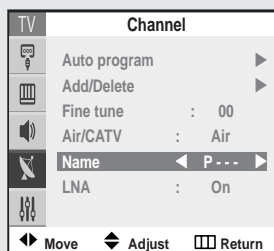

5

Press the \blacktriangleright button to switch to the next field, which will be high-light.
Select a second letter or digit using the \blacktriangle or \blacktriangledown button, as above.
Repeat the process to select the last two digits.

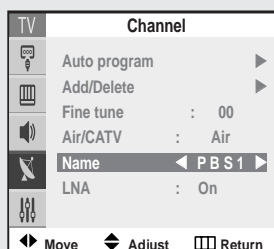

Press the EXIT button to exit the menu.

Setting the Clock

1

Press the **MENU** button to display the menu.

Press the **▲** or **▼** button to select "Setup", then press the **ENTER** button.

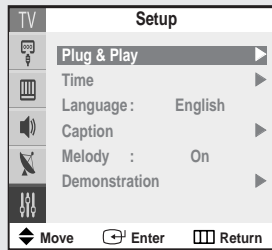

2

Press the **▲** or **▼** button to select "Time", then press the **ENTER** button.

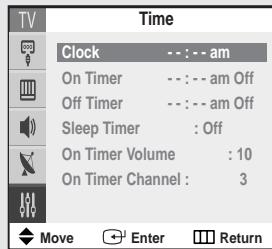

3

Press the **◀** or **▶** button to move to "Hour" or "Minute". Set the clock you want by pressing the **▲** or **▼** button, then press the **▶** button.

Press the **EXIT** button to exit the menu.

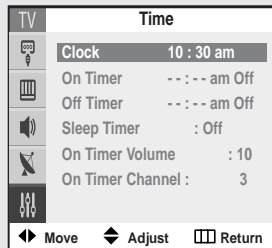

◀ When selecting the hours, be sure to select the proper time of day (am or pm).

You can change the hours by pressing the **▲** or **▼** button repeatedly (or by holding down either of these buttons).

The current time will appear every time you press the **INFO** button.

Customizing the Picture

You can use the on-screen menus to change the Contrast, Brightness, Sharpness, Color, Tint and according to personal preference. (Alternatively, you can use one of the “Automatic” settings. See next page.)

1

Press the **MENU** button to display the menu.

Press the **▲** or **▼** button to select “Picture”, then press the **ENTER** button.

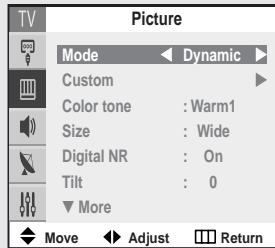

2

Press the **▲** or **▼** button to select “Custom”, then press the **ENTER** button. (The words Contrast, Brightness, Sharpness, Color and Tint will appear on the screen.)

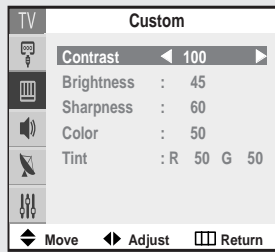

3

Press the **▲** or **▼** button to select a particular item.

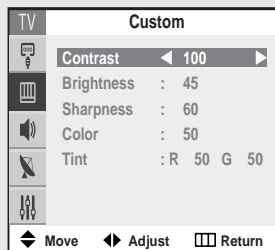

4

Press the **◀** or **▶** button to increase or decrease the value of a particular item.

For example, if you select “Contrast”, pressing the **▶** button increases it.

Press the **EXIT** button to exit the menu.

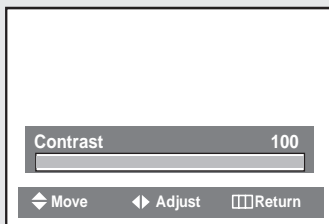

◀ After adjusting an item, the gauge will automatically disappear (after about 10 seconds).

Using Automatic Picture Settings

Your TV has three automatic picture settings (“Dynamic”, “Standard” and “Movie”) that are preset at the factory. You can activate either Dynamic, Standard, Movie or Custom by pressing the PMODE button (or by making a selection from the menu). Or, you can select “Custom” which automatically recalls your personalized picture settings.

1

Press the **MENU** button to display the menu.

Press the **▲** or **▼** button to select “Picture”, then press the **ENTER** button.

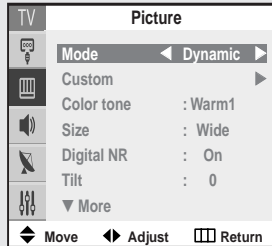

2

Press the **◀** or **▶** button to select the “Dynamic” “Standard” “Movie” or “Custom” picture setting.

Press the **EXIT** button to exit the menu.

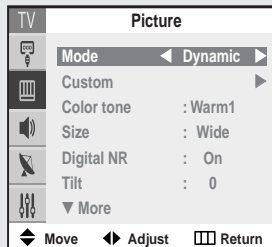

- Choose *Dynamic* for viewing the TV during the day or when there is bright light in the room.
- Choose *Standard* for the standard factory settings.
- Choose *Movie* when viewing the movie.
- Choose *Custom* if you want to adjust the settings according to personal preference (see “Customizing the Picture”, page 31).

Adjusting the Volume

Press the **VOL +** or **VOL -** button to increase or decrease the volume.

Using the MUTE Button

At any time, you can temporarily cut off the sound using the MUTE button.

1

Press the **MUTE** button and the sound cuts off. The word "Mute" will appear in the lower-left corner of the screen.

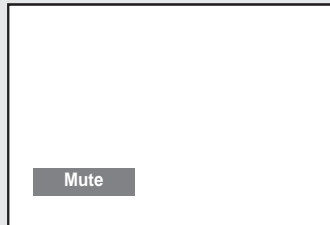
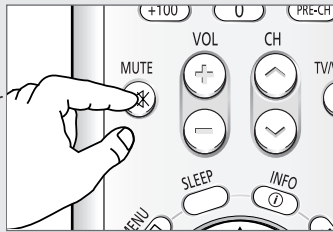

2

To turn mute off, press the **MUTE** button to again, or simply press either the **VOL +** or **VOL -** button.

Customizing the Sound

You can use the on-screen menus to adjust the Equalizer setting, according to individual preference. (Alternatively, you can use one of the “automatic” settings. See next page.)

1

Press the **MENU** button to display the menu.

Press the **▲** or **▼** button to select the “Sound”, then press the **ENTER** button.

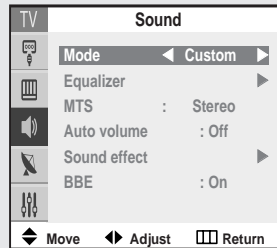

2

Press the **▲** or **▼** button to select “Equalizer”, then press the **ENTER** button.

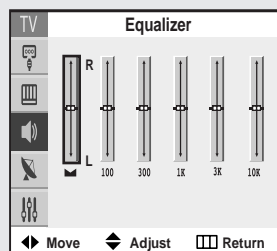

3

Press the **◀** or **▶** button to select a particular item.

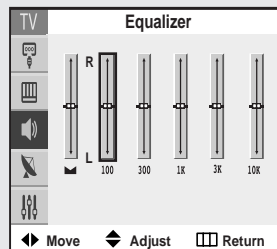

4

Press the **▲** or **▼** button to increase or decrease the value of a particular item.

Press the **EXIT** button to exit the menu.

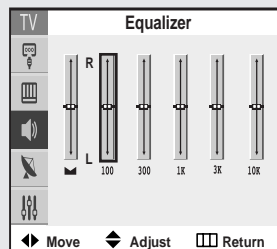

Using Automatic Sound Settings

Your TV has four automatic sound settings (“Standard”, “Music”, “Movie” and “Speech”) that are preset at the factory. You can activate either Standard, Music, Movie or Speech by pressing the S.MODE button (or by making a selection from the menu). Or, you can select “Custom”, which automatically recalls your personalized sound settings.

1

Press the **MENU** button to display the menu.

Press the **▲** or **▼** button to select the “Sound”, then press the **ENTER** button.

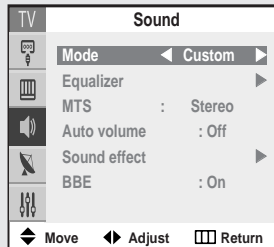

2

Press the **◀** or **▶** button to select the to select the “Standard”, “Music” “Movie”, “Speech” or “Custom” sound settings.

Press the **EXIT** button to exit the menu.

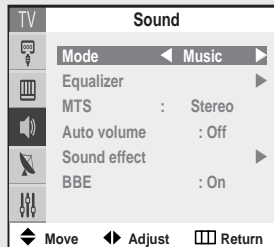

- Choose *Standard* for the standard factory settings.
- Choose *Music* when watching music videos or concerts.
- Choose *Movie* when watching movie.
- Choose *Speech* when watching a show that is mostly dialogue (i.e., news).
- Choose *Custom* to recall your personalized settings. (see “Customizing the Sound”, page 34).

Viewing an External Signal Source

Use the remote control to switch between viewing signals from connected equipment, such as VCRs, DVD, Set-Top Box and the TV source (broadcast or cable).

Setting the Signal Source

1

Press the **MENU** button to display menu, then press the **ENTER** button.

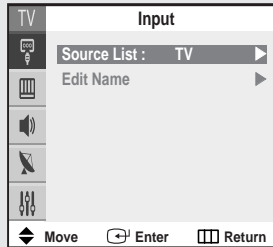

2

Press the **ENTER** button again. Press the **▲** or **▼** button to select signal source, then press the **ENTER** button.



Alternate method:

Simply press the **TV/VIDEO** or **TV/COMP.** button on the remote control to select an External Signal Source.

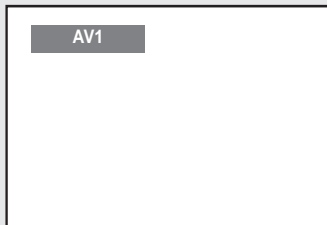

Assigning Names to External input mode

1
Press the **MENU** button to display menu, then press the **ENTER** button.

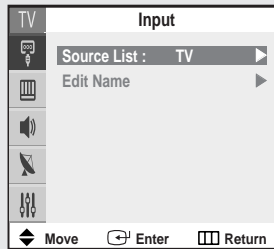

2
Press the **▲** or **▼** button to select the "Edit Name", then press the **ENTER** button.

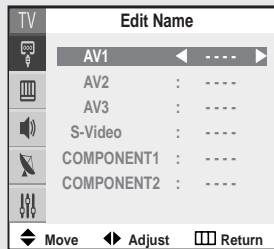

3
Press the **▲** or **▼** button to select the source list.

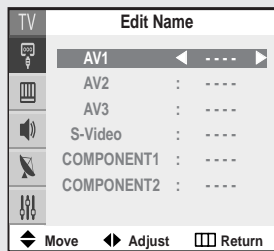

4
Press the **◀** or **▶** button to select external device (VCR, DVD, Cable STB, Sat. STB, AV Recv., DVD Recv., Game, Camcorder, DVD Combo).

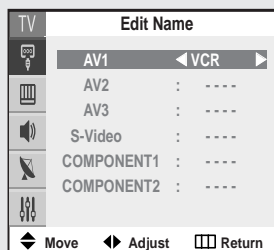

Set other signal sources (AV2, AV3, S-Video, COMPONENT1, COMPONENT2) using the same method as listed above.

Press the EXIT button to exit the menu.

Chapter Four

SPECIAL FEATURES

Fine Tuning Channels

Use fine tuning to manually adjust a particular channel for optional reception.

1

Press the **MENU** button to display the menu.

Press the **▲** or **▼** button to select "Channel", then press the **ENTER** button.

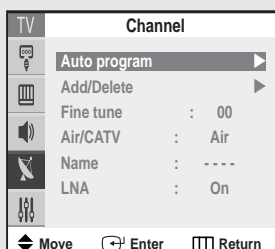

2

Press the **▲** or **▼** button to select "Fine tune".

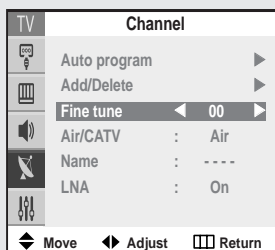

3

Press the **◀** or **▶** button to adjust the fine tuning.

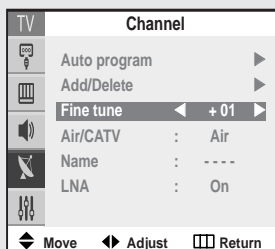

4

To store the fine tuning setting in the TV's memory, press the **▲** button. ("*" will appear).

To reset the fine tuning to "00", press the **▼** button.

Press the **EXIT** button to exit the menu.

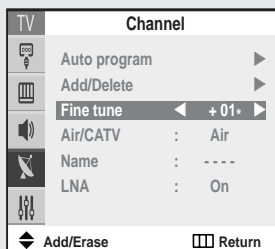

◀ After you adjust the fine tuning, "*" will appear when you press INFO while watching this channel.

LNA (Low Noise Amplifier)

When a weak broadcast signal causes unclear noisy picture the “LNA” feature improves the picture quality by setting to “On”. If you experience noise on a certain channel, set the “LNA” to “On” or “Off” for this channel, to obtain the optimum picture.

1

Press the **MENU** button to display the menu.

Press the **▲** or **▼** button to select “Channel”, then press the **ENTER** button.

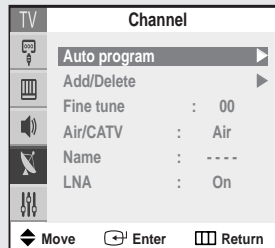

2

Press the **▲** or **▼** button to select “LNA”.

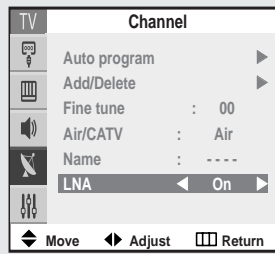

3

Press the **◀** or **▶** button to select “On” or “Off”.

Press the **EXIT** button to exit the menu.

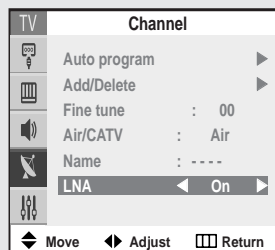

Changing the Color Tone

1

Press the **MENU** button to display the menu.

Press the **▲** or **▼** button to select "Picture", then press the **ENTER** button.

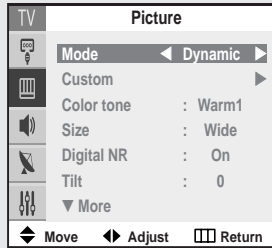

2

Press the **▲** or **▼** button to select "Color tone".

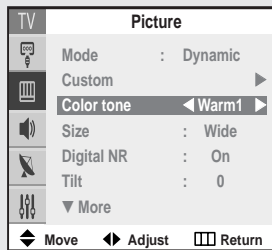

3

Press the **◀** or **▶** button to select "Cool2", "Cool1", "Normal", "Warm1" or "Warm2" according to personal preference.

Press the **EXIT** button to exit the menu.

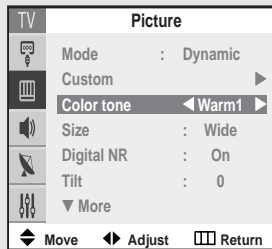

Changing the Screen Size

1

Press the **MENU** button to display the menu.

Press the **▲** or **▼** button to select "Picture", then press the **ENTER** button.

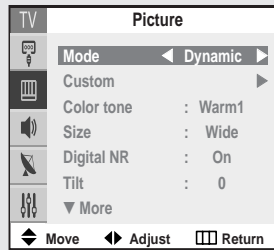

2

Press the **▲** or **▼** button to select "Size".

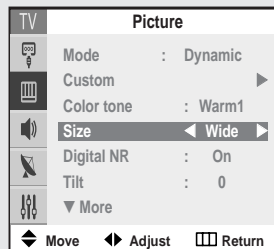

3

Press the **◀** or **▶** button to select "Wide", "Panorama", "Zoom1", "Zoom2", or "4:3".

Press the **EXIT** button to exit the menu.

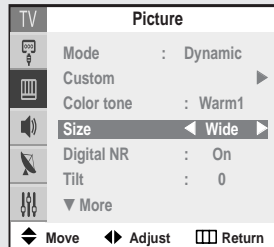

Alternate method:

Simply press the **P.SIZE** button on the remote control to change a screen size.



- **Wide:** Sets the picture to 16:9 wide mode.
- **Panorama:** Use this mode for the wide aspect ratio of a panoramic picture.
- **Zoom1:** Magnifies the size of the picture on screen.
You can also move the picture on screen using the **▲** or **▼** button on the remote control.
- **Zoom2:** Magnifies the size of the picture more than Zoom1.
You can also move the picture on screen using the **▲** or **▼** button on the remote control.
- **4:3:** Sets the picture to 4:3 normal mode.

Notes: Screen size cannot be changed in the PIP mode.

In the WISE LINK mode you can change the screen size in the 4:3 normal mode and 16:9 wide mode.

Digital Noise Reduction

If the broadcast signal received by your TV is weak, you can activate the Digital Noise Reduction feature to help reduce any static and ghosting that may appear on the screen.

1

Press the **MENU** button to display the menu.

Press the **▲** or **▼** button to select "Picture", then press the **ENTER** button.

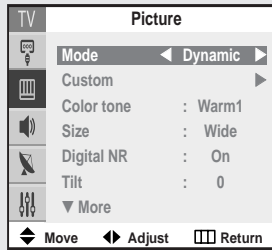

2

Press the **▲** or **▼** button to select "Digital NR".

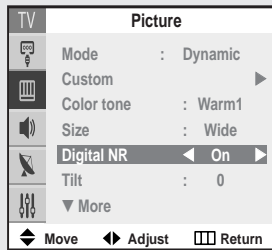

3

Press the **◀** or **▶** button to select "On" or "Off".

Press the **EXIT** button to exit the menu.

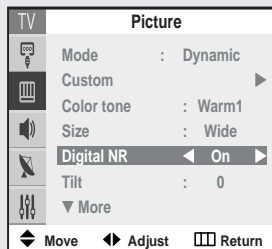

Tilt

Due to the Earth's magnetic field there may be some minor image tilt depending on the TV's location. When this occurs, follow the steps below.

1

Press the **MENU** button to display the menu.

Press the **▲** or **▼** button to select "Picture", then press the **ENTER** button.

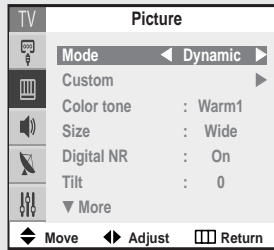

2

Press the **▲** or **▼** button to select "Tilt".

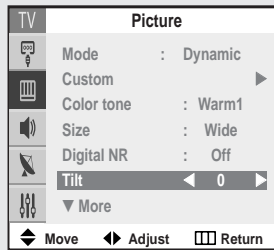

3

Press the **◀** or **▶** button to adjust the Tilt.

Press the **EXIT** button to exit the menu.

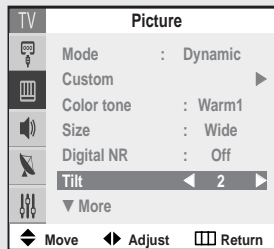

DNiE™ (Digital Natural Image engine) DNiE™

Samsung's New Technology enables an improved image with detail, contrast and white enhancement and 3D noise reduction.

1

Press the **MENU** button to display the menu.

Press the **▲** or **▼** button to select "Picture", then press the **ENTER** button.

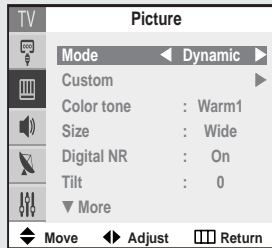

2

Press the **▲** or **▼** button to select "DNiE".

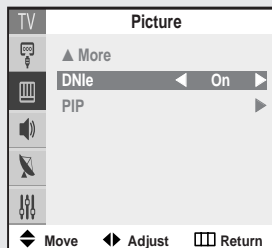

3

Press the **◀** or **▶** button to select DNiE "Off", "On" or "Demo".

Press the **EXIT** button to exit.

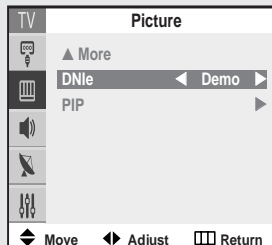

Alternate method:

Simply press the **DNiE** button on the remote control to change the DNiE mode.

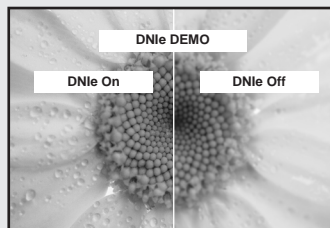

- On: Switches on the DNiE mode.
- Demo: The screen before applying DNiE appears on the right and the screen after applying DNiE appears on the left.
- Off: Switches off the DNiE mode.

Using the R.Surf Feature

This feature allows you to set the TV to return to a particular channel after a certain amount of time. For example, you may be watching a channel when commercials start. You can set the R.Surf to "5 minutes", then switch channels. After minutes, the TV will return to the original channel. To use the R.Surf feature:

1

While you are watching the channel to which you want to return, press the **R.SURF** button. The on-screen display will read "Surf off".



2

Press the **R.SURF** button again to set the timer in thirty second intervals, up to five minutes.



◀ The time will be decreasing while you are setting up the timer. And you will reset it when you pass five minutes or turn it off.

3

The time you set will begin counting down on the screen. When the time runs out, the TV will return to the channel you were watching when you set the timer.

Freezing the Picture

Press the **STILL** button to freeze a moving picture. (normal sound will still be heard.)

Press again to cancel.

◀ Note: The still function doesn't operate in the WISE LINK and COMPONENT mode.

Viewing Picture-in-Picture

You can use the PIP feature to simultaneously watch two video sources.

Note: When PIP is selected in the Panorama, Zoom1, Zoom2 or 4:3 mode, the Mode is automatically converted into the Wide mode.

Activating Picture-in-Picture

1

Press the **MENU** button to display the menu.

Press the **▲** or **▼** button to select "Picture", then press the **ENTER** button.

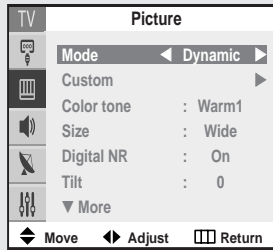

2

Press the **▲** or **▼** button to select "PIP", then press the **ENTER** button.

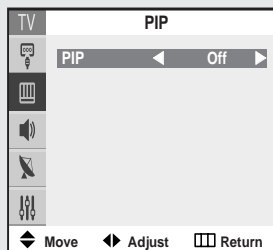

3

Press the **◀** or **▶** button to select PIP "On."

Press the **EXIT** button to exit the menu.

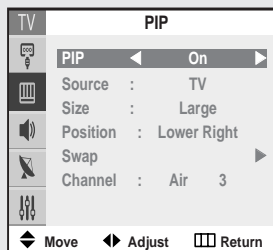

◀ If you turn TV off while watching and turn it on again, the PIP window will disappear.

Alternate method:

Simply press the **PIP** button on the remote control to select the PIP On.

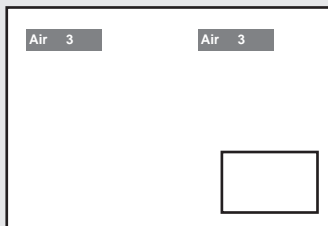

Selecting a Signal Source (External A/V) for PIP

1

Press the **MENU** button to display the menu.

Press the **▲** or **▼** button to select "Picture", then press the **ENTER** button.

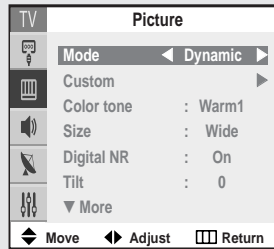

2

Press the **▲** or **▼** button to select "PIP", then press the **ENTER** button.

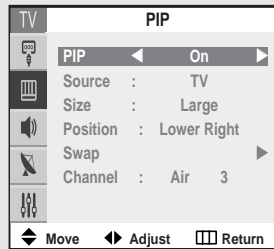

3

Press the **▲** or **▼** button to select "Source".

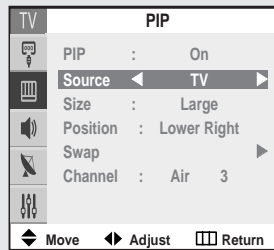

4

Press the **◀** or **▶** button repeatedly to cycle through all of the available signal sources: "TV", "AV1", "AV2" and "AV3".

Press the **EXIT** button to exit the menu.

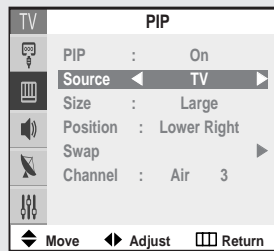

◀ For more information about external A/V components and signals, see "Viewing an External Signal Source" on page 39.

If you select "TV", the PIP image is the same as the main image.

Changing the Size of the PIP Window

1

Press the **MENU** button to display the menu.

Press the **▲** or **▼** button to select "Picture", then press the **ENTER** button.

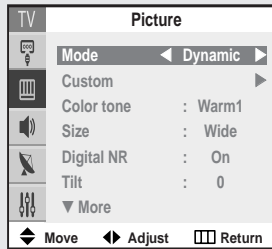

2

Press the **▲** or **▼** button to select "PIP", then press the **ENTER** button.

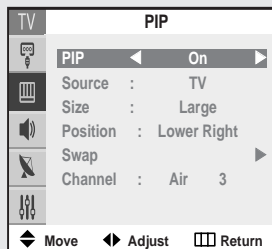

3

Press the **▲** or **▼** button to select "Size".

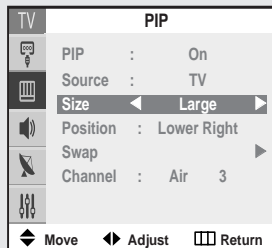

4

Press the **◀** or **▶** button repeatedly to select the "Double Window", "Large", "Small" or "Stock Ticker".

Press the **EXIT** button to exit the menu.

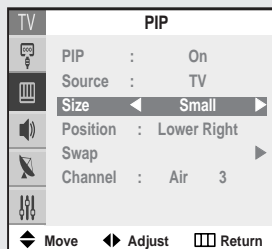

Alternate method:

Simply press the **SIZE(PIP)** button on the remote control to change a PIP screen size.

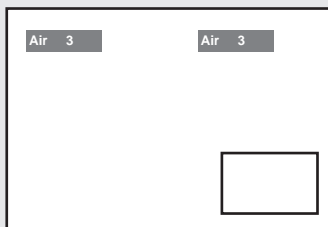

Changing the Position of the PIP Window

1

Press the **MENU** button to display the menu.

Press the **▲** or **▼** button to select "Picture", then press the **ENTER** button.

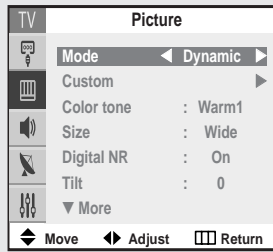

2

Press the **▲** or **▼** button to select "PIP", then press the **ENTER** button.

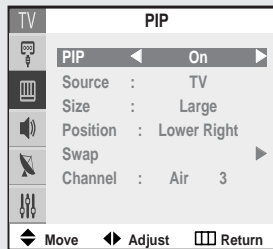

3

Press the **▲** or **▼** button to select "Position".

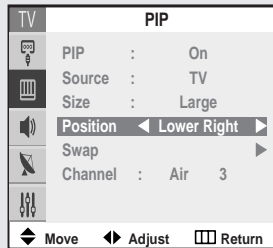

4

Press the **◀** or **▶** button repeatedly to select the required screen position.

Press the **EXIT** button to exit the menu.

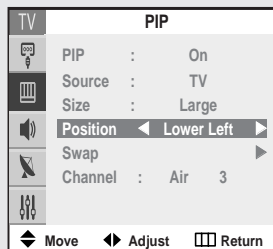

◀ The size Stock Ticker has the positions: Bottom, Top, Upper Center and Lower Center.

Swapping the Contents of the PIP image and Main image

1

Press the **MENU** button to display the menu.

Press the **▲** or **▼** button to select "Picture", then press the **ENTER** button.

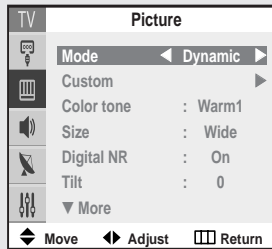

2

Press the **▲** or **▼** button to select "PIP", then press the **ENTER** button.

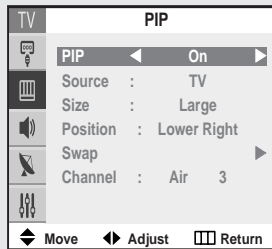

3

Press the **▲** or **▼** button to select "Swap".

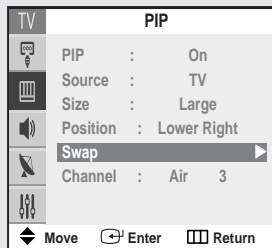

4

Press the **ENTER** button. The image in the PIP window will appear on the main screen, and vice versa.

Press the **EXIT** button to exit the menu.

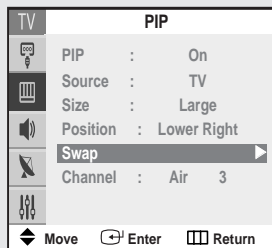

Alternate method:

Simply press the **SWAP** button on the remote control.

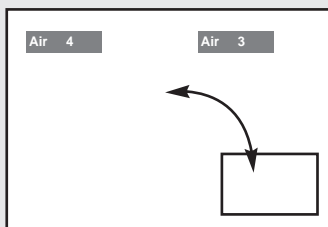

Changing the PIP Channel

1

Press the **MENU** button to display the menu.

Press the **▲** or **▼** button to select "Picture", then press the **ENTER** button.

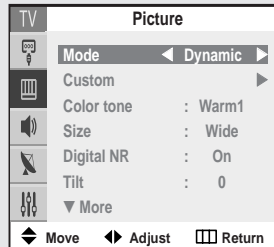

2

Press the **▲** or **▼** button to select "PIP", then press the **ENTER** button.

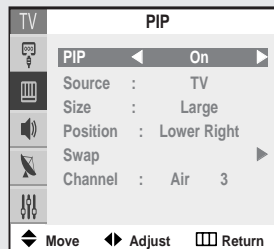

3

Press the **▲** or **▼** button to select "Channel".

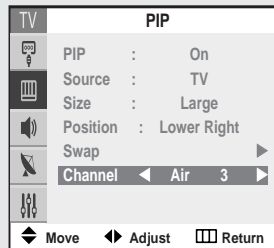

4

Press the **◀** or **▶** button to change the channel that appears in the PIP window.

Press the **EXIT** button to exit the menu.

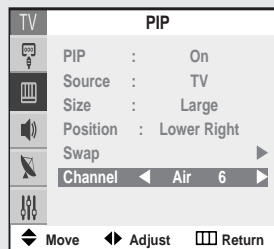

Alternate method:

Simply press the **CH(PIP)** button on the remote control.

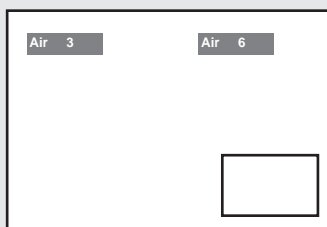

Choosing a Multi-Channel Sound (MTS) Soundtrack

Depending on the particular program being broadcast, you can listen to Stereo, Mono, or a Separate Audio Program. (SAP audio is usually a foreign-language translation. Sometimes SAP has unrelated information like news or weather.)

1

Press the **MENU** button to display the menu.

Press the **▲** or **▼** button to select the "Sound", then press the **ENTER** button.

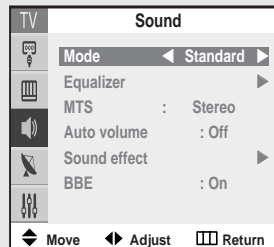

2

Press the **▲** or **▼** button to select "MTS".

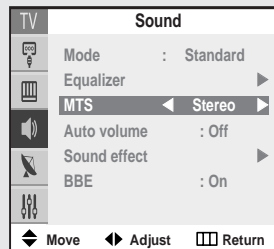

3

Press the **◀** or **▶** button to select "Mono", "Stereo" or "SAP".

Press the **EXIT** button to exit the menu.

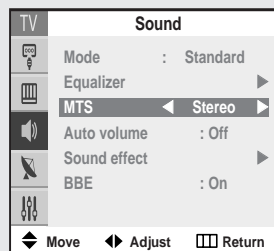

◀ The text at the bottom of the menu tells you if the incoming audio is Mono, Stereo or SAP.

Alternate method:

Simply press the **MTS** button on the remote control to select the MTS setting.

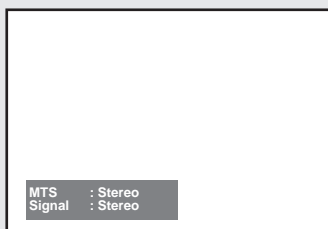

- Choose *Mono* for channels that are broadcasting in mono, or if you are having difficulty receiving a stereo signal.
- Choose *Stereo* for channels that are broadcasting in stereo.
- Choose *SAP* to listen to the Separate Audio Program, which is usually a foreign-language translation.

Adjusting the Volume Automatically

Each broadcasting station has its own signal conditions, which can make it necessary to adjust the volume every time the channel is changed. "Auto volume" lets you automatically adjust the volume of the desired channel by lowering the sound output when the modulation signal is high or by raising the sound output when the modulation signal is low.

1

Press the **MENU** button to display the menu.

Press the **▲** or **▼** button to select the "Sound", then press the **ENTER** button.

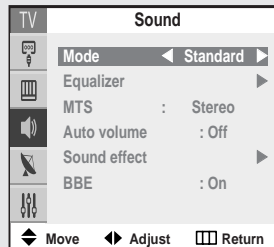

2

Press the **▲** or **▼** button to select "Auto volume".

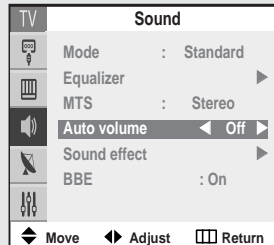

3

Press the **◀** or **▶** button to select "On" or "Off".

Press the **EXIT** button to exit the menu.

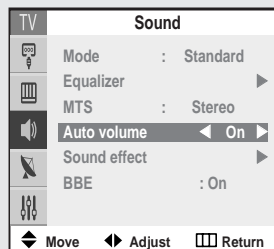

Setting the Surround

Your Samsung TV can create a "surround" effect such that the sound seems to come from all directions. Once the "Surround" is set to "On", the setting applies to sound effects such as Standard, Music, Movie and Speech.

1

Press the **MENU** button to display the menu.

Press the **▲** or **▼** button to select the "Sound", then press the **ENTER** button.

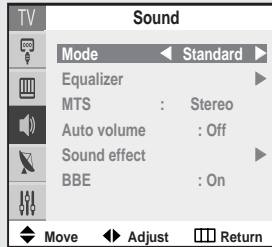

2

Press the **▲** or **▼** button to select "Sound effect" then press the **ENTER** button.

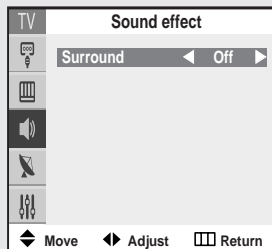

3

Press the **◀** or **▶** button to select "On" or "Off".

Press the **EXIT** button to exit the menu.

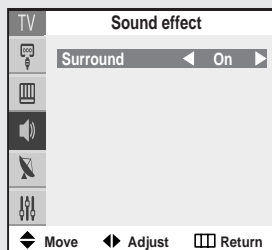

Setting the BBE

BBE is a built-in effect that adds clarity, punch and dynamics to the sound.

1

Press the **MENU** button to display the menu.

Press the **▲** or **▼** button to select the "Sound", then press the **ENTER** button.

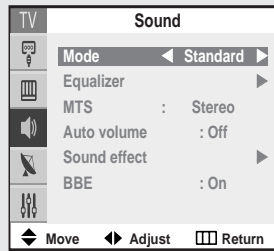

2

Press the **▲** or **▼** button to select "BBE".

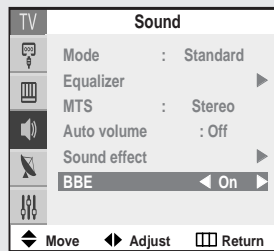

3

Press the **◀** or **▶** button to select "On" or "Off".

Press the **EXIT** button to exit the menu.

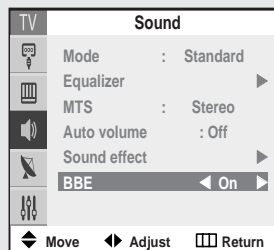

Setting the On/Off Timer

1

Press the **MENU** button to display the menu.

Press the **▲** or **▼** button to select "Setup", then press the **ENTER** button.

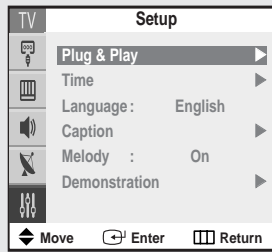

◀ Before using the timer, you must set the TV's clock. (See "Setting the Clock" on page 30).

When any of the timers are set, the "Timer" LED will illuminate (front panel of TV.)

2

Press the **▲** or **▼** button to select "Time", then press the **ENTER** button.

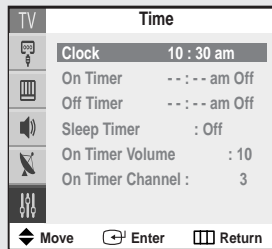

3

Press the **▲** or **▼** button to select "On Timer".

Press the **▶** button to select the hours. (The minutes digits will be highlighted.)

Press the **▲** or **▼** button repeatedly to select the appropriate hours (i.e., the hour when the TV will turn on.)

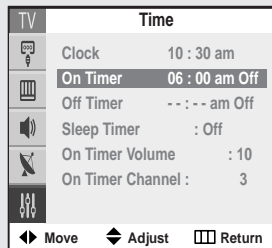

4

Press the **▶** button to select the minutes. (The minutes digits will be highlighted.)

Press the **▲** or **▼** button to select the appropriate minutes.

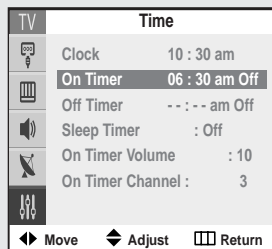

5

Press the **▶** button to select "On" or "Off".

Press the **▲** or **▼** button to turn the on-timer "On". (Repeatedly pressing the **▲** or **▼** button will alternate between "On" and "Off".)

When finished, press the **▶** button.

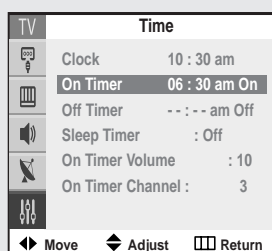

◀ To deactivate the "On Timer," select "Off" during this step.

6

To set the Off Timer, press the ▲ or ▼ button to select "Off Timer". Press the ► button and set the hours and minutes. (Follow the same procedure as in steps 3-5 above.)

When finished setting the timer, Press the EXIT button to exit the menu.

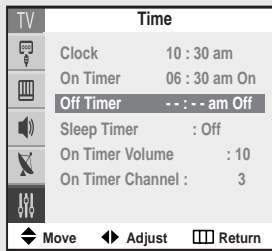

◀ **Absent Power Off**

When you set the timer "On", your television will eventually be turned off, if you do not operate any controls during the 3 hours after the TV is turned on by timer.

This function is available in only the timer "On" mode and will prevent a leakage accident or overheating, caused by your TV left on for a long time due to the timer "On" (when you are away on holiday, for example).

Setting the Sleep Timer

The sleep timer automatically shuts off the TV after a preset time (from 30 to 180 minutes).

1

Press the **MENU** button to display the menu.

Press the ▲ or ▼ button to select "Setup", then press the **ENTER** button.

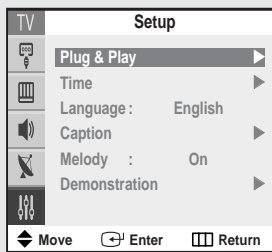

2

Press the ▲ or ▼ button to select "Time", then press the **ENTER** button.

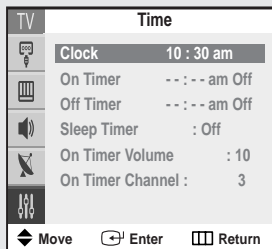

3

Press the ▲ or ▼ button to select "Sleep Timer".

Press the ◀ or ▶ button repeatedly until the appropriate time interval appears (any of the preset values from "Off" to "180"). Press the EXIT button to exit the menu.

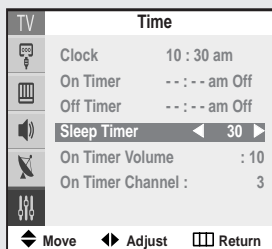

Alternate method:

Simply press the **SLEEP** button repeatedly until the appropriate time interval appears (any of the preset values from "Off" to "180").



◀ After about 5 seconds, the sleep display will disappear from the screen, and the time interval will be set.

Setting the Preferred Volume Level and Channel

The preferred volume and channel can be set for when the timer automatically turns on the TV.

1

Press the **MENU** button to display the menu.

Press the **▲** or **▼** button to select "Setup", then press the **ENTER** button.

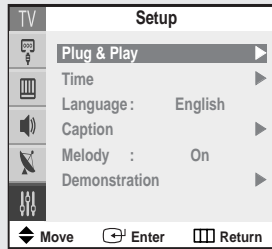

2

Press the **▲** or **▼** button to select "Time", then press the **ENTER** button.

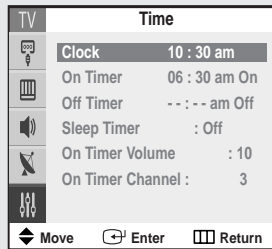

3

Press the **▲** or **▼** button to select "On Timer Volume".

Press the **◀** or **▶** button to adjust volume level.

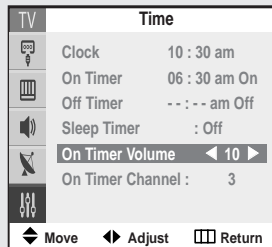

4

Press the **▲** or **▼** button to select "On Timer Channel".

Press the **◀** or **▶** button to select channel.

Press the **EXIT** button to exit the menu.

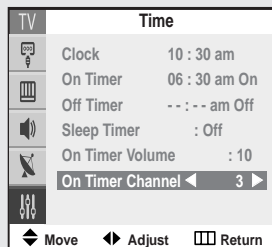

Viewing Closed Captions

Your TV decodes and displays the closed captions that are broadcast with certain TV shows. These captions are usually subtitles for the hearing impaired or foreign-language translations. All VCRs record the closed caption signal from television programs, so home-recorded video tapes also provide closed captions. Most pre-recorded commercial video tapes provide closed captions as well. Check for the closed caption symbol in your television schedule and on the tape's packaging: .

1

Press the **MENU** button to display the menu.

Press the **▲** or **▼** button to select the "Setup", then press the **ENTER** button.

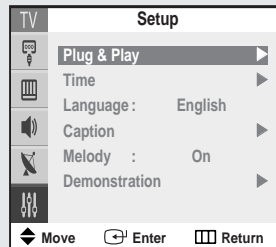

2

Press the **▲** or **▼** button to select the "Caption", then press the **ENTER** button.

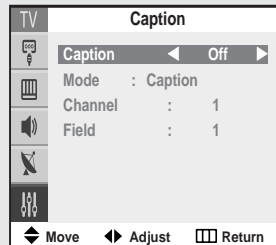

3

Press the **◀** or **▶** button to turn closed captioning "On" or "Off".

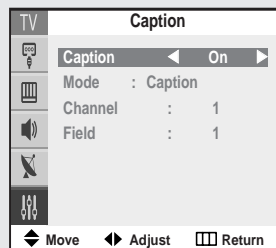

4

Press the **▲** or **▼** button to select "Mode", press the **◀** or **▶** button to select "Caption" or "Text".

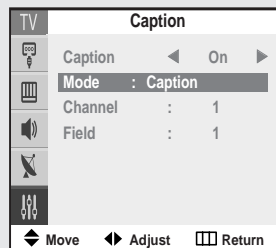

5

Depending on the particular broadcast, it might be necessary to make changes to "Channels" and "Field": Use the **▲**, **▼**, **◀** and **▶** buttons to make the changes. (Follow the same procedure as in steps 3-4 above.)

Press the **EXIT** button to exit the menu.

◀ Misspellings and unusual characters sometimes occur during closed caption transmissions, especially those of live events. There may be a small delay before captions appear when you change channels. These are not malfunctions of the TV.

◀ In "Caption" mode, captions appear at the bottom of the screen, and they usually cover only a small portion of the picture.

In "Text" mode, information unrelated to the program, such as news or weather, is displayed. Text often covers a large portion of the screen.

◀ Different channels and fields display different information: Field 2 carries additional information that supplements the information in Field 1. (For example, Channel 1 may have subtitles in English, while Channel 2 has subtitles in Spanish.)

Setting The On/Off Melody

You can hear clear a melody sound when the TV is powered On or Off.

1

Press the **MENU** button to display the menu.

Press the **▲** or **▼** button to select the "Setup", then press the **ENTER** button.

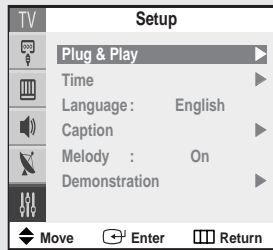

2

Press the **▲** or **▼** button to select "Melody".

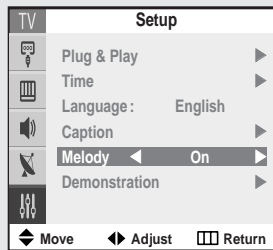

3

Press the **◀** or **▶** button to select "On", then press the **ENTER** button.

Press the **EXIT** button to exit the menu.

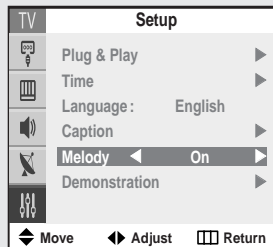

Viewing the Demonstration

To become familiar with the various menus provided by your television, you can view the in built demonstration.

1

Press the **MENU** button to display the menu.

Press the **▲** or **▼** button to select the "Setup", then press the **ENTER** button.

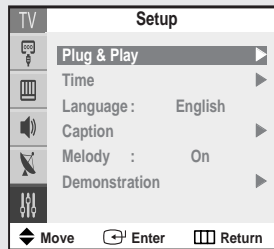

2

Press the **▲** or **▼** button to select "Demonstration", then press the **ENTER** button.

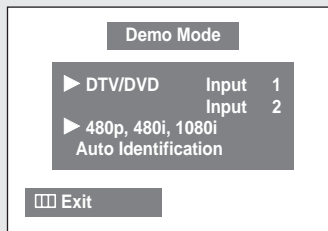

3

Each of the menu options is displayed in turn.

When you wish to stop the demonstration, press the **MENU** button on the remote control.

Press the **EXIT** button to exit the menu.

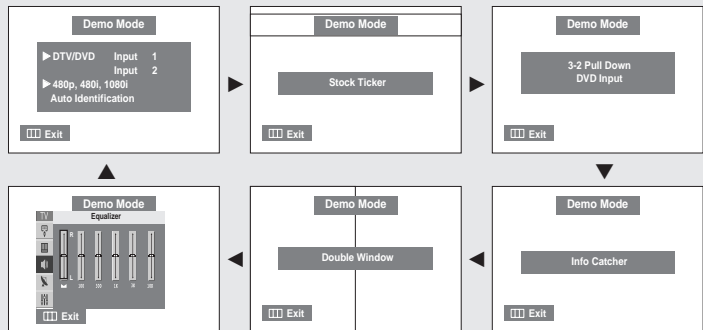

Using WISE LINK

WISE LINK is used to play JPEG files (*.jpg) and MP3 files (*.MP3) stored in the memory card on the TV.

What is a Memory Card?

A memory card is an auxiliary storage device used in AV equipment to exchange data between devices. It is mainly used in digital cameras, digital camcorders, MP3 players, notebooks and PDAs.

Memory Cards Available in WISE LINK

You can use CF (Compact Flash), SMC (Smart Media Card), SD (Secure Digital), MMC (Multi Media Card), and MS (Memory Stick) in the four WISE LINK slots. Confirm the card type and proper insertion direction before you insert a memory card. The correct card type is listed for each slot.



Compact Flash I



Multimedia Card
(MMC)



Memory Stick



Secure Digital Card
(SD Card)



Smart Media Card

Notes: Memory Stick Pro and Memory Stick Duo are not supported.

There are different slot configurations for Compact Flash Type I and II. This product supports CF Type I.

- How to Insert a Memory Card
Gently push the memory card into the slot. If the card is not inserted completely, it will not work.
Insert the card in the direction indicated on the memory card.
Note: Do not apply excessive force while inserting the card.
- How to Eject a Memory Card
Holding the tip of the card, gently pull it out.

Cautions on Memory Card Use

- Data can be damaged when a memory card is used in the presence of static electricity and/or electronic noise.
- Data can be damaged when a memory card is repeatedly inserted and ejected.
- Play speed may differ depending on the card type.
- Do not attach anything but a label in the proper place.
- Be careful to attach the label only within the proper space.
- Be careful not to make contact between the memory card terminal and metal objects.
- Do not strike, bend or drop the memory card.
- Do not dismantle or tinker with the memory card.
- Be careful to keep the memory card dry.

Cautions on using WISE LINK Mode

- Do not insert foreign objects into the slot.
- Insert the memory card in the proper direction
- Do not remove the memory card when it is in use.
- The manufacturer's responsibility does not include damaged data. (Be careful not to corrupt data and be sure to back up files.)
- Use the slot cover so that dust and foreign objects cannot enter the slot when WISE LINK is not in use.

Initialization of WISE LINK Mode

Errors can occur in WISE LINK mode because of the various memory card types, the various manufacturers and the type of data stored. When an error occurs, please initialize WISE LINK as follows:

Method1: Press the W.LINK button on the transmitter for about 2 seconds to initialize WISE LINK. During Initialization, there will be no display for about 3 seconds.

Method2: After pressing the W.LINK button to switch into TV mode, press the W.LINK button again to return to Wise LINK mode. Initialization is now finished.

Files supported by WISE LINK

File Type	JPEG Image (*.jpg)	MP3 Files (*.mp3)
File Size	JPEG images are classified into standard JPEG and progressive JPEG. <ul style="list-style-type: none"> • Standard JPEG: Files with less than 5 million pixels. • Progressive JPEG: Files with less than 2 million pixels. 	No limit to file sizes. MP3 files may not play depending on the data transfer rate. <ul style="list-style-type: none"> • Data Transfer Rate: Files from 56 Kbps through 192 Kbps will run.
Compatibility	Still Image Files with (*.jpg) Extension	Music Files with the (*.mp3) Extension
Supported Memory Card Sizes	<ul style="list-style-type: none"> • CF: 512MBytes • MS: 128MBytes • MMC&SD: 512MBytes • SMC: 128Mbytes An error can take place if a higher capacity memory card is used.	
Data Copying	When you use a memory card reader to copy data on your home computer, follow the normal procedures. If you do not follow the proper procedures and erroneously copy data, the data will not run in WISE LINK.	
Formatting the Memory Card	If you format the memory card on your computer, an error can occur in other digital devices with the formatted card. You should only format the memory card in the digital equipment using the memory card.	
Unsupported and Erroneous Files	For unsupported and erroneous JPEG/MP3 files, "The file is not supported." will be displayed. Do not rename unsupported files with file extensions that are supported. It may cause errors.	

Switching to WISE LINK Mode

1

Press the **MENU** button to display menu, then press the **ENTER** button.

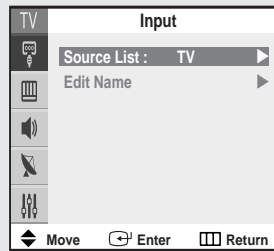

2

Press the **ENTER** button to select "Source List".

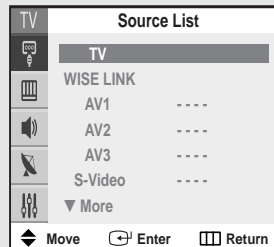

3

Press the **▲** or **▼** button to select "WISE LINK"; then press the **ENTER** button. The WISE LINK menu is displayed.

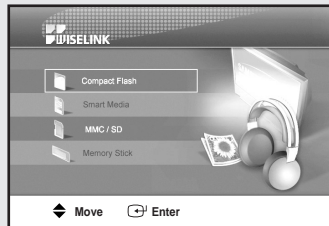

Alternate method:

Simply press the W.LINK button. WISE LINK mode is activated. If you press the button again, it switches back to TV mode.

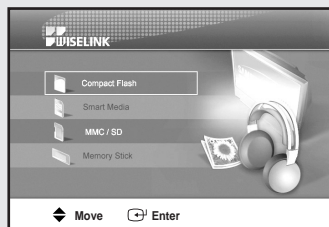

Selecting Image (JPEG) Files/Music (MP3) Files

1
Press the W.LINK button.

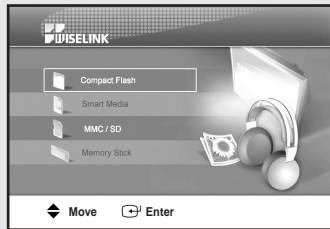

2
Press the ▲ or ▼ button to select which memory card to run and then press the ENTER button.



3
Press the ◀ or ▶ button to select the file type to run and then press the ENTER button.



Notes

- While making a selection, information about the selected file is displayed on the right side of the screen.
- When no card is inserted, "Please Insert Card." will be displayed.
- When a new card is inserted or the inserted card is loose, the memory card selecting screen will automatically open.
- When any card other than the memory card currently in use becomes loose, (⊗) will be displayed at the top of the screen.
- A maximum of one thousand files can be displayed.
- JPEG/MP3 file names are displayed in English only.
- Images edited by JPEG editors (for example: Photoshop or Paintshop) may not appear normal.

Picture (JPEG) Playback

JPEG file format is supported.

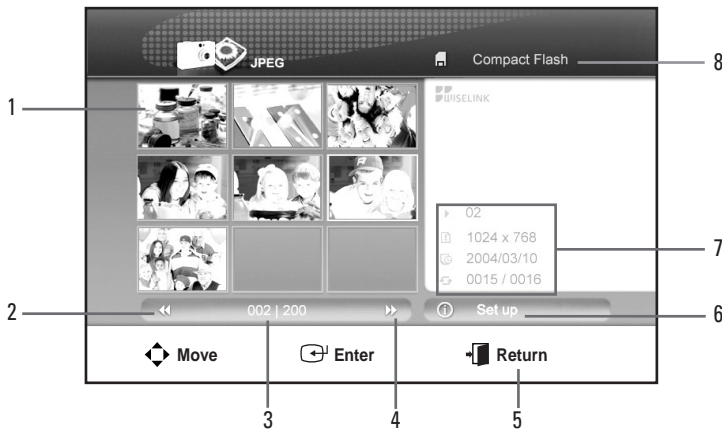

1. Press the (▲▼◀▶) button to move to the desired file and select it. Press the ENTER button and a full page image will be displayed.
 2. Press the (◀◀) button to move to the previous page.
 3. The current page number out of the total pages is displayed.
 4. Press the (▶▶) button to move to the next page.
 5. Press the EXIT button to return to the previous menu.
 6. Press the INFO button to move to the WISE LINK Menu Setup. (See page 71.)
 7. The title, resolution, creation date and number (current file number / total file number) for the selected image file will be displayed.
 8. The selected memory card type is displayed.
- Press the PLAY/PAUSE button to start the slide show beginning with the selected image.

Notes

- When a JPEG file is displayed full page, the right/left and/or upper/lower parts of the image may appear black or the image may not be located in the center in the following situations:
 - 1) When the picture is smaller than 640 x 480.
 - 2) When the width : length proportion of the picture is not 4:3.
 - 3) When those same parts of the original picture are black
- When a JPEG file is displayed full page or enlarged, the four edges may not be displayed.
- This is because the picture tube display of the TV does not expose the four edges of any image as to reduce the viewer's inconvenience during a screen fluctuation caused by power supply or signal changes.
- The small pictures in the list of JPEG files may appear slightly different from the full-page pictures.
- If you press the MOVE button before all the pictures are displayed, the icon (⏸) appears.
- When viewing still images or pausing a slide show, a screen saver will become active after a set period of time.

Rotating the Picture (JPEG)

1

Press the ENTER button while viewing the full page image. The help menu is displayed in the lower part of the screen.

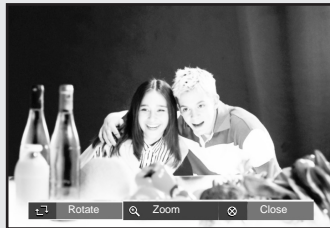

2

Press the ◀ or ▶ button to select "Rotate", then press the ENTER button.

In order to display the full image on the screen, the picture size will automatically change depending on the rotational angles (90 and 270 degrees).

When rotating the picture, the rotated image will be displayed in the JPEG file list. An enlarged image cannot be rotated.

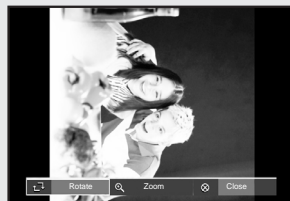

90 degrees



180 degrees

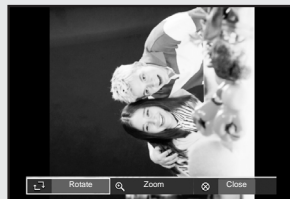

270 degrees

Alternate method:

Simply press the ROTATE button to rotate images 90, 180, 270 and 360 degrees clockwise.

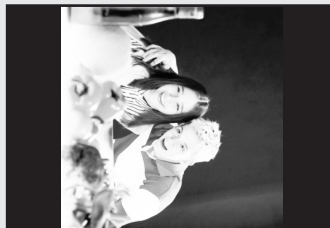

Picture Zoom (JPEG)

1

Press the ENTER button while viewing the full page image. The help menu is displayed in the lower part of the screen.

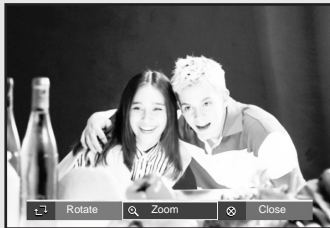

2

Press the ◀ or ▶ button to select "Zoom", then press the ENTER button.

When you press the ENTER Enlarge1 (🔍), Enlarge2 (🔍⁺) and Normal (🔍◼) will be selected in sequence.

You can use the ▲/▼/◀/▶ buttons to move the enlarged picture. When you move the enlarged picture, the edges of the original picture may not be displayed.

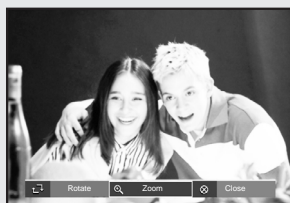

🔍 (Enlarge 1)

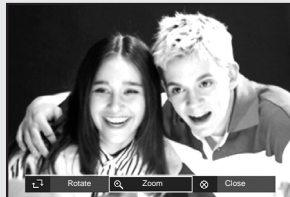

🔍⁺ (Enlarge 2)

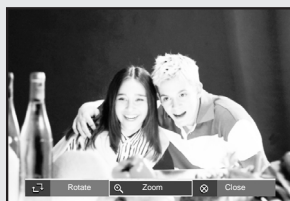

🔍◼ (No Enlarge)

Alternate method:

Simply press the ZOOM button. When you press the ZOOM Enlarge1 (🔍), Enlarge2 (🔍⁺) and Normal (🔍◼) will be selected in sequence.



Music File (MP3) Playback

MP3 file format is supported.

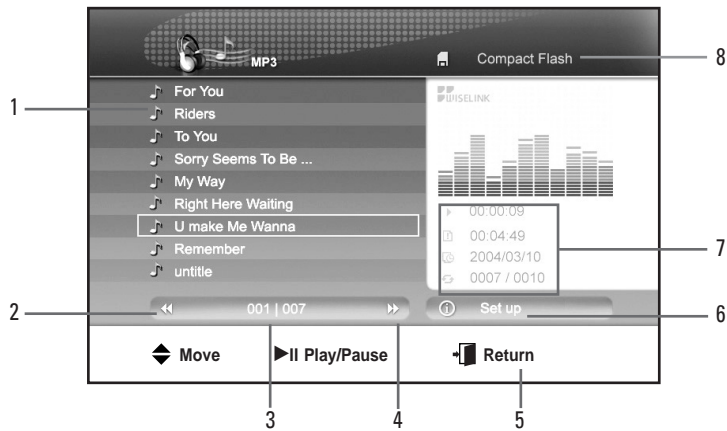

1. Press the ▲ or ▼ button to move to a desired file and it will automatically play.
2. Press the ◀◀ button to move to the previous page.
3. The active page is displayed.
4. Press the ▶▶ button to move to the next page.
5. Press the EXIT button to move to the previous menu.
6. Press the INFO button to move to the WISE LINK setup menu. (Refer to page 71.)
7. The elapsed time, total playback time, creation date and number (current file number / total file number) for the selected file will be displayed.
8. The selected memory card type is displayed.
Press the PLAY/PAUSE button to play or pause the file.

Notes

- Play time and total running time of VBR MP3 files will not be displayed.
- The screen saver will become active after a set period of time whether the music is stopped or paused.

Playback All JPEG/MP3 Files

JPEG/MP3 files are displayed.

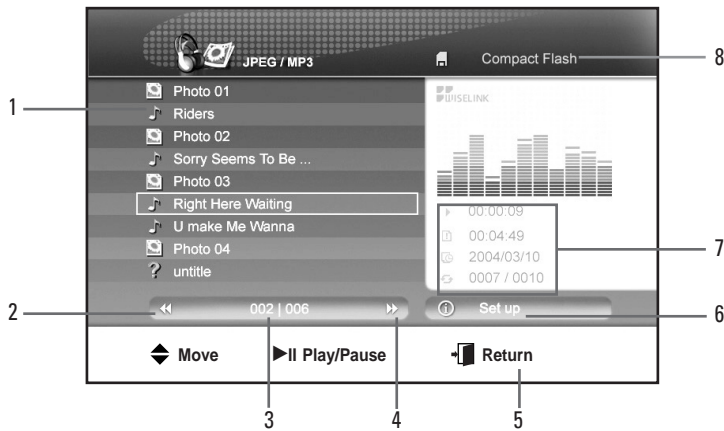

- | | |
|--|---|
| <ol style="list-style-type: none"> 1. Please see pages 66 and 69 on how to playback JPEG & MP3 files. 2. Press the ◀◀ button to move to the previous page. 3. The active page is displayed. 4. Press the ▶▶ button to move to the next page. | <ol style="list-style-type: none"> 5. Press the EXIT button to return to the previous menu. 6. Press the INFO button to move to the WISE LINK Setup Menu. (See page 81.) 7. The information for the current file is displayed. 8. The selected memory card type is displayed. |
|--|---|

Notes

- The file manager may show other files in addition to JPEG/MP3 files, but they cannot be run. “The file type is not supported” will be displayed.
- You cannot select “Music Repeat” in the file list. When a piece of music is finished, it stops.

WISE LINK Menu Setup

You can set various functions in WISE LINK mode.

1

Press the INFO button while in WISE LINK Setup mode. WISE LINK Setup mode is displayed.

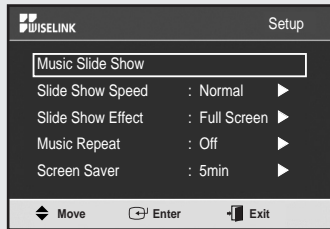

2

Press the ▲ or ▼ button to select the desired sub-menu, then press the ENTER button.

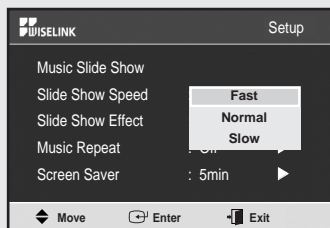

3

Press the ▲ or ▼ button to select the desired sub-menu, then press the ENTER button.

Press the EXIT button to exit the menu.

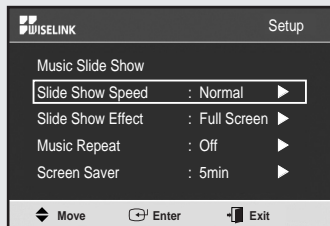

Note

- Turning off the TV set or switching to another mode during setup will cancel your settings. The WISE LINK settings will revert to the previously memorized settings.

continued...

Music Slide Show

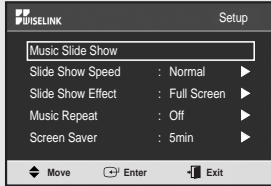

- Music plays while the pictures are displayed in sequence.
- Music Slide Show does not work in either Card Selection mode or File Type Selection mode.
- If there are no JPEG files or MP3 files in the folder, Music Slide Show will not run.
- During the Music Slide Show, only the PLAY/PAUSE, EXIT and STOP buttons are available.
- Only the files in the same folder can be played when you run a file from the JPEG/MP3 file folder.

Slide Show Speed

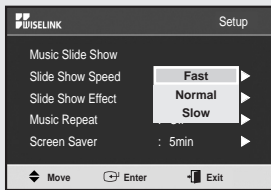

You can set the Time per Picture when the slide show starts.

- Fast: Pictures change every three seconds.
- Normal: Pictures change every five seconds.
- Slow: Pictures change every ten seconds.

Slide Show Effects

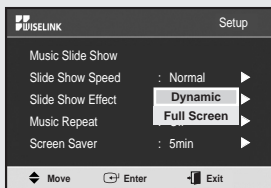

During the slide show, you can select the Slide Show Effects to display using the remote control.

- Dynamic: Pictures appear from various directions.
- Full Screen: Stops the Slide Show Effects.

Music Repeat

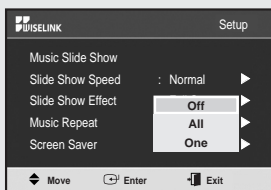

You can set the music to repeat.

- Off: MP3 files stop after playing the folder play in sequence.
- All: All the files within the folder play in sequence and repeat.
- One: The file currently playing repeats.

Screen Saver

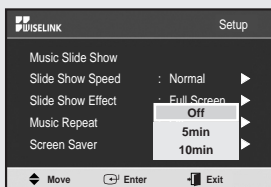

A screen saver is provided to prologue the life of the Screen.

- Off: Stops the screen saver.
- 5 min: The screen saver automatically turns on if no button is pressed within five minutes.
- 10 min: The screen saver automatically turns on if no button is pressed within ten minutes.

Notes

- When Music Repeat is set to OFF, the Music Slide Show repeats all the music.
- The PAUSE button will toggle between the following (during Music Slide Show): Picture Pause → Picture/Music Pause → Release Pause (Play).
- When Music Slide Show is on, Picture Pause and Picture/Music Pause will be released after five minutes in order to protect the CRT.
- VBR (Variable Bit Rate) MP3 files will not be played in order to ensure the stable operation of the slide show.

Customizing Your Remote Control

Your TV comes equipped with a universal remote control. In addition to controlling the TV, the universal remote control can also operate a Set-Top Box, VCR, Cable box and DVD (even if your VCR, Cable box and DVD are made by manufacturers other than Samsung).

- The remote control might not be compatible with all VCRs, DVD players and Cable boxes.

Setting Up Your Remote Control to Operate Your VCR (Cable box or DVD player)

1

Turn off your VCR (Cable box or DVD player).

2

Press the **MODE** button and make sure that the **VCR (CABLE or DVD)** LED is illuminated.

◀ The remote control has five modes: **TV**, **STB**, **VCR**, **CABLE** and **DVD**.

3

On your Samsung remote control, press the **SET** button.

4

Enter 3 digits of the VCR (Cable box or DVD player) code listed on next page for your brand of VCR (Cable box or DVD player).

◀ Make sure you enter 3 digits of the code, even if the first digit is a "0". (If more than one code listed, try the first one.)

5

Press the **POWER** button on the remote control. Your VCR (Cable box or DVD player) should turn on. If your VCR (Cable box or DVD player) turns on, your remote control is now set correctly.

◀ If your VCR (Cable box or DVD player) does not turn on, repeat steps 2, 3, and 4, but try one of the other codes listed for the brand of your particular VCR (Cable box or DVD player).

6

Once your remote control is set up, press the **MODE** button any time you want to use the remote to operate your VCR (Cable box or DVD player).

- When your remote is in the **TV** mode, the VCR (or DVD player) control buttons (**REW**, **STOP**, **PLAY/PAUSE** and **FF**) will still operate your VCR (or DVD player).
- When your remote control is in the **VCR (CABLE or DVD)** mode, the volume buttons still control your TV's volume.

SPECIAL FEATURES

Remote Control Codes

VCR Codes

000	Samsung	018	Candle, Citizen, Emerson, LG(Goldstar), Radio Shack, Realistic, Sears, Tashiko, Teknika, Totevision	036	Electrohome, Emerson, Radio Shack, Realistic, Sharp	059	Pioneer
001	LG(Goldstar)			037	RCA	060	JC Penny
002				038	Magnavox, Marantz, Philco, Philips, Sylvania	061	Candle, Citizen, Portland
003		019	Broksonic, Emerson	039	JC Penny, JCL, Kenwood, Marantz, NEC, Tatung, Teac	062	Canon, Curtis Mathes, General Electric, JC Penny, Magnavox, Panasonic, Philco, Radio Shack, Realistic, Sylvania
004	Daewoo	021	Craig, Fisher, Radio Shack, Realistic, Sanyo, Sears	040	Logik, Multitech, Shintom	063	RCA
005				041	General Electric, Multitech, Samsung	064	Shintom
006				042	Pioneer	065	Magnavox, Philco, Sylvania
007	Daewoo, LG(Goldstar)	022	Audio Dynamics, Candle, Citizen, Daewoo, Emerson, Samsung, Scott, Toshiba	043	Emerson	066	Emerson
008	Daewoo			044	Hitachi, JC Penny, Pentax, RCA, Sears	067	Fisher
009	Curtis Mathes, Dimensia, General Electric, PROSCAN, RCA	023	Colortyme, Curtis Mathes, DB, LG(Goldstar), Harman Kardon, JC Penny, JCL, Kenwood, Marantz, NEC	045	Hitachi	069	LG(Goldstar)
011	Bell & Howell, Fisher, JC Penny, JCL, Kenwood, Marantz, NEC, Quartz, Radio Shack, Realistic, Sanyo, Sears, Tandy	024	Aiwa, Curtis Mathes, Dynatech, Emerson, Funai, Hitachi, Lloyd, LXI, MTC, Multitech, Radio Shack, Realistic, Signature, Sylvania, Symphonic, Tandy, Teac, Teknika	046	RCA	070	Marantz, NEC
014	Hitachi, JC Penny, Pentax, Pioneer, RCA, Sears, Toshiba			047	Sony	071	Emerson
015	Admiral, Optimus, Radio Shack, Realistic, Sharp	025	Audio Dynamics, DB, JC Penny, JCL, Kenwood, Marantz, NEC, Pioneer, Sansui	048	Sharp	073	Curtis Mathes, NEC
016	Candle, Citizen, Craig, Curtis Mathes, General Electric, Go Video, JC Penny, MTC, Multitech, RCA, Samsung, Totevision			050	Emerson, Scott	074	Emerson
017	Canon, Curtis Mathes, Emerson, General Electric, Instant Replay, JC Penny, JCL, Magnavox, Marantz, Panasonic, Philco, Philips, Quasar, Radio Shack, Realistic, RCA, Sylvania, Technics, Teknika	026	Akai, Shintom, Sony	051	Emerson, Samsung	076	Curtis Mathes, Emerson, TMK
		027	Fisher, Sears	052	Fisher, Radio Shack, Realistic, Sears	077	Emerson, Scott
		028	Fisher, Radio Shack, Realistic, Sears, Toshiba	053	Portland, Quasar	078	RCA, Teac
		029	Emerson	054	Candle, Citizen, Daewoo, Portland, Sharp	079	Emerson
		030	Teknika	055	Candle, Citizen, Curtis Mathes, LG(Goldstar), JCL, Kenwood, Marantz, NEC, Pentex Research+	082	KLH
		031	Akai, Samsung	056	Emerson	084	Panasonic
		032	Akai, Emerson	057	Fisher, Sears, Toshiba	085	Daewoo
		035	Shintom, Sony	058	Emerson, Scott, Toshiba	086	Panasonic
						088	Admiral

Cable Box Codes

000	Samsung	020	Eastern International, Hamlin, Regal	038	GI, Jerrold	057	Tocom
001	Nawoo			039	Unika	058	
002	TaePyungYang	021	Hamlin, Regal	040	Magnavox, Philips, Unika, Viewstar	059	Universal
003	DeaRyung	022	Zenith			060	
004	DongKuk	023	GI, Jerrold	041	Magnavox, Philips, Regency, Viewstar	063	Tocom
005	DaeHan	024	Oak, Osk Sigma			065	Zenith
006	LG(Goldstar)	025	Tocom	042	Hamlin	066	Stargate 2000
007	Saewoo	026	Pioneer	044	GI, Jerrold	067	Sylvania, Texscan
008	RCA	027	Magnavox, Philips, Viewstar	045	Hitachi, Maccom	069	Panasonic, Zenith
010	Regency	028	Pioneer	046	Oak	070	Jerrold
011	Hamlin, Panasonic, Regal, Samsung	029	Magnavox, Philips, Tocom, Viewstar	047	Panasonic	071	
012	GI, Hamlin, Jerrold	030	Samsung	048	Magnavox, Philips, Viewstar	072	Samsung
013	GI, Jerrold	031		049	Magnavox, Philips, Unika, Viewstar	073	Jerrold
015	Anvision, Cable Star, Eagle, Magnavox, Philips, Randtek, Viewstar	032	GI, Jerrold			074	RCA
016		033		050	Zenith	075	
		034	Magnavox, Philips, Viewstar	051	Hitachi, Maccom	076	GI
017	NSC	035	RCA, Panasonic, Sprucer	052	Pioneer, Samsung, Warner Amex	077	
019	Sylvania, Texscan	036	Magnavox, Philips, Viewstar	054	General Instrument, Hitachi, Jerrold, Signature, Starcom		
		037		056	Hamlin		

DVD Codes

000	Samsung	003	JVC	006	Panasonic	009	Curtis Mathes
001	LG(Goldstar)	004	Sony	007	Philips		
002	Toshiba	005	Sharp	008	PROSCAN, RCA		

Chapter Five

TROUBLESHOOTING

If the TV seems to have a problem, first try this list of possible problems and solutions. If none of these troubleshooting tips apply, then call your nearest service center.

Identifying Problems

Problem	Possible Solution
Poor picture	Try another channel. Adjust the antenna. Check all wire connections.
Poor sound quality.	Try another channel. Adjust the antenna.
No picture or sound.	Try another channel. Press the TV/VIDEO button. Make sure the TV is plugged in. Check the antenna connections.
No color, wrong colors or tints.	Make sure the program is broadcast in color. Adjust the picture settings. If the set is moved or turned in a different direction, the power should be OFF for at least 30 minutes.
Picture rolls vertically.	Adjust the antenna. Check all wire connections.
The TV operates erratically	Unplug the TV for 30 seconds, then try operating it again.
Your remote control does not operate your TV.	Press the "MODE" button to put your remote control in the "TV" mode.
The TV won't turn on.	Make sure the wall outlet is working.
Image or Music Files do not play back.	Please check the original files. There may be errors in the original files.
The image appears in mosaic at first.	It is typical for a Progressive JPEG. It will automatically become normal after a short period of time.
Each picture or slide has a different running time.	The processing time may be different depending on the memory card type or the picture size.
The memory card is not recognized.	Check if it is supported in WISE LINK mode. Check if the card is inserted all the way. The reading time may differ depending on the card capacity and type. Please give it a moment. Check if the memory card is normal. A memory card which has been formatted on a computer may not work in AV devices.
The volume changes while music is played.	Check the original file. The manufacturers may randomly set the volume when they create MP3 files.
There is a blank screen when switching to WISE LINK.	Check if the inserted memory card is normal.

Cleaning and Maintaining Your TV

With proper care, your TV unit will give you many years of service. Please follow these guidelines to get the maximum performance from your TV.

Placement

- Do not place the TV near extremely hot, cold, humid or dusty places.
- Do not place the TV near appliances with electric motors that create magnetic fields, such as vacuum cleaners.
- Keep the ventilation openings clear; do not place the TV on a soft surface, such as cloth or paper.
- Place the TV in a vertical position only.

Liquids

- Do not handle liquids near or on the TV. Liquids that spill into it can cause serious damage.

Cabinet

- Never open the cabinet or touch the parts inside.
- Wipe your TV with a clean, dry cloth. Never use water, cleaning fluids, wax, or chemicals.
- Do not put heavy objects on top of the cabinet.

Temperature

- If your TV is suddenly moved from a cold to a warm place, unplug the power cord, and allow at least two hours for moisture that may have formed inside the unit to dry completely.

Using Your TV in Another Country

If you plan to take your TV with you to a foreign country, please be aware of the different television systems that are in use around the world. A TV designed for one system may not work properly with another system due to differences in the TV channel frequencies.

Specifications

Model	CL28A20HE	CL32A20HE
Voltage	AC100-240 V	AC100-240V
Frequency of Operation	50/60 Hz	50/60 Hz
Dimensions (mm/inches)	800 X 550 X 505/ 31.49 X 21.65 X 19.88	880 X 597 X 555/ 34.64 X 23.50 X 21.85
Weight (Kg/ lbs)	40.5/89.28	55.5/122.35

MEMO

MEMO

MEMO



Printed in Mexico
AA68-03472A-00

Free Manuals Download Website

<http://myh66.com>

<http://usermanuals.us>

<http://www.somanuals.com>

<http://www.4manuals.cc>

<http://www.manual-lib.com>

<http://www.404manual.com>

<http://www.luxmanual.com>

<http://aubethermostatmanual.com>

Golf course search by state

<http://golfingnear.com>

Email search by domain

<http://emailbydomain.com>

Auto manuals search

<http://auto.somanuals.com>

TV manuals search

<http://tv.somanuals.com>