

SAMSUNG



High Resolution Day & Night Varifocal Lens Camera SOC-4160 User Guide

Before installing and operating this product,
please read this manual thoroughly.

Before operating the camera, confirm the camera model and correct input power voltage. In order to that you can understand this manual thoroughly, we will explain the model description.

■ **SOC-4160 SERIES**

- NTSC MODEL
SOC-4160N

- PAL MODEL
SOC-4160P

■ **MODEL DESCRIPTION**

- SOC-4160 X



- SIGNAL SYSTEM

- N --> NTSC MODEL
- P --> PAL MODEL

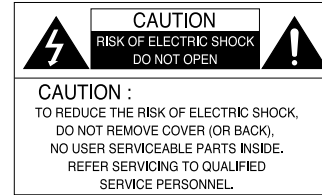

The lightning flash with an arrowhead symbol, within an equilateral triangle is intended to alert the user to the presence of uninsulated "dangerous voltage" within the product's enclosure that may be of sufficient magnitude to constitute a risk of electric shock to persons.



The exclamation point within an equilateral triangle is intended to alert the user to the presence of important operating and maintenance (servicing) instructions in the literature accompanying the appliance.

INFORMATION - This equipment has been tested and found to comply with limits for a Class A digital device, pursuant to part 15 of the FCC Rules. These limits are designed to provide reasonable protection against harmful interference when the equipment is operated in a commercial environment. This equipment generates, uses, and can radiate radio frequency energy and, if not installed and used in accordance with the instruction manual, may cause harmful interference to radio communications.

Operation of this equipment in a residential area is likely to cause harmful interference in which case the user will be required to correct the interference at his own expense.

WARNING - Changes or modifications not expressly approved by the manufacturer could void the user's authority to operate the equipment.

WARNING - To prevent electric shock and risk of fire hazards:

- ◆ Do NOT use power sources other than that specified.

This installation should be made by a qualified service person and should conform to all local codes.

- Features 5
- Warnings & cautions 6
- Precautions..... 7
- Components and Accessories 9
- Overview 9
 - Front 9
 - Back 10
- Adjust to lens 11
 - Adjust to Lens's ZOOM and Focus 11
- Connection 12
 - Connecting to monitor 12
 - Connecting to power 13
 - RS-485 Communication control 14
 - Using Coaxial Communications 15
- Operating Your Camera 16
 - Menu Configuration 16
 - Menu Setup 16
 - LENS (Adjusting to the brightness level) 17
 - EXPOSURE 18
 - White Balance (White Bal.) 19
 - SDDR (Samsung Super Dynamic Range) 20
 - BACKLIGHT 21
 - SSNR3 23
 - DAY/NIGHT 24
 - SPECIAL 26
 - EXIT 31
- Troubleshooting 32
- Specifications 33
- Dimension 34

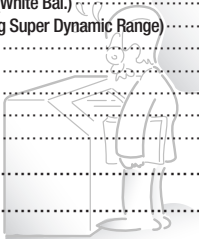

Excellent Sensitivity

The built-in high sensitivity COLOR CCD enable a clear image even in 0.15Lux(COLOR), 0.0003Lux (SENS-UP) or lower illumination.



High Resolution

By adopting a diagonal 6mm(1/3") 410,000 (NTSC) pixel, 470,000(PAL) pixel SONY CCD, the camera produces clear picture quality with a horizontal resolution of 600TV lines for color and a horizontal resolution of 700TV lines for BW mode.



SSNR3 (Samsung Super Noise Reduction) Function

The high-performance W-V DSP chip effectively removes low-light gain noise and ghosting to provide clear images even in dark environments.



DAY&NIGHT(ICR)

This camera has a function that automatically selects the mode that is appropriate for daytime or night-time conditions.
The COLOR mode operates in daytime conditions to provide optimum colors, and BW mode operates in night-time conditions to enhance the definition of the image.



SDDR (Samsung Super Dynamic Range)

For images with high contrast between bright and dark Areas from difficult lighting conditions such as backlighting, this camera selectively illuminates darker Areas while retaining the same light level for brighter Areas to even out the overall brightness.



DIS (Digital Image Stabilizer)

The DIS function compensates for any camera movement, to produce more stable pictures.



IP66 Approved/Dust and Rain Resistant

With dust and rain resistant design, the camera can be installed outside under building eaves or places that are exposed to the dust and rain.



Communication

RS-485, Coaxial communication methods are supported.

- RS-485 Communications
- : STW(SPD), PELCO-P, PELCO-D, VICON, PANASONIC, BOSCH, HONEYWELL, SEC
- Coaxial Communications
- : Pelco Coaxial



Miscellaneous Functions

HLC(High Light Compensation), SENS-UP, FLIP(H/V-REV), D-ZOOM, SHARPNESS, MOTION DETECTION and PRIVACY functions are provided.



OSD

The camera's OSD is complimented by 18 languages.

- NTSC : Korean, English, French, Spanish, Japanese, Portuguese, Taiwanese
- PAL : English, French, German, Spanish, Italian, Chinese, Russian, Czech, Polish, Romanian, Serbian, Swedish, Danish, Turkish, Portuguese



Samsung Techwin cares for the environment at all product manufacturing stages to preserve the environment, and is taking a number of steps to provide customers with more environment-friendly products. The Eco mark represents Samsung Techwin's will to create environment-friendly products, and indicates that the product satisfies the EU RoHS Directive.

Warnings & Cautions

This information is provided to ensure your safety and to prevent any losses, financial or otherwise. Please read it carefully and use the product accordingly.

* For product inquiries, please contact the retail shop where you bought the camera. The use of equipment such as an aerial ladder while providing after-sales service shall be at your expense.

Notes

- Please make sure the product is installed appropriate places where secured from flood, such as under the eaves, to operate properly.
- This product is certified as IP66 standard. However, if there is any flood concerns, it is highly recommended to use an outdoor Housing. When you install the camera inside an outdoor Housing, please use one of the following methods:
 1. Remove the front glass of Housing before installing the camera.
 2. To keep the front glass of Housing, remove the front cover, and then put the camera close to the front glass.

Warning/Attention/Special Mark Messages



Ignoring this information may result in death or serious personal injuries.



Ignoring this information may result in material loss or personal injuries.



Indicates "Never Allowed."



Indicates "No Disassembling."



Correct Disposal of This Product (Waste Electrical & Electronic Equipment)

(Applicable in the European Union and other European countries with separate collection systems)

This marking shown on the product or its literature, indicates that it should not be disposed with other household wastes at the end of its working life. To prevent possible harm to the environment or human health from uncontrolled waste disposal, please separate this from other types of wastes and recycle it responsibly to promote the sustainable reuse of material resources.

Household users should contact either the retailer where they purchased this product, or their local government office, for details of where and how they can take this item for environmentally safe recycling.

Business users should contact their supplier and check the terms and conditions of the purchase contract. This product should not be mixed with other commercial wastes for disposal.

Precautions

Do not install under extreme temperature conditions.



Use only under temperature conditions between -10°C and $+50^{\circ}\text{C}$. Provide good ventilation when using in high temperature conditions.

Do not install in high humidity environment.



May lower image quality.

Do not install under unstable lighting conditions.

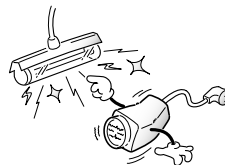

Severe lighting changes or flickering may hinder normal camera operation.

Avoid touching the camera lens.



The lens is the most important component of the camera. Be careful not to smear it with fingerprints.

Precautions

Do not drop the camera or subject it to physical shock.



May cause a product malfunction.

Never keep the camera face to strong light directly.

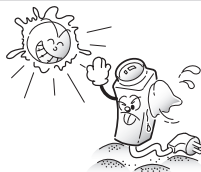

May damage the CCD.

Do not expose the camera to radioactivity.



Radioactivity exposure may damage the CCD.

Notes

- Exposure to a spotlight or an object emitting strong light may cause smear or blooming.
- Ensure that the power source complies with normal specifications before supplying it to the camera.

Components and Accessories



- 1 SOC-4160
- 2 Sunshield
- 3 L-type hexagon wrenches (3.0mm)
- 4 Sunshield Adaptor (1EA)
- 5 Tapping Screw (3EA)
- 6 User's Manual
- 7 Installation Video Output Cable

Overview

FRONT

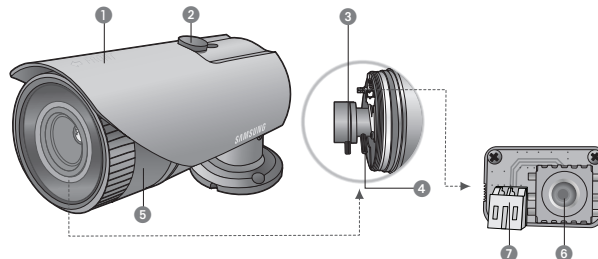

- 1 **Camera Sunshield**
- 2 **Sunshield adaptor** : Fixing the sunshield onto the camera.
- 3 **Focus lever** : Set focus of lens by turn the focus lever.
- 4 **Zoom lever** : Set zoom magnification of lens by turn the zoom lever.
- 5 **Front cover**
- 6 **Function Setup Switch** :
Display the menu on the screen and move the cursor to four directions to confirm status or after changing a selected item.
- 7 **Video Output Terminal to Monitor** :
Used for monitoring of video output When camera installation.

Overview



Notes

- When you adjust to the ZOOM & FOCUS of the lens, Please remove the front cover from the camera, by turning the cover counterclockwise.
- To adjust the zoom & focus loosen the individual levers before tightening them again.
- To ensure the weatherproof integrity is maintained, ensure the front cover is tightened correctly.

BACK

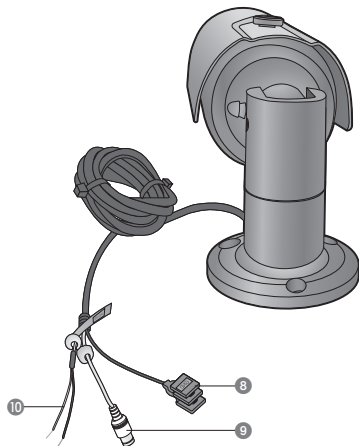

- 8 **Power input terminal** : Connect the power as specified for each model here.
- 9 **Video output terminal** : Video signals are output through this port. Connect this port to the Video IN port of a monitor.
- 10 **RS-485 control terminal** :
You can control SETUP MENU through this port by using external controllers like a Remote controller that RS-485 Communication is supported. For details, see page 14.

Adjust to Lens

Adjust the lens's zoom and focus.

1. Remove the sunshield from the camera.
2. Remove the front cover from the camera by turning it counterclockwise.
3. Unlock the Zoom or Focus lever before adjusting the lens.
4. Adjust the zoom & focus by moving the lever counterclockwise for (NEAR & TELE) and clockwise for (WIDE & FAR) position.
5. After adjustment, tighten the zoom or focus levers, taking care not to adjust the zoom/focus position.
6. Please, close and tighten the front cover.
7. Replace the sunshield.

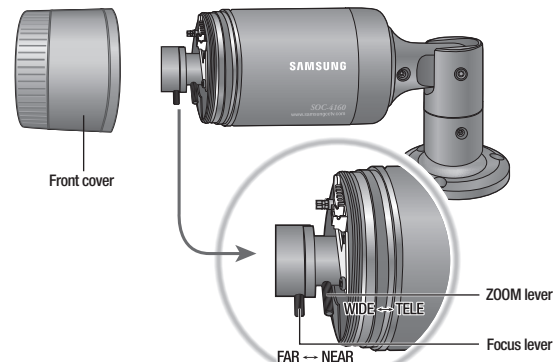

Notes

- If the front cover is cross threaded or not correctly tightened the camera housing will not be weatherproof.
- When you combine the front cover, combine the triangle of front cover and triangle of main body confront each other.

Connection

Connecting to Monitor

Please connect the video output terminal located on the back of the camera to the monitor.

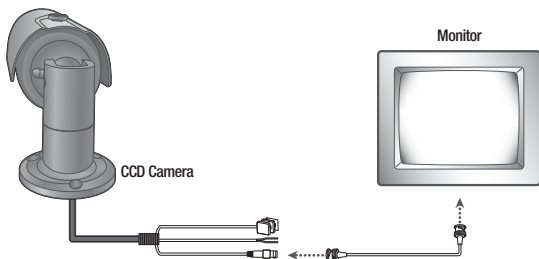

- The connection method varies depending on the type of monitor and accessories. Please refer to the user's manual for each instrument.
- Please turn off the power when connecting.
- Please select Hi-Z on the 75Ω/Hi-Z switch for the intermediate video TV set and select 75Ω for the Intermediate device as shown in the picture below.

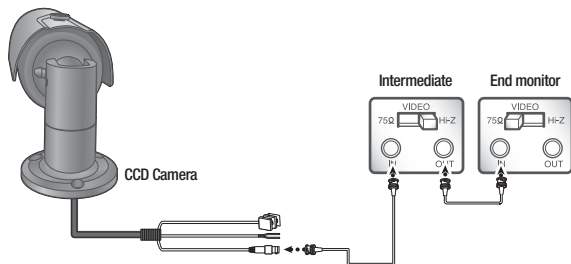

Connecting to Power

The recommended adaptor specification for SOC-4160N/P is DC 12V / 500mA , AC 24V / 500mA.

Please check the standard power requirement before connecting the power. Recommend AC24A / 500mA adaptor for a long-distance.

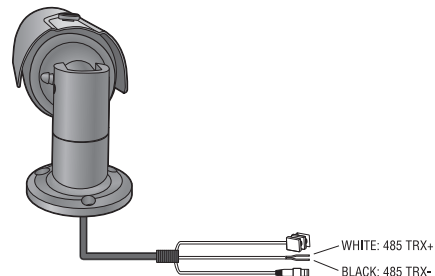

When the resistance value of copper wire is at [20°C(68°F)]

Copper wire size(AWG)	#24(0.22mm ²)	#22(0.33mm ²)	#20(0.52mm ²)	#18(0.83mm ²)
Resistance value(Ω/m)	0.078	0.050	0.030	0.018
Voltage drop(V/m)	0.028	0.018	0.011	0.006

- As shown in the table above, voltage decreases as the wire gets longer. Therefore having an excessively long distance between the power adaptor and the camera may affect the camera's performance.

* Standard voltage for camera operation : DC 12V±10% / AC 24V±10%

* There may be some deviation in voltage drop depending on the type of wire and the manufacturer.



Notes

- Please use a power adaptor that meets the required standards.
- Please connect the power after installation.

Connection

RS-485 communication control

Connecting to RS-485 Control Cable

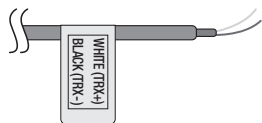

CONTROL CABLE	SPEC
WHITE (TRX+)	RS-485+
BLACK (TRX-)	RS-485-

Using RS-485 communication will enable you to control the OSD menu from a SAMSUNG TECHWIN System Controller or DVR.

(1) Connection to a PC.

Connect the camera to the PC via a RS-485 converter using RS-485 and a serial cable.
 EX) SERIAL PORT OF THE PC(COM1) → SERIAL CABLE → RS-485 CONVERTER → RS-485 CONTROL CABLE

(2) Connection to a DVR or System Controller.

Connect the RS-485 cable to the connection ports of the DVR or System Controller.

485 Control Board Connection Port	RS-485 Control Port
(+) CONNECTION TERMINAL	WHITE (TRX+)
(-) CONNECTION TERMINAL	BLACK (TRX-)

* RS-485 Communication establishment initial value

Item	Camera ID	BAUD RATE	UART MODE	RET PKT
Initial value	1	9600	8-NONE-1	ENABLE



Notes

- When making a control system to control the camera, please use to the protocol(STW(SPD), PELCO-P, PELCO-D, VICON, PANASONIC, BOSCH, HONEYELL, SEC).
- When you connecting to RS-485 CONTROL TERMINAL, please peel off the outer skin inside the RS-485 CONTROL TERMINAL.
- In case of SCC-101 connection, change communication mode to 「8-E-1」 at 「Communication configuration」 menu. (For more information, refer to SCC-101 manual.)

Using Coaxial Communications

- Coaxial Communications System
- OSD Control method

CAMERA	DVR	CONTROLLER
SET	MENU/ENTER	OSD KEY
UP	UP KEY	JOYSTICK UP
DOWN	DOWN KEY	JOYSTICK DOWN
LEFT	LEFT KEY	JOYSTICK LEFT
RIGHT	RIGHT KEY	JOYSTICK RIGHT

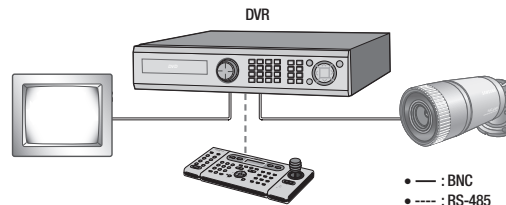

- Video Cable

The camera's video output port is connected to the monitor with a BNC coaxial cable, shown below : If the distance between the camera and the monitor exceeds the recommended maximum, please use an auxiliary video amp.

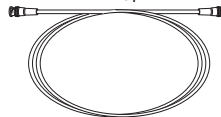

Distance	Recommended Cable Specification
300m	3C2V(RG-59/U)
450m	5C2V(RG-6/U)
600m	7C2V(RG-11/U)



Notes

- If the camera is controlled through coaxial communication, please use a video amp intended for coaxial communications. Regular video amps do not transfer coaxial signals.

Operating Your Camera

Menu Configuration

MAIN SETUP			
LENS	● DC		
EXPOSURE	● BRIGHTNESS	● SHUTTER	● AGC
	● SENS-UP	● RETURN	
WHITE BAL	● ATW	● OUTDOOR	● INDOOR
	● MANUAL	● AWC—SET	
SSDR	● OFF	● ON	
BACKLIGHT	● OFF	● BLC	● HLC
SSNR3	● OFF		
	● ON		
DAY/NIGHT	● COLOR	● B/W	● AUTO
	● IMAGE ADJ.	● CAM TITLE	● SYNC
SPECIAL	● MOTION DET	● PRIVACY	● DIS
	● COMM ADJ	● LANGUAGE	● RETURN
EXIT	● SAVE	● NOT SAVE	● RESET

Menu Setup

Use the Function Setup Switch within the camera.

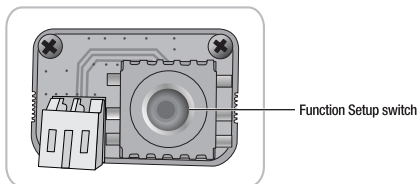

1. Press the Function Setup switch.
 - Main setup menu is displayed on the monitor screen.

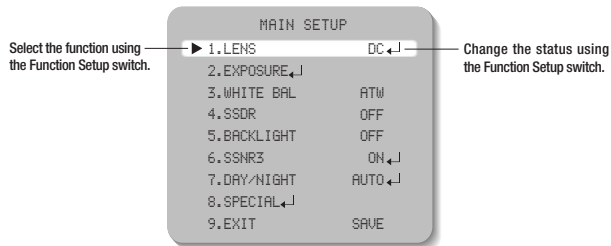

2. Select a desired function using the Function Setup switch.
 - Place the cursor over a desired item.
3. Set up a selected item by using the Function Setup switch.
4. To finish the setting, select 'EXIT' and press the Function Setup switch.

Notes

- An item with the ↵ icon also has sub menus. To select a sub menu, select an item with the icon and press the Setup switch.
- An item with the --- icon is unavailable due to function settings.

LENS

- Using this function, you can control the screen brightness.
1. When the SETUP menu screen is displayed, select 'LENS' by using the Function Setup switch so that the arrow indicates 'LENS'.
 2. DC : You can adjust the minimum shutter and maximum value of ESC shutter mode.

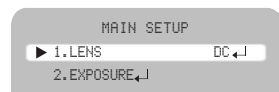

3. THE Lens mode has sub menu items as listed below.
 - BRIGHTNESS : Adjusts the video brightness.

Operating Your Camera

- FOCUS ADJ : To adjust the DC lens focus correctly, you must activate the Focus Settings mode under each lens menu. Activate the Focus Settings mode, adjust the lens focus, and then deactivate the settings mode.



Notes

- If color rolling occurs when using a DC lens, set Shutter to Fixed (---).

EXPOSURE

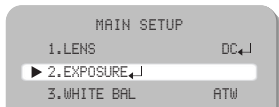

1. When the SETUP menu screen is displayed, select 'EXPOSURE' by using the Function Setup Switch.
2. Select a desired mode using the Function Setup switch.

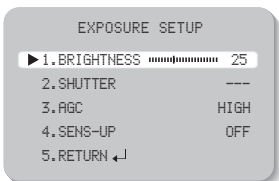

- SHUTTER : You can select either auto or manual shutter.
 - --- : Shutter speed is fixed at 1/60sec(1/50sec)
 - ESC : Select this to control the shutter speed automatically. If ESC is selected, the shutter speed is automatically controlled depending on the ambient illumination of the subject.
 - MANUAL : You can control shutter speed manually.
(NTSC MODEL : 1/60~1/120,000, PAL MODEL : 1/50~1/120,000)
 - A.FLK : Select this when you see picture flicker, this can happen when the frequency of the local lighting clashes with the camera.



Notes

- When the SHUTTER is set to MANUAL or A.FLK mode, SENS-UP will be disabled.
- AGC(AUTO GAIN CONTROL) : The higher the gain level, the brighter the screen - but the higher the noise.
 - OFF : Deactivates the AGC function.
 - LOW : Allows automatic gain control from 5.3dB to 32dB.
 - HIGH : Allows automatic gain control from 5.3dB to 37dB.
- SENS-UP : When it is night or dark, the camera automatically detects the light level and maintains a clear picture if this mode is activated.
 - OFF : Deactivates the SENS-UP function.
 - AUTO : Activates the SENS-UP function.
- RETURN : Select this to save the changes in the EXPOSURE menu and return to the SETUP menu.



Notes

- If you press the Function Setup switch to 'AUTO' mode, you can adjust brightness by increasing or decreasing the shutter speed. (x2 ~ x512)
- Note that the higher the zoom level, the brighter the screen, but the more likely there will be a ghosting effect.
- It is normal for Noise, Spots and Whiteish symptoms to appear in SENS-UP mode when the D-ZOOM level is increased.

White Balance (White Bal)

Use the White Balance function to adjust the screen color.

1. When the SETUP menu screen is displayed, select 'White Bal' by using the Function Setup switch so that the arrow indicates 'White Bal'.
2. Select a desired mode using the Function Setup switch.

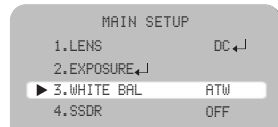

Operating Your Camera

※ Select one of the following 5 modes, as appropriate for your purpose.

- ☉ ATW : Select this when the color temperature is between 1,700°K and 11,000°K.
- ☉ OUTDOOR : Select this when the color temperature is between 1,700°K and 11,000°K. (sodium light inclusion)
- ☉ INDOOR : Select this when the color temperature is between 4,500°K and 8,500°K.
- ☉ MANUAL : Select this to fine-tune White Balance manually. Set White Balance first by using the ATW or AWC mode. After that switch to MANUAL mode, fine-tune the White Balance and then press the Function Setup switch.
- ☉ AWC→SET : To find the optimal luminance level for the current environment, point the camera towards a sheet of white paper and press the Function Setup switch. If the environment changes, readjust it.



Notes

- White Balance may not work properly under the following conditions. In this case select the AWC mode.
 - 1 When the color temperature of the environment surrounding the subject is out of the control range (e.g. clear sky or sunset).
 - 2 When the ambient illumination of the subject is dim.
 - 3 If the camera is directed towards a fluorescent light or is installed in a place where illumination changes dramatically, the White Balance operation may become unstable.

SSDR (Samsung Super Dynamic Range)

SSDR illuminates darker spots of an image while retaining the same light level for brighter spots to even out the overall brightness of images with high contrast between bright and dark spots.

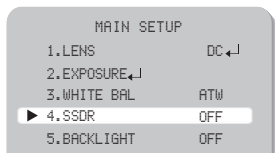

1. When the SETUP menu screen is displayed, select 'SSDR' by using the switch so that the arrow indicates 'SSDR'.
2. Use the switch to change the SSDR level according to the contrast between bright and dark areas.

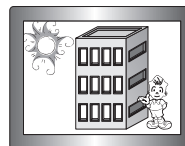

SSDR ON

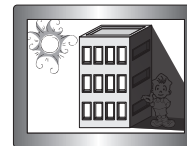

SSDR OFF

BACKLIGHT

Unlike conventional cameras, the SOC-4160 is designed to deliver a distinctive subject and background at the same time, even when the subject is backlight, by using the features of the proprietary W-V DSP chip.

1. When the SETUP menu screen is displayed, select 'BACKLIGHT' by using the Function Setup switch so that the arrow indicates 'BACKLIGHT'.

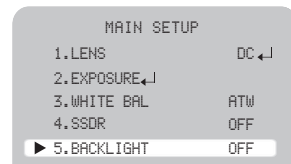

2. Select a desired mode using the Function Setup switch.

- ☉ BLC : Enables a user to directly select a desired area from a picture, and to view the area more clearly.

Operating Your Camera

☞ HLC (High Light Compensation) :

If the scene contains extremely bright light areas such as; from car headlights, the light can mask out much of the on-screen detail.

- LEVEL : Adjust level of the HLC function.
- LIMIT : Enable to change the operating condition.
- MASK COLOR/TONE : Change the color / transparency of the masking area.
(Black, Red, Blue, Cyan, Magenta)
- TOP/BOTTOM/LEFT/RIGHT : Adjust the area to be enhanced

☞ OFF : Not being used

3. Select a desired mode using the Function Setup switch and press the Function Setup switch.

- ☞ Select 'BLC' to adjust the area to be enhanced then adjust the level.
- ☞ HLC : Enable the user to change the level, limit, mask color/tone and area.

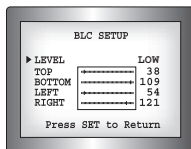

Notes

- Because there can be a difference in the effectiveness of HLC according to the amount of light area in the screen, optimize the installation angle for the best HLC performance.
- When dark, the HLC is only activated when a bright light exceeding a specific size in NIGHT ONLY mode.
- The HLC is not activated in day light or when bright light is not present at night in NIGHT ONLY mode.

SSNR3

This function reduces the background noise in a low luminance environment.

1. When the SETUP menu screen is displayed, select 'SSNR3' by using the Function Setup switch so that the arrow indicates 'SSNR3'.

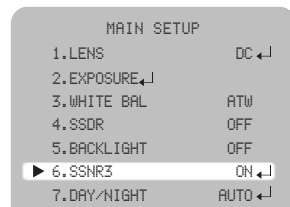

2. Select a desired mode using the Function Setup switch.

- ☞ OFF : Deactivates SSNR3. Noise is not reduced.
- ☞ ON : Activates SSNR3 so that noise is reduced.

3. Set the SSNR3 mode to 'ON' and press the Function Setup switch. Then you can adjust the noise reduction level.

Notes

- You cannot set the SSNR3 to 'ON' or 'OFF' when the AGC mode of the EXPOSURE menu is 'OFF'.
- When adjusting the noise reduction level in the SSNR3 mode, remember that the higher the level set, the more the noise level will be reduced, as will the brightness of the image.

Operating Your Camera

DAY/NIGHT

You can display pictures in color or black and white.

- When the SETUP menu screen is displayed, select 'DAY/NIGHT' by using the Function Setup switch so that the arrow indicates 'DAY/NIGHT'.

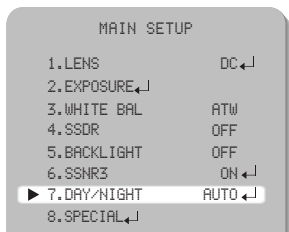

- Select a desired mode using the Function Setup Switch according to the picture display you want.

☞ COLOR : The picture is always displayed in color.

☞ B/W : The picture is always displayed in black and white.

- BURST MODE : You can turn on or off the burst signal on B/W mode.

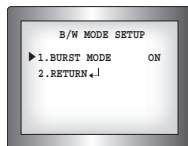

☞ AUTO : The mode is switched to 'Color' in a normal environment, but switches to 'B/W' mode when ambient illumination is low. To set up the switching time for AUTO mode, press the Function Setup switch. You can turn on or off the burst signal on B/W mode.

- BURST MODE : You can turn on or off the burst signal on B/W mode.

- DURATION : You can select brightness of illumination about changing the day/night mode.

- DWELL TIME : You can select the duration time about changing the day/night mode.
→ 3s, 5s, 7s, 10s, 15s, 20s, 30s, 40, 60s

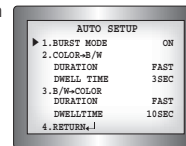

	Color → B/W	B/W → Color
Fast	2.5 lux	5 lux
Slow	1 lux	10 lux

* The day/night switching point of the camera can be adjusted.



Notes

- When AGC in the EXPOSURE menu is 'OFF', '---' mode operates as like selecting 'COLOR' mode and 'AUTO' mode can not be selected.

Operating Your Camera

SPECIAL

1. When the SETUP menu screen is displayed, select 'SPECIAL' by using the Function Setup switch so that the arrow indicates 'SPECIAL'.

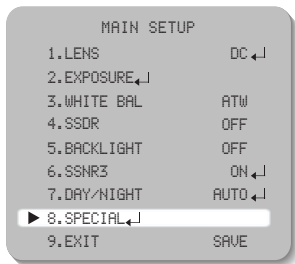

2. Select a desired mode using the Function Setup switch.

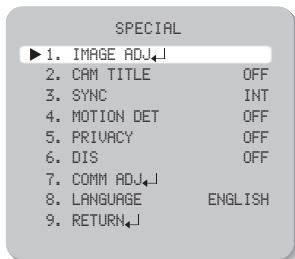
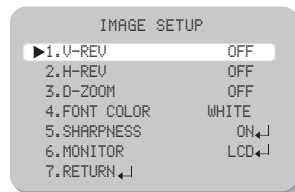
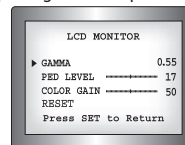

IMAGE ADJ :

- 1) When the SETUP menu screen is displayed, select 'IMAGE ADJ' by using the Function Setup switch so that the arrow indicates 'IMAGE ADJ'.
- 2) Select a desired mode using the Function Setup switch.



- V-REV : You can flip the picture vertically on the screen.
- H-REV : You can flip the picture horizontally on the screen.
- D-ZOOM : You can use a digital zoom of x1 ~ x16.
- FONT COLOR : You can change the OSD font color. (White, Yellow, Green, Red, Blue)
- SHARPNESS : As you increase this value, the picture outline becomes stronger and clearer. Adjust this value appropriately depending on the sharpness of the picture.
- MONITOR : Please change the settings value of video appropriate to your monitor.
 - LCD : Please select this menu item when using a LCD monitor.
 - CRT : Please select this menu item when using a CRT monitor.
 - USER : Please use this menu item when using a monitor other than standard ones. You can change the gamma, PED level, and color gain in the sub menus.
- RETURN : Select this to save the settings for the IMAGE ADJ menu and to return to the SETUP menu.



Notes

- When the V-REV or H-REV mode is enabled, the text on the screen does not flip.
- If you increase the SHARPNESS level too high, the picture may become distorted or noise may appear.

Operating Your Camera

☉ CAM TITLE : If you enter a title, the title will appear on the monitor.

- 1) If the SPECIAL menu screen is displayed, use the Function Setup switch so that the arrow indicates 'CAM TITLE'.
- 2) Set it to 'ON' by using the Function Setup switch.
- 3) Press the Function Setup switch.
- 4) Use the Function Setup switch to move to a desired letter and select the letter by pressing the Function Setup switch. Repeat this to enter multiple letters. You can enter up to 15 letters.
- 5) Enter a title, move the cursor to 'POS' and press the Function Setup switch. The entered title appears on the screen. Select the position to display the title on the screen by using the Function Setup switch and press the Function Setup switch. When the position is determined, select 'END' and press the Function Setup switch to return to the SPECIAL menu.

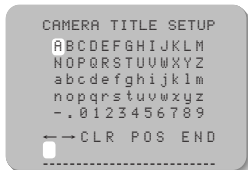

Notes

- When the CAM TITLE menu is 'OFF', no title will be displayed on the monitor screen even if you enter one.
- Only English is available in this mode.
- If you move the cursor to CLR and press the Function Setup switch, all the letters are deleted. To edit a letter, change the cursor to the bottom left arrow and press the Function Setup switch. Move the cursor over the letter to be edited, move the cursor to the letter to be inserted and then press the Function Setup switch.

☉ SYNC : In areas where the supply is at 60Hz(NTSC), 50Hz(PAL), you can synchronize the output phase of multiple cameras using the power synchronization function (Line-Lock) without using a synchronization signal generator.

- INT : Internal Synchronization Type
- L/L : Power Synchronization Type, Line-lock
- Press the Function Setup switch.
- You can select a desired phase from 0 to 359 when select 'phase'.

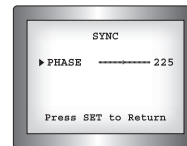

Notes

- When using AC power at 60Hz(NTSC), 50Hz(PAL), frequency, you can use the L/L type synchronization.
- When the power is DC 12V, the SYNC menu is fixed to the 'INT' mode.

☉ MOTION DET :

This product has a feature that allows you to observe movement of objects in 8 different areas on the screen, and the words 'MOTION DETECTED' appear on the screen when movement is detected.

Activity can be monitor more efficiently.

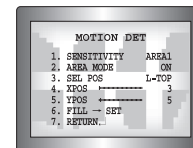

- 1) When the SPECIAL menu screen is displayed, press the Function Setup switch so that the arrow indicates 'MOTION DET'.
- 2) Set up the mode using the Function Setup switch.
 - SENSITIVITY : You can select up to 8 MD areas. When SENSITIVITY number is high, motion detection sensitivity is increased to recognize even small movement.
 - AREA MODE : Determines whether to use the MD area selected in SENSITIVITY.
 - SEL POS : Determines which of the 4 vertices of each MD area is to be used.
 - XPOS : Determines the coordinate of the horizontal axis for SEL POS.
 - YPOS : Determines the coordinate of the vertical axis for SEL POS.
 - FILL—SET : Fills in a selected MD area. The color of the area can be selected from brown, orange, blue, cyan, green, yellow, magenta and red.
 - RETURN : Select this to save the MOTION DET menu settings and return to the SPECIAL menu.

Operating Your Camera

- PRIVACY : Mask an area you want to hide on the screen.

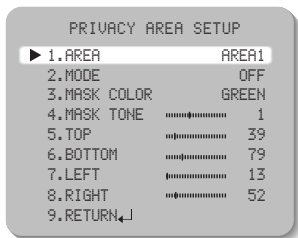

1) When the SPECIAL menu screen is displayed, press the Function Setup switch so that the arrow indicates 'PRIVACY'.

2) Set up the mode using the Function Setup switch.

- AREA : You can select up to 12 PRIVACY areas.
- MODE : Determines whether to use the area selected in the AREA.
- MASK COLOR : Determine area color. You can select Green, Red, Blue, Black, White, Gray.
- MASK TONE : Adjust the brightness of MASK COLOR.
- TOP/BOTTOM/LEFT/RIGHT : Adjust the size and position of the selected area.
- RETURN : Select this to save the PRIVACY menu settings and return to the SPECIAL menu.

- DIS (Digital Image Stabilizer) :

This function mitigates any picture movement due to external factors such as wind.

Notes

- As the DIS function uses the digital zoom the camera's resolution will decrease.
- DIS doesn't operate when background illumination is too low.
- DIS doesn't operate when object pattern is monotonic as like sky or white wall.

- COMMADJ (Communication Adjustment) :

This function sets up the camera communication status when controlling the camera through an external control device.

1) When the SPECIAL menu screen is displayed, press the Function Setup switch so that the arrow indicates 'COMMADJ'.

2) Set up the mode using the Function Setup switch.

- CAM ID : Determines the camera's identification number (between 0 and 255).
- BAUD RATE : You can select 2400/4800/9600/19200/38400/57600 bps.
- UART MODE : You can select NONE, EVEN or ODD for the parity bits.
- RET PKT : Determines whether to send a command back to the controller device when a communication control command is sent to the camera.
- DISP ID : Display camera title on top left corner of the screen.
- PROTOCOL : You can select one of various protocols. STW(SPD), PELCO-P, PELCO-D, VICON, PANASONIC, BOSCH, HONEYWELL, SEC.

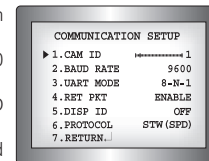

* Initial value of communication adjustment

Item	Camera ID	BAUD RATE	UART MODE	PET PKT
Initial value	1	9600	8-NONE-1	ENABLE

- LANGUAGE : You can select the menu language according to your requirements.

- RETURN : Select this to save the SPECIAL menu settings and return to the MAIN SETUP menu.

EXIT

Select a desired EXIT mode using the Function Setup Switch.

- SAVE : Save the current settings and exit the MAIN SETUP menu.
- NOT SAVE : Do not save the current settings and exit the MAIN SETUP menu.
- RESET : Resets the camera settings to the factory defaults. Language, Communication and Monitor settings are not initialized.

If there are problems in operation, please refer to the items below. If the problem persists, please contact the agent you purchased this product from.

- **Nothing appears on the screen.**
 - ▶ Check that the power cord and line connection between the camera and monitor are fixed properly.
 - ▶ Check that you have properly connected UTP cable or BNC cable to the camera.
- **The image on the screen is dim.**
 - ▶ Is lens stained with dirt? Clean your lens with soft, clean cloth.
 - ▶ Set the monitor to proper condition.
 - ▶ If the camera is exposed to too strong light, change the camera position.
- **The image on the screen is dark.**
 - ▶ Adjust the contrast feature of the monitor.
 - ▶ If you have an intermediate device, set the 75Ω / Hi-z properly.
- **The camera is not working properly, and the surface of the camera is hot.**
 - ▶ Check that you have properly connected the camera to an appropriate power source.
- **The SENS-UP function does not work.**
 - ▶ Check that AGC of EXPOSURE SETUP menu is 'OFF'.
 - ▶ Check that SHUTTER of EXPOSURE SETUP menu is 'A.FLK' or 'MANUAL'.
- **The Motion Detection function does not work.**
 - ▶ Check that MOTION DET of SPECIAL SETUP menu is 'OFF'.
- **Color is not correct.**
 - ▶ Check the setting of WHITE BAL SETUP menu.
- **The screen flickers continually.**
 - ▶ Check that direction of camera turns toward the Sun.
- **When coaxial communication is not available:**
 - ▶ Make sure that the camera and monitor are installed within the recommended distance.
 - ▶ Use the video amplifier equivalent to coaxitron if the recommended installation distance is exceeded.
- **When the camera is not waterproof.**
 - ▶ Please check the Front Cover and Main Body by the following Guide Label.

	SOC-4160N	SOC-4160P
ELECTRICAL		
Input Voltage	DC 12V / AC 24V	
Power Consumption	MAX 2.7W / 3.8W	
VIDEO		
Imaging Device	1/3 inch, Diagonal 6mm Super HAD CCD	
Total Pixels	811(H) x 508(V)	795(H) x 596(V)
Effective Pixels	768(H) x 494(V)	752(H) x 582(V)
Scanning System	2:1 Interlace	
Synchronization	Internal /Line-Lock	
Frequency	H : 15.734KHz V:59.94Hz	H: 15.625KHz V: 50.00Hz
Horizontal Resolution	COLOR : 600TVL, B/W : 700TVL	
Min. Illumination	COLOR : 0.15Lux (50IRE, @F1.2), 0.0003Lux (SENE-UP, x512) B/W : 0.001Lux (50IRE, @F1.2), 0.000002Lux (SENS-UP, x512)	
S/N (Y Signal)	52dB (Weight On, AGC Off)	
Video Output	CVBS : 1.0Vp-p, 75Ω composite	
LENS		
Zoom Ratio	3.6x (Manual)	
Focus Length	2.8 – 10.0mm (F1.2)	
Angular Field of View	H : 94.4°(Wide)–28°(Tele) / V : 69.2°(Wide)–21°(Tele)	
OPERATIONAL		
Electronic Shutter Speed	1/60 – 1/120k sec	1/50 – 1/120k sec
On Screen Display	NTSC : 7 Languages, PAL : 15 Languages	
SSDR	On / Off (Level adjustable)	
Backlight Compensation	BLC / HLC / OFF	
Day & Night	COLOR / B/W / AUTO (ICR)	
Gain Control	Low / High / Off	
White Balance	ATW / Outdoor / Indoor / Manual / AWC (1,700°K – 11,000°K)	
SENS-UP (frame Integration)	Auto / Off (Selectable x2 – x512)	
Motion Detection	On / Off (8 Programmable zones)	
Privacy Masking	On / Off (12 Programmable zones)	
3D Noise Filter (SSNRILL)	On / Off (Level adjustable)	
Digital Zoom	On / Off (x1 – x16)	
Digital Image Stabilization(DIS)	On / Off	
Camera Title	On / Off (Displayed 15 Characters)	
Sharpness	On / Off (Level adjustable)	
Flip / Mirror	On / Off	
Communication	Coaxial, RS-485	
Protocol	Coaxial(Pelco), RS-485(STW(SPD), PELCO-P, PELCO-D, VICON, PANASONIC, BOSCH, HONEYWELL, SEC)	
ENVIRONMENTAL		
Operating Temperature / Humidity	-10°C – +50°C / 30% – 80% RH	
Storage Temperature / Humidity	-20°C – +60°C / 20% – 90% RH	
MECHANICAL		
Water Resistance	IP66	
Dimension	Ø77mm(W) x 216mm(H) (BRACKET ANGLE 90°), 284mm (BRACKET ANGLE 180°)	
Weight	955g	

※ The specification for this product may change without prior notice for product improvement.

Dimension

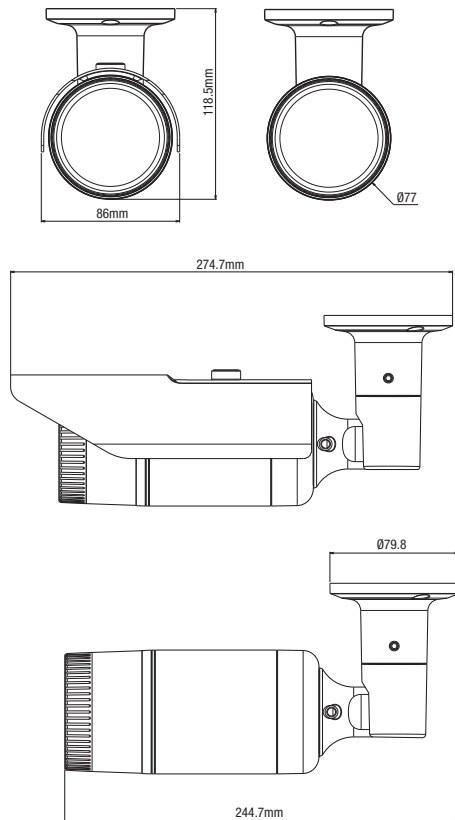

DECLARATION OF CONFORMITY

Application of Council Directive(s)	89 / 336 / EEC
Manufacturer's Name	SAMSUNG TECHWIN CO., LTD
Manufacturer's Address	SAMSUNG TECHWIN CO., LTD 42, SUNGJU-DONG CHANGWON-CITY, KYUNGNAM, KOREA, 641-716
European Representative Name	
European Representative Address	
Equipment Type/Environment	CCTV Camera
Model Name	SOC-4160P
Beginning Serial NO.	C10S8010007
Year of Manufacture	2009.08.01
Conformance to	EN 50081-1 : 1992 EMC-Directive 89/336 EEC and 92/31/EEC EN 50130-4 : 1996

We, the undersigned, hereby declare that the equipment specified above conforms to the above Directive(s).

Manufacturer	SAMSUNG TECHWIN CO., LTD	Legal Representative in Europe
Signature	<i>Bj Gu</i>	Signature
Full Name	BONJENG GU	Full Name
Position	QUALITY CONTROL MANAGER	Position
Place	CHANGWON, KOREA	Place
Date	2009.08.01	Date

SAMSUNG TECHWIN

The Samsung logo, consisting of the word "SAMSUNG" in a bold, sans-serif font, enclosed within a black, horizontally-oriented oval.

SALES NETWORK

• **SAMSUNG TECHWIN CO., LTD.**

145-3, Sangdaewon 1-dong, Jungwon-gu, Seongnam-si Gyeonggi-do, Korea, 462-703
TEL : +82-31-740-8151-8 FAX : +82-31-740-8145

• **SAMSUNG TECHWIN AMERICA Inc.**

1480 Charles Willard St, Carson, CA 90746, UNITED STATES
Tol Free : +1-877-213-1222 FAX : +1-310-632-2195
www.samsungcctvusa.com

• **SAMSUNG TECHWIN EUROPE CO., LTD.**

Samsung House, 1000 Hillswood Drive, Hillswood Business
Park Chertsey, Surrey, UNITED KINGDOM KT16 OPS
TEL : +44-1932-45-5300 FAX : +44-1932-45-5325

www.samsungtechwin.com
www.samsungcctv.com

P/No. : Z6806-1045-01B

VAN 09.10

Free Manuals Download Website

<http://myh66.com>

<http://usermanuals.us>

<http://www.somanuals.com>

<http://www.4manuals.cc>

<http://www.manual-lib.com>

<http://www.404manual.com>

<http://www.luxmanual.com>

<http://aubethermostatmanual.com>

Golf course search by state

<http://golfingnear.com>

Email search by domain

<http://emailbydomain.com>

Auto manuals search

<http://auto.somanuals.com>

TV manuals search

<http://tv.somanuals.com>