



DIGITAL HOME CINEMA SYSTEM

HT-DB120

THIS APPLIANCE IS MANUFACTURED BY:

Instruction Manual

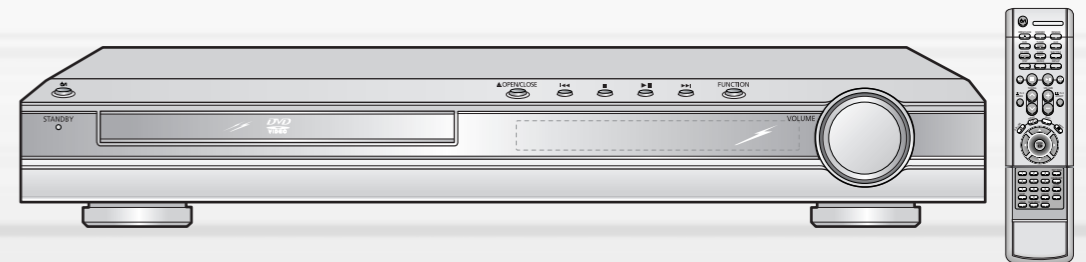

AH68-01339B

Safety Warnings

**CLASS 1 LASER PRODUCT
KLASSE 1 LASER PRODUKT
LUOKAN 1 LASER LAITE
KLASS 1 LASER APPARAT
PRODUCTO LASER CLASE 1**



CAUTION:
TO REDUCE THE RISK OF ELECTRIC SHOCK, DO NOT REMOVE REAR COVER. NO USER SERVICEABLE PARTS INSIDE. REFER SERVICING TO QUALIFIED SERVICE PERSONNEL.

CLASS 1 LASER PRODUCT

This Compact Disc player is classified as a CLASS 1 LASER product.

Wiring the Main Power Supply Plug(UK Only)

IMPORTANT NOTICE

The main lead on this equipment is supplied with a moulded plug incorporating a fuse. The value of the fuse is indicated on the pin face of the plug and if it requires replacing, a fuse approved to BS1362 of the same rating must be used.

Never use the plug with the fuse cover removed. If the cover is detachable and a replacement is required, it must be of the same colour as the fuse fitted in the plug. Replacement covers are available from your dealer.

If the fitted plug is not suitable for the power points in your house or the cable is not long enough to reach a power point, you should obtain a suitable safety approved extension lead or consult your dealer for assistance.

However, if there is no alternative to cutting off the plug, remove the fuse and then safely dispose of the plug. Do not connect the plug to a main socket as there is a risk of shock hazard from the bared flexible cord.

Never attempt to insert bare wires directly into a main socket. A plug and fuse must be used at all times.

IMPORTANT

The wires in the main lead are coloured in accordance with the following code:-

BLUE = NEUTRAL BROWN = LIVE

As these colours may not correspond to the coloured markings identifying the terminals in your plug, proceed as follows:-

The wire coloured BLUE must be connected to the terminal marked with the letter N or coloured BLUE or BLACK.
The wire coloured BROWN must be connected to the terminal marked with the letter L or coloured BROWN or RED.

WARNING: DO NOT CONNECT EITHER WIRE TO THE EARTH TERMINAL WHICH IS MARKED WITH THE LETTER E OR BY THE EARTH SYMBOL \perp , OR COLOURED GREEN OR GREEN AND YELLOW.

Use of controls, adjustments or performance of procedures other than those specified herein may result in hazardous radiation exposure.

CAUTION-INVISIBLE LASER RADIATION WHEN OPEN AND INTERLOCKS DEFEATED, AVOID EXPOSURE TO BEAM.



This symbol indicates that dangerous voltage which can cause electric shock is present inside this unit.



This symbol alerts you to important operating and maintenance instructions accompanying the unit.

WARNING: To reduce the risk of fire or electric shock, do not expose this appliance to rain or moisture.

CAUTION: TO PREVENT ELECTRIC SHOCK, MATCH WIDE BLADE OF PLUG TO WIDE SLOT, FULLY INSERT.

Precautions

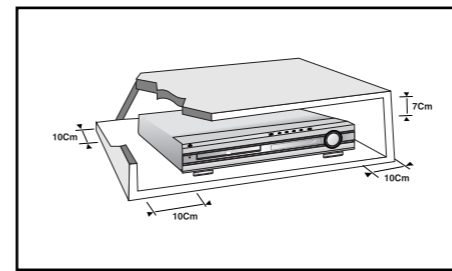

Ensure that the AC power supply in your house complies with the identification sticker located on the back of your player. Install your player horizontally, on a suitable base (furniture), with enough space around it for ventilation (3~4inches). Make sure the ventilation slots are not covered. Do not stack anything on top of the player. Do not place the player on amplifiers or other equipment which may become hot. Before moving the player, ensure the disc tray is empty. This player is designed for continuous use. Switching off the DVD player to the stand-by mode does not disconnect the electrical supply. In order to disconnect the player completely from the power supply, remove the main plug from the wall outlet, especially when left unused for a long period of time.

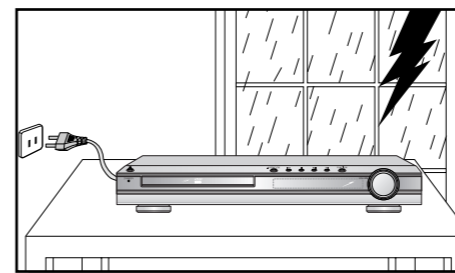

During thunderstorms, disconnect AC main plug from the wall outlet.
Voltage peaks due to lightning could damage the unit.

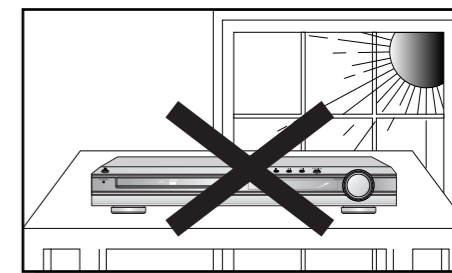
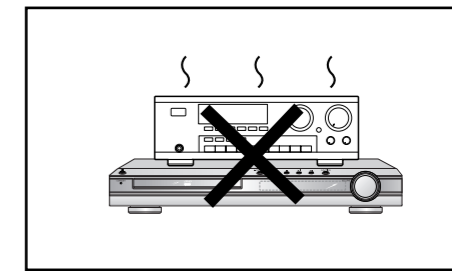

Do not expose the unit to direct sunlight or other heat sources.
This could lead to overheating and malfunction of the unit.

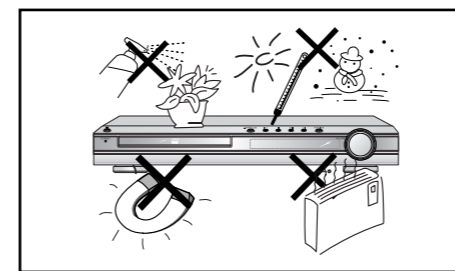

Protect the player from moisture(i.e. vases) , and excess heat(e.g.fire-place) or equipment creating strong magnetic or electric fields (i.e.speakers...). Disconnect the power cable from the AC supply if the player malfunctions. Your player is not intended for industrial use.

Use of this product is for personal use only.

Condensation may occur if your player or disc have been stored in cold temperatures.

If transporting the player during the winter, wait approximately 2 hours until the unit has reached room temperature before using.

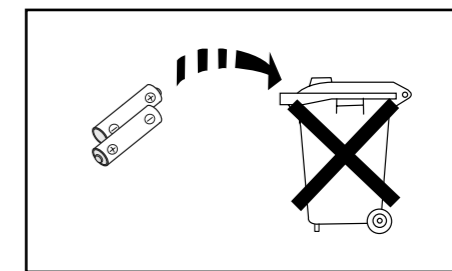

The battery used with this product contain chemicals that are harmful to the environment.

Do not dispose of batteries in the general household trash.

Features

● Multi-Disc Playback & AM/FM Tuner

The HT-DB120 combines the convenience of multi-disc playback capability, including DVD, CD, MP3-CD, CD-R, CD-RW, and DVD-RW, with a sophisticated AM/FM tuner, all in a single player.

● Dolby Pro Logic II

Dolby Pro Logic II is a new form of multi-channel audio signal decoding technology that improves upon existing Dolby Pro Logic.

● DTS (Digital Theater Systems)

DTS is an audio compression format developed by Digital Theater Systems Inc. It delivers full-frequency 5.1 channel sound.

● TV Screen Saver Function

The HT-DB120 automatically brightens and darkens the brightness of the TV screen after 2 minutes in the stop or pause mode.
The HT-DB120 automatically switches itself into the power saving mode after 20 minutes in the screen saver mode.

● Power Saving Function

The HT-DB120 automatically shuts itself off after 20 minutes in the stop or pause mode.

● Customized TV Screen Display

The HT-DB120 allows you to select your favorite image during JPEG, DVD playback and set it as your background wallpaper.

Selecting the Video Format

Turn off the main unit and then press **NTSC/PAL**.

- By default, the video format is set to "PAL".
- Each time the button is pressed, the video format switches between "NTSC" and "PAL".
- Each country has a different video format standard.
- For normal playback, the video format of the disc must be the same as the video format of your TV.

Contents

● PREPARATION

Safety Warnings.....	1
Precautions.....	2
Features.....	3
Notes on Discs.....	5
Description.....	7

● CONNECTIONS

Connecting the Speakers.....	11
Connecting the FM and AM(MW) Antennas.....	13
Connecting the Video to TV.....	14
Connecting External Components.....	15

● OPERATION

Disc Playback.....	17
Displaying Disc Information.....	18
Fast/Slow Playback.....	19
Skipping Scenes/Songs.....	20
Repeat Playback.....	21
A-B Repeat Playback.....	22
Angle Function.....	23
Zoom Function.....	24
Selecting Audio/Subtitle Language.....	25
Moving Directly to a Scene/Song.....	26
JPEG File Playback.....	27
Using Disc Menu.....	29
Using the Title Menu.....	30

● SETUP

Setting the Language.....	31
Setting TV Screen type.....	33
Setting Parental Controls (Rating Level).....	35
Setting the Password.....	37
Setting the Wallpaper.....	39
Setting the Speaker Mode.....	41
Setting the Test Tone.....	42
Setting the Delay Time.....	43
Setting the Audio Quality.....	45
Setting the DRC (Dynamic Range Compression).....	47
Sound Field (DSP)/EQ Function.....	48
Dolby Pro Logic II Mode.....	49
Dolby Pro Logic II Effect.....	50

● RADIO OPERATION

Listening to Radio.....	51
Presetting Stations.....	52

● MISCELLANEOUS

Convenient Functions.....	53
Before Calling for Service.....	55
Cautions on Handling and Storing Discs.....	57
Specifications.....	58
Notes on Terminology.....	59
Memo.....	60

Notes on Discs



DVD (Digital Versatile Disc) offers fantastic audio and video, thanks to Dolby Digital surround sound and MPEG-2 video compression technology. Now you can enjoy these realistic effects in the home, as if you were in a movie theater or concert hall.



DVD players and the discs are coded by region. These regional codes must match in order for the disc to play. If the codes do not match, the disc will not play. The Region Number for this player is given on the rear panel of the player. (Your DVD player will only play DVDs that are labeled with identical region codes.)

Playable Discs

Disc Type	Mark (Logo)	Recorded Signals	Disc Size	Max. Playing Time
DVD		Audio + Video	12cm	Approx. 240 min. (single-sided)
				Approx. 480 min. (double-sided)
			8cm	Approx. 80 min. (single-sided)
				Approx. 160 min. (double-sided)
AUDIO-CD		Audio	12cm	74 min.
			8cm	20 min.

Do not use the following types of disc!

- LD, CD-G, CD-I, CD-ROM and DVD-ROM cannot be played on this player. If such discs are played, a "WRONG DISC FORMAT" message appears on the TV screen.
- DVD discs purchased abroad may not play on this player. If such discs are played, a "WRONG REGION CODE" message appears on the TV screen.

Copy Protection

- Many DVD discs are encoded with copy protection. Because of this, you should only connect your DVD player directly to your TV, not to a VCR. Connecting to a VCR results in a distorted picture from copy-protected DVD discs.
- This product incorporates copyright protection technology that is protected by methods claims of certain U.S. patents and other intellectual property rights owned by Macrovision Corporation and other rights owners. Use of this copyright protection technology must be authorized by Macrovision Corporation, and is intended for home and other limited viewing uses only unless otherwise authorized by Macrovision Corporation. Reverse engineering or disassembly is prohibited.

Disc Recording Format

CD-R Discs

- Depending on the disc recording device (CD-Recorder or PC) and the condition of the disc, some CD-R discs may not be playable.
- Use a 650MB/74 minute CD-R. Avoid CD-R media, as they may not be playable.
- If possible, do not use CD-RW (Rewritable) media, as they may not be playable.
- Only the CD-Rs that are properly "closed" can be fully played. If the session is closed but the disc is left open, you may not be able to fully play the disc.

CD-R MP3 Discs

- Only CD-R discs with MP3 files in ISO 9660 or Joliet format can be played.
- MP3 file names should be 8 characters or less in length and contain no blank spaces or special characters (. / = +).
- If the name of a file is in Korean, the name will be displayed on the TV screen in Korean and * will be shown in the display of the main unit.
- Use discs recorded with a compression/decompression data rate greater than 128Kbps.
- Only files with the ".mp3" and ".MP3" extensions can be played.
- Only a consecutively written Multisession disc can be played. If there is a blank segment in the Multisession disc, the disc can be played only up to the blank segment.
- If the disc is not closed, it will take longer to begin playback and not all of the recorded files may be played.
- For files encoded in Variable Bit Rate (VBR) format, i.e. files encoded in both low bit rate and high bit rate (e.g., 32Kbps ~ 320Kbps), the sound may skip during playback.
- If more than 500 tracks are recorded on a single CD, a maximum of 500 tracks can be played.
- If more than 300 folders are recorded on a single CD, a maximum of 300 folders can be played.

What is MP3?

MP3 is short for MPEG-1 Audio Layer 3 and MPEG is an acronym for Moving Pictures Experts Group. MP3 is a file format with compression ratio of 1:12 (128 Kbps*) That is, you can use MP3 format to record about 12 times the usual amount of data on a regular CD.

CD-R JPEG Discs

- Only files with the ".jpeg" and ".JPEG" extensions can be played.
- If the disc is not closed, it will take longer to start playing and not all of the recorded files may be played.
- Only CD-R discs with JPEG files in ISO 9660 or Joliet format can be played.
- JPEG file names should be 8 characters or less in length and contain no blank spaces or special characters (. / = +).
- Only a consecutively written multisession disc can be played. If there is a blank segment in the multisession disc, the disc can be played only up to the blank segment.
- A maximum of 9,999 images can be stored on a single CD.
- When playing a Kodak/Fuji Picture CD, only the JPEG files in the picture folder can be played.
- Picture discs other than Kodak/Fuji Picture CDs may take longer to start playing or may not play at all.

Description

—Front Panel—

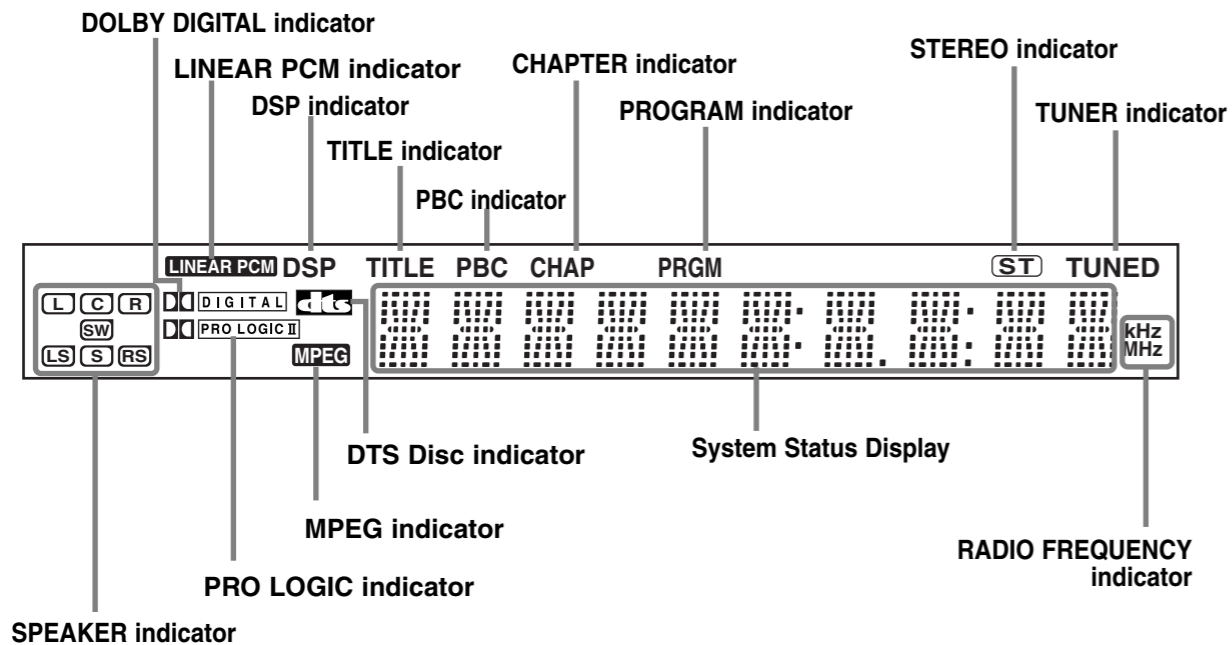
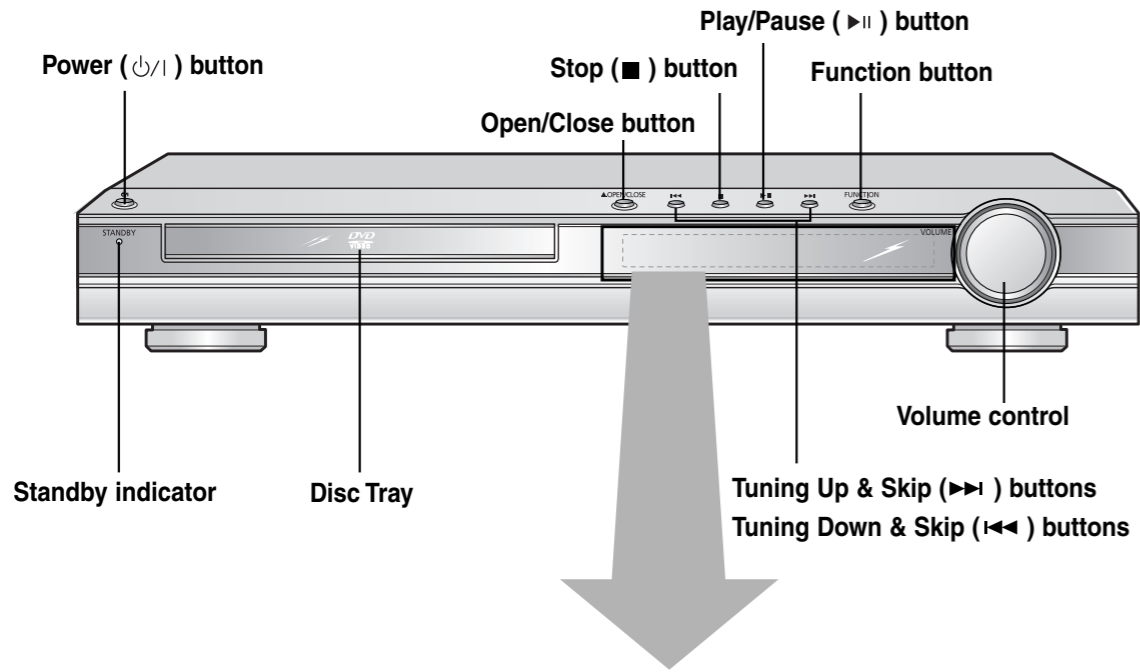

—Rear Panel—

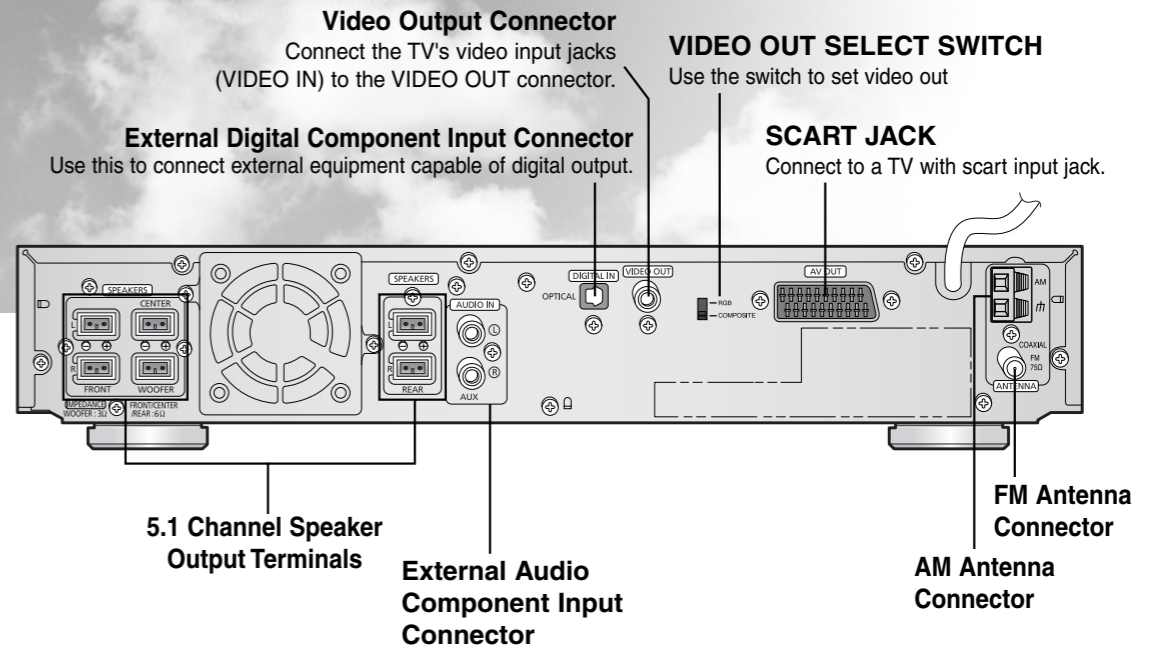

Accessories

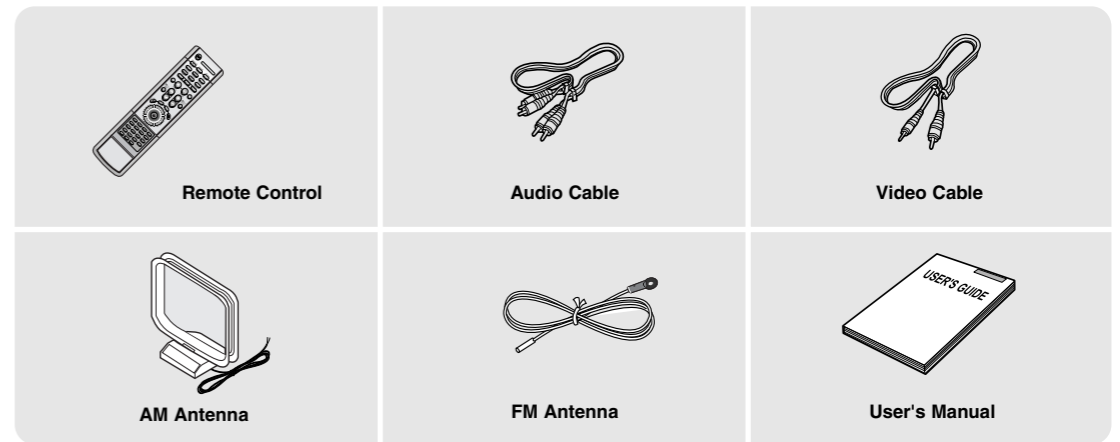

Description

—Remote Control—

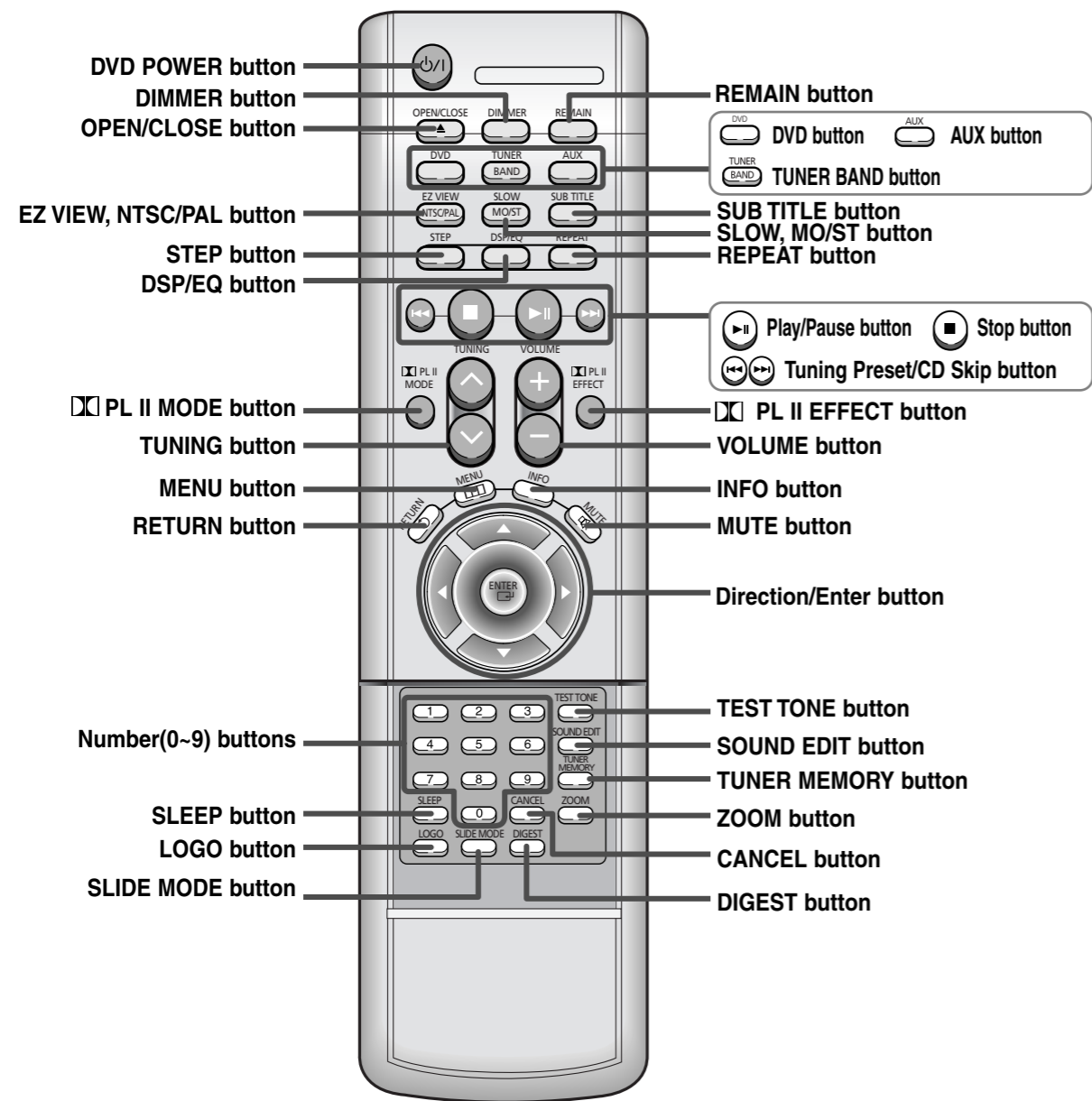

Insert Remote Batteries

1 Remove the battery cover on the back of the remote by pressing down and sliding the cover in the direction of the arrow.

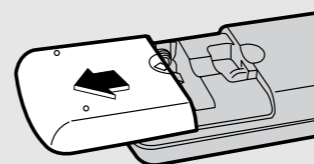

2 Insert two 1.5V AAA batteries, paying attention to the correct polarities (+ and -).

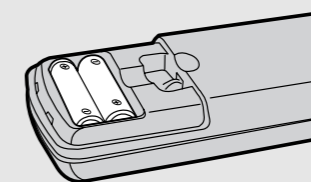

3 Replace the battery cover.

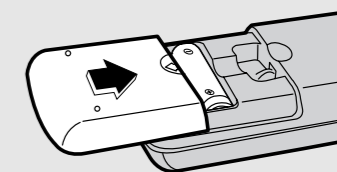

Caution

Follow these precautions to avoid leaking or cracking cells:

- Place batteries in the remote control so they match the polarity:(+) to (+)and (-)to (-).
- Use the correct type of batteries.Batteries that look similar may differ in voltage.
- Always replace both batteries at the same time.
- Do not expose batteries to heat or flame.

Range of Operation of the Remote Control

The remote control can be used up to approximately 23 feet/7 meters in a straight line. It can also be operated at a horizontal angle of up to 30° from the remote control sensor.

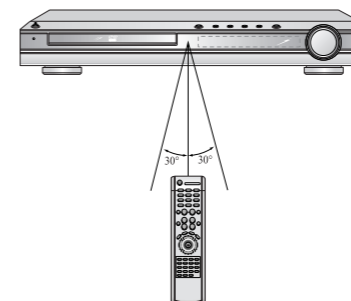

To open the remote control cover, push the top of the cover, then slide downward.

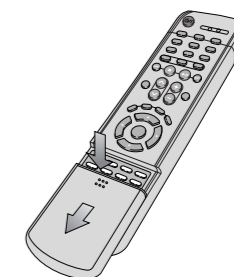

Connecting the Speakers

Before moving or installing the product, be sure to turn off the power and disconnect the power cord.

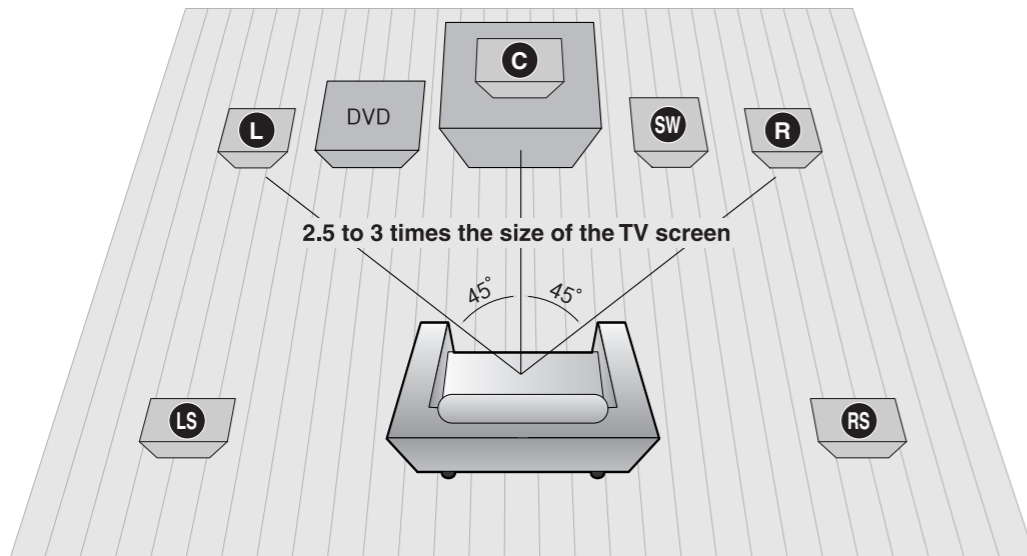

Position of the DVD Player

- Place it on a stand or cabinet shelf, or under the TV stand.

Selecting the Listening Position

The listening position should be located about 2.5 to 3 times the distance of the TV's screen size away from the TV. Example: For 32" TVs 2~2.4m (6~8feet)
For 55" TVs 3.5~4m (11~13feet)

Front Speakers **L R**

- Place these speakers in front of your listening position, facing inwards (about 45°) toward you.
- Place the speakers so that their tweeters will be at the same height as your ear.
- Align the front face of the front speakers with the front face of the center speaker or place them slightly in front of the center speakers.

Center Speaker **C**

- It is best to install it at the same height as the front speakers.
- You can also install it directly over or under the TV.

Rear Speakers **LS RS**

- Place these speakers behind your listening position.
- If there isn't enough room, place these speakers to face each other.
- Place them about 60 to 90cm (2 to 3feet) above your ear, facing slightly downward.

* Unlike the front and center speakers, the rear speakers are used to handle mainly sound effects and sound will not come from them all the time.

Subwoofer **SW**

- The position of the subwoofer is not so critical. Place it anywhere you like.
- Usually, it is placed by a corner near the front speakers.

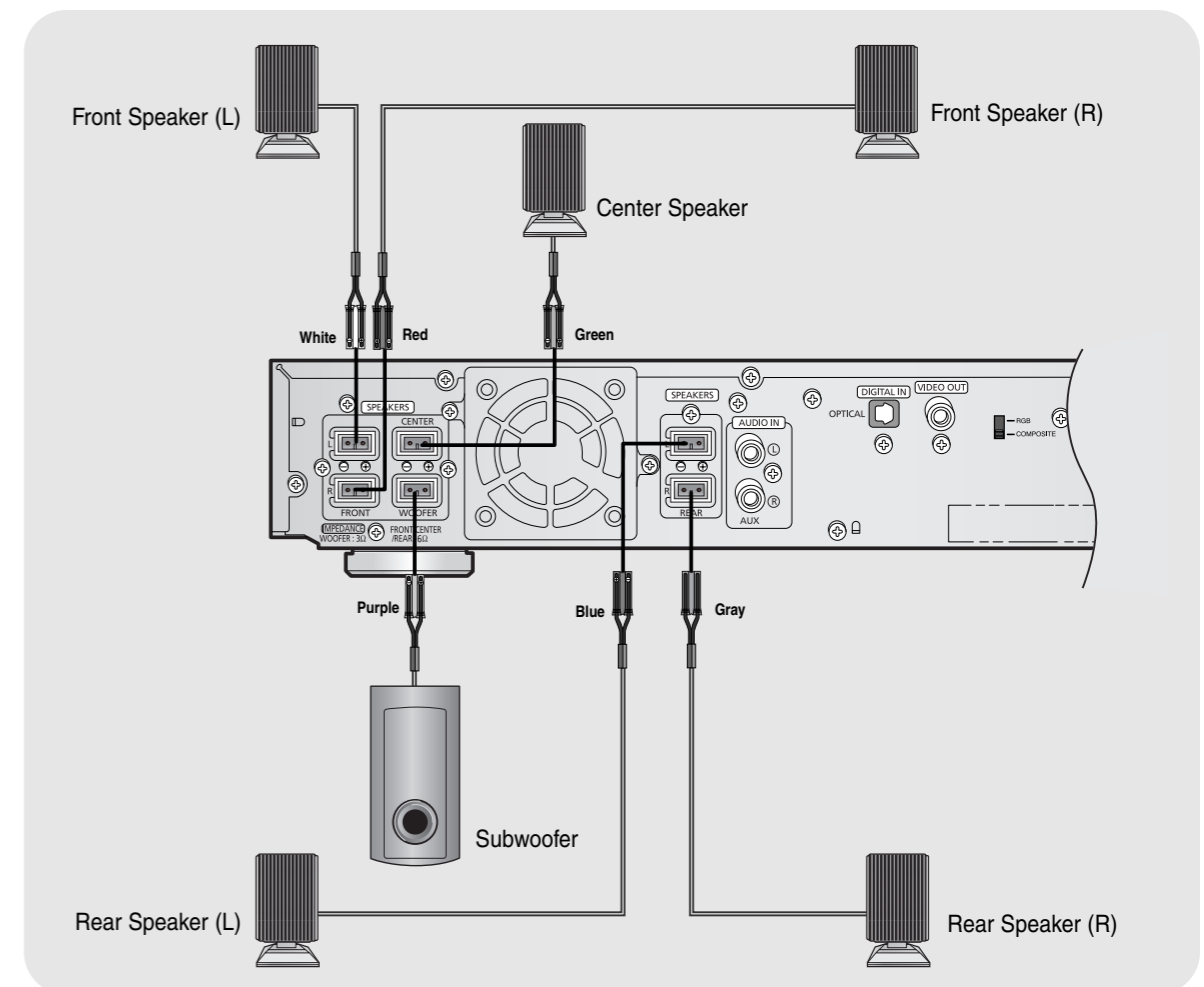

Back of the Speakers

- Press down the terminal tab on the back of the speaker.

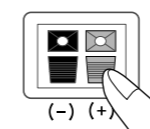

- Insert the wire into the terminal and release the terminal tab.

- Insert the black wire into the black (-) terminal and the gray wire into the gray (+) terminal.
- Make sure the polarities (+ and -) are correctly.

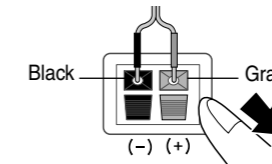

Back of the Main Unit

- Connect the connecting jacks to the back of the DVD player.

- Make sure the colors of the speaker terminals match the colors of the connecting jacks.
- Make sure the polarities (+ and -) are correctly.

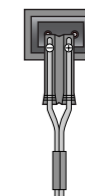

Connecting the FM and AM(MW) Antennas

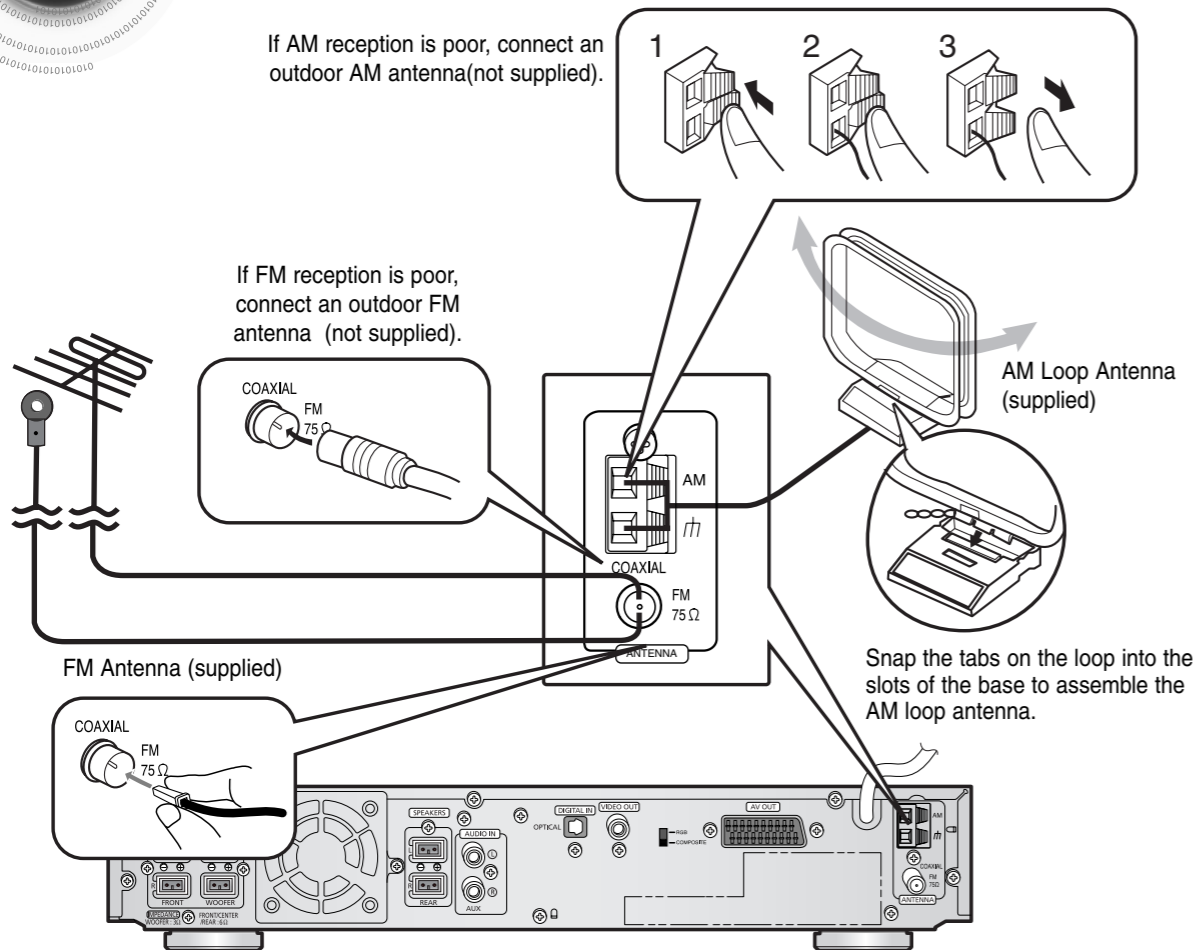

FM antenna connection

1. Connect the FM antenna supplied to the FM 75Ω COAXIAL terminal as a temporary measure.
2. Slowly move the antenna wire around until you find a location where reception is good, then fasten it to a wall or other rigid surface.

- If reception is poor, connect an outdoor antenna. Before attaching a 75Ω coaxial cable (with a standard type connector), disconnect the supplied FM antenna.

Cooling Fan

The cooling fan dissipates the heat generated inside the unit so that the unit can be operated normally. The cooling fan is activated automatically to supply cool air to the unit.

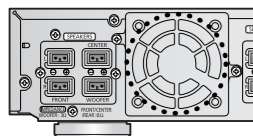

Please observe the following cautions for your safety.

- Make sure the unit is well-ventilated. If the unit has poor ventilation, the temperature inside the unit could rise and may damage it.
- Do not obstruct the cooling fan or ventilation holes. (If the cooling fan or ventilation holes are covered with a newspaper or cloth, heat may build up inside the unit and fire may result.)

AM(MW) antenna connection

1. Connect the AM loop antenna supplied to the AM and μ terminals.
2. If reception is poor, connect an outdoor single vinyl-covered wire to the AM terminal. (Keep the AM loop antenna connected).

Connecting the Video to TV

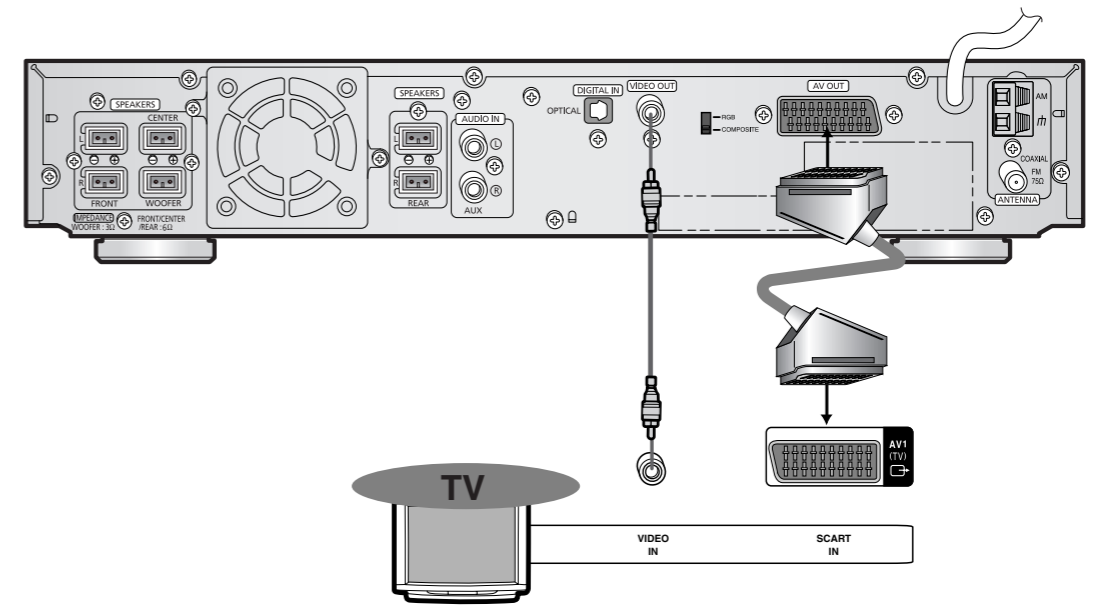

Composite Video (Good Quality)

Connect the supplied video cable from the VIDEO OUT jack on the back panel of the system to the VIDEO IN jack on your television.

Scart (Best Quality)

If you television is equipped with an SCART input, connect an Scart Jack (not supplied) from the AV OUT jack on the back panel of the system to the SCART IN jack on your television.

For using the SCART cable

- If Scart is equipped for your TV, set RGB-COMPOSITE selector of the center unit to RGB. You can get a better picture quality by using Scart setting.
- If Scart (RGB Input) is not equipped for your TV, set RGB-COMPOSITE selector to COMPOSITE.

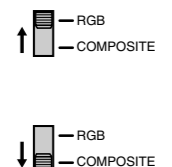

Note • On the rear panel SCART cable is indicated as "AV OUT."

Connecting External Components

Connecting an External Digital Component

Example: Digital signal components such as a DVD or CD Recorder.

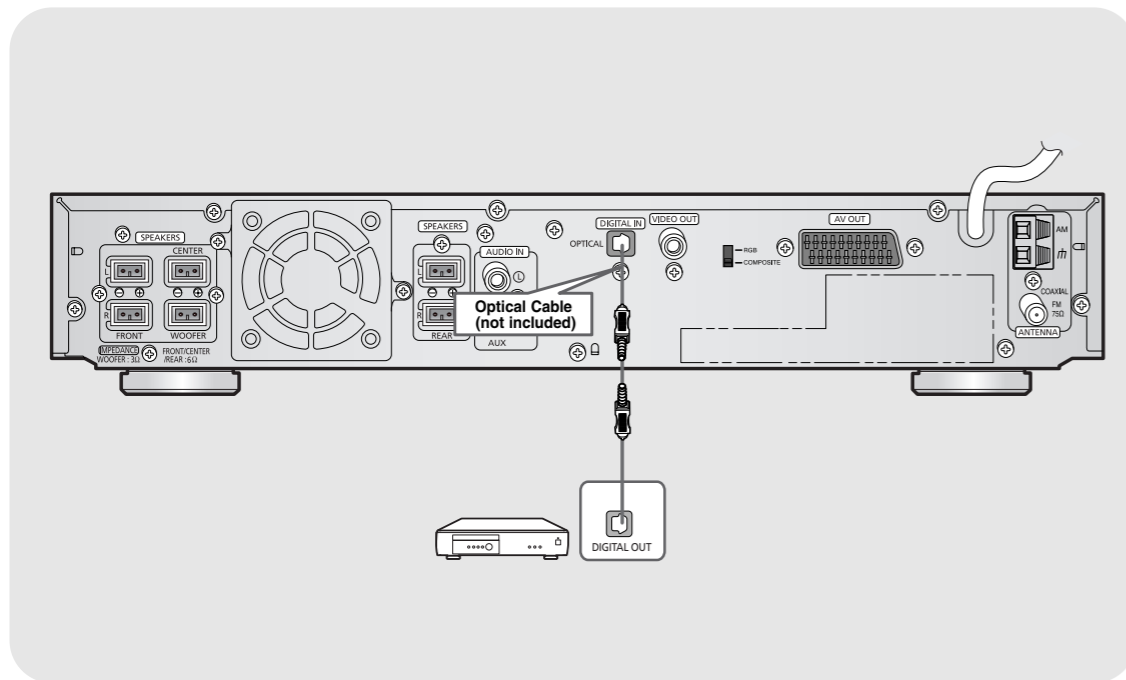

- 1 Connect the Digital Input (OPTICAL) to the Digital Output on the external digital component.
- 2 Press **AUX** on the remote control to select 'DIGITAL IN'.
 - Each time the button is pressed, the selection changes as follows: **DIGITAL IN** → **AUX**.
 - You can also use the **FUNCTION** button on the main unit.
The mode switches as follows: **DVD/CD** → **DIGITAL IN** → **AUX** → **FM** → **AM(MW)** → **LW(UK Only)**.

Connecting an External Analog Component

Example: Analog signal components such as a VCR, Camcorder, and TV.

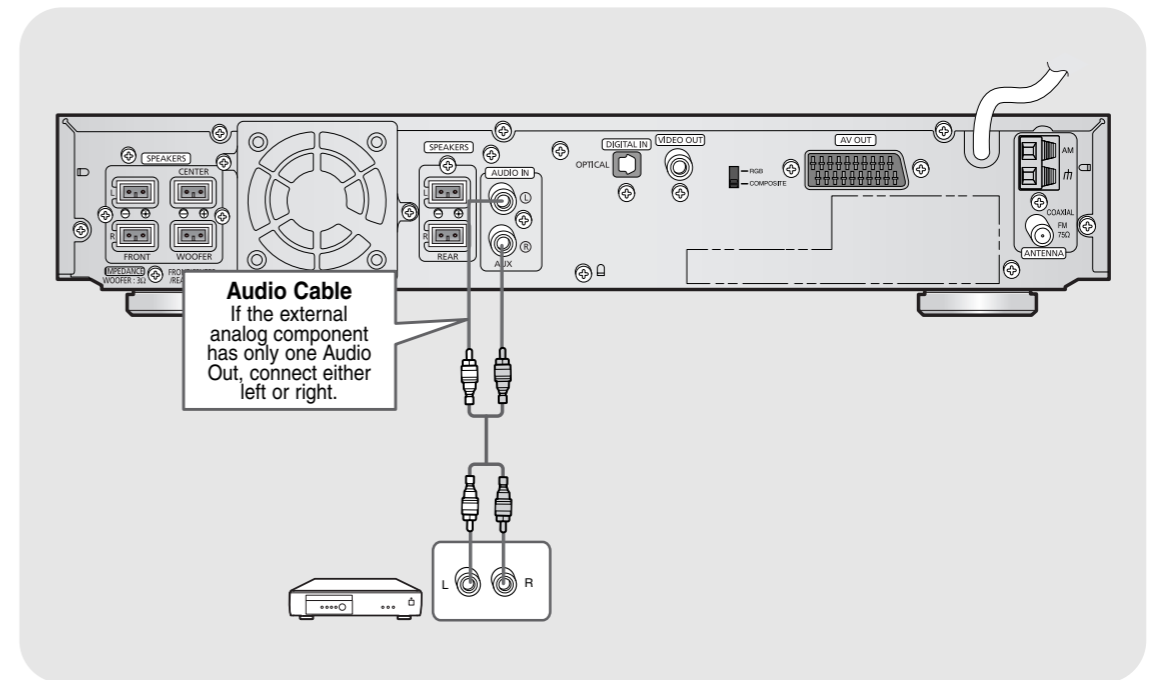

- 1 Connect Audio In on the DVD player to Audio Out on the external analog component.
 - Be sure to match connector colors.
- 2 Press **AUX** on the remote control to select **AUX**.
 - Each time the button is pressed, the selection changes as follows: **DIGITAL IN** → **AUX**.
 - You can also use the **FUNCTION** button on the main unit.
The mode switches as follows: **DVD/CD** → **DIGITAL IN** → **AUX** → **FM** → **AM(MW)** → **LW(UK Only)**.

Disc Playback

1 Press **OPEN/CLOSE** button to open the disc tray.

3 Press **OPEN/CLOSE** button to close the disc tray.

DVD CD

- Playback starts automatically.

MP3 JPEG

- Playback starts automatically.
- If the TV is on, a list of MP3s on the CD will appear on the TV screen.



2 Load a disc.

- Place a disc gently into the tray with the disc's label facing up.

To stop playback, press **STOP** during playback.

- If pressed once, "PRESS PLAY" is displayed and the stop position will be stored in memory. If **PLAY/PAUSE** (▶||) button or **ENTER** button is pressed, playback resumes from the stop position. (This function works only with DVDs.)
- If pressed twice, "STOP" is displayed, and if **PLAY/PAUSE** (▶||) button is pressed, playback starts from the beginning.

To temporarily pause playback, press **PLAY/PAUSE** during playback.

- To resume playback, press **PLAY/PAUSE** button again.

Note

- Depending on the content of the disc, the initial screen may appear different.
- Depending on the recording mode, some MP3-CDs cannot be played.
- Table of contents of a MP3-CD varies depending on the MP3 track format recorded on the disc.

Displaying Disc Information

You can view playback information on the disc on the TV screen.

Press **INFO** button.

- Each time the button is pressed, the display changes as follows:



Display disappears

MP3 JPEG



Display disappears

Note

- Depending on the disc, the disc information display may appear different.
- Depending on the disc, you can also select DTS, DOLBY DIGITAL, or PRO LOGIC.

What is a Title?

A movie contained in a DVD disc.

What is a Chapter?

Each title on a DVD disc is divided into several smaller sections called "chapters".

Hand icon appears on the TV screen!

If this symbol appears on the TV screen while buttons are being operated, that operation is not possible with the disc currently being played.

What is a Track (File)?

A section of video or a music file recorded on a CD, or MP3-CD.

Checking the Remaining Time

Press the **REMAIN** button.

- For checking the total and remaining time of a title or chapter being played.

Each time the **REMAIN** button is pressed

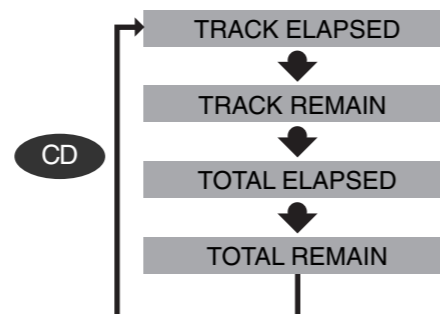
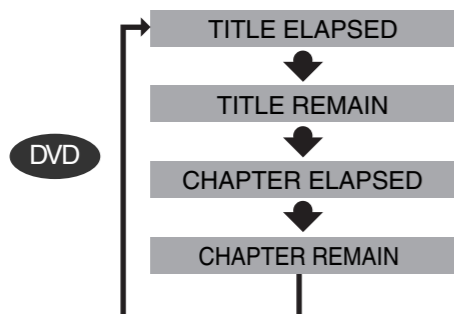

Screen Display

DVD DVD display	CHAPTER display	AUDIO LANGUAGE display	LR STEREO (L/R) display
CD CD display	TRACK (FILE) display	SUBTITLE display	DOLBY DIGITAL display
MP3 MP3 CD display	ELAPSED TIME display	ANGLE display	
TITLE display	REPEAT PLAYBACK display		

Fast/Slow Playback

Fast Playback DVD CD MP3

Press and hold **⏮** **⏭** .

- Each time the button is held down during playback, the playback speed changes as follows:

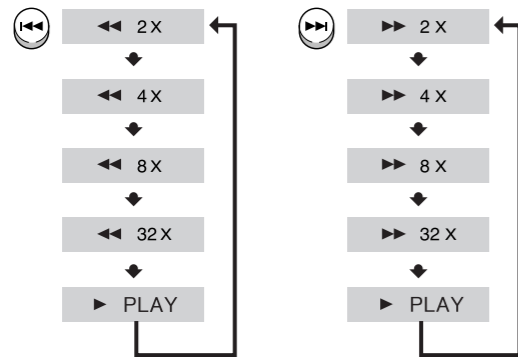

Slow Playback

Press **SLOW** button.

- Each time the button is pressed during playback, the playback speed changes as follows:

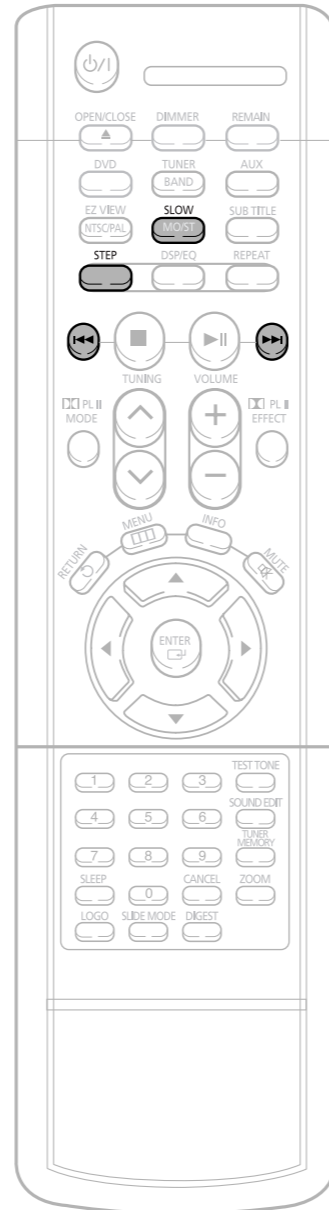
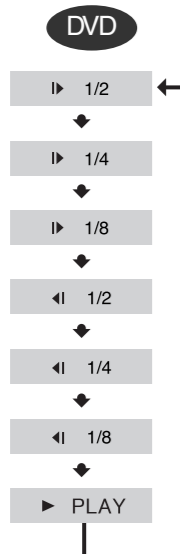

Skipping Scenes/Songs

DVD CD MP3

Briefly press **⏮** **⏭** .

- Each time the button is pressed briefly during playback, the previous or next chapter, track, or directory (file) will be played.
- But, you cannot skip chapters consecutively.

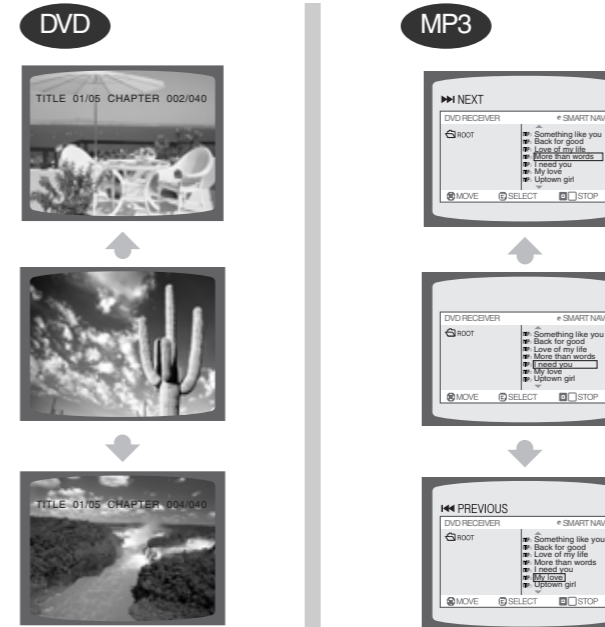

Playing Frame by Frame DVD

Press **STEP** button.

- The picture moves forward one frame each time the button is pressed during playback.



Note

- During fast playback of a CD or MP3-CD, sound is heard only at 2x speed, and not at 4x, 8x, and 32x speeds.
- No sound is heard during slow playback and step motion playback.

Repeat Playback

Repeat playback allows you to repeatedly play a chapter, title, track (song), or directory (MP3 file).

DVD CD MP3 JPEG

Press **REPEAT** button.

- Each time the button is pressed during playback, the repeat playback mode changes as follows:

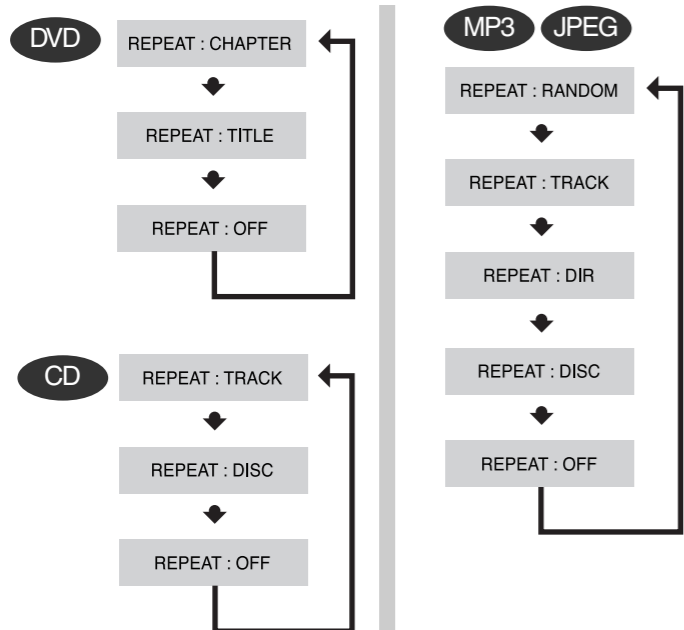

Repeat Playback Options

- CHAPTER**
Repeatedly plays the selected chapter.
- TITLE**
Repeatedly plays the selected title.
- RANDOM**
Plays tracks in random order.
(A track that has already been played may be played again.)
- TRACK**
Repeatedly plays the selected track.
- FOLDER**
Repeatedly plays all tracks in the selected folder.
- DISC**
Repeatedly plays the entire disc.
- OFF**
Cancels Repeat Playback.

To Select a Repeat Playback Mode in the Disc Information Screen

- 1 Press **INFO** button twice.
- 2 Press Cursor **▶** button to move to REPEAT PLAYBACK display.
- 3 Press Cursor **▼** button to select the desired Repeat Playback mode.
- 4 Press **ENTER** button.

* For MP3 and JPEG discs, you cannot select Repeat Play from the information display screen.



A-B Repeat Playback

DVD CD

- 1 Press **INFO** button twice.

- For a CD, press **INFO** button once.

DVD KO 1/3 OFF/ 02 OFF

- 2 Press Cursor **▶** button to move to REPEAT PLAYBACK display.

DVD KO 1/3 OFF/ 02 OFF

- 3 Press Cursor **▲**, **▼** buttons to select 'A-' and then press **ENTER** button at the beginning of the desired segment.

- When **ENTER** button is pressed, the selected position will be stored in memory.

DVD KO 1/3 OFF/ 02 A-



DVD KO 1/3 OFF/ 02 A-
REPEAT: A-

- 4 Press **ENTER** button at the end of the desired segment.

- The specified segment will be played repeatedly.

DVD KO 1/3 OFF/ 02 A-B
REPEAT: A-B

To return to normal playback, press Cursor **▲**, **▼** buttons to select **OFF**.

Note

- The A-B Repeat function will not work on an MP3 or JPEG disc.

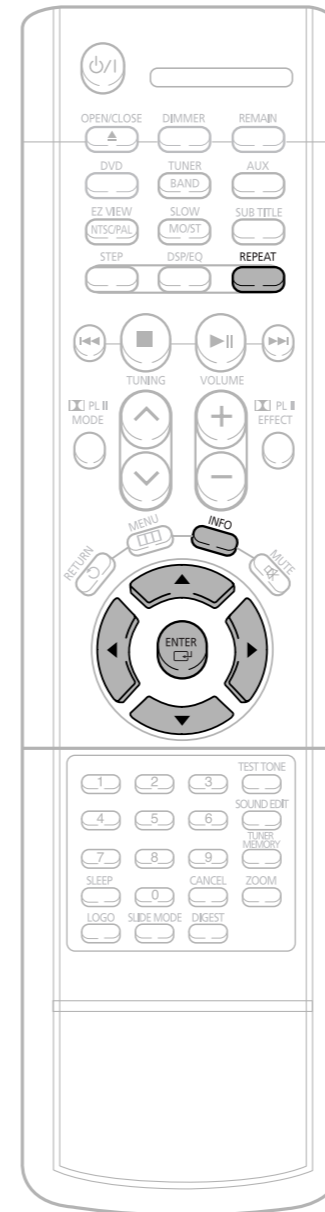

Angle Function

This function allows you to view the same scene in different angles.

Zoom Function

This function allows you to enlarge a particular area of the displayed image.

DVD

1 Press **INFO** button.

2 Press Cursor **▶** button to move to **ANGLE** display.

DVD 01/01 001/040 0:00:37 1/3

DVD 01/01 001/040 0:00:37 1/3

3 Press Cursor **▲**, **▼** buttons or numeric buttons to select the desired angle.

• Each time the button is pressed, the angle changes as follows:

DVD 01/01 001/040 0:00:37 1/3
2/3
3/3



Note • The Angle function works only with discs on which multiple angles have been recorded.

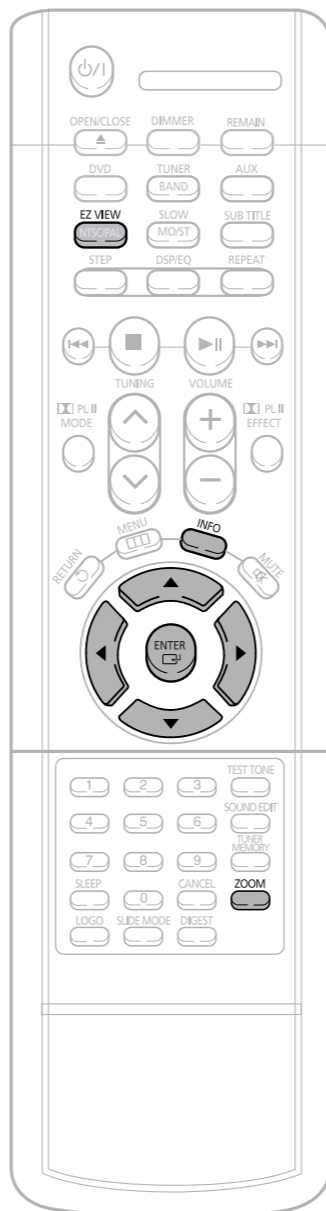

Zoom (Screen Enlarge) Function

DVD

1 Press **ZOOM** button.

2 Press Cursor **▲**, **▼**, **◀**, **▶** buttons to move to the area you want to enlarge.

3 Press **ENTER** button.

• Each time the button is pressed, the zoom level changes as follows:

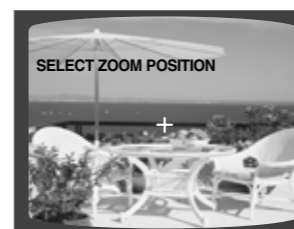
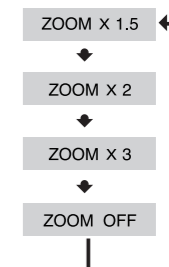

Aspect Ratio

DVD

Press **EZ VIEW** button.

- Each time the button is pressed, the zoom function will switch between On and Off.
- When a movie is played in Widescreen format, black bars at the top and bottom of the TV screen can be removed by pressing the **EZ VIEW** button.

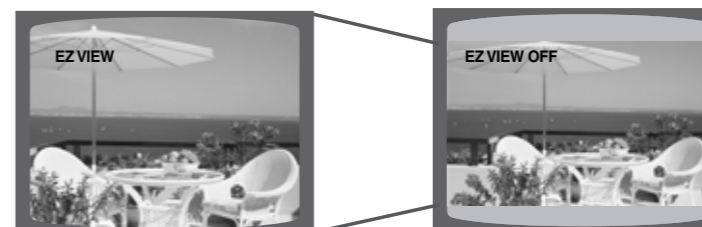

Note

- This function will not work if the DVD is recorded with multi-camera angle format.
- Black bars may not disappear because some DVD discs have a built-in horizontal to vertical ratio.

OPERATION

Selecting Audio/Subtitle Language

Audio Language Selection Function DVD

1 Press **INFO** button twice.

DVD KO 1/3

2 Press Cursor **▲**, **▼** buttons or numeric buttons to select the desired audio language.

- Depending on the number of languages on a DVD disc, a different audio language (KOREAN, ENGLISH, JAPANESE, etc.) is selected each time the button is pressed.

DVD KO 1/3

EN 2/3
JA 3/3

Subtitle Language Selection Function DVD

1 Press **INFO** button twice.

DVD KO 1/3

2 Press Cursor **▶** button to move to **SUBTITLE** display.

DVD KO 1/3

3 Press Cursor **▼** button or numeric buttons to select the desired subtitle.

DVD KO 1/3

EN 02/ 03
JA 03/ 03
OFF / 03

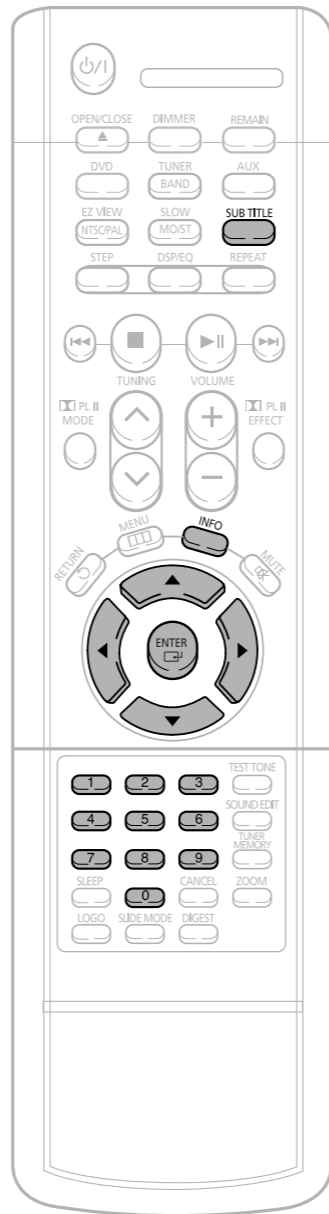

Note

- You can use the **SUBTITLE** button on the remote control to select a subtitle language.
- Depending on the disc, the Subtitle and Audio Language functions may not work.

Moving Directly to a Scene/Song

DVD CD

1 Press **INFO** button.

DVD 01/05 001/040 0:00:37 1/1

Moving to a Title/Track

2 Press Cursor **▲**, **▼** buttons or numeric buttons to select the desired title/track and then press **ENTER** button.

DVD 03/05 001/002 0:00:01 1/1

Moving to a Chapter

3 Press Cursor **◀**, **▶** buttons to move to Chapter display.

DVD 01/05 001/040 0:00:01 1/1

Moving to a Chapter

4 Press Cursor **▲**, **▼** buttons or numeric buttons to select the desired chapter and then press **ENTER** button.

DVD 01/05 025/040 0:00:01 1/1

Moving to a Specific Time

5 Press Cursor **◀**, **▶** buttons to move to time display.

DVD 01/05 025/040 1:17:30 1/1

Moving to a Specific Time

6 Press the numeric buttons to select the desired time and then press **ENTER** button.

DVD 01/05 028/040 1:30:00 1/1

MP3 JPEG

Press the **numeric** buttons.

- The selected file will be played.
- An MP3 or JPEG disc cannot be moved from the disc information screen.
- When playing an MP3 or JPG disc, you cannot use **▲**, **▼** to move a folder. To move a folder, press **■** (Stop) and then press **▲**, **▼**.

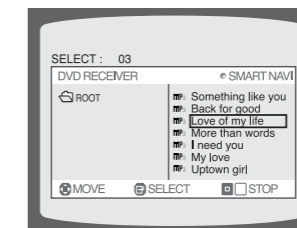

Note

- You can press **◀◀▶▶** on the remote control to move directly to the desired title, chapter, or track.
- Depending on the disc, you may not be able to move to the selected title or time.

JPEG File Playback JPEG

Images captured with a digital camera or camcorder, or JPEG files on a PC can be stored on a CD and then played back with this DVD player.

Slide Mode

1 Place the JPEG disc on the disc tray.

2 Press the **OPEN/CLOSE** button.

3 Press **SLIDE MODE** button.

- Playback starts automatically.
- Each time the button is pressed, the image makes the transition as follows:

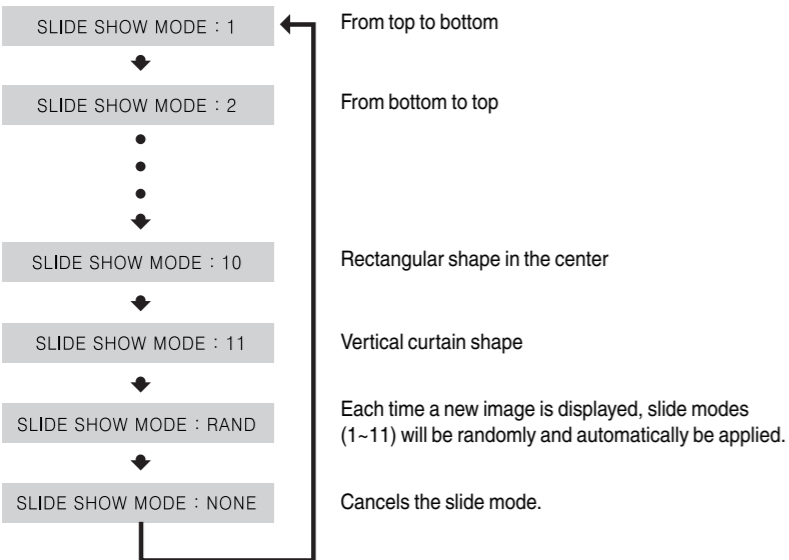

Press **◀◀▶▶** to skip to the next slide.

- Each time the button is pressed, the slide moves backward or forward.

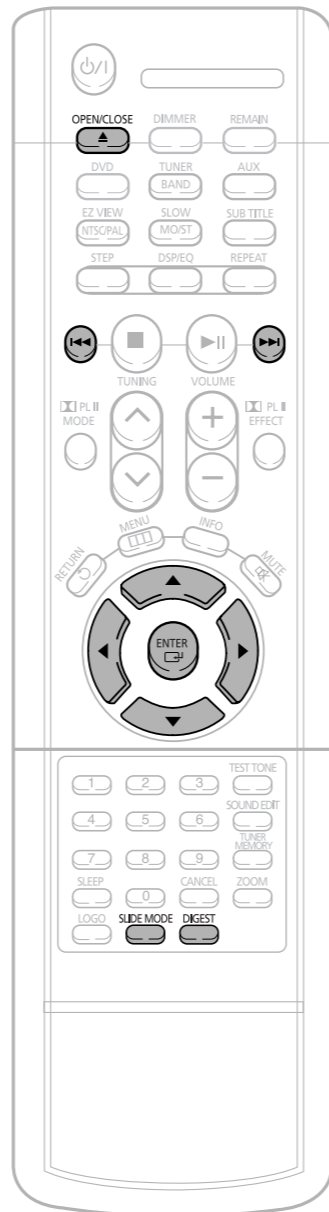

Digest Function

You can view 9 JPEG images on the TV screen.

1 Press **DIGEST** button during playback.

- JPEG files will be shown in 9 windows.



2 Press Cursor **▲, ▼, ◀, ▶** buttons to select the desired image and then press **ENTER** button.

- The selected image is played for 5 seconds before moving to the next image.

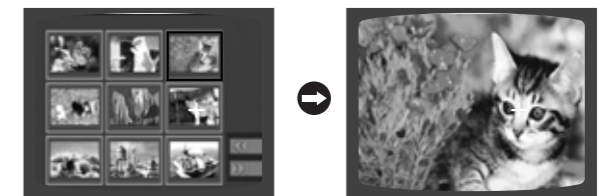

To view the previous or next image with 9 windows, press **◀◀▶▶**.

Rotate/Flip Function

Press Cursor **▲, ▼, ◀, ▶** buttons during playback.

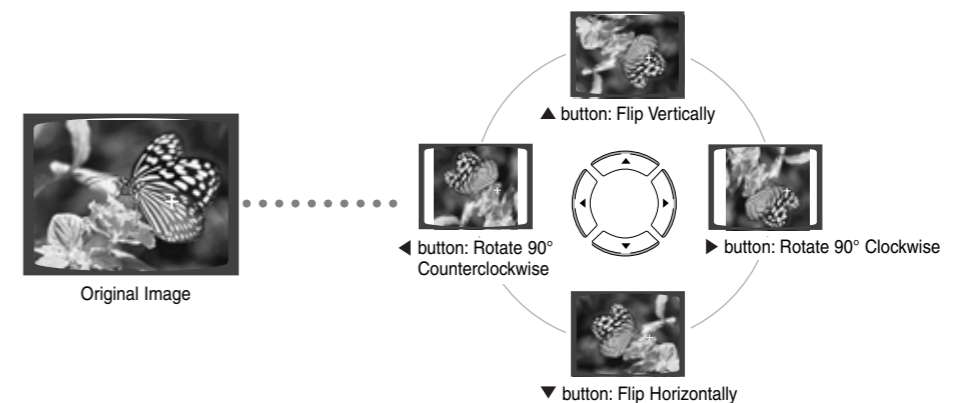

Using Disc Menu

You can use the menus for the audio language, subtitle language, profile, etc. DVD menu contents differ from disc to disc.

Using the Title Menu

For DVDs containing multiple titles, you can view the title of each movie. Depending on the disc, this function may either not work at all or may work differently.

DVD

1 Press **MENU** button.



2 Press Cursor **▲**, **▼** buttons to move to 'DISC MENU' and then press **ENTER** button.

- When you select the disc menu that is not supported by the disc, the "This menu is not supported" message appears on the screen.



3 Press Cursor **▲**, **▼**, **◀**, **▶** buttons to select the desired item.



4 Press **ENTER** button.

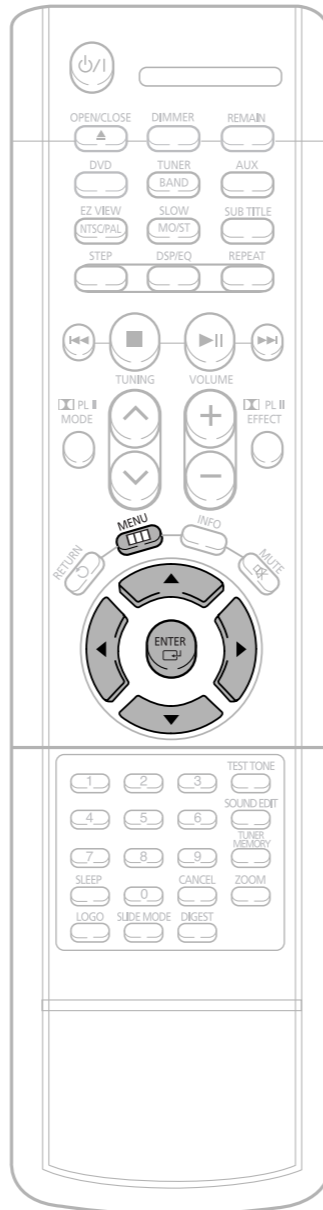

DVD

1 Press **MENU** button.



2 Press Cursor **▲**, **▼** button to move to 'Title Menu'.



3 Press **ENTER** button.

- The title menu appears.



Press **MENU** button to exit the setup screen.

OPERATION

Setting the Language

OSD language is set to English by default.

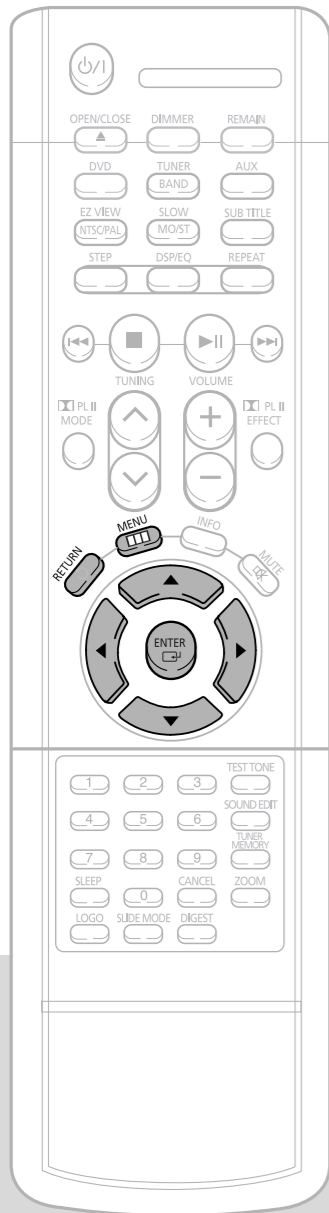

1 Press **MENU** button.



2 Press Cursor **▼** button to move to 'Setup' and then press **ENTER** button.



3 Press **ENTER** button.



4 Press Cursor **▲, ▼** button to select the desired item and then press **ENTER** button.



5 Press Cursor **▲, ▼** button to select the desired language and then press **ENTER** button.

- Once the setup is complete, if the language was set to English, OSD will be displayed in English.



Press **RETURN** button to return to the previous level.

Press **MENU** button to exit the setup screen.



Selecting the OSD Language



Selecting the Audio Language (recorded on the disc)



Selecting the Subtitle Language (recorded on the disc)



Selecting the Menu Language (recorded on the disc)

* If the language you selected is not recorded on the disc, menu language will not change even if you set it to your desired language.

SETUP

Setting TV Screen type

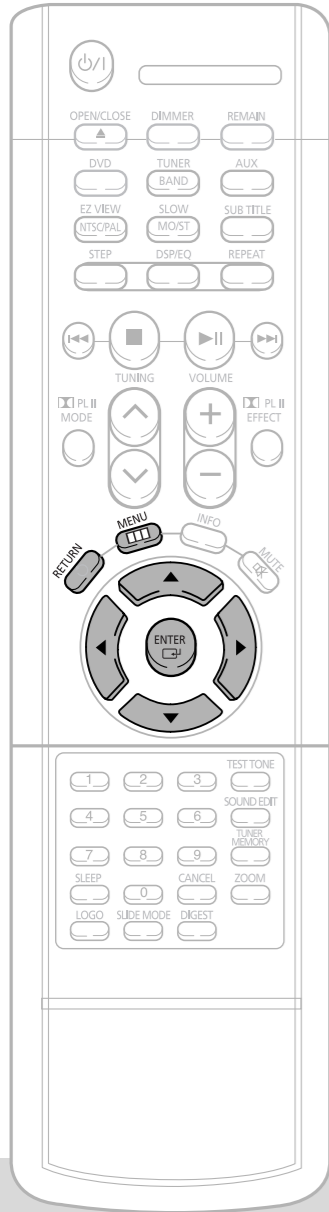

1 Press **MENU** button.



2 Press Cursor **▼** button to move to 'Setup' and then press **ENTER** button.



3 Press Cursor **▼** button to move to 'TV DISPLAY' and then press **ENTER** button.



4 Press Cursor **▲,▼** button to select the desired item and then press **ENTER** button.

- Once the setup is complete, you will be taken to the previous screen.



Press **RETURN** button to return to the previous level.

Press **MENU** button to exit the setup screen.

Adjusting the TV Aspect Ratio (Screen Size)

The horizontal to vertical screen size ratio of conventional TVs is 4:3, while that of widescreen and high definition TVs is 16:9. This ratio is called the aspect ratio. When playing DVDs recorded in different screen size, you should adjust the aspect ratio to fit your TV or monitor.

* For a standard TV, select either "4:3LB" or "4:3PS" option according to personal preference. Select "16:9" if you have a widescreen TV.

WIDE

- : Select this to view a 16:9 picture in the full-screen mode on your widescreen TV.
- You can enjoy the widescreen aspect.



4:3LB (4:3 Letterbox)

- : Select this to play a 16:9 picture in the letter box mode on a conventional TV.
- Black bars will appear at the top and bottom of the screen.



4:3PS (4:3 Pan&Scan)

- : Select this to play a 16:9 picture in the pan & scan mode on a conventional TV.
- You can see the central portion of the screen only (with the sides of the 16:9 picture cut off).

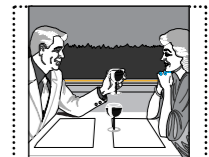

Note

- If a DVD is in the 4:3 ratio, you cannot view it in widescreen.
- Since DVD discs are recorded in various image formats, they will look different depending on the software, the type of TV, and the TV aspect ratio setting.

Setting Parental Controls (Rating Level)

Use this to restrict playback of adult or violent DVDs you do not want children to view.

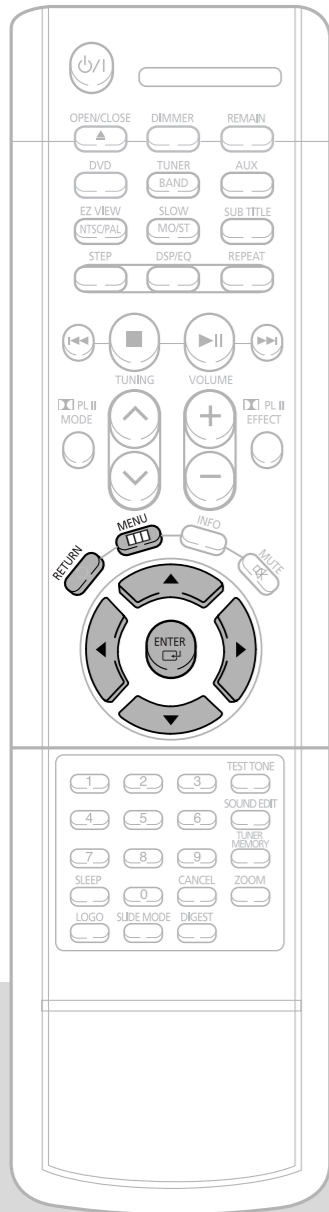

1 Press **MENU** button.



2 Press Cursor **▼** button to move to 'Setup' and then press **ENTER** button.



3 Press Cursor **▼** button to move to 'PARENTAL' and then press **ENTER** button.



4 Press Cursor **▲, ▼** button to select the desired rating level and then press **ENTER** button.

- If you have selected Level 6, you cannot view DVDs with Level 7 or higher.
- The higher the level, the closer the content is to violent or adult material.



5 Enter the password and then press **ENTER** button.

- The password is set to "7890" by default.
- Once the setup is complete, you will be taken to the previous screen.



Note • This function works only if a DVD disc contains the rating level information.

Press **RETURN** button to return to the previous level.

Press **MENU** button to exit the setup screen.

Setting the Password

You can set the password for the Parental (rating level) setting.

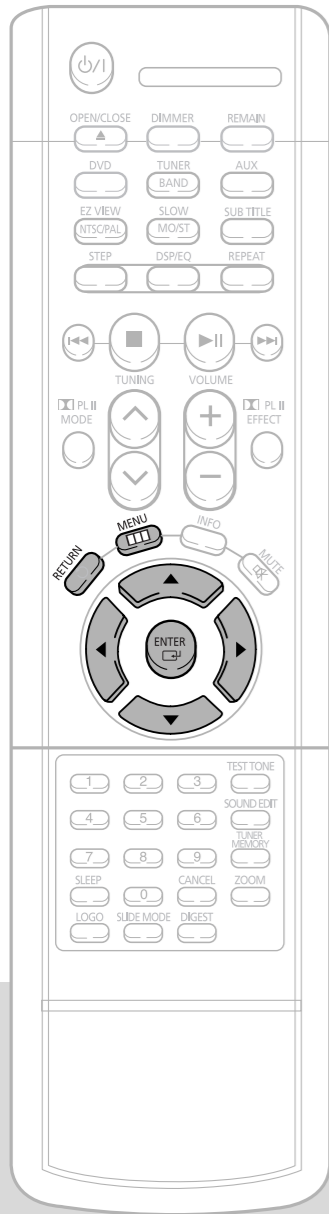

1 Press **MENU** button.



2 Press Cursor **▼** button to move to 'Setup' and then press **ENTER** button.



3 Press Cursor **▼** button to move to 'PASSWORD' and then press **ENTER** button.

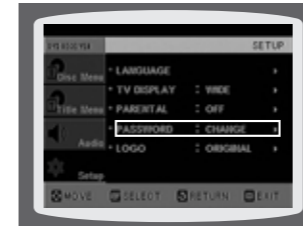

4 Press **ENTER** button.



5 Enter the password and then press **ENTER** button.

- Enter the old password, a new password, and confirm new password.
- The setting is complete.



Press **RETURN** button to return to the previous level.

Press **MENU** button to exit the setup screen.

Setting the Wallpaper

JPEG DVD

While watching a DVD or JPEG CD, you can set the image you like as a wallpaper.

Setting the Wallpaper

- 1 During playback, press **PLAY/PAUSE** button when the image you like comes up.



- 2 Press **LOGO** button.

- "LOGO COPY DATA" will be displayed on the TV screen.



- 3 The power will turn off and then back on and the disc tray will open automatically.

- The selected wallpaper will be displayed.

- 4 Press **OPEN/CLOSE** to close the disc tray.

- You can repeat Steps 1 and 2 to set up to 3 wallpapers.

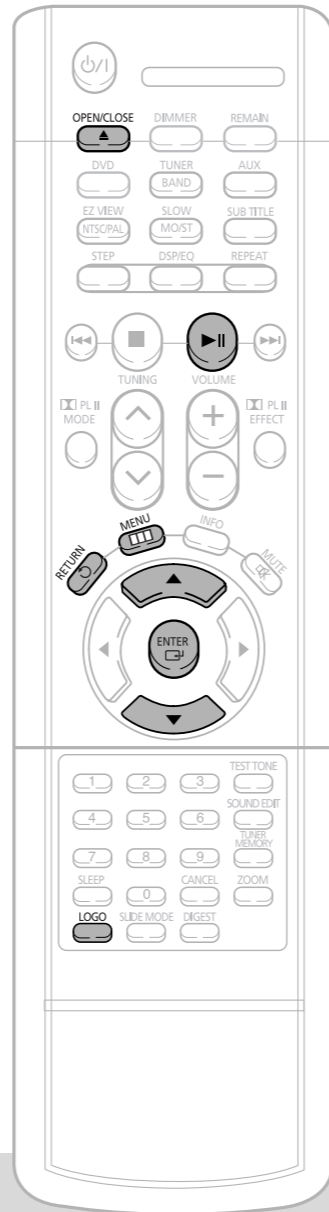

To Change the Wallpaper

- 1 Press **MENU** button.



- 2 Press Cursor **▼** button to move to 'Setup' and then press **ENTER** button.



- 3 Press Cursor **▼** button to move to 'LOGO' and then press **ENTER** button.



- 4 Press **▼** to select the desired 'USER', and then press **ENTER**.



- 5 Press **MENU** button to exit the setup screen.



Select this to set the Samsung Logo image as your wallpaper.



Select this to set the desired image as your wallpaper.

Press **RETURN** button to return to the previous level.

Press **MENU** button to exit the setup screen.

Setting the Speaker Mode

1 Press **MENU** button.



2 Press Cursor **▼** button to move to 'Audio' and then press **ENTER** button.



3 In the Speaker Setup, press the **ENTER** button again.



4 Press Cursor **▲, ▼, ◀, ▶** buttons to move to the desired speaker and then press **ENTER** button.

- For C, LS, and RS, each time the button is pressed, the mode switches alternately as follows: **SMALL** → **NONE**.
- For L and R, the mode is set to **SMALL**.

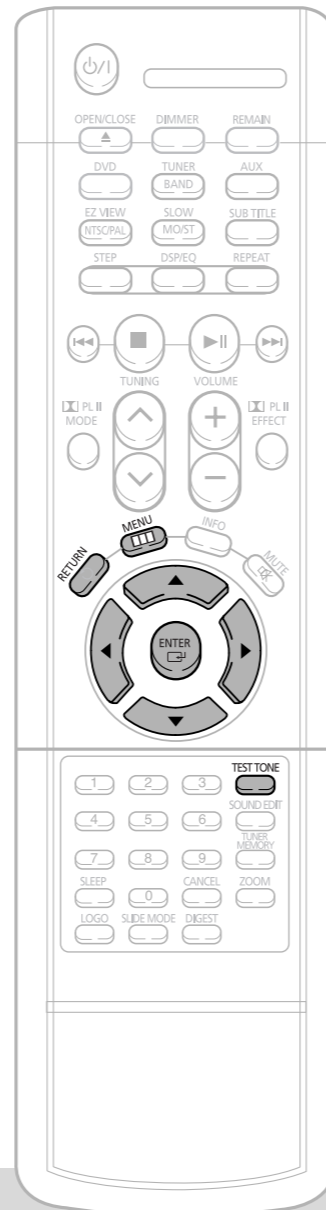

SMALL : Select this when using the speakers.
NONE : Select this when no speakers are installed.

Note

- With **Dolby Pro Logic II** (Dolby Pro Logic II), the delay time may be different for each mode.
- With **AC-3** and **DTS**, the delay time is set between 00 and 15mSEC.
- Depending on **PRO LOGIC** and **STEREO**, the speaker mode may vary.

Setting the Test Tone

1 Press **MENU** button.



2 Press Cursor **▼** button to move to 'Audio' and then press **ENTER** button.



3 Press Cursor **▼** button to move to 'TEST TONE' and then press **ENTER** button.

- The test tone will be sent to **L → C → R → RS → LS → SW** in that order. If the button is pressed again at this time, the test tone will stop.



Press **RETURN** button to return to the previous level.

Press **MENU** button to exit the setup screen.

When manually testing using the **TEST TONE** button

L: Front Speaker (L) C: Center Speaker SW: Subwoofer
 R: Front Speaker (R) LS: Rear Speaker (L) RS: Rear Speaker (R)

Press **TEST TONE** button.

- Test tone will be produced as follows: When playing a DVD or CD, this will work only in Stop mode.
- Use this function to check that each speaker is correctly connected and that there is no problem.

To end the test tone, press **TEST TONE** button.

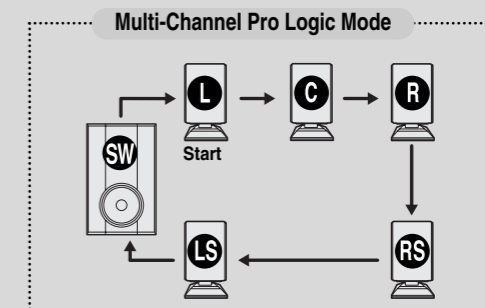

Setting the Delay Time

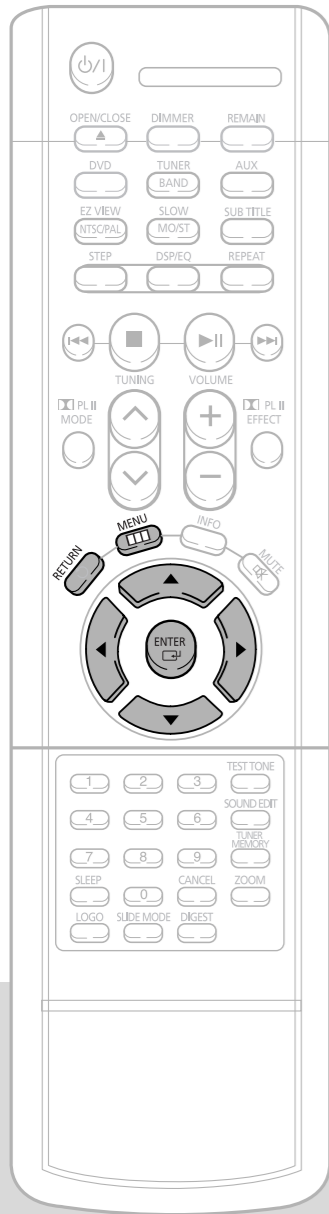

1 Press **MENU** button.



2 Press Cursor **▼** button to move to 'Audio' and then press **ENTER** button.



3 Press Cursor **▼** button to move to 'DELAY TIME' and then press **ENTER** button.



4 Press Cursor **▲, ▼, ◀, ▶** buttons to move to the desired speaker and then press **ENTER** button.



5 Press Cursor **◀, ▶** to set the Delay time.

- You can set the delay time for C between 00 and 05mSEC and for LS and RS between 00 and 15mSEC.



Setting up the Speaker Delay Time

When 5.1CH Surround Sound is played, you can enjoy the best sound if the distance between you and each speaker is the same. Since the sounds arrive at the listening position at different times depending on the placement of speakers, you can adjust this difference by adding a delay effect to the sound of the Center Speaker and Surround Speakers.

• Setting CENTER SPEAKER

If the distance of D_c is equal to or longer than the distance of D_f in the figure, set the mode as 0ms. Otherwise, change the setting according to the table.

Distance between D_f and D_c	Delay Time
50	1.3 ms
100	2.6 ms
150	3.9 ms
200	5.3 ms

• Setting REAR (SURROUND) SPEAKERS

If the distance of D_f is equal to the distance of D_s in the figure, set the mode as 0ms. Otherwise, change the setting according to the table.

Distance between D_s and D_c	Delay Time
200	5.3 ms
400	10.6 ms
600	15.9 ms

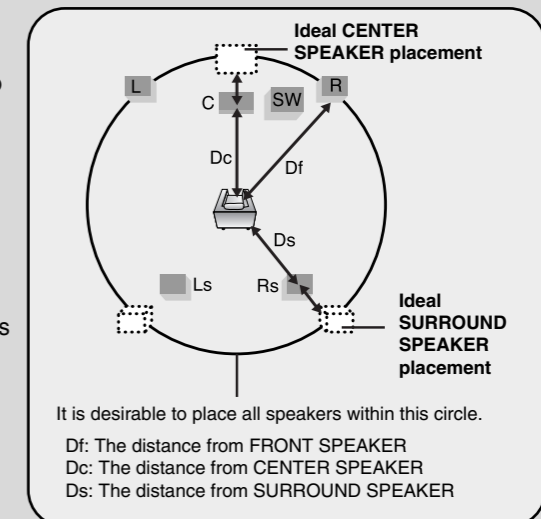

Setting the Audio Quality

You can adjust the balance and level for each speaker.

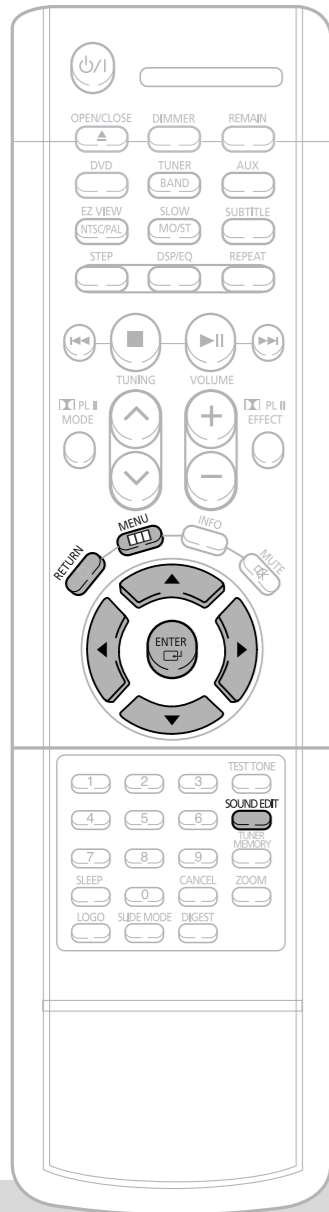

Method 1 When adjusting the audio quality using the setup screen

1 Press **MENU** button.



2 Press Cursor **▼** button to move to 'Audio' and then press **ENTER** button.



3 Press Cursor **▼** button to move to 'SOUND EDIT' and then press **ENTER** button.



4 Press Cursor **▲, ▼, ◀, ▶** buttons to select the desired item and then press **ENTER** button.



Method 2 When manually adjusting with the SOUND EDIT button

Adjusting Front Speaker Balance

1 Press **SOUND EDIT** button and then press Cursor **◀, ▶**.



Adjusting Rear Speaker Balance

2 Press **SOUND EDIT** button and then press Cursor **◀, ▶**.



Adjusting Center Speaker Level

3 Press **SOUND EDIT** button and then press Cursor **◀, ▶**.



Adjusting Rear Speaker Level

4 Press **SOUND EDIT** button and then press Cursor **◀, ▶**.



Adjusting Subwoofer Speaker Level

5 Press **SOUND EDIT** button and then press Cursor **◀, ▶**.



Press **RETURN** button to return to the previous level.

Press **MENU** button to exit the setup screen.

Note

- Adjusting Front/Rear Speaker Balance**
- You can select between 00 and -06 and OFF.
 - The volume decreases as you move closer to -6.

- Adjusting Center/Rear/Subwoofer Speaker Level**
- The volume level can be adjusted in steps from +6dB to -6dB.
 - The sound gets louder as you move closer to +6dB and smaller as you get closer to -6dB.

Setting the DRC (Dynamic Range Compression)

You can use this function to enjoy Dolby Digital sound when watching movies at low volume at night.

Sound Field (DSP)/EQ Function

DSP (Digital Signal Processor) DSP modes have been designed to simulate different acoustic environments.
EQ: You can select from ROCK, POP, or CLASSIC, depending on the genre of music.

1 Press **MENU** button.



2 Press Cursor **▼** button to move to 'Audio' and then press **ENTER** button.



3 Press Cursor **▼** button to move to 'DRC' and then press **ENTER** button.



4 Press Cursor **▲, ▼** to adjust the 'DRC'.

- The longer the Cursor **▲** button is held down, the greater the effect, and the longer Cursor **▼** button is held down, the smaller the effect.
- Once the setup is complete, you will be taken to the previous screen.



Press **RETURN** button to return to the previous level.

Press **MENU** button to exit the setup screen.

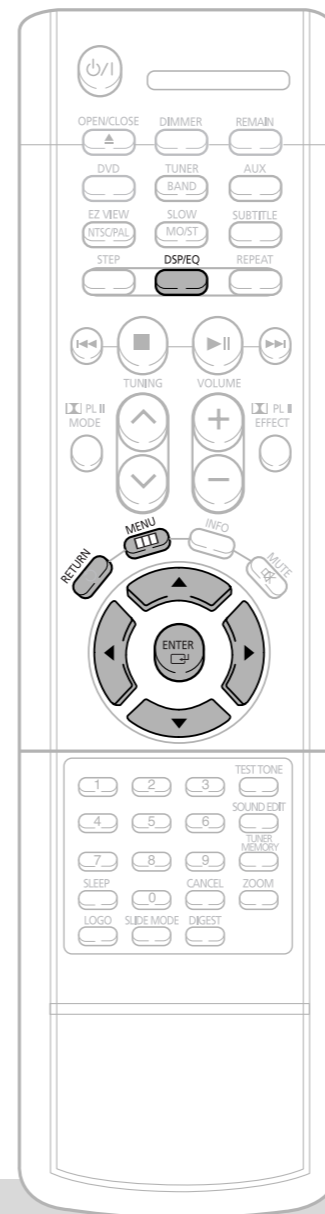

Press **DSP/EQ** button.

- "DSP" appears on the display panel.
- Each time the button is pressed, the selection changes as follows:

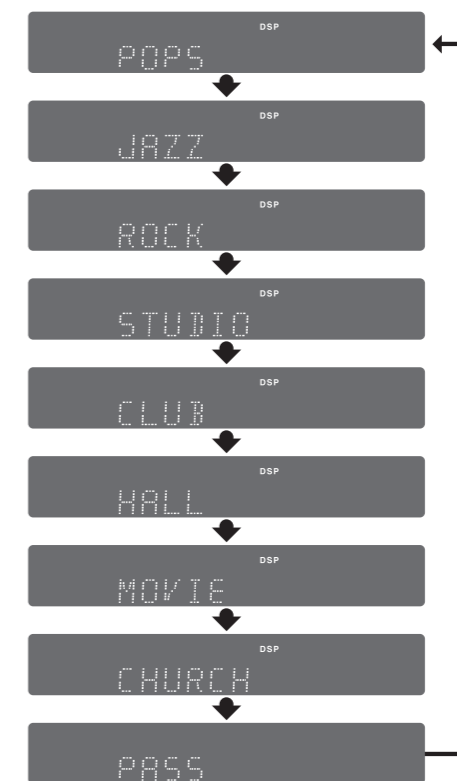

Note

- POP, JAZZ, ROCK:** Depending on the genre of music, you can select from POP, JAZZ, and ROCK.
- STUDIO:** Provides a sense of presence as if in a studio.
- CLUB:** Simulates the sound of a dance club with a throbbing bass beat.
- HALL:** Provides a clear vocal as if listening in a concert hall.
- MOVIE:** Provides the feeling of a movie theater.
- CHURCH:** Gives the feel of being in a grand church.
- PASS:** Select this for normal listening.

Dolby Pro Logic II Mode

You can select the desired Dolby Pro Logic II audio mode.

Press **PL II MODE** button.

- Each time the button is pressed, the mode changes as follows.

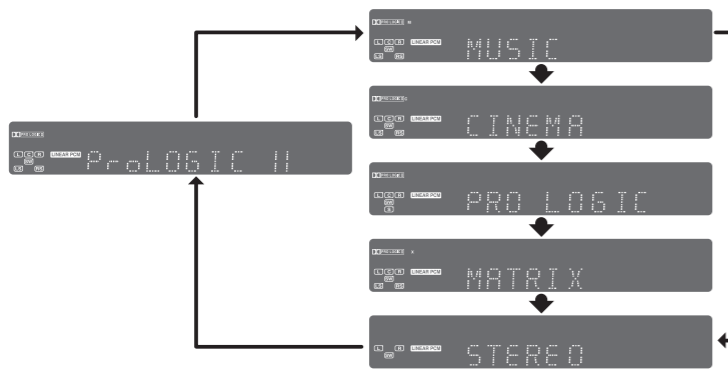

Note

- When selecting Pro Logic II mode, connect your external device to the AUDIO INPUT jacks (L and R) on the player. If you connect to only one of the inputs (L or R), you cannot listen to 5.1 channel surround sound.

PRO LOGIC II

- **MUSIC:** When listening to music, you can experience sound effects as if you are listening to the actual performance.
 - **CINEMA:** Adds realism to the movie soundtrack.
 - **PRO LOGIC:** You will experience a realistic multi-channel effect, as if using five speakers, while using just the front left and right speakers.
 - **MATRIX:** You will hear 5.1 channel surround sound.
- STEREO:** Select this to listen to sounds from the front left and right speakers and the subwoofer only.

Dolby Pro Logic II Effect

This function works only in Dolby Pro Logic MUSIC mode.

1 Press **PL II MODE** button to select 'MUSIC' mode.



2 Press **PL II EFFECT** button and then press Cursor **◀, ▶** buttons to select the mode.

- You can select either 0 or 1.



3 Press **PL II EFFECT** button and then press Cursor **◀, ▶** buttons to select the mode.

- You can select between 0 and 7.



4 Press **PL II EFFECT** button and then press Cursor **◀, ▶** buttons to select the mode.

- You can select between 0 and 6.



Note

- When playing a DVD disc encoded with two or more channels, multi-channel mode will be selected automatically and **PL II** (Dolby Pro Logic II) button does not work.

- **PANORAMA:** This mode extends the front stereo image to include the surround speakers for an exciting "wraparound" effect with side wall imaging.
- **CENTER WIDTH:** Sound is output to the center speaker only. The front left and right speakers produce phantom sound.
- **DIMENSION:** Incrementally adjusts the sound field (DSP) from the front or rear.

Listening to Radio

You can listen to the chosen band (FM, MW, LW(UK Only) broadcast stations) by using either the automatic or manual tuning operation.

Presetting Stations

You can store up to:

- ◆ 15 FM stations
- ◆ 8 MW stations
- ◆ 7 LW stations(UK Only)
- FM Frequency Modulation
- AM(MW) Medium Wave
- LW Long Wave

Remote Control Unit

1 Press TUNER/BAND button.

- The selection toggles back and forth between "FM → MW → LW(UK Only)" each time the TUNER(BAND) button is pressed.

2 Tune in to the desired station.

- Automatic Tuning 1** When is pressed, a preset broadcast station is selected.
- Automatic Tuning 2** Press and hold to automatically search for active broadcasting stations.
- Manual Tuning** Briefly press to increase or decrease the frequency incrementally.

Main Unit

1 Press the Function button to select the desired band (FM, MW, LW(UK Only)).

2 Select a broadcast station.

- Automatic Tuning 1** Press the STOP (■) button to select PRESET and then press to select the preset station.
- Automatic Tuning 2** Press the STOP (■) button to select "MANUAL" and then press and hold to automatically search the band.
- Manual Tuning** Press STOP (■) to select MANUAL and then briefly press to tune in to a lower or higher frequency.

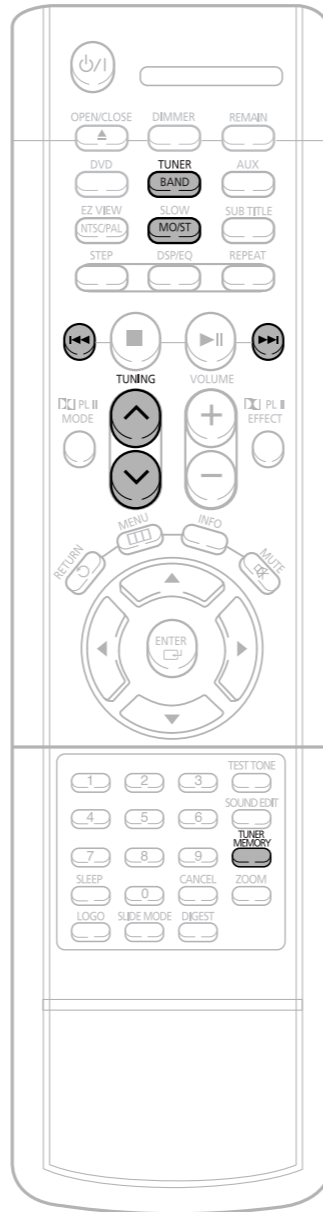

Example: Presetting FM 89.1 in the memory

1 Press the TUNER(BAND) button and select the FM band.

- Each time the button is pressed, the band switches between "FM → MW → LW(UK Only)".

FM 91.90 MHz

2 Press to select "89.10".

- Refer to Step 2 on page 51 to automatically or manually tune in to a station.

FM 89.10 MHz

3 Press the TUNER MEMORY button.

- "PRGM" flashes in the display.

PRGM FM 89.10 MHz

4 Press to select preset number.

- You can select between 1 and 15.

PRGM 2 FM 89.10 MHz

5 Press the TUNER MEMORY button.

- Press the TUNER MEMORY button before 'PRGM' disappears from the display.
- 'PRGM' disappears from the display and the station is stored in memory.

FM 89.10 MHz

6 To preset another station, repeat steps 2 to 5.

Press MO/ST button to listen in Mono/Stereo. (This applies only when listening to an FM station.)

- Each time the button is pressed, the sound switches between "STEREO" and "MONO".
- In a poor reception area, select MONO for a clear, interference-free broadcast.

To tune in to a preset station, press on the remote control to select a channel.

Convenient Functions

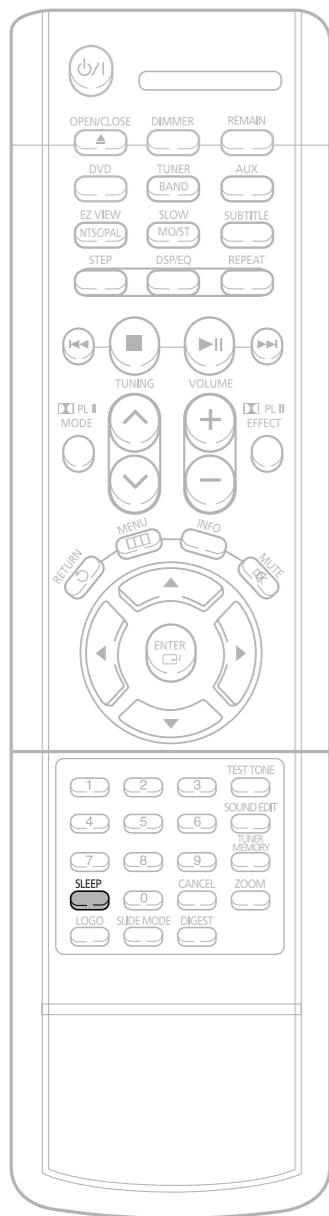

Sleep Timer Function

You can set the time that the DVD player will shut itself off.

Press **SLEEP** button.

- "SLEEP" will be displayed. Each time the button is pressed the preset time changes as follows: 10 → 20 → 30 → 60 → 90 → 120 → 150 → OFF.

SLEEP 10

To confirm the sleep timer setting, press **SLEEP** button.

- The remaining time before the DVD player will shut itself off is displayed.
- Pressing the button again changes the sleep time from what you have set earlier.

To cancel the sleep timer, press **SLEEP** button until OFF appears on the display.

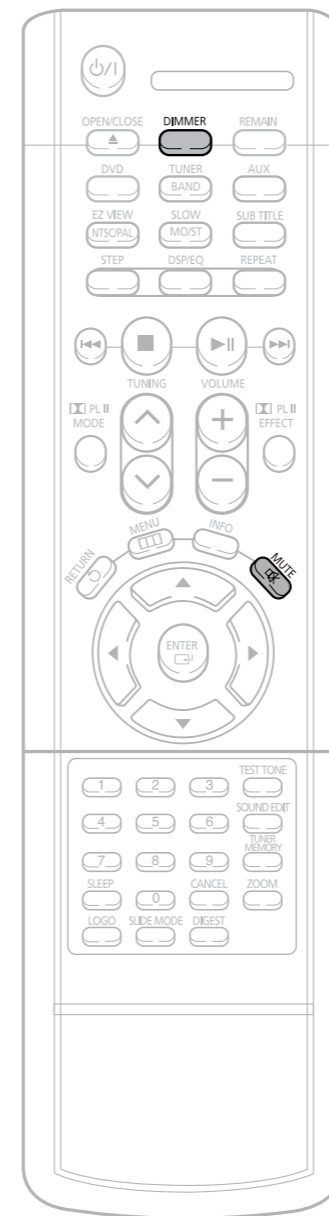

Adjusting Display Brightness

You can adjust the brightness of the display on the main unit so it won't interfere with your movie viewing.

Press **DIMMER** button.

- Each time the button is pressed, the brightness changes as follows: SLIGHTLY DARK → DARK → BRIGHT.

Mute Function

This is useful when answering a doorbell or telephone call.

Press **MUTE** button.

- 'MUTE' flash in the display.
- To switch the sound back on (at the same volume as before), press **MUTE** again or the **VOLUME** buttons.

MUTE



Before Calling for Service

Refer to the chart below when this unit does not function properly. If the problem you are experiencing is not listed below or if the instruction below does not help, turn off the unit, disconnect the power cord, and contact the nearest authorized dealer or Samsung Electronics Service Center.

Symptom	Check/Remedy
Disc tray does not open.	<ul style="list-style-type: none"> • Is the power cord plugged securely into the outlet? • Turn off the power and then turn it back on.
Playback does not start.	<ul style="list-style-type: none"> • Check the region number of the DVD. DVD discs purchased from abroad may not be playable. • CD-ROMs and DVD-ROMs cannot be played on this DVD player. • Make sure that the rating level is correct.
Playback does not start immediately when the Play/Pause button is pressed.	<ul style="list-style-type: none"> • Are you using a deformed disc or a disc with scratches on the surface? • Wipe the disc clean.
Sound is not produced.	<ul style="list-style-type: none"> • No sound is heard during fast playback, slow playback, and step motion playback. • Are the speakers connected properly? Is the speaker setup correctly customized? • Is the disc severely damaged?
Sound can be heard only from a few speakers and not all six.	<ul style="list-style-type: none"> • When listening to a CD or radio, sound is output to the front speakers (L/R) only. Select "PRO LOGIC II" by pressing PL II (Dolby Pro Logic II) on the remote control to use all six speakers. • Make sure that the DVD disc is 5.1-CH compatible. • If you set C, SL, and SR to NONE in the speaker mode in the audio setup of the setup screen, no sound is heard from the center speaker and the front left and right speakers. Set C, SL, and SR to SMALL.
Picture does not appear, sound is not produced, or the disc tray opens 2 to 5 seconds later.	<ul style="list-style-type: none"> • Was the DVD player suddenly moved from a cold place to a warm one? When condensation forms inside the player, remove the disc and let the player stand for 1 or 2 hours with the power on. (You can use the player again after condensation disappears.)
Dolby Digital 5.1 CH Surround Sound is not produced.	<ul style="list-style-type: none"> • Is there "Dolby Digital 5.1 CH" mark on the disc? Dolby Digital 5.1 CH Surround Sound is produced only if the disc is recorded with 5.1 channel sound. • Is the audio language correctly set to DOLBY DIGITAL 5.1-CH in the information display?

Symptom	Check/Remedy
<ul style="list-style-type: none"> • Disc is rotating but no picture is produced. • Picture quality is poor and picture is shaking. 	<ul style="list-style-type: none"> • Is the TV power on? • Are the video cables connected properly? • Is the disc dirty or damaged? • A poorly manufactured disc may not be playable.
The remote control does not work.	<ul style="list-style-type: none"> • Is the remote control being operated within its operation range of angle and distance? • Are the batteries exhausted?
Audio language and subtitles do not work.	<ul style="list-style-type: none"> • Audio language and subtitles will not work for DVDs not containing them. And depending on the disc, they may work differently.
Menu screen does not appear even when the menu function is selected.	<ul style="list-style-type: none"> • Are you using a disc that does not contain menus?
Aspect ratio cannot be changed.	<ul style="list-style-type: none"> • You can play 16:9 DVDs in 16:9 WIDE mode, 4:3 LETTER BOX mode, or 4:3 PAN SCAN mode, but 4:3 DVDs can be seen in 4:3 ratio only. Refer to the DVD disc jacket and then select the appropriate function.
Can't receive radio broadcast.	<ul style="list-style-type: none"> • Is the antenna connected properly? • If the antenna's input signal is weak, install an external FM antenna in an area with good reception.
<ul style="list-style-type: none"> • The main unit is not working. (Example: The power goes out or strange noise is heard.) • The DVD player is not working normally. 	<ul style="list-style-type: none"> • Turn off the power and hold the button on the main unit for longer than 5 seconds. <p>Using the RESET function will erase all stored settings. Do not use this unless necessary.</p>
The password for rating level has been forgotten.	<ul style="list-style-type: none"> • While "NO DISC" message appears on the display of main unit, hold the main unit's button for longer than 5 seconds. "INITIAL" appears on the display and all settings will return to the default values. • Press the POWER button. <p>Using the RESET function will erase all stored settings. Do not use this unless necessary.</p>

Cautions on Handling and Storing Discs

Small scratches on the disc may reduce sound and picture quality or cause breaks in playback. Be especially careful not to scratch discs when handling them.

● Handling discs

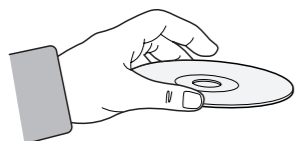

Do not touch the playback side of the disc. Hold the disc by the edges so that fingerprints will not get on the surface.

Do not stick paper or tape on the disc.

● Disc Storage

<p>Do not keep in direct sunlight</p>	<p>Keep in a cool ventilated area</p>	<p>Keep in a clean Protection jacket. Store vertically.</p>
--	--	--

Caution

- Do not allow the discs to become contaminated with dirt.
- Do not load cracked discs or discs that are scratched.

● Handling and Storing Discs



When you get fingerprints or dirt on the disc, clean it with a mild detergent diluted in water and wipe with a soft cloth.

- When cleaning, wipe gently from the inside to the outside of the disc.

Note





- Condensation may form if warm air comes into contact with cold parts inside the player. When condensation forms inside the player, the player may not operate correctly. If this occurs, remove the disc and let the player stand for 1 or 2 hours with the power on.

Specifications

GENERAL	Power Consumption	110W	
	Weight	6.3Kg	
	Dimensions (W x H x D)	360 x 65 x 408 mm	
	Operating Temperature Range	+5°C~+35°C	
	Operating Humidity Range	10%~75%	
FM TUNER	Usable Sensitivity	10dB	
	S/N Ratio	60dB	
	Distortion	0.5%	
AM (WM) TUNER	Usable Sensitivity	54dB	
	S/N Ratio	40dB	
	Distortion	2%	
VIDEO OUTPUT	Composite Video	1.0Vp-p(75Ω load)	
	Scart Jack	Composite Video	1.0Vp-p(75Ω load)
		Luminance signal	1.0Vp-p(75Ω load)
	Color Signal	0.286Vp-p(75Ω load)	
AMPLIFIER	Front speaker output	40W(6Ω)/CH	
	Center speaker output	40W(6Ω)	
	Rear speaker output	40W(6Ω)/CH	
	Subwoofer speaker output	50W(3Ω)	
	Frequency range	20Hz~20KHz	
	S/N Ratio	75dB	
	Channel separation	50dB	
	Input sensitivity	(AUX)500mV	
SPEAKER	Speaker system	5.1ch speaker system	
		Front/Center/Rear speaker	Subwoofer speaker
	Impedance	6Ω x 5	3Ω
	Frequency range	150Hz~20KHz	30Hz~150Hz
	Output sound pressure level	82dB/W/M	85dB/W/M
	Rated input	40W	50W
	Maximum input	80W	100W
	Dimensions (W x H x D)	77 x 132 x 87 mm	180 x 320 x 410 mm
Weights	0.3 Kg	6.1 Kg	

Notes on Terminology

Memo

ANGLE	Recorded onto some DVD discs are scenes which have been simultaneously shot from a number of different angles (the same scene is shot from the front, from the left, from the right, etc.). With such discs, the Angle button can be used to change the angle of view for specific scenes.
CHAPTER NUMBER	These numbers are recorded on DVD discs. A Title is subdivided into many sections, each of which is numbered, and specific parts of the video can be searched quickly using these numbers.
DVD	A high-density optical disc on which high-quality pictures and sound have been recorded by means of digital signals. Incorporating a new video compression technology (MPEG-2) and high-density recording technology, a DVD disc comprises two 0.6 mm thick discs bonded together.
PCM	An acronym for Pulse Code Modulation - another name for digital audio.
REGION NUMBER	Both the DVD player and DVD discs are encoded with a region number. If the region number on the DVD disc does not correspond to the region number of the DVD player, the player cannot play the disc.
SUBTITLES	Translated appearing at the bottom of the screen. A DVD disc can contain up to 32 subtitle languages.
TITLE NUMBER	These numbers are recorded on DVD discs. When a disc contains two or more movies, these movies are numbered as Title 1, Title 2, etc.
TRACK NUMBER	These numbers are assigned to the tracks which are recorded on video and audio CDs. They enable specific tracks to be located quickly.
	You can enjoy 5.1 (or 6) channels of high fidelity digital sound from various digital input sources such as DVD, CD etc. DTS provides a realistic, clear surround sound that has not previously been available from conventional surround sound.
	5.1 (or 6) Channel Digital Surround sound reproduced from DVDs and LDs recorded as a digital signals (with  disc marking). With better sound quality, dynamic range, and directionality than traditional Dolby surround technology, you can enjoy dynamic, realistic sound.
	A 4 channel analog sound reproduced from a program source such as a videotape or LD with the  mark. You can enjoy a more realistic, robust sound unavailable from regular stereo sources.

Free Manuals Download Website

<http://myh66.com>

<http://usermanuals.us>

<http://www.somanuals.com>

<http://www.4manuals.cc>

<http://www.manual-lib.com>

<http://www.404manual.com>

<http://www.luxmanual.com>

<http://aubethermostatmanual.com>

Golf course search by state

<http://golfingnear.com>

Email search by domain

<http://emailbydomain.com>

Auto manuals search

<http://auto.somanuals.com>

TV manuals search

<http://tv.somanuals.com>