

**SAMSUNG**

## *Instruction Manual*

# DVD-HR733

# DVD-HR738

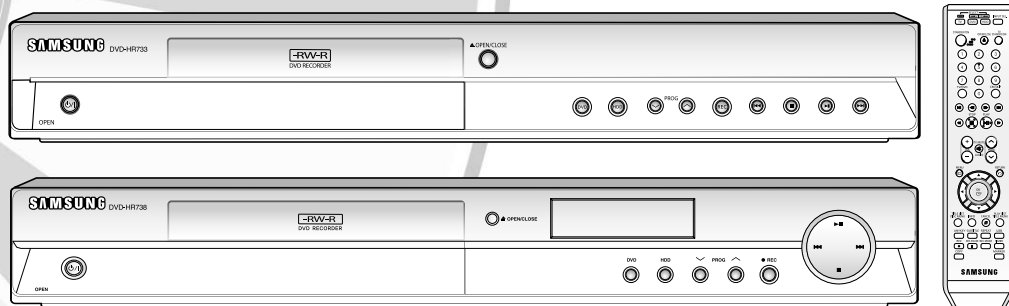

English



[www.samsung.com/uk](http://www.samsung.com/uk)

AK68-01111A

# Warning

TO REDUCE THE RISK OF ELECTRIC SHOCK, DO NOT REMOVE THE COVER(OR BACK). NO USER-SERVICEABLE PARTS ARE INSIDE. REFER SERVICING TO QUALIFIED SERVICE PERSONNEL.



This symbol indicates "dangerous voltage" inside the product that presents a risk of electric shock or personal injury.



This symbol indicates important instructions accompanying the product.

Do not install this equipment in a confined space such as a bookcase or similar unit.

**WARNING :** To prevent damage which may result in fire or electric shock hazard, do not expose this appliance to rain or moisture.

**CAUTION :** HDD & DVD RECORDER USES AN INVISIBLE LASER BEAM WHICH CAN CAUSE HAZARDOUS RADIATION EXPOSURE IF DIRECTED. BE SURE TO OPERATE HDD & DVD RECORDER CORRECTLY AS INSTRUCTED.

## CAUTION

THIS PRODUCT UTILIZES A LASER. USE OF CONTROLS OR ADJUSTMENTS OR PERFORMANCE OF PROCEDURES OTHER THAN THOSE SPECIFIED HEREIN MAY RESULT IN HAZARDOUS RADIATION EXPOSURE. DO NOT OPEN COVERS AND DO NOT REPAIR YOURSELF. REFER SERVICING TO QUALIFIED PERSONNEL.

This product satisfies CE regulations when shielded cables and connectors are used to connect the unit to other equipment. To prevent electromagnetic interference with electric appliances, such as radios and televisions, use shielded cables and connectors for connections.

## IMPORTANT NOTE

The mains lead on this equipment is supplied with a moulded plug incorporating a fuse. The value of the fuse is indicated on the pin face of the plug. If it requires replacing, a fuse approved to BS1362 of the same rating must be used.

Never use the plug with the fuse cover omitted if the cover is detachable. If a replacement fuse cover is required, it must be of the same colour as the pin face of the plug. Replacement covers are available from your dealer.

If the fitted plug is not suitable for the power points in your house or the cable is not long enough to reach a power point, you should obtain a suitable safety approved extension lead or consult your dealer for assistance.

However, if there is no alternative to cutting off the plug, remove the fuse and then safely dispose of the plug. Do not connect the plug to a mains jack, as there is a risk of shock hazard from the bared flexible cord. To disconnect the apparatus from the mains, the plug must be pulled out from the mains socket, therefore the mains plug shall be readily operable.

The product unit accompanying this user manual is licenced under certain intellectual property rights of certain third parties. This licence is limited to private non-commercial use by end-user consumers for licenced contents.

No rights are granted for commercial use.

The licence does not cover any product unit other than this product unit and the licence does not extend to any unlicensed product unit or process conforming to ISO/IEC 11172-3 or ISO/IEC 13818-3 used or sold in combination with this product unit. The licence only covers the use of this product unit to encode and/or decode audio files conforming to the ISO/IEC 11172-3 or ISO/IEC 13818-3. No rights are granted under this licence for product features or functions that do not conform to the ISO/IEC 11172-3 or ISO/IEC 13818-3.

# Precaution



## Important Safety Instructions

Read these operating instructions carefully before using the unit. Follow all the safety instructions listed below. Keep these operating instructions handy for future reference.

- 1) Read these instructions.
- 2) Keep these instructions.
- 3) Heed all warnings.
- 4) Follow all instructions.
- 5) Do not use this apparatus near water.
- 6) Clean only with dry cloth.
- 7) Do not block any ventilation openings, Install in accordance with the manufacturer's instructions.
- 8) Do not install near any heat sources such as radiators, heat registers, stoves, or other apparatus (including amplifiers) that produce heat.
- 9) Do not defeat the safety purpose of the polarized or grounding-type plug. A polarized plug has two blades with one wider than the other. A grounding-type plug has two blades and a third grounding prong. The wide blade or the third prong are provided for your safety. If the provided plug does not fit into your outlet, consult an electrician for replacement of the obsolete outlet.
- 10) Protect the power cord from being walked on or pinched particularly at plugs, convenience receptacles, the point where they exit from the apparatus.
- 11) Only use attachments/accessories specified by the manufacturer.
- 12) Use only with the cart, stand, tripod, bracket, or table specified by the manufacturer, or sold with the apparatus. When a cart is used, use caution when moving the cart/apparatus combination to avoid injury from tip-over.
- 13) Unplug this apparatus during lightning storms or when unused for long periods of time.
- 14) Refer all servicing to qualified service personnel. Servicing is required when the apparatus has been damaged in any way, such as power-supply cord or plug is damaged, liquid has been spilled or objects have fallen into the apparatus, the apparatus has been exposed to rain or moisture, does not operate normally, or has been dropped.

## Handling Cautions

- Before connecting other components to this HDD & DVD RECORDER, be sure to turn them all off.
- Do not move the HDD & DVD RECORDER while a disc is being played, or the disc may be scratched or broken, the HDD & DVD RECORDER internal parts may be damaged.
- Do not put a flower vase filled with water or any small metal objects on the HDD & DVD RECORDER.
- Be careful not to put your hand into the disc tray.
- Do not place anything other than the disc in the disc tray.
- Exterior interference such as lightning and static electricity can affect normal operation of this HDD & DVD RECORDER. If this occurs, turn the HDD & DVD RECORDER off and on again with the **STANDBY/ON** button, or disconnect and then reconnect the AC power cord to the AC power outlet. The HDD & DVD RECORDER will operate normally.
- Be sure to remove the disc and turn off the HDD & DVD RECORDER after use.
- Disconnect the AC power cord from the AC outlet when you don't intend to use the HDD & DVD RECORDER for long periods of time.
- Clean the disc by wiping in a straight line from the inside to the outside of the disc.

## Maintenance of Cabinet

For safety reasons, be sure to disconnect the AC power cord from the AC outlet.

- Do not use benzene, thinner, or other solvents for cleaning.
- Wipe the cabinet with a soft cloth.

## HDD (Hard Disk Drive)

The hard disk has a high storage density, which enables long recording durations and quick access to written data. However, it can easily be damaged by shock, vibration or dust and should be kept away from magnets. To avoid losing important data, observe the following precautions.

- Do not use the HDD & DVD RECORDER in a place subject to extreme changes in temperature.
- Do not apply a strong shock to the HDD & DVD RECORDER.
- Do not place the HDD & DVD RECORDER in a location subject to mechanical vibrations or in an unstable location.

- Do not place the HDD & DVD RECORDER on top of a heat source.
- Do not disconnect the AC power cord while the power is on.
- Do not attempt to change the hard disk. This may result in a malfunction.

Should the hard disk be damaged, you cannot recover lost data. The hard disk is only a temporary storage space.

## Disc Handling

- Use discs with regular shapes. If an irregular disc (a disc with a special shape) is used, this HDD & DVD RECORDER may be damaged.

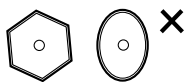

### Holding discs

- Avoid touching the surface of a disc where recording is performed.



### DVD-RAM, DVD-RW and DVD-R

- Clean with an optional DVD-RAM/PD disc cleaner (LF-K200DCA1 where available). Do not use cleaners or cloths for CDs to clean DVD-RAM/-RW/-R discs.



### DVD-Video, Audio-CD

- Wipe off dirt or contamination on the disc with a soft cloth.

### Cautions on handling discs

- Do not write on the printed side with a ball-point pen or pencil.
- Do not use record cleaning sprays or antistatic. Also, do not use volatile chemicals, such as benzene or thinner.

- Do not apply labels or stickers to discs. (Do not use discs fixed with exposed tape adhesive or leftover peeled-off stickers.)
- Do not use scratch-proof protectors or covers.
- Do not use discs printed with label printers available on the market.
- Do not load warped or cracked discs.

## Disc Storage

Be careful not to harm the disc because the data on these discs is highly vulnerable to the environment.

- Do not keep under direct sunlight.
- Keep in a cool ventilated area.
- Store vertically.
- Keep in a clean protection jacket.
- If you move your HDD & DVD RECORDER suddenly from a cold place to a warm place, condensation may generate on the operating parts and lens and cause abnormal disc playback. If this occurs, do not connect the plug to the power outlet and wait for two hours. Then insert the disc and try to play back again.

## Disc Specifications

### Disc Type

#### DVD-Video

- A digital versatile disc (DVD) can contain up to 135-minutes of images, 8 audio languages and 32 subtitle languages. It is equipped with MPEG-2 picture compression and Dolby digital surrounding, allowing you to enjoy vivid and clear theatre quality images in the comfort of your own home.
- When switching from the first layer to the second layer of a dual-layered DVD Video disc, there may be momentary distortion in the image and sound. This is not a malfunction of the unit.
- Once a DVD-RW/-R recorded in Video Mode is finalised, it becomes DVD-Video.

#### Audio CD

- An audio disc on which 44.1kHz PCM Audio is recorded.
- Plays CD-DA format audio CD-R and CD-RW discs.
- The unit may not be able to play some CD-R or CD-RW discs due to the condition of the recording.

## CD-R/-RW

- Use a 700MB(80 minutes) CD-R/-RW disc. If possible, do not use a 800MB(90 minutes) or above disc, as the disc may not play back.
- If the CD-R/-RW disc was not recorded as a closed session, you may experience a delay in the early playback time, all recorded files may not play.
- Some CD-R/-RW discs may not be playable with this unit, depending on the device which was used to burn them. For contents recorded on CD-R/-RW media from CDs for your personal use, playability may vary depending on contents and discs.

## DVD-R Disc Playback and Recording

- Once a DVD-R recorded in Video Mode is finalised, it becomes DVD-Video.
- You can record onto the available space on the disc and perform editing functions such as giving titles to discs and programmes and erasing programmes before finalising.
- When programming is erased from a DVD-R, that space does not become available. Once an area on a DVD-R is recorded on, that area is no longer available for recording, whether the recording is erased or not.
- It takes about 30 seconds for the unit to complete recording management information after recording finishes.
- This product optimizes the DVD-R for each recording. Optimizing is carried out when you start recording after inserting the disc or turning on the unit. Recording onto the disc may become impossible if optimizing is carried out too many times.
- Playback may be impossible in some cases due to the condition of recording.
- This unit can play back DVD-R discs recorded and finalised with a Samsung DVD video recorder. It may not be able to play some DVD-R discs depending on the disc and the condition of the recording.

## DVD-RW Disc Playback and Recording

- Recording and playback can be performed on DVD-RW discs in both the Video and VR Modes.
- Once a DVD-RW recorded in both the Video and VR Modes is finalised, you cannot perform additional recording.
- Once a DVD-RW recorded in Video Mode is finalised, it becomes DVD-Video.
- In both modes, playback can be performed before and after finalisation, but additional recording, deleting and editing can not be performed after finalisation.
- If you want to record the disc in VR Mode and then record in V Mode, be sure to execute Format. Be careful when executing Format because all the recorded data may be lost.
- A DVD-RW blank disc is initialized to VR Mode when first initialized.

## DVD-RAM Disc Playback

- You cannot play a DVD-RAM in most DVD components due to compatibility issues.
- Only DVD-RAM standard Version 2.0. discs can be played in this unit.
- For cartridge type DVD-RAM discs, remove the cartridge and use the disc only.

## Disc Copy

### Contents Copy Specifications

Contents	HDD → DVD	DVD → HDD
Recorded Video Title	Supported	Supported
Copy Protected Title	Not supported	Not supported
Copy Once Title	Move (Deletes the Title in the HDD after copying)	Not supported

Once "Copy Once programme" has been recorded on the DVD disc, this title cannot be copied to HDD anymore. But "Copy Once programme" has been recorded on the HDD, this title can be copied to DVD-RW(VR mode).

### Contents Copy Specifications

Contents	HDD → DVD or USB	DVD → HDD or USB	USB → HDD or DVD
MP3	Supported	Supported	Supported
JPEG(photo)	Supported	Supported	Supported
DivX	Supported	Supported	Supported

- Disc(CD-R/ CD-RW/ DVD-R(Finalise)/ DVD-RW(Finalise))→ HDD or USB
- HDD → DVD-R, DVD-RW(V) or USB
- USB → HDD or DVD-R, DVD-RW(V)
- The disc that has Video recording or has title dubbing from HDD can't be copied.
- PTP USB is not available when you copy to USB.
- If the disc is finalised through Disc Manager, it can be compatible with PC as a disc with a UDF file system.

## COPY PROTECTION

- Many DVD discs are encoded with copy protection. Because of this, you should only connect your HDD & DVD RECORDER directly to your TV, not to a VCR. Connecting to a VCR results in a distorted picture from copy-protected DVD discs.
- This product incorporates copyright protection technology that is protected by methods claims of certain U.S. patents and other intellectual property rights owned by Macrovision Corporation and other rights owners. Use of this copyright protection technology must be authorised by Macrovision Corporation, is intended for home and other limited viewing uses only unless otherwise authorised by Macrovision Corporation. Reverse engineering or disassembly is prohibited.

### Protection

This HDD & DVD RECORDER can allow you to protect the contents of your discs, as described below.

- Programme-protected: See page 91 "Locking(Protecting) a Title"
- Disc-protected: See page 115 "Disc Protection"
- \* DVD-RW/-R discs that are incompatible with the DVD-VIDEO format cannot be played with this product.
- \* For more information on DVD recording compatibility, consult your DVD-RW/-R manufacturer.
- \* Use of poor quality DVD-RW/-R discs may cause following unexpected problems including, without limitation, recording failure, loss of recorded or edited materials or damage to the HDD & DVD RECORDER.

### Disc Format

#### Using MP3 disc

- CD-R/-RW, DVD-RAM/-RW/-R, HDD with MP3 files recorded with UDF, ISO9660 or JOLIET format can be played.
- Only MP3 files with the ".mp3" or ".MP3" extension can be played.
- For MP3 files recorded with a VBR(Variable Bit Rates), from 32 Kbps to 320 Kbps, the sound may cut in out.
- Playable bit-rate range is from 56 Kbps to 320 Kbps.
- The unit can handle a maximum of 500 files and 100 sub folders under a folder.

#### Using JPEG disc

- CD-R/-RW, DVD-RAM/-RW/-R recorded with UDF, ISO9660 or JOLIET format can be played.
- Only JPEG files with the ".jpg" or ".JPG" extension can be displayed.
- The unit can handle a maximum of 500 files and 100 sub folders under a folder.
- MOTION JPEG and progressive JPEG are not supported.

#### Using MPEG4 disc

- Disc : CD-R/-RW, DVD-RAM/-RW/-R
- MPEG4(DivX) File with following extensions can be played: .avi, .divx, .AVI, .DIVX
- DivX Video (Codec) Format : DivX 3.11 DivX 4.x DivX 5.x (without QPEL and GMC)
- DivX Audio (Codec) Format : MP3, MPEG1 Audio Layer 2, Windows Media Audio, LPCM, AC3
- Supported subtitle file formats: .smi, .srt, .sub, .psb, .txt, .ass
- The unit can handle a maximum of 500 files and 100 sub folders under a folder.

#### DVD-RW (VR)

- This is a format that is used for recording data on a DVD-RW disc. You can record multiple titles, edit, delete, partial delete, create a playlist, etc.
- A disc that is recorded in this mode may not be played by existing HDD & DVD RECORDER.

#### DVD-RW (V)-R

- This is a format that is used for recording data on a DVD-RW or DVD-R disc. The disc can be played by existing HDD & DVD RECORDER once it has been finalised.
- If a disc that has been recorded in Video Mode by a different maker's recorder but has not been finalised, it cannot be played or additionally be recorded by this HDD & DVD RECORDER.

### Do not use the following discs!

- LD, CD-G, CD-I, CD-ROM and DVD-ROM discs should not be used in this product.
- [Note]  
Disc types that can be played : CD/CD-R/-RW/MP3/JPEG/DVD-Video/DVD-RAM/-RW-R.  
For a DVD-RW/-R disc, which has been recorded in Video Mode on another component, it can play only when finalised.
- Some commercial discs and DVD discs purchased outside your region may not be playable with this product. When these discs are played, either "No disc." or "Please check the regional code of the disc." will be displayed.
- If your DVD-RW disc is an illegal copy or is not in DVD video format, it may also not be playable.

## Disc compatibility

- High Speed Recording discs can be used in this unit.
- Not all brands of discs will be compatible with this unit.

## Compatible USB devices at host port

- The USB host port acts as the one of desktop or laptop computer.
  - \* This product is compatible with mass storage devices (removable storage devices) and PTP devices (such as digital still cameras)
- The USB host port provides USB2.0 connectivity and also backward compatibility with USB1.1 (USB1.0) devices.
- Supported devices at host port
  - \* Mass Storage Devices
    - ✓ Digital Still Camera (in PC or Normal mode among USB connection modes)
    - ✓ MP3 Player
    - ✓ Memory Stick
    - ✓ Card Reader (One or Multi-slot Card Reader)
    - ✓ External Hard Disk Drive
    - ✓ Others removable storage devices.
  - \* PTP (Picture Transfer Protocol) devices
    - ✓ Digital Still Camera (in PTP mode among USB connection modes)
- This product supports FAT16/32 file systems
- This product supports up to maximum 4 partitions
- Notice (Caution)
  - \* If you happen to use a bad quality USB cable, the USB device might not be recognized.
  - \* The compatibility with MP3 players is somewhat restricted.
    - ✓ This product can playback only mp3 format contents.
    - ✓ This product does not support the audio contents encrypted by DRM (Digital Right Management)
  - \* Either USB hub device or hub extension connectivity is not supported
  - \* There are awfully lots of kinds of USB devices. Some of the USB devices mentioned above might not be compatible with this product. In other words, the USB host function of this product does not guarantee the compatibility with all of USB devices.
  - \* This product supports both the high and full speed USB devices. (Does not support Low speed device)
- TPL (Target Peripheral List)
 

Since this product is not a Windows XP but a embedded USB host system, naturally the supported USB devices cannot help being limited. The USB host functionality and compatibility of this product have been proved with following items.  
(Except these items, we expect lots of other USB devices will work well with this product)

### \* DSC ( Digital Still Camera)

Vendor	Brand
Samsung	VP-MS11, V20, U-CA4, Pro 815, U-CA5, #1, Alpha 5, S800
Sony	DSC-W50, DSC-R1, DSC-P150, DSC-P10, DSC-M2, DSC T1, DSC T7
Canon	PowerShot A620, IXY Digital 700, IXUS 60, IXUS 430, A2, S80
Panasonic	DMC-LX1, DMC-FX7, DMC-FX8, DMC-FX9
Nikon	COOLPIXS1, COOLPIXS2, COOLPIXS4, COOLPIX P3 VR, COOLPIX 7900
Olympus	C-470, C-70, FE-5500, U-10, SP-700
Fuji	Finepix-F700

### \* MP3 Player

Vendor	Brand
Samsung	YP-T6, YH-820, YP-T8N, YP-T7, YP-F2
Apple	ipod video, ipod nano, ipod shuffle
iniver	H10, U10
Sony	NW-A1000

### \* Others

Product	Vendor	Brand
Card Reader	Unicon	UC-601R
PMP	Cowon	A2
External HDD	DATAgram	DHC-350

## Compatible Printers at device port

- This product is compatible with PictBridge-supporting printers.
  - \* PictBridge logo certified.
  - \* Do not connect to other USB host such as PC
- The USB device port provides USB2.0 connectivity and also backward compatibility with USB1.1 (USB1.0) printers.
- The USB device functionality and compatibility of this product have been proved with following items. (Except these items, we expect lots of other PictBridge USB printers will work well with this product)

Vendor	Brand
Samsung	SPP-2040, SPP-2020
HP	Photo Smart 7830, PSC1610
Epson	Picturemate 100, R310
Canon	CP-500, i860, i900D
Sony	DPP-FP30, DPP-EX50
Kodak	EasySharePrinterDock
Olympus	P-10

# Contents



## Getting Started

<b>Warning</b> .....	<b>2</b>
<b>Precaution</b> .....	<b>3</b>
Important Safety Instructions .....	3
Handling Cautions .....	3
Maintenance of Cabinet .....	3
HDD (Hard Disk Drive) .....	3
Disc Handling .....	4
Disc Storage .....	4
Disc Specifications .....	4
Disc Copy .....	5
<b>General Features</b> .....	<b>10</b>
<b>Before Reading the User's Manual</b> .....	<b>11</b>
<b>How to use the HDD &amp; DVD RECORDER</b> .....	<b>11</b>
<b>Unpacking</b> .....	<b>13</b>
<b>Description</b> .....	<b>15</b>
Front Panel .....	15
Rear Panel .....	16
Front Panel Display .....	16
Tour of the Remote Control .....	17

## Connecting & Setting Up

<b>Quick Overview</b> .....	<b>18</b>
<b>Connecting the HDD &amp; DVD RECORDER</b> .....	<b>19</b>
<b>Additional connections</b> .....	<b>19</b>
<b>Other type of connecting the Video output cable</b> ..	<b>20</b>
Case 1 : Connecting to a Video (Composite) output jack .....	20
Case 2 : Connecting to an S-Video output jack .....	21
Case 3 : Component Video output jacks .....	21
<b>Other type of connecting the Audio output cable</b> . . .	<b>22</b>
Case 1 : Connecting to your TV .....	22
Case 2 : Connecting to a stereo amplifier with AV output jacks .....	22
Case 3: Connecting to an AV amplifier with a digital output jack .....	23

<b>Connecting HDMI/DVI to a TV (HR738 Only)</b> .....	<b>23</b>
Case 1 : Connecting to a TV with HDMI Jack .....	23
Case 2 : Connecting to a TV with DVI Jack .....	24
<b>Connecting to AV 3 IN, DV input jack</b> .....	<b>25</b>
Case 1 : Connecting a VCR, Set-Top Box(STB), DVD player or Camcorder to the AV3 IN jacks.....	25
Case 2 : Connecting a Camcorder to the DV IN jack .....	26
<b>Connecting to USB Devices</b> .....	<b>26</b>
Case 1 : Connecting to PictBridge-supporting printer ..	26
Case 2 : Connecting a USB memory, MP3 player, Digital Camera to the USB port.....	26

## System Setup

<b>On-Screen Menu Navigation</b> .....	<b>27</b>
<b>Plug &amp; Auto Setup</b> .....	<b>28</b>
<b>Setting the Clock</b> .....	<b>29</b>
<b>Presetting Channels with the Auto Setup function</b> .....	<b>30</b>
<b>Presetting Channels with the Manual Setup function</b> .....	<b>31</b>
<b>Setting up the Language Options</b> .....	<b>32</b>
<b>Auto Power Off Setting</b> .....	<b>33</b>
<b>Setting up the Quick Recording Options</b> .....	<b>34</b>
<b>Automatic Chapter Creator</b> .....	<b>35</b>
<b>DivX(R) Registration</b> .....	<b>36</b>
<b>CM Skip Time Setting</b> .....	<b>36</b>
<b>EP Mode Time Setting</b> .....	<b>37</b>
<b>Setting up the Audio Options</b> .....	<b>38</b>
<b>Setting up the Video display Options</b> .....	<b>40</b>
<b>Setting up Video Output Options</b> .....	<b>41</b>
<b>Setting up the Progressive scan</b> .....	<b>41</b>
<b>Canceling the Progressive scan</b> .....	<b>42</b>
<b>Setting up the Parental Lock</b> .....	<b>43</b>
If you forgot your password.....	44
Setting the Rating Level.....	44
Changing the Password.....	44

## Playback

<b>Before Playing</b> .....	<b>45</b>
<b>Playing a Disc</b> .....	<b>46</b>
<b>Using the Disc Menu &amp; Title Menu</b> .....	<b>47</b>



Using the Search & Skip Functions .....	47
Slow Motion Play/Step Motion Play .....	48
About ANYKEY .....	49
Playing the Title List .....	50
Navigation menu .....	51
Using Markers .....	54
Using the Bookmarks .....	56
Selecting the Subtitle Language .....	57
Selecting the Soundtracks & Audio channels....	58
Changing the Camera Angle .....	59
Repeat Play .....	60
Zooming-In .....	61
Select Media.....	62
Playing an Audio CD/MP3 .....	62
Viewing a Picture .....	69
Playing an MPEG4 .....	73

## Recording

---

Before Recording.....	75
Recording the current TV programme you are watching.....	77
Recording from external equipment you are watching.....	79
Copying from a Camcorder.....	80
Making a One Touch Recording (OTR).....	81
Simultaneous Recording and Playback.....	82
Making a Timer Recording .....	83
Editing the Scheduled List .....	85
Deleting a Scheduled List .....	86
Go To Recorded List.....	87

## Editing

---

<b>Basic Editing (Title List) .....</b>	<b>90</b>
Renaming(Labeling) a Title.....	90
Locking (Protecting) a Title .....	91
Deleting a Title .....	92
Splitting a Section of a Title (Split).....	93
Deleting a Section of a Title (Partial Delete).....	94
<b>Advanced Editing (Playlist).....</b>	<b>96</b>
Creating a Playlist.....	96
Playing Entries in the Playlist.....	98

Renaming a Playlist Entry.....	98
Editing a Scene for the Playlist.....	99
Deleting a Playlist Entry from the Playlist .....	104
<b>Copying Title List.....</b>	<b>105</b>
About the Copy Screen.....	105
Copying from HDD to DVD.....	105
Changing the Record Mode .....	108
Copying from DVD to HDD.....	108
<b>Copying MP3, JPEG or Divx.....</b>	<b>110</b>
About the Copy Screen.....	110
File Copy .....	110
Folder Copy .....	112
<b>Disc Manager .....</b>	<b>114</b>
Editing the Disc Name .....	114
Disc Protection .....	115
Formatting a Disc .....	115
Delete All Title Lists/DivX List/Music Lists/Photo Lists ...	116
Delete All Title Lists .....	117
Finalising a Disc .....	118
Unfinalising a Disc (V/VR mode).....	119

## Reference

---

<b>Troubleshooting .....</b>	<b>120</b>
<b>Specifications .....</b>	<b>124</b>

# General Features



The HDD(Hard Disk Drive) & DVD RECORDER allows you to record and play high quality digital video on DVD-RW/-R discs or on the HDD. You can also edit digital images on DVD-RW discs or HDD.

## HDD Recording

### • DVD-HR733

You can record up to 127 hours of video (in EP mode) on the internal 80 GB (gigabyte) hard disk (HDD).

### • DVD-HR738

You can record up to 429 hours of video (in EP mode) on the internal 250 GB (gigabyte) hard disk (HDD).

With both recordable DVD and a high-capacity HDD in the same recorder, you have the flexibility to keep recordings on the HDD for quick access anytime, or record to DVD for archiving or playing on other DVD players.

## Copy between HDD and DVD

You can copy recordings from the HDD to recordable DVD, or from DVD to the HDD. Usually you can use the high speed copy feature.

You can also choose to copy material at a different recording quality from the original. For example, you might want to copy at XP mode (highest quality) recording on the HDD to SP (standard play) quality on a DVD so that you can fit other recordings on the same disc.

## Simultaneous Recording and Playback

Playback and recording for both the DVD and the built-in hard disk drive (HDD) are completely independent. For example you can record a broadcast programme to either a recordable DVD or the HDD, while watching another recording you already made on the same DVD or on the HDD.

## High quality digital audio and video recording and playback

Record up to 8-hours of video with a 4.7 GB DVD-RW/-R disc, depending on the recording mode.

## Selectable Recording Mode

You can set your HDD & DVD RECORDER to one of four different recording speeds, each varying in recording quality and length. EP (6Hr or 8Hr) mode yields the most recording time, LP & SP modes provide less recording time with higher quality recording, XP mode gives you the highest quality recording.

## Automated Quality Adjustment for Timer Recording

If FR mode is selected, the video quality is adjusted automatically so that all video for the scheduled time can be recorded onto the free disc space. (See page 84)

## 10 - English

## Creating a DVD video title using DVD-RW/-R disc

With the HDD & DVD RECORDER, you can create your own DVD Video titles on 4.7 GB DVD-RW/-R discs.

## Copying data from a digital camcorder using a DV input jack

Record DV Device video onto HDD and DVD-RW/-R discs using the DV input jack (IEEE 1394-4pin/4pin). (See page 80)

## High quality progressive scan

Progressive scanning provides high resolution and flicker free video. The 10-bit 54-MHz DAC and 2D Y/C Separating Circuitry provides the highest image playback and recording quality. (See pages 41~43)

## A variety of functions with an easy-to-use user interface

The integrated menu system allows you to perform desired operations both easily and conveniently. With a HDD, DVD-RW disc, you can edit recorded video, create a playlist, edit video in a specific sequence according to your requirements.

## MPEG4 playback

This HDD & DVD RECORDER can play MPEG4 formats within an avi file.

## DivX Certification

DivX, DivX Certified, and associated logos are trademarks of DivXNetworks, Inc and are used under licence.



## HDMI (High Definition Multimedia Interface) (HR738 only)

HDMI reduces picture noise by allowing a pure digital video/audio signal path from the HDD & DVD RECORDER to your TV.

This HDD & DVD RECORDER only supports 576p.

## USB Interface for Data Transfer

You can transfer JPEG, MP3 and DivX file of the MP3 player, USB memory or digital camera to a HDD & DVD RECORDER using the USB interface.

You can also copy JPEG, MP3 and DivX file of the HDD & DVD RECORDER to MP3 player, USB memory or digital camera using the USB interface.

## Printing with PictBridge















When you connect the HDD & DVD RECORDER to a PictBridge-supported printer using a USB cable, you can print your stored pictures without a PC. (See page 72)



# Before Reading the User's Manual

Make sure to check the following terms before reading the user manual.

## Icons that will be used in manual

Icon	Term	Definition
	HDD	This involves a function available on the HDD.
	DVD	This involves a function available on DVD or DVD-R/DVD-RW discs that have been recorded and finalised in Video Mode.
	RAM	This involves a function available on DVD-RAM.
	RW	This involves a function available on DVD-RW.
	R	This involves a function available on DVD-R.
	CD	This involves a function available on a data CD (CD-R or CD-RW).
	JPEG	This involves a function available on CD-R/-RW or DVD-R/-RW/-RAM discs.
	MP3	This involves a function available on CD-R/-RW or DVD-R/-RW/-RAM discs.
	MPEG4	This involves a function available on CD-R/-RW or DVD-R/-RW/-RAM discs.
	Caution	This involves a case where a function does not operate or settings may be cancelled.
	NOTE	This involves tips or instructions on the page that help each function operate.
	One-Touch button	A function that can be operated by using only one button.
	ANYKEY button	A function that can be operated by using <b>ANYKEY</b> button.
	USB	This involves a function available on USB.

## About the use of this user's manual

- 1) Be sure to be familiar with Safety Instructions before using this product. (See pages 2~7)
- 2) If a problem occurs, check the Troubleshooting. (See pages 120~123)

## Copyright

©2006 Samsung Electronics Co.  
All rights reserved; No part or whole of this user's manual may be reproduced or copied without the prior written permission of Samsung Electronics Co.

# How to use the HDD & DVD RECORDER

## Step 1 Select the disc type or HDD

This unit can record on the following types of discs. If you want to repeatedly record on the same disc or you want to edit the disc after recording, select a rewritable DVD-RW type disc. If you want to save a recording without any changes, choose a non-rewritable DVD-R. You can record files directly to the built-in HDD or edit a recorded file.



## Step 2 Format the disc to start recording

Unlike a VCR, the HDD & DVD RECORDER automatically starts formatting when an unused disc is inserted. This is required for the preparation of recording on a disc.

### Using the HDD

Formatting unnecessary.

### Using a DVD-RW

This type of disc can be formatted in either DVD-Video format (V mode) or DVD-Video Recording format (VR mode). For an unused disc, a message that asks whether to initialize a disc or not. If you select "Yes", disc will be formatted in VR mode. You can play a Video mode disc on various DVD components. A VR mode disc allows more varied editing.

### Using a DVD-R

Formatting disc is unnecessary and only V Mode Recording is supported. You can play these type of discs on various DVD components only when they have been finalised.



## NOTE

- You can only use either the VR or Video mode on a DVD-RW, but not both at the same time.
- You can change the DVD-RW to format to another format by reinitializing. It should be noted that the disc's data will be lost when changing formats.

### Step 3 Recording

There are two different recording methods, Direct Recording and Timer Recording. Timer recording is classified as follows:

Recording mode : XP (high quality mode), SP (standard quality mode), LP (long recording mode), and EP (extended mode) according to the recording mode. When recording is set in the FR mode, the best quality picture is recorded with regards to the remaining time on the disc.

### Step 4 Playing

You can select the title you want to play in a displayed menu and then immediately start playback.

A DVD consists of sections, called titles, and sub-sections, called chapters.

During recording, a title is created between two points where you start and stop recording. Chapters will be created automatically when you finalise recording on DVD-RW/-R discs in Video mode.

The chapter's length (interval between chapters) varies according to the recording mode.

### Step 5 Editing a recorded disc

Editing on discs is easier than conventional video tapes. The HDD & DVD RECORDER supports many different edit functions, possible only with DVDs and HDD.

With a simple and easy edit menu, you can operate various edit functions, such as delete, copy, rename, lock, etc., on a recorded title.

#### **Creating a playlist (DVD-RW in VR mode, HDD)**

With this HDD & DVD RECORDER, you can create a new playlist on a disc and edit it without the original, pre-existing recording.

### Step 6 Finalising & Playing on other DVD components

To play your DVD on other DVD components, finalising may be necessary. First, finish all editing and recording operations, then finalise the disc.

#### **When using a DVD-RW disc in VR Mode**

DVD discs recorded in VR mode can only be played back in DVD recorders, not players.

#### **When using a DVD-RW disc in Video Mode**

The disc should be finalised first to enable playback on anything other than this HDD & DVD RECORDER. No more editing or recording can be made on the disc once it has been finalised.

To enable recording on the disc again, the disc must be unfinalised.

#### **When using a DVD-R disc**

You should finalise the disc to play it on a component other than this HDD & DVD RECORDER. You cannot edit or record on the disc once it has been finalised.

# Unpacking

## Accessories

Check for the supplied accessories below.

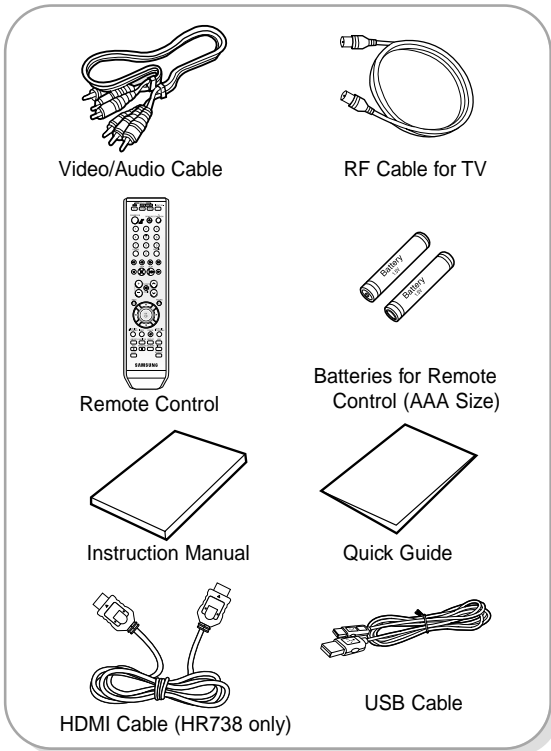

## Preparing the Remote Control

### Install Batteries in the Remote Control

- Open the battery cover on the back of the remote control.
- Insert two AAA batteries. Make sure that the polarities (+ and -) are aligned correctly.
- Replace the battery cover.

### If the remote does not operate properly:

- Check the polarity + - of the batteries (Dry-Cell)
- Check if the batteries are drained.
- Check if remote sensor is blocked by obstacles.
- Check if there is any fluorescent lighting nearby.

Dispose of batteries according to local environmental regulations. Do not put them in the household trash.

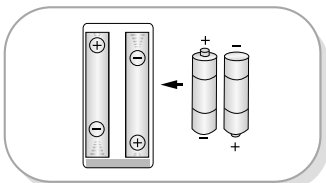

## Setting the Remote Control

You can control certain functions of another manufacturer's TV with this remote control.

Control function buttons involve: **TV STANDBY/ON**, **PROG** ^ v , **VOL** + - , **Number** buttons, **TV MUTE**, **INPUT SEL.** button.

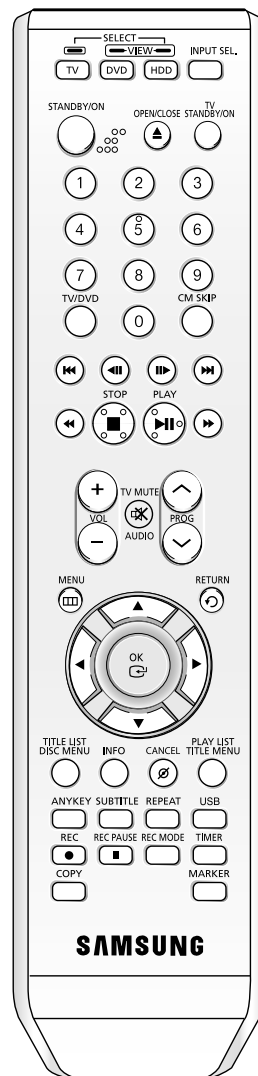

**To determine whether your television is compatible, follow the instructions below.**

1. Switch your television on.
2. Point the remote control towards the television.
3. Press and hold the **TV STANDBY/ON** button and enter the two-figure code corresponding to the brand of your television, by pressing the appropriate number buttons.

**Controllable TV Codes**

BRAND	BUTTON
SAMSUNG	01, 02, 03, 04, 05, 06, 07, 08, 09
AIWA	82
ANAM	10, 11, 12, 13, 14, 15, 16, 17, 18
BANG & OLUFSEN	57
BLAUPUNKT	71
BRANDT	73
BRIONVEGA	57
CGE	52
CONTINENTAL EDISON	75
DAEWOO	19, 20, 23, 24, 25, 26, 27, 28, 29, 30, 31, 32, 33, 34
EMERSON	64
FERGUSON	73
FINLUX	06, 49, 57
FORMENTI	57
FUJITSU	84
GRADIENTE	70
GRUNDIG	49, 52, 71
HITACHI	60, 72, 73, 75
IMPERIAL	52
JVC	61, 79
LG	06, 19, 20, 21, 22, 78
LOEWE	06, 69
LOEWE OPTA	06, 57
MAGNAVOX	40
METZ	57
MITSUBISHI	06, 48, 62, 65
MIVAR	52, 77
NEC	83
NEWSAN	68
NOBLEX	66
NOKIA	74
NORDMENDE	72, 73, 75
PANASONIC	53, 54, 74, 75
PHILIPS	06, 55, 56, 57
PHONOLA	06, 56, 57
PIONEER	58, 59, 73, 74
RADIOLA	06, 56
RADIOMARELLI	57
RCA	45, 46
REX	74
SABA	57, 72, 73, 74, 75
SALORA	74
SANYO	41, 42, 43, 44, 48
SCHNEIDER	06

BRAND	BUTTON
SELECO	74
SHARP	36, 37, 38, 39, 48
SIEMENS	71
SINGER	57
SINUDYNE	57
SONY	35, 48
TELEAVA	73
TELEFUNKEN	67, 73, 75, 76
THOMSON	72, 73, 75
THOMSON ASIA	80, 81
TOSHIBA	47, 48, 49, 50, 51, 52
WEGA	57
YOKO	06
ZENITH	63

**Result:** If your television is compatible with the remote control, it will switch off. It is now programmed to operate with the remote control.



**NOTE**

- If several codes are indicated for your television brand, try each one in turn until you find one that works.
- If you replace the remote control's batteries, you must set the brand code again.

**Then you can control the television using the following buttons after pressing the TV button.**

Button	Function
TV STANDBY/ON	Used to switch the television on and off.
INPUT SEL.	Used to select an external source.
VOL (+ -)	Used to adjust the volume of the television.
PROG ( ^ v )	Used to select the desired channel.
TV MUTE	Used to toggle the sound on and off.
Number	Used to input number directly.



**NOTE**

- The functions listed above will not necessarily work on all televisions. If you encounter problems, operate the television directly.

# Description

## Front Panel

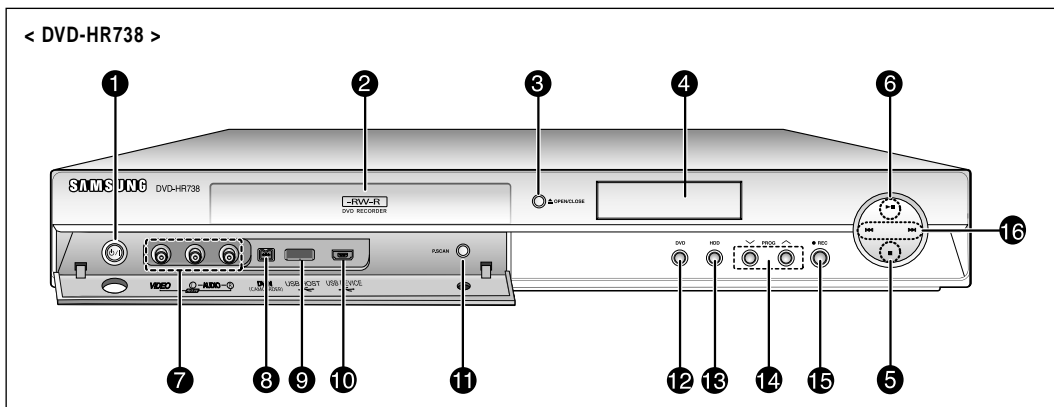
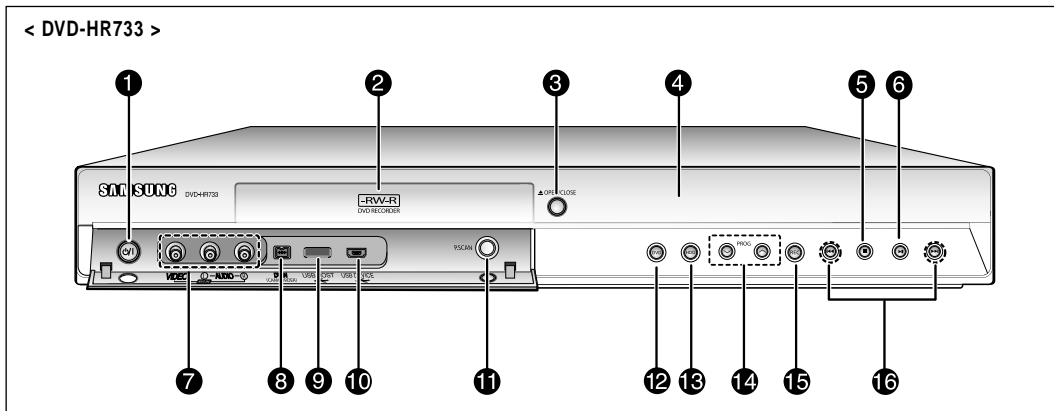

1. **STANDBY/ON BUTTON**  
Turns the HDD & DVD RECORDER on and off.
2. **DISC TRAY**  
Opens to accept a disc.
3. **OPEN/CLOSE BUTTON**  
Opens and closes the disc tray.
4. **DISPLAY**  
Displays the playing status, time, etc.
5. **STOP BUTTON**  
Stops disc playback.
6. **PLAY/PAUSE BUTTON**  
Plays a disc or pauses playback.
7. **AV 3 INPUT**  
Connect external equipment.
8. **DV-INPUT**  
Connect external digital equipment with a DV jack. (such as a camcorder)
9. **USB HOST**  
Connect digital still camera, MP3 player, memory stick, Card reader, external HDD or other removable storage devices.
10. **USB DEVICE**  
Connect the PictBridge-supporting printer using a USB cable.
11. **P.SCAN BUTTON**  
Selects the progressive scan mode.
12. **DVD BUTTON**  
Select DVD mode.
13. **HDD BUTTON**  
Select HDD mode.
14. **PROG ∨ ^ BUTTONS**  
Select TV preset Channels. Same as **PROG** button on the remote control.
15. **REC BUTTON**  
Starts recording.
16. **SEARCH/SKIP BUTTONS**  
Goes to the next title/chapter/track or goes back to the previous title/chapter/track.

## Rear Panel

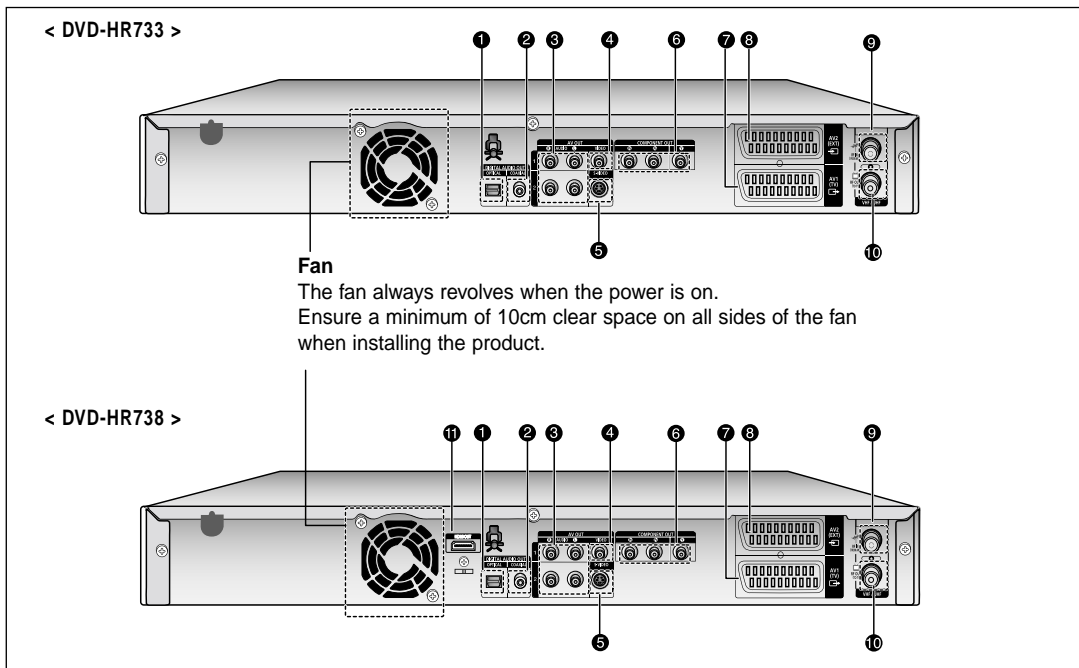

### 1. DIGITAL AUDIO OUT(OPTICAL)

Connects to an amplifier having a digital optical audio input jack.

### 2. DIGITAL AUDIO OUT(COAXIAL)

Connects to an amplifier having a digital coaxial audio input jack.

### 3. AUDIO OUT

Connects to the audio input of external equipment using audio cables.

### 4. VIDEO OUT

Connects the input of external equipment using a Video cable.

### 5. S-VIDEO OUT

Connects the input of external equipment using an S-Video cable.

### 6. COMPONENT VIDEO OUT

Connects to equipment having Component video input.

### 7. AV1(TV) OUTPUT SCART Connector

### 8. AV2(EXT) INPUT SCART Connector

### 9. In from aerial connector

### 10. Out to TV connector

### 11. HDMI OUT (HR738 Only)



NOTE

- The Antenna connection does not pass the output signal of the DVD. To watch DVD/HDD playback your TV, you must connect audio/video or Scart cables.

## Front Panel Display

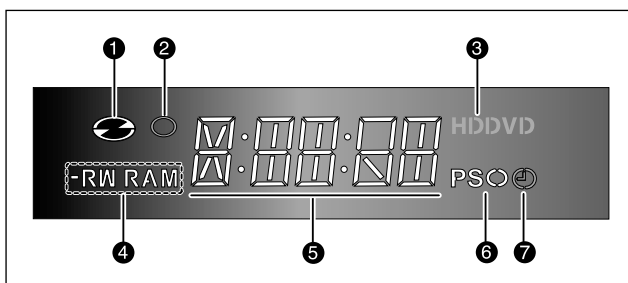

- Lights when a disc is loaded.
- Lights in the record mode.
- Lights when a HDD/DVD is selected.
- Lights when a -R/RW/RAM disc is loaded.
- Playing time/clock/current status indicator.
- Lights in the progressive scan mode.
- Lights to indicate the timer record mode.



## Tour of the Remote Control

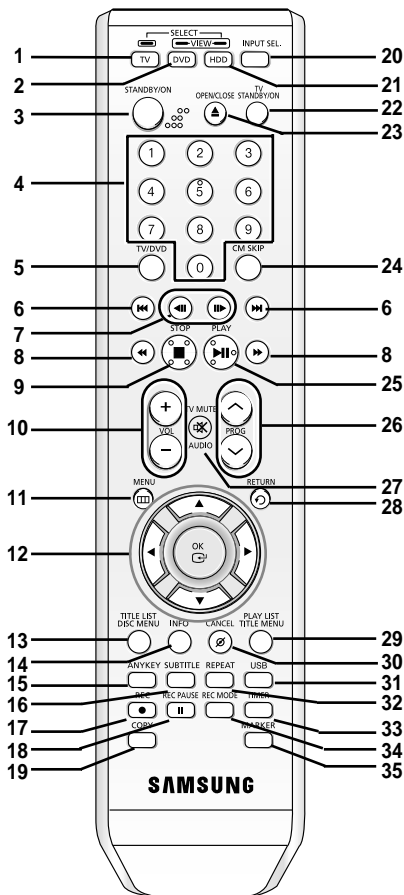

1. **TV Button**  
Press this to operate TV.
2. **DVD Button**  
Press this to operate DVD.
3. **STANDBY/ON Button**
4. **NUMBER Buttons**
5. **TV/DVD Button**
6. **REVERSE/FORWARD SKIP Buttons**  
Press to skip backwards or forwards.
7. **REVERSE/FORWARD STEP Buttons**  
Each time this button is pressed, a new frame will appear.
8. **REVERSE/FORWARD SEARCH Buttons**  
Press to search a disc backwards or forwards.
9. **STOP Button**  
Press to stop a disc.
10. **VOL Button**  
TV volume adjustment
11. **MENU Button**  
Brings up the HDD & DVD RECORDER's setup menu.
12. **OK/DIRECTION Buttons (▲▼◀▶ Buttons)**
13. **TITLE LIST/DISC MENU Button**  
Use this to enter the View Recording list/disc menu.
14. **INFO Button**  
This will display current setting or disc status.
15. **ANYKEY Button**  
Allows access to common functions of the recorder.
16. **SUBTITLE Button**  
Press this to switch the DVD's subtitle language.
17. **REC Button**  
Use to make a recording on HDD/DVD-RW/-R discs.
18. **REC PAUSE Button**  
Use this to pause during recording.
19. **COPY Button**  
Press this when you copy DVD to HDD and vice-versa.  
You can also copy files from HDD or DVD to the USB storage devices and vice-versa.
20. **INPUT SEL Button**  
Select input signal in external input mode (PROG, AV1, AV2, AV3 or DV input)
21. **HDD Button**  
Press this to operate HDD.
22. **TV STANDBY/ON Button**
23. **OPEN/CLOSE Button**  
To open and close the disc tray.
24. **CM SKIP Button**  
When a programme recorded on DVD disc or HDD is played, the unit can be set to automatically skip a portion of the programme.
25. **PLAY/PAUSE Button**  
Press to play/pause a disc.
26. **PROG Button**  
Use this to select a TV programme.
27. **TV MUTE/AUDIO Button**  
In TV mode, this operates as sound mute.  
Use this to access various audio functions on a disc (DVD mode).
28. **RETURN Button**
29. **PLAY LIST/TITLE MENU Button**  
Use this to return to the Title menu, or to view the recorded files list.
30. **CANCEL Button**
31. **USB Button**  
Press this to operate USB.
32. **REPEAT Button**  
Allows you to repeat a title, chapter, track or disc.
33. **TIMER Button**  
Press to directly enter the Timer Recording Mode menu.
34. **REC MODE Button**  
Use this to set the desired Recording time and picture quality. (XP/SP/LP/EP).
35. **MARKER Button**  
Use this to bookmark a position while playing a disc.

# Connecting & Setting Up

This section involves various methods of connecting the HDD & DVD RECORDER to other external components and required initial setting modes.

Quick Overview .....	18
Connecting the HDD & DVD RECORDER .....	19
Additional connections .....	19
Other type of connecting the Video output cable ...	20
Other type of connecting the Audio output cable ...	22
Connecting to HDMI/DVI to a TV (HR738 Only) ...	23
Connecting to AV 3 IN, DV input jack .....	25
Connecting to USB Devices .....	26

## Quick Overview

A Quick Overview presented in this guide will give you enough information to start using the HDD & DVD RECORDER.

### Connecting the HDD & DVD RECORDER



#### Additional connections



#### Other type of connecting the Video output cable



#### Other type of connecting the Audio output cable



#### Connecting to HDMI/DVI to a TV (HR738 Only)



#### Connecting to AV 3 IN, DV input jack



#### Connecting to USB Devices

# Connecting the HDD & DVD RECORDER

You can connect your HDD & DVD RECORDER to the television using the SCART cable if the appropriate input is available on the television.

1. Connect the RF cable as shown.
2. Connect one end of the SCART cable to the AV1 socket on the rear of the HDD & DVD RECORDER.
3. Plug the other end into the appropriate connector on the television.
4. Plug in the HDD & DVD RECORDER and TV.
5. Turn on the HDD & DVD RECORDER and TV.
6. Press the **INPUT SEL.** button on your TV remote control until the Video signal from the HDD & DVD RECORDER appears on the TV screen.

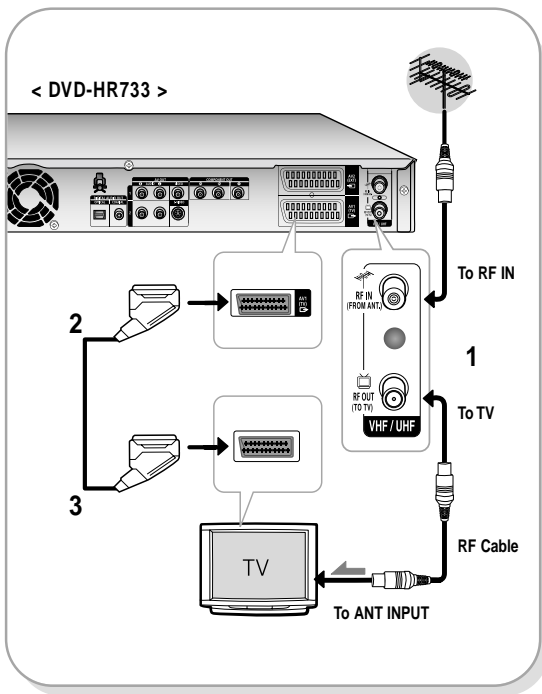

NOTE

- The RF cable connection of this product sends only signals of TV. You must connect SCART cable or Audio/Video cables to watch a DVD from your HDD & DVD RECORDER.
- TV mode : Press the **TV/DVD** button on remote control, then "TV" appear on Front LED display (or turn off HDD & DVD RECORDER). Then you can watch programmes received through TV.

# Additional connections

You can connect your HDD & DVD RECORDER to a satellite or digital tuner.

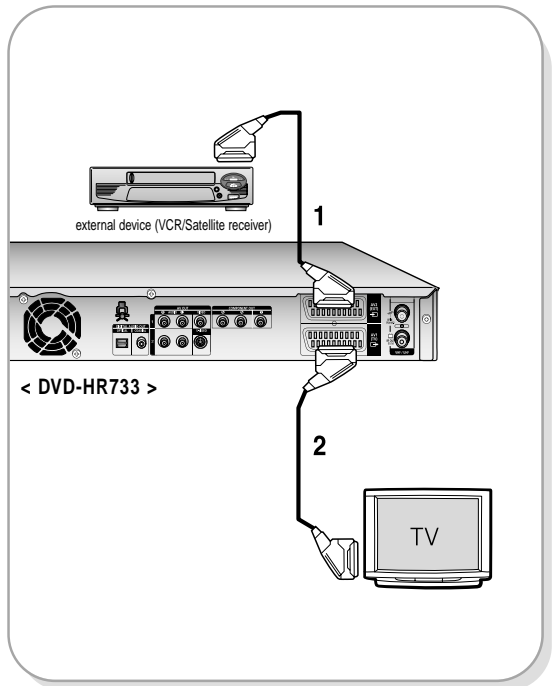

- DVD mode

1. Connect the AV2 connector of HDD & DVD RECORDER and VCR/Satellite receiver or digital tuner using a SCART cable.
2. Connect the AV1 connector to the SCART AV connector on TV.
3. Turn on the HDD & DVD RECORDER, VCR/Satellite receiver or digital tuner and TV.
4. Set Input mode on AV2.

- TV mode

1. Press the **TV/DVD** button on remote control, then "TV" appear on Front LED display. (or turn off HDD & DVD RECORDER.)
2. You can watch programmes from a satellite or digital tuner connected to this HDD & DVD RECORDER, even when the HDD & DVD RECORDER is turned off.

## Other type of connecting the Video output cable

There are several ways to output video signal not using scart cables. Select one of the following video connecting that best suits you below.

- **Case 1** : Connecting to a Video (Composite) output jack
- **Case 2** : Connecting to an S-Video output jack
- **Case 3** : Component Video output jacks

### S-Video, Component video and Progressive Output Modes

- S-Video and Component video output are available only if your TV supports S-Video input or Component video input, respectively. If S-Video or Component video output does not work, check the TV connections and the TV input selection settings.
- Compared to standard interlaced video, progressive scan doubles the amount of video lines fed to your TV, resulting in a more stable, flicker-free, clear image than interlaced video. This is only available with TVs that support progressive scan.
- Progressive Scan Output (576p)  
Consumers should note that not all high definition television sets are fully compatible with this product and may cause artifacts to be displayed in the picture, in case of 576 progressive scan picture problems, It is recommended that the user switch the connection to the 'standard definition' output. If there are questions regarding our TV set compatibility with this model 576p HDD & DVD RECORDER, please contact our customer service centre.

### Case 1 : Connecting to a Video (Composite) output jack

1. Connect a video(yellow) cable between the VIDEO (yellow) OUT jack on HDD & DVD RECORDER and VIDEO (yellow) INPUT jack on your TV (or AV amplifier).
  - You will enjoy regular quality images.
2. Connect audio cables (white and red) between the AUDIO OUT jacks on the HDD & DVD RECORDER and AUDIO IN jacks on TV (or AV amplifier). (See pages 22~23)

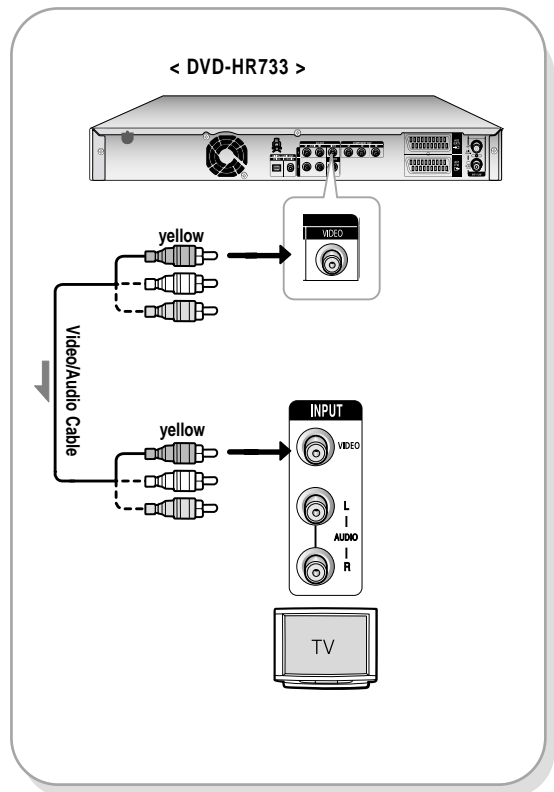

## Case 2 : Connecting to an S-Video output jack

1. Connect an S-Video cable (not included) between the S-VIDEO OUT jack on HDD & DVD RECORDER and S-VIDEO INPUT jack on your TV (or AV amplifier).
  - You will enjoy high quality images.
2. Connect audio cables (white and red) between the AUDIO OUT jacks on HDD & DVD RECORDER and AUDIO IN jacks on TV (or AV amplifier). (See pages 22~23)

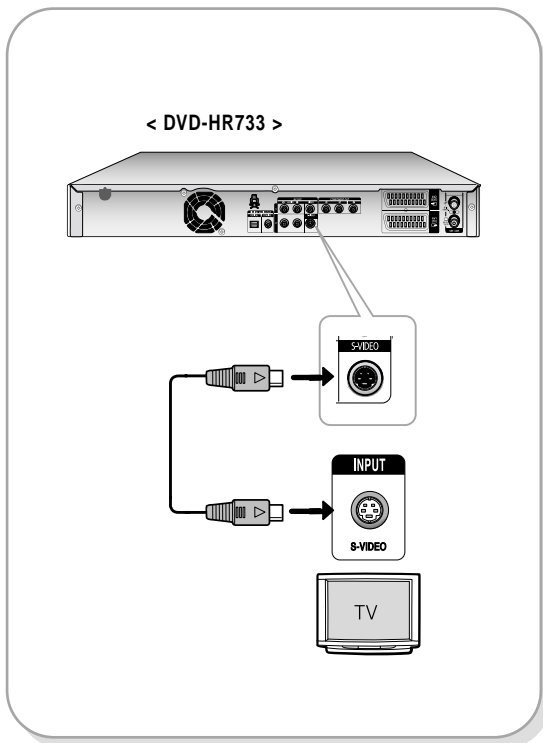

## Case 3 : Component Video output jacks

1. Connect Component video cables(not supplied) between the COMPONENT OUT(Y,P<sub>B</sub>,P<sub>R</sub>) jacks on HDD & DVD RECORDER and COMPONENT IN(Y,P<sub>B</sub>,P<sub>R</sub>) jacks on your TV.
  - You will enjoy high quality and accurate colour reproduction images.
2. Connect audio cables (white and red) between the AUDIO OUT jacks on the HDD & DVD RECORDER and AUDIO IN jacks on TV (or AV amplifier). (See pages 22~23).
3. After connecting, refer to the pages 41~43.

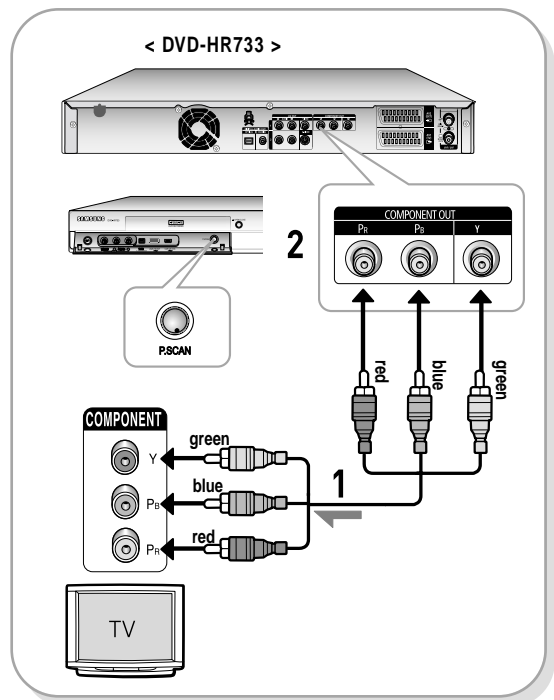

NOTE

- Make sure that the colour coded connections match. The Y, P<sub>B</sub>, P<sub>R</sub> component output jacks of your HDD & DVD RECORDER must be connected to the exact corresponding component input jacks on your TV.
- Progressive setting is only available when the Video Out is set to Component. (See pages 41~43)

# Other type of connecting the Audio output cable

There are several ways to output audio signal not using scart cables. Select the audio connection that best suits you below.

- **Case 1 :** Connecting to your TV
- **Case 2 :** Connecting to a stereo amplifier with AV output jacks
- **Case 3 :** Connecting to an AV amplifier with a digital output jack

Manufactured under licence from Dolby Laboratories. "Dolby" and the double-D symbol are trademarks of Dolby Laboratories.

"DTS" and "DTS Digital Out" are trademarks of Digital Theatre System, Inc.

## Case 1 : Connecting to your TV

If your TV has audio input jacks, use this connection.

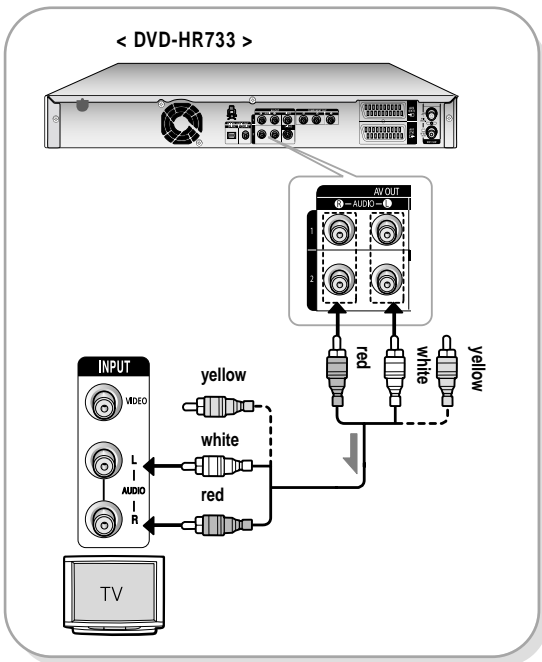

## Case 2 : Connecting to a stereo amplifier with AV output jacks

If your stereo amplifier only has AUDIO INPUT jacks(L and R), use the AUDIO OUT jacks.

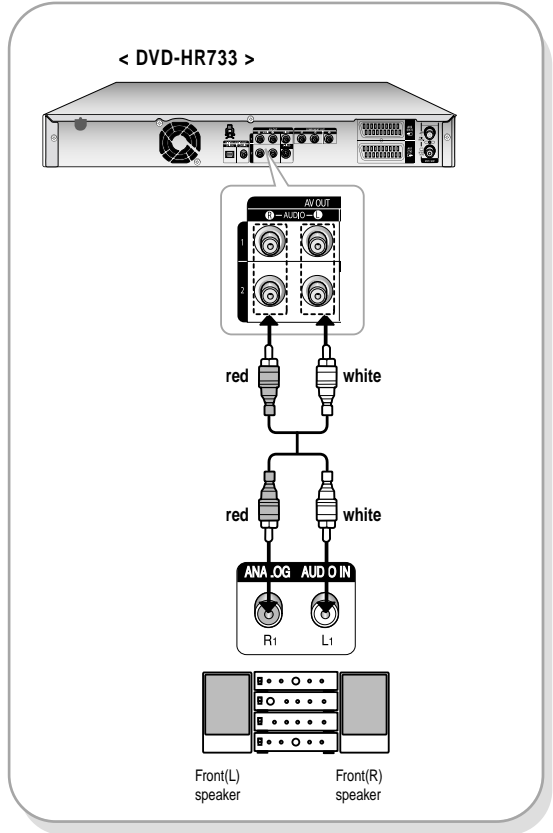

### Case 3: Connecting to an AV amplifier with a digital output jack

If your AV amplifier has a Dolby Digital, MPEG2 or DTS decoder and a digital input jack, use this connection. To enjoy Dolby Digital, MPEG2 or DTS sound, you will need to set up the audio settings.

According to your amplifier, connect to an optical cable or a coaxial cable. (See pages 38~39)

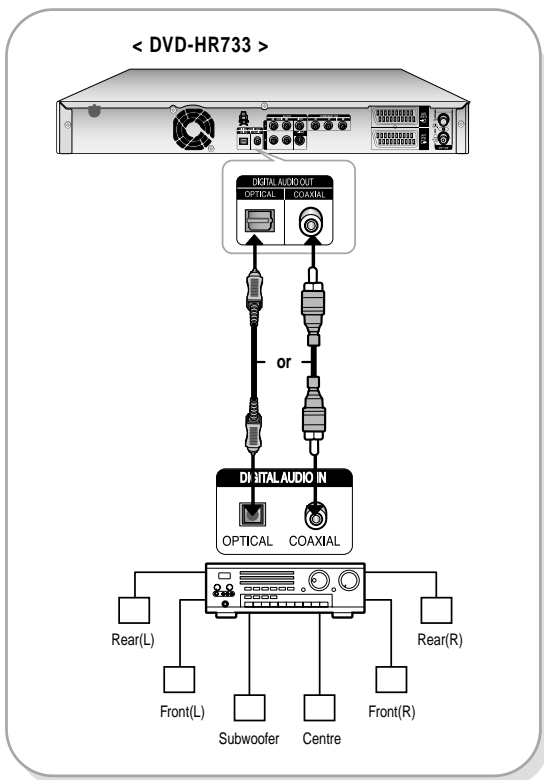

## Connecting HDMI/DVI to a TV (HR738 Only)

If your TV has a HDMI/DVI input, connect HDMI/DVI Adapter cable to a TV. You will enjoy the best quality images and sounds.

- **Case 1** : Connecting to a TV with HDMI Jack
- **Case 2** : Connecting to a TV with DVI Jack

### Case 1 : Connecting to a TV with HDMI Jack

- Using the HDMI cable connect the HDMI OUT jack on the rear of the HDD & DVD RECORDER to the HDMI IN jack of your TV.
- Press the input selector on your TV remote control until the HDMI signal from the HDD & DVD RECORDER appears on your TV screen.

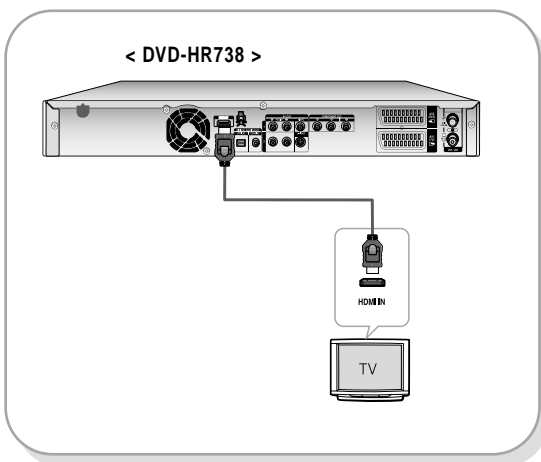

## Case 2 : Connecting to a TV with DVI Jack

- Using the DVI Adapter Cable(not supplied), connect the HDMI OUT jack on the rear of the HDD & DVD RECORDER to the DVI IN jack of your TV.
- Using the audio cables, connect the AUDIO (red and white) OUT jacks on the rear of the HDD & DVD RECORDER to the AUDIO (red and white) IN jacks of your TV. Turn on the HDD & DVD RECORDER and TV.
- Press the input selector on your TV remote control until the DVI signal from the HDD & DVD RECORDER appears on your TV screen.



CAUTION

- To use HDMI cable, make the Audio/Video connection before plugging in the power cord or after finishing the "Plug & Auto Setup." Do not connect the HDMI cable while the "Plug & Auto Setup" is progressing.
- Progressive scan automatically activates when HDMI is connected.
- If your TV does not have Bitstream decoder, you must set the digital audio output to PCM in order to watch through the HDMI output. (See pages 38~39)
- Depending on the HDMI device (TV/HDMI Receiver) you use, audio may not be supported. If TV/HDMI Receiver does not support Dolby digital, Audio output is not available when you set Digital output as 'Bitstream' in Audio setup menu. In this case, set the digital audio output to PCM. If TV/HDMI Receiver does not support DTS, Audio output is not available when you play disc in DTS format.
- You can switch from the HDMI output to other output only in stop mode.

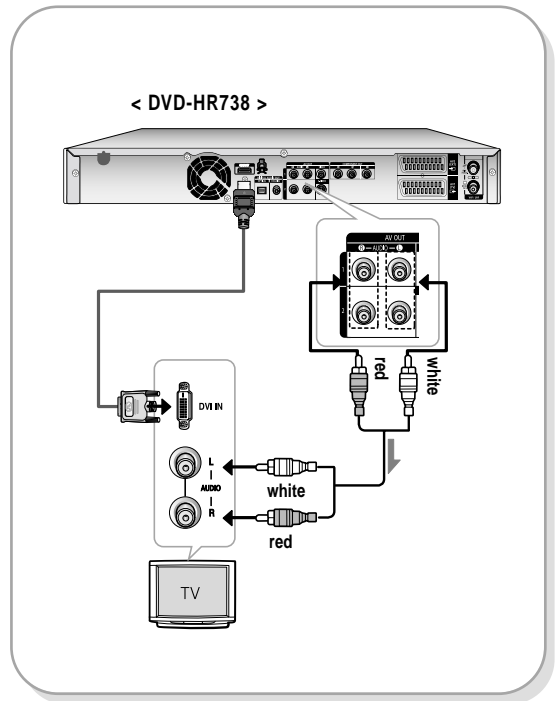

NOTE

- **HDMI (High Definition Multimedia Interface)**  
HDMI is an interface to enable the digital transmission of video and audio data with just a single connector. Since HDMI is based on DVI, it is completely compatible with DVI. The only difference between HDMI and DVI is that HDMI supports multi-channel audio. Using HDMI, the HDD & DVD RECORDER transmits a digital video and audio signal and displays a vivid picture on a TV having an HDMI input jack.
- **HDMI connection description**  
HDMI connector - Both uncompressed video data and digital audio data (LPCM or Bit Stream data).
  - Though the HDD & DVD RECORDER uses a HDMI cable, the HDD & DVD RECORDER outputs only a pure digital signal to the TV.
  - If TV does not support HDCP (High -bandwidth Digital Content Protection), snow noise appears on the screen.



■ Why does Samsung use HDMI?

Analog TVs require an analog video/audio signal. However, when playing a DVD, the data transmitted to a TV is digital. Therefore either a digital-to-analog converter (in the HDD & DVD RECORDER) or an analog-to-digital converter (in the TV) is required. During this conversion, the picture quality is degraded due to noise and signal loss. HDMI technology is superior because it requires no D/A conversion and is a pure digital signal from the HDD & DVD RECORDER to your TV.

■ What is the HDCP?

HDCP (High-bandwidth Digital Content Protection) is a system for protecting DVD content outputted via HDMI from being copied. It provides a secure digital link between a video source (PC, DVD, etc) and a display device (TV, projector, etc). Content is encrypted at the source device to prevent unauthorized copies from being made.

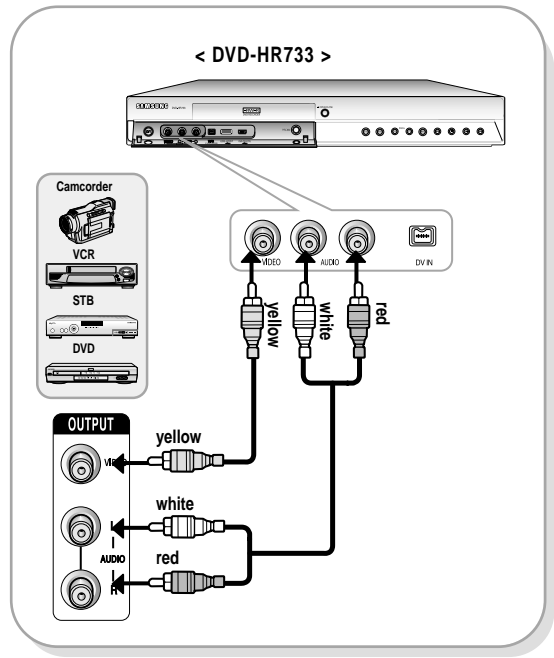

- AV 3 in selection will be automatically done. If the input is not selected automatically, use **INPUT SEL.** button to select proper input.
- Copy protected content cannot be recorded.

## Connecting to AV 3 IN, DV input jack

This allows you to connect your HDD & DVD RECORDER to other external devices and view or record their outputs.

- **Case 1** : Connecting a VCR, Set-Top Box(STB), DVD player or Camcorder to the AV3 IN jacks
- **Case2** : Connecting a DV Device to the DV IN jack

### ■ Case 1 : Connecting a VCR, Set-Top Box(STB), DVD player or Camcorder to the AV3 IN jacks

Connecting a VCR or external device to AV3 IN jacks of the HDD & DVD RECORDER. You can record from connected equipment (VCR, STB, DVD player or Camcorder).

### ■ Case 2 : Connecting a Camcorder to the DV IN jack

If your digital camcorder has a DV output jack, connect it to the DV input jack of your HDD & DVD RECORDER.

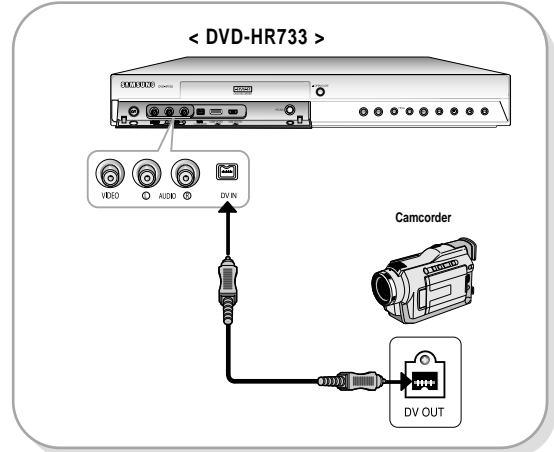

- If the input is not selected automatically, use **INPUT SEL.** button to select proper input.

# Connecting to USB Devices

This allows you to connect your HDD & DVD RECORDER to USB devices and print or copy files.

- **Case 1** : Connecting to PictBridge-supporting printer
- **Case 2** : Connecting a USB memory, MP3 player, Digital Camera to the USB port.

## Case 1 : Connecting to PictBridge-supporting printer

Connect the USB cable between the USB DEVICE on HDD & DVD RECORDER and USB port on printer. You can print your photo images directly without connecting to a PC. (See page 72)

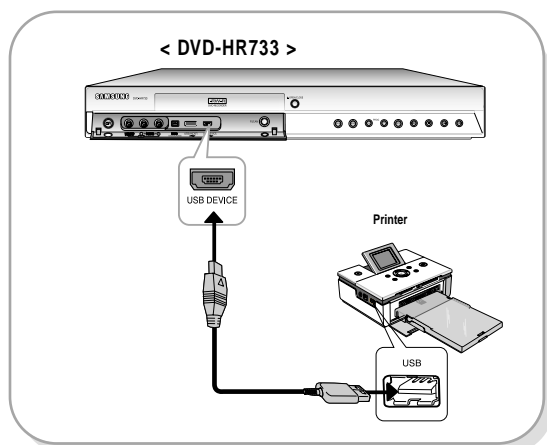

NOTE

- For printing information, refer to the User's manual of the printer.
- Depending on the printer, printing failure may occur.

## Case 2 : Connecting a USB memory, MP3 player, Digital Camera to the USB port.

Connecting a USB memory or other USB device to USB HOST of the HDD & DVD RECORDER.

You can transfer JPEG, MP3 and DivX file of the MP3 player, USB memory or digital camera to a HDD & DVD RECORDER using the USB interface. You can also copy JPEG, MP3 and DivX file of the HDD & DVD RECORDER to MP3 player, USB memory or digital camera using the USB interface. (See pages 110~113)

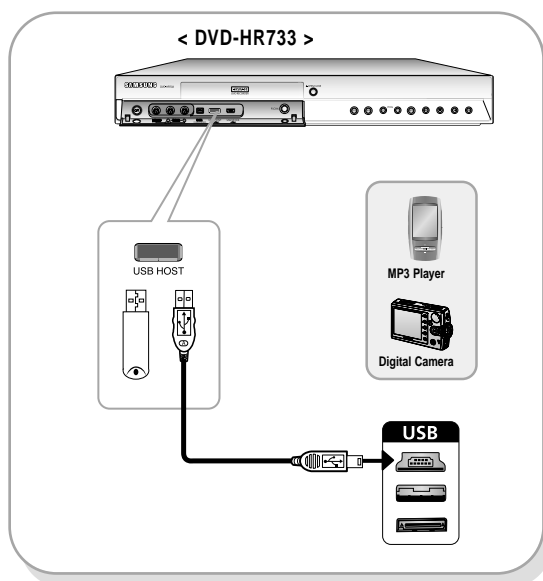

NOTE

- Disconnecting the USB cable during the data transfer will stop the communication and may damage data stored in the memory.
- When data communication is disrupted due to static electricity, magnetic field or other reason, restart the programme or try to disconnect / connect the USB Cable again.

# System Setup

On-Screen Menu Navigation . . . . .	27
Plug & Auto Setup . . . . .	28
Setting the Clock . . . . .	29
Presetting Channels with the Auto Setup function . . . . .	30
Presetting Channels with the Manual Setup function . . . . .	31
Setting up the Language Options . . . . .	32
Auto Power Off Setting . . . . .	33
Setting up the Quick Recording Options . . . . .	34
Automatic Chapter Creator . . . . .	35
DivX(R) Registration . . . . .	36
CM Skip Time Setting . . . . .	36
EP Mode Time Setting . . . . .	37
Setting up the Audio Options . . . . .	38
Setting up the Video display Options . . . . .	40
Setting up Video Output Options . . . . .	41
Setting up the Progressive scan . . . . .	41
Canceling the Progressive scan . . . . .	42
Setting up the Parental Lock . . . . .	43

## On-Screen Menu Navigation

The on-screen menus allow you to enable or disable various functions on your HDD & DVD RECORDER. Use the following buttons to open and navigate through the on-screen menus.



### 1 MENU Button

Press this button on the remote control to open the on-screen menu.  
Press again to exit the on-screen menu.

### 2 ▲▼◀▶ Buttons

Press these buttons on the remote control to move the selection bar ▲▼◀▶ to cycle through the menu options.

### 3 OK Button

Press this button on the remote control to confirm any new settings.

### 4 RETURN Button

Press this button on the remote control to return to the Previous menu screen displayed or to exit the on-screen menu.

# Plug & Auto Setup

Your HDD & DVD RECORDER will automatically set itself up when it is plugged in for the first time. TV stations and clock will be stored in memory. The process takes a few minutes. Your HDD & DVD RECORDER will then be ready for use.

- 1 Connect the RF cable as indicated on page 19. (Connecting Your HDD & DVD RECORDER to the TV Using the RF Cable and scart cable.)

(HR738 Only)

To use HDMI cable, make the Audio/Video connection before plugging in the power cord or after finishing the "Plug & Auto Setup."

Do not connect the HDMI cable while the "Plug & Auto Setup" is progressing.

- 2 Plug the HDD & DVD RECORDER into the mains. "AUTO" in the front panel display flickers.

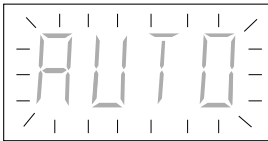

- 3 Press the **OK** button to start the auto setup.

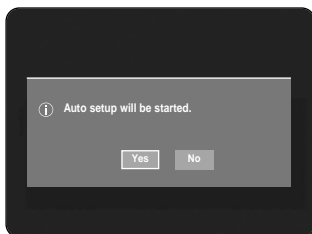

- 4 Auto channel scan will be started.

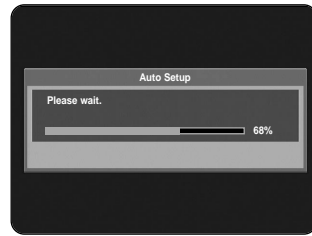

- 5 After auto channel scan is completed, auto clock setting will be started automatically in 10 seconds. If you want to start auto clock setting immediately, press **OK** button. If you do not want to do auto clock setting, press **CANCEL** or **MENU** button.

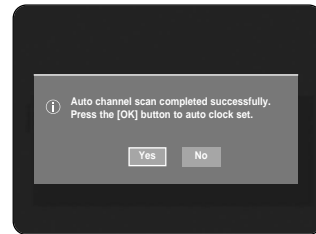

- 6 Wait until current date and time are displayed automatically. If you want to exit auto clock setting, press **MENU** button.

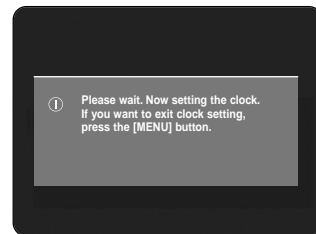

## 7 Check the date and time.

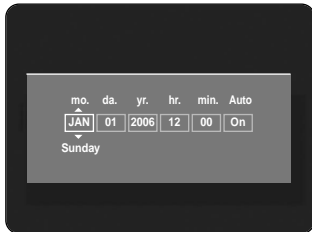

- if it is : Correct, press **OK** button then the date and time will be saved. If you don't press the **OK** button, the date and time will be saved automatically after 5 seconds.
- if it is : Incorrect, input correct **Month, Day, Year, Hour or Minute** using **▲▼◀▶** buttons or number buttons. Press **OK** button then the date and time will be saved. When you need to change clock setting, you can set up it manually.



NOTE

- Now, HDD & DVD RECORDER is ready for use. Function for "Plug & Auto Setup" is fixed already. So if you want to change this fixed one, you can change it by Presetting the Stations in OSD "Presetting Channels with the Manual Setup function" menu. (See page 31~32)
- Auto setup function can be performed by pressing **STOP** (⊙) on the unit continuously for 5 seconds or more during power off with no disc inserted.

## Setting the Clock

This menu is used to set the current time. You need to set the time to use timer recording.

- 1 With the unit in Stop mode, press the **MENU** button.



- 2 Press the **▲▼** buttons to select **Setup**, then press the **OK** or **▶** button.



- 3 Press the **▲▼** buttons to select **System**, then press the **OK** or **▶** button.

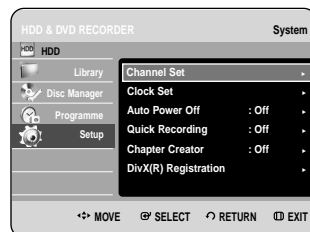

- 4** Press the ▲▼ buttons to select **Clock Set**, then press the **OK** or ► button.  
Press the ▲▼◀▶ buttons to input Month, Day, Year, Hour or Minute. Press the number buttons to input clock data directly.  
The day of the week is displayed automatically.



- 5** Press the ▲▼ buttons to select **On** for the Auto Clock.

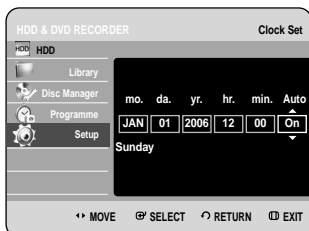

- 6** Press the **OK** button, then the date and time will be saved. If you don't press the **OK** button, it will not be saved.



NOTE

- You must have the RF cable connected to set the Auto Clock. (See page 19)
- The HDD & DVD RECORDER automatically sets the clock according to the time signal broadcast between the channels PR1 to PR5. If you do not need the Auto Clock Set function, select Off.

## Presetting Channels with the Auto Setup function

This feature allows you to manually set the HDD & DVD RECORDER tuner band to Antenna or Cable, whichever you connected to the Antenna In jack during initial setup.

- 1** With the unit in Stop mode, press the **MENU** button.

- 2** Press the ▲▼ buttons to select **Setup**, then press the **OK** or ► button.



- 3** press the ▲▼ buttons to select **System**, then press the **OK** or ► button.

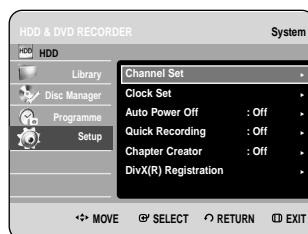

- 4** Press the ▲▼ buttons to select **Channel Set**, then press the **OK** or ► button.

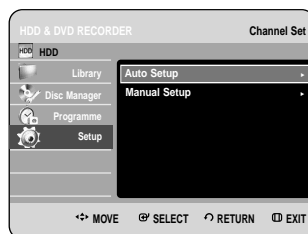

- 5** Press the ▲▼ buttons to select **Auto Setup**, then press the **OK** or ► button. The message “Your data will be lost. Press [OK] to continue, [Return] to exit.” is displayed.

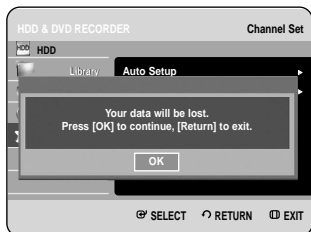

- 6** Press the **OK** button. If you want to exit, press the **MENU** button.

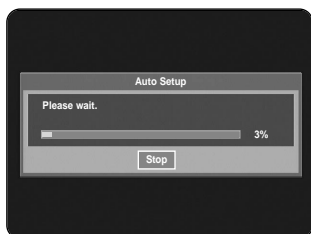

- The first frequency band is scanned and the first station found is displayed and stored. And the HDD & DVD RECORDER searches for the second station and so on.
- The number of stations automatically stored by the HDD & DVD RECORDER depends on the number of stations that it has found.

- 7** Channel scan will be started. Press the **OK** button to stop the Auto Setup.

## Presetting Channels with the Manual Setup function

You can add preset channel that Auto Channel Search missed. And you can delete a channel you wish to remove. You can programme the order of channels.

- 1** With the unit in Stop mode, press the **MENU** button.

- 2** Press the ▲▼ buttons to select **Setup**, then press the **OK** or ► button.

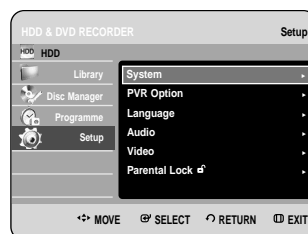

- 3** Press the ▲▼ buttons to select **System**, then press the **OK** or ► button.

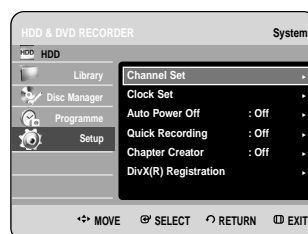

- 4** Press the ▲▼ buttons to select **Channel Set**, then press the **OK** or ► button.

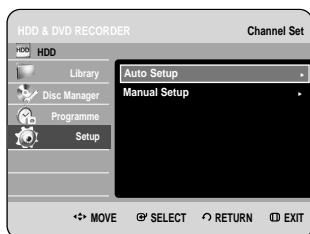

- 5** Press the ▲▼ buttons to select **Manual Setup**, then press the **OK** or ► button.

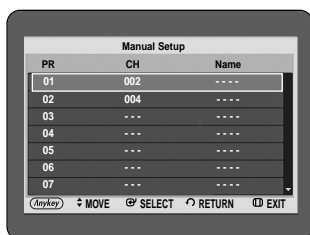

- 6** Press the ▲▼ buttons to select a **PR(programme)** you wish to edit, delete, or swap, then press the **ANYKEY** button. Select **Edit**, **Delete** or **Swap**.

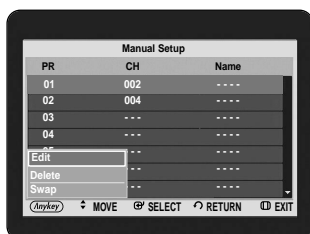

- **In case of Edit** : You can add or edit PR(programme) information. After change PR informations (**CH.**, **Name**, **MFT**), select **Save**, then press the **OK** button.

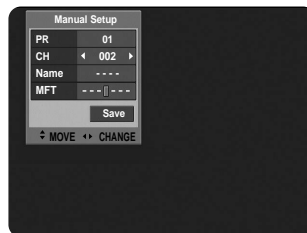

- **CH** : Tune the channel using ◀▶ buttons.
- **Name** : Display station name automatically detected in broadcasting signal. If not detected, you can edit name by using ▲▼◀▶ buttons.
- **MFT(Manual Frequency Tunning)** : You can tune up the channel frequency better using ◀▶ buttons.

- **In case of Delete** : the channel information of selected PR(programme) will be removed.

- **In case of Swap** : You can swap the channel information of two PR(programme). For example, if you wish to swap PR2 and PR5, select swap at PR2, then press the **OK** button at PR5.

## Setting up the Language Options

If you set the audio, subtitle, disc menu and on-screen menu, in advance, they will come up automatically every time you watch a movie.

If the selected language is not recorded on the disc, the original pre-recorded language is selected.

- 1** With the unit in Stop mode, press the **MENU** button.



- 2** Press the ▲▼ buttons to select **Setup**, then press the **OK** or ► button.



- 3** Press the ▲▼ buttons to select **Language**, then press the **OK** or ► button. Language setup menu will be displayed.



- 4** Press the ▲▼ buttons to select the desired language option, press the **OK** or ► button.



- **Audio** : For the disc audio language.
- **Subtitle** : For the disc subtitles.
- **Disc Menu**: For the disc menu contained on the disc
- **Menu**: For the on-screen menu of your HDD & DVD RECORDER.

- 5** Press the ▲▼ buttons to select the desired language, then press the **OK** or ► button.



NOTE

- Press the **RETURN** or ◀ button to return to the previous menu. Press the **MENU** button to exit the menu.
- The selected language will only appear if it is supported on the disc.

## Auto Power Off Setting

This feature automatically turns off your HDD & DVD RECORDER, if you do not press any button for the selected time.

- 1** With the unit in Stop mode, press the **MENU** button.
- 2** Press the ▲▼ buttons to select **Setup**, then press the **OK** or ► button.



- 3** Press the ▲▼ buttons to select **System**, then press the **OK** or ► button. System menu will be displayed.

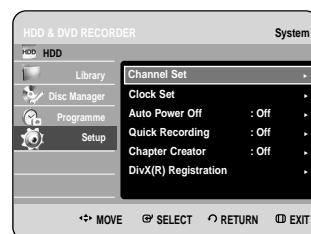

- 4** Press the ▲▼ buttons to select **Auto Power Off**, then press the **OK** or ► button.

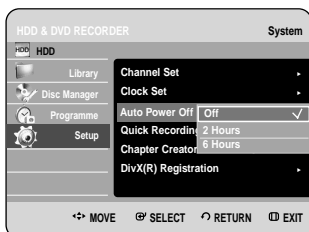

- 5** Press the ▲▼ buttons to select the desired item, then press the **OK** or ► button.

- **Off** : Auto power off is disabled.
- **2 Hours** : HDD & DVD RECORDER will automatically turn off for 2 hours after the last button is pressed.
- **6 Hours** : HDD & DVD RECORDER will automatically turn off for 6 hours after the last button is pressed.
- If the turn off time set with the Auto Power off function is reached during playback or recording, the device will operate until the playback or recording is finished.

## Setting up the Quick Recording Options

If this function is set to on, the HDD & DVD RECORDER will power on quickly, which enables you to immediately record a desired channel.

- 1** With the unit in Stop mode/No Disc mode, press the **MENU** button.

- 2** Press the ▲▼ buttons to select **Setup**, then press the **OK** or ► button.

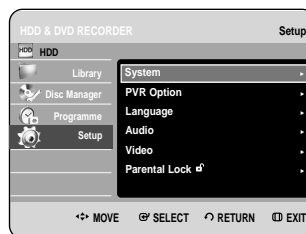

- 3** Press the ▲▼ buttons to select **System**, then press the **OK** or ► button.

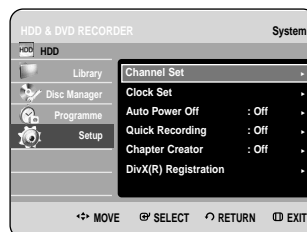

- 4** Press the ▲▼ buttons to select **Quick Recording**, then press the **OK** or ► button.

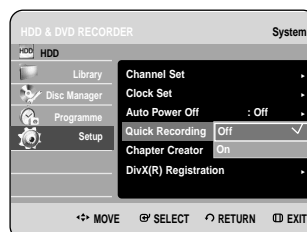

- 5** Press the ▲▼ buttons to select **On**, then press the **OK** or ► button.



NOTE

- The Quick Recording is set to Off as default.
- If this function is set to on, power consumption will be increased when the unit power off.

# Automatic Chapter Creator

A DVD-Video consists of 'Titles' and 'Chapters'. When you record one programme, it makes one Title. If you use this function, the Title will be divided into Chapters.



(V mode)

- 1 With the unit in Stop mode, press the **MENU** button.
- 2 Press the **▲▼** buttons to select **Setup**, then press the **OK** or **▶** button.

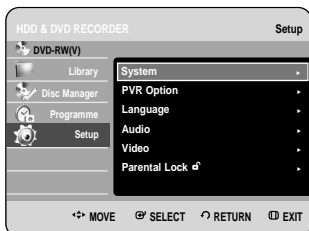

- 3 Press the **▲▼** buttons to select **System**, then press the **OK** or **▶** button. System menu will be displayed.

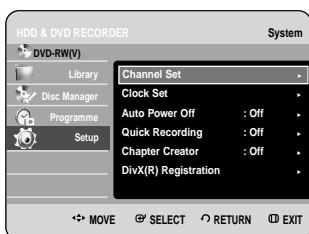

- 4 Press the **▲▼** buttons to select **Chapter Creator**, then press the **OK** or **▶** button.

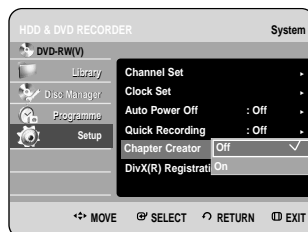

- 5 Press the **▲▼** buttons to select **Off** or **On**, then press the **OK** or **▶** button.
  - **Off**: Select if you do not want use Automatic Chapter Creator.
  - **On**: Select this option to use the Automatic Chapter Creator feature.

Press the **MENU** button to exit the menu.

- 6 Press the **REC** button to start recording. (See page 76 about how to set recording speed) The message "Do you want to create the chapter menu after this recording?" is displayed.

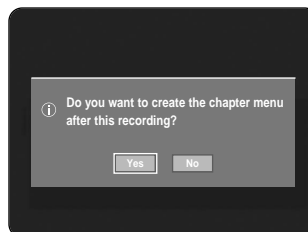

- 7 Press the **◀▶** buttons to select **Yes** and press the **OK** button.
  - A new chapter is created according to the selected recording mode. A chapter will be about 5 minutes long in XP and SP, and about 15 minutes long in LP and EP mode.

- 8 Press the **STOP** button to stop recording.

- 9** To display the created titles, finalise the disc (See page 118) and then press the **TITLE MENU** button. The title menu will be displayed.

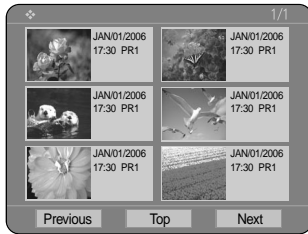

- 10** To display the created chapters, select the desired Title and then press the **DISC MENU** button. The chapter menu for the selected Title will be displayed.

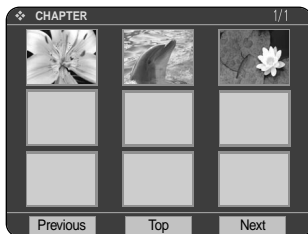

Caution

- The Automatic Chapter Creator function does not work during Timer Recording or when you turn the power off.

## DivX(R) Registration

Please use the Registration code to register this HDD & DVD RECORDER with the DivX(R) Video On Demand format. For more information, visit [www.divx.com/vod](http://www.divx.com/vod)

## CM Skip Time Setting

When a programme recorded on a HDD, a DVD-RW, or a DVD-R is played, the unit can be set to automatically skip a portion of the programme corresponding to a CM (commercial) skip time set by the user.

- 1 With the unit in Stop mode, press the **MENU** button.
- 2 Press the **▲▼** buttons to select **Setup**, then press the **OK** or **▶** button.

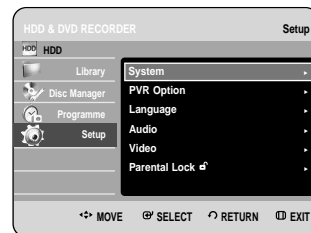

- 3 Press the **▲▼** buttons to select **PVR Option**, then press the **OK** or **▶** button. **PVR Option** menu will be displayed.



- 4** Press the ▲▼ buttons to select **CM Skip Time**, then press the **OK** or ► button.

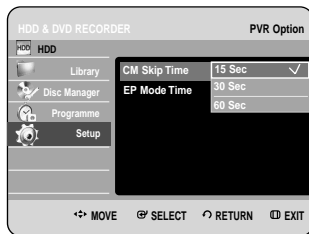

- 5** Press the ▲▼ buttons to select the desired time interval, then press the **OK** or ► button.

- 6** If you press the **CM SKIP** button during playback, the section corresponding to the set time is skipped, and then the next section is played.



NOTE

- CM Skip can be performed only during normal playback.
- When the time set is more than a remaining time of a current title: The next title is played from the beginning.
- When the time set is more than a remaining time of a play list, the next scene is played.
- CM Skip does not work in still picture mode.
- When a set time is greater than the remaining time of a scene, last title, or last track that is currently displayed, a prohibition mark appears.
- CM Skip releases Repeat (including Repeat A-B, Chapter, and Title).
- CM Skip may not operate with some DVD-Video discs.

## EP Mode Time Setting

You can select one of four recording modes by pressing the **REC MODE** button repeatedly. EP mode is one of four REC Mode (XP, SP, LP, EP). In EP(Extended Play) mode, you can set recording time to 6 or 8 hours with this setting.

- 1** With the unit in Stop mode, press the **MENU** button.

- 2** Press the ▲▼ buttons to select **Setup**, then press the **OK** or ► button.



- 3** Press the ▲▼ buttons to select **PVR Option**, then press the **OK** or ► button. **PVR Option** menu will be displayed.

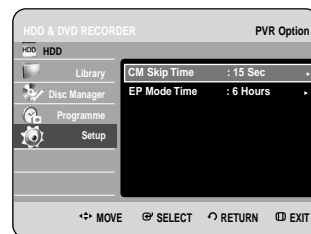

- 4** Press the ▲▼ buttons to select **EP Mode Time**, then press the **OK** or ► button.



- 5** Press the ▲▼ buttons to select the desired Time, then press the **OK** or ► button.

- 3** Press the ▲▼ buttons to select **Audio**, then press the **OK** or ► button.

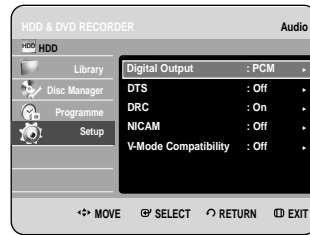

- 4** Press the ▲▼ buttons to select the desired audio option, then press the **OK** or ► button.

- 5** Press the ▲▼ buttons to select the desired item, then press the **OK** or ► button.

## Setting up the Audio Options

You can connect the HDD & DVD RECORDER to an external amp or Home theatre. Allows you to setup the Audio device and sound status depending on the audio system in use. You can also set NICAM mode.

- 1** With the unit in Stop mode, press the **MENU** button.
- 2** Press the ▲▼ buttons to select **Setup**, then press the **OK** or ► button.



- NOTE**
- Press the **RETURN** or ◀ button to return to the previous menu. Press the **MENU** button to exit the menu.

## Digital Output

1. **PCM** : Select this when your equipment is not decode Dolby Digital compatible.
2. **Bitstream** : Outputs Dolby Digital (or MPEG-2) audio as bitstream. Select this when your AV receiver or AV amplifier has a Dolby Digital (or MPEG-2) Decoder.

- NOTE**
- Digital output setting is equally applied to both Dolby Digital and MPEG-2 audio. LPCM sound track is always outputted as PCM. It has no relation with Digital Output setting.
  - Be sure to select the correct Digital Output or you will hear no sound or a loud noise.

## DTS

1. Off : Doesn't output DTS signal. Select this when your AV receiver (or AV amplifier) does not have DTS decoder.
2. On : Outputs DTS Bitstream via digital output when you play DTS track. Select this only when your AV receiver (or AV amplifier) have DTS decoder.



NOTE

- When DTS soundtrack is played, sound does not output from AV Audio Output.

## DRC

This is only active when a Dolby Digital signal is detected.

1. Off : You can enjoy the movie with the standard Dynamic Range.
2. On : When Movie soundtracks are played at low volume or from smaller speakers, the system can apply appropriate compression to make low-level content more intelligible and prevent dramatic passages from getting too loud.

## NICAM

NICAM programmes are divided into 3 types. NICAM Stereo, NICAM Mono and Bilingual (transmission in another language). NICAM programmes are always accompanied by a standard mono sound broadcast and you can select the desired sound by setting NICAM on or off.

1. Off: Only set at this position to record the standard mono sound during a NICAM broadcast if the stereo sound is distorted due to inferior reception conditions.
2. On: NICAM mode

## V-Mode Compatibility

This feature is about the setup for selecting audios when recording the NICAM STEREO (Multi-audio) broadcasting on HDD. It does not affect to the direct DVD recording of a programme.

1. Off : Both "Dual L" and "Dual R" of the multi-audio broadcasting are recorded on HDD. Titles recorded on HDD under such setup status cannot be copied to V mode (DVD-RW/-R).
2. On : Either "Dual L" or "Dual R" of the multi-audio broadcasting is recorded on HDD. Titles recorded on HDD under such setup status can be copied to DVD-R or DVD-RW (V mode). "Dual L" and "Dual R" options can be selected from "Audio Selection."

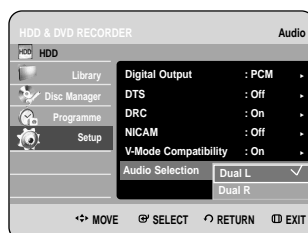
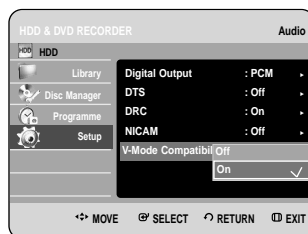

# Setting up the Video display Options

This function allows you to setup the TV screen settings. This function depends on disc type. It may not work for some disc types.

- 1 With the unit in Stop mode, press the **MENU** button.
- 2 Press the **▲▼** buttons to select **Setup**, then press the **OK** or **▶** button.



- 3 Press the **▲▼** buttons to select **Video**, then press the **OK** or **▶** button. Video setup menu will be displayed.

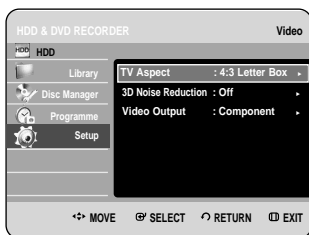

- 4 Press the **▲▼** buttons to select the desired video option, then press the **OK** or **▶** button.

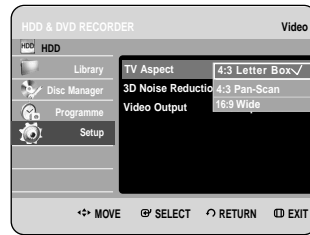

- 5 Press the **▲▼** buttons to select the desired item, then press the **OK** or **▶** button.



NOTE

- Press the **RETURN** or **◀** button to return to the previous menu. Press the **MENU** button to exit the menu.

## TV Aspect

Depending on the type of television you have, you may want to adjust the screen setting. (aspect ratio)

1. 4:3 Letter Box : Select when you want to see the total 16:9 ratio screen DVD supplies, even though you have a TV with a 4:3 ratio screen. Black bars will appear at the top and bottom of the screen.
2. 4:3 Pan-Scan : Select this for conventional size TV when you want to see the central portion of the 16:9 screen. (Extreme left and right side of movie picture will be cut off.)
3. 16:9 Wide : You can view the full 16:9 picture on your widescreen TV.

## 3D Noise Reduction (motion adaptive noise reduction)

1. Off : Normal
2. On : Provides a clear picture through noise reduction (for recording).



# Setting up Video Output Options

You can enjoy high quality image through RGB or Component video connections. RGB video output is available connecting scart jack(AV1) and component video output is available connecting component(Y,P<sub>B</sub>,P<sub>R</sub>) jack. Only one of these signals can be selected at one time.

**1** With the unit in Stop mode, press the **MENU** button.

**2** Press the **▲▼** buttons to select **Setup**, then press the **OK** or **▶** button.

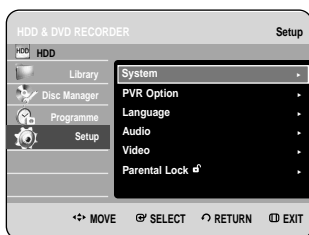

**3** Press the **▲▼** buttons to select **Video**, then press the **OK** or **▶** button. Video setup menu will be displayed.

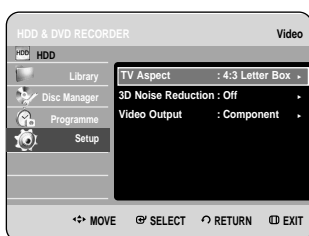

**4** Press the **▲▼** buttons to select **Video Output**, then press the **OK** or **▶** button.

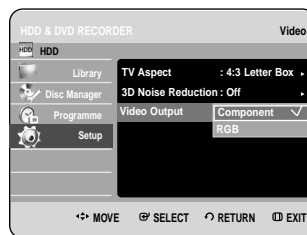

**5** Press the **▲▼** buttons to select the desired item, then press the **OK** or **▶** button.

In Component mode, you can set video output to Progressive(P.SCAN) or Interlace, see pages 41 to 43.

Available video output jacks are as follow.

## Available Video Output Jack

Output jack	Setting mode	Component mode		RGB Mode
		P.SCAN off mode (Interlace mode)	P.SCAN on mode	
Component Output (Y, P <sub>B</sub> , P <sub>R</sub> )		0	0 (TV in progressive mode)	X
AV1 Scart	R, G, B	X	X	0
	Composite	0	X	X
Composite Video out		0	X	0
S-Video out		0	X	0



NOTE

- When the HDMI cable is connected, other Video output does not operate. (HR738 Only)

# Setting up the Progressive scan

If your TV supports Progressive Scan, press the **P.SCAN** button on the front of the HDD & DVD RECORDER.

To view 'Progressive scan mode', first connect the component cable.(See page 21)

Be sure the Component cables are connected properly.

- 1 With the unit in Stop mode, press the **P.SCAN** button on the front of the HDD & DVD RECORDER. The message "Press [Yes] to confirm Progressive scan mode. Otherwise, press [No]." will appear. Press the ◀ ▶ buttons to select **Yes**, and then press the **OK** button.

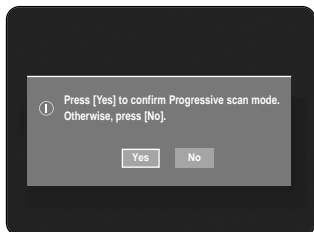

- 2 The message "Please, set your TV to Progressive input. To deactivate, press [STOP] key." will appear. Press the **OK** button.

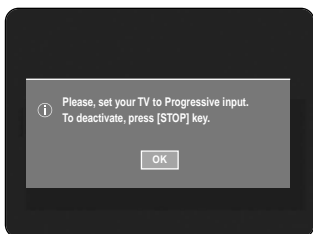

- 3 The message "Video Output Mode Progressive Scan" will appear. The video will now be Progressive Scan.

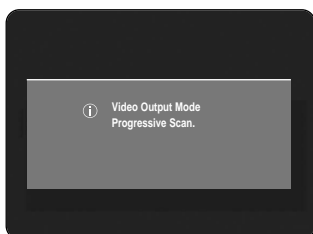

## NOTE

- When the HDMI cable is connected, this screen is not displayed. (HR738 Only)
- If the **P.SCAN** button on the HDD & DVD RECORDER's front panel is pressed during playback, the message "This function is possible only on stop mode" appears on the screen.
- Progressive setting is only available when the HDD & DVD RECORDER is in stop mode.

## Canceling the Progressive scan



- 1 With the unit in Stop mode, press the **P.SCAN** button on the front of the HDD & DVD RECORDER. The message "Press [Yes] to confirm Interlace scan mode. Otherwise, press [No]." will appear. Press the ◀ ▶ buttons to select **Yes**, and then press the **OK** button.

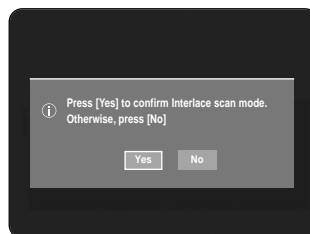

- 2 The message "Please, set your TV to Interlace input. To deactivate, press [STOP] key." will appear. Press the **OK** button.

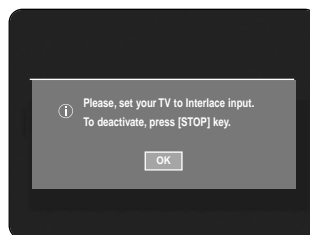

- 3 The message "Video Output Mode Interlace Scan" will appear.

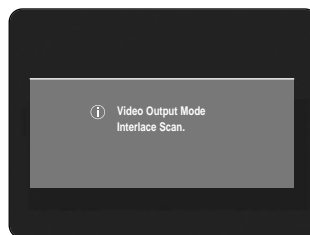



NOTE

- Do not press the **P.SCAN** button if you are using a TV that does not support Progressive mode as nothing will be displayed on the screen.
- If you press the **P.SCAN** button by mistake when your TV does not support Progressive mode, the mode will then need to be released. To release the Progressive mode, press the **P.SCAN** button on the front panel 3 times. The screen will recover after the PS indicator on the front panel display turns off.

## Setting up the Parental Lock

The Parental Lock function works in conjunction with DVDs that have been assigned a rating which helps you control the types of DVDs that your family watches. There are up to 8 rating levels on a disc.



**1** With the unit in Stop mode, press the **MENU** button.

**2** Press the **▲▼** buttons to select **Setup**, then press the **OK** or **▶** button.

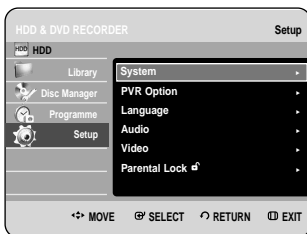

**3** Press the **▲▼** buttons to select **Parental Lock**, then press the **OK** or **▶** button. When you operate your HDD & DVD RECORDER for the first time, the "Create the Password" message will be displayed.

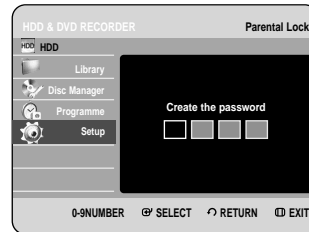

**4** Enter the 4-digit password using the number buttons on the remote control. The "Confirm the password" message will be displayed. Enter your password again.

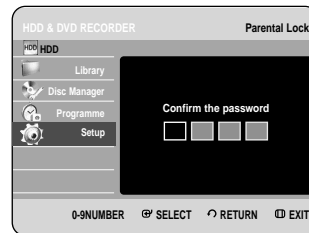

**5** Press the **OK** or **▶** button to select **Password**.

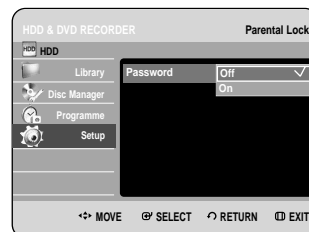

**6** Press the **▲▼** buttons to select **On** or **Off**, then press the **OK** or **▶** button.



NOTE

- Press the **RETURN** or **◀** button to return to the previous menu. Press the **MENU** button to exit the menu.

## If you forgot your password

- 1 Remove the disc.
- 2 Press and hold the **PROG** (⏪ ⏩) button on the front panel for 5 seconds or more.

## Setting the Rating Level

- 1 Press the **▲▼** buttons to select **Rating Level**, then press the **OK** or **▶** button.

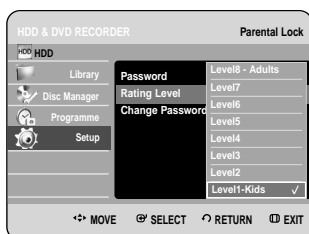

- 2 Press the **▲▼** buttons to select the rating level you want, then press the **OK** or **▶** button. For example, if you select up to Level 6, discs that contain Level 7, 8 will not play. A larger number indicates that the programme is intended for adult use only.

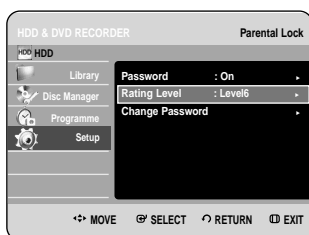

## Changing the Password

- 1 Press the **▲▼** buttons to select **Change Password**, then press the **OK** or **▶** button.

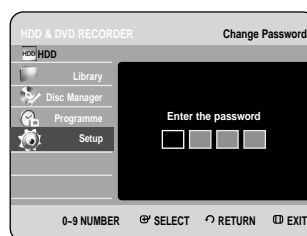
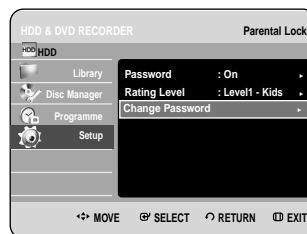

- 2 Enter the 4-digit password using the number buttons on the remote control. The "Confirm the password" message will be displayed.

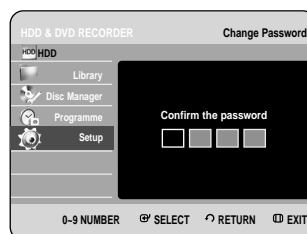

- 3 Enter your password again using the number buttons on the remote control.

# Playback

This section introduces basic functions of playback and playback by disc type.



Dolby Digital



DTS



Digital Audio



Stereo



PAL broadcast system in U.K, France, Germany, etc.



MP3



DivX

Before Playing .....	45
Playing a Disc.....	46
Using the Disc Menu & Title Menu .....	47
Using the Search & Skip Functions.....	47
Slow Motion Play/Step Motion Play .....	48
About ANYKEY .....	49
Playing the Title List .....	50
Navigation menu .....	51
Using Markers .....	54
Using the Bookmarks .....	56
Selecting the Subtitle Language .....	57
Selecting the Soundtracks & Audio channels .....	58
Changing the Camera Angle.....	59
Repeat Play .....	60
Zooming-In .....	61
Select Media.....	62
Playing an Audio CD/MP3.....	62
Viewing a Picture .....	69
Playing an MPEG4 .....	73

## Before Playing

Read the following information before playing a disc.

### Region code (DVD-Video only)



Both the HDD & DVD RECORDER and the discs are coded by region. These regional codes must match in order for the disc to play. If the codes do not match, the disc will not play.



The Region Number for this HDD & DVD RECORDER is described on the rear panel of the HDD & DVD RECORDER.

### Disc types that can be played

Disc Types	Disc Logo	Recorded content	Disc Shape	Max. Playing Time or minute
DVD-VIDEO		AUDIO + VIDEO	Single sided(12cm)	240
			Double sided(12cm)	480
			Single sided(8cm)	80
			Double sided(8cm)	160
AUDIO-CD		AUDIO	Single sided(12cm)	74
			Single sided(8cm)	20
DVD-RAM		AUDIO + VIDEO	Single-sided 12cm (4.7GB)	1 (XP: Excellent Quality)
				2 (SP: Standard Quality)
			Double-sided 12cm (9.4GB)	4 (LP: Long Playback)
				6 or 8 (EP: Extended)
				2 (XP: Excellent Quality)
				4 (SP: Standard Quality)
				8 (LP: Long Playback)
				12 or 16 (EP: Extended)
DVD-RW		AUDIO + VIDEO	12cm (4.7GB)	1 (XP: Excellent Quality)
				2 (SP: Standard Quality)
				4 (LP: Long Playback)
				6 or 8 (EP: Extended)
DVD-R		AUDIO + VIDEO	12cm (4.7GB)	1 (XP: Excellent Quality)
				2 (SP: Standard Quality)
				4 (LP: Long Playback)
				6 or 8 (EP: Extended)
CD-R/-RW		JPEG		
DVD-RAM/-RW/-R		MP3 MPEG4	-	-
HDD	DVD-HR733		AUDIO + VIDEO	Approx. 18 (XP: Excellent Quality) Approx. 33 (SP: Standard Quality) Approx. 64 (LP: Long Playback) Approx. 95 or Approx. 127 (EP: Extended)
	DVD-HR738		AUDIO + VIDEO	Approx. 61 (XP: Excellent Quality) Approx. 113 (SP: Standard Quality) Approx. 219 (LP: Long Playback) Approx. 324 or Approx. 429 (EP: Extended)

## Discs that cannot be played

- DVD-Video with a region number other than "2" or "ALL"
- 12cm 2.6 GB and 5.2 GB DVD-RAM
- 3.9 GB DVD-R Disc for Authoring.
- DVD-RAM/RW(VR mode) not recorded following the Video Recording Standard
- Unfinalised DVD-R, unfinalised DVD-RW(V mode) recorded on other equipment.
- DVD-ROM/PD/MV-Disc, etc
- CVD/CD-ROM/CDV/CD-G/CD-I



NOTE

- This HDD & DVD RECORDER can only operate with discs that are compatible with DVD-RAM Standard Version 2.0.
- Playback and/or recording may not work for some types of discs, or when specific operations, such as angle change and aspect ratio adjustment, are being performed. Information about the discs is written in detail on the box. Please refer to this if necessary.
- Do not allow the disc to become dirty or scratched, finger prints, dirt, dust, scratches or deposits of cigarette smoke on the recording surface may make it impossible to use the disc for recording.
- DVD-RAM/-RW/-R discs may not be able to play on some DVD players, depending on the player, disc and the condition of the recording.
- Discs with NTSC programmes recorded on them cannot be played and recorded using this product.

## Playing a Disc

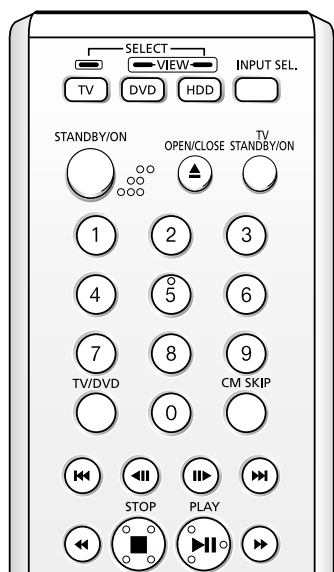

1

Press the **OPEN/CLOSE** button.

2

Place a disc gently into the tray with the disc's label facing up.

3

Press the **OPEN/CLOSE** button to close the disc tray.

- Your HDD & DVD RECORDER closes the disc tray and plays the disc automatically.
- The HDD & DVD RECORDER does not play discs automatically after being powered on initially.
- When the HDD & DVD RECORDER is powered on and a disc is in the tray, the unit will be activated and wait in stop status.
- Press the **PLAY**(▶) button to start playback.
- If you want the unit to play automatically when it is powered on with a disc in the unit, power on with the **PLAY**(▶) button.

4

Press the **STOP**(■) button to stop playback.



NOTE

- When you stop playing back a disc, the HDD & DVD RECORDER remembers where you stopped, so when you press **PLAY**(▶) button again, it will pick up where you left off. (Unless the disc is removed or the HDD & DVD RECORDER is unplugged, or if you press the **STOP**(■) button twice.)



Caution

- Do not move your HDD & DVD RECORDER while playing, as this may cause damage to the disc.
- Make sure to press the **OPEN/CLOSE** button to open or close the disc tray.
- Do not push the disc tray while it is being opened or closed, as this may cause a product malfunction.
- Do not place foreign materials on or in the disc tray.
- Some functions may perform differently or be disabled depending on the disc type. If this occurs, refer to the instructions written on the disc case.
- Be especially careful that children's fingers are not caught between the disc tray and the tray chassis when it closes.
- You must only insert one DVD disc at a time. Inserting two or more discs will not allow playback and may cause damage to the HDD & DVD RECORDER.

# Using the Disc Menu & Title Menu

Some type of discs contain a dedicated menu system that allows you to select special functions for title, chapter, audio track, subtitle, film preview, information on characters, etc.

## For DVD-VIDEO Disc



- 1 Press the **DISC MENU** button to enter the disc menu of the disc.
  - Move to the setup menu related to playback operation.
  - You can select audio language and subtitle etc. provided by the disc.

- 2 Press the **TITLE MENU** button to move to the title menu of the disc.
  - Press this button if the disc contains more than one title. Some discs may not support the title menu functionality.

## For HDD/DVD-RAM/-RW/-R Disc



- 1 Press the **TITLE LIST** button to display title list.



NOTE

- **Title List** : Title List is a list of previously recorded programmes. If a title is deleted, that title cannot be played again.
- **Play List** : This refers to a list of user-selected titles. When one playlist is played, only the scene selected by the user will play and then stop. Since only the information necessary for playing a desired scene is included in a playlist, even if that playlist is deleted, the original recording will not be deleted. (only VR mode)

# Using the Search & Skip Functions

## Searching through a Chapter or Track



- 1 During play, press the **SEARCH** (◀▶) buttons on the remote control.

HDD/ DVD-VIDEO/ DVD-RAM/-RW/-R	▶▶ Fast 1 →    ▶▶ Fast 2 → ▶▶ Fast 3 →    ▶▶ Fast 4 → ▶▶ Fast 5 →    ▶▶ Fast 6 →
MPEG4	▶▶ Fast 1 → ▶▶ Fast 2 → ▶▶ Fast 3
AUDIO CD (CD-DA)	▶▶ X 2 → ▶▶ X 4 → ▶▶ X 8 →

- You can scan the programme in reverse. To return to normal speed playback, press the **PLAY** (▶) button.
- When you press and hold the **SEARCH** (◀▶) buttons, playback is done at the default speed of X4. If you release the **SEARCH** (◀▶) buttons, playback is performed at a normal speed.
- The speed marked in this function may be different from the actual playback speed.



NOTE

- No sound is heard during Scan(Search) mode, except with CDs (CD-DA). (You can hear sound during forward search(Fast 1) in disc.)

## Skipping Chapters, Tracks or Markers

During play, you can search quickly through a chapter or track.

- 1 During play, press the **SKIP** (⏮) (⏭) buttons on the remote control.
  - If you press the **SKIP** (⏮) button, it moves to the beginning of the chapter or track or marker(HDD/DVD-RAM/-RW(VR mode)). Pressing the button once again within 3 seconds returns to the beginning of the previous chapter or track or marker(HDD/DVD-RAM/-RW(VR mode)).
  - If you press the **SKIP** (⏭) button, it moves to the next chapter or track or marker (HDD/DVD-RAM/-RW(VR mode)).

## Slow Motion Play/ Step Motion Play

### Slow Motion Play



In pause or step mode, press the **SEARCH** (⏪) (⏩) buttons on the remote control.

- If you press the **SEARCH** (⏩) button,
  - ▶ Slow 1 → ▶ Slow 2 → ▶ Slow 3
- If you press the **SEARCH** (⏪) button,
  - ◀ Slow 1 → ◀ Slow 2 → ◀ Slow 3
- To return to normal speed playback, press the **PLAY** (⏮) button.

Press and hold the **SEARCH** (⏪) (⏩) buttons during pause, the disc will play slowly at 1/4 speed. If the button is released, the pause operation will resume.



NOTE

- The speed marked in this function may be different from the actual playback speed.
- Slow motion operates only in the forward direction on MPEG4 discs.

## Step Motion Play



Press the **STEP** (⏮) (⏭) buttons on the remote control in the pause mode.

- Each time the button is pressed, a new frame will appear.
  - When the **STEP** (⏮) button is pressed, the previous frame will be activated.
  - When the **STEP** (⏭) button is pressed, the next frame will be activated.
- To return to normal speed playback, press the **PLAY** (⏮) button.



NOTE

- Step motion operates only in the forward direction on MPEG4 discs.



# About ANYKEY

The ANYKEY function allows you to easily search for a desired scene by accessing title, chapter, time. You can also change the subtitle and audio settings and set some features including Marker, Angle, Zoom, Repeat, Media.

## Moving to a scene directly using the ANYKEY

- If you want to move to a title or a chapter to find a desired scene.



- 1 Press the **ANYKEY** button during playback.

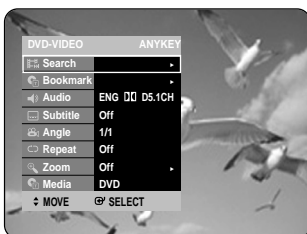
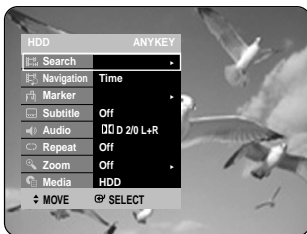

- 2 Press the **▲▼** buttons to select **Search**, then press the **OK** button or **▶** button.



- 3 Press the **▲▼** buttons to select **Title** or **Chapter**.

- 4 Press the **◀▶** buttons or number buttons to select the desired scene, then press the **OK** button.

- If you want to move to a desired time, the following instructions will help you find a scene.

- 1 Press the **ANYKEY** button during playback.

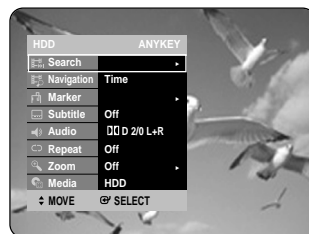

**2** Press the ▲▼ buttons to select **Search**, then press the **OK** or ► button.

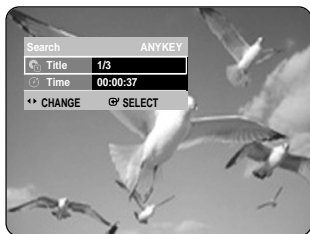

**3** Press the ▲▼ buttons to select **Time**.

**4** Enter the time in the sequence of hours, minutes, and seconds using the number buttons, then press the **OK** button.



NOTE

- This may not work for some discs. When an audio CD(CD-DA) or an MP3 disc is inserted, depending on the disc type, the information display may not appear.
- The Time Search function does not operate in some discs.
- To make the screen disappear, press the **RETURN** button.

## Playing the Title List

Follow these instructions to play back a scene from the Title List.



### Using the TITLE LIST button

**1** With the unit in Stop mode/Playback mode, press the **TITLE LIST** button. The Title List screen is displayed.

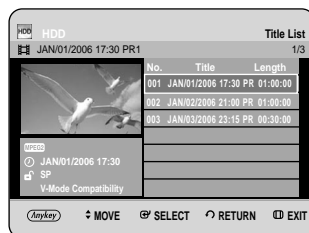

### Using the MENU button.

- With the unit in Stop mode/Playback mode, press the **MENU** button.
- Press the ▲▼ buttons to select **Library**, then press the **OK** or ► button.
- Press the ▲▼ buttons to select **Title**, then press the **OK** or ► button.

**2** Press the ▲▼ buttons to select an entry you want to play from Title List, then press the **OK** or **PLAY** (▶) button. The selected entry (title) will be played back.

**3** To stop title play, press the **STOP** (⏏) button. To return the title list screen, press the **TITLE LIST** button.

## - About INFO button -

If you press the **INFO** button once during a playback, the system information screen appears.: Displays Active Status, Background Status, and Screen information.

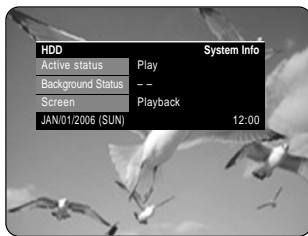

Pressing the **INFO** button twice, Disc information screen appears.: Displays Total numbers of Titles and Playlists, Recordable Time(Title), Available Space(Music/Photo).

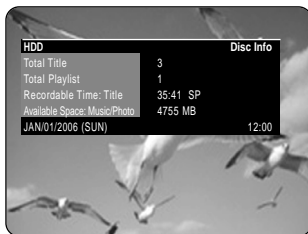

Pressing the **INFO** button three times, Current playback information screen appears.: Displays information of Playback Name, Title, Created Time, Length, Playing Time, Audio, and if the disc protection is activated.



## Navigation Menu

### Scene Navigation

If there is a title composed of markers (See page 54), you can search the desired scene using the Scene Navigation.



(VR mode)



### Using the TITLE LIST button

- 1 With the unit in Stop mode/Playback mode, press the **TITLE LIST** button.  
The Title List screen is displayed.

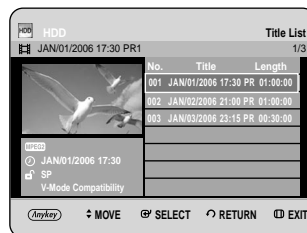

### Using the MENU button.

- With the unit in Stop mode/Playback mode, press the **MENU** button.
- Press the **▲▼** buttons to select **Library**, then press the **OK** or **▶** button.
- Press the **▲▼** buttons to select **Title**, then press the **OK** or **▶** button.

- 2 Press the **▲▼** buttons to select an entry you want to play from Title List, then press the **ANYKEY** button.

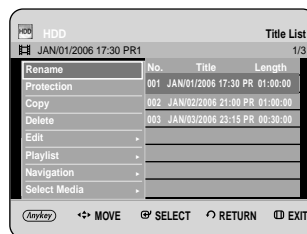

- Press the ▲▼ buttons to select **Navigation**, then press the **OK** or ► button.

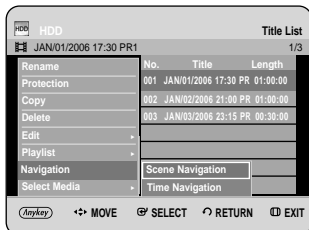

- Press the ▲▼ buttons to select **Scene Navigation**, then press the **OK** or ► button.

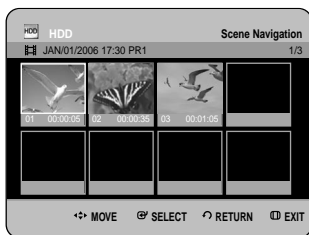

- Press the ▲▼◀▶ buttons to select desired scene, then press the **OK** or **PLAY** (⏪) button.

- Press the **OK** button.

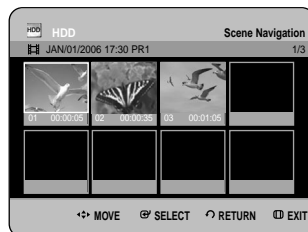

- Press the ▲▼◀▶ buttons to select desired scene, then press the **OK** or **PLAY** (⏪) button.



- Scene Navigation will not operate if a selected title does not have Markers.

NOTE

## Time Navigation



(VR mode)

Using this function, you can search scene minute-by-minute from the recorded title list.



### Using the TITLE LIST button

- With the unit in Stop mode/Playback mode, press the **TITLE LIST** button. The Title List screen is displayed.



### Using the MENU button.

- With the unit in Stop mode/Playback mode, press the **MENU** button.
- Press the ▲▼ buttons to select **Library**, then press the **OK** or ► button.
- Press the ▲▼ buttons to select **Title**, then press the **OK** or ► button.



### Using the ANYKEY button

- Press the **ANYKEY** button during playback.
- Press the ▲▼ buttons to select **Navigation**, then press the ◀▶ buttons to select **Scene**.



- Press the ▲▼ buttons to select an entry you want to play from Title List, then press the ANYKEY button.

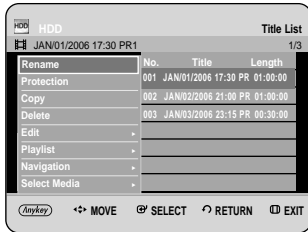

- Press the ▲▼ buttons to select **Navigation**, then press the OK or ► button.

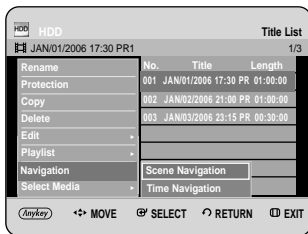

- Press the ▲▼ buttons to select **Time Navigation**, then press the OK or ► button.



- Press the ◀▶ buttons to skip one minute at a time and search the desired scene, then press the OK or PLAY (⏪) button.

## Using the ANYKEY button

- Press the ANYKEY button during playback.

- Press the ▲▼ buttons to select **Navigation**, then press the ◀▶ buttons to select **Time**.



- Press the OK button.



- Press the ◀▶ buttons to skip one minute at a time and search the desired scene, then press the OK or PLAY (⏪) button.



- Cursor does not move if the selected recorded title is shorter than 1 minute.
- The Navigation function may not work on a disc that has not been recorded by this device.
- An edited title may not display the exact search time.

# Using Markers

Set marks at scenes you want to see again so that you can start playback from the marked position.



## Using the MARKER button

- 1 Press the **MARKER** button during playback.

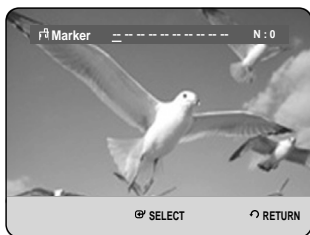

### Using the ANYKEY button.

- Press the **ANYKEY** button during playback.
- Press the **▲▼** buttons to select **Marker**, then press the **OK** or **▶** button.

- 2 Press the **OK** button when the desired scene appears.
  - The number **01** is displayed and the scene is memorized.

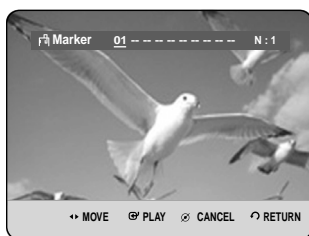

- 3 Press the **▶** buttons to move to the next position.

- 4 Press the **OK** button again when the desired scene appears.
  - The number **02** is displayed and the scene is memorized.



- HDD or DVD-RW (VR Mode) discs have the Marker function instead of the Bookmark function. Since the scenes may be displayed as many different pages, numbering is necessary. If a disc in use is encoded with Disc Protection or is a DVD-RAM disc, Markers cannot be set or deleted, only playback is available.

## Playing back a marker



## Using the MARKER button

- 1 Press the **MARKER** button during playback.

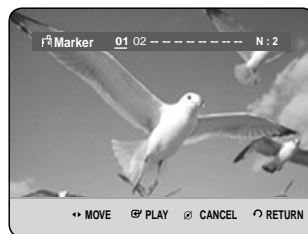

### Using the ANYKEY button.

- Press the **ANYKEY** button during playback.
- Press the **▲▼** buttons to select **Marker**, then press the **OK** or **▶** button.

2 Press the ◀▶ buttons to select a marked scene.

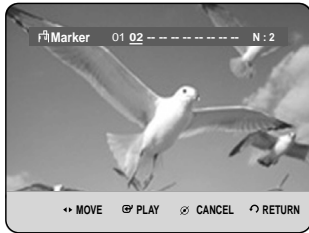

2 Press the ◀▶ buttons to select a marked scene.

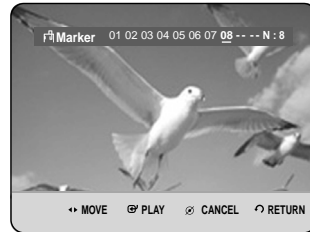

3 Press the **OK** or **PLAY** (▶) button to start playing from the selected scene.

- If you press the **SKIP** (◀) button, it moves to the beginning of the marker. Pressing the button once again within 3 seconds returns to the beginning of the previous marker.
- If you press the **SKIP** (▶) button, it moves to the next marker.

3 Press the **CANCEL** button to delete the selected mark.

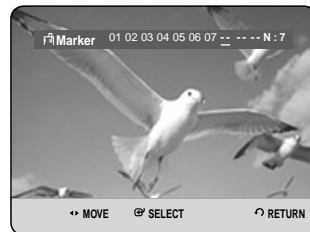

## Clearing a marker



### Using the **MARKER** button

1 Press the **MARKER** button during playback.

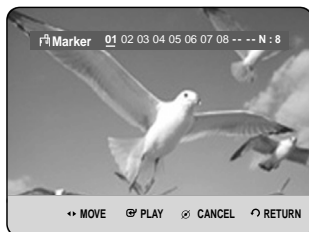

### Using the **ANYKEY** button.

- Press the **ANYKEY** button during playback.
- Press the ▲▼ buttons to select **Marker**, then press the **OK** or ▶ button.

- When a marker is cleared while HDD/ DVD-RW (VR mode) is playing, marker numbers will change. For example, if the 7th marker is cleared after ten markers are registered, the marker numbers after the eighth will automatically move ahead by one and the 8th marker becomes the 7th.

# Using the Bookmarks



## Using the MARKER button

**1** Press the **MARKER** button during playback.

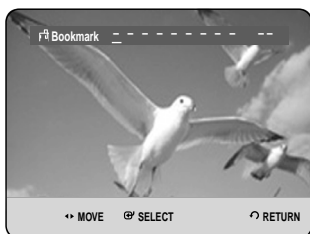

### Using the ANYKEY button.

- Press the **ANYKEY** button during playback.
- Press the **▲▼** buttons to select **Bookmark**, then press the **OK** or **▶** button.

**2** Press the **OK** button when the desired scene appears.

- The number **1** is displayed and the scene is memorized.

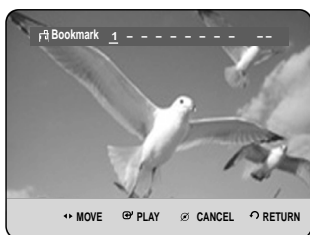

**3** Press the **▶** buttons to move to the next position.

**4** Press the **OK** button again when the desired scene appears.

The number **2** is displayed and the scene is memorized.

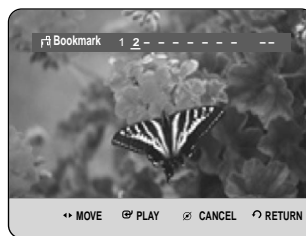

- Repeat above to bookmark other positions.
- You can bookmark up to 10 scenes.



NOTE

- When the disc tray is opened and then closed, bookmarks will disappear.

## Playing back a bookmark



### Using the MARKER button

**1** Press the **MARKER** button during playback.

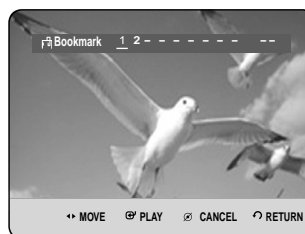

### Using the ANYKEY button.

- Press the **ANYKEY** button during playback.
- Press the **▲▼** buttons to select **Bookmark**, then press the **OK** or **▶** button.

**2** Press the **◀▶** buttons to select a bookmarked scene.

**3** Press the **OK** or **PLAY(⏪)** button to start playing from the selected scene.



## Clearing a bookmark



### Using the MARKER button

- 1 Press the **MARKER** button during playback.

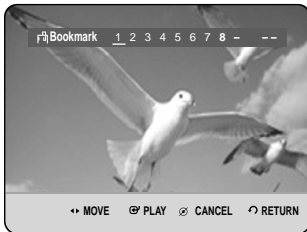

### Using the ANYKEY button.

- Press the **ANYKEY** button during playback.
- Press the **▲▼** buttons to select **Bookmark**, then press the **OK** or **▶** button.

- 2 Press the **◀▶** buttons to select a bookmarked scene.

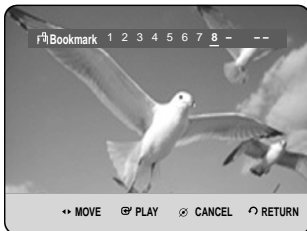

- 3 Press the **CANCEL** button to delete the selected bookmark.

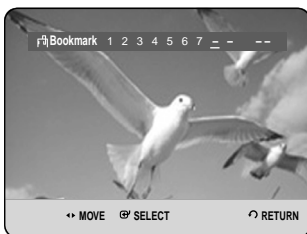

## Selecting the Subtitle Language

Selects one of the subtitle language recorded on the disc.



### Using the SUBTITLE button

- 1 Press the **SUBTITLE** button during playback.

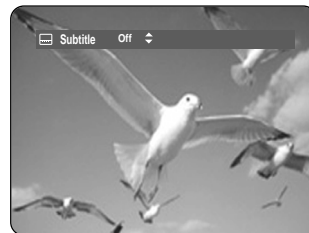

- 2 Press the **▲▼** buttons to select the desired subtitle language. Also, press the **SUBTITLE** button repeatedly to select the desired subtitle language.
  - To make the screen disappear, press the **CANCEL** or **RETURN** button.



## Using the ANYKEY button

- 1 Press the **ANYKEY** button during playback.
- 2 Press the **▲▼** buttons to select **Subtitle**.

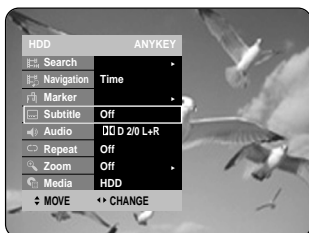

- 3 Press the **◀▶** buttons to select the desired subtitle language.



NOTE

- The subtitle display may be different depending on the disc type.
- Some discs allow you to select the language for the disc menu only.

# Selecting the Soundtracks & Audio Channels

## Selecting the Audio

Selects one of the soundtracks recorded on the disc. Also selects the audio channels from recorded TV programmes.



## Using the AUDIO button

- 1 Press the **AUDIO** button during playback.

HDD/DVD-RAM/RW

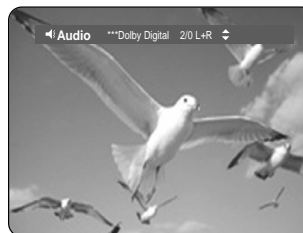

DVD-VIDEO

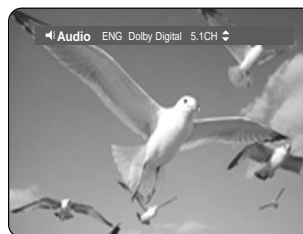

- 2 Press the **▲▼** buttons to select the desired soundtracks or audio channel. Also, press the **AUDIO** button repeatedly to select the desired soundtracks or audio channel.
  - To make the screen disappear, then press the **CANCEL** or **RETURN** button.

ANYKEY

## Using the ANYKEY button

**1** Press the **ANYKEY** button during playback.

**2** Press the **▲▼** buttons to select **Audio**.

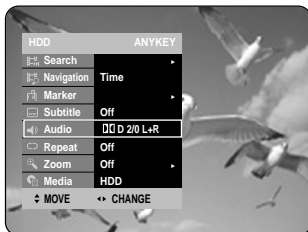

**3** Press the **◀▶** buttons to select the desired soundtracks or audio channel.



NOTE

- Soundtracks or Audio channel may be different because they are disc-specific.
- Some discs allow you to select the audio language for the disc menu only.

# Changing the Camera Angle

When a DVD VIDEO contains multiple angles of a particular scene, you can select the Angle function.



ANYKEY

## Using the ANYKEY button

**1** Press the **ANYKEY** button during playback.

**2** Press the **▲▼** buttons to select **Angle**.



**3** Press the **◀▶** buttons to select the desired angle.



NOTE

- This function is disc-dependent, and may not work on all DVDs.
- This function does not work when a DVD has not been recorded with a multi-camera angle system.
- Displays the current angle, total angle number.

# Repeat Play

## Playing Repeatedly(Repeat Playback)



### Using the REPEAT button

1 Press the **REPEAT** button during playback.

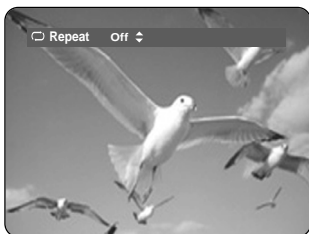

2 Press the **▲▼** buttons to select the **Off**, **Title** or **Chapter** you want to play repeatedly, then press the **OK** button.

### Using the ANYKEY button

1 Press the **ANYKEY** button during playback.

2 Press the **▲▼** buttons to select the **Repeat**.



3 Press the **◀▶** buttons to select **Repeat Off**, **Repeat A-B** or **Repeat Title** or **Repeat Chapter** you want to play repeatedly, then press the **OK** button.



NOTE

- HDD/DVD-RAM/-RW(VR mode), unfinalised DVD-R and unfinalised DVD-RW (V mode) discs will do not repeat a chapter.
- You can also activate Normal Playback by pressing the **CANCEL** button.

## Repeat A-B



ANYKEY

### Using the ANYKEY button

1 Press the **ANYKEY** button during playback.

2 Press the **▲▼** buttons to select **Repeat**.



3 Press the **◀▶** buttons to select **Repeat A-B**, then press the **OK** button.

- Press the **OK** button at the point where you want the repeat play to start (A) and press it again at the point where you want the repeat play to stop (B). Repeat playback of the A-B section starts.



### - To return to normal playback -

- Press the **CANCEL** button to return to normal playback.



NOTE

- If you set point (B) before five seconds of playback has lapsed, the prohibition mark (⊘) will appear.
- You can also activate Normal Playback by pressing the **CANCEL** button.
- Audio CDs (CD-DA), MP3 discs and MPEG4 discs do not support the Repeat A-B function.

## Zooming-In



- Press the **ANYKEY** button during playback.

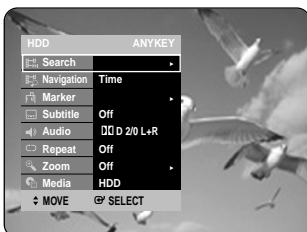

- Press the **▲▼** buttons to select **Zoom**, then press the **OK** or **▶** button. (⌕) will be displayed.



- Press **▲▼◀▶** buttons to move to the area you want to enlarge.

- Press the **OK** button. The screen will be enlarged to twice the normal size. The screen size will be enlarged to four times the normal size.

HDD/DVD-VIDEO/ DVD-RAM/RW/-R	normal size → x2 → x4 → x2 → normal size
---------------------------------	---



NOTE

- When the recording is done in EP mode, the zoom function is not supported except when the recording has been in V mode.

# Select Media



**1** Press the **ANYKEY** button during playback.

**2** Press the **▲▼** buttons to select **Media**.

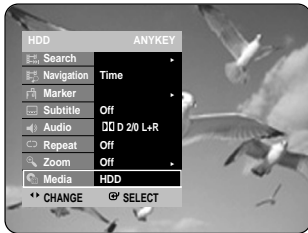

**3** Press the **◀▶** buttons to select **HDD**, **DVD** or **USB**, then press the **OK** button.



NOTE

- USB media will only appear when connect a USB cable.

# Playing an Audio CD/MP3

## Playing an Audio CD(CD-DA)

**1** Insert an audio CD (CD-DA) into the disc tray.

- The audio CD menu appears and the tracks (songs) are played automatically.

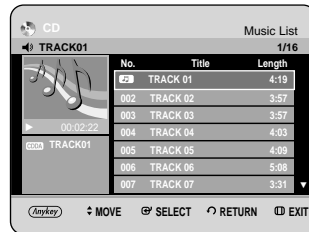

**2** Press the **▲▼** buttons to select the track (song) you want to hear, and then press the **OK** button.

## Audio CD(CD-DA) Screen Elements

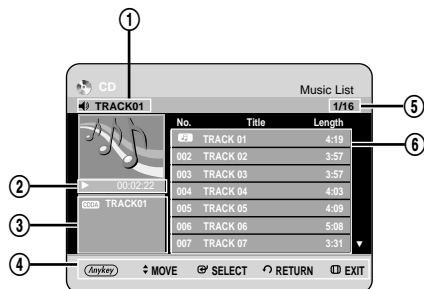

- 1. Current track (song):** Displays the number of the track currently being played.
- This shows the operating state of a disc and a playback time corresponding to a portion that is currently played.
- Displays the current file type and file name.
- Display available buttons.
- Displays the current play index, total track number.
- Displays the track list (song list).

## Buttons on the Remote Control used for Audio CD(CD-DA) playback



1. **▲▼**: Selects a track (song).
2. **OK button, Play (▶) button** : Plays the selected track (song).
3. **SKIP (⏮) button**: Plays the next track.
4. **SKIP (⏭) button**: Returns to the beginning of the current track when pressed during playback. If pressed again, your HDD & DVD RECORDER moves to and plays the previous track.  
If you press the this button within three seconds after playback starts, the previous track will be played.  
If you press the this button after three seconds, the current track will be replayed from the beginning.
5. **STEP (⏪ ⏩) buttons**: Move the page up/down.
6. **Press the SEARCH (🔍) buttons**:  
Fast Play (X2, X4, X8)
7. **STOP (⏹) button**: Stops a track(song).
8. **PLAY (▶) button**: Plays a track(song) or pauses playback.
9. **ANYKEY button**: The ANYKEY menu is displayed.

## Playing an MP3 Disc



1. Insert an MP3 disc into the disc tray.  
•The menu is displayed
2. Press the **▲▼** buttons to select **Library**, then press the **OK** or **▶** button.
3. Press the **▲▼** buttons to select **Music**, then press the **OK** or **▶** button.
4. Press the **▲▼** buttons to select the track you want to hear, and then press the **OK** button.

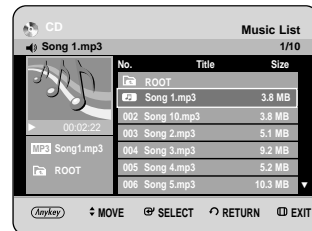

## MP3 Screen Elements

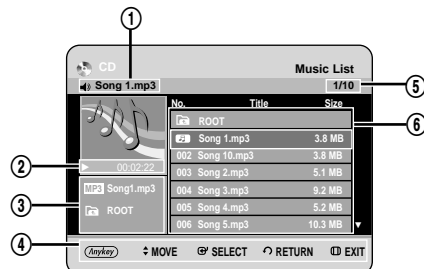

1. **Current track (song)**: Displays the name of the track being played.
2. This shows the operating state of a disc and a playback time corresponding to a portion that is currently played.
3. Displays the current filetype, file name and folder name.
4. Displays available buttons.
5. Displays the current play index, total track number.
6. Displays the track list (song list).

## Buttons on the Remote Control used for MP3 playback



1. **▲▼**: Selects a track (song).
2. **OK button, Play (▶) button**: Plays the selected track (song).
3. **SKIP (⏮) button**: Plays the next track.
4. **SKIP (⏭) button**: Returns to the beginning of the current track when pressed during playback. If pressed again, your HDD & DVD RECORDER moves to and plays the previous track.  
If you press the this button within three seconds after playback starts, the previous track will be played.  
If you press the this button after three seconds, the current track will be replayed from the beginning.
5. **STEP (⏪ ⏩) buttons**: Move the page up/down.
6. **STOP (⏹) button**: Stops a track(song).
7. **PLAY (▶) button**: Plays a track(song) or pauses playback.
8. **ANYKEY button**: The ANYKEY menu is displayed.

## Repeat CD (CD-DA) & MP3



Using the REPEAT button.

- 1 During playback, press the **REPEAT** button repeatedly to select the repeat mode you want.

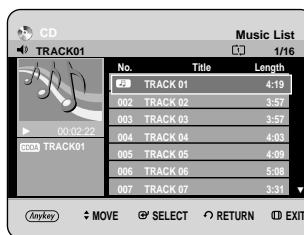

- **Normal (CD (CD-DA)/MP3)**: Tracks on a disc are played in the order in which they were recorded on the disc.
- **Repeat Track (CD (CD-DA)/MP3)**
- **Repeat Folder (MP3)**
- **Repeat All (CD (CD-DA)/MP3)**
- **Random (CD (CD-DA)/MP3)**: The random option plays a disc's track in random order.

- To return to normal playback -

- 2 Press the **REPEAT** or **CANCEL** button repeatedly to return to normal playback.



## Using the ANYKEY button

- 1 Press the **ANYKEY** button during the Music List playback.

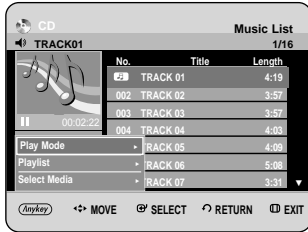

- 2 Press the **▲▼** buttons to select **Play Mode**, then press the **OK** or **▶** button.

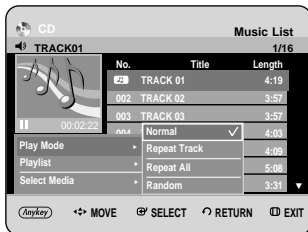

- 3 Press the **▲▼** buttons to select desired play mode, then press the **OK** or **▶** button.

- **Normal (CD (CD-DA)/MP3):** Tracks on a disc are played in the order in which they were recorded on the disc.
- **Repeat Track (CD (CD-DA)/MP3)**
- **Repeat Folder (MP3)**
- **Repeat All (CD (CD-DA)/MP3)**
- **Random (CD (CD-DA)/MP3):** The random option plays a disc's tracks in random order.

## New Playlist

You can register a maximum 28 tracks in the playlist.

- 1 Press the **ANYKEY** button during the Music List playback.

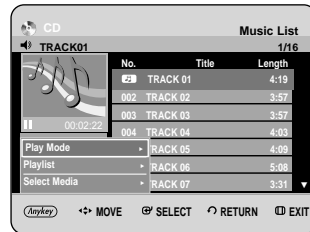

- 2 Press the **▲▼** buttons to select **Playlist**, then press the **OK** or **▶** button.

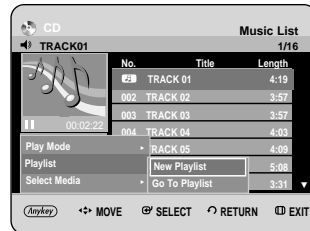

- 3 Press the **▲▼** buttons to select **New Playlist**, then press the **OK** or **▶** button.



- 4 Press the **▲▼** buttons to select tracks in the order in which you want them to play, then press the **OK** button.



- 5** If you playlisted a wrong track, press the ►▲▼ buttons to select the wrong track, then press the **OK** or **CANCEL** button. The wrong track will be removed.

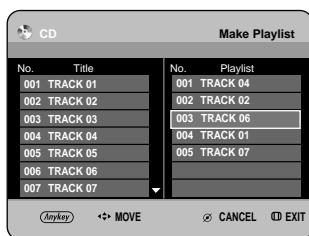

- 6** To store the Playlist, press the **ANYKEY** button.

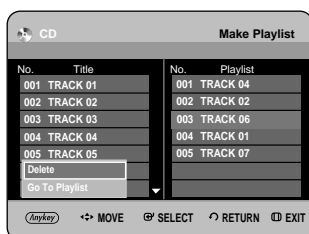

- 7** Press the ▲▼ buttons to select the **Go To Playlist**, then press the **OK** button. A new **Playlist** will be created.

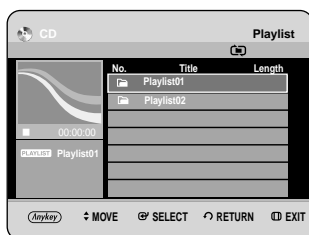

## Go To Playlist

- 1** Press the **ANYKEY** button during the Music List playback.

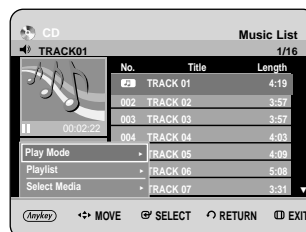

- 2** Press the ▲▼ buttons to select **Playlist**, then press the **OK** or ► button.

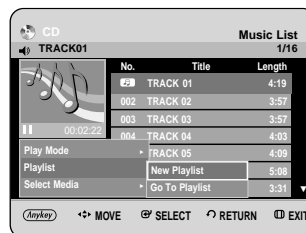

- 3** Press the ▲▼ buttons to select **Go To Playlist**, then press the **OK** or ► button.

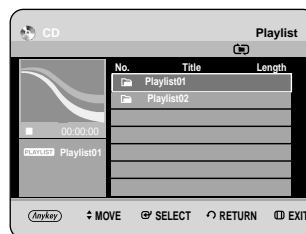

- 4** Press the ▲▼ buttons to select the desired playlist folder, then press the **OK** button. The selected tracks are played automatically.

## Delete the Playlist

- 1 Press the **ANYKEY** button during the Music List playback.

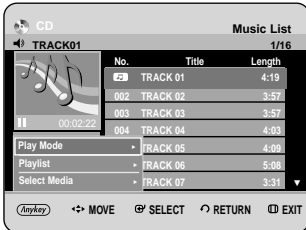

- 2 Press the **▲▼** buttons to select **Playlist**, then press the **OK** or **▶** button.

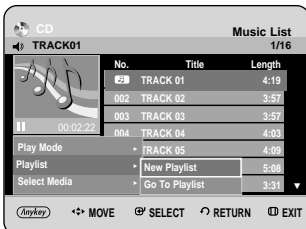

- 3 Press the **▲▼** buttons to select **Go To Playlist**, then press the **OK** or **▶** button.

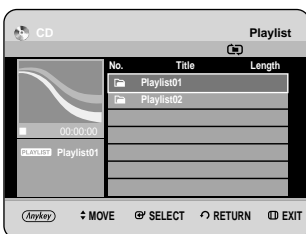

- 4 Press the **▲▼** buttons to select the Playlist you want to delete.

- 5 Press the **ANYKEY** button.



- 6 Press the **▲▼** buttons to select the **Delete Playlist**, then press the **OK** or **▶** button.

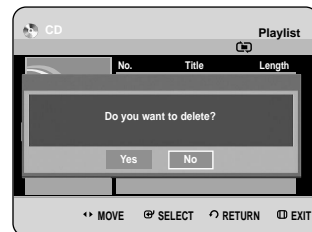

- 7 Press the **◀▶** buttons to select **Yes**, then press the **OK** button. The selected Playlist is deleted.

## Go To Edit Playlist

- 1 Press the **ANYKEY** button during the Music List playback.

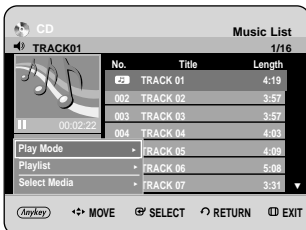

- 2 Press the ▲▼ buttons to select **Playlist**, then press the **OK** or ► button.

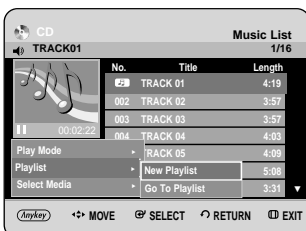

- 3 Press the ▲▼ buttons to select **Go To Playlist**, then press the **OK** or ► button.

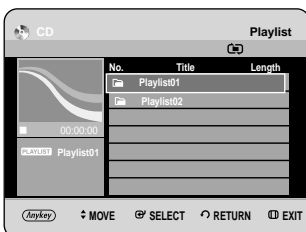

- 4 Press the ▲▼ buttons to select the Playlist you want to edit.

- 5 Press the **ANYKEY** button in playlist mode.



- 6 Press the ▲▼ buttons to select **Edit Playlist**, then press the **OK** or ► button.

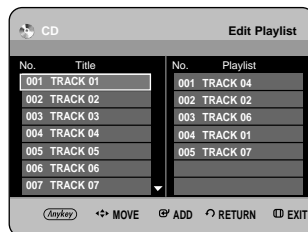

- 7 Press the ▲▼ buttons to select tracks in the order in which you want them to play, then press the **OK** button.

- 8 If you playlisted a wrong track, press the ►▲▼ buttons to select the wrong track, then press the **OK** or **CANCEL** button.

- 9 To store the Playlist, press the **ANYKEY** button.

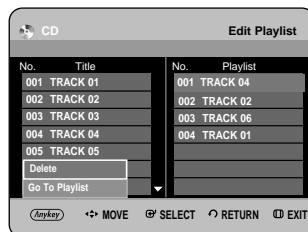

- 10 Press the ▲▼ buttons to select the **Go To Playlist**, then press the **OK** button. Playlist will be edited.

## Go To Music List

- 1 Press the **ANYKEY** button during the Playlist playback.



- 2 Press the **▲▼** buttons to select **Go To Music List**, then press the **OK** or **▶** button.

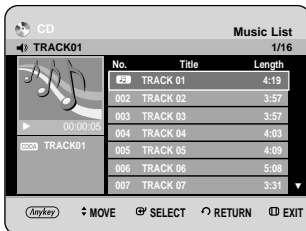

## Select Media

- 1 Press the **ANYKEY** button.

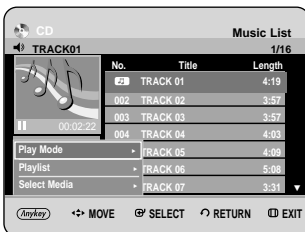

- 2 Press the **▲▼** buttons to select **Select Media**, then press the **OK** or **▶** button.

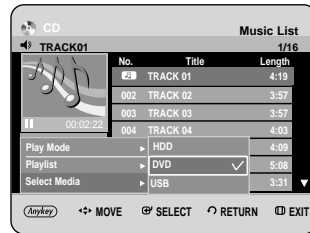

- 3 Press the **▲▼** buttons to select **HDD**, **DVD** or **USB**, then press the **OK** or **▶** button.

## Viewing a Picture



- 1 Insert a JPEG disc into the disc tray.
  - The menu is displayed
- 2 Press the **▲▼** buttons to select **Library**, then press the **OK** or **▶** button.



- 3** Press the ▲▼ buttons to select **Photo**, then press the **OK** or ► button.

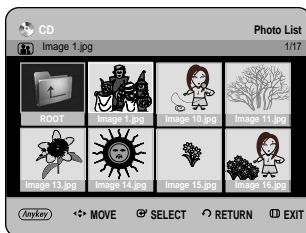

- 4** Press the ▲▼◀▶ buttons to select a picture.
- To see the next 8 pictures, press the **SKIP** (⏭) button.
  - To see the previous 8 pictures, press the **SKIP** (⏮) button.

## Slide Show

- 5** Press the **ANYKEY** button.

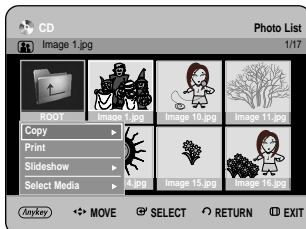

- 6** Press the ▲▼ buttons to select **Slideshow**, then press the **OK** or ► button.

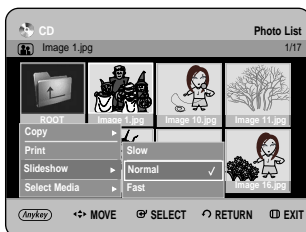

- 7** Press the ▲▼ buttons to select the slideshow speed, then press the **OK** or ► button. The slide show starts.

## - To stop the Slide Show -

- 1** Press the **ANYKEY** button.

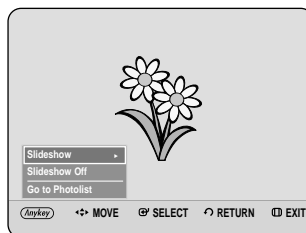

- 2** Press the ▲▼ buttons to select **Slideshow Off**, then press the **OK** or ► button.

## Rotate

To setup, follow steps 1 to 4 in pages 69~70.

- 5-1** Press the **OK** button to select the picture you want to see, then press the **ANYKEY** button.

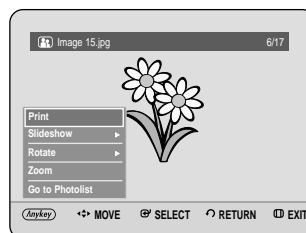

- 6** Press the ▲▼ buttons to select **Rotate**, then press the **OK** or ► button.

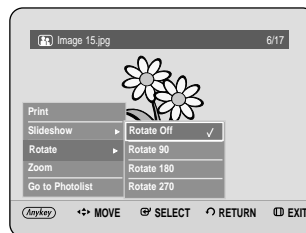

- 7** Press the ▲▼ buttons to select the rotate angle, then press the **OK** or ► button.

## - To stop the Rotate -

- 1 Press the **ANYKEY** button.

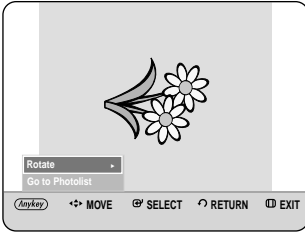

- 2 Press the **▲▼** buttons to select **Rotate**, then press the **OK** or **▶** button.

- 3 Press the **▲▼** buttons to select **Rotate Off**, then press the **OK** or **▶** button.

## Zoom

To setup, follow steps 1 to 4 in page 69~70.

- 5-1 Press the **OK** button to select the picture you want to see, then press the **ANYKEY** button.

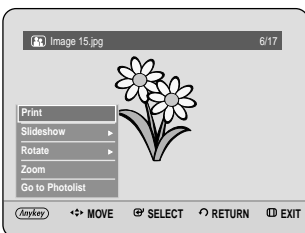

- 6 Press the **▲▼** buttons to select **Zoom**, then press the **OK** or **▶** button.

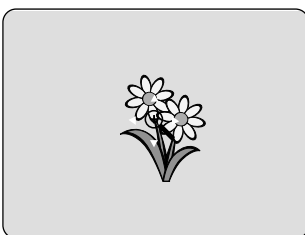

- 7 Each time the **OK** button is pressed, the picture is enlarged up to 4x(four times the normal size).

→ X2 → X4 → X2 → Normal

## - To stop the Zoom -

- 1 Press the **ANYKEY** button.

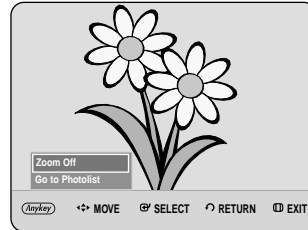

- 2 Press the **▲▼** buttons to select **Zoom Off**, then press the **OK** or **▶** button.

## Go To Photo List

To setup, follow steps 1 to 4 in page 69~70.

- 5-1 Press the **OK** button to select the picture you want to see, then press the **ANYKEY** button.

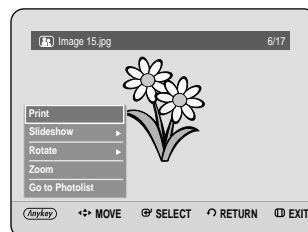

- 6 Press the **▲▼** buttons to select **Go to Photo list**, then press the **OK** or **▶** button.

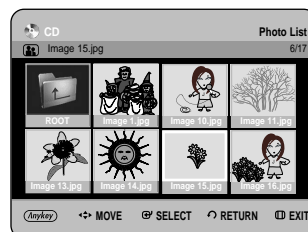

## Printing Photos

You can print your stored pictures without a PC. To printing, first connect the printer using a USB cable (See page 26), then check whether a printer is power on.

**1** Press the **ANYKEY** button in the Photo List.

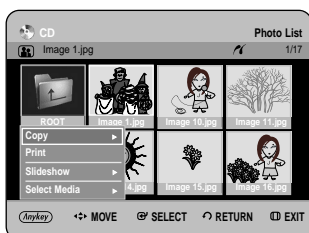

**2** Press the **▲▼** buttons to select **Print**, then press the **OK** or **▶** button. Print screen will be displayed.

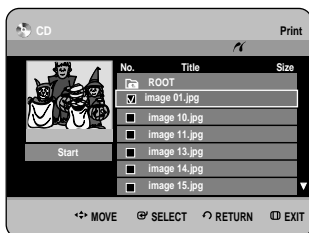

**3** Press the **▲▼** buttons to select the **JPEG** files you want to print, then press the **OK** or **▶** button until a checkmark appears.

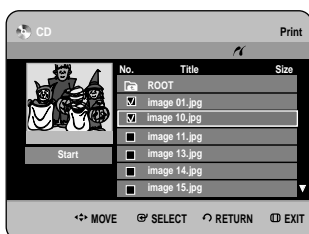

- If you don't want to print a certain one of the checked entries, simply select that entry and press **OK** or **▶** button to deselect it until a checkmark disappears.

**4** Press the **◀** buttons to select **Start**, then press the **OK** button to begin printing.

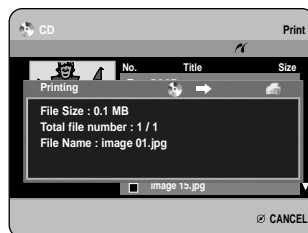
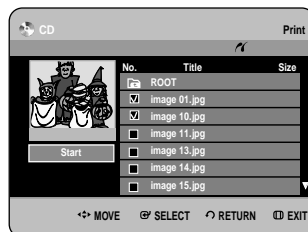

- To cancel Printing, press the **CANCEL** button.

**5** When finished, disconnect the USB cable.



Caution

- This function works only with printers that support PictBridge.



NOTE

- If you check some entries in the current folder and move to open a different folder, those entries are automatically unchecked and excluded from the selection list.
- For further details about printing photos, refer to the user's manual of the printer.
- Printing may not be performed depending on types of printers.



# Playing an MPEG4



## Using the MENU button

- 1 Insert a DivX disc into the disc tray.
  - The menu is displayed
- 2 Press the ▲▼ buttons to select **Library**, then press the **OK** or ► button.  
(In case of playing a DivX Disc, see number 4 on this page.)



- 3 Press the ▲▼ buttons to select **DivX(MPEG4)**, then press the **OK** or ► button.  
The DivX(MPEG4) screen is displayed.

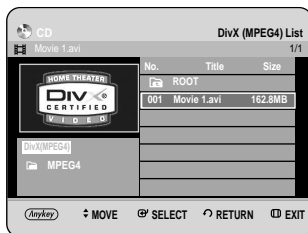

- 4 Press the ▲▼ buttons to select the avi file (DivX), then press the **OK** or **PLAY** (▶) button.

- 5 When MPEG4 file is played, you can use following functions. Pressing the **STOP** (■) button once during playback will display the file list, pressing the button again will exit the menu screen.

### MPEG4 Function Description

Function	Description
Skip	During play, press the <b>SKIP</b> (◀▶) buttons, it moves forward or backward 5 minutes.
Search	During play, press the <b>SEARCH</b> (⊖⊕) buttons and press again to search at a faster speed. (Fast 1, Fast 2, Fast 3)
Slow Motion Play	In pause or step mode, press the <b>SEARCH</b> (⊖) button on the remote control. (Slow1, Slow2, Slow3)
Step Motion Play	Press the <b>STEP</b> (⊖) button on the remote control in the still mode.



NOTE

- This unit can play the following video compression formats,
  - DivX Video (Codec) Format : DivX 3.11  
DivX 4.x DivX 5.x (without QPEL and GMC)
  - DivX Audio (Codec) Format : MP3, MPEG1 Audio Layer 2, Windows Media Audio, LPCM, AC3
- Supported subtitle file formats: .smi, .srt, .sub, .psb, .txt, .ass (The subtitle file should have exactly the same name to corresponding MPEG4 file name)
- Some MPEG4 files created on a personal computer may not be play back.  
Codec Type, Version and Higher resolution over specification are not supported.

# DivX Subtitle Encoding

1 Press the **ANYKEY** button in the file list.

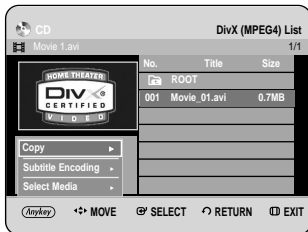

2 Press the **▲▼** buttons to select **Subtitle Encoding**, then press the **OK** or **▶** button.

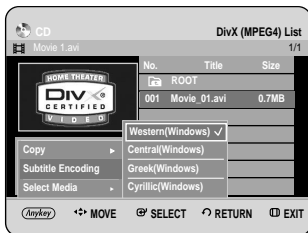

3 Press the **▲▼** buttons to select a supported DivX subtitle language by region, then press the **OK** button.

Western	Afrikaans, Basque, Catalan, Danish, Dutch, English, Faeroese, Finnish, French, German, Icelandic, Indonesian, Italian, Malay, Norwegian, Portuguese, Spanish, Swahili, Swedish
Central	English, Albanian, Croatian, Czech, Hungarian, Polish, Romanian, Serbian(Latin), Slovak, Slovenian
Greek	English, Greek
Cyrillic	English, Azeri, Belarusian, Bulgarian, Kazakh, Macedonian, Russian, Serbian, Tatar, Ukrainian, Uzbek



NOTE

- If the subtitle language is displayed in broken fonts, change DivX Subtitle to the appropriate region. If it still does not work, the format is not supported.

# Recording

This section shows various HDD & DVD Recording methods.

Before Recording .....	75
Recording the current TV programme you are watching .....	77
Recording from external equipment you are watching .....	79
Copying from a Camcorder .....	80
Making a One Touch Recording (OTR) .....	81
Simultaneous Recording and Playback .....	82
Making a Timer Recording .....	83
Editing the Scheduled List .....	85
Deleting a Scheduled List .....	86
Go To Recorded List .....	87

## Before Recording

This unit can record on various types of discs. Before recording, read the following instructions and select the disc type according to your preference.

### Recordable Discs

This HDD & DVD RECORDER can record on the following discs.

HDD	DVD-RW	DVD-R
		

- DVD-RWs are rewritable.
- DVD-Rs are non-rewritable

### Compatibility between Samsung and Other Company's Recorder

Disc Types	Recording format	Recording Device	Finalising	Additional Recording in Samsung Recorder
DVD-RW	VR Mode	Samsung	finalised	Not recordable
			not finalised	Recordable
		Other Company	finalised	Not recordable
			not finalised	Recordable
	V Mode	Samsung	finalised	Not recordable
			not finalised	Recordable
Other Company		finalised	Not recordable	
		not finalised	Not recordable	
DVD-R	V Mode	Samsung	finalised	Not recordable
			not finalised	Recordable
		Other Company	finalised	Not recordable
			not finalised	Not recordable



- Finalise
  - This closes the DVD-RW/-R so no additional recording can be done.
- Unfinalise
  - This allows additional recording on a DVD-RW disc originally recorded on the HDD & DVD RECORDER.
  - A DVD-RW disc that has been recorded by DAO(Disc At Once) in a PC cannot be unfinalised.
  - A DVD-RW disc that has been recorded in Video Mode of a different maker's recorder cannot be unfinalised.
  - A DVD-R disc cannot be unfinalised.

## Recording Formats

When you insert an unused disc, the following message appears. Since available functions differ depending on the disc type, select a disc that best fits your preferences.

**DVD-RW:** When unused DVD-RW disc is first inserted, the message "Uninitialized Disc. Do you want to initialize this disc?" will be displayed. If you select **Yes**, the disc will be formatted in VR mode.

If you want to change the mode, refer to Formatting a Disc on pages 115~116.

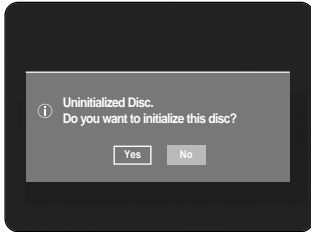

**DVD-R:** Formatting disc is unnecessary and only V Mode Recording is supported.

### DVD-RW(V mode)/-R

- Chapters will be created automatically when you finalise recording on DVD-RW/-R discs in V mode. The chapter's length (interval between chapters) varies according to the recording mode.
- Simple editing (erasing titles/changing title name)

### DVD-RW(VR mode)

- This mode allows multiple editing functions (such as deletion of the whole title, partial deletion of a title, etc.)
- Various editing options using a created Playlist.

## Recording Mode

Select one of four recording modes by pressing the **REC MODE** button repeatedly while the unit is in Stop mode for the desired recording time and picture quality. In general, picture quality improves as the recording time decreases. In FR mode, the most suitable record mode is adjusted automatically, according to remaining time on the disc and length of the timer recording. This function is selected only one mode in XP, SP, LP and EP modes and you can use this mode for timer recording.

### • DVD-HR733

Recording Mode	Recording Times	
	HDD (80GB)	DVD-RW/-R
XP (high quality mode)	Approx. 18 hours	Approx. 1 hour about 8.5 Mbps
SP (standard quality mode)	Approx. 33 hours	Approx. 2 hours about 4.5 Mbps
LP (long recording mode)	Approx. 64 hours	Approx. 4 hours about 2 Mbps
EP (extended mode)	Approx. 95 hours	Approx. 6 hours/ about 1.6 Mbps
	Approx. 127 hours	Approx. 8 hours/ about 1.2 Mbps
FR (Flexible Recording)	Approx. 18~95 hours	Approx. 1~6 hours

### • DVD-HR738

Recording Mode	Recording Times	
	HDD (250GB)	DVD-RW/-R
XP (high quality mode)	Approx. 61 hours	Approx. 1 hour about 8.5 Mbps
SP (standard quality mode)	Approx. 113 hours	Approx. 2 hours about 4.5 Mbps
LP (long recording mode)	Approx. 219 hours	Approx. 4 hours about 2 Mbps
EP (extended mode)	Approx. 324 hours	Approx. 6 hours/ about 1.6 Mbps
	Approx. 429 hours	Approx. 8 hours/ about 1.2 Mbps
FR (Flexible Recording)	Approx. 61~324 hours	Approx. 1~6 hours



NOTE

- Recording time may vary according to specific conditions.

## Unrecordable pictures

Video with copy protection cannot be recorded on this HDD & DVD RECORDER.

When the HDD & DVD RECORDER receives a copy-guard signal while recording, recording stops and the following message appears on the screen.

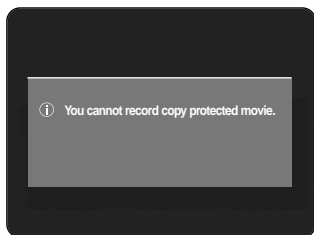

## Concerning Copy Control Signals

TV broadcasts that contain copy control signals may have one of the following three signal types, Copy-Free, Copy-Once and Copy-Never. If you want to record a copy-once type programme, use DVD-RW with CPRM in VR Mode.

Media \ Signal type	Copy-Free	Copy-Once	Copy-Never
DVD-RW(Ver.1.1)	○	-	-
DVD-RW(Ver.1.1) with CPRM			
VR mode	○	○*	-
V mode	○		-
DVD-R	○		-

Once "Copy Once" has been recorded, recording cannot be done anymore.

### - Content Protection for Recordable Media (CPRM)

CPRM is a mechanism that ties a recording to the media on which it is recorded. It is supported by some HDD & DVD RECORDERS, but not by many DVD players. Each blank recordable DVD has a unique 64-bit media ID etched in the BCA. When protected content is recorded onto the disc, it can be encrypted with a 56-bit C2 (Cryptomeria) cipher derived from the media ID.

During playback, the ID is read from the BCA and used to generate a key to decrypt the contents of the disc. If the contents of the disc are copied to other media, the ID will be absent or wrong and the data will not be decryptable.

## Recording the current TV programme you are watching



Check that the disc has enough available space for the recording. Adjust the recording mode.

- 1 Press the **HDD** or **DVD** button.  
If you select DVD, Press the **OPEN/CLOSE** button and place a recordable disc on the disc tray.  
Press the **OPEN/CLOSE** button to close the disc tray.  
Wait until **LOAD** disappears from the front panel display.

If an unused DVD-RW disc is used, whether to initialize or not will be asked first. Make your selection, then press the **OK** button.(See page 76)

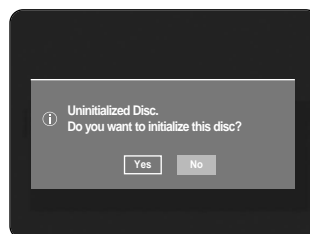

- 2 Press the **PROG** (⏪ ⏩) or number buttons to select the current programme you want to record.

- 3** Press the **REC MODE** button repeatedly, (or press the **REC MODE** button and then press the **▲▼** buttons) to select the recording speed(quality).

→ SP → LP → EP → XP

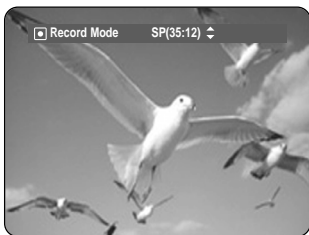

- 4** Press the **REC** button. Information concerning the channel is displayed on the screen, then recording begins. Icon(○) is displayed on the front panel.



#### - To pause recording -

- Press the **REC PAUSE** button to pause a recording in progress.
- Press the **REC PAUSE** button again during pause to resume recording.
- You can switch channels by pressing the **PROG** (☺ ☹) buttons while recording pauses.

#### - To stop recording -

Press the **STOP** (⊘) button to stop or finish a recording in progress.

- When using DVD-RW/R discs, the message "Updating the information of disc. Please wait for a moment" is displayed.



NOTE

- You can not change the recording mode and the **PROG** while recording.
- Recording will stop automatically if there is no free space left for recording.
- Up to 99 titles can be recorded onto a disc.(DVD-RW/R)
- Up to 999 titles can be registered on the HDD.
- HDD recording is available for up to 24 hours, and when recording for 24 hours, 4 titles will be recorded with each being 6 hours in length.
- Recording will stop automatically if a copy protected image is selected.
- DVD-RW discs must be formatted before starting to record. Most new discs are sold unformatted.
- Do not use DVD-R authoring discs with this unit.

# Recording from external equipment you are watching



## Before you start

Check that the disc has enough available space for the recording. Adjust the recording mode.

**1** Press the **HDD** or **DVD** button.  
If you select DVD, press the **OPEN/CLOSE** button and place a recordable disc on the disc tray. Press the **OPEN/CLOSE** button to close the disc tray. Wait until **LOAD** disappears from the front panel display. If an unused DVD-RW disc is used, whether to initialize or not will be asked first. (See page 76)

**2** Press the **INPUT SEL.** button to select the input source according to the connection you made. The front panel display changes in the following sequence:

→ PR Number → AV1 → AV2 → AV3 → DV

If you connect a digital camcorder, press the **INPUT SEL.** button to select **DV**. (See page 80)

**3** Press the **REC MODE** button repeatedly, (or press the **REC MODE** button, then press the **▲▼** buttons) to select the recording speed (quality).

→ SP → LP → EP → XP

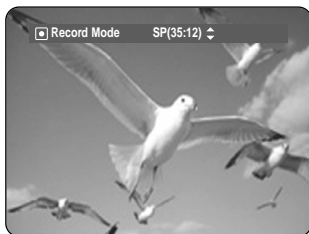

**4** Press the **REC** button.  
Information concerning the external input mode is displayed on the screen, then recording begins.  
Icon(○) is displayed on the front panel.

## - To pause recording -

- Press the **REC PAUSE** button to pause a recording in progress.
- Press the **REC PAUSE** button again during pause to resume recording.
- You can switch channels by pressing the **PROG** (⏪ ⏩) buttons while recording pauses.

## - To stop recording -

Press the **STOP** (⏹) button to stop or finish a recording in progress.

- When using DVD-RW/-R discs, the message "Updating the information of disc. Please wait for a moment" is displayed.

# Copying from a Camcorder

You may control the Camcorder using the IEEE1394 (DV) interface.



**1** Connect the DV output jack of your camcorder to the DV input jack on the front of your HDD & DVD RECORDER using a DV cable.

**2** Press the **HDD** or **DVD** button. If you select DVD, press the **OPEN/CLOSE** button and place a recordable disc on the disc tray. Press the **OPEN/CLOSE** button to close the disc tray. Wait until **LOAD** disappears from the front panel display.

**3** Press the **REC MODE** button repeatedly to select the recording speed(quality).

→ SP → LP → EP → XP

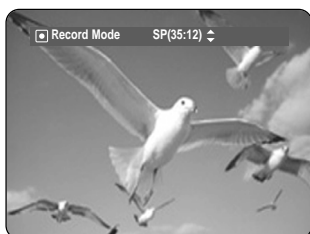

**4** Press the **INPUT SEL.** button to select **DV**. If the input is set to DV, a playback/record menu that enables camcorder control appears on the top of the screen.



**5** Select the Play (▶) icon on the upper part of the screen to playback the camcorder and find the starting position to copy.

**6** To start recording, use the ◀▶ buttons to select Record (●) icon in the top side of the screen, then press the **OK** button. You can press the **REC** button of the remote control to start recording.

## - To stop recording -

Press the **STOP** (⏹) button to stop or finish a recording in progress.

- When using DVD-RW/-R discs, the message "Updating the information of disc. Please wait for a moment" is displayed.



NOTE

- To display playback related icons on the screen, press any direction button on the remote control.



# Making a One Touch Recording (OTR)

You can set the HDD & DVD RECORDER to record in 30-minute increments up to 8 hours by pressing the **REC** button.



**1** Press the **HDD** or **DVD** button. If you select DVD, press the **OPEN/CLOSE** button and place a recordable disc on the disc tray. Press the **OPEN/CLOSE** button to close the disc tray. Wait until **LOAD** disappears from the front panel display.

**2** Press the **PROG** (☺☺) or number buttons to select the programme to record. If you want to record through a connected external component, press the **INPUT SEL.** button to select an appropriate external input (AV1, AV2, AV3, DV or PR01).

**3** Press the **REC** button to start recording.



**4** Press the **REC** button repeatedly to adjust the desired recording time.

→ 0:30 → 1:00 → ... 8:00 → Off

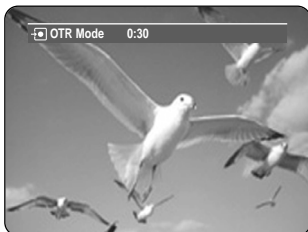

NOTE

- The timer counter decreases by the minute from 8:00 to 0:00, then the HDD & DVD RECORDER stops recording.

## - To stop recording -

Press the **STOP** (⊙) button. The message "Do you want to stop recording?" is displayed.

- Press the ◀▶ buttons to select **Yes**, then press the **OK** button.
- Or press the **STOP** (⊙) button again.

## About INFO button

During recording, press the **INFO** button once, the system information screen appears.: Displays Active Status, Background Status, and Main Screen information.



Pressing the **INFO** button twice, Disc information screen appears.: Displays Total numbers of Titles and Playlists, Recordable Time(Title), Available Space(Music/Photo).



Pressing the **INFO** button three times: Current recording information screen appears.: Displays information of recording Name, Title, Created Time and Recording Time.



# Simultaneous Recording and Playback

You can play back from the beginning of the programme you are currently recording.

You can watch the previous title list while recording a programme.



## While Recording

- 1 Press the **PLAY** (⏮) button. It plays back the title that you are currently recording from the beginning. Playback is not available for 10 seconds from the start of recording. You can use the **SKIP** (⏪) (⏩) and other playback-related buttons to view the previous recorded list.

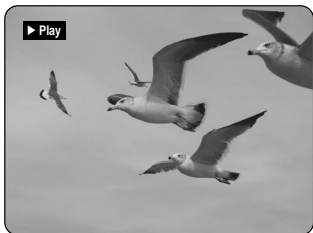

## Using the TITLE LIST button

- 1 With the unit in recording mode, press the **TITLE LIST** button. The Title List screen is displayed. Press the **▲▼/SKIP** (⏪) (⏩) buttons to select the recording title list.



- 2 Press the **OK** or **PLAY** (⏮) button. It plays back the title that you are currently recording from the beginning.

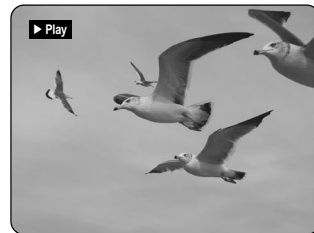

## - Stopping Playback / Recording -

- 1 Press the **STOP** (⏹) button. Playback screen disappears and the recording in progress screen appears.
- 2 Pressing the **STOP** (⏹) button once more will stop the recording.



- No sound is heard during search mode.
- DVD disc playback is available during HDD recording. However, JPEG, MP3, and DivX files in the disc cannot be played back.
- HDD playback is available during DVD recording. However, JPEG and MP3 files in the HDD cannot be played back.

# Making a Timer Recording



1. Check the antenna cable is connected.
  2. Check the remaining time of the disc.
  3. Check the date and time are correct.
- Make sure the Clock (Setup-Clock Set) must be set before you proceed with a timer recording. (See pages 29~30)



## Using the TIMER button

- 1 With the unit in Stop mode/Playback mode, press the **TIMER** button. The Programme screen is displayed.



### Using the MENU button.

- With the unit in Stop mode/Playback mode, press the **MENU** button.
- Press the **▲▼** buttons to select **Programme**, then press the **OK** or **▶** button.

- 2 Press the **OK** or **▶** button to select **Scheduled List**.

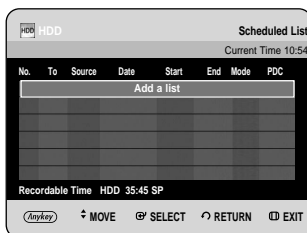

- 3 Press the **OK** button to select **Add a list**.

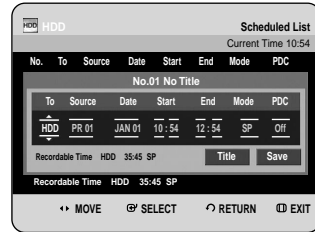

### Using the ANYKEY button.

- Press the **ANYKEY** button.
- Press the **▲▼** buttons to select **Add**, then press the **OK** or **▶** button.

- 4 Set timer recording option.
- Fill the input items using the **▲▼◀▶** buttons and number buttons.

- ◀▶ : Moves to the previous/next item.
- ▲▼, 0-9 : Sets a value.

- **To** : Select the media to record HDD or DVD.
- **Source** : The video input source (AV1, AV2 or AV3), or the broadcasting channel you want to make a timer recording from.
- **Date** : Timer Recording allows setting the recording time within one month period. Set the recording day. (month/day)

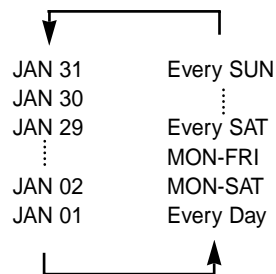

- **Start/End Time** : Start and end time of the timer recording.
- **Mode (Recording Mode)** :
  - FR (Flexible Recording) : Select when you want to set video quality automatically. In FR mode, the most suitable record mode is adjusted automatically, according to remaining time on the disc and length of the timer recording. This function is selected only one mode in XP, SP, LP and EP modes.
  - XP (high quality) : Select when video quality is important.
  - SP (standard quality) : Select to record in standard quality.
  - LP (low quality) : Select when a long recording time is required.
  - EP (extended) : Select when a longer recording time is required.



NOTE

- When you are recording at EP mode on a DVD-RW(V mode)/-R disc, it may not record the full 6 or 8 hours because the unit uses the VBR(Variable Bit Rate) ENCODING system. For example, if you record a programme with a lot of action, it uses a higher bit rate which in turn consumes more disc memory.

- **PDC** : PDC(Programme Delivery Control) function.

- If you set this function on, you can control the starting and ending time of recording by special signal included in the broadcasting signal. If a TV programme is shortened or starts earlier or later than scheduled, this function synchronizes the starting and ending time of recording with the actual broadcasting time automatically.
- Set up the start-time EXACTLY according to the published TV schedule. Otherwise the timer recording will not operate.
- Do not select PDC unless you are sure the programme you wish to record is broadcast with PDC.

- **TITLE** : To label the title name, select the title and then press the **OK** button. Title renaming screen appears. See page 90 for the registration.

- 
- 5** After selecting the set up value for each mode, press the **OK** button to select **Save**, and press the **OK** button again.

- will appear on the front panel. It means that a timer recording is registered.

**If the timer settings overlap;**

The programmes are recorded in order of priority. If timer recording is set for the first programme and then again for the second programme and both programmes overlap, the following message will appear on the screen: "This setting is identical with 1." The message shows that the first programme has priority. After recording of the first programme is complete, the second programme starts being recorded.

**To exit without saving the current setting**

Press the **MENU** button.

**To return to the previous menu**

Press the **RETURN** button if you don't want to set a timer recording.

- 
- 6** When you want to recording on DVD-RW/-R, you must insert the disc.

- 
- 7** Turn the power off to finish the Timer Recording setting.

Timer Recording will not work when the power is on.



NOTE

- The timer recording time may differ from the set time depending on disc status and overall timer recording status (for example, recording times overlapping, or when the previous recording ends within 2 minutes before the start time of the next recording.)
- You can make the Timer Recording up to 12 programmes.
- If HDD disk has no available recording space, blinks. It means that HDD disk has no space to record.

# Editing the Scheduled List

Follow these directions to edit the Scheduled List.



## Using the TIMER button

- 1 With the unit in Stop mode/Playback mode, press the **TIMER** button. The Programme screen is displayed.



## Using the MENU button.

- With the unit in Stop mode/Playback mode, press the **MENU** button.
- Press the **▲▼** buttons to select **Programme**, then press the **OK** or **▶** button.

- 2 Press the **OK** or **▶** button to select **Scheduled List**.

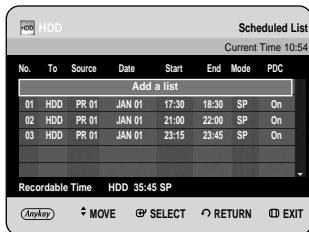

- 3 Press the **▲▼** buttons to select the number of the Scheduled List you want to edit, then press the **ANYKEY** button.
  - The **Add**, **Edit**, **Delete** and **Go to Recorded List** items is displayed.

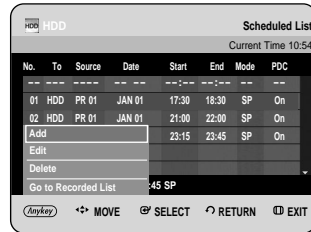

- 4 Press the **▲▼** buttons to select **Edit**, then press the **OK** or **▶** button.
  - The Scheduled Record Input item is displayed. Edit the items you want to modify. See the "Making a Timer Recording" section for more information on Timer Recording Input items. (See pages 83 to 84)

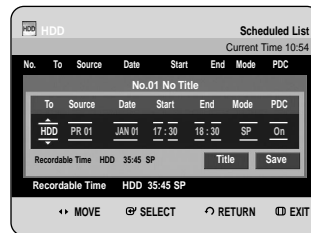

- 5 Press the **OK** button to select **Save**, then press the **OK** button to confirm the edited setting.

- 6 Press the **MENU** button after finishing the operation. The Scheduled List screen will disappear.

# Deleting a Scheduled List

Follow these directions to delete an entry from the Scheduled List.



## Using the TIMER button

- 1 With the unit in Stop mode/Playback mode, press the **TIMER** button. The Programme screen is displayed.



## Using the MENU button.

- With the unit in Stop mode/Playback mode, press the **MENU** button.
- Press the **▲▼** buttons to select **Programme**, then press the **OK** or **▶** button.

- 2 Press the **OK** or **▶** button to select **Scheduled List**.

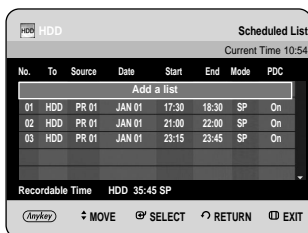

- 3 Press the **▲▼** buttons to select the number of the Scheduled List you want to delete, and then press the **ANYKEY** button.

- The **Add**, **Edit**, **Delete** and **Go to Recorded List** items are displayed.

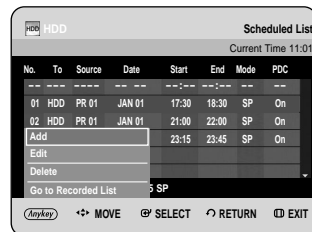

- 4 Press the **▲▼** buttons to select **Delete**, then press the **OK** or **▶** button.

- You will be prompted with the delete confirm message such as "Do you want to delete?".

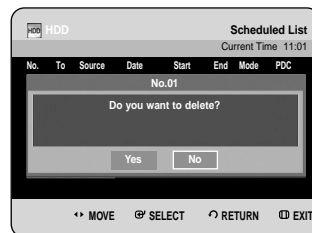

- 5 Press the **◀▶** buttons to select **Yes**, then press the **OK** button.

- The selected entry will be deleted from the list.

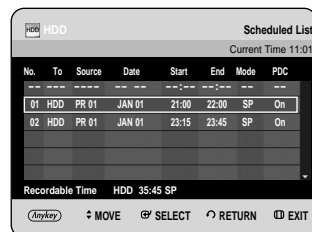

- 6 Press the **MENU** button after finishing the operation. The Scheduled List screen will disappear.

# Go To Recorded List

You can confirm the performance results of title lists that have passed the reserved recording time.



## Using the TIMER button

- 1 With the unit in Stop mode/Playback mode, press the **TIMER** button. The Programme screen is displayed.



### Using the MENU button.

- With the unit in Stop mode/Playback mode, press the **MENU** button.
- Press the **▲▼** buttons to select **Programme**, then press the **OK** or **▶** button.

- 2 Press the **▲▼** button to select **Recorded List**, then press the **OK** or **▶** button. The **Recorded List** screen is displayed.

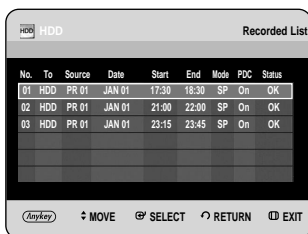

- 3 Press the **MENU** button after finishing the operation. The Recorded List screen will disappear.

## Information about Recorded List

Informs whether the selected Recorded List performed a Timer Recording successfully.

- 3-1 Press the **▲▼** buttons to select the number of the **Recorded List**, then press the **ANYKEY** button.

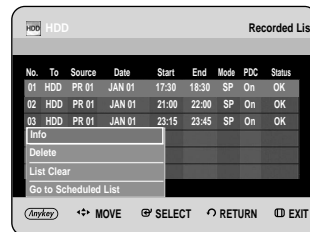

- 4 Press the **▲▼** buttons to select **Info**, then press the **OK** or **▶** button.



## Delete Recorded List

Deletes a Recorded List individually.

- 3**-1 Press the ▲▼ buttons to select the number of the **Recorded List** you want to delete, and then press the **ANYKEY** button.

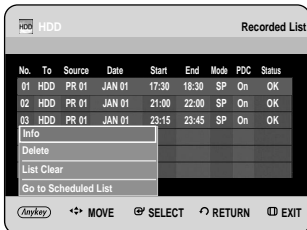

- 4** Press the ▲▼ buttons to select **Delete**, then press the **OK** or ► button.

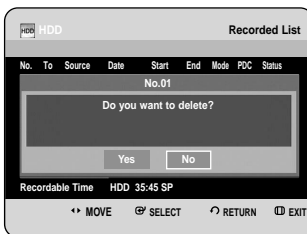

## Clear Recorded List

Clears all Recorded List at once.

- 3**-1 Press the **ANYKEY** button.

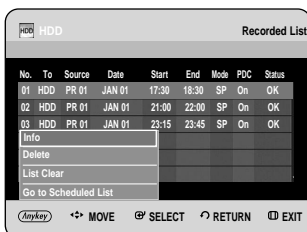

- 4** Press the ▲▼ buttons to select **List Clear**, then press the **OK** or ► button.



## Go to Scheduled List

Switches directly from the Recorded List to the Scheduled List.

- 3**-1 Press the **ANYKEY** button.

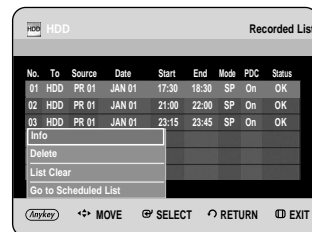

- 4** Press the ▲▼ buttons to select **Go to Scheduled List**, then press the **OK** or ► button.

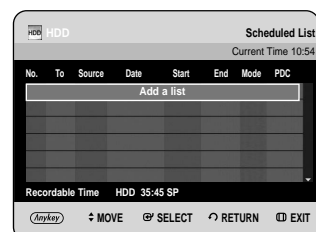





# Editing

This section introduces basic functions of editing and explains both edit functions for the recording on a disc and edit functions for the entire disc.

Basic Editing (Title List) . . . . .	.90
Advanced Editing (Playlist) . . . . .	.96
Copying Title List . . . . .	.105
Copying MP3, JPEG or DivX . . . . .	.110
Disc Manager . . . . .	.114

## • Title List

Title List is a list of previously recorded programmes. If a title is deleted, that title cannot be played again.

## • Play List

This refers to a unit of playback, which is made by selecting a desired scene in the entire Title List. When one playlist is played, only the scene selected by the user will play and then stop. Since only the information necessary for playing a desired scene is included in a playlist, even if that playlist is deleted, the original stream will not be deleted.

***Recording or editing might not be completed if an error, such as a sudden power failure occurs. Please be aware that a material that has been damaged is unable to be retrieved to its original content.***

# Basic Editing (Title List)

## Renaming(Labeling) a Title

Follow these instructions to rename a title list entry, i.e., to edit the title of a recorded programme.



### Using the TITLE LIST button

- 1 With the unit in Stop mode/Playback mode, press the **TITLE LIST** button. The Title List screen is displayed.

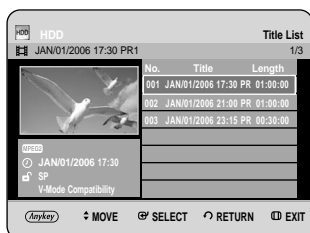

### Using the MENU button.

- With the unit in Stop mode/Playback mode, press the **MENU** button.
- Press the **▲▼** buttons to select **Library**, then press the **OK** or **▶** button.
- Press the **▲▼** buttons to select **Title**, then press the **OK** or **▶** button.

- 2 Press the **▲▼** buttons to select an entry you want to rename from the Title List, then press the **ANYKEY** button.

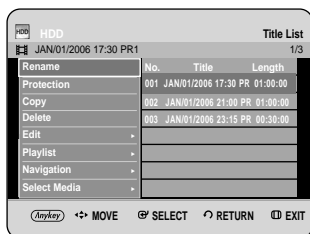

- 3 Press the **▲▼** buttons to select **Rename**, then press the **OK** or **▶** button. The Rename screen is displayed.



- 4 Select the desired characters using the **▲▼◀▶** buttons, press the **OK** button.



- **Back Space:** Deletes and moves the cursor backwards by one position.
- **Space:** Enters a blank and moves the cursor one forward (to the right).
- **Delete:** Deletes the character at the cursor position.
- **Clear:** Deletes all the character inputs.
- **Save:** Registers the character inputs.

- 5 Press the **▲▼◀▶** buttons to select **Save**, and then press the **OK** button. The changed title name is displayed on the title item of the selected entry.



## Locking (Protecting) a Title

Follow these instructions to lock an entry to protect it from accidental deletion.



### Using the TITLE LIST button

- 1 With the unit in Stop mode/Playback mode, press the **TITLE LIST** button .  
The Title List screen is displayed.



### Using the MENU button.

- With the unit in Stop mode/Playback mode, press the **MENU** button.
- Press the **▲▼** buttons to select **Library**, then press the **OK** or **▶** button.
- Press the **▲▼** buttons to select **Title**, then press the **OK** or **▶** button.

- 2 Press the **ANYKEY** button.

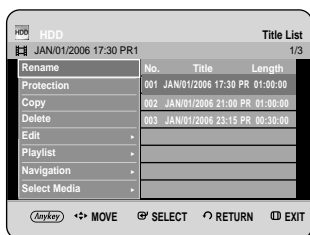

- 3 Press the **▲▼** buttons to select **Protection**, then press the **OK** or **▶** button.

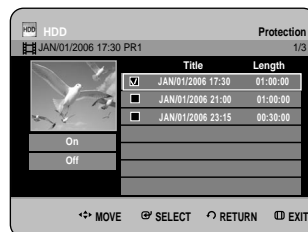

- 4 Press the **▲▼** buttons to select the additional entry you want to protect, then press the **OK** or **▶** button until a checkmark appears.

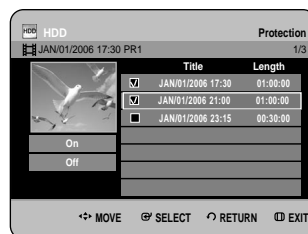

- If you don't want to protect a certain one of the checked entries, simply select that entry and press **OK** or **▶** button to deselect it until a checkmark disappears.

- 5 Press the **◀** button to select **On**, then press the **OK** button. The key icon on the information window for the selected entry changes to the locked status. ( **🔒** → **🔒** )

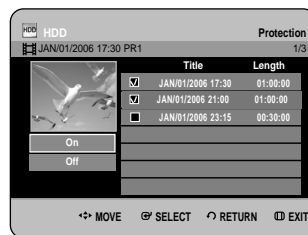

## Deleting a Title

Follow these instructions to delete an entry from the Title List.



### Using the TITLE LIST button

- 1 With the unit in Stop mode/Playback mode, press the **TITLE LIST** button.  
The Title List screen is displayed.

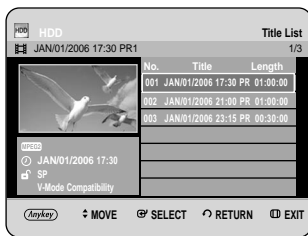

### Using the MENU button.

- With the unit in Stop mode/Playback mode, press the **MENU** button.
- Press the **▲▼** buttons to select **Library**, then press the **OK** or **▶** button.
- Press the **▲▼** buttons to select **Title**, then press the **OK** or **▶** button.

- 2 Press the **ANYKEY** button.

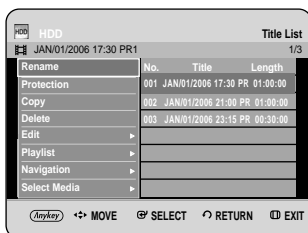

- 3 Press the **▲▼** buttons to select **Delete**, then press the **OK** or **▶** button.

Delete screen will be displayed.

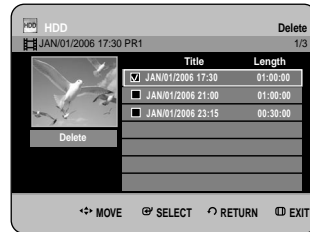

- 4 Press the **▲▼** buttons to select the additional entry you want to delete, then press the **OK** or **▶** button until a checkmark appears.

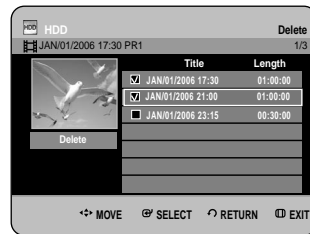

- If you don't want to delete a certain one of the checked entries, simply select that entry and press **OK** or **▶** button to deselect it until a checkmark disappears.

- 5 Press the **◀** button to select **Delete**, then press the **OK** button.

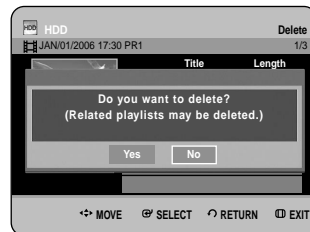

- The message may be different depending on the type of disc. You will be prompted with the confirmation message. HDD, DVD-RW(VR mode): If a Playlist is present, the message "Do you want to delete? (Related playlists may be deleted.)" is displayed. DVD-RW(Video mode)/-R: If a Playlist is not present, the message "Do you want to delete?" is displayed.

- 6** Press the ◀▶ buttons to select **Yes**, then press the **OK** button.

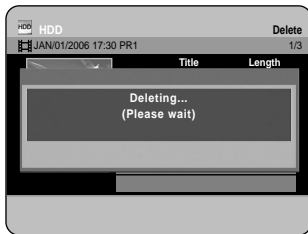

- You cannot delete a protected entry. If you want to delete a protected entry, select "Off" in the Title Protection menu. (See page 91)
- When the Disc Protection has been set to Protected, you cannot delete titles. (See page 115)
- Once an entry is deleted from the Title List it cannot be recovered.
- Once DVD-RW/-R is finalised, it cannot be deleted.

## Splitting a Section of a Title (Split)

Follow these instructions to split a section of a Title List entry into two titles.



### Using the TITLE LIST button

- 1** With the unit in Stop mode/Playback mode, press the **TITLE LIST** button. The Title List screen is displayed.

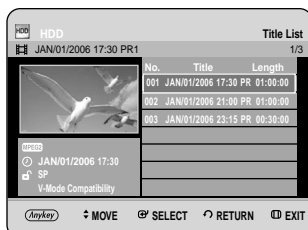

### Using the MENU button.

- With the unit in Stop mode/Playback mode, press the **MENU** button.
- Press the ▲▼ buttons to select **Library**, then press the **OK** or ▶ button.
- Press the ▲▼ buttons to select **Title**, then press the **OK** or ▶ button.

- 2** Press the ▲▼ buttons to select an entry you want to Split from the Title List, then press the **ANYKEY** button.

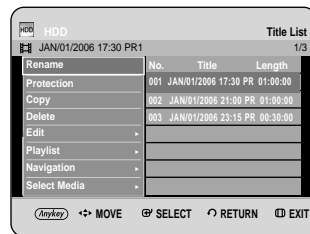

- 3** Press the ▲▼ buttons to select **Edit**, then press the **OK** or ▶ button. The Edit menu is displayed.

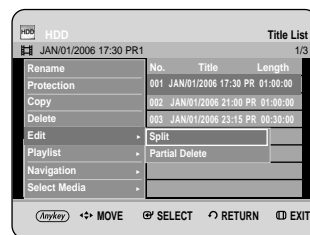

- 4** Press the ▲▼ buttons to select **Split**, then press the **OK** or ▶ button.



- 5** Using the playback-related buttons (**PLAY**(⏪), **SEARCH**(⏪⏩)), move to a point for splitting and press the **OK** button. If it is not the point where you want to split, press the **RETURN** button to cancel the selection. Using the playback-related buttons, move to a point to split and press the **OK** button.

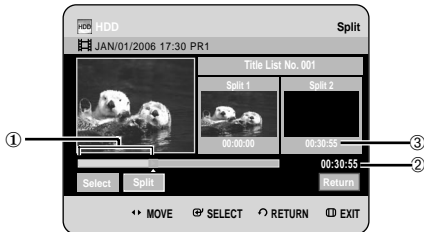

- ① First split interval
- ② Current playtime
- ③ Start time of the second split and its screen



- 6** Press the **OK** button to select **Split**. The message "This title cannot be recovered after splitting. Do you want to split?" is displayed.

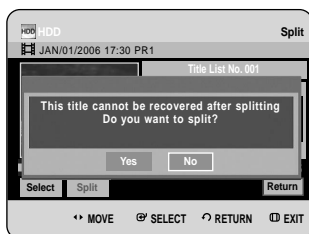

- 7** Press the ◀▶ buttons to select **Yes**, then press the **OK** button. The split title is divided into two, and the following titles will be shifted down by one.

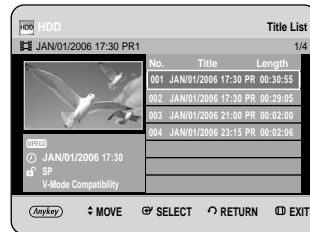

## Deleting a Section of a Title (Partial Delete)

Follow these instructions to delete a section of a Title List entry.



(VR mode)



### Using the TITLE LIST button

- 1** With the unit in Stop mode/Playback mode, press the **TITLE LIST** button. The Title List screen is displayed.

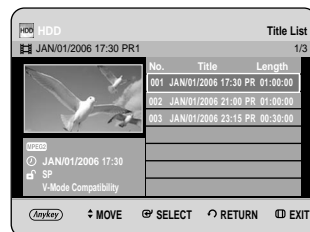

### Using the MENU button.

- With the unit in Stop mode/Playback mode, press the **MENU** button.
- Press the ▲▼ buttons to select **Library**, then press the **OK** or ▶ button.
- Press the ▲▼ buttons to select **Title**, then press the **OK** or ▶ button.

- 2** Press the ▲▼ buttons to select an entry you want to edit from the Title List, then press the **ANYKEY** button.

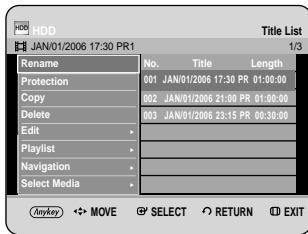

- When using a DVD-RW(VR) disc, you can select Partial Delete directly by pressing the **ANYKEY** button. (Then go to step 5)

- 3** Press the ▲▼ buttons to select **Edit**, then press the **OK** or ► button.  
The Edit Title List screen is displayed.

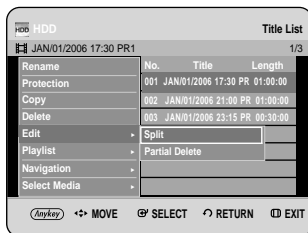

- 4** Press the ▲▼ buttons to select **Partial Delete**, then press the **OK** or ► button.



- 5** Press the **OK** button at the starting point.  
The image and starting point time is displayed in the section deletion starting point window.



## Partial Delete List Screen Elements

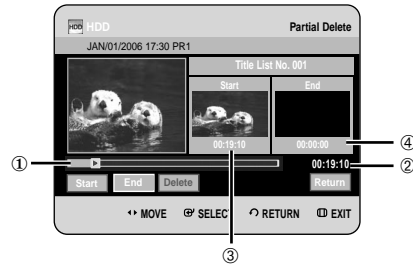

- ① Playback bar
- ② Playtime
- ③ Section deletion starting point window and time
- ④ Section deletion end point window and time
  - Select the start and end points of the section you want to delete using the playback related buttons.
  - Playback related buttons :  
(PLAY (▶), SEARCH (◀▶))

- 6** Press the **OK** button at the end point.  
The image and end point time is displayed in the Section deletion ending point window.



- 7** Press the ◀▶ buttons to select **Delete**, then Press the **OK** button.

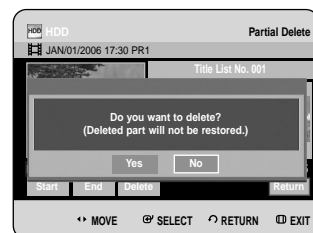

**8** Press the ◀▶ buttons to select **Yes**, then press the **OK** button. The selected section has been deleted.

**9** Press the ◀▶ buttons to select **Return**, then press the **OK** button to finish the operation.



NOTE

- The length of the section to be deleted must be at least 5 seconds long.
- If the length of the section to be deleted is less than 5 seconds, you will be prompted with the message "The range is too short."
- If the end time precedes the starting time, you will be prompted with the message "End point cannot be marked earlier than start point".
- The section cannot be deleted when it includes a still picture.
- Press the **MENU** button after the operation has finished. The Title List screen will disappear.

## Advanced Editing (Playlist)

### Creating a Playlist

Follow these instructions to create a new playlist entry from a recorded title.



(VR mode)



### Using the TITLE LIST button

- 1** With the unit in Stop mode/Playback mode, press the **TITLE LIST** button. The Title List screen is displayed.

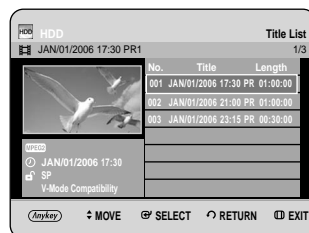

### Using the MENU button.

- With the unit in Stop mode/Playback mode, press the **MENU** button.
- Press the ▲▼ buttons to select **Library**, then press the **OK** or ▶ button.
- Press the ▲▼ buttons to select **Title**, then press the **OK** or ▶ button.

- 2** Press the **ANYKEY** button. Press the ▲▼ buttons to select **Playlist**, then press the **OK** or ▶ button.





- 3** Press the ▲▼ buttons to select **New Playlist**, then press the **OK** or ► button. The Make Playlist screen is displayed.



- 4** Press the **OK** button at the start point.



- The image and time at the start point is displayed on the Start window.
- The yellow-coloured selection bar moves to the End item.
- Select the starting point of the section from which you want to create a new scene using the playback related buttons (**PLAY**(▶), **SEARCH**(◀▶)).

- 5** Press the **OK** button at the end point.



- The image and end point time is displayed in the End window.
- The yellow-coloured selection bar moves to the Make item.

- 6** Press the ◀▶ buttons to select **Make**, then press the **OK** button.
- To make a scene for the playlist. A new Make scene screen is displayed. Repeat steps 4–6 to make a new scene for the playlist. A new scene will be added to the current playlist. You can check and see all the scenes on the Edit playlist screen. (See page 99)
  - To make a new playlist. Repeat steps 1–6 if you want to make a new playlist.

- 7** Press the ◀▶ button to select **Return**, then press the **OK** button to finish the operation.



NOTE

- You can create up to 99 playlist entries.
- Depending on the kind of disc, the displayed screen may have a slight difference.

## Playing Entries in the Playlist

Follow these instructions to play the playlist entries.



(VR mode)



### Using the PLAY LIST button

- 1 With the unit in Stop mode/Playback mode, press the **PLAY LIST** button.  
The Playlist screen is displayed.

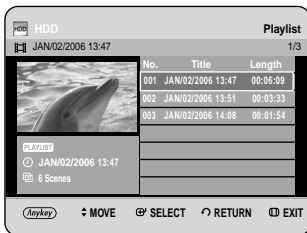

#### Using the MENU button.

- With the unit in Stop mode/Playback mode, press the **MENU** button.
- Press the **▲▼** buttons to select **Library**, then press the **OK** or **▶** button.
- Press the **▲▼** buttons to select **Title**, then press the **OK** or **▶** button.  
The Title List screen is displayed.
- Press the **ANYKEY** button.
- Press the **▲▼** buttons to select **Playlist**, then press the **OK** or **▶** button.
- Press the **▲▼** buttons to select **Go To Playlist**, then press the **OK** or **▶** button.

- 2 Press the **▲▼** buttons to select the playlist you want to play, then press the **OK** or **PLAY (⊕)** button.

- 3 Press the **STOP (⊖)** button to stop playing.  
The screen returns to the Playlist screen.

## Renaming a Playlist Entry

Follow these instructions to rename a playlist entry, i.e. to edit the title of a playlist entry.



(VR mode)



### Using the PLAY LIST button

- 1 With the unit in Stop mode/Playback mode, press the **PLAY LIST** button.  
The Edit Playlist screen is displayed.

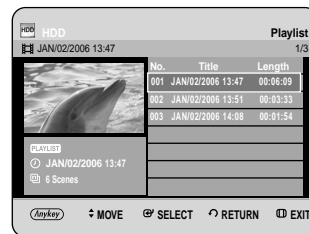

#### Using the MENU button.

- With the unit in Stop mode/Playback mode, press the **MENU** button.
- Press the **▲▼** buttons to select **Library**, then press the **OK** or **▶** button.
- Press the **▲▼** buttons to select **Title**, then press the **OK** or **▶** button.  
The Title List screen is displayed.
- Press the **ANYKEY** button.
- Press the **▲▼** buttons to select **Playlist**, then press the **OK** or **▶** button.
- Press the **▲▼** buttons to select **Go To Playlist**, then press the **OK** or **▶** button.

- 2 Press the **▲▼** buttons to select the title you want to Rename from the Playlist, then press the **ANYKEY** button.  
ANYKEY menu is displayed : **Rename**, **Copy**, **Delete**, **Edit Playlist**, **New Playlist**, **Go to Titlelist**.



- 3** Press the ▲▼ buttons to select **Rename**, then press the **OK** or ► button.  
The Rename screen is displayed.

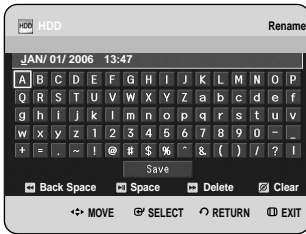

- 4** Select the desired characters using the ▲▼◀▶ buttons, then press the **OK** button.



- This function is the same as the Rename function in Renaming the Title. (See page 90)
- The maximum number of characters that can be entered is 31. All 31 characters can be displayed by pressing the **INFO** button.

- 5** Press the ▲▼◀▶ buttons to select **Save**, then press the **OK** button.  
The changed title is displayed in the title field of the selected playlist entry.

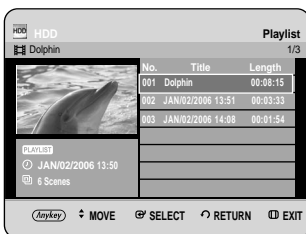

## Editing a Scene for the Playlist

Follow these instructions to edit scenes for a playlist.



### Using the PLAY LIST button

- 1** With the unit in Stop mode/Playback mode, press the **PLAY LIST** button.  
The Edit Playlist screen is displayed.

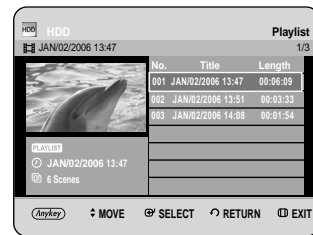

### Using the MENU button.

- With the unit in Stop mode/Playback mode, press the **MENU** button.
- Press the ▲▼ buttons to select **Library**, then press the **OK** or ► button.
- Press the ▲▼ buttons to select **Title**, then press the **OK** or ► button.
- Press the **ANYKEY** button.
- Press the ▲▼ buttons to select **Playlist**, then press the **OK** or ► button.
- Press the ▲▼ buttons to select **Go To Playlist**, then press the **OK** or ► button.

- 2** Press the ▲▼ buttons to select the title you want to edit from the Playlist, then press the **ANYKEY** button.  
The Edit Playlist menu is displayed: **Rename**, **Copy**, **Delete**, **Edit Playlist**, **New Playlist**, **Go to Titlelist**.



- 3** Press the ▲▼ buttons to select **Edit Playlist**, then press the **OK** or ► button.  
The Edit Scene screen is displayed.

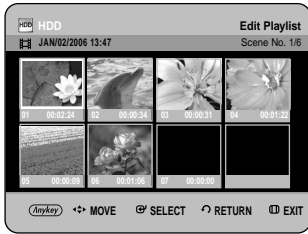

### Playing a Selected Scene

- 4** Press the ▲▼◀▶ buttons to select the scene you want to play, then press the **ANYKEY** button.  
The playlist entry to be played is selected.

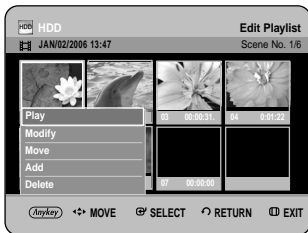

- 5** Press the ▲▼ buttons to select **Play**, then press the **OK** or ► button.  
The selected scene is played.

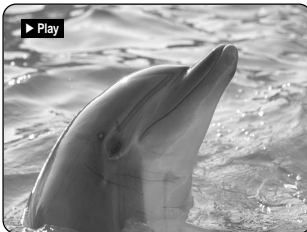

- To stop scene play, press the **STOP** (⊙) button.

### Modifying a Scene (Replacing a Scene)

To setup, follow steps 1 to 3 in page 99~100.

- 4** Press the ▲▼◀▶ buttons to select the scene you want to Modify, then press the **ANYKEY** button.

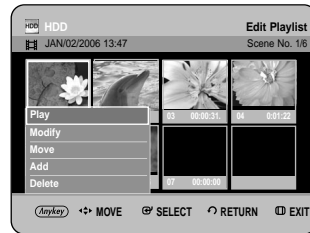

- 5** Press the ▲▼ buttons to select **Modify**, then press the **OK** or ► button.  
The Modify Scene screen is displayed.

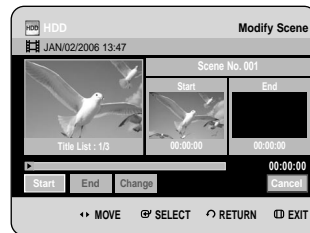

- 6** Press the **OK** button at the start point of the scene.

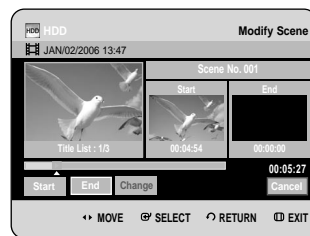

- The image and starting point time is displayed on the Start window.
- Select the starting or ending point of the section you want to modify using the playback related buttons (**PLAY**(▶), **SEARCH**(⊖ ⊕)).

- 7 Press the **OK** button at the end point of the scene.

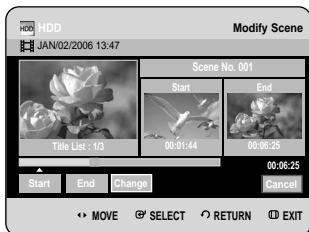

- The image and ending point time is displayed in the End window.

- 8 Press the **◀▶** buttons to select **Change**, then press the **OK** button.

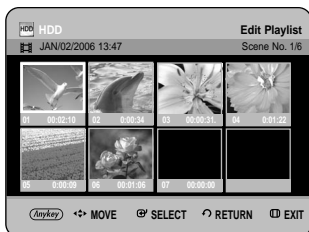

- The scene you want to modify is changed with the selected section.

## Moving a Scene (Changing the Position of a Scene)

To setup, follow steps 1 to 3 in page 99~100.

- 4-1 Press the **▲▼◀▶** buttons to select the scene you want to move (change the position), then press the **ANYKEY** button.

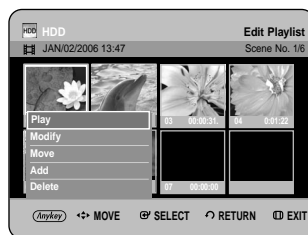

- 5 Press the **▲▼** buttons to select **Move**, then press the **OK** or **▶** button.

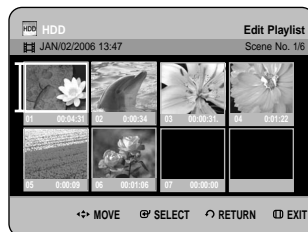

- A yellow selection window is displayed on the scene to be moved.

- 6** Press the **▲▼◀▶** buttons to select the position to which you want to move the selected scene, then select the **OK** button.

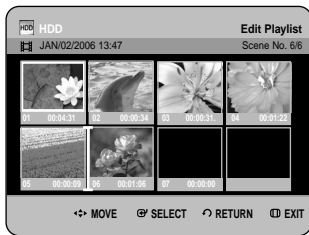

- The selected scene is moved to the selected position.

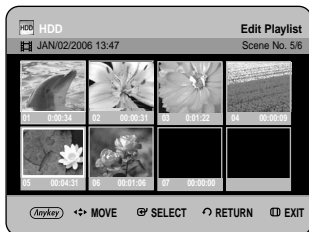

NOTE

- You cannot move the selected scene to the position of the next scene, because the selected scene should be inserted before that position, which requires no action.
- Depending on the kind of disc, the displayed screen may have a slight difference.

## Adding a Scene

To setup, follow steps 1 to 3 in page 99~100.

- 4-1** Press the **▲▼◀▶** buttons to select the scene that will have a new scene inserted before it, then press the **ANYKEY** button.

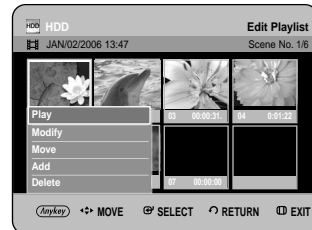

- 5** Press the **▲▼** buttons to select **Add**, then press the **OK** or **▶** button. The Add Scene screen is displayed.

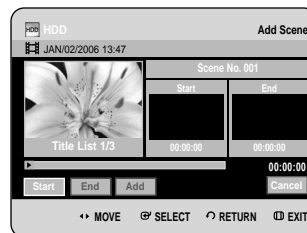

- 6** Press the **OK** button at the starting point of the scene.



- The image and starting point time is displayed on the Start window.
- Select the starting or ending point of the section you want to modify using the playback related buttons (**PLAY**(▶), **SKIP**(◀▶)).

**7** Press the **OK** button at the end point of the scene.

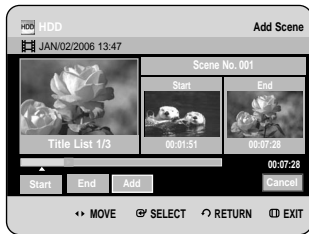

- The image and end point time are displayed in the End window.
- To cancel, press the ◀▶ buttons to select **Cancel**, then press the **OK** button.

**8** Press the ◀▶ buttons to select **Add**, then press the **OK** button.

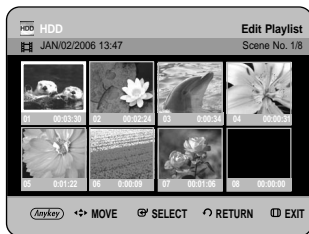

- The section you want to add is inserted prior to the scene selected in step 4 of Adding a Scene on the previous page.

## Deleting a Scene

To setup, follow steps 1 to 3 in page 99~100.

**4-1** Press the ▲▼◀▶ buttons to select the scene you want to delete, then press the **ANYKEY** button.

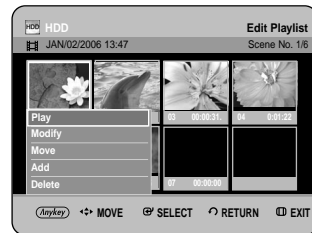

**5** Press the ▲▼ buttons to select **Delete**, then press the **OK** or ▶ button.

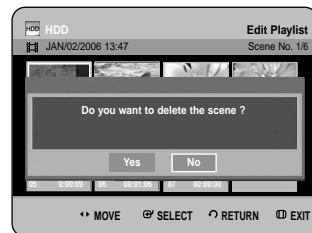

- The message "Do you want to delete the scene ?" is displayed.

**6** Press the ◀▶ buttons to select **Yes**, then press the **OK** to delete the selected scene.

## Deleting a Playlist Entry from the Playlist



### Using the PLAY LIST button

- With the unit in Stop mode/Playback mode, press the **PLAY LIST** button.  
The Edit Playlist screen is displayed.

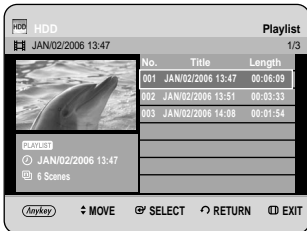

### Using the MENU button.

- With the unit in Stop mode/Playback mode, press the **MENU** button.
- Press the **▲▼** buttons to select **Library**, then press the **OK** or **▶** button.
- Press the **▲▼** buttons to select **Title**, then press the **OK** or **▶** button.  
The Title List screen is displayed.
- Press the **ANYKEY** button.
- Press the **▲▼** buttons to select **Playlist**, then press the **OK** or **▶** button.
- Press the **▲▼** buttons to select **Go To Playlist**, then press the **OK** or **▶** button.

- Press the **ANYKEY** button.  
The Edit Playlist menu is displayed: **Rename**, **Copy**, **Delete**, **Edit Playlist**, **New Playlist**, **Go to Titlelist**.



- Press the **▲▼** buttons to select **Delete**, then press the **OK** or **▶** button.  
Delete screen will be displayed.

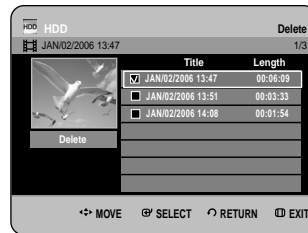

- Press the **▲▼** buttons to select the additional entry you want to delete from the Playlist, then press the **OK** or **▶** button until a checkmark appears.

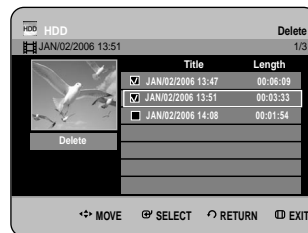

- If you don't want to delete a certain one of the checked entries, simply select that entry and press **OK** or **▶** button to deselect it until a checkmark disappears.

- Press the **◀** button to select **Delete**, then press the **OK** button.  
You will be prompted with the delete confirmation message "Do you want to delete?".

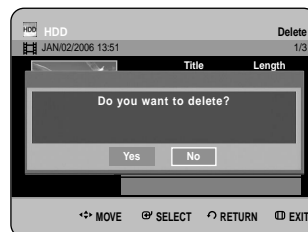

- Press the **◀▶** buttons to select **Yes**, then press the **OK** button.  
You will be automatically returned to the Playlist screen after the delete operation has finished.





# Copying Title List

You can copy a title from DVD to HDD and vice-versa.

## About the Copy Screen

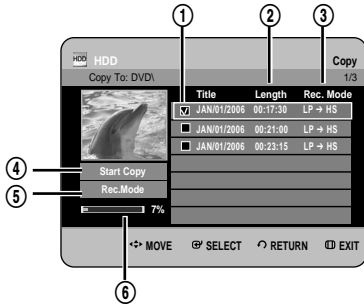

- ① Check titles to be copied
- ② Record time of title to be copied
- ③ Recording mode for copying
  - HS(high speed): you can copy more quickly than normal playback speed.
  - Copies in the same record mode as source title.
  - XP/SP/LP/EP : you can not use high speed copy.
- ④ Copy start button
- ⑤ Record mode setup button
- ⑥ This shows a available space of a disc corresponding to a percentage that is currently selected.

## Contents Copy Specifications

Contents	HDD → DVD	DVD → HDD
Recorded Video Title	Supported	Supported
Copy Protected Title	Not supported	Not supported
Copy Once Title	Move (Deletes the Title in the HDD after copying)	Not supported

Once "Copy Once programme" has been recorded on the DVD disc, this title cannot be copied to HDD anymore. But "Copy Once programme" has been recorded on the HDD, this title can be copied to DVD-RW(VR mode).

## Copying from HDD to DVD



### Using the TITLE LIST button

- 1 Press the **OPEN/CLOSE** button and place a recordable disc on the disc tray.
- 2 Press the **OPEN/CLOSE** button to close the disc tray. Wait until **LOAD** disappears from the front panel display. Check that the disc has enough available space for the recording.
- 3 Select the HDD by pressing the **HDD** button on the front panel of the HDD & DVD RECORDER or on the remote control.
- 4 With the unit in Stop mode/Playback mode, press the **TITLE LIST** button. The Title List screen is displayed.

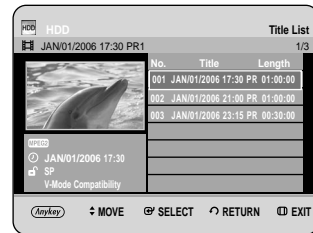

### Using the MENU button.

- With the unit in Stop mode/Playback mode, press the **MENU** button.
- Press the **▲▼** buttons to select **Library**, then press the **OK** or **▶** button.
- Press the **▲▼** buttons to select **Title**, then press the **OK** or **▶** button.

5 Press the **ANYKEY** button.

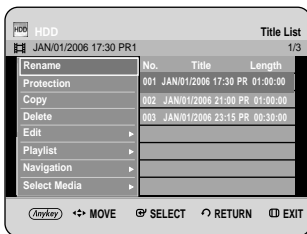

6 Press the **▲▼** buttons to select **Copy**, then press the **OK** or **▶** button. Copy screen is displayed.



By pressing **COPY** button from the title list( or during playback), you can go to this step.

7 Press the **▲▼** buttons to select an additional title you want to copy, then press the **OK** or **▶** button until a checkmark appears. Repeat this step to select a additional title you want to copy.

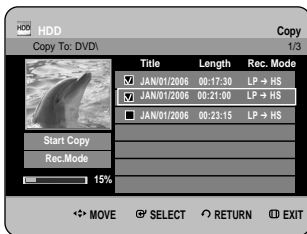

- If you don't want to copy a certain one of the checked entries, simply select that entry and press **OK** or **▶** button to deselect it until a checkmark disappears.
- If you want to change the record mode when copying, see page 108.
- Up to 7 entries can be checked for titles.

8 Press **◀** button to select **Start Copy**, then press the **OK** button.



- Copying a Title that has been edited once before -

9 The "Do you want to view screen of copying title?" message is displayed.

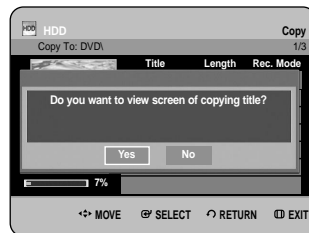

10 To copy a title while viewing the title on the copy screen, press the **◀▶** buttons to select **Yes**, then press the **OK** button.



- If **No** is selected, the title to be copied is not displayed on the screen, and copying begins while the currently broadcasting programme is displayed on the screen.
- Press the **INFO** button to change the copy processing bar. If you press **INFO** button again, copy processing bar will be appeared.
- To cancel the copying in progress, press the **CANCEL** button.

---

## - Copying an Unedited title -

**9**-1 The "Do you want to use high speed copy mode?" message is displayed.



NOTE

- High speed copy : This means that you can transfer without having to worry about the quality getting worse with each copy 'generation'. It also means that copying can be carried out at the maximum speed possible.
- 

---

**10** To begin high speed copy, press the ◀▶ buttons to select **Yes**, then press the **OK** button. High speed copy begins. The title to be copied is not played back, while the currently broadcasting programme is displayed on the screen.



- If **No** is selected, the title to be copied is displayed at its playback speed while copying.
  - Press the **INFO** button to change the copy processing bar. If you press **INFO** button again, copy processing bar will be appeared.
  - To cancel the copying in progress, press the **CANCEL** button.
- 

**11** After a successful copy, "The title is successfully copied" message is displayed.

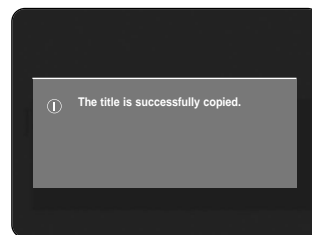

## Changing the Record Mode

To setup, follow steps 1 to 7 in page 105~106.

- 7-1** Press the ◀ and ▼ buttons to select **Rec. Mode**, then press the **OK** button.

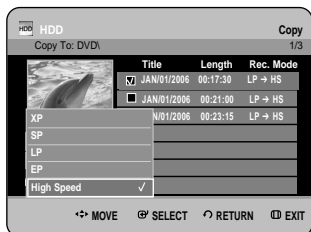

- 8** Press the ▲▼ buttons to select record mode you want to record, then press the **OK** button.

- HS(High Speed) : Copies in the same record mode as HDD.
- XP/SP/LP/EP : You cannot copy at a higher quality mode than original. If the same record mode is selected, the title is copied at high speed.



NOTE

- Using the same method, you can copy a Playlist.
- High speed copying is not available for a title list that has been partially deleted.
- During copying, timer recording is not available.
- High speed copying is not available when:
  - Copying a title that can only be copied once
  - Copying a playlist
  - Copying a partially-deleted title
- If copy list contains at least one title that cannot be copied at high speed, it performs step 9 described on page 106. Otherwise, it performs the step 9-1 described on page 107.
- Regarding title lists that can be copied only once:
  - Only available for DVD discs that support CPRM
  - If a playlist contains a scene that can only be copied once, it cannot be copied.

## Copying from DVD to HDD



### Using the TITLE LIST button

- 1** Press the **OPEN/CLOSE** button and place a recorded disc on the disc tray.
- 2** Press the **OPEN/CLOSE** button to close the disc tray.
- 3** With the unit in Stop mode/Playback mode, press the **TITLE LIST** button.  
The Title List screen is displayed.

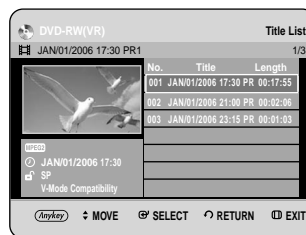

### Using the MENU button.

- With the unit in Stop mode/Playback mode, press the **MENU** button.
- Press the ▲▼ buttons to select **Library**, then press the **OK** or ► button.
- Press the ▲▼ buttons to select **Title**, then press the **OK** or ► button.

4 Press the **ANYKEY** button.

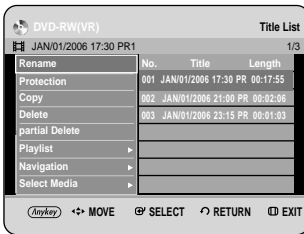

5 Press the **▲▼** buttons to select **Copy**, then press the **OK** or **▶** button.  
Copy screen is displayed.

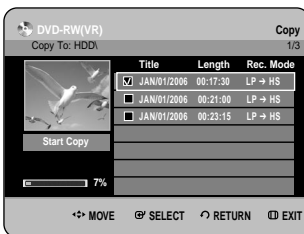

By pressing COPY button from the title list( or during playback), you can go to this step.

6 Press the **▲▼** buttons to select an additional title you want to copy, then press the **OK** or **▶** button until a checkmark appears. Repeat this step to select a additional title you want to copy.

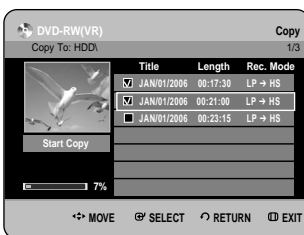

- If you don't want to copy a certain one of the checked entries, simply select that entry and press **OK** or **▶** button to deselect it until a checkmark disappears.
- Up to 7 entries can be checked for titles.

7 Press the **◀** button to select **Start Copy**, then press the **OK** button.

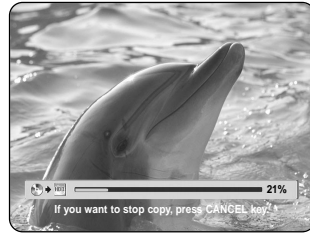

- Press the **INFO** button to change the copy processing bar.  
If you press **INFO** button again, copy processing bar will be appeared.

8 After a successful copy, "The title is successfully copied." message is displayed.

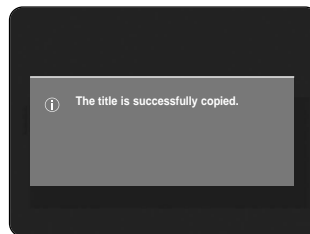

NOTE

- You cannot copy anything else on finalised DVD-R and DVD-RW(V mode) mode.
- You cannot copy a DVD-VIDEO to HDD.
- High speed copying from a DVD-RW (VR mode) is available.
- When you copy from DVD-RW(V mode)/-R disc to HDD, high speed copy is not available.
- Record mode cannot be changed when you copy a title from DVD to HDD.

# Copying MP3, JPEG or DivX

## About the Copy Screen

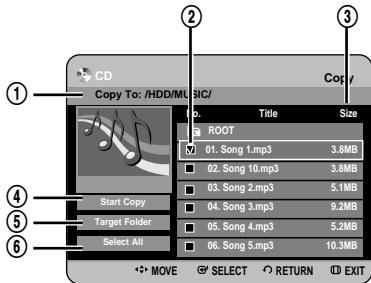

- ① The location where the copied files are stored
- ② Check titles to be copied
- ③ File size
- ④ Copy start button
- ⑤ Target Folder setup button
- ⑥ All entries in the current folder will be checked.

### Contents Copy Specifications

Contents	HDD → DVD or USB	DVD → HDD or USB	USB → HDD or DVD
MP3	Supported	Supported	Supported
JPEG(photo)	Supported	Supported	Supported
DivX	Supported	Supported	Supported

- Disc(CD-R/ CD-RW/ DVD-R(Finalise)/ DVD-RW(Finalise))→ HDD or USB
- HDD → DVD-R, DVD-RW(V) or USB
- USB → HDD or DVD-R, DVD-RW(V)
- The disc that has Video recording or has title dubbing from HDD can't be copied.
- PTP USB is not available when you copy to USB.
- If the disc is finalised through Disc Manager, it can be compatible with PC as a disc with a UDF file system.

## File Copy



- 1 Insert a Disc (JPEG, MP3 or DivX) into the tray.
- 2 Press the **OPEN/CLOSE** button to close the disc tray. Wait until **LOAD** disappears from the front panel display. Check that the disc has enough available space for the recording.
- 3 Press the **▲▼** buttons to select **Library**, then press the **OK** or **▶** button.
- 4 Press the **▲▼** buttons to select **Music**, **Photo** or **DivX(MPGE4)**, then press the **OK** or **▶** button.

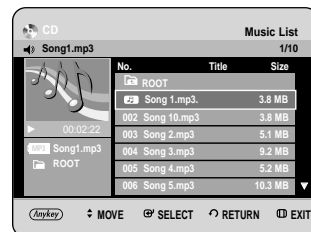

- 5 Press the **▲▼** buttons to select the MP3, JPEG or DivX files you want to copy, then press the **ANYKEY** button.

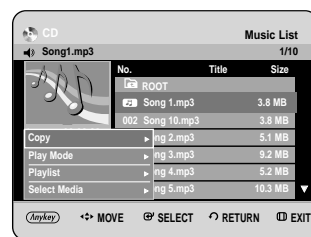

- 6 Press the **▲▼** buttons to select **Copy**, then press the **OK** or **▶** button.

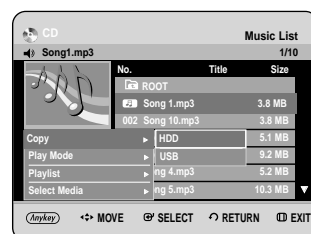

- 7** Press the ▲▼ buttons to select the target media, then press the **OK** or ► button. Copy screen is displayed.

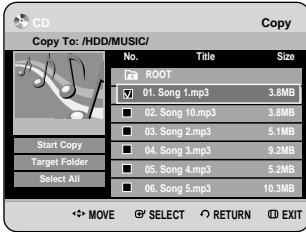

By pressing **COPY** button from the Music list (Photo List, DivX(MPEG4) List), you can go to this step.

- 8** Press the ▲▼ buttons to select the additional entry you want to copy, then press the **OK** or ► button until a checkmark appears.

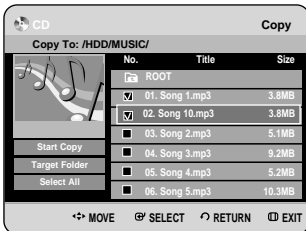

- If you don't want to copy a certain one of the checked entries, simply select that entry and press **OK** or ► button to deselect it until a checkmark disappears.
- If you select **"Select All"**, all entries in the current folder will be checked.
- Up to 100 entries can be checked for MP3, JPEG or DivX files.

- 9** Press the ◀ and ▼ buttons to select **Target Folder**, then press the **OK** button. Target Folder screen will be displayed.

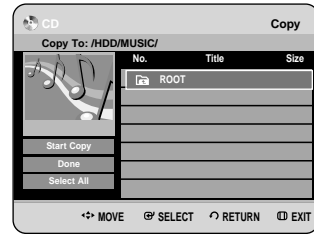
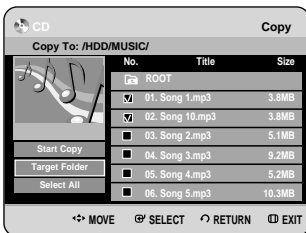

- 10** Press the ▲▼ or **OK** button to select the location where the copied files are stored.

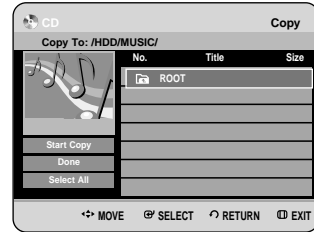

- 11** Press the ◀ button to select **Start Copy**, then press the **OK** button. File copy begins.

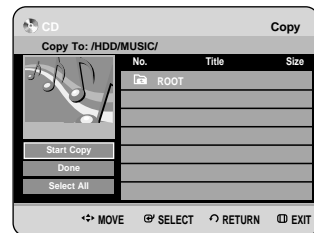

- If you select **Done**, you will be returned to the copy screen.



- If you check some entries in the current folder and move to open a different folder, those entries are automatically unchecked and excluded from the selection list.

## Folder Copy



(VR mode)

- 1 Insert a Disc (JPEG, MP3 or DivX) into the tray.
- 2 Press the ▲▼ buttons to select **Library**, then press the OK or ► button.
- 3 Press the ▲▼ buttons to select **Music, Photo** or **DivX(MPEG4)** then press the OK or ► button. MP3, JPEG or DivX(MPEG4) folder is displayed.

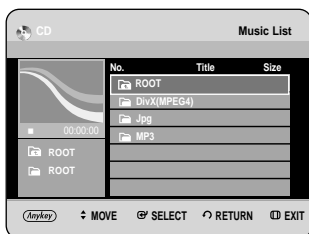

- 4 Press the **ANYKEY** button.

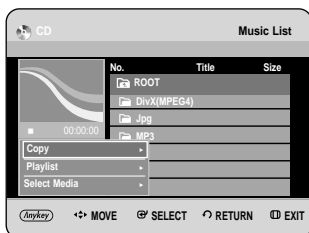

- 5 Press the ▲▼ buttons to select **Copy**, then press the OK or ► button.

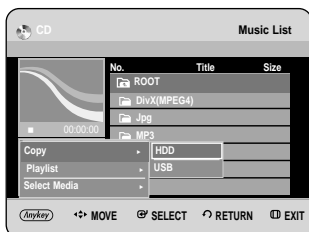

- 6 Press the ▲▼ buttons to select the target media, then press the OK or ► button. Copy screen is displayed.

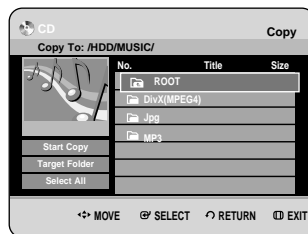

- 7 Press the ▲▼ buttons to select the folder you want to copy, then press the OK button.

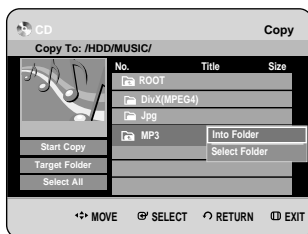

- 8 Press the ▲▼ buttons to select **Select Folder**, then press the OK button. Checkmark will appear.

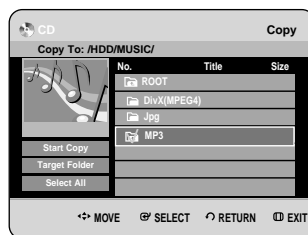

- If you select **Into Folder**, Subfolders and files in the folder will be displayed.
- If you select **"Select All"**, all folder will be checked.



- 9** Press the ◀ and ▼ buttons to select **Target Folder**, then press the OK button.  
Target Folder screen is displayed.

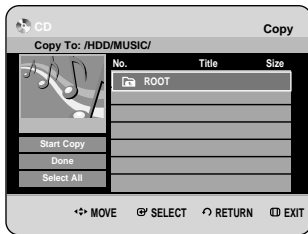

- 10** Press the ▲▼ or OK button to select the location where the copied folders are stored.

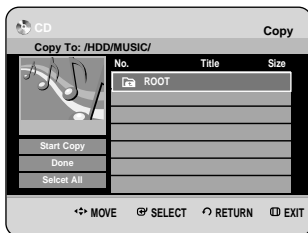

- 11** Press the ◀ button to select **Start Copy**, then press the OK button.  
Folder copy begins. Subfolders and files in the selected folder are copied.

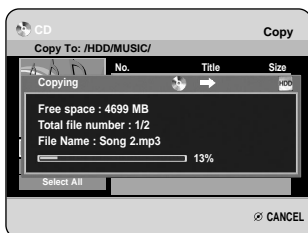
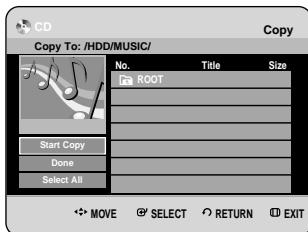

- If you select **Done**, you will be returned to the copy screen.

## - To return to check off -

- 1** Press the ▲▼ buttons to select the folder you want to check off, then press the OK or ► button.

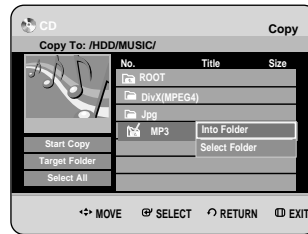

- 2** Press the ▲▼ buttons to select **Select Folder**, then press the OK or ► button.  
Checkmark will disappear.

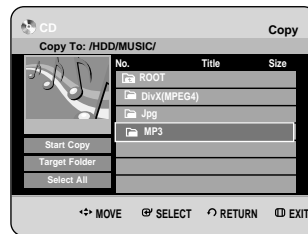

NOTE

- Pressing the **CANCEL** button during folder copying will cancel the folder copying after the current file is copied.
- Up to 500 files and 100 subfolders can be copied into one folder for MP3 files.
- Up to 500 files and 100 subfolders can be copied into one folder for JPEG files.
- Up to 500 files and 100 subfolders can be copied into one folder for DivX files.
- Files having an existing name of **\*\*\*.mp3/\*\*\*.jpg**, are automatically renamed to **\*\*\*01.mp3/\*\*01.jpg** and copied.
- It allows up to 999 copies to have the same name.
- You cannot copy an Audio CD.
- File size on a disc and the copied file in the HDD may be slightly different due to the file system.

# Disc Manager



## Editing the Disc Name

Follow these instructions to give a name to a disc.



- 1 With the unit in Stop mode, press the **MENU** button.

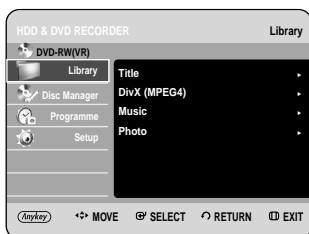

- 2 Press the **▲▼** buttons to select **Disc Manager**, then press the **OK** or **▶** button.

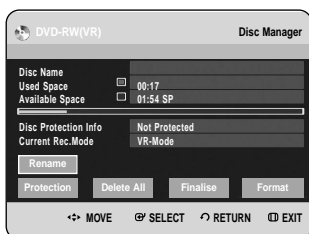

- 3 Press the **▲▼◀▶** buttons to select **Rename**, then press the **OK** button.  
The Rename screen is displayed.



- 4 Select the desired characters using the **▲▼◀▶** buttons, then press the **OK** button.



- 5 Press the **▲▼◀▶** buttons to select **Save**, then press the **OK** button.  
A disc name is given to the disc.



- You may need to clear Disc Protection beginning editing.
- Depending on the kind of disc, the displayed screen may be different.

## Disc Protection

Disc Protection allows you to protect your discs from being formatted or deleted due to unintended operations.



- 1 With the unit in Stop mode, press the **MENU** button.

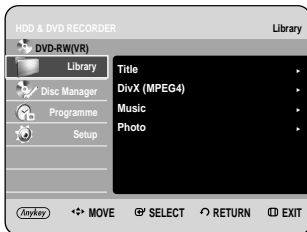

- 2 Press the **▲▼** buttons to select **Disc Manager**, then press the **OK** or **▶** button.

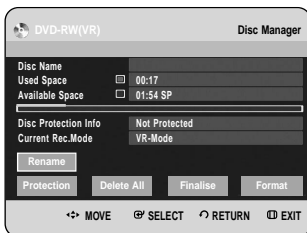

- 3 Press the **▲▼◀▶** buttons to select **Protection**, then press the **OK** button.

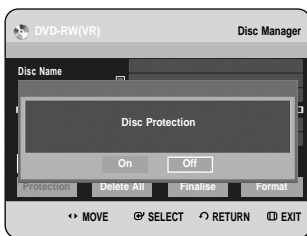

- 4 Press the **◀▶** buttons to select **On**, then press the **OK** button.

## Formatting a Disc

Use these instructions to format a disc. The disc protect should also be cleared.



- 1 With the unit in Stop mode, press the **MENU** button.



- 2 Press the **▲▼** buttons to select **Disc Manager**, then press the **OK** or **▶** button.

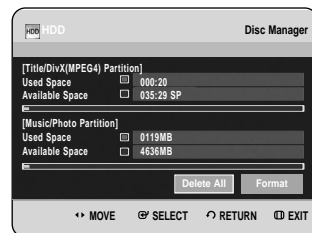

- 3 Press the **◀▶** buttons to select **Format**, then press the **OK** button.

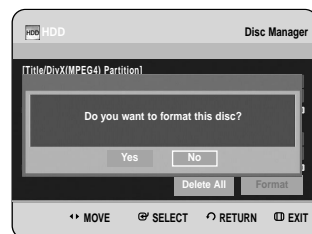

### HDD

- You will be prompted with the confirmation message "Do you want to format this disc?".
- If you select **Yes**, you will be prompted with the confirmation message "All data will be deleted. Do you want to continue?".

## DVD-RW

- You will be prompted with the confirmation message "Choose the recording format for DVD- RW."



## USB

- If the USB storage device has more than two logical drives, select a "Drive" that you want to format.



- You will be prompted with confirmation message "Do you want to format this USB Drive?".
- If you select **Yes**, you will be prompted with the confirmation message "All data will be deleted. Do you want to continue?".

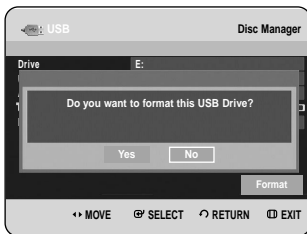

- Press the ◀▶ buttons to select **Yes**, then press the **OK** button. The disc is formatted.

	DVD-VR	DVD-V
DISC	DVD-RW	DVD-RW/DVD-R

DVD-VR and DVD-V are defined according to their recording format.

## Delete All Title Lists/DivX Lists /Music Lists/Photo Lists



- With the unit in Stop mode, press the **MENU** button.



- Press the ▲▼ buttons to select **Disc Manager**, then press the **OK** or ▶ button.

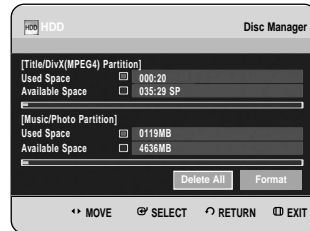

- Press the ◀▶ buttons to select **Delete All**, then press the **OK** button.

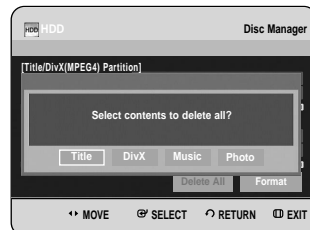

- When Protected Entry exists: The Delete All Title List function will not operate. If there is a title containing a still picture, however, that function will not operate. If you want to delete a protected entry, disable Protect for it on the Lock item.

- 4** Press the ◀▶ buttons to select the **Title**, **DivX**, **Music** or **Photo**, then press the **OK** button.

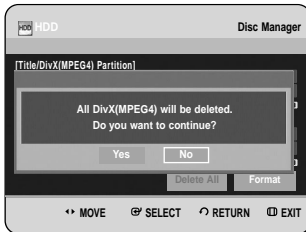
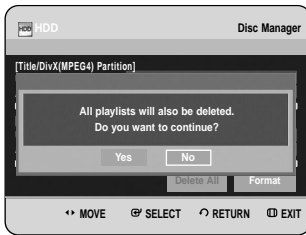

- 5** Press the ◀▶ buttons to select **Yes**, then press the **OK** button. All title lists, DivX lists, music lists or photo lists are deleted.

## Delete All Title Lists



- 1** With the unit in Stop mode, press the **MENU** button.



- 2** Press the ▲▼ buttons to select **Disc Manager**, then press the **OK** or ▶ button.

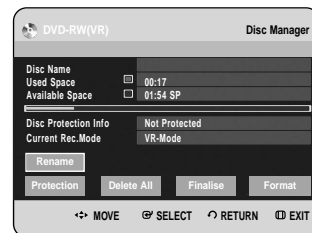

- 3** Press the ▲▼◀▶ buttons to select **Delete All**, then press the **OK** button.
- You will be prompted with the confirmation message "Do you want to delete all title lists?".

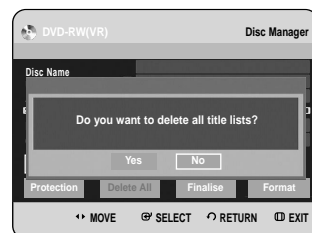

- When Protected Entry exists: The Delete All Title List function will not operate. If there is a title containing a still picture, however, that function will not operate. If you want to delete a protected entry, disable Protect for it on the Lock item.
- When protected a DVD-RW is used, data cannot be deleted from a disc.
- If you select **Yes**, you will be prompted with the confirmation message “All playlists will also be deleted. Do you want to continue?”.

**4** Press the ◀▶ buttons to select **Yes**, then press the **OK** button.  
All title lists are deleted.

## Finalising a Disc

After you record titles onto a DVD-RW/DVD-R disc with your HDD & DVD RECORDER, it needs to be finalised before it can be played back on external devices.



**1** With the unit in Stop mode, press the **MENU** button.



**2** Press the ▲▼ buttons to select **Disc Manager**, then press the **OK** or ▶ button.

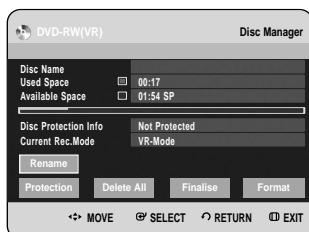

**3** Press the ▲▼◀▶ buttons to select **Finalise**, then press the **OK** button.  
You will be prompted with the message “Do you want to finalise disc?”.

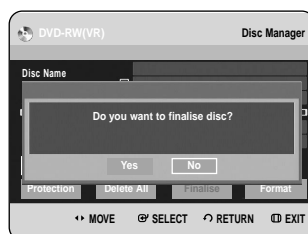

If you select **Yes**, you will be prompted again with the message “Disc will be finalised. Do you want to continue?”.

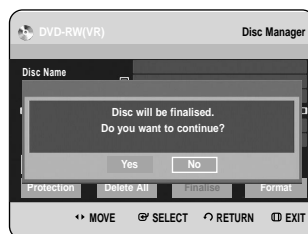

**4** Press the ◀▶ buttons to select **Yes**, then press the **OK** button.  
The disc is finalised.



NOTE

- Once a disc is finalised, you cannot delete entries from the record list.
- After being finalised, the DVD-R/DVD-RW(video mode) operates in the same manner as a DVD-Video.
- Depending on the disc type, the displayed screen may be different.
- Finalising time may be different depending on the amount of data recorded on the disc.
- Data on the disc will be damaged if the recorder is powered off during finalisation process.

# Unfinalising a Disc (V/VR mode)



**1** With the unit in Stop mode, press the **MENU** button.



**2** Press the **▲▼** buttons to select **Disc Manager**, then press the **OK** or **▶** button.

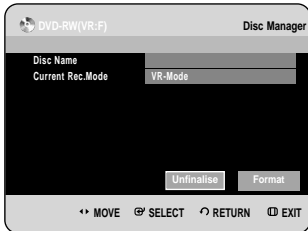

**3** Press the **◀▶** buttons to select **Unfinalise**, then press the **OK** button. You will be prompted with the message "Do you want to unfinalise disc?".

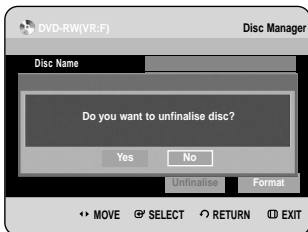

If you select **Yes**, you will be prompted again with the message "Disc will be unfinalised. Do you want to continue?".

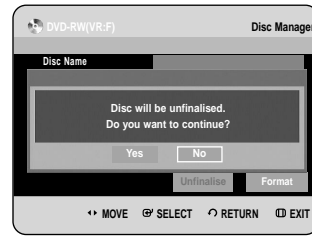

**4** Press the **◀▶** buttons to select **Yes**, then press the **OK** button. The disc is unfinalised.



- A DVD-RW can be finalised or unfinalised in Video mode.

	Finalise	Unfinalise
Mark	DVD-Video(RW)	DVD-RW(V)
Operation	Same as DVD-Video	Additional recording, protection and deletion are possible.

- A DVD-RW can be finalised or unfinalised in VR mode.

	Finalise	Unfinalise
Mark	DVD-RW(VR:F)	DVD-RW(VR)
Operation	Additional recording, deletion, editing, and protection are impossible.	Additional recording, deletion, editing, and protection are possible.

# Reference

Troubleshooting .....	120
Specifications .....	124

## Troubleshooting

If your product malfunctions, go through the checkpoints below before contacting a Samsung authorised service centre.

### Power

The input is displayed for a while when the power is turned on.



- Checkpoint 1** ▶ The HDD & DVD RECORDER requires some time to initialize and the input will be displayed for approx. 10 seconds after it is turned on. But If Quick recording function is set to on, the HDD & DVD RECORDER will power on quickly, which enables you to immediately record a desired channel. (see page 34)

### Recording

Cannot record TV programmes.



- Checkpoint 1** ▶ Check whether the power cord is securely plugged into the power outlet.
- Checkpoint 2** ▶ Did you set the HDD & DVD RECORDER channel settings correctly?
- Checkpoint 3** ▶ Check the free space on your HDD/DVD-RW/-R discs.

I pressed the **REC** button but there is no response.



- Checkpoint 1** ▶ Recording is possible for HDD/DVD-RW/-R discs only. If a programme is copy protected, it cannot be recorded.



## Playback

Cannot play the disc.



**Checkpoint 1** Check whether the disc is inserted correctly with the label facing up.

**Checkpoint 2** Check the regional code of the DVD disc.

**Checkpoint 3** This HDD & DVD RECORDER cannot play some types of discs. (See pages 6, 46)

⊘ icon appears on the screen.



**Checkpoint 1** You cannot use this operation or function due to one of the following reasons:  
(1) Your DVD disc restricts it.  
(2) Your DVD disc does not support this feature (for example: angles)  
(3) The feature is not available at the moment.  
(4) You've requested a title, chapter, or scan time that is out of range.

Play mode settings are different from the settings configured in the Settings menu.



**Checkpoint 1** The disc does not support all selected functions. In this case, some settings configured in the settings menu may not work properly.

Cannot change the aspect ratio.



**Checkpoint 1** The aspect ratio is fixed for DVD discs. (See page 40)

The angle operation does not work while playing a DVD disc.



**Checkpoint 1** The angle operation is available only when the disc contains images captured from different angles.

The selected audio and/or subtitle language is not played.



**Checkpoint 1** Audio and subtitle languages are disc-specific. Only the sound and subtitle languages contained on the DVD disc are available and displayed in the disc menu.

Cannot copy title or file to the other mode.



**Checkpoint 1** DVD discs encoded with copy protection can not be copied to HDD.

**Checkpoint 2** Refer to "Contents Copy Specifications" on page 5 to check if copying is supported. Refer to "V-Mode Compatibility" on page 39 to check if copying is support.

## Video

The disc revolves, but no image or bad quality images is displayed.



- Checkpoint 1** Be sure that the Video Setting is properly set. (See page 40)
- Checkpoint 2** Check whether there is damage to or any foreign material on your disc.
- Checkpoint 3** Some low quality discs may not play properly.
- Checkpoint 4** If scenes change from dark to bright suddenly, the screen may shake vertically temporarily, but this is not a fault.

## Sound

No sound.



- Checkpoint 1** Are you watching a programme in slow or skip mode?  
If you are playing a programme at a speed other than normal speed, sound will not be heard.(except for forward search (Fast 1) in disc.)
- Checkpoint 2** Check the connections and settings. (See pages 22~23, 38~39)
- Checkpoint 3** Check whether the disc is damaged. Clean the disc, if necessary.
- Checkpoint 4** Check whether the disc is inserted correctly with the label facing up.

No audio output.



- Checkpoint 1** Check whether you have selected the correct digital output options in the Audio Output Options menu. (See pages 38~39)

## Timer Recording

Timer lamp flickers.



- Checkpoint 1** Check there is enough space in the disc or HDD for recording.
- Checkpoint 2** Check whether the current disc is recordable or not. Make sure to check before the start time of recording.

Timer recording does not work properly.



- Checkpoint 1** Re-check the recording time and the end time settings again.
- Checkpoint 2** Recording will be cancelled if the power is interrupted due to a power failure or another similar reason while recording.

## USB

Cannot copy MP3 or JPEG or DivX files



- Checkpoint 1** Check the connections and settings. (See page 26)
- Checkpoint 2** Check the USB connection. Disconnect and try to connect again.
- Checkpoint 3** Refer to "Compatible USB devices at host port" on page 7.

Cannot print image files.



- Checkpoint 1** Check the connections and settings. (See page 26)
- Checkpoint 2** Refer to "Printing Photos" on page 72
- Checkpoint 3** Refer to "Compatible Printers at device port" on page 7

## HDMI (HR738 Only)

No HDMI output.



- Checkpoint 1** Check whether the mode is stop mode or not. You can switch HDMI mode in stop mode.
- Checkpoint 2** Check the Video output is HDMI enabled.
- Checkpoint 3** Check the connection between the TV and the HDMI jack of the HDD & DVD RECORDER.
- Checkpoint 4** See if your TV supports HDMI.

Abnormal HDMI output screen.



- Checkpoint 1** If snow noise appears on the screen, it means that TV does not support HDCP (High-bandwidth Digital Content Protection).

HDMI output Jitter



- Checkpoint 1** Check your TV system setup correctly.
- Checkpoint 2** Please refer to the user's manual of your TV.

## Remote Control Unit

The remote control doesn't work.





- Checkpoint 1** Point the remote control at the remote control sensor on your HDD & DVD RECORDER. Allow for proper distance. Remove obstacles between your HDD & DVD RECORDER and the remote control.
- Checkpoint 2** Check whether the batteries are drained.
- Checkpoint 3** Check the **TV/DVD** selection button setting.
- Checkpoint 4** Check whether TV control button is selected or not.

## Other

I forgot my password for parental supervision.



- Checkpoint 1** Press and hold the **PROG**( ) buttons on the front panel of the Recorder for more than 5 seconds with no disc in the unit. All settings including the password will revert to the factory settings. Do not use this unless absolutely necessary. (Note that this function is possible only when no disc is inserted.)

Is it possible to change a subtitle and an audio signal on a recorded disc?



- Checkpoint 1** A recorded disc is played with only the subtitle and the audio signal which were selected during recording.

Other problems.



- Checkpoint 1** Read the table of contents and then find and read the section describing your problem, follow the instructions given.
- Checkpoint 2** Plug your HDD & DVD RECORDER off and on.
- Checkpoint 3** If the problem still persists, contact a nearby Samsung service centre.

# Specifications



General	Power requirements	220-240V AC, 50Hz
	Power consumption	35 Watts / 4,3Watts(Power off)
	Weight	3,9 Kg
	Dimensions	430mm(W) x 300mm(D) x 59mm(H)
	Operating temp.	+5°C to +35°C
	Other conditions	Keep level when operating. Less than 75% operating humidity
Input	Video	Composite Video : 1.0 V p-p at 75Ω load, sync negative
	Audio	Max.Audio Input Level : 2Vrms
	DV Input	IEEE 1394(4p) compatible jack
	Receivable Channels	PAL-I
	Scart Jack	AV2 (Scart Ext)
Output	Audio	Analogue output jacks x 2
		Optical/Coaxial digital audio output
	Video	Composite Video : Video output jack x 1
		S-Video output x 1 (Y:1,0Vp-p, C:0,286Vp-p at 75Ω load)
		Component output x 1 (Y: 1,0Vp-p, Pb: 0,70Vp-p, Pr: 0,70Vp-p at 75Ω load)
		HDMI/DVI (576p) (HR738 Only)
Scart Jack	AV1 (Scart TV)	Video : Composite, RGB Audio: analogue
Recording	Picture Compression format	MPEG-II
	Audio Compression format	Dolby Digital 2ch/256Kbps, MPEG-II
	Recording Quality	XP (about 8,5 Mbps), SP (about 4,5 Mbps), LP (about 2,5 Mbps), EP (about 1,6 Mbps or about 1,2 Mbps)
		Audio Frequency Response
HDD Capacity	DVD-HR733	80 GB
	DVD-HR738	250 GB
USB	USB 2.0 H/S	Host x 1, Device x 1

## Audio Output

For DVD discs, audio signals recorded at 96kHz sampling frequency are converted into and output at 48kHz.

Disc Type	DVD	AUDIO CD(CD-DA)
Analog Audio Output	48 / 96kHz	44,1kHz
Digital Audio Output	48kHz	44,1kHz



## UNITED KINGDOM

This Samsung product is warranted for the period of twelve (12) months from the original date of purchase, against defective materials and workmanship. In the event that warranty service is required, you should return the product to the retailer from whom it was purchased.

However, Samsung Authorised Dealers and Authorised Service Centres in other EC Countries will comply with the warranty on the terms issued to purchasers in the country concerned. In case of difficulty, details of our Authorised Service Centres are available from:

**Samsung Electronics U.K.Ltd.**  
**Unit C, Stafford Park 12**  
**Telford, Shropshire**  
**TF3 3BJ**  
**The United Kingdom**  
**Tel: 0870)242 0303,**  
**Fax: 01952)297617**

### ■ WARRANTY CONDITIONS

1. The warranty is only valid if, when warranty service is required, the warranty card is fully and properly completed and is presented with the original invoice or sales slip or confirmation, and the serial number on the product has not been defaced.
2. Samsung's obligations are limited to the repair or, at its discretion, replacement of the product or the defective part.
3. Warranty repairs must be carried out by Authorised Samsung Dealers or Authorised Service Centres. No re-imburement will be made for repairs carried out by non Samsung Dealers and, any such repair work and damage to the products caused by such repair work will not be covered by this warranty.



## REPUBLIC OF IRELAND

4. This product is not considered to be defective in materials nor workmanship by reason that it requires adaptation in order to conform to national or local technical or safety standards in force in any Country other than the one for which the product was originally designed and manufactured. This warranty will not cover, and no re-imburement will be made for such adaptation nor any damage which may result.
5. This warranty covers none of the following:
  - a) Periodic check ups, maintenance and repair or replacement of parts due to normal wear and tear.
  - b) Cost relating to transport, removal or installation of the product.
  - c) Misuse, including the failure to use this product for its normal purposes or incorrect installation.
  - d) Damage caused by Lightning, Water, Fire, Acts of God, War, Public Disturbances, incorrect mains voltage, improper ventilation or any other cause beyond the control of Samsung.
6. This warranty is valid for any person who legally acquired possession of the product during the warranty period.
7. The consumers statutory rights in any applicable national legislation whether against the retailer arising from the purchase contract or otherwise are not affected by this warranty. Unless there is national legislation to the contrary, the rights under this warranty are the consumers sole rights and Samsung, its subsidiaries and distributors shall not be liable for indirect or consequential loss or any damage to records, compact discs, videos or audio taper or any other related equipment or material.

**SAMSUNG ELECTRONICS (U.K.)LTD.**

## Contact SAMSUNG WORLD WIDE

If you have any questions or comments relating to Samsung products, please contact the SAMSUNG customer care centre.

Region	Country	Customer Care Centre ☎	Web Site
North America	CANADA	1-800-SAMSUNG (7267864)	www.samsung.com/ca
	MEXICO	01-800-SAMSUNG (7267864)	www.samsung.com/mx
	U.S.A	1-800-SAMSUNG (7267864)	www.samsung.com
Latin America	ARGENTINE	0800-333-3733	www.samsung.com/ar
	BRAZIL	0800-124-421	www.samsung.com/br
	CHILE	800-726-7864(SAMSUNG)	www.samsung.com/cl
	COSTA RICA	0-800-507-7267	www.samsung.com/latin
	ECUADOR	1-800-10-7267	www.samsung.com/latin
	EL SALVADOR	800-6225	www.samsung.com/latin
	GUATEMALA	1-800-299-0013	www.samsung.com/latin
	JAMAICA	1-800-234-7267	www.samsung.com/latin
	PANAMA	800-7267	www.samsung.com/latin
	PUERTO RICO	1-800-682-3180	www.samsung.com/latin
	REP. DOMINICA	1-800-751-2676	www.samsung.com/latin
	TRINIDAD & TOBAGO	1-800-7267-864	www.samsung.com/latin
VENEZUELA	1-800-100-5303	www.samsung.com/latin	
Europe	BELGIUM	02 201 2418	www.samsung.com/be
	CZECH REPUBLIC	844 000 844	www.samsung.com/cz
	DENMARK	38 322 887	www.samsung.com/dk
	FINLAND	09 693 79 554	www.samsung.com/fi
	FRANCE	08 25 08 65 65 (0,15€/Min)	www.samsung.com/fr
	GERMANY	01805 -121213 (€0,12/Min)	www.samsung.de
	HUNGARY	06 40 985 985	www.samsung.com/hu
	ITALIA	199 153 153	www.samsung.com/it
	LUXEMBURG	02 261 03 710	www.samsung.lu
	NETHERLANDS	0900 20 200 88 (€0.10/Min)	www.samsung.com/nl
	NORWAY	231 627 22	www.samsung.com/no
	POLAND	0 801 801 881	www.samsung.com/pl
	PORTUGAL	80 8 200 128	www.samsung.com/pt
	SLOVAKIA	0850 123 989	www.samsung.com/sk
	SPAIN	902 10 11 30	www.samsung.com/es
	SWEDEN	08 585 367 87	www.samsung.com/se
U.K	0870 242 0303	www.samsung.com/uk	
CIS	RUSSIA	8-800-200-0400	www.samsung.ru
	UKRAINE	8-800-502-0000	www.samsung.com/ur
Asia Pacific	AUSTRALIA	1300 362 603	www.samsung.com/au
	CHINA	800-810-5858, 010- 6475 1880	www.samsung.com.cn
	HONG KONG	2862 6001	www.samsung.com/hk
	INDIA	3030 8282 1600 1100 11	www.samsung.com/in
	INDONESIA	0800-112-8888	www.samsung.com/id
	JAPAN	0120-327-527	www.samsung.com/jjp
	MALAYSIA	1800-88-9999	www.samsung.com/my
	PHILIPPINES	1800-10-SAMSUNG (7267864)	www.samsung.com/ph
	SINGAPORE	1800-SAMSUNG (7267864)	www.samsung.com/sg
	THAILAND	1800-29-3232 02-689-3232	www.samsung.com/th
	TAIWAN	0800-329-999	www.samsung.com/tw
VIETNAM	1 800 588 889	www.samsung.com/vn	
Middle East & Africa	SOUTH AFRICA	0860 7267864 (SAMSUNG)	www.samsung.com/za
	U.A.E	800SAMSUNG (7267864)	www.samsung.com/mea



**Correct Disposal of This Product  
(Waste Electrical & Electronic Equipment)**



**(Applicable in the European Union and other European countries with separate collection systems)**

This marking shown on the product or its literature, indicates that it should not be disposed with other household wastes at the end of its working life. To prevent possible harm to the environment or human health from uncontrolled waste disposal, please separate this from other types of wastes and recycle it responsibly to promote the sustainable reuse of material resources.

Household users should contact either the retailer where they purchased this product, or their local government office, for details of where and how they can take this item for environmentally safe recycling.

Business users should contact their supplier and check the terms and conditions of the purchase contract. This product should not be mixed with other commercial wastes for disposal.

**English**

AK68-01111A

## Free Manuals Download Website

<http://myh66.com>

<http://usermanuals.us>

<http://www.somanuals.com>

<http://www.4manuals.cc>

<http://www.manual-lib.com>

<http://www.404manual.com>

<http://www.luxmanual.com>

<http://aubethermostatmanual.com>

Golf course search by state

<http://golfingnear.com>

Email search by domain

<http://emailbydomain.com>

Auto manuals search

<http://auto.somanuals.com>

TV manuals search

<http://tv.somanuals.com>