

HT-C330

Digital Home Cinema System user manual

Imagine the possibilities

Thank you for purchasing this Samsung product.

To receive more complete service,
please register your product at



www.samsung.com/register



Safety Information

Safety Warnings

TO REDUCE THE RISK OF ELECTRIC SHOCK, DO NOT REMOVE THE COVER(OR BACK). NO USER-SERVICEABLE PARTS ARE INSIDE. REFER SERVICING TO QUALIFIED SERVICE PERSONNEL.

	CAUTION RISK OF ELECTRIC SHOCK DO NOT OPEN	
This symbol indicates "dangerous voltage" inside the product that presents a risk of electric shock or personal injury.	CAUTION : TO PREVENT ELECTRIC SHOCK, MATCH WIDE BLADE OF PLUG TO WIDE SLOT, FULLY INSERT.	This symbol indicates important instructions accompanying the product.

WARNING

- To reduce the risk of fire or electric shock, do not expose this appliance to rain or moisture.

CAUTION

- Apparatus shall not be exposed to dripping or splashing and no objects filled with liquids, such as vases, shall be placed on the apparatus.
- The Mains plug is used as a disconnect device and shall stay readily operable at any time.
- This apparatus shall always be connected to a AC outlet with a protective grounding connection.
- To disconnect the apparatus from the mains, the plug must be pulled out from the mains socket, therefore the mains plug shall be readily operable.

CLASS 1 LASER PRODUCT
KLASSE 1 LASER PRODUKT
LUOKAN 1 LASER LAITE
KLASS 1 LASER APPARAT
PRODUCTO LÁSER CLASE 1

CLASS 1 LASER PRODUCT

This Compact Disc player is classified as a CLASS 1 LASER product.

Use of controls, adjustments or performance of procedures other than those specified herein may result in hazardous radiation exposure.

CAUTION

- INVISIBLE LASER RADIATION WHEN OPEN AND INTERLOCKS DEFEATED, AVOID EXPOSURE TO BEAM.

Precautions

- Ensure that the AC power supply in your house complies with the identification sticker located on the back of your product.
- Install your product horizontally, on a suitable base (furniture), with enough space around it for ventilation (7.5-10cm).
- Do not place the product on amplifiers or other equipment which may become hot. Make sure the ventilation slots are not covered.
- Do not stack anything on top of the product.
- Before moving the product, ensure the Disc Insert Hole is empty.
- In order to disconnect the product completely from the power supply, remove the AC plug from the wall outlet, especially when left unused for a long period of time.
- During thunderstorms, disconnect the AC plug from the wall outlet. Voltage peaks due to lightning could damage the product.
- Do not expose the product to direct sunlight or other heat sources. This could lead to overheating and malfunction of the product.
- Protect the product from moisture, and excess heat or equipment creating strong magnetic or electric fields (i.e. speakers.).
- Disconnect the power cable from the AC supply if the product malfunctions.
- Your product is not intended for industrial use. Use of this product is for personal use only.
- Condensation may occur if your product or disc has been stored in cold temperatures. If transporting the product during the winter, wait approximately 2 hours until the product has reached room temperature before using.
- The batteries used with this product contain chemicals that are harmful to the environment. Do not dispose of batteries in the general household trash.

Accessories

Check for the supplied accessories below.



Video Cable



FM Antenna



User's Manual



Remote Control/Batteries (AAA size)

Safety Information

Cautions on Handling and Storing Discs

Small scratches on the disc may reduce sound and picture quality or cause skipping.

Be especially careful not to scratch discs when handling them.

Holding discs

- Do not touch the playback side of the disc.
- Hold the disc by the edges so that fingerprints will not get on the surface.
- Do not stick paper or tape on the disc.

Disc Storage

- Do not keep in direct sunlight
- Keep in a cool ventilated area
- Keep in a clean Protection jacket.
Store vertically.



NOTE

- Do not allow the discs to become contaminated with dirt.
- Do not load cracked or scratched discs.

Handling and Storing Discs

If you get fingerprints or dirt on the disc, clean it with a mild detergent diluted in water and wipe with a soft cloth.

- When cleaning, wipe gently from the inside to the outside of the disc

NOTE

- Condensation may form if warm air comes into contact with cold parts inside the product. When condensation forms inside the product, it may not operate correctly. If this occurs, remove the disc and let the product stand for 1 or 2 hours with the power on.

Licence

- ABOUT DIVX VIDEO: DivX® is a digital video format created by DivX, Inc. This is an official DivX Certified device that plays DivX video. Visit www.divx.com for more information and software tools to convert your files into DivX video. ABOUT DIVX VIDEO-ON-DEMAND: This DivX Certified® device must be registered in order to play DivX Video-on-Demand (VOD) content. To generate the registration code, locate the DivX VOD section in the device setup menu. Go to vod.divx.com with this code to complete the registration process and learn more about DivX VOD.
- DivX Certified® to play DivX® video
- Dolby and the double-D symbol are registered trademarks of Dolby Laboratories.
- "Pat. 7,295,673; 7,460,688; 7,519,274"



Copyright

© 2010 Samsung Electronics Co., Ltd. All rights reserved.

Copy Protection

- Many DVD discs are encoded with copy protection. Because of this, you should only connect your product directly to your TV, not to a VCR. Connecting to a VCR results in a distorted picture from copy-protected DVD discs.
- This product incorporates copyright protection technology that is protected by U.S. patents and other intellectual property rights. Use of this copyright protection technology must be authorized by Rovi Corporation, and is intended for home and other limited viewing uses only unless otherwise authorized by Rovi Corporation. Reverse engineering or disassembly is prohibited.

Contents

SAFETY INFORMATION

2

- 2 Safety Warnings
- 3 Precautions
- 3 Accessories
- 4 Cautions on Handling and Storing Discs
- 4 Licence
- 4 Copyright
- 4 Copy Protection

GETTING STARTED

7

- 7 Icons that will be used in manual
- 7 Disc Types and Characteristics
- 11 Description
 - 11 Front Panel
 - 12 Rear Panel
- 13 Remote control

CONNECTIONS

15

- 15 Connecting the Speakers
- 17 Connecting the Video Out to your TV
- 18 P.SCAN(progressive scan) function
- 19 Connecting the FM Antenna
- 20 Connecting Audio from External Components

SETUP

21

- 21 Before Starting (Initial Setting)
- 21 Setting the Setup menu
- 22 Display
 - 22 TV Aspect
- 22 Audio
 - 22 Speaker Setting
 - 24 DRC (Dynamic Range Compression)
 - 24 AV-SYNC
- 24 System
 - 24 Initial Setting
 - 24 DivX(R) Registration
- 24 Language
- 24 Security
 - 24 Parental Rating
 - 24 Change Password
- 24 Support
 - 24 Product Information

ENGLISH

Contents

BASIC FUNCTIONS

25

- 25 Disc Playback
- 25 Audio CD(CD-DA)/MP3/WMA Playback
- 26 JPEG File Playback
- 26 Using the Playback Function
- 31 Sound Mode
- 32 Listening to Radio
- 32 Connecting Microphone

ADVANCED FUNCTIONS

33

- 33 USB Function
- 33 CD Ripping

OTHER INFORMATION

34









- 34 Troubleshooting
- 35 Country code list
- 36 Specifications

- Figures and illustrations in this User Manual are provided for reference only and may differ from actual product appearance.

Getting Started

Icons that will be used in manual

Make sure to check the following terms before reading the user manual.

Icon	Term	Definition
	DVD	This involves a function available with DVD-Video or DVD±R/±RW discs that have been recorded and finalised in Video Mode.
	CD	This involves a function available with a data CD (CD DA, CD-R/-RW).
	MP3	This involves a function available with CD-R/-RW discs.
	JPEG	This involves a function available with CD-R/-RW discs.
	DivX	This involves a function available with MPEG4 discs. (DVD±R/±RW, CD-R/-RW)
	CAUTION	This involves a case where a function does not operate or settings may be cancelled.
	NOTE	This involves tips or instructions on the page that help each function operate.
	Shortcut Key	This function provides direct and easy access pressing the button on the remote control.

Disc Types and Characteristics



Region Code

The product and the discs are coded by region. These regional codes must match in order for the disc to play. If the codes do not match, the disc will not play.

Disc Type	Region Code	Area
DVD-VIDEO		The U.S., U.S. territories and Canada
		Europe, Japan, the Middle East, Egypt, South Africa, Greenland
		Taiwan, Korea, the Philippines, Indonesia, Hong Kong
		Mexico, South America, Central America, Australia, New Zealand, Pacific Islands, Caribbean
		Russia, Eastern Europe, India, most of Africa, North Korea, Mongolia
		China

Getting Started

Disc types that can be played

Disc Types & Mark (Logo)	Recorded Signals	Disc Size	Max. Playing Time
 DVD-VIDEO	VIDEO	12 cm	Approx. 240 min. (single-sided)
			Approx. 480 min. (double-sided)
		8 cm	Approx. 80 min. (single-sided)
			Approx. 160 min. (double-sided)
 AUDIO-CD	AUDIO	12 cm	74 min.
		8 cm	20 min.
 DivX	AUDIO + VIDEO	12 cm	—
		8 cm	—

Do not use the following types of discs!

- LD, CD-G, CD-I, CD-ROM, DVD-ROM and DVD-RAM discs cannot be played on this product. If such discs are played, a <WRONG DISC FORMAT> message appears on the TV screen.
- DVD discs purchased abroad may not play on this product. If such discs are played, a <Wrong Region. Please check Disc.> message appears on the TV screen.

Disc Types And Disc Format

This product does not support Secure (DRM) Media files.

CD-R Discs

- Some CD-R discs may not be playable depending on the disc recording device (CD-Recorder or PC) and the condition of the disc.
- Use a 650MB/74 minute CD-R disc. Do not use CD-R discs over 700MB/80 minutes as they may not be played back.
- Some CD-RW (Rewritable) media, may not be playable.
- Only CD-Rs that are properly "closed" can be fully played. If the session is closed but the disc is left open, you may not be able to fully play the disc.

CD-R MP3 Discs

- Only CD-R discs with MP3 files in ISO 9660 or Joliet format can be played.
- MP3 file names should contain no blank spaces or special characters (. / = +).
- Use discs recorded with a compression/decompression data rate greater than 128Kbps.
- Only files with the ".mp3" and ".MP3" extensions can be played.
- Only a consecutively written multisession disc can be played. If there is a blank segment in the Multisession disc, the disc can be played only up to the blank segment.
- If the disc is not closed, it will take longer to begin playback and not all of the recorded files may be played.
- For files encoded in Variable Bit Rate (VBR) format, i.e. files encoded in both low bit rate and high bit rate (e.g., 32Kbps ~ 320Kbps), the sound may skip during playback.
- A maximum of 500 tracks can be played per CD.
- A maximum of 300 folders can be played per CD.

CD-R JPEG Discs

- Only files with the "jpg" extensions can be played.
- If the disc is not closed, it will take longer to start playing and not all of the recorded files may be played.
- Only CD-R discs with JPEG files in ISO 9660 or Joliet format can be played.
- JPEG file names should be 8 characters or less in length and contain no blank spaces or special characters (. / = +).
- Only a consecutively written multisession disc can be played. If there is a blank segment in the multisession disc, the disc can be played only up to the blank segment.
- A maximum of 999 images can be stored on a folder.
- When playing a Kodak/Fuji Picture CD, only the JPEG files in the picture folder can be played.
- Picture discs other than Kodak/Fuji Picture CDs may take longer to start playing or may not play at all.

DVD±R/±RW, CD-R/RW Discs

- Software updates for incompatible formats are not supported.
(Example : QPEL, GMC, resolutions higher than 800 x 600 pixels, etc.)
- If a DVD-R/-RW disc has not been recorded properly in DVD Video format, it will not be playable.

DivX (Digital internet video express)

DivX is a video file format developed by Microsoft and is based on MPEG4 compression technology to provide audio and video data over the Internet in real-time.

MPEG4 is used for video encoding and MP3 for audio encoding, enabling to watch a movie at near DVD-quality video and audio.

Supported Formats (DivX)

This product only supports the following media formats. If both video and audio formats are not supported, the user may experience problems such as broken images or no sound.

Supported Video Formats

Format	Supported Versions
AVI	DivX3.11~DivX5.1, XviD
WMV	V1/V2/V3/V7

Supported Audio Formats

Format	Bit Rate	Sampling Frequency
MP3	80~320kbps	44.1khz
WMA	56~128kbps	
AC3	128~384kbps	44.1/48khz

- Aspect Ratio : Although the default DivX resolution is 640x480 pixels, this product supports up to 720x480 pixels. TV screen resolutions higher than 800 will not be supported.
- When you play a disc whose sampling frequency is higher than 48khz or 320kbps, you may experience shaking on the screen during playback.
- Sections with a high frame rate might not be played while playing a DivX file.

- Since this product only provides encoding formats authorized by DivX Networks, Inc., a DivX file created by the user might not play.

USB Host Specification

USB Host Specification

- Supports USB 1.1 or USB 2.0 compliant devices.
- Supports devices connected using the USB A type cable.
- Supports UMS (USB Mass Storage Device) V1.0 compliant devices.
- Supports devices with drives formatted in the FAT(FAT, FAT16, FAT32)file system.

Non-compliance

- Does not support a device that requires installing a separate driver on a PC (Windows).
- Does not support connection to a USB hub.
- A USB device that is connected using a USB extension cable may not be recognized.
- A USB device requiring a separate power source needs to be connected to the product with the separate power connection.

Operational Limitations

- If the connected device has multiple drives (or partitions) installed, only one drive (or partition) can be connected.
- A device supporting USB 1.1 alone may cause a difference in the picture quality, depending on the device.

Getting Started

USB Devices that can be used with the product

- USB Storage Device, MP3 Player, Digital Camera
- Removable HDD
 - Removable HDDs equipped with less than 160 Gbytes are supported. Removable HDDs equipped with 160Gbytes or more may not be recognized, depending on the device.
 - If the connected device does not work due to insufficient power supply, you can use a separate power cable to supply power so that it can work properly. The connector of the USB cable may differ, depending on the manufacturer of the USB device.
- USB card Reader: One slot USB card reader and Multi slot USB card reader.
 - The USB card reader may not be supported, depending on the manufacturer.
 - If you install multiple memory devices into a multi card reader, you may experience problems.

- Some MP3 players, when connected to this product, may not operate depending on the sector size of their file system.
- The USB host function is not supported if a product that transfers media files by its manufacturer specific program is connected.
- Does not operate with Janus enabled MTP (Media Transfer Protocol) devices.

Supported file Formats

Format	Still Picture	Music		Movie	
File name	JPG	MP3	WMA	WMV	DivX
File extension	JPG .JPEG	.MP3	.WMA	.WMV	.AVI
Bit rate	-	80-320 kbps	56-128 kbps	4Mbps	4Mbps
Version	-	-	V8	V1,V2, V3,V7	DivX3.11~ DivX5.1, XviD
Pixel	640x480	-	-	720x480	
Sampling Frequency	-	44.1kHz	44.1kHz	44.1KHz~ 48KHz	

- CBI (Control/Bulk/Interrupt) is not supported.
- Digital Cameras that use PTP protocol or require additional program installation when connected to a PC are not supported.
- A device using NTFS file system is not supported. (The system supports only the FAT file system and will not play a movie larger than 1 GB in USB mode.)

10 English

Description

Front Panel

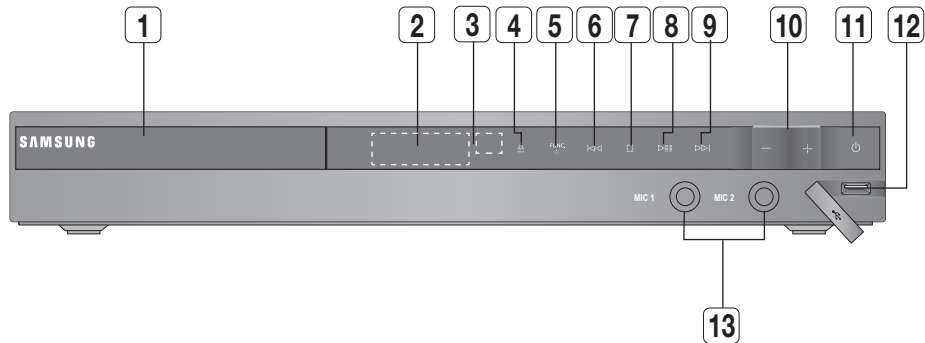

1	DISC TRAY	Insert disc here.
2	DISPLAY	Displays the playing status, time, etc.
3	REMOTE CONTROL SENSOR	Detects signals from the remote control.
4	OPEN/CLOSE BUTTON (▲)	Opens and closes the disc tray.
5	FUNCTION BUTTON (FUNC.)	The mode switches as follows : DVD/CD → D.IN → AUX → USB → FM.
6	TUNING DOWN & SKIP BUTTON (◀)	Goes back to the previous title/chapter/track. Tunes down the FM frequency band.
7	STOP BUTTON (■)	Stops disc playback.
8	PLAY/PAUSE BUTTON (▶)	Plays a disc or pauses playback.
9	TUNING UP & SKIP BUTTON (▶)	Goes to the next title/chapter/track. Tunes up the FM frequency band.
10	VOLUME CONTROL BUTTON (—, +)	Volume adjustment.
11	POWER BUTTON (⏻)	Turns the product on and off.
12	USB PORT	Connect here and play files from external USB storage devices such as MP3 players, USB flash memory, etc.
13	MIC 1,2 jack	Connect up to two microphones.

Getting Started

Rear Panel

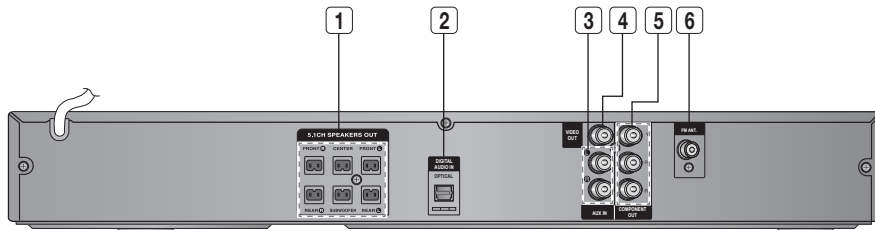

1	5.1 CHANNEL SPEAKER OUTPUT CONNECTORS	Connect the front, Centre, surround speakers and subwoofer.
2	EXTERNAL DIGITAL OPTICAL IN JACK (DIGITAL AUDIO IN)	Use this to connect external equipment capable of digital output.
3	AUX IN JACKS	Connect to the 2CH Analogue output of an external device (such as a VCR).
4	VIDEO OUT JACK	Connect your TV's Video Input jack (VIDEO IN) to the VIDEO OUT jack.
5	COMPONENT VIDEO OUTPUT JACKS	Connect a TV with Component video inputs to these jacks.
6	FM ANTENNA JACK	Connect the FM antenna.

Remote control

Tour of the Remote Control

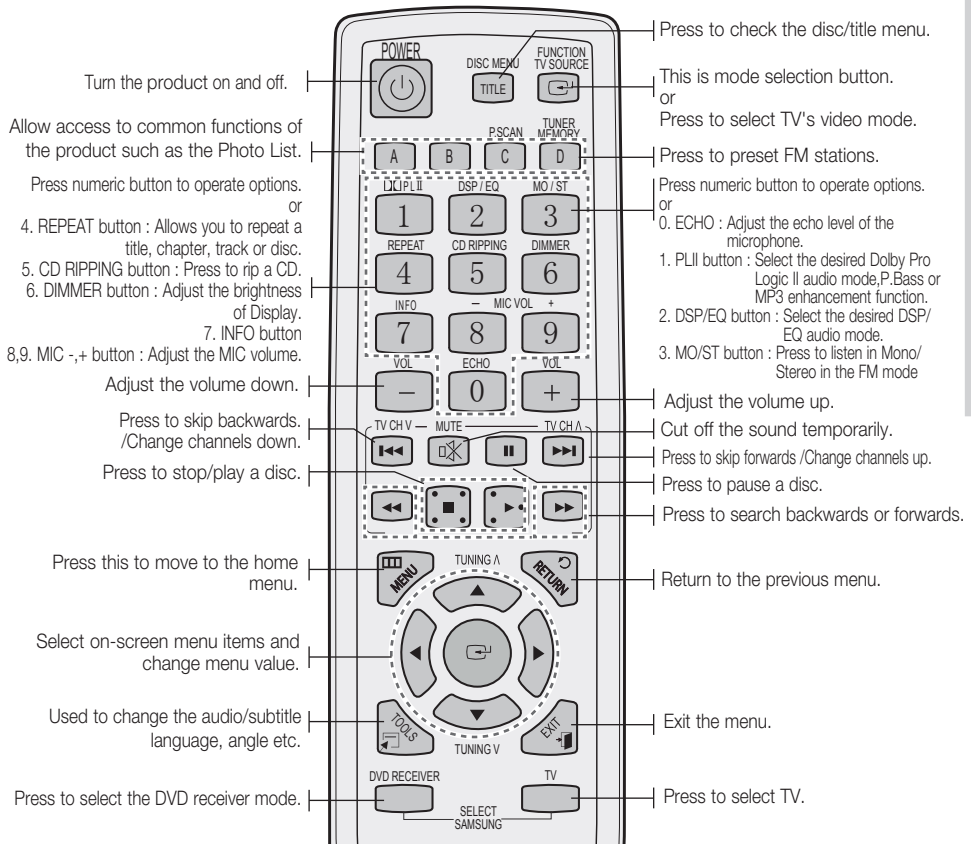

Installing batteries in the Remote Control

* Battery size: AAA

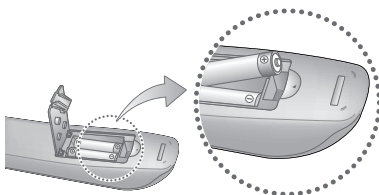

NOTE

- Place batteries in the remote control so they match the polarity : (+) to (+) and (-) to (-).
- Always replace both batteries at the same time.
- Do not expose the batteries to heat or flame.
- The remote control can be used up to approximately 7 meters in a straight line.

Getting Started

Setting the Remote Control

You can control certain functions of your TV with this remote control.

When operating a TV with the remote control

1. Press the **TV** button to set the remote control to TV mode.
2. Press the **POWER** button to turn on the TV.
3. While holding down the **POWER** button, enter the code corresponding to your brand of TV.
 - If there is more than one code listed for your TV in the table, enter one at a time to determine which code works.
 - **Example : For a Samsung TV**
While holding down the **POWER** button, use the number buttons to enter 00, 15, 16, 17 and 40.
4. If the TV turns off, the setting is complete.
 - You can use the TV **POWER**, **VOLUME**, **CHANNEL**, and **Numeric** buttons (0-9).

NOTE

- The remote control may not work or some operations may not be possible with some brands of TVs.
- The remote control will work on a Samsung TV by default.

TV Brand Code List

Brand	Code	Brand	Code
Admiral (M.Wards)	56, 57, 58	MTC	18
A Mark	01, 15	NEC	18, 19, 20, 40, 59, 60
Anam	01, 02, 03, 04, 05, 06, 07, 08, 09, 10, 11, 12, 13, 14	Nikei	03
AOC	01, 18, 40, 48	Onking	03
Bell & Howell (M.Wards)	57, 58, 81	Ornwa	03
Brocsonic	59, 60	Panasonic	06, 07, 08, 09, 54, 66, 67, 73, 74
Candle	18	Penney	18
Cetronic	03	Philco	03, 15, 17, 18, 48, 54, 59, 62, 69, 90
Citizen	03, 18, 25	Philips	15, 17, 18, 40, 48, 54, 62, 72
Cinema	97	Pioneer	63, 66, 80, 91
Classic	03	Portland	15, 18, 59
Concerto	18	Proton	40
Contec	46	Quasar	06, 66, 67
Coronado	15	Radio Shack	17, 48, 56, 60, 61, 75
Craig	03, 05, 61, 82, 83, 84	RCA/Proscan	18, 59, 67, 76, 77, 78, 92, 93, 94
Croslex	62	Realistic	03, 19
Crown	03	Sampo	40
Curtis Mates	59, 61, 63	Samsung	00, 15, 16, 17, 40, 43, 46, 47, 48, 49
CXC	03	Sanyo	19, 61, 65
Daewoo	02, 03, 04, 15, 16, 17, 18, 19, 20, 21, 22, 23, 24, 25, 26, 27, 28, 29, 30, 32, 34, 35, 36, 46, 59, 90	Scott	03, 40, 60, 61
Daytron	40	Sears	15, 18, 19
Dynasty	03	Sharp	15, 57, 64
Emerson	03, 15, 40, 46, 59, 61, 64, 82, 83, 84, 85	Signature 2000 (M.Wards)	57, 58
Fisher	19, 65	Sony	50, 51, 52, 53, 55
Funai	03	Soundesign	03, 40
Futuretech	03	Spectricon	01
General Electric (GE)	06, 40, 56, 59, 66, 67, 68	SSS	18
Hall Mark	40	Sylvania	18, 40, 48, 54, 59, 60, 62
Hitachi	15, 18, 50, 59, 69	Symphonic	61, 95, 96
Inkel	45	Tatung	06
JC Penney	56, 59, 67, 86	Techwood	18
JVC	70	Teknika	03, 15, 18, 25
KTV	59, 61, 87, 88	TMK	18, 40
KEC	03, 15, 40	Toshiba	19, 57, 63, 71
KMC	15	Vidtech	18
LG (Goldstar)	01, 15, 16, 17, 37, 38, 39, 40, 41, 42, 43, 44	Videch	59, 60, 69
Luxman	18	Wards	15, 17, 18, 40, 48, 54, 60, 64
LXI (Sears)	19, 54, 56, 59, 60, 62, 63, 65, 71	Yamaha	18
Magnavox	15, 17, 18, 48, 54, 59, 60, 62, 72, 89	York	40
Marantz	40, 54	Yupiteru	03
Matsui	54	Zenith	58, 79
MGA	18, 40	Zonda	01
Mitsubishi/MGA	18, 40, 59, 60, 75	Dongyang	03, 54

Connections

This section involves various methods of connecting the product to other external components. Before moving or installing the product, be sure to turn off the power and disconnect the power cord.

Connecting the Speakers

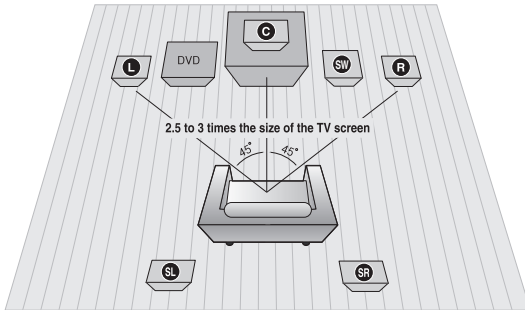

Position of the product

Place it on a stand or cabinet shelf, or under the TV stand.

Selecting the Listening Position

The listening position should be located about 2.5 to 3 times the distance of the TV's screen size away from the TV.

Example : For 32" TV's 2-2.4m
For 55" TV's 3.5-4m

Front Speakers L R	Place these speakers in front of your listening position, facing inwards (about 45°) toward you. Place the speakers so that their tweeters will be at the same height as your ear. Align the front face of the front speakers with the front face of the centre speaker or place them slightly in front of the centre speakers.
Centre Speaker C	It is best to install it at the same height as the front speakers. You can also install it directly over or under the TV.
Rear Speakers SL SR	Place these speakers to the side of your listening position. If there isn't enough room, place these speakers so they face each other. Place them about 60 to 90cm above your ear, facing slightly downward. * Unlike the front and centre speakers, the rear speakers are used to handle mainly sound effects and sound will not come from them all the time.
Subwoofer SW	The position of the subwoofer is not so critical. Place it anywhere you like.

! CAUTION

- Do not let children play with or near the speakers. They could get hurt if the speaker falls.
- When connecting the speaker wires to the speakers, make sure that the polarity (+/-) is correct.
- Keep the subwoofer out of the reach of children so as to prevent them from inserting their hands or alien substances into the duct (hole) of the subwoofer.
- Do not hang the subwoofer on the wall through the duct (hole).

📎 NOTE

- If you place a speaker near your TV set, screen colour may be distorted because of the magnetic field generated by the speaker. If this occurs, place the speaker away from your TV set.

Connections

Connecting the Speakers

Speaker Components

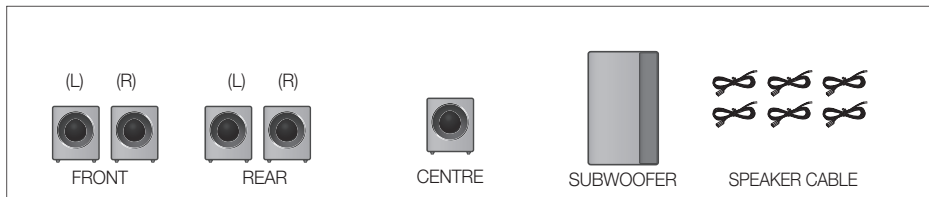

Connecting The Speakers

1. Press down the terminal tab on the back of the speaker.
2. Insert the black wire into the black terminal (-) and the red wire into the red terminal (+), and then release the tab.
3. Connect the connecting plugs to the back of the product by matching the colours of the speaker plugs to the speaker jacks.

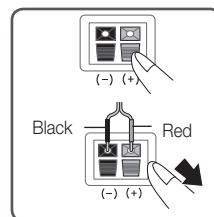

HT-C330

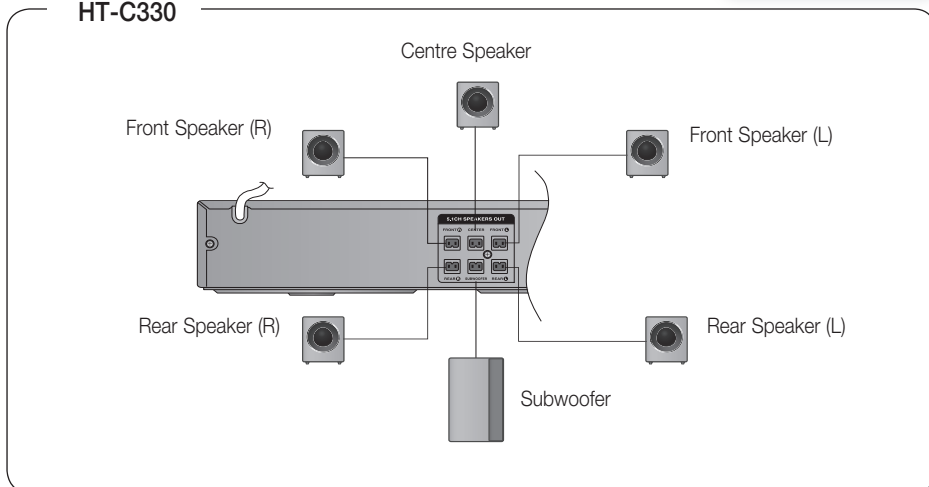

Connecting the Video Out to your TV

Choose one of the two methods for connecting to a TV.

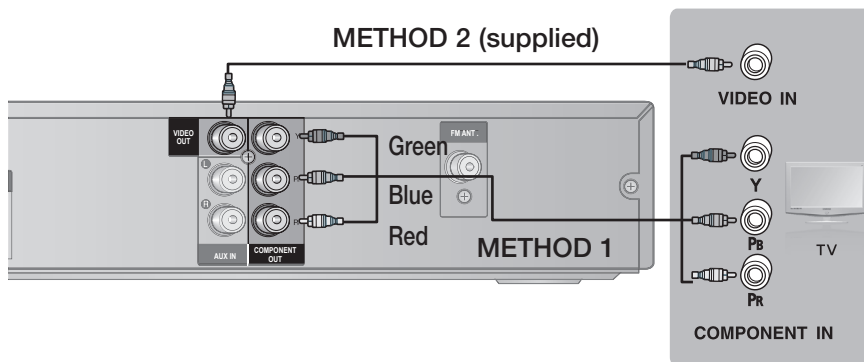

METHOD 1 : Component Video

If your television is equipped with Component Video inputs, connect a Component video cable(not supplied) from the **COMPONENT OUT** (Pr, Pb and Y) jacks on the back of the product to the Component Video Input jacks on your TV.

METHOD 2 : Composite Video

Connect the supplied Video cable from the **VIDEO OUT** jack on the back of the product to the VIDEO IN jack on your TV.

NOTE

- This product operates in Interlace scan mode 480i(576i) for component/composite output.
- After making the video connection, set the Video input source on your TV to match the corresponding Video output mode on your product.
See your TV owner's manual for more information on how to select the TV's Video Input source.
- Turn the your product on before searching the TV source.

! CAUTION

- Do not connect the unit through a VCR. Video signals fed through VCRs may be affected by copyright protection systems and the picture will be distorted on the television.

Connections

P.SCAN(PROGRESSIVE SCAN) FUNCTION

Unlike regular Interlace Scan, in which two fields of picture information alternate to create the entire picture (odd scan lines, then even scan lines), Progressive Scan uses one field of information (all lines displayed in one pass) to create a clear and detailed picture without visible scan lines.

1. Press **STOP** button.
 - If playing a disc, press the **STOP** button twice so that "**STOP**", appears on the display.
2. Press and hold **P.SCAN** button on the remote control for over 5 seconds.
 - Pressing and holding the button for over 5 seconds will select "**P.SCAN**" and "**I.SCAN**" alternately.
 - When you select P.SCAN, "**P.SCAN**" will appear on the display.
 - To set P.Scan mode for DivX discs, press the **P.SCAN** button on the remote control for more than 5 seconds with no disc in the unit ("**NO DISC**" on the display), then load the DivX disc and play.

What is Progressive (or Non-Interlaced) Scanning?

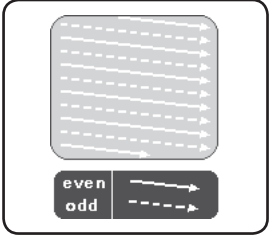
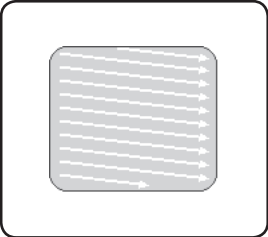
Interlaced Scan (1 FRAME = 2 FIELDS)	Progressive Scan (FULL FRAME)
 <p>In interlaced-scan video, a frame consists of two interlaced fields (odd and even), where each field contains every other horizontal line in the frame. The odd field of alternating lines is displayed first, and then the even field is displayed to fill in the alternating gaps left by the odd field to form a single frame.</p> <p>One frame, displayed every 1/30th of a second, contains two interlaced fields, thus a total of 60 fields are displayed every one second.</p> <p>The interlaced scanning method is intended for capturing a still object.</p>	 <p>The progressive scanning method scans one full frame of video consecutively down the screen, line by line. An entire image is drawn at one time, as opposed to the interlaced scanning process by which a video image is drawn in a series of passes.</p> <p>The progressive scanning method is desirable for dealing with moving objects.</p>

NOTE

- Depending on the capabilities of your TV, this function may not work.

Connecting the FM Antenna

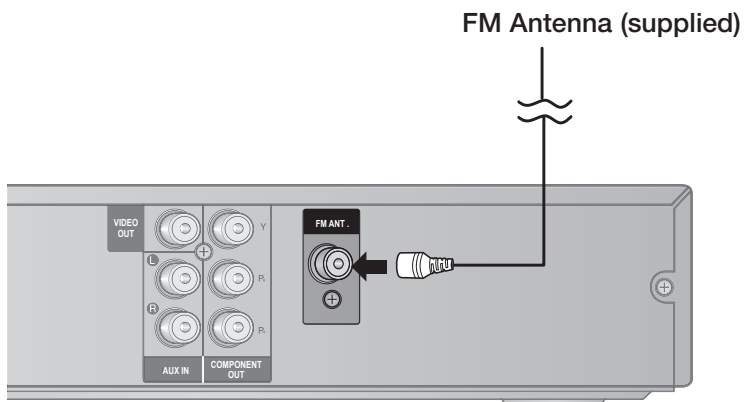

1. Connect the FM antenna supplied to the FM Antenna jack.
2. Slowly move the antenna wire around until you find a location where reception is good, then fasten it to a wall or other rigid surface.

NOTE

- This product does not receive AM broadcasts.

Connections

Connecting Audio from External Components

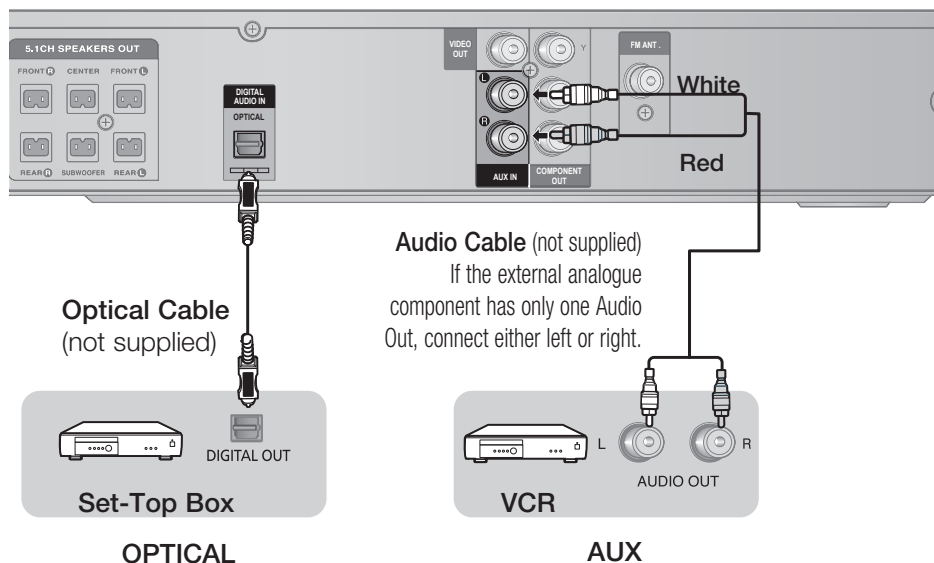

AUX : Connecting an External Analogue Component

Analogue signal components such as a VCR.

1. Connect **AUX IN** (Audio) on the back of the product to the Audio Out of the external Analogue component.
 - Be sure to match the colours of the connecting jacks.
2. Press the **FUNCTION** button to select **AUX** input.
 - The mode switches as follows :
DVD/CD → D.IN → **AUX** → USB → FM.

NOTE

- You can connect the Video Output jack of your VCR to the TV, and connect the Audio Output jacks of the VCR to this product.

OPTICAL : Connecting an External Digital Component

Digital signal components such as a Cable Box/Satellite receiver (Set-Top Box).

1. Connect the **DIGITAL AUDIO IN (OPTICAL)** on the back of the product to the Digital Output of the external digital component.
2. Press the **FUNCTION** button to select **D.IN**.
 - The mode switches as follows :
DVD/CD → **D.IN** → AUX → USB → FM.

Before Starting (Initial Setting)

1. Press the **POWER** button when it is plugged in TV for the first time.
Initial Setting screen will be displayed.

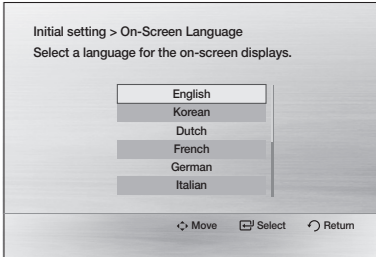

2. Press the **▲▼** buttons to select the desired language, then press the **ENTER** button.
3. Press the **ENTER** button to select Start button.
4. Press the **▲▼** buttons to select desired TV Aspect, then press the **ENTER** button.
5. Press the **ENTER** button to select Start button.

NOTE

- If you want to move to the previous screen, press the **RETURN** button.
- Once you select a menu language, you can change it by pressing the **STOP** (■) button on the remote control for more than 5 seconds with no disc inserted.
- When the Initial Setting screen does not appear, refer to the Initial Setting. (see page 24)

Selecting the Video Format

Each country has a different video format standard. You can select the video format either NTSC or PAL. Press and hold the Number 7 button on the remote control for over 5 seconds while the product is turned off.

- "NTSC" or "PAL" will appear on the display. At this time, press the Number 7 button to select either "NTSC" or "PAL".
- The video format of the disc must be the same as the video format of your TV.

Setting the Setup menu

The access step may differ depending on the selected menu. The GUI (Graphical User Interface) in this manual may differ, depending on the firmware version.

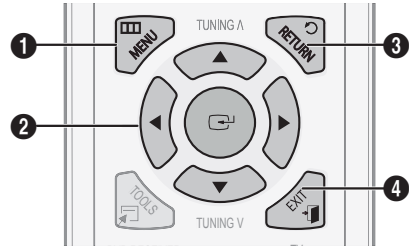

- | | |
|---|---|
| 1 | MENU BUTTON : Display the home menu. |
| 2 | ENTER / DIRECTION BUTTON
Move the cursor and select an item.
Select the currently selected item.
Confirm the setting. |
| 3 | RETURN BUTTON : Return to the previous setup menu. |
| 4 | EXIT BUTTON : Exit the setup menu. |

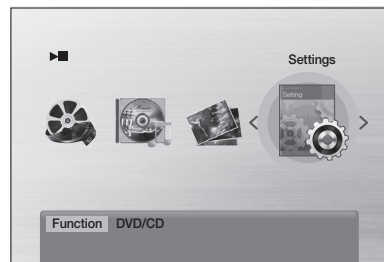

1. Press the **POWER** button.
2. Press the **◀▶** buttons to select **Settings**, then press the **ENTER** button.
3. Press the **▲▼** buttons to select the desired menu, then press the **ENTER** button.
4. Press the **▲▼** buttons to select the desired sub-menu, then press the **ENTER** button.
5. Press the **▲▼** buttons to select the desired item, then press the **ENTER** button.
6. Press the **EXIT** button to exit the setup menu.

Setup

Display

You can configure various display options such as the TV Aspect, Resolution, etc.

TV Aspect

Depending on the type of television you have, you may want to adjust the screen setting.

• 4:3 Pan-Scan



Select when you want to see the 16:9 video supplied by the DVD without the black bars on top and bottom, even though you have a TV with a 4:3 ratio screen (extreme left and right portion of the movie picture will be cut off).

• 4:3 Letter Box



Select when you want to see the total 16:9 ratio screen DVD supplies, even though you have a TV with a 4:3 ratio screen. Black bars will appear at the top and bottom of the screen.

• 16:9 Wide



You can view the full 16:9 picture on your widescreen TV.

NOTE

- If a DVD is in the 4:3 ratio, you cannot view it in the wide screen.
- Since DVD discs are recorded in various image formats, they will look different depending on the software, the type of TV, and the TV aspect ratio setting.

Audio

Speaker Setting

Speaker Size

You can set the Speaker Size of the Center and Rear Speakers, as well as Test Tone in this mode.

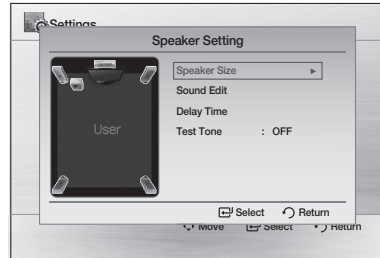

- For the Front speakers, the mode is set to Small.
- For the Subwoofer, the mode is set to Present.
- For the Centre and Rear speakers, you can switch the mode to Small or None.
 - **Small** : Select this when using the speakers.
 - **None** : Select this when no speaker is connected.

NOTE

- The speaker mode may vary depending on the Dolby Pro Logic and Stereo settings.

Sound Edit

You can adjust the balance and level for each speaker.

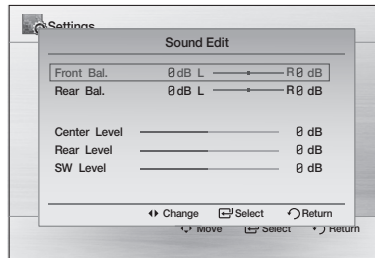

Press the ▲▼ buttons to select and adjust the desired speaker.

Press the ◀▶ buttons to adjust the settings.

Adjusting Front/Rear Speaker Balance

- You can select between 0 and -6.
- The volume decreases as you move closer to -6.

Adjusting Centre/Rear/Subwoofer Speaker Level

- The volume level can be adjusted in steps from +6dB to -6dB.
- The sound gets louder as you move closer to +6dB and quieter as you get closer to -6dB.

Delay Time

If the speakers cannot be placed at equal distances from the listening position, you can adjust the delay time of the audio signals from the Centre and Rear speakers. You can also set the Test Tone in this mode.

Setting up the Speaker Delay Time

When 5.1CH Surround Sound is played, you can enjoy the best sound if the distance between you and each speaker is the same.

Since the sounds arrive at the listening position at different times depending on the placement of speakers, you can adjust this difference by adding a delay effect to the Center and Rear Speakers.

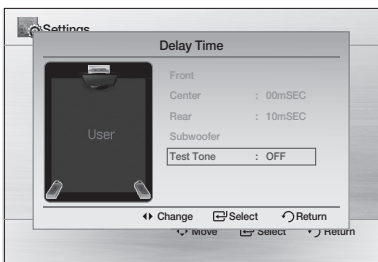

NOTE

- The Delay Time menu will be activated only when the 5.1 channel source is played.
- You can not set Centre and Rear in this mode when their Speaker Size is set to None.

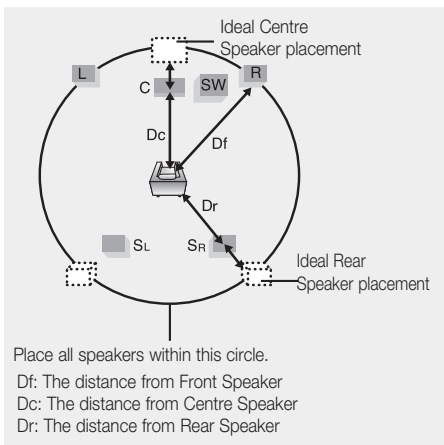

Setting the Centre Speaker

If the distance of Dc is equal to or longer than the distance of Df in the figure, set the mode as 0ms. Otherwise, change the setting according to the table.

Distance between Df and Dc	0.00m	0.34m	0.68m	1.06m	1.40m	1.76m
Delay Time	00 ms	01 ms	02 ms	03 ms	04 ms	05 ms

Setting the Rear Speaker

If the distance of Dc is equal to or longer than the distance of Dr in the figure, set the mode as 0ms. Otherwise, change the setting according to the table.

Distance between Dr and Dc	0.00m	1.06m	2.11m	3.16m	3.62m	5.29m
Delay Time	00 ms	03 ms	06 ms	09 ms	12 ms	15 ms

NOTE

- With PL II (Dolby Pro Logic II), the delay time may be different for each mode.
- With AC-3, the delay time can be set between 00 and 15mSEC.
- The Centre channel is only adjustable on 5.1 channel discs.

Test Tone

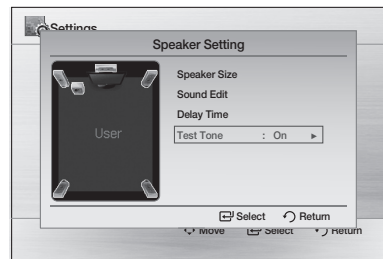

Use the Test Tone feature to check the speaker connections.

- Press the ◀▶ buttons to select **ON**.
- The test tone will be sent to **Front Left → Center → Front Right → Rear Right → Rear Left → Subwoofer** in order.
 To stop the test tone, press the **ENTER** button.

Setup

DRC (Dynamic Range Compression)

This feature balances the range between the loudest and quietest sounds. You can use this function to enjoy Dolby Digital sound when watching movies at low volume at night.

- You can select either off, 2/8, 4/8, 6/8, Full.

AV-SYNC

Video and audio sync may not match with digital TV. If this occurs, adjust the audio delay time to match the video

- You can set the audio delay time between 0 mSec and 300 mSec. Set it to the optimal status.

System

Initial Setting

By using the Initial Setting, you can set the language and TV aspect.

DivX(R) Registration

View DivX(R) VOD Registration Code to purchase and play DivX(R) VOD content.

Language

You can select the language you prefer for on-screen menu, disc menu, etc.

OSD Language	Select the language for the on-screen displays.
Disc Menu	Select the language for the disc menu displays.
Audio	Select the language for disc audio.
Subtitle	Select the language for disc subtitles.

※ To select a language that does not appear in the menu, select OTHERS in the Disc Menu, Audio and Subtitle, and enter the language code of your country (see page 35).

※ You cannot select OTHERS in the OSD Language menu.

NOTE

- The selected language will only appear if it is supported on the disc.

24 English

Security

The Parental Lock function works in conjunction with DVDs that have been assigned a rating, which helps you control the types of DVDs that your family watches. There are up to 8 rating levels on a disc.

Parental Rating

Select the rating level you want to set.

A larger number indicates that the program is intended for adult use only. For example, if you select up to Level 6, discs that contain Level 7, 8 will not play.

Enter the password and then press the **ENTER** button.

- The password is set to "7890" by default.

- Once the setup is complete, you will be taken to the previous screen.

Change Password

Select **Change** and enter the 4-digit password to set the parental lock using the number buttons on the remote control.

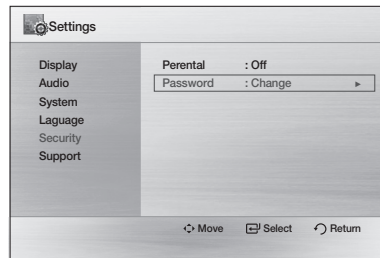

If you forgot your password

1. Remove the disc.
2. Press and hold the **STOP** (■) button on the remote control for 5 seconds or more. All settings will revert to the factory settings.

Support

Product Information

Product information such as Model code, Software Version, etc. is provided.

Basic Functions

Disc Playback

1. Press the **OPEN/CLOSE** (▲) button.
2. Place a disc gently into the tray with the disc's label facing up.
3. Press the **OPEN/CLOSE** (▲) button to close the disc tray.

NOTE

- Resume function: When you stop disc play, the product remembers where you stopped, so when you press **PLAY** button again, it will pick up where you left off. (This function works only with DVDs.)
Press the **STOP** button twice during playback to disable the Resume function.
 - If no buttons are pressed on the product or remote control for more than 3 minutes when the product is in Pause mode, it will change to STOP mode.
 - The initial screen may appear different, depending on the content of the disc.
 - Pirated discs will not play in this product because they violate the CSS(Content Scrambling System: a copy protection system) recommendations.
- ※  will appear when an invalid button is pressed.

TV Screen Saver/Power Saving Function

- If the product is left in the stop mode for more than 5 minutes without being used, a screen saver will appear on your TV.
- If the product is left in the screen saver mode for more than 25 minutes, the power will automatically turn off (Automatic Power-Off Function).

Audio CD(CD-DA)/MP3/WMA Playback

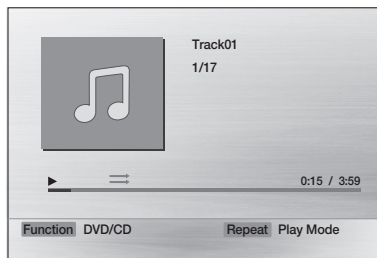

1. Insert an Audio CD(CD-DA) or an MP3 Disc into the disc tray.
 - For an Audio CD, the first track will be played automatically.
 - Press the **◀◀▶▶** buttons to move to the previous/next track.
 - For the MP3/WMA disc, press the **◀▶** buttons to select **Music**, then press the **ENTER** button.
 - Press the **▲▼◀▶** buttons to select a desired file and press the **ENTER** button.
 - Press the **◀◀▶▶** buttons to move to the previous/next pages.
2. Press the **STOP** (■) button to stop playback.

NOTE

- Some MP3/WMA-CDs may not play, depending on the recording mode.
- Table of contents of a MP3-CD varies depending on the MP3/WMA track format recorded on the disc.
- WMA-DRM files, DTS CD cannot be played.
- When MP3/WMA/CD playing, number key doesn't work.

Basic Functions

JPEG File Playback

Images captured with a digital camera or camcorder, or JPEG files on a PC can be stored on a CD and then played back with this product.

1. Insert a JPEG disc on the disc tray.
2. Press the ◀▶ buttons to select **Photo**, and then press the **ENTER** button.
3. Press the ▲▼ buttons to select the folder you want to play, and then press the **ENTER** button.
4. Press the ▲▼ buttons to select the photo you want to play, and then press the **ENTER** button.
 - The selected file will play and slide show will start.
 - To stop slide show, press the **PAUSE (||)** button.
 - You can view the previous/next file by pressing the ◀▶ buttons during the slideshow mode.

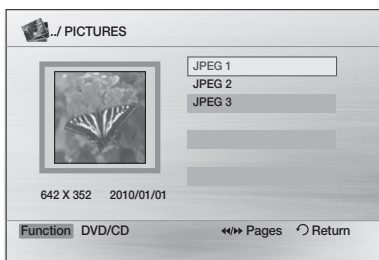

Rotate Function



Press the **GREEN(B)** or **YELLOW(C)** button during the **PAUSE** mode.

- **GREEN(B)** Button: Rotate 90° counterclockwise.
- **YELLOW(C)** Button: Rotate 90° clockwise.

NOTE

- The maximum resolutions supported by this product are 5120 x 3480 (or 19.0 MPixel) for standard JPEG files and 2048 x 1536 (or 3.0 MPixel) for progressive image files.

Using the Playback Function

Forward/Reverse Search



Press the ◀▶ buttons for Search Function.

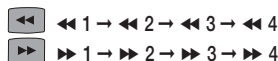

NOTE

- During the fast playback of the CD, sound is only heard at 1 and 2 step speed.
- No sound is heard during the fast playback of the DVD/DivX.

Skipping Scenes/Songs



Press the ◀▶▶▶ buttons.

- Each time the button is pressed during playback, the previous or next chapter, track or directory (file) will be played.
- You cannot skip chapters consecutively.

Slow Motion Play



Press the **PAUSE (||)** button and then ▶▶ button for Slow Motion play.

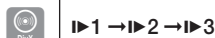
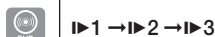

NOTE

- No sound is heard during slow playback.
- Reverse slow playback does not work.

Step Motion Play



Press the **PAUSE** button repeatedly.

- The picture moves forward one frame each time the button is pressed during playback.

NOTE

- No sound is heard during step motion playback.

5 Minute Skip function



During playback, press the ◀▶ button.

- Playback skips 5 minutes forward whenever you press the ▶ button.
- Playback skips 5 minutes backward whenever you press the ◀ button.

NOTE

- You can operate this function only on the DivX.

Using the Disc Menu



You can view the menus for the audio language, subtitle language, profile, etc.

1. During playback, press and hold the **DISC MENU** button on the remote control.
2. Press the ▲▼◀▶ buttons to make the desired selection, then press the **ENTER** button.



NOTE

- Depending on the disc, menu setup items may vary and this menu may not be available.

Using the Title Menu



For DVDs containing multiple titles, you can view the title of each movie.

1. During playback, press the **TITLE** button on the remote control.
2. Press the ▲▼◀▶ buttons to make the desired selection, then press the **ENTER** button.



NOTE

- Depending on the disc, menu setup items may vary and this menu may not be available.

Basic Functions

Repeat Playback



DVD/DivX Repeat

You can repeat the title, chapter or the section (A-B Repeat) of the DVD/DivX.



1. During DVD/DivX playback, press the **REPEAT** button on the remote control.
2. Press the **▲▼** buttons to select a desired repeat mode, then press the **ENTER** button.
3. Press the **▲▼** buttons to select **OFF** to return to normal play, then press the **ENTER** button.



	Title → Chapter → A - → Off
	Track → Dir (Directory) → Disc → Off

CD/MP3 Repeat

1. During the CD/ MP3 playback, press the **REPEAT** button repeatedly to select the repeat mode you want.

	 (Normal → Repeat Track → Repeat All → Random → Repeat Section A-B)
	 (Normal → Repeat Track → Repeat Dir → Repeat All → Random)

A-B Repeat Playback



You can repeatedly play back a designated section of a DVD or CD.

1. During the DVD disc or CD playback, press the **REPEAT** button on the remote control.
2. For DVD, press the **▲▼** buttons to select **A-**. For CD press the **REPEAT** button repeatedly until **A-B** appears.
3. Press the **ENTER** button at the point where you want repeat play to start (A).
4. Press the **ENTER** button at the point where you want repeat play to stop (B).
5. To return to normal playback, For DVD, press the **▲▼** buttons to select to OFF. For CD, press the **REPEAT** button to select to .

NOTE

- The A-B Repeat function does not operate with DivX, MP3 or JPEG discs.

Displaying Disc Information

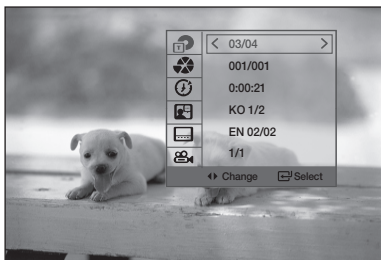

1. During playback, press the **TOOLS** button on the remote control.
2. Press the **▲▼** buttons to select the desired item.
3. Press the **◀▶** buttons to make the desired setup change and then press the **ENTER** button.
 - You may use the number buttons of the remote control to control some items.
4. To make Disc information disappear, press the **TOOLS** button again.



NOTE

- If you are playing contents from the tools menu, some functions may not be enabled depending on the disc.
- You can also select, Dolby Digital or Pro Logic, depending on the disc.
- Some tools menus may differ depending on discs and files.

TOOLS menu

- **Title**(): To access the desired title when there is more than one in the disc. For example, if there is more than one movie on a DVD, each movie will be identified as a Title.
- **Chapter**(): Most DVD discs are recorded in chapters so that you can quickly find a specific chapter.
- **Playing time**(): Allows playback of the film from a desired time. You must enter the starting time as a reference. The time search function does not operate on some discs.

- **Audio**(): Refers to the film's soundtrack language. A DVD Disc can contain up to 8 audio languages.
- **Subtitle**(): Refers to the subtitle languages available in the disc. You will be able to choose the subtitle languages or, if you prefer, turn them off from the screen. A DVD Disc can contain up to 32 subtitle languages.
- **Angle**(): When a DVD contains multiple angles of a particular scene, you can use the Angle function.

Selecting the Audio Language



1. Press the **TOOLS** button.
2. Press the **▲▼** buttons to select **AUDIO** () display.
3. Press the **◀▶** buttons or numeric buttons to select the desired audio language.
 - Depending on the number of languages on a DVD disc, a different audio language is selected each time the button is pressed.

NOTE

- DTS AUDIO doesn't support.

Basic Functions

Selecting the Subtitle Language



1. Press the **TOOLS** button.
2. Press the **▲▼** buttons to select **SUBTITLE** () display.
3. Press the **◀▶** buttons or numeric buttons to select the desired subtitle language.
 - Depending on the number of languages on a DVD disc, a different subtitle language is selected each time the button is pressed.

NOTE

- Depending on the disc, the Subtitle and Audio Language functions may not be available.
- On the DivX file format, the subtitle languages may be represented by only numbers.

Caption Function



- You must have some experience with video extraction and editing in order to use this feature properly.
- To use the caption function, save the caption file (*.smi) in the same file name as that of the DivX media file (*.avi) within the same folder.
Example. Root Samsung_007CD1.avi
 Samsung_007CD1.smi
- Up to 60 alphanumeric characters or 30 East Asian characters (2 byte characters such as Korean and Chinese) for the file name.
- The subtitle of DivX files are *.smi, *.sub, *.srt over 148 kbyte is not supported.

Angle Function



This function allows you to view the same scene in different angles.

1. Press the **TOOLS** button.
2. Press the **▲▼** buttons to select **ANGLE** () display.
3. Press the **◀▶** buttons or numeric buttons to select the desired angle.

NOTE

- The Angle function works only with discs on which multiple angles have been recorded.

Sound Mode

DSP (Digital Signal Processor)/EQ

- DSP (Digital Signal Processor) : DSP modes have been designed to simulate different acoustic environments.
- EQ : You can select ROCK, POP, or CLASSIC etc. to optimize the sound for the genre of music you are playing.

Press the **DSP/EQ** button.



POPS, JAZZ, ROCK	Select POPS, JAZZ, or ROCK, depending on the genre of music you're listening to.
STUDIO	Provides a sense of presence as if in a studio.
CLUB	Simulates the sound of a dance club with a throbbing bass beat.
HALL	Provides a clear vocal as if listening in a concert hall.
MOVIE	Provides the feeling of a movie cinema.
CHURCH	Provides the feeling of being in a grand church.
PASS	Select this for normal listening.

Dolby Pro Logic II Mode

You can select the desired Dolby Pro Logic II audio mode, P.Bass or MP3 Enhancement function.

Press the  **PL II** button.



MUSIC	When listening to music, you can experience sound effects as if you are listening to the actual performance.
CINEMA	Adds realism to the movie soundtrack.
PROLOG	You will experience a realistic multi-channel effect while using just the front left and right speakers.
MATRIX	You will hear multi-channel surround sound.
STEREO	Select this to listen to sound from the front left and right speakers and the subwoofer only.
MP3ENH	You can upscale your MP3 level sound (24 kHz, 8bit) to CD level sound (44.1 kHz, 16bit). The MP3 Enhancement function is only available MP3 file.
POWER BASS ON	This function stresses low tones providing thudding sound effects.
POWER BASS OFF	POWER BASS is turned off.

NOTE

- When selecting Pro Logic II mode, connect your external device to the AUDIO INPUT jacks (L and R) on the product. If you connect to only one of the inputs (L or R), you cannot listen to surround sound.
- The Pro Logic II function is only available in Stereo mode.
- The P.BASS function is only available with 2 channel LPCM sources such as MP3, Divx, CD and WMA.

Basic Functions

Listening to Radio

Using buttons on the Remote Control

1. Press the **FUNCTION** button to select **FM**.
2. Tune in to the desired station.
 - **Automatic Tuning 1** : When the **◀▶** buttons is pressed, a preset broadcast station is selected
 - **Automatic Tuning 2** : Press and hold the **TUNING (Λ, V)** buttons to automatically search for active broadcasting stations.
 - **Manual Tuning** : Press the **TUNING (Λ, V)** buttons to increase or decrease the frequency incrementally.

Using buttons on the product

1. Press the **FUNCTION (●)** button to select **FM**.
2. Select a broadcast station.
 - **Automatic Tuning 1** : Press the **STOP (■)** button to select **PRESET** and then press the **◀▶** buttons to select the preset station.
 - **Automatic Tuning 2** : Press the **STOP (■)** button to select **MANUAL** and then press and hold the **◀▶** buttons to automatically search the band.
 - **Manual Tuning** : Press the **STOP (■)** button to select **MANUAL** and then press the **◀▶** buttons to tune in to a lower or higher frequency.

Setting Mono/Stereo

Press the **MO/ST** button.

- Each time the button is pressed, the sound switches between **STEREO** and **MONO**.
- In a poor reception area, select **MONO** for a clear, interference-free broadcast.



Presetting Stations

Example : Presetting FM 89.10 in the memory

1. Press the **FUNCTION** button to select **FM**.
2. Press the **TUNING (Λ, V)** buttons to select <89.10>.
3. Press the **TUNER MEMORY** button.
 - Number flashes on the display.
4. Press the **◀▶** buttons to select preset number.
 - You can select between 1 and 15 presets.
5. Press the **TUNER MEMORY** button again.
 - Press the **TUNER MEMORY** button before number disappears from the display.
 - Number disappears from the display and the station is stored in memory.
6. To preset another station, repeat steps 2 to 5.
 - To tune in to a preset station, press the **◀▶** buttons on the remote control to select a channel.



Connecting Microphone

You can enjoy the feeling of a karaoke bar in the comfort of your home.

Watch the video and sing along the lyrics displayed on the TV screen against the accompaniment.

1. Connect the microphone to the **MIC** jack on the front panel.
2. Press the **ECHO** button to adjust the echo level of the microphone.



3. Press the **MIC VOL** button to adjust the voice volume of the microphone.

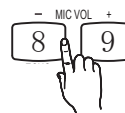

USB Function

Playing Media Files using the USB Host Feature

You can enjoy media files such as pictures, movies and music saved on an MP3 player, USB memory stick or digital camera in high quality video with 5.1 channel sound by connecting the storage device to the USB port of the product.

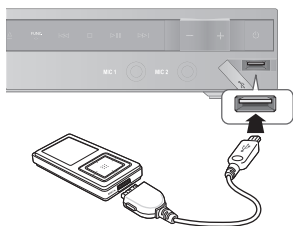

1. Connect the USB device to the USB port on the front panel of the product.
2. Press the **FUNCTION** button to select USB.
 - **USB** appears on the display screen and then disappears.
3. Press the **◀▶** buttons to select **Videos, Music** or **Photo**.
 - Select a file to play.

Safe USB Removal

To prevent damage to the memory stored in the USB device, perform safe removal before disconnecting the USB cable.

- Press the **YELLOW(C)** button.
 - **REMOVE** will appear on the display.
- Remove the USB cable.

NOTE

- To listen to your music files with 5.1 channel sound, you must set the Dolby Pro Logic II mode to Matrix. (See page 31)
- Remove the USB cable from the USB port slowly. Otherwise, it may cause damage to the USB port.

CD Ripping



Converts audio sound of the CD into a MP3 file format before sending to a USB storage device.

1. Connect the USB device to your product.
2. Insert the audio CD into the CD tray.
3. Press the **CD RIPPING** button.
 - To start ripping the current track, press the **CD RIPPING** button on the remote control while the system is playing a track or stopped temporarily.
 - To rip the entire CD, press and hold the **CD RIPPING** button on the remote control.
 - "FULL CD RIPPING" appears on the display and ripping starts.
4. Press the **STOP** (■) button to stop ripping.
 - When the CD ripping is done, a directory named "RIPPING" will be created in the USB device and the ripped file will be saved in a format of "SAM-XXXX".MP3".



NOTE

- Do not disconnect the USB connection or the power cable during the CD ripping. Otherwise, it may cause damage to the data. To stop CD ripping, press the STOP button and disconnect the USB device after the system stops playing the CD completely.
- If you disconnect the USB connection during the CD ripping, the system will turn off and you will not be able to delete the ripped file.
- If you connect the USB device to the system while it is playing a CD, the system stops temporarily and will play again.
- DTS-CDs cannot be ripped.
- If the ripping duration is less than 5 seconds, a ripping file may not be created.
- CD ripping works only if the USB device or the HDD is formatted in the FAT file system. (The NTFS file system is not supported.)
For a list of compliant devices, refer to the specification of the USB host.
- The ripping is performed at a normal speed of x3. The ripping time may be longer with some USB devices.
- While the system is ripping a CD, the audio sound will not be output.
- Do not put touch or move the system while it is ripping a CD.

Other Information

Troubleshooting

Refer to the chart below when this product does not function properly. If the problem you are experiencing is not listed below or if the instruction below does not help, turn off the product, disconnect the power cord, and contact the nearest authorized dealer or Samsung Electronics Service Centre.

Symptom	Check/Remedy
I cannot eject the disc.	<ul style="list-style-type: none"> • Is the power cord plugged securely into the outlet? • Turn off the power and then turn it back on.
Playback does not start.	<ul style="list-style-type: none"> • Check the region number of the DVD. DVD discs purchased from abroad may not be playable. • CD-ROMs and DVD-ROMs cannot be played on this product. • Make sure that the rating level is correct.
Playback does not start immediately when the Play/Pause button is pressed.	<ul style="list-style-type: none"> • Are you using a deformed disc or a disc with scratches on the surface? • Wipe the disc clean.
Sound is not produced.	<ul style="list-style-type: none"> • No sound is heard during fast playback, slow playback, and step motion playback. • Are the speakers connected properly? Is the speaker setup correctly customized? • Is the disc severely damaged?
Sound can be heard only from a few speakers and not all 6.	<ul style="list-style-type: none"> • On certain DVD discs, sound is output from the front speakers only. • Check if the speakers are connected properly. • Adjust the volume. • When listening to a CD, radio or TV, sound is output to the front speakers only. Select "PROLOG" by pressing  PL II (Dolby Pro Logic II) on the remote control to use all six speakers.
Dolby Digital 5.1 CH Surround Sound is not produced.	<ul style="list-style-type: none"> • Is there "Dolby Digital 5.1 CH" mark on the disc? Dolby Digital 5.1 CH Surround Sound is produced only if the disc is recorded with 5.1 channel sound. • Is the audio language correctly set to Dolby Digital 5.1-CH in the information display?
The remote control does not work.	<ul style="list-style-type: none"> • Is the remote control being operated within its operation range of angle and distance? • Are the batteries drained? • Have you selected the mode (DVD RECEIVER/TV) functions of the remote control (DVD RECEIVER/TV) correctly?
<ul style="list-style-type: none"> • Disc is rotating but no picture is produced. • Picture quality is poor and picture is shaking. 	<ul style="list-style-type: none"> • Is the TV power on? • Are the video cables connected properly? • Is the disc dirty or damaged? • A poorly manufactured disc may not be playable.
Audio language and subtitles do not work.	<ul style="list-style-type: none"> • Audio language and subtitles will not work if the disc does not contain them.
The Disc/Title menu screen does not appear even when the Disc/Title function is selected.	<ul style="list-style-type: none"> • Are you using a disc that does not contain menus?
Aspect ratio cannot be changed.	<ul style="list-style-type: none"> • You can play 16:9 DVDs in 16:9 WIDE mode, 4:3 LETTER BOX mode, or 4:3 PAN SCAN mode, but 4:3 DVDs can be seen in 4:3 ratio only. Refer to the DVD disc jacket and then select the appropriate function.

Symptom	Check/Remedy
<ul style="list-style-type: none"> The product is not working. (Example: The power goes out or the front panel key doesn't work or a strange noise is heard.) The product is not working normally. 	<ul style="list-style-type: none"> Press and hold the STOP (■) button on the remote control for longer than 5 seconds with no disc (reset function). <p>Using the RESET function will erase all stored settings. Do not use this unless necessary.</p>
The rating level password has been forgotten.	<ul style="list-style-type: none"> While "NO DISC" message appears on the display of the product, press and hold the remote control's STOP (■) button for longer than 5 seconds. "INIT" appears on the display and all settings will return to the default values. And then press the POWER button. <p>Using the RESET function will erase all stored settings. Do not use this unless necessary.</p>
Can't receive radio broadcast.	<ul style="list-style-type: none"> Is the antenna connected properly? If the antenna's input signal is weak, install an external FM antenna in an area with good reception.

Country code list

Enter the appropriate code number for OTHERS in the Disc Menu, Audio and Subtitle. (See page 24).

Code	Language	Code	Language	Code	Language	Code	Language	Code	Language	Code	Language
1027	Afar	1142	Greek	1239	Interlingue	1345	Malagasy	1482	Kirundi	1527	Tajik
1028	Abkhazian	1144	English	1245	Inupiak	1347	Maori	1483	Romanian	1528	Thai
1032	Afrikaans	1145	Esperanto	1248	Indonesian	1349	Macedonian	1489	Russian	1529	Tigrinya
1039	Amharic	1149	Spanish	1253	Icelandic	1350	Malayalam	1491	Kinyarwanda	1531	Turkmen
1044	Arabic	1150	Estonian	1254	Italian	1352	Mongolian	1495	Sanskrit	1532	Tagalog
1045	Assamese	1151	Basque	1257	Hebrew	1353	Moldavian	1498	Sindhi	1534	Setswana
1051	Aymara	1157	Persian	1261	Japanese	1356	Marathi	1501	Sangro	1535	Tonga
1052	Azerbaijani	1165	Finnish	1269	Yiddish	1357	Malay	1502	Serbo-Croatian	1538	Turkish
1053	Bashkir	1166	Fiji	1283	Javanese	1358	Maltese	1503	Singhalese	1539	Tsonga
1057	Byelorussian	1171	Faeroese	1287	Georgian	1363	Burmese	1505	Slovak	1540	Tatar
1059	Bulgarian	1174	French	1297	Kazakh	1365	Nauru	1506	Slovenian	1543	Twi
1060	Bihari	1181	Frisian	1298	Greenlandic	1369	Nepali	1507	Samoan	1557	Ukrainian
1069	Bislama	1183	Irish	1299	Cambodian	1376	Dutch	1508	Shona	1564	Urdu
1066	Bengali, Bangla	1186	Scots Gaelic	1300	Canada	1379	Norwegian	1509	Somali	1572	Uzbek
1067	Tibetan	1194	Galician	1301	Korean	1393	Occitan	1511	Albanian	1581	Vietnamese
1070	Breton	1196	Guarani	1305	Kashmiri	1403	(Afan) Oromo	1512	Serbian	1587	Volapuk
1079	Catalan	1203	Gujarati	1307	Kurdish	1408	Oriya	1513	Siswati	1613	Wolof
1093	Corsican	1209	Hausa	1311	Kirghiz	1417	Punjabi	1514	Sesotho	1632	Xhosa
1097	Czech	1217	Hindi	1313	Latin	1428	Polish	1515	Sundanese	1665	Yoruba
1103	Welsh	1226	Croatian	1326	Lingala	1435	Pashto, Pushto	1516	Swedish	1684	Chinese
1105	Danish	1229	Hungarian	1327	Laotian	1436	Portuguese	1517	Swahili	1697	Zulu
1109	German	1233	Armenian	1332	Lithuanian	1463	Quechua	1521	Tamil		
1130	Bhutani	1235	Interlingua	1334	Latvian, Lettish	1481	Rhaeto-Romance	1525	Tegulu		

Specifications

General	Weight	2.6 Kg		
	Dimensions	430.0 (W) x 60.0 (H) x 290.0 (D) mm		
	Operating Temperature Range	+5°C~+35°C		
	Operating Humidity Range	10 % to 75 %		
FM Tuner	Signal/noise ratio	70 dB		
	Usable sensitivity	10 dB		
	Total harmonic distortion	0.5 %		
Disc	DVD (Digital Versatile Disc)	Reading Speed : 3.49 ~ 4.06 m/sec. Approx. Play Time (Single Sided, Single Layer Disc) : 135 min.		
	CD : 12 cm (COMPACT DISC)	Reading Speed : 4.8 ~ 5.6 m/sec. Maximum Play Time : 74 min.		
	CD : 8cm (COMPACT DISC)	Reading Speed : 4.8 ~ 5.6 m/sec. Maximum Play Time : 20 min.		
Video Output	Composite Video	480i(576i) 1 channel : 1.0 Vp-p (75 Ω load)		
	Component Video	480i(576i) Y : 1.0 Vp-p (75 Ω load) Pr : 0.70 Vp-p (75 Ω load) Pb : 0.70 Vp-p (75 Ω load)		
Amplifier	Front speaker output	55W x 2(3Ω)		
	Centre speaker output	55W(3Ω)		
	Rear speaker output	55W x 2(3Ω)		
	Subwoofer output	55W(3Ω)		
	Frequency range	20Hz~20KHz		
	S/N Ratio	70dB		
	Channel separation	60dB		
	Input sensitivity	(AUX)400mV		
Speaker	Speaker system	5.1ch speaker system		
		Front/Rear	Centre	Subwoofer
	Impedance	3 Ω	3 Ω	3 Ω
	Frequency range	140Hz~20KHz	140Hz~20KHz	40Hz~160Hz
	Output sound pressure level	86dB/W/M	86dB/W/M	88dB/W/M
	Rated input	55W	55W	55W
	Maximum input	110W	110W	110W
	Dimensions (W x H x D)	Front/Rear : 84 x 104.5 x 68.5 mm Centre : 84 x 104.5 x 68.5 mm Subwoofer : 155 x 350 x 285 mm		
Weights	Front/Rear : 0.4 Kg, Centre : 0.4 Kg Subwoofer : 3.8 Kg			

*: Nominal specification

- Samsung Electronics Co., Ltd reserves the right to change the specifications without notice.
- Weight and dimensions are approximate.
- Design and specifications are subject to change without prior notice.
- For the power supply and Power Consumption, refer to the label attached to the product.

Contact SAMSUNG WORLD WIDE

If you have any questions or comments relating to Samsung products, please contact the SAMSUNG customer care centre.

Area	Contact Center ☎	Web Site
■ North America		
Canada	1-800-SAMSUNG (726-7864)	www.samsung.com
Mexico	01-800-SAMSUNG (726-7864)	www.samsung.com
U.S.A	1-800-SAMSUNG (726-7864)	www.samsung.com
■ Latin America		
Argentina	0800-333-3733	www.samsung.com
Brazil	0800-124-421 4004-0000	www.samsung.com
Chile	800-SAMSUNG (726-7864)	www.samsung.com
Nicaragua	00-1800-5077267	www.samsung.com
Honduras	800-7919267	www.samsung.com
Costa Rica	0-800-507-7267	www.samsung.com
Ecuador	1-800-10-7267	www.samsung.com
El Salvador	800-6225	www.samsung.com
Guatemala	1-800-299-0013	www.samsung.com
Jamaica	1-800-234-7267	www.samsung.com
Panama	800-7267	www.samsung.com
Puerto Rico	1-800-682-3180	www.samsung.com
Rep. Dominica	1-800-751-2676	www.samsung.com
Trinidad & Tobago	1-800-SAMSUNG (726-7864)	www.samsung.com
Venezuela	0-800-100-5303	www.samsung.com
Colombia	01-8000112112	www.samsung.com
■ Europe		
Austria	0810 - SAMSUNG (7267864, € 0.07/min)	www.samsung.com
Belgium	02-201-24-18	www.samsung.com/ be (Dutch) www.samsung.com/ be_fr (French)
Czech	800 - SAMSUNG (800-726786)	www.samsung.com
Denmark	70 70 19 70	www.samsung.com
Finland	030 - 6227 515	www.samsung.com
France	01 48 63 00 00	www.samsung.com
Germany	01805 - SAMSUNG (726-7864 € 0,14/Min)	www.samsung.com
Hungary	06-80-SAMSUNG (726-7864)	www.samsung.com
Italia	800-SAMSUNG (726-7864)	www.samsung.com
Luxemburg	261 03 710	www.samsung.com
Netherlands	0900-SAMSUNG (0900-7267864) (€ 0,10/Min)	www.samsung.com
Norway	815-56 480	www.samsung.com
Poland	0 801 1SAMSUNG (172678) 022-607-93-33	www.samsung.com
Portugal	80820-SAMSUNG (726-7864)	www.samsung.com
Slovakia	0800-SAMSUNG (726-7864)	www.samsung.com
Spain	902 - 1 - SAMSUNG (902 172 678)	www.samsung.com
Sweden	0771 726 7864 (SAMSUNG)	www.samsung.com
U.K	0845 SAMSUNG (7267864)	www.samsung.com
Eire	0818 717100	www.samsung.com

Area	Contact Center ☎	Web Site
Switzerland	0848 - SAMSUNG (7267864, CHF 0.08/min)	www.samsung.com/ch www.samsung.com/ ch_fr/ (French)
Lithuania	8-800-77777	www.samsung.com
Latvia	8000-7267	www.samsung.com
Estonia	800-7267	www.samsung.com
■ CIS		
Russia	8-800-555-55-55	www.samsung.com
Georgia	8-800-555-555	
Armenia	0-800-05-555	
Azerbaijan	088-55-55-555	
Kazakhstan	8-10-800-500-55-500	
Uzbekistan	8-10-800-500-55-500	www.samsung.com
Kyrgyzstan	00-800-500-55-500	www.samsung.com
Tadjikistan	8-10-800-500-55-500	www.samsung.com
Ukraine	0-800-502-000	www.samsung.ua www.samsung.com/ ua_ru
Belarus	810-800-500-55-500	
Moldova	00-800-500-55-500	
■ Asia Pacific		
Australia	1300 362 603	www.samsung.com
New Zealand	0800 SAMSUNG (0800 726 786)	www.samsung.com
China	400-810-5858 010-6475 1880	www.samsung.com
Hong Kong	(852) 3698-4698	www.samsung.com/ hk www.samsung.com/ hk_en/
India	3030 8282 1800 110011 1800 3000 8282 1800 266 8282	www.samsung.com
Indonesia	0800-112-8888 021-5699-7777	www.samsung.com
Japan	0120-327-527	www.samsung.com
Malaysia	1800-88-9999	www.samsung.com
Philippines	1-800-10-SAMSUNG (726-7864) 1-800-3-SAMSUNG (726-7864) 1-800-8-SAMSUNG (726-7864) 02-5805777	www.samsung.com
Singapore	1800-SAMSUNG (726-7864)	www.samsung.com
Thailand	1800-29-3232 02-689-3232	www.samsung.com
Taiwan	0800-329-999	www.samsung.com
Vietnam	1 800 588 889	www.samsung.com
■ Middle East & Africa		
Turkey	444 77 11	www.samsung.com
South Africa	0860-SAMSUNG (726-7864)	www.samsung.com
U.A.E	800-SAMSUNG (726-7864)	www.samsung.com
Bahrain	8000-4726	
Jordan	800-22273	



AH68-02254K

Free Manuals Download Website

<http://myh66.com>

<http://usermanuals.us>

<http://www.somanuals.com>

<http://www.4manuals.cc>

<http://www.manual-lib.com>

<http://www.404manual.com>

<http://www.luxmanual.com>

<http://aubethermostatmanual.com>

Golf course search by state

<http://golfingnear.com>

Email search by domain

<http://emailbydomain.com>

Auto manuals search

<http://auto.somanuals.com>

TV manuals search

<http://tv.somanuals.com>