

**CFTD2785  
CFTD2085**

**3WAY COMBINATION UNIT**

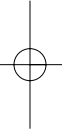

**Owner's  
Instructions**



AA68-03265A-00

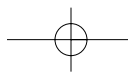

# CONTENTS

<b>Chapter 1: Your New 3Way Combination Unit</b>	<b>1.1</b>
List of Features	1.1
Familiarizing Yourself with The 3way Combination Unit	1.2
Front Panel Buttons	1.2
Front/Side Panel Jacks	1.3
Rear Panel Jacks	1.4
Remote Control (TV Function Buttons)	1.5
Remote Control (DVD Function Buttons)	1.6
Remote Control (VCR Function Buttons)	1.7
<b>Chapter 2: Installation</b>	<b>2.1</b>
Connecting VHF and UHF Antennas	2.1
Antennas with 300-ohm Flat Twin Leads	2.1
Antennas with 75-ohm Round Leads	2.1
Separate VHF and UHF Antennas	2.2
Connecting Cable TV	2.2
Cable without a Cable Box	2.2
Connecting to a Cable Box that Descrambles All Channels	2.2
Connecting to a Cable Box that Descrambles some Channels	2.3
Connecting a Second VCR to Record from the TV	2.4
Connecting a Camcorder	2.5
Connecting an Audio System	2.6
Installing Batteries in the Remote Control	2.7
<b>Chapter 3: TV Operation</b>	<b>3.1</b>
Turning the TV On and Off	3.1
Viewing the Menus and On-Screen Displays	3.1
Viewing the Menus	3.1
Viewing the Display	3.1
Selecting a Menu Language	3.2
Memorizing the Channels	3.3
Selecting the Video Signal-source	3.3
Storing Channels in Memory (Automatic Method)	3.4
Adding and Erasing Channels (Manual Method)	3.5
Changing Channels	3.6
Using the Channel Buttons	3.6
Directly Accessing Channels	3.6
Using the Pre-CH Button to select the Previous Channel	3.6
Adjusting the Volume	3.7
Using Mute	3.7
Setting the Clock	3.8
Customizing the Picture	3.9
Changing the Color Tone	3.10
Changing the Screen Size	3.11
Fine Tuning Channels	3.12
Digital Noise Reduction	3.13
Tilt	3.14
Customizing the Sound	3.15
Using Automatic Sound Settings	3.16
Choosing a Multi-Channel Soundtrack (MTS)	3.17
Viewing a VCR or Camcorder Tape	3.18
Setting the Clock	3.19
Setting the On/Off Timer	3.23
Setting the Sleep Timer	3.25
Viewing Closed Captions	3.26
Using the V-Chip	3.27
Setting Up Your Personal ID Number (PIN)	3.27
How to Enable/Disable the V-Chip	3.28
How to Set up Restrictions Using the "TV guidelines"	3.28
How to Set up Restrictions using the MPAA Ratings:	
G, PG, PG-13, R, NC-17, X	330
How to Reset the TV after the V-Chip Blocks a Channel ("Emergency Escape")	3.31
<b>Chapter 4: DVD Operation</b>	<b>4.1</b>
Playing a Disc	4.1
Playback	4.1
Stopping Playback	4.1
Removing Disc	4.1
Pausing Playback	4.1
Step Motion Playback (Except CD)	4.2
Slow Motion Playback (Except CD)	4.2

# CONTENTS

<b>Chapter 4: DVD Operation (Cont.)</b> . . . . .	<b>4.3</b>
Using the Search and Skip Functions . . . . .	4.3
Searching through a Chapter or Track . . . . .	4.3
Skipping Tracks . . . . .	4.3
Using the Display Function . . . . .	4.4
When Playing a MP3/WMA . . . . .	4.4
When Playing a MPG . . . . .	4.6
When Playing a Picture CD . . . . .	4.7
Using the Disc Menu . . . . .	4.9
Using the Title Menu . . . . .	4.9
Displaying the Disc Information . . . . .	4.10
Using the Zoom Function (DVD/VCD) . . . . .	4.12
Using the Bookmark Function (DVD/VCD) . . . . .	4.13
Recalling a Marked Scene . . . . .	4.14
Clearing a Bookmark . . . . .	4.14
Repeat Play . . . . .	4.15
Using the EZ View . . . . .	4.17
Program Play (CD) . . . . .	4.18
Program Playback . . . . .	4.18
Changing the Camera Angle . . . . .	4.19
Setting up the Language Features . . . . .	4.20
Setting up the Audio Options . . . . .	4.21
Setting up the TV Aspect . . . . .	4.22
Setting up the Display Options . . . . .	4.23
Setting up the Parental Control . . . . .	4.24
 <b>Chapter 5: VCR Operation</b> . . . . .	 <b>5.1</b>
Inserting and Ejecting a Video Cassette Tape . . . . .	5.1
Playing a Pre-Recorded Video Cassette Tape . . . . .	5.2
Playing the Tape . . . . .	5.2
Pausing . . . . .	5.2
Using Picture Search . . . . .	5.3
Using Automatic Tracking . . . . .	5.3
Using the Time Counter . . . . .	5.4
Using Memory Stop . . . . .	5.5
Using PPLUS . . . . .	5.6
Recording TV Programs As You Watch . . . . .	5.7
Recording . . . . .	5.7
Editing While Recording . . . . .	5.8
Using Advanced Recording Features . . . . .	5.9
Using One-Touch Recording . . . . .	5.9
Recording at a Later Time . . . . .	5.10
Using Program Review . . . . .	5.13
Using True Repeat . . . . .	5.14
Using Block Repeat . . . . .	5.15
MTS (Multi-Channel Television sound) System . . . . .	5.16
Selecting the MTS System . . . . .	5.16
MTS Recording/Monitor Mode . . . . .	5.16
Video Dubbing . . . . .	5.17
Making the Connections . . . . .	5.17
Video Dubbing . . . . .	5.18
Using Special Playback Features . . . . .	5.19
Frame Advance . . . . .	5.19
Slow motion . . . . .	5.19
 <b>Chapter 6: Troubleshooting</b> . . . . .	 <b>6.1</b>
Identifying TV Problems . . . . .	6.1
Identifying DVD Problems . . . . .	6.2
Identifying VCR Problems . . . . .	6.3
 <b>Appendix</b> . . . . .	 <b>A.1</b>
Cleaning and Maintaining Your 3Way Combination Unit . . . . .	A.1
Using Your 3Way Combination Unit in Another Country . . . . .	A.1
Learning About Video Cassette Tapes . . . . .	A.2
Sending Tapes to Another Country . . . . .	A.3
Specifications . . . . .	A.3

# Chapter One

## YOUR NEW 3WAY COMBINATION UNIT

### List of Features

Your 3way Combination Unit was designed with the latest technology. This 3way Combination Unit is a high-performance unit that includes the following special features:

#### TV Features

- Full Flat screen
- Automatic timer to turn the 3way Combination Unit on and off
- Adjustable picture and sound settings that can be stored in the 3way Combination Unit's memory
- Automatic channel tuning for up to 181 channels
- A special filter to reduce or eliminate reception problems
- Fine tuning control for the sharpest picture possible
- A built-in multi-channel sound decoder for stereo and bilingual listening
- Built-in, dual channel speakers
- A special sleep timer
- V-chip function

#### DVD Features

- DTS digital output for DTS-enhanced DVDs
- Playback MP3, JPG, WMA, MPG files from CD-ROM

#### Discs which cannot be played with this player.

- |                              |  |
|------------------------------|--|
| • DVD-ROM                    | • CDGs play audio only,<br>not graphics. |
| • CD-ROM                     |  |
| • CDI                        | • CDV                                    |
| • HD layer of super Audio CD |  |

#### VCR Features

- Hi-Fi Stereo VCR.
- 4 heads for superior slow motion and stop action
- Playback of S-VHS tapes at better than standard resolution
- Real time counter

**YOUR NEW 3WAY COMBINATION UNIT**

**Familiarizing Yourself with The 3way Combination Unit**

**Front Panel Buttons**

The buttons on the front panel control your 3way Combination Unit's basic features, including the on-screen menu. To use the more advanced features, you must use the remote control.

- CFTD2785

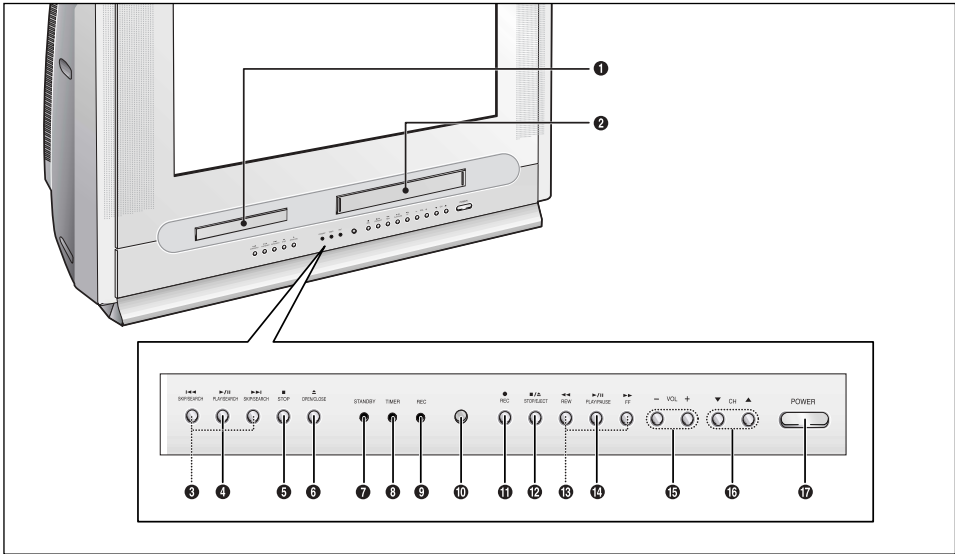

- CFTD2085

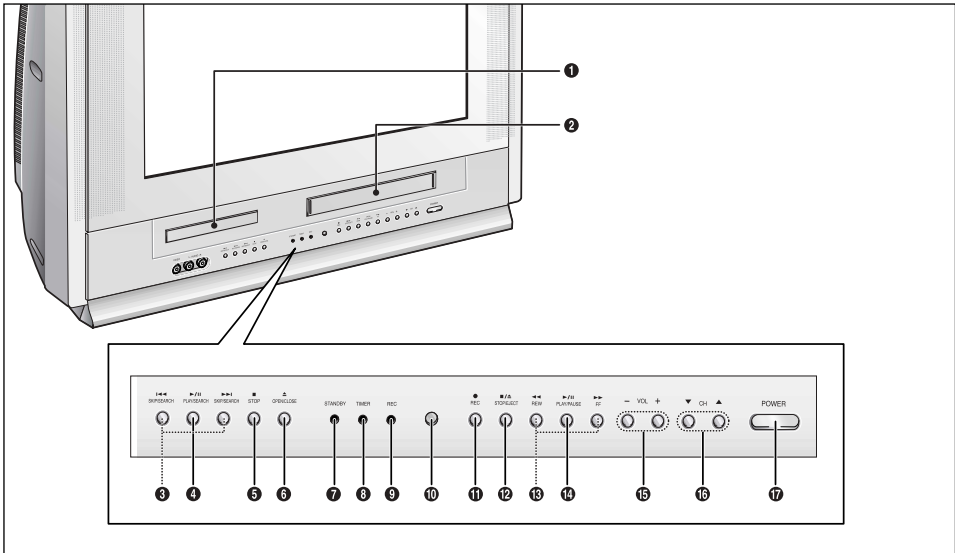

## YOUR NEW 3WAY COMBINATION UNIT

- 1 Disc tray**  
Load the disc here.
- 2 VCR deck**  
Insert a standard VHS video tape.
- 3 SKIP/SEARCH (DVD)**  
Press to skip or search the title, chapter or track.
- 4 PLAY/PAUSE (DVD)**  
Press to play or pause the disc
- 5 STOP (DVD)**  
Press to stop the disc
- 6 OPEN/CLOSE (DVD)**  
Press to open and close the disc tray.
- 7 STAND BY indicator**  
Lit when TV power is Off.
- 8 TIMER indicator**  
Lit when the program times are stored.
- 9 REC indicator**  
Lit when the VCR is recording.
- 10 Remote Control Sensor**  
Aim the remote control towards this spot on the TV.
- 11 REC (VCR)**  
Press to begin recording.
- 12 STOP/EJECT (VCR)**  
Press to stop a video tape during play, record, rewind, or fast forward. Press to eject a video tape if the tape is stopped.
- 13 REW/FF (VCR)**  
Press to rewind/fast forward a videotape.
- 14 PLAY/PAUSE (VCR)**  
Press to play or pause a video tape.
- 15 VOLUME - , +**  
Press to increase or decrease the volume.
- 16 CHANNEL ▼ and ▲**  
Press to change channels.
- 17 POWER**  
Press to turn the TV on and off.

### Front/Side Panel Jacks

You can use the Front/Side panel jacks to connect an A/V component that is used only occasionally, such as a camcorder or video game. (For information on connecting equipment, see pages 2.1 – 2.6.)

#### • CFTD2785

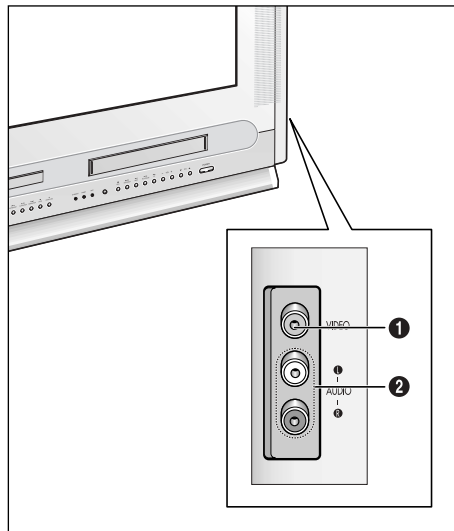

- 1 VIDEO IN jack**  
Used to connect a video signal from a camcorder or video game.

#### • CFTD2085

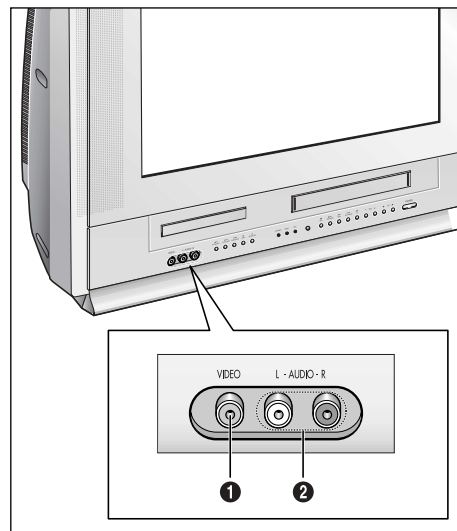

- 2 AUDIO IN jacks**  
Used to connect the audio signals from a camcorder or video game.

## YOUR NEW 3WAY COMBINATION UNIT

### Rear Panel Jacks

Use the rear panel jacks to connect an A/V component that will be connected continuously, such as a VCR or a camcorder.

For more information on connecting equipment, see pages 2.1 – 2.6.

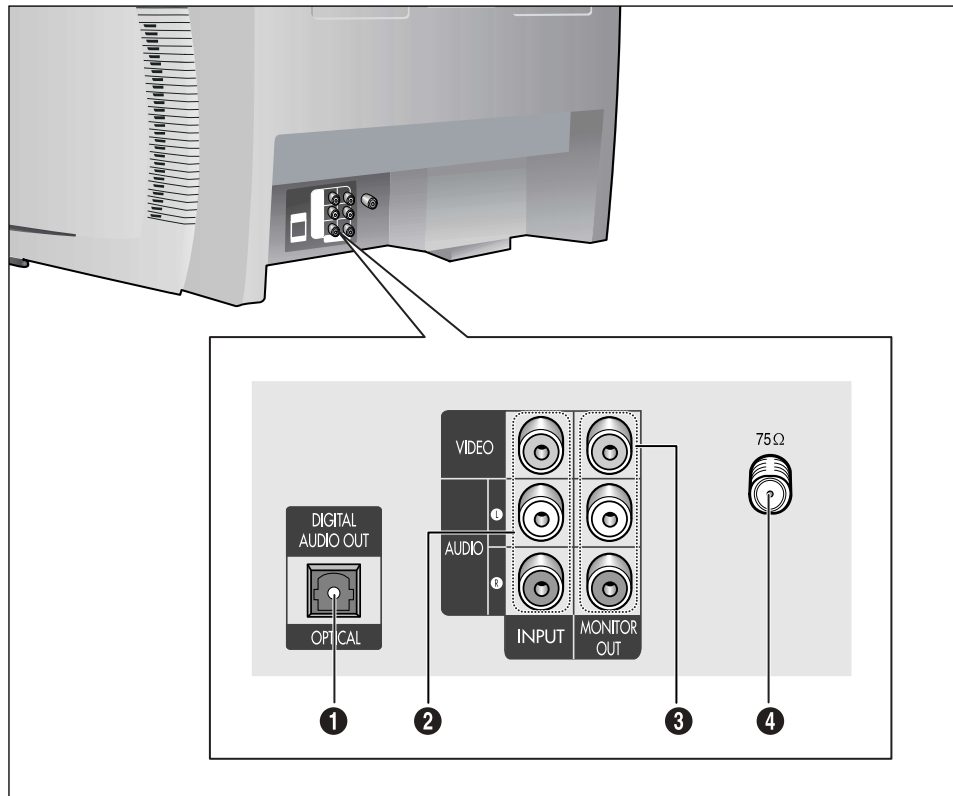

- 1 DIGITAL AUDIO OUTPUT**  
Connect to a compatible dolby digital receiver.
- 2 VIDEO-AUDIO INPUTS**  
Used to connect video-audio signals from VCRs, laserdisc players and similar devices.
- 3 AUDIO-AUDIO MONITOR OUTPUTS**  
Connect to the audio-video input jacks of a recording VCR.
- 4 VHF/UHF**  
Connect to an antenna or to a cable 3way Combination Unit system.

## YOUR NEW 3WAY COMBINATION UNIT

### Remote Control (TV Function Buttons)

You can use the remote control up to about 23 feet from the TV.  
When using the remote, always point it directly at the TV.

#### 1 POWER

Turns the 3way Combination Unit on and off.

#### 2 +100

Press to select channels over 100. For example, to select channel 121, press "+100," then press "2" and "1."

#### 3 MTS (Multichannel Television Stereo)

Press to choose stereo, mono or Separate Audio Program (SAP broadcast).

#### 4 MUTE

Press to temporarily cut off the sound.

#### 5 VOL +, VOL -

Press increase or decrease the volume.

#### 6 S.MODE

Adjust the TV sound by selecting one of the preset factory settings (or select your personal, customized sound settings).

#### 7 MENU

Displays the main on-screen menu.

#### 8 Control the cursor in the menu

Allows move to items.

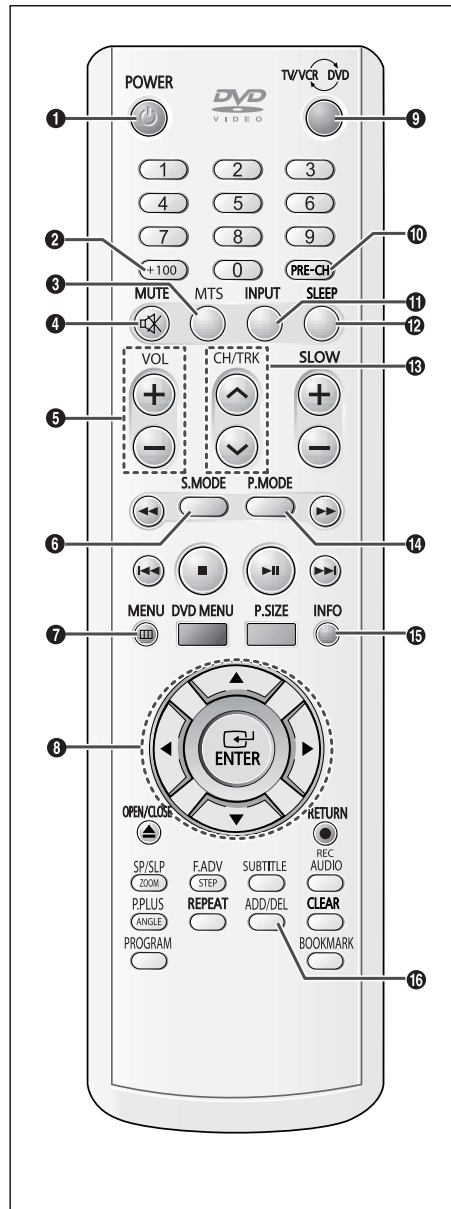

#### 9 TV/VCR $\leftrightarrow$ DVD selection

Press to switch between TV/VCR, and DVD mode.

#### 10 PRE-CH

Tunes to the previous channel.

#### 11 INPUT

Press to watch the TV picture or a picture from a connected component (VCR, camcorder etc...)

#### 12 SLEEP

Press to select a preset time interval for automatic shutoff.

#### 13 CH $\downarrow$ and CH $\uparrow$ (Channel Down/Up)

Press CH  $\downarrow$  or CH  $\uparrow$  to change channels.

#### 14 P.MODE

Adjust the TV picture by selecting one of the preset factory settings (or select your personal, customized picture settings).

#### 15 INFO

Press to see the channel, time, current disc mode, audio/video settings etc., on-screen.

#### 16 ADD/DEL

Press to add or erase channels in the TV's memory.



## YOUR NEW 3WAY COMBINATION UNIT

### Remote Control (DVD Function Buttons)

- 1 Search**  
Press to search forward/backward through a disc.
- 2 Stop**  
Press to stop a disc.
- 3 ENTER**  
Confirms a selection.
- 4 OPEN/CLOSE**  
Press to open or close the disc tray.
- 5 STEP**  
Press to advance play one frame at a time.
- 6 ZOOM**  
Press to zoom-in during playback, slow motion or pause mode on the selected area of a scene.
- 7 ANGLE**  
Press to access various camera angles on a DVD.
- 8 PROGRAM**  
For program play.

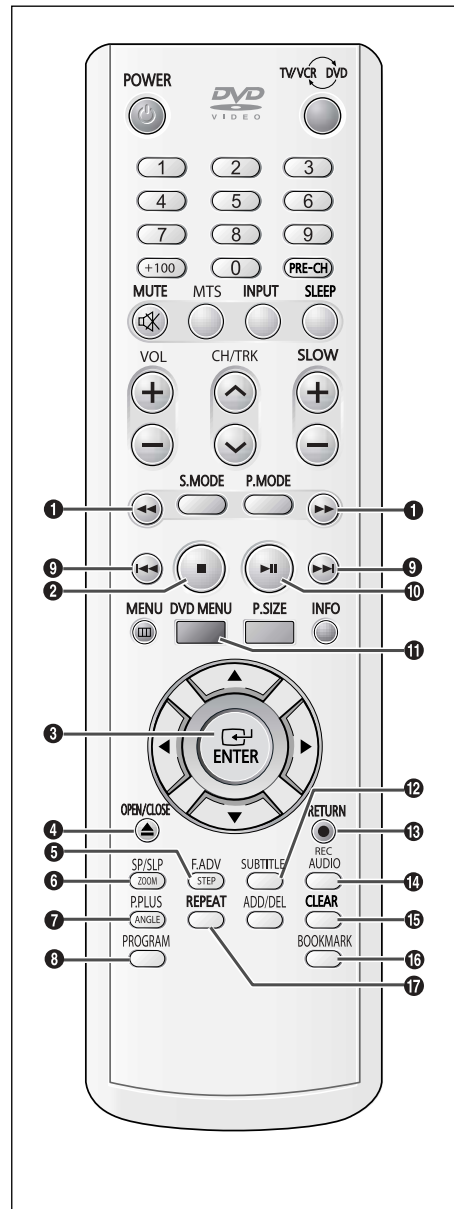

- 9 Skip**  
Press to skip the title, chapter, or track.
- 10 Play/pause**  
Press to play or pause disc play.
- 11 DVD MENU**  
Displays the DVD play's Setup menu.
- 12 SUBTITLE**  
Press to display the subtitle language name abbreviation on-screen.
- 13 RETURN**  
Press to return to a previous menu or exit.
- 14 AUDIO**  
Press to access various audio functions on a disc.
- 15 CLEAR**  
Press to clear on-screen displays.
- 16 BOOKMARK**  
Press to memorize scenes for replay.
- 17 REPEAT**  
Press to repeat play a title, chapter, track, or disc.

## YOUR NEW 3WAY COMBINATION UNIT

### Remote Control (VCR Function Buttons)

- 1 TRK+, - (tracking)**  
Press to adjust tape tracking.
- 2 REW/F.F**  
Press to rewind/fast forward a video tape.
- 3 Stop**  
Press to stop a video tape.
- 4 OPEN/CLOSE**  
Press to eject a tape.
- 5 F.ADV (frame advance)**  
Press to advance a tape frame-by-frame.
- 6 SP/SLP**  
Press to select the tape recording speed.

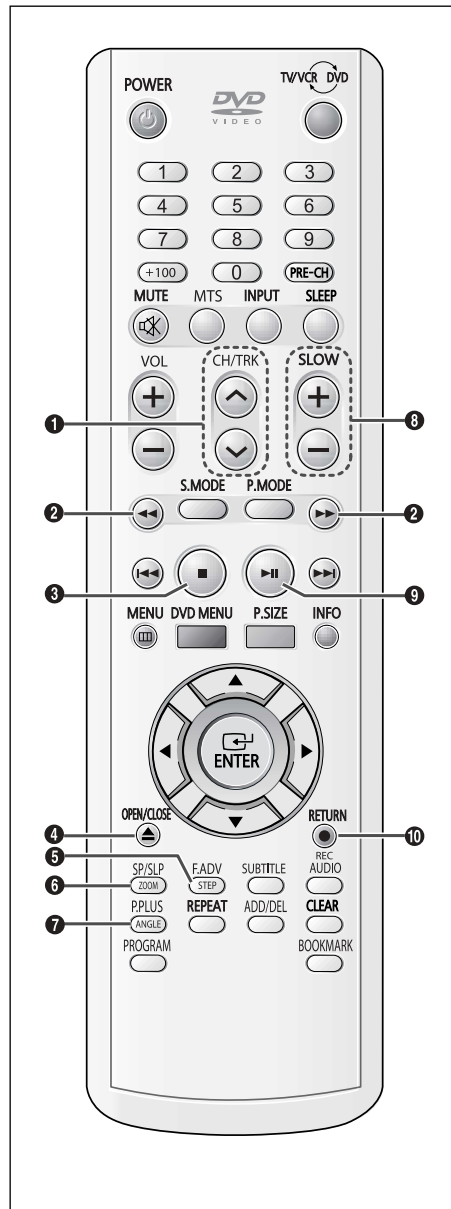

- 7 P.PLUS**  
Press to compensate for a poor rental tape.
- 8 SLOW+, -**  
Press to watch a tape in slow motion.
- 9 Play/pause**  
Press to play or pause a tape.
- 10 REC**  
Press to begin recording.

# Chapter Two

## INSTALLATION

### Connecting VHF and UHF Antennas

If your antenna has a set of leads that look like this, see "Antennas with 300-ohm Flat Twin Leads," below.

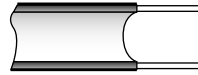

If your antenna has one lead that looks like this, see "Antennas with 75-ohm Round Leads," on page 2.2.

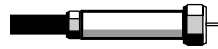

If you have two antennas, see "Separate VHF and UHF Antennas," on page 2.2.

#### Antennas with 300-ohm Flat Twin Leads

If you are using an off-air antenna (such as a roof antenna or "rabbit ears") that has 300-ohm twin flat leads, follow the directions below.

**1**

Place the wires from the twin leads under the screws on the 300-75 ohm adaptor (not supplied). Use a screwdriver to tighten the screws.

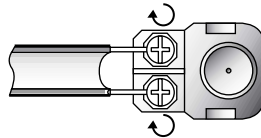

**2**

Plug the adaptor into the VHF/UHF terminal on the bottom of the back panel.

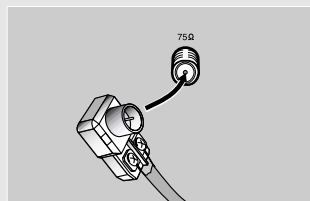

#### Antennas with 75-ohm Round Leads

**1**

Plug the antenna lead into the VHF/UHF terminal on the bottom of the back panel.

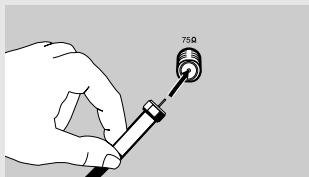

## INSTALLATION

### Separate VHF and UHF Antennas

If you have two separate antennas for your TV (one VHF and one UHF), you must combine the two antenna signals before connecting the antennas to the TV. This procedure requires a an optional combiner-adaptor (available at most electronics shops).

- 1**  
Connect both antenna leads to the combiner.

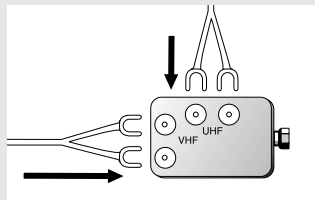

- 2**  
Plug the combiner into the VHF/UHF terminal on the bottom of the rear panel.

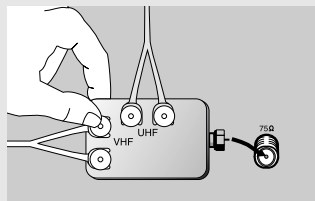

### Connecting Cable TV

To connect to a cable TV system, follow the instructions below.

#### Cable without a Cable Box

- 1**  
Plug the incoming cable into the VHF/UHF antenna terminal on back of the TV.

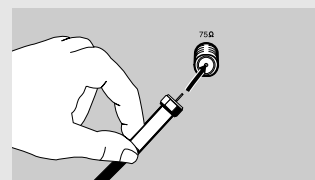

◀ Because this TV is cable-ready, you do not need a cable box to view unscrambled cable channels.

#### Connecting to a Cable Box that Descrambles All Channels

- 1**  
Find the cable that is connected to the ANTENNA OUT terminal on your cable box.

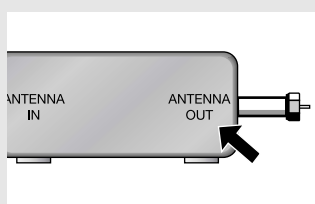

◀ This terminal might be labeled "ANT OUT," "VHF OUT," or simply "OUT."

- 2**  
Connect the other end of this cable to the VHF/UHF antenna terminal on the back of the TV.

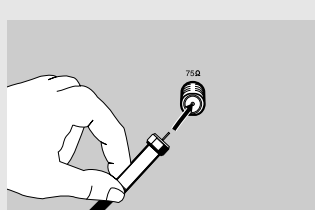

# INSTALLATION

## Connecting to a Cable Box that Descrambles Some Channels

If your cable box descrambles only some channels (such as premium channels), follow the instructions below. You will need a two-way splitter, an RF (A/B) switch, and four lengths of coaxial cable. (These items are available at most electronics stores.)

**1**  
Find and disconnect the cable that is connected to the ANTENNA IN terminal on your cable box.

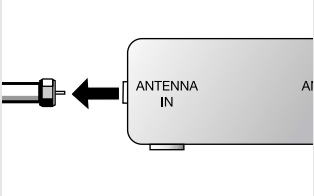

◀ This terminal might be labeled "ANT IN," "VHF IN," or simply "IN."

**2**  
Connect this cable to a two-way splitter.

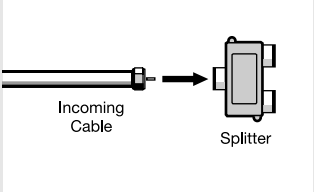

**3**  
Connect a coaxial cable between an OUTPUT terminal on the splitter and the IN terminal on the cable box.

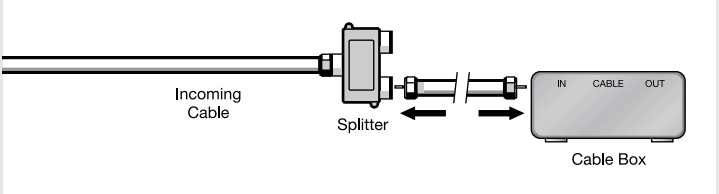

**4**  
Connect a coaxial cable between the ANTENNA OUT terminal on the cable box and the B-IN terminal on the A/B switch.

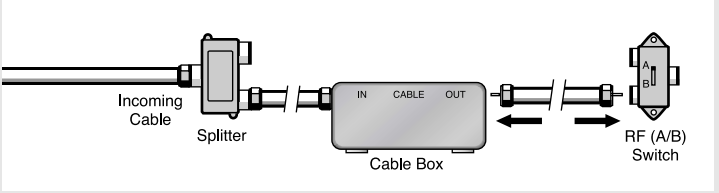

*continued...*

## INSTALLATION

### 5

Connect another cable between the other OUT terminal on the splitter and the A-IN terminal on the RF (A/B) switch.

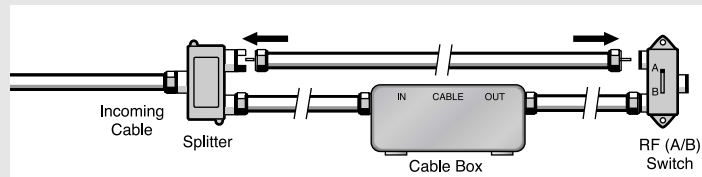

### 6

Connect the last coaxial cable between the OUT terminal on the RF (A/B) switch and the VHF/UHF terminal on the rear of the TV.

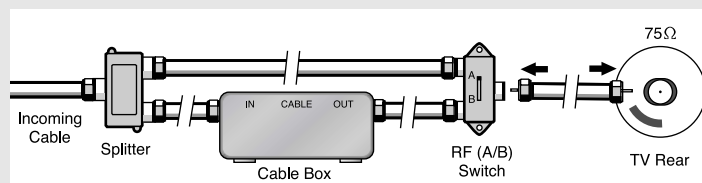

After you've made this connection, set the A/B switch to the "A" position for normal viewing. Set the A/B switch to the "B" position to view scrambled channels. (When you set the A/B switch to "B," you will need to tune your TV to the cable box's output channel, which is usually channel 3 or 4.)

## Connecting a Second VCR to Record from the TV

Your TV can send out signals of its picture and sound to be recorded by a second VCR.

To do this, connect your second VCR as follows:

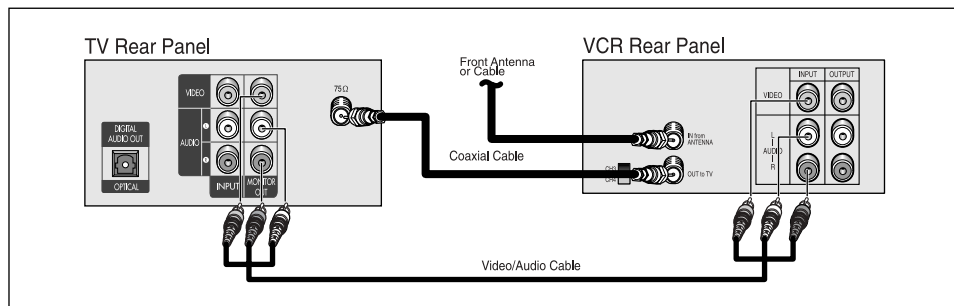

### 1

Connect a coaxial cable between the ANTENNA OUT terminal on the VCR and the antenna terminal on the TV. A coaxial cable is usually included with a VCR. (If not, check your local electronics store).

### 2

Connect a set of audio cables between the VIDEO/AUDIO OUT jacks on the TV and the VIDEO/AUDIO IN jacks on the VCR.

(The VCR input jacks might be either on the front or on back of the VCR.)

If you have a mono VCR, connect L (mono) to VCR audio out using only one audio cable.

Refer to your VCR's instructions for more information about how to record using this kind of connection.

## INSTALLATION

### Connecting a Camcorder

The front/side panel jacks on your TV make it easy to connect a camcorder to your TV. They allow you to view the camcorder tapes without using a VCR. (Also see "Viewing a VCR or Camcorder Tape" on page 3.17)

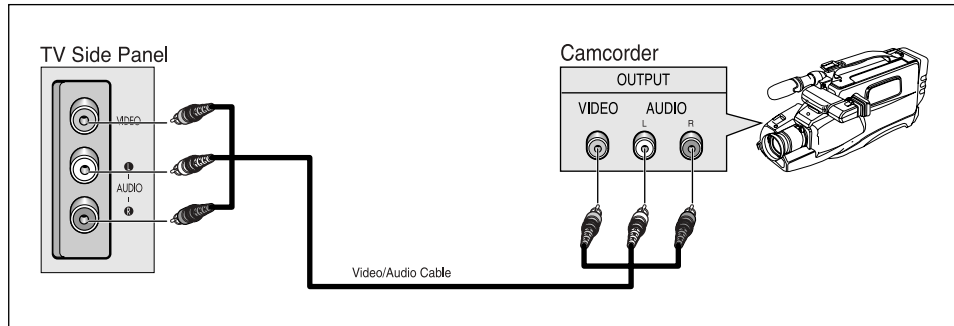

#### 1

Locate the A/V output jacks on the camcorder. They are usually found on the side or rear of the camcorder.

#### 2

Connect an video/audio cable between the VIDEO/AUDIO OUTPUT jack on the camcorder and the VIDEO/AUDIO terminals on the TV.

If you have mono camcorder, connect L(mono) to camcorder audio out using only one audio cable. The audio-video cables shown here are usually included with a Camcorder. (If not, check your local electronics store.) If your camcorder is stereo, you need to connect a set of two cables.

Note: This figure shows the Standard connector-jack panel. The actual configuration for your TV may be different.



# INSTALLATION

## Connecting an Audio System (When playing a DVD)

The DIGITAL AUDIO OUT connector is used for equipment, such as an audio system (to take full advantage of the Surround sound effect).

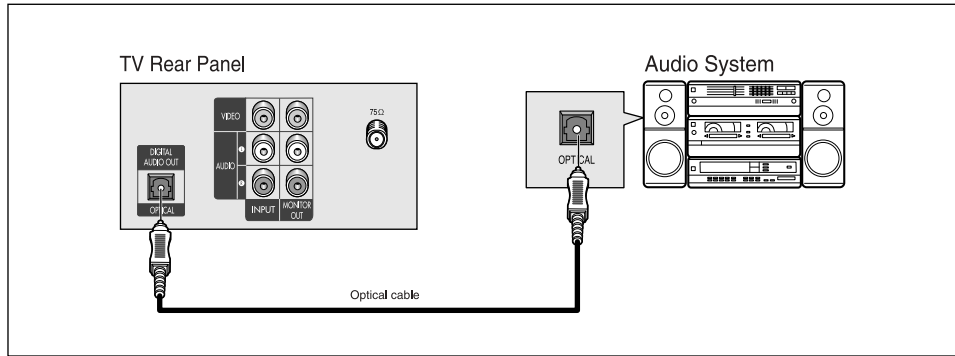

Connect an optical cable between the DIGITAL AUDIO IN jacks on the AUDIO and the DIGITAL AUDIO OUT jack on the TV.

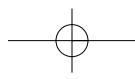
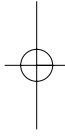



## INSTALLATION

### Installing Batteries in the Remote Control

**1**

Slide the cover out completely.

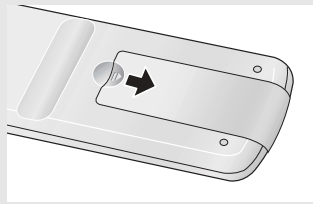

**2**

Install two AA size batteries.

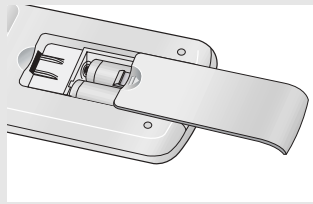

◀ Make sure to match the “+” and “-” ends of the batteries with the diagram inside the compartment.

**3**

Replace the cover.

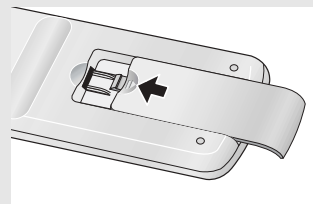

◀ Remove the batteries and store them in a cool, dry place if you won't be using the remote control for a long time.

The remote control can be used up to about 23 feet from the TV.

(Assuming typical TV usage, the batteries last for about one year.)

# Chapter Three

## TV OPERATION

### Turning the TV On and Off

Press the **POWER** button on the remote control.  
You can also use the Power button on the front panel.

### Viewing the Menus and On-Screen Displays

#### Viewing the Menus

**1**

With the power on, press the **MENU** button.

The main menu appears on the screen:  
Picture, Sound, Channel, Function and VCR setup.

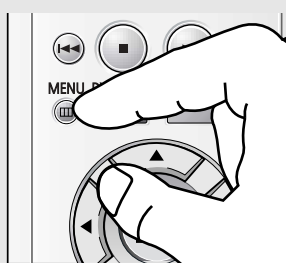

◀ The on-screen menus disappear from the screen after about thirty seconds.

**2**

Use the UP/DOWN▲▼ buttons to select one of the 5 items. Then press the LEFT/RIGHT◀▶ buttons to access the item's sub-menu.

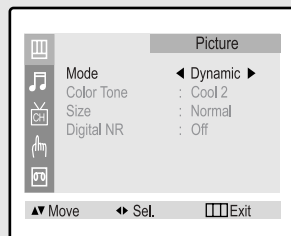

◀ On the control panel of the TV to make selections.

**3**

Press the **MENU** button to exit.

#### Viewing the Display

The display identifies the current channel and the status of certain audio-video settings.

**1**

Press the **INFO** button on the remote control.

The TV will display the channel, Time, disc mode, the status of certain picture and sound settings, V-chip and the type of sound.

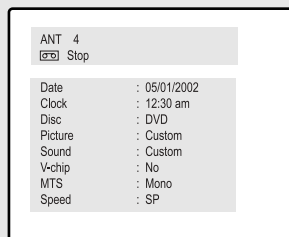

◀ The on-screen displays disappear after about ten seconds.

## TV OPERATION

### Selecting a Menu Language

**1**

Press the **MENU** button to display the menu.

Press the **UP/DOWN** ▲▼ buttons to select "Function".

Press the **LEFT/RIGHT** ◀▶ buttons.

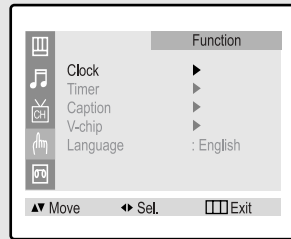

**2**

Press the **UP/DOWN** ▲▼ buttons to select "Language".

Press the **LEFT/RIGHT** ◀▶ buttons to select the appropriate language: English, Spanish, or French.



**3**

Press the **MENU** button to exit.

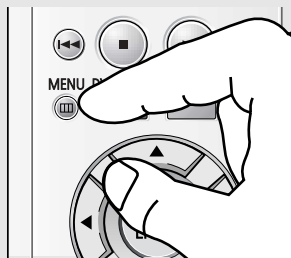

## TV OPERATION

### Memorizing the Channels

Your TV can memorize and store all of the available channels for both “off-air” (antenna) and cable channels. After the available channels are memorized, use the CH ▲ and CH ▼ buttons to scan through the channels. This eliminates the need to change channels by entering the channel digits. There are three steps for memorizing channels: selecting a broadcast source, memorizing the channels (automatic) and adding and deleting channels (manual).

#### Selecting the Video Signal-source

Before your television can begin memorizing the available channels, you must specify the type of signal source that is connected to the TV (i.e., an antenna or a cable system).

### 1

Press the **MENU** button to display the menu.

Press the UP/DOWN▲▼ buttons to select “Channel”.

Press the LEFT/RIGHT◀▶ buttons.

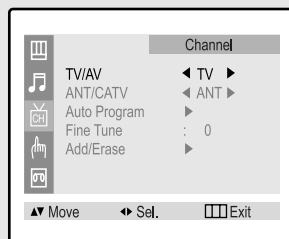

### 2

Press the UP/DOWN▲▼ buttons to select “ANT/CATV”.

Repeatedly press the LEFT/RIGHT◀▶ buttons to cycle through these choices:

ANT (antenna), STD, HRC or IRC (all cable TV).

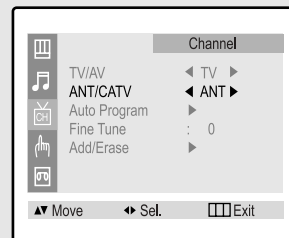

**Note:** STD, HRC and IRC identify various types of cable TV systems. Contact your local cable company to identify the type of cable system that exists in your particular area.

At this point the signal source has been selected. Proceed to “Storing Channels in Memory” (next page).

# TV OPERATION

## Storing Channels in Memory (Automatic Method)

**1**  
First, select the correct signal source (ANT, STD, HRC, IRC). See steps 1-2 on previous page.  
  
Press the UP/DOWN▲▼ buttons to select "Channel", then press the LEFT/RIGHT◀▶ buttons.

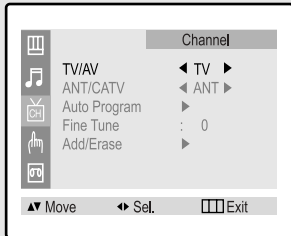

**2**  
Press the UP/DOWN▲▼ buttons to select "Auto Program".

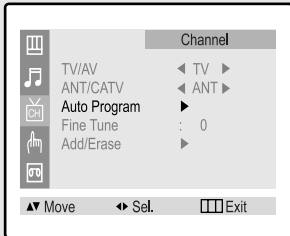

**3**  
Press the LEFT/RIGHT◀▶ buttons.  
TV will begin memorizing all of the available channels.



◀ The TV automatically cycles through all of the available channels and stores them in memory. This takes about one to two minutes.  
Press the RIGHT▶ button at any time to interrupt the memorization process and return to the Channel menu.

**4**  
After all the available channels are stored, the Auto program menu disappears. Press the MENU button to exit.

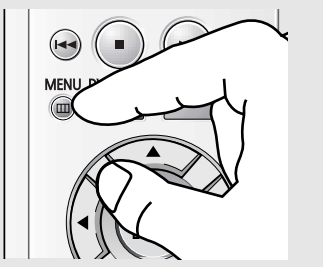

## TV OPERATION

### Adding and Erasing Channels (Manual Method)

**1**

Press the **MENU** button to display the menu.

Press the **UP/DOWN** buttons to select "Channel".

Press the **LEFT/RIGHT** buttons.

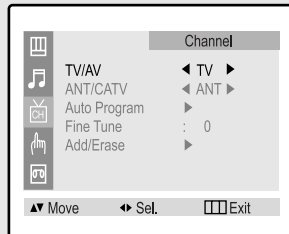

**2**

Press the **UP/DOWN** buttons to select "Add/Erase".

Press the **LEFT/RIGHT** buttons.

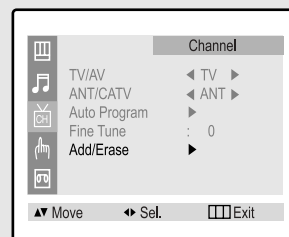

**3**

Press the **LEFT/RIGHT** buttons or the number buttons to select the channel you want to add or erase.

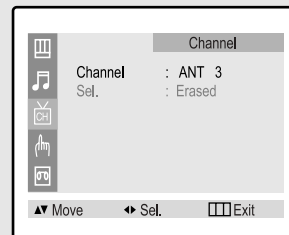

**4**

Press the **UP/DOWN** buttons to select "Sel.".

Press the **LEFT/RIGHT** buttons to select "Added" or "Erased".

Press the **MENU** button to exit.

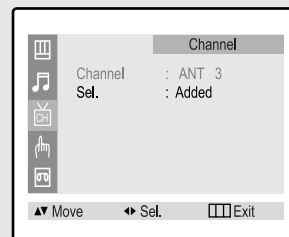

◀ You can view any channel (including an erased channel) by using the number buttons or **LEFT/RIGHT** buttons on the remote control.

## TV OPERATION

### Changing Channels

#### Using the Channel Buttons

Press the **CH**  $\downarrow$  or **CH**  $\uparrow$  buttons to change channels.



◀ When you press the **CH**  $\uparrow$  or **CH**  $\downarrow$  buttons, the TV changes channels in sequence. You will see all the channels that the TV has memorized. (The TV must have memorized at least three channels.) You will not see channels that were either erased or not memorized.

#### Directly Accessing Channels

Use the number buttons to quickly tune to any channel.

Press the number buttons to go directly to a channel. For example, to select channel 27, press "2," then "7." The TV will change channels when you press the second number.

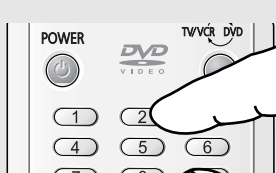

When you use the number buttons, you can directly select channels that were either erased or not memorized.

To select a channel over 100, press the **+100** button. (For channel 122, press "+100," then "2," then "2.")

To change to single-digit channels (0-9) faster, press "0" before the single digit. (For channel "4," press "0," then "4.")

#### Using the Pre-CH Button to select the Previous Channel

Press the **PRE.CH** button. The TV will switch to the last channel viewed.

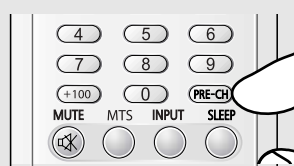

◀ To quickly switch between two channels that are far apart, tune to one channel, then use the number button to select the second channel. Then, use the **Pre-CH** button to quickly alternate between them.

## TV OPERATION

### Adjusting the Volume

Press the **VOL +** or **VOL-** buttons to increase or decrease the volume.

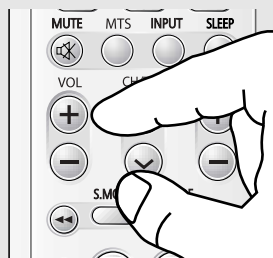

### Using Mute

At any time, you can temporarily cut off the sound using the Mute button.

**1**

Press the **MUTE** button and the sound cuts off.

The word "Mute" will appear in the lower-left corner of the screen.

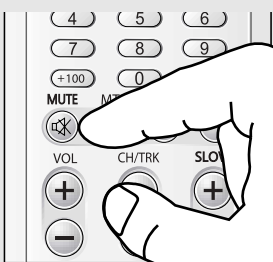

**2**

To turn mute off, press the **MUTE** button again, or simply press either the **VOL +** or **VOL-** buttons.

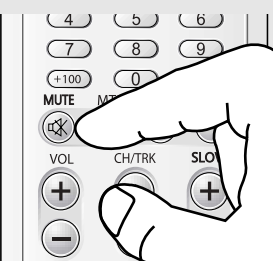



## TV OPERATION

### Customizing the Picture

You can use the on-screen menus to change the contrast, brightness, tint, color, and sharpness according to personal preference. (Alternatively, you can use one of the "automatic" settings. See next page.)

**1**

Press the **MENU** button to display the menu.

Press the **LEFT/RIGHT** buttons to display the Picture menu.

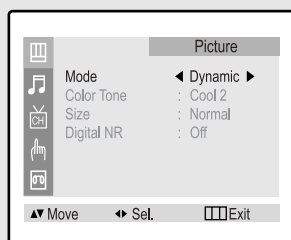

**2**

Press the **LEFT/RIGHT** buttons to select "Custom".

Press the **UP/DOWN** buttons to select "Adjust", then press the **LEFT/RIGHT** buttons.

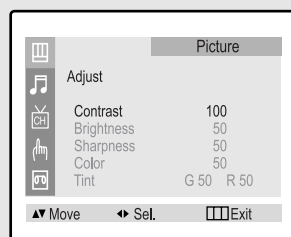

**3**

Press the **UP/DOWN** buttons to select particular item.

Press the **LEFT/RIGHT** buttons increase or decrease the value of a particular item.

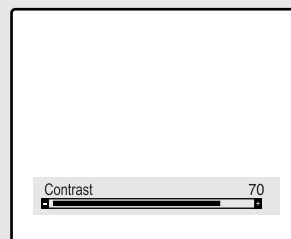

After adjusting an item, the gauge will automatically disappear (after about 3 seconds).

**4**

Press the **MENU** button to exit.

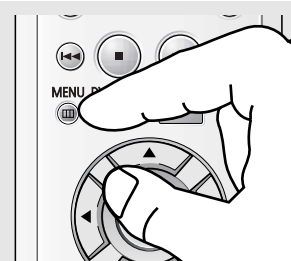

## TV OPERATION

### Using Automatic Picture Settings

Your TV has three automatic picture settings (“Dynamic”, “Standard” and “Movie”) that are preset at the factory. You can activate either Dynamic, Standard, or Movie by pressing P.MODE (or by making a selection from the menu). Or, you can select “Custom” which automatically recalls your personalized picture settings.

#### 1

Press the **MENU** button to display the menu.

Press the **LEFT/RIGHT** buttons to display the Picture menu.

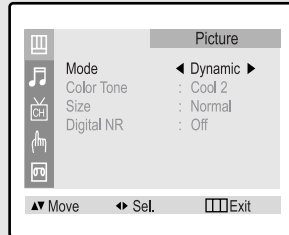

#### 2

Press the **LEFT/RIGHT** buttons to select the “Dynamic,” “Standard,” “Movie,” or “Custom” picture setting.

Press the **MENU** button to exit.

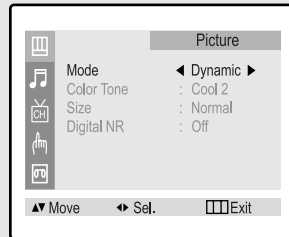

#### Alternate method:

Simply press the **P.MODE** button on the remote control to select one of the standard picture settings.



- Choose Dynamic for viewing the TV during the day or when there is brightlight in the room.
- Choose Standard for the standard factory settings.
- Choose Movie when viewing the movie.
- Choose Custom if you want to adjust the settings accordings to personal preference (see “Customizing the Picture”, page 3.8).

## TV OPERATION

### Changing the Color Tone

**1**

Press the **MENU** button to display the menu.

Press the **LEFT/RIGHT** buttons to display the Picture menu.

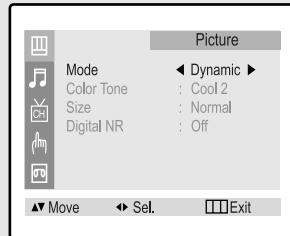

**2**

Press the **UP/DOWN** buttons to select Color Tone.

Press the **LEFT/RIGHT** buttons to select "Cool 2", "Cool 1", "Normal", "Warm 1" or "Warm 2" according to personal preference.

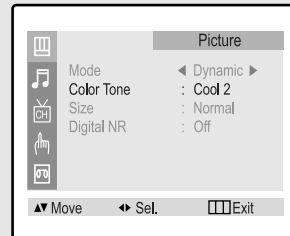

**3**

Press the **MENU** button to exit.

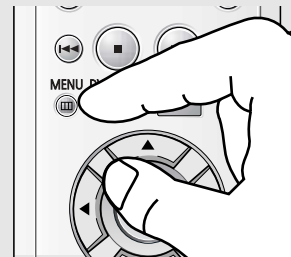

## TV OPERATION

### Changing the Screen Size (Depending on the model)

**1**

Press the **MENU** button to display the menu.

Press the **LEFT/RIGHT** buttons to display the Picture menu.

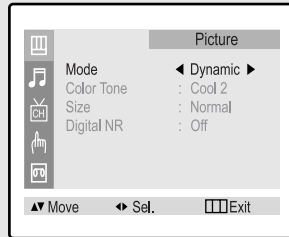

**2**

Press the **UP/DOWN** buttons to select "Size".

Press the **LEFT/RIGHT** buttons to select "Normal", "Zoom" or "16:9".

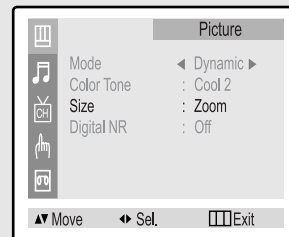

**3**

Press the **MENU** button to exit.

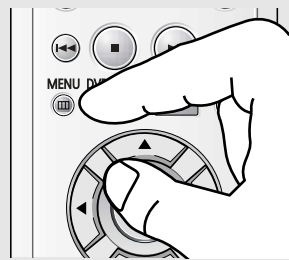

- **Normal** : Sets the picture to 4:3 normal mode. This is a standard TV screen size.
- **Zoom** : Sets the picture to Zoom mode.
- **16:9** : Sets the picture to 16:9 mode.

## TV OPERATION

### Fine Tuning Channels

Use fine tuning to manually adjust a particular channel for optimal reception.

**1**

Select the appropriate channel.

Press the **MENU** button to display the menu.

Press the UP/DOWN▲▼ buttons to select "Channel".

Press the LEFT/RIGHT◀▶ buttons.

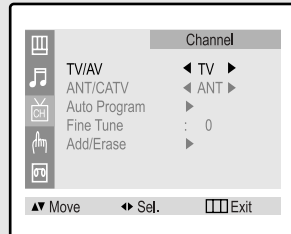

**2**

Press the UP/DOWN▲▼ buttons to select "Fine tune".

Press the LEFT/RIGHT◀▶ buttons to adjust the fine tuning.

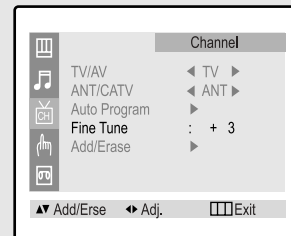

**3**

To store the fine tuning setting in the TV's memory, press the **UP ▲** button. (An asterisk "\*" will appear.)

To reset the fine tuning to "0," press the **DOWN ▼** button.

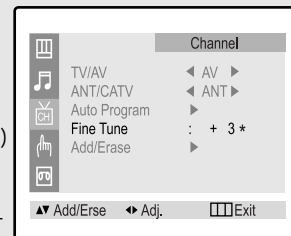

◀ After you adjust the fine tuning, the color of Channel No. will turn into red if you press the **DISPLAY** button while watching this channel.

**4**

Press the **MENU** button to exit.

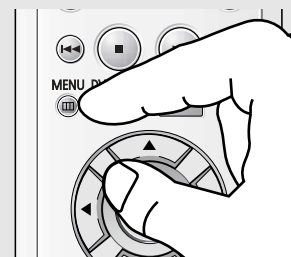

## TV OPERATION

### Digital Noise Reduction

If the broadcast signal received by your TV is weak, you can activate the Digital Noise Reduction feature to help reduce any static and ghosting that may appear on the screen.

**1**

Press the **MENU** button to display the menu.

Press the **LEFT/RIGHT** buttons to display the Picture menu.

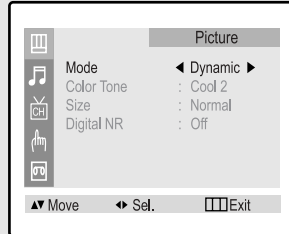

**2**

Press the **UP/DOWN** buttons to select "Digital NR".

Press the **LEFT/RIGHT** buttons to select Digital NR "On".

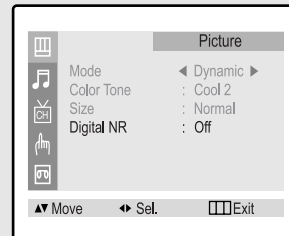

Pressing the **LEFT/RIGHT** buttons will alternate between "On" and "Off".

**3**

Press the **MENU** button to exit.

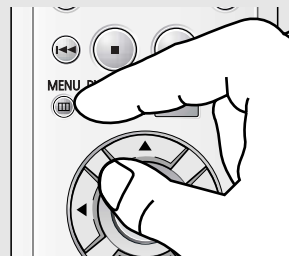

## TV OPERATION

### Tilt (Depending on the model)

Due to the Earth's magnetic field there may be some minor image tilt depending on the TV's location. When this occurs, follow the steps below.

**1**

Press the **MENU** button to display the menu.

Press the **LEFT/RIGHT** buttons to display the Picture menu.

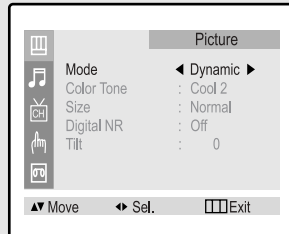

**2**

Press the **UP/DOWN** buttons to select "Tilt".

Press the **LEFT/RIGHT** buttons to adjust the Tilt.

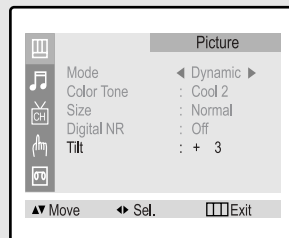

**3**

Press the **MENU** button to exit.

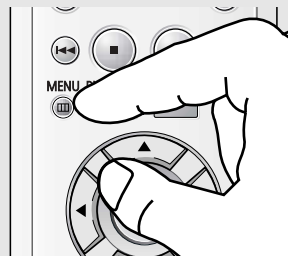

## TV OPERATION

### Customizing the Sound

The sound settings can be adjusted to suit your personal preferences. (Alternatively, you can use one of the “automatic” settings. See next page.)

**1**

Press the **MENU** button to display the menu.

Press the **UP/DOWN▲▼** buttons to select “Sound”, then press the **LEFT/RIGHT◀▶** buttons.

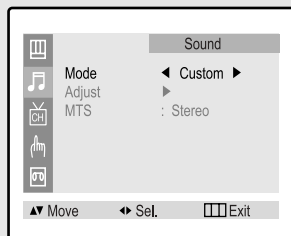

**2**

Press the **UP/DOWN▲▼** buttons to select “Adjust”, then press the **LEFT/RIGHT◀▶** buttons.

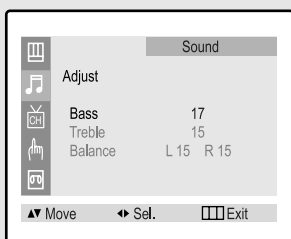

**3**

Press the **UP/DOWN▲▼** buttons to select a particular item.

Press the **LEFT/RIGHT◀▶** buttons increase or decrease the value of a particular item.

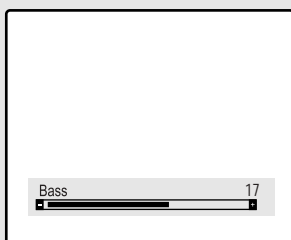

**4**

Press the **MENU** button to exit.

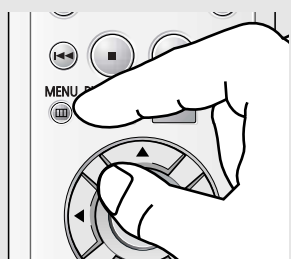

◀ After adjusting an item, the gauge will automatically disappear (after about 3 seconds).



## TV OPERATION

### Using Automatic Sound Settings

Your TV has four automatic sound settings (“Standard,” “Music,” “Movie” and “Speech”) that are preset at the factory. You can activate any of them by pressing the S.MODE button (or by making a selection from the on-screen menu). Or, you can select “Adjust,” which automatically recalls your personalized sound settings.

**1**

Press the **MENU** button to display the menu.

Press the UP/DOWN▲▼ buttons to select “Sound”, then press the LEFT/RIGHT◀▶ buttons.

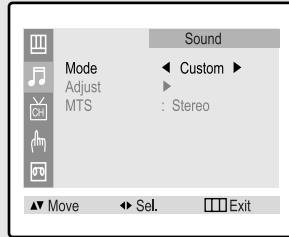

**2**

Press the LEFT/RIGHT◀▶ buttons to select the “Standard,” “Music,” “Movie,” “Speech” or “Custom” sound setting.

Press the **MENU** button to exit.

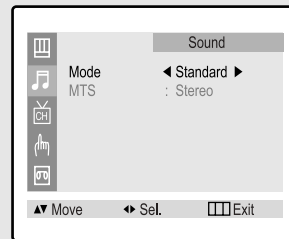

#### Alternate method:

Simply press the the **S.MODE** button on the remote control to select one of the standard sound settings.



- Choose Standard for the standard factory settings.
- Choose Music when watching music videos or concerts.
- Choose Movie when watching movies.
- Choose Speech when watching a show that is mostly dialogue (i.e., news).
- Choose Custom to recall your personalized settings.

## TV OPERATION

### Choosing a Multi-Channel Soundtrack (MTS)

Depending on the particular program being broadcast, you can listen to stereo, mono, or a Separate Audio Program. (SAP audio is usually a foreign-language translation. Sometimes SAP has unrelated information like news or weather.)

#### 1

Press the **MENU** button to display the menu.

Press the UP/DOWN▲▼ buttons to select Sound.  
Press the LEFT/RIGHT◀▶ buttons.

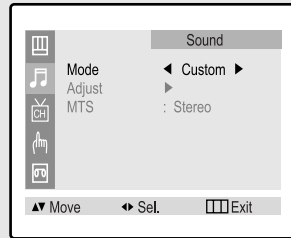

#### 2

Press the UP/DOWN▲▼ buttons to select "MTS".

Press the LEFT/RIGHT◀▶ buttons repeatedly to select "Mono," "Stereo" or "SAP".

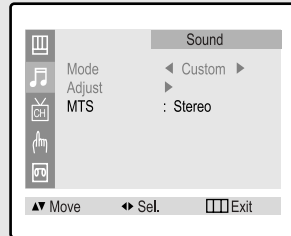

#### 3

Press the **MENU** button to exit.

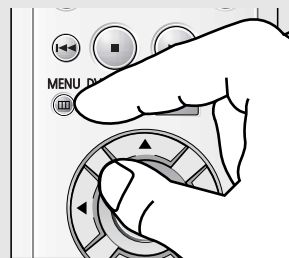

- Choose Mono for channels that are broadcasting in mono, or if you are having difficulty receiving a stereo signal.
- Choose Stereo for channels that are broadcasting in stereo.
- Choose SAP to listen to the Separate Audio Program, which is usually a foreign-language translation.

You can also change the MTS setting by pressing the "MTS" button on the remote control.

# TV OPERATION

## Viewing a VCR or Camcorder Tape

You must select the appropriate mode in order to view the VCR or Camcorder signal on the TV.

**1**  
 Press the **MENU** button to display the menu.

Press the **UP/DOWN▲▼** buttons to select "Channel", then press the **LEFT/RIGHT◀▶** buttons.

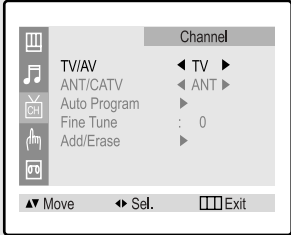

**2**  
 Press the **LEFT/RIGHT◀▶** buttons. You will switch between viewing the signals coming from equipment connected to the TV's A/V jacks, and the TV signal.

Press the **MENU** button to exit.

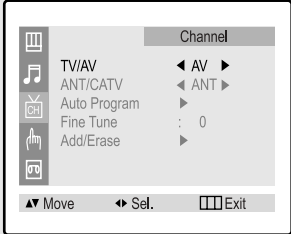

**Alternate method:**

Simply press the **INPUT** button on the remote control one or more times until the required input is displayed.



## TV OPERATION

### Setting the Clock

Setting the clock is necessary in order to use the various timer features of the TV. Also, you can check the time while watching the TV (Just press the DISPLAY button).

#### Option 1: Setting the Clock Manually

### 1

Press the **MENU** button to display the menu.

Press the **UP/DOWN▲▼** buttons to select "Function", then press the **LEFT/RIGHT◀▶** buttons.

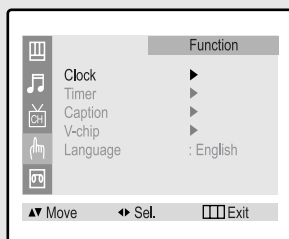

### 2

Press the **LEFT/RIGHT◀▶** buttons to select "Manual".

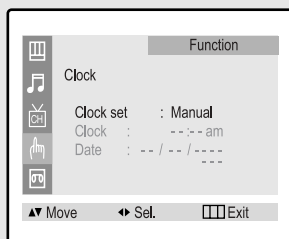

### 3

Press the **UP/DOWN▲▼** buttons to select "Clock", then press the **RIGHT▶** button.

Press the **UP/DOWN▲▼** buttons repeatedly until the correct hour appears.

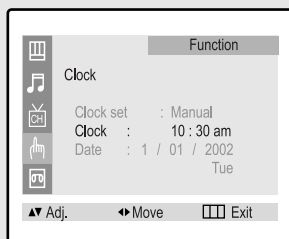

### 4

After the hour is entered, Press the **RIGHT▶** (at this point the minutes digits will be highlighted). Press the **UP/DOWN▲▼** buttons to select the correct minutes.

After selecting the correct minutes, press the **RIGHT▶** button.

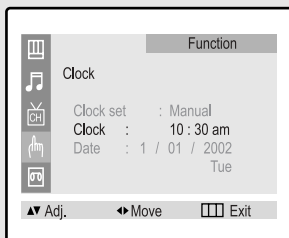

◀ When selecting the hours, be sure to select the proper time of day (am or pm).

You can change the hours by pressing the **UP▲** or **DOWN▼** button repeatedly (or by holding down either of these buttons).

◀ The time will appear every time you press the **DISPLAY** button.

## TV OPERATION

### Setting the Date

**5**

Press the UP/DOWN▲▼ buttons to select "Date", then press the RIGHT ► button.

Press the UP/DOWN▲▼ buttons to set the current month.

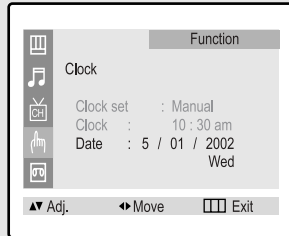

**6**

Press the RIGHT ► button, then press the UP/DOWN▲▼ buttons to set the current day.

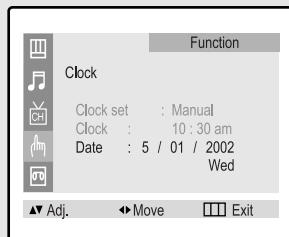

**7**

Press the RIGHT ► button, then press the UP/DOWN▲▼ buttons to set the current year.

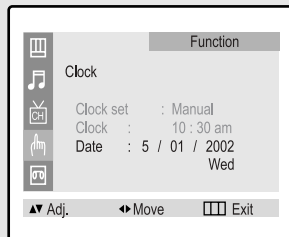

◀ If you make a mistake, press LEFT ◀ to move back to the incorrect item. Press the UP/DOWN ▲▼ buttons to change the item.

## TV OPERATION

### Option 2: Using the Local PBS Channel to Automatically Set the TV Clock

**1**

Press the **MENU** button to display the menu.

Press the **UP/DOWN** ▲▼ buttons to select "Function", then press the **LEFT/RIGHT** ◀▶ buttons.

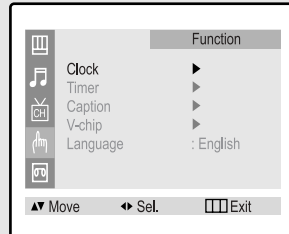

**2**

Press the **LEFT/RIGHT** ◀▶ buttons to select "Auto".

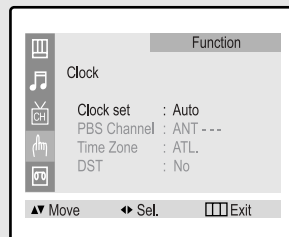

**3**

Press the **UP/DOWN** ▲▼ buttons to select "PBS channel", then press the **RIGHT** ► button to activate the channel-number field.

Press the **UP/DOWN** ▲▼ buttons to select your local PBS channel.

Press the **RIGHT** ► button.

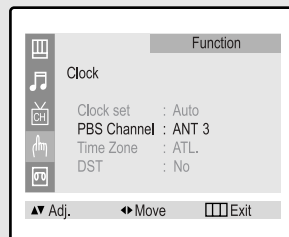

## TV OPERATION

### 4

Press the UP/DOWN▲▼ buttons to select "Time Zone", then press the RIGHT ► button to change the Time zone.

Sequence: ATL., EAST, CEN., MTN., PAC., ALAS., HAW..

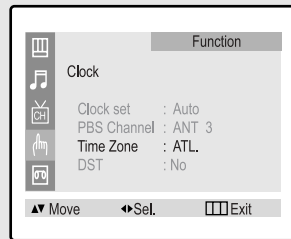

### 5

Press the UP/DOWN▲▼ buttons to select "DST" (Daylight saving time), then press the LEFT/RIGHT ◀▶ buttons to indicate "Yes" or "No".

The clock is set.

Press the **MENU** button to exit.

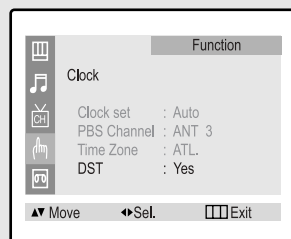

## TV OPERATION

### Setting the On/Off Timer

**1**

Press the **MENU** button to display the menu.

Press the **UP/DOWN▲▼** buttons to select "Function", then press the **LEFT/RIGHT◀▶** buttons.

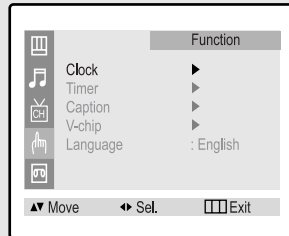

◀ Before using the timer, you must set the TV's clock. (See "Setting the Clock" on page 3.18)

**2**

Press the **UP/DOWN▲▼** buttons to select "Timer", then press the **LEFT/RIGHT◀▶** buttons.

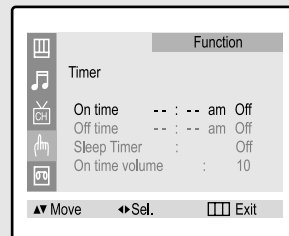

**3**

Press the **UP/DOWN▲▼** buttons to select "On Time."

Press the **RIGHT▶** button to highlight the "On time" hours.

Press the **UP/DOWN▲▼** buttons repeatedly to select the appropriate hours (i.e., the hour when the TV will turn on.)

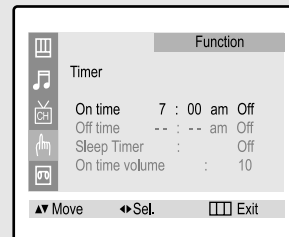

◀ When you set the hours, make sure the correct time of day (am or pm) appears to the right of the hour.

**4**

Press the **RIGHT▶** button to highlight the "On time" minutes.

Press the **UP/DOWN▲▼** buttons repeatedly to select the appropriate minutes.

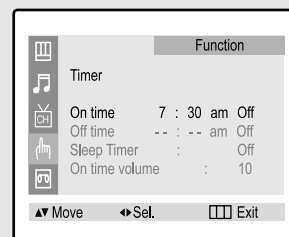



# TV OPERATION

## 5

Press the RIGHT ► button to highlight "Off".

Press the UP/DOWN▲▼ buttons to turn the on timer "On." (Repeatedly pressing the UP/DOWN▲▼ buttons will alternate between On and Off.)

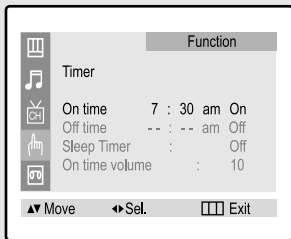

◀ To deactivate the "On time," select "Off" during this step.

## 6

When finished, press the RIGHT ► button.

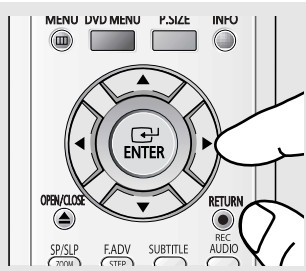

## 7

To set the Off time, press the UP/DOWN▲▼ buttons to select "Off Time".

Press the RIGHT ► button and set the hours and minutes. (Follow the same procedure as in steps 1-6 above.)

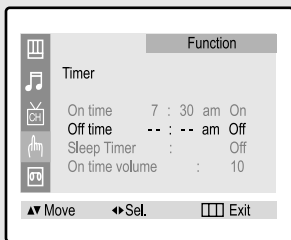

## 8

If you want to set the volume level when the TV turns on, press the DOWN ▼ button to select "On time volume". Press the LEFT/RIGHT ◀▶ buttons to set the volume level you want when the TV turns on.

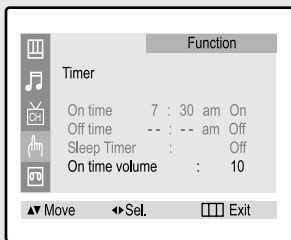

## 9

When finished setting the timer, press the MENU button to exit.

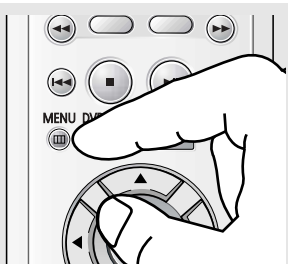

# TV OPERATION

## Setting the Sleep Timer

The sleep timer automatically shuts off the TV after a preset time (from 15 to 180 minutes).

**1**  
 Press the **MENU** button to display the menu.  
  
 Press the UP/DOWN▲▼ buttons to select "Function", then press the LEFT/RIGHT◀▶ buttons.

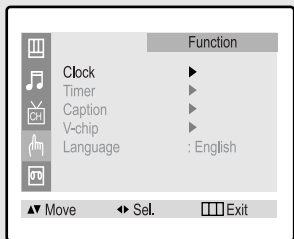

**2**  
 Press the UP/DOWN▲▼ buttons to select "Timer", then press the LEFT/RIGHT◀▶ buttons.

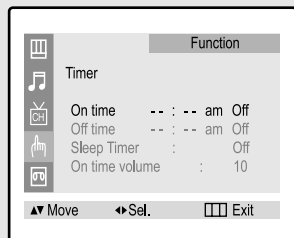

**3**  
 Press the UP/DOWN▲▼ buttons to select "Sleep Timer."  
  
 Press the RIGHT▶ button repeatedly until the appropriate time interval appears (any of the preset values from "Off" to "180").

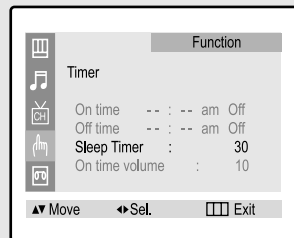

Press the **MENU** button to exit.

### Alternate method:

Simply press **SLEEP** repeatedly until the appropriate time interval appears (any of the preset values from "Off" to "180").



◀ After about 3 seconds, the sleep display will disappear from the screen, and the time interval will be set.

## TV OPERATION

### Viewing Closed Captions

Your TV decodes and displays the closed captions that are broadcast with certain TV shows. These captions are usually subtitles for the hearing impaired or foreign-language translations. All VCRs record the closed caption signal from television programs, so home-recorded video tapes also provide closed captions. Most DVDs and pre-recorded commercial video tapes provide closed captions as well. Check for the closed caption symbol in your television schedule and on the tape's packaging: **CC** .

**1**

Press the **MENU** button to display the menu.

Press the UP/DOWN▲▼ buttons to select "Function", then press the LEFT/RIGHT◀▶ buttons.

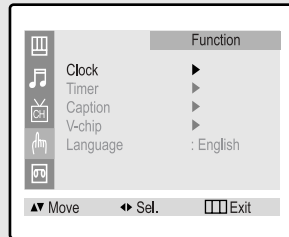

**2**

Press the UP/DOWN▲▼ buttons to select "Caption", then press the LEFT/RIGHT◀▶ buttons.

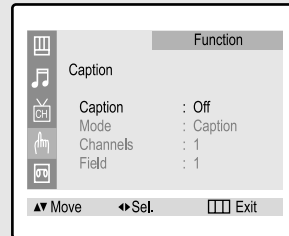

**3**

Press the LEFT/RIGHT◀▶ buttons to turn closed captioning on/off.

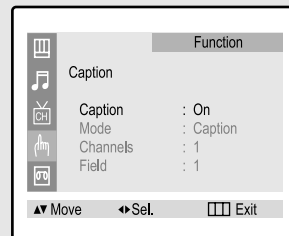

**4**

Press the UP/DOWN▲▼ buttons to select "Mode".

Press the LEFT/RIGHT◀▶ buttons to select "Caption" or "Text."

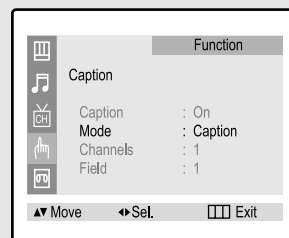

**5**

Depending on the particular broadcast, it might be necessary to make changes to "Channels" and "Field": Use the UP/DOWN▲▼, LEFT/RIGHT◀▶ buttons to make the changes. (Follow the same procedure as in steps 3-4 above.) Press the **MENU** button to exit.

◀ Misspellings and unusual characters sometimes occur during closed caption transmissions, especially those of live events. There may be a small delay before captions appear when you change channels. These are not malfunctions of the TV.

◀ In caption mode, captions appear at the bottom of the screen, and they usually cover only a small portion of the picture.

In text mode, information unrelated to the program, such as news or weather, is displayed. Text often covers a large portion of the screen.

◀ Different channels and fields display different information: Field 2 carries additional information that supplements the information in Field 1. (For example, Channel 1 may have subtitles in English, while Channel 2 has subtitles in Spanish.)

## TV OPERATION

### Using the V-Chip

The V-Chip feature automatically locks out programming that is deemed inappropriate for children. The user must first enter a PIN (personal ID number) before any of the V-Chip restrictions can be set up or changed.

#### Setting Up Your Personal ID Number (PIN)

**1**

Press the **MENU** button to display the menu.

Press the UP/DOWN▲▼ buttons to select "Function", then press the LEFT/RIGHT◀▶ buttons.

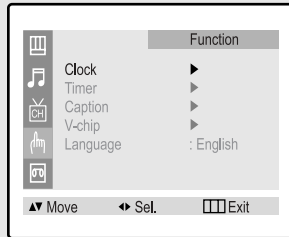

**2**

Press the UP/DOWN▲▼ buttons to select "V-Chip". Press the LEFT/RIGHT◀▶ buttons.

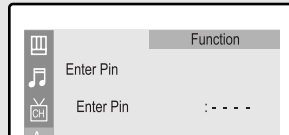

The "Enter pin" screen will appear. Enter your 4-digit PIN number. Note: The default PIN number for a new TV set is "0-0-0-0."

**3**

After entering a valid PIN number, the "V-chip mode" screen will appear. Press the UP/DOWN▲▼ buttons to select "Change pin".

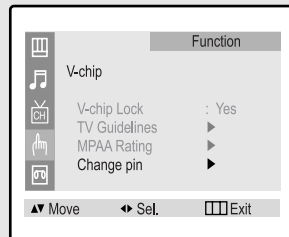

**4**

While the "Change pin" field is selected, press the LEFT/RIGHT◀▶ buttons. The Change pin screen will appear. Choose any 4-digits for your PIN and enter them.

As soon as the 4 digits are entered, the "Confirm new pin" screen appears. Re-enter the same 4 digits. When the Confirm screen disappears, your PIN has been memorized. Press the **MENU** button to exit.

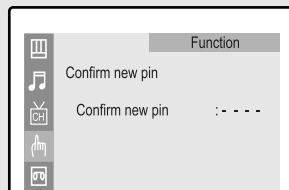
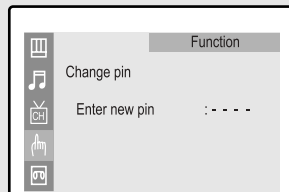

◀ **Note:** If you forget the PIN, press the remote-control buttons in the following sequence, which resets the pin to 0-0-0-0:

**POWER OFF → MUTE → 8 → 2 → 4 → POWER ON.**

## TV OPERATION

### How to Enable/Disable the V-Chip

**1**

Press the **MENU** button to display the menu.

Press the UP/DOWN▲▼ buttons to select "Function", then press the LEFT/RIGHT◀▶ buttons.

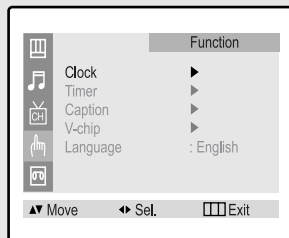

**2**

Press the UP/DOWN▲▼ buttons to select "V-Chip". Press the LEFT/RIGHT◀▶ buttons.

The "Enter pin" screen will appear. Enter your 4-digit PIN number.

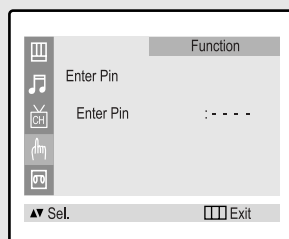

**3**

After entering a valid PIN number, the "V-chip" screen will appear. To enable the V-Chip feature, press the LEFT/RIGHT◀▶ buttons so that the "V-Chip lock" field is Yes. (Pressing the LEFT/RIGHT◀▶ buttons will alternate between Yes and No.)

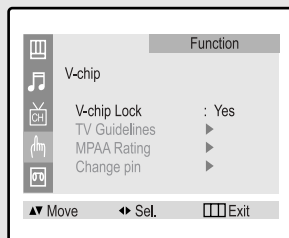

### How to Set up Restrictions Using the "TV guidelines"

First, set up a personal identification number (PIN), and enable the V-Chip. (See previous section.) Parental restrictions can be set up using either of two methods: The TV guidelines or the MPAA rating.

**1**

Press the **MENU** button to display the menu.

Press the UP/DOWN▲▼ buttons to select "Function", then press the LEFT/RIGHT◀▶ buttons.

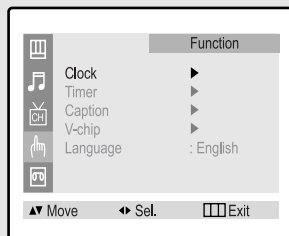

## TV OPERATION

### 2

Press the UP/DOWN▲▼ buttons to select "V-Chip". Press the LEFT/RIGHT◀▶ buttons.

The "Enter pin" screen will appear. Enter your 4-digit PIN number.

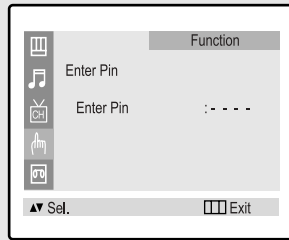

### 3

Press the UP/DOWN▲▼ buttons to select "TV Guidelines".

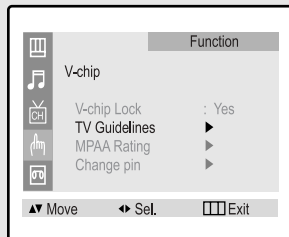

### 4

Press the LEFT/RIGHT◀▶ buttons. The "TV guidelines" screen will appear. Press the UP/DOWN▲▼ buttons to select one of the six age-based categories:

TV-Y Young children  
TV-Y7 Children 7 and over

TV-G General audience  
TV-PG Parental guidance  
TV-14 Viewers 14 and over  
TV-MA Mature audience

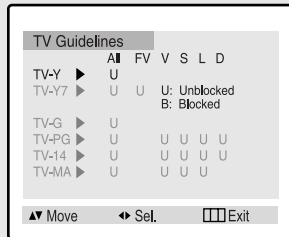

◀ Note: These categories consist of two separate groups: TV-Y and TV-Y7 (young children through age 7), and TV-G through TV-MA (everybody else).

The restrictions for these two groups work independently: If a household includes very young children as well as young adults, the TV guidelines must be set up separately for each age group. (See next step.)

### 5

At this point, one of the TV-Ratings is selected.

Press the LEFT/RIGHT◀▶ buttons: Depending on your existing setup, a letter "U" or "B" will be selected. (U= Unblocked, B= Blocked)

While the "U" or "B" is selected, press the UP/DOWN▲▼ buttons to block or unblock the category. Press the LEFT/RIGHT◀▶ buttons to save the TV guidelines. A TV-Rating will be selected. To select a different TV-Rating, press the UP/DOWN▲▼ buttons and then repeat the process.

Note 1: The TV-Y7, TV-PG, TV-14 and TV-MA have additional options. See the next step to change any of the following sub-ratings:

FV: Fantasy violence  
D: Sexual suggestive dialog  
L: Adult language  
S: Sexual situation  
V: Violence

Note 2: The V-Chip will automatically block certain categories that are "more restrictive." For example, if you block "TV-Y" category, then TV-Y7 will automatically be blocked. Similarly, if you block the TV-G category, then all the categories in the "young adult" group will be blocked (TV-G, TV-PG, TV-14 and TV-MA). The sub-ratings (D, L, S, V) work together similarly. (See next section.)

## TV OPERATION

### 6

#### How to set the FV, D, L, S and V sub-ratings.

First, select one of these TV-Ratings: TV-Y7, TV-PG, TV-14 or TV-MA (See Step 4, on previous page). Next, while the TV-Rating is selected, repeatedly press the LEFT/RIGHT ◀▶ buttons. This will cycle through the available sub-ratings (FV, L, S, D or V).

A letter ("U" or "B") will be displayed for each sub-rating. While the "U" or "B" is selected, press the UP/DOWN ▲▼ buttons to change the sub-rating. Press the LEFT/RIGHT ◀▶ buttons to save the TV guidelines. A TV-Rating will be selected. To select a different TV-Rating, press the UP/DOWN ▲▼ buttons and then repeat the process.

Note: The V-chip will automatically block certain categories that are "More restrictive". For example, if you block "L" sub-rating in TV-PG, then the "L" sub-ratings in TV-14 and TV-MA will automatically be blocked.

### 7

Press the **MENU** button to clear all the screens. (Or proceed to the next section, and set up additional restrictions based on the MPAA codes).

#### How to Set up Restrictions using the MPAA Ratings: G, PG, PG-13, R, NC-17, X

The MPAA rating system uses the Motion Picture Association of America (MPAA) system, and its main application is for movies. (Eventually, movie videocassettes and DVDs will be encoded with MPAA ratings.) When the V-Chip lock is on, the TV will automatically block any programs that are coded with objectionable ratings (either MPAA or TV-Ratings).

### 1

Press the **MENU** button to display the menu.

Press the UP/DOWN ▲▼ buttons to select "Function", then press the LEFT/RIGHT ◀▶ buttons.

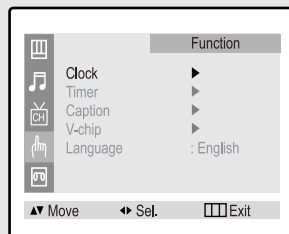

### 2

Press the UP/DOWN ▲▼ buttons to select "V-Chip". Press the LEFT/RIGHT ◀▶ buttons.

The "Enter pin" screen will appear. Enter your 4-digit PIN number.

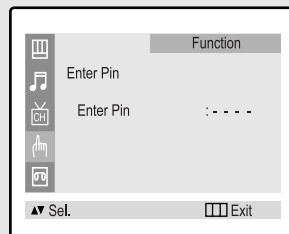

## TV OPERATION

### 3

Press the UP/DOWN▲▼ buttons to select the "MPAA Rating."

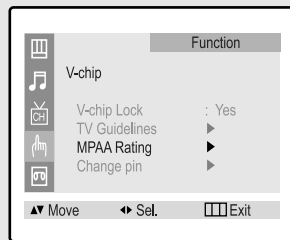

### 4

Press the LEFT/RIGHT◀▶ buttons. The "MPAA Rating" screen will appear.

Repeatedly press the UP/DOWN▲▼ buttons to select a particular MPAA category.

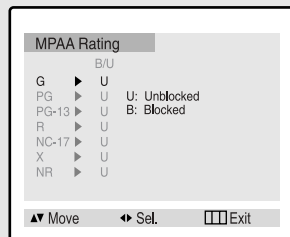

<b>G</b>	General audience (no restrictions).
<b>PG</b>	Parental guidance suggested.
<b>PG-13</b>	PG-13 (Parents strongly cautioned).
<b>R</b>	R (Restricted. Children under 17 should be accompanied by an adult).
<b>NC-17</b>	No children under age 17.
<b>X</b>	X (Adults only).
<b>NR</b>	Not rated.

While a particular category is selected, press the LEFT/RIGHT◀▶ buttons to activate it. A letter ("U" or "B") will be selected. Press the UP/DOWN▲▼ buttons to select "U" or "B".

Press the LEFT/RIGHT◀▶ buttons to save the settings and Press the MENU button to exit.

Note: The V-Chip will automatically block any category that is "more restrictive."

For example, if you block the "PG-13" category, then "R," "NC-17," and "X" will automatically be blocked also.

### How to Reset the TV after the V-Chip Blocks a Channel ("Emergency Escape")

If the TV is tuned to a restricted channel, the V-Chip will block it. The screen will go blank and the following message will appear: "Excessive rating."

To resume normal viewing, tune to a different channel using the number buttons. Under certain conditions (depending on the rating of the local TV programs) the V-Chip might lock out all the channels. In this case, use the V.Chip button for an "emergency escape":

1. Press the **MENU** button on the remote control.
2. Press the UP/DOWN▲▼ buttons to select the "Function", then press the LEFT/RIGHT◀▶ buttons.
3. Press the UP/DOWN▲▼ buttons to select the "V-Chip", then press the LEFT/RIGHT◀▶ buttons.
4. Enter your PIN number, and press the LEFT/RIGHT◀▶ buttons to temporarily disable the V-Chip Lock.



# Chapter Four

## DVD OPERATION

### Playing a Disc

#### Playback

**1**  
Press the **TV/VCR DVD** button to switch the DVD mode.



**2**  
Press the **OPEN/CLOSE** button.

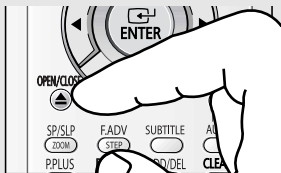

**3**  
Place a disc gently into the tray with the disc's label facing up.



**4**  
Press the **PLAY/PAUSE** (▶/⏸) or **OPEN/CLOSE** button to close the disc tray.

#### Stopping Playback

Press the **STOP** (■) button during playback.



#### Removing Disc

Press the **OPEN/CLOSE** button.

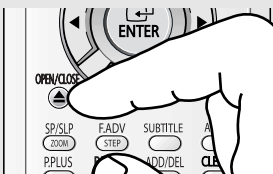

#### Pausing Playback

Press the **PLAY/PAUSE** (▶/⏸) or **STEP** button on the remote control during playback.

- Screen stops, no sound.
- To resume again, press the **PLAY/PAUSE** (▶/⏸) button once again.



## DVD OPERATION

### Step Motion Playback (Except CD)

Press the **STEP** button on the remote control during playback.

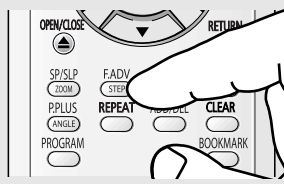

- Each time the button is pressed, a new frame will appear.
- No sound is heard during STEP mode.
- Press the **PLAY/PAUSE** (▶/||) button to resume normal playback (You can only perform step motion playback in the forward direction).

### Slow Motion Playback (Except CD)

Press the **FWD** (▶▶) **SEARCH** button on the remote control during **PAUSE**.



- By pressing the **FWD SEARCH** button, you can select slow motion playback for 1/2, 1/4, 1/8 or 1/16 of normal speed.
- No sound is heard during slow mode.
- Press the **PLAY/PAUSE** (▶/||) button to resume normal playback.
- When playing a **VCD**, the reverse slow motion play will not work.

## DVD OPERATION

### Using the Search and Skip Functions

#### Searching through a Chapter or Track

Press the **FWD(▶▶)** or **REW(◀◀)** **SEARCH** button on the remote control during playback.



◀ When in search mode (2X/4X/8X/16X/32X) on a DVD or high-speed playback on a VCD, no sound will be heard.

- Press the **FWD(▶▶)** or **REW(◀◀)** **SEARCH** button on the remote control and press again to search at a faster speed (2X/4X/8X/16X/32X) on the DVD, VCD, CD.
- To return to normal speed playback, press the **PLAY/PAUSE(▶/||)** button.

#### Skipping Tracks

During playback, press the **NEXT SKIP(▶▶|)** or **BACK SKIP(|◀◀)** button.



- When playing a DVD, if you press the **NEXT SKIP (▶▶|)** button, it moves to next chapter. If you press the **BACK SKIP (|◀◀)** button, it moves to the beginning of the chapter. One more press makes it move to the beginning of the previous chapter.
- When playing a CD, if you press the **NEXT SKIP (▶▶|)** button, it moves to next track. If you press the **BACK SKIP (|◀◀)** button, it moves to the beginning of the track. One more press makes it move to the beginning of the previous track.
- When playing a VCD 2.0 in MENU OFF mode, a VCD1.1 or a CD, if you press the **NEXT SKIP(▶▶|)** button, it moves to next track. If you press the **BACK SKIP(|◀◀)** button, it moves to the the beginning of the track. One more press makes it move to the beginning of the previous track.
- If a track exceeds 15 minutes when playing a VCD and you press the **NEXT SKIP(▶▶|)** button, it moves forward 5 minutes. If you press the **BACK SKIP(|◀◀)** button, it moves backward 5 minutes.
- When playing a VCD 2.0 in the MENU MODE or Track View function, if you press the **NEXT SKIP(▶▶|)** button, it moves to the next MENU or the next Track View display. If you press the **BACK SKIP(|◀◀)** button, it moves to the previous MENU or the previous Track View display.

## DVD OPERATION

### Using the Display Function

#### When Playing a MP3/WMA

**1**

Press the OPEN/CLOSE button. Place a disc gently into the tray with the disc's label facing up. Press the PLAY/PAUSE (▶/⏸) or OPEN/CLOSE button to close the disc tray.

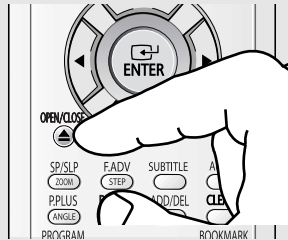

**2**

Press the UP/DOWN▲▼ button to select the desired music folder, then press the ENTER or RIGHT ▶ button.

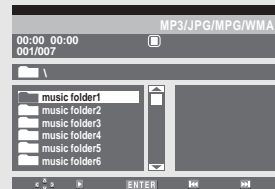

**3**

Press the UP/DOWN▲▼ button again to select a song file. Press the ENTER or PLAY/PAUSE (▶/⏸) button to begin play of the song file.

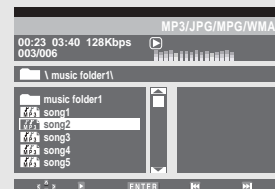

To play another song file of the same music folder, press the STOP button and press the UP/DOWN▲▼ button to select a song file. Press the ENTER or PLAY/PAUSE (▶/⏸) button.

To play another song file of another folder, press the LEFT ◀ button to move the music folder lists.

## DVD OPERATION

In the case of CD-R MP3 discs, please follow all the recommendations for CD-R above, plus the comments below:

- **Your MP3 files should be ISO 9660 or JOLIET format.**  
ISO 9660 format and Joliet MP3 files are compatible with Microsoft's DOS and Windows, and with Apple's Mac. These two formats are the most widely used.
- **When naming your MP3 files do not exceed 8 characters, and place ".mp3" as the file extension.**  
General name format of: Title.mp3. When composing your title, make sure that you use 8 characters or less, have no spaces in the name, and avoid the use of special characters including: (,./\,=,+).
- **Use a decompression transfer rate of at least 128 Kbps when recording MP3 files.**  
Sound quality with MP3 files basically depends on the rate of compression/decompression you choose. Getting audio CD quality sound requires an analog/digital sampling rate (conversion to MP3 format) of at least 128 Kbps and up to 160 Kbps. However, choosing higher rates, like 192 Kbps or more, only rarely give better sound quality. Conversely, files with sampling rates below 128 Kbps will not be played properly.
- **Do not try recording copyright protected MP3 files.**  
Certain "securized" files are encrypted and code protected to prevent illegal copying. These files are of the following types: Windows Media™ (registered trade mark of Microsoft Inc) and SDMI™ (registered trade mark of The SDMI Foundation). You cannot copy such files.
- **Your DVD player only accepts one level of file directory.**  
Consequently you must choose:
  - either to save all your MP3 recording files at the root of the disc;
  - and/or create folders in the directory for each artist or music type (e.g.classical, rock, jazz, etc)
- **Important:**  
The above recommendations cannot be taken as a guarantee that the DVD player will play MP3 recordings, or as an assurance of sound quality. You should note that certain technologies and methods for MP3 file recording on CD-Rs prevent optimal playback of these files on your DVD player (degraded sound quality and in some cases, inability of the player to read the files).
- This unit can play a maximum of 500 files and 300 folders per disc.

## DVD OPERATION

### When Playing a MPG

**1**

Press the OPEN/CLOSE button. Place a disc gently into the tray with the disc's label facing up. Press the PLAY/PAUSE (▶/||) or OPEN/CLOSE button to close the disc tray.

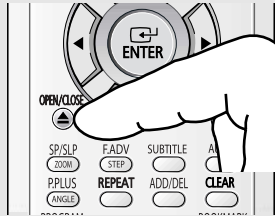

**2**

Press the UP/DOWN▲▼ button to select the desired MPEG folder, then press the ENTER or RIGHT ► button.

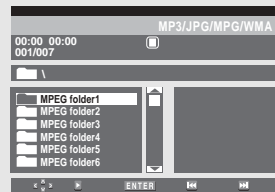

**3**

Press the UP/DOWN▲▼ button again to select a MPEG file. Press the ENTER or PLAY/PAUSE (▶/||) button to begin play of the MPEG file.

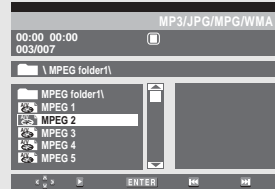

**4**

To play another MPEG file of the same MPEG folder, press the STOP button and press the UP/DOWN▲▼ button to select a MPEG folder. Press the ENTER or PLAY/PAUSE (▶/||) button.

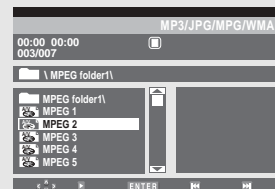

◀ To play another MPEG folder of another folder, press the LEFT ◀ button to move the MPEG folder lists. Repeat Steps 2 to 3.

## DVD OPERATION

### When Playing a Picture CD

Press the OPEN/CLOSE button. Place a disc gently into the tray with the disc's label facing up. Press the PLAY/PAUSE (▶/⏸) or OPEN/CLOSE button to close the disc tray.

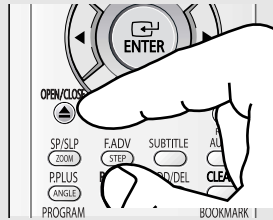

### Rotating and Reversing the picture

**1**

Press the UP/DOWN▲▼ button to select the desired picture file of the file list, then press the ENTER button.

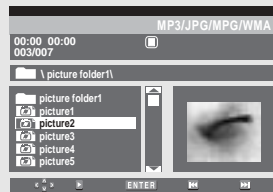

◀ If you want to return to the file list, press the STOP button.

**2**

Press the LEFT/RIGHT ◀▶ button to rotate the picture.

Press the UP ▲ button repeatedly to reverse vertically.  
Press the DOWN ▼ button repeatedly to reverse horizontally.



- Slide Show

Press the LEFT/RIGHT ◀▶ button to select the desired picture file of the file list, then press the PLAY/PAUSE (▶/⏸) button.

- If you want to return to the file list, press the STOP button.

## DVD OPERATION

### Viewing the Album Screen

- 1**  
Press the DVD MENU button during slide show.



- 2**  
The DVD menu is displayed with the Disc Menu selected.

Press the ENTER button.



- 3**  
To display the next or previous 12 pictures, press the next skip (▶▶) or back skip (◀◀) button.

Press the UP/DOWN▲▼ or LEFT/RIGHT◀▶ button to select the desired picture, then press the PLAY/PAUSE (▶/||) button.

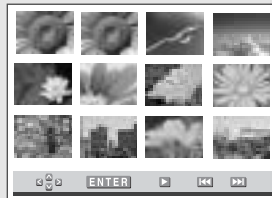

◀ If you press the ENTER button after selecting the desired picture, the selected picture will be displayed only.



## DVD OPERATION

### Using the Disc Menu

- 1**  
Press the DVD MENU button during the play of a DVD.



- 2**  
The DVD menu is displayed with the Disc Menu selected.

Press the ENTER button.



◀ Depending on the disc, the Disc Menu may not work.

### Using the Title Menu

- 1**  
Press the DVD MENU button during the play of a DVD.



- 2**  
Press the UP/DOWN▲▼ button to select Title Menu.

Press the ENTER button.

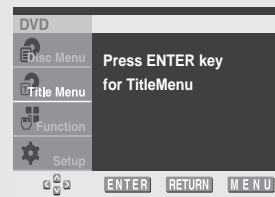

◀ Depending on the disc, the Title Menu may not work.

The Title Menu will only be displayed if there are at least two titles in the disc.

## DVD OPERATION

### Displaying the Disc Information

- 1**  
Press the DVD MENU button during play.



- 2**  
Press the UP/DOWN▲▼ button to select Function. Press the ENTER button.

The Info menu is selected. Press the ENTER button again.

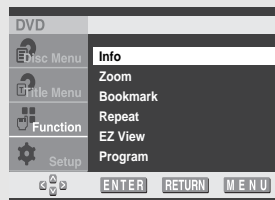

◀ Depending on the disc, the disc information will be displayed.

- 3**  
You can display by simply pressing the INFO button on the remote control.

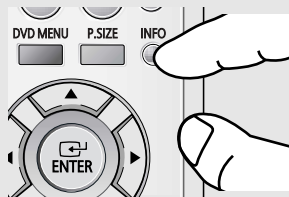





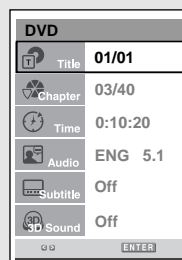

- 4**  
Press the UP/DOWN▲▼ button to select the required item. Press the LEFT/RIGHT ◀▶ button to make the required setup, then press the ENTER button.

To make the screen disappear, press the INFO button.



◀ You may use the number buttons of the remote control to start play from a desired time.

## DVD OPERATION

 <b>Title</b>	<p>To access the desired title when there is more than one in the disc. For example, if there is more than one movie on a DVD, each movie will be identified.</p>
 <b>Chapter</b>	<p>Most DVD discs are recorded in chapters so that you can quickly find a specific passage.</p>
 <b>Time</b>	<p>Allows playback of the film from a desired time. You must enter the starting time as a reference.</p>
 <b>Audio</b>	<p>Refers to the language of the film soundtrack. In the example, the soundtrack is played in English 5.1CH. A DVD disc can have up to eight different soundtracks.</p>
 <b>Subtitle</b>	<p>Refers to the subtitle languages available in the disc. You will be able to choose the subtitles language or, if you prefer, turn them off from the screen. A DVD disc can have up to 32 different subtitles.</p>
 <b>3D Sound</b>	<p>The simulated surround effect depends on the disc contents. If you connect the unit to your stereo system, you can enhance sound quality and produce a greater surround effect. This feature is useful when you are using the DVD player with a two channel stereo through the analog outputs. (Discs which are recorded with PCM or DTS will not work.) 3D Sound is possible only on discs recorded using DOLBY SURROUND or DOLBY DIGITAL. However, some of these discs do not contain rear channel sound signals. Depending on the disc, the 3D Sound function may not work.</p>

- **What is a Chapter?**  
Each Title on a DVD can be divided into chapters (similar to tracks on an audio CD).
- **What is a Title?**  
A DVD may contain several different titles. For example, if a disc contains four different movies, each might be considered a title.

## DVD OPERATION

### Using the Zoom Function (DVD/VCD)

- 1**  
Press the DVD MENU button during play or pause mode.



- 2**  
Press the UP/DOWN▲▼ button to select Function.  
Press the ENTER button.  
  
Press the UP/DOWN▲▼ button to select Zoom.  
Press the ENTER button.

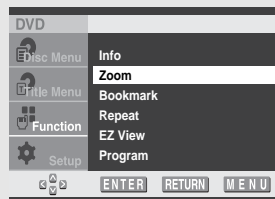

- 3**  
You can display by simply pressing the ZOOM button on the remote control.

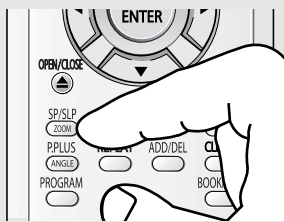

- 4**  
The mark is displayed.



Press the ENTER button repeatedly to zoom in on.

- DVD or VCD: 2X, 3X, 4X, 1/2X, 1/3X, 1/4X in order.
- Press the UP/DOWN▲▼ or LEFT/RIGHT ◀▶ button to select the part of the screen you want to zoom in on (2X/3X/4X).

## DVD OPERATION

### Using the Bookmark Function (DVD/VCD)

This feature lets you bookmark sections of a DVD or VCR so you can quickly find them at a later time.

- 1**  
Press the DVD MENU button during play.



- 2**  
Press the UP/DOWN▲▼ button to select Function.  
Press the ENTER button.  
  
Press the UP/DOWN▲▼ button to select Bookmark.  
Press the ENTER button.

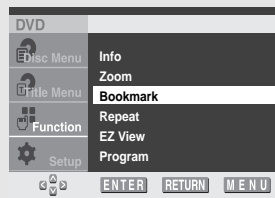

- 3**  
You can display by simply pressing the BOOKMARK button on the remote control.

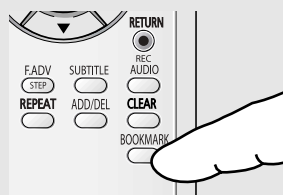

- 4**  
Press the LEFT/RIGHT◀▶ buttons to move to the desired bookmark icon.

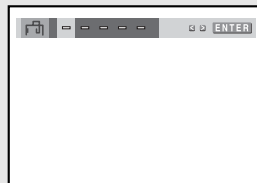

- 5**  
When you reach the scene you want to mark, press the ENTER button.  
The icon will change to a number (1, 2, or 3).

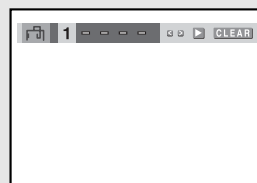

- Press the **BOOKMARK** button to turn off the display.

# DVD OPERATION

## Recalling a Marked Scene

**1**  
During playback, press the **BOOKMARK** button.  
A marker will be displayed.

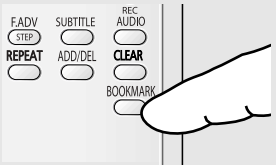

**2**  
Press the **LEFT/RIGHT** buttons to select a marked scene.



**3**  
Press the **PLAY/PAUSE** button to skip to the marked scene.



## Clearing a Bookmark

**1**  
During playback, press the **BOOKMARK** button.  
A marker will be displayed.

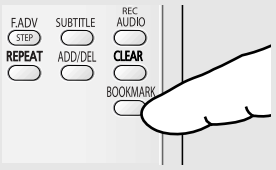

**2**  
Press the **LEFT/RIGHT** buttons to select the bookmark number you want to delete.



**3**  
Press the **CLEAR** button to delete a bookmark number.  
Press the **BOOKMARK** button to turn off display.



- Up to three scenes may be marked at the same time.
- Depending on the disc, the Bookmark function may not work.

## DVD OPERATION

### Repeat Play

Repeat the current track, chapter, title, a chosen section (A-B), or all of the disc.

**1**

Press the DVD MENU button during play.



**2**

Press the UP/DOWN▲▼ button to select Function. Press the ENTER button.

Press the UP/DOWN▲▼ button to select Repeat. Press the ENTER button.

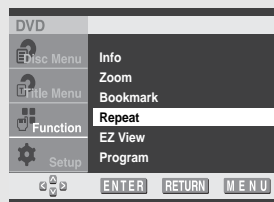

**3**

You can display by simply pressing the REPEAT button on the remote control.

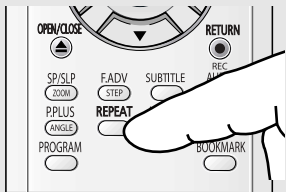

#### A-B Repeat

- ❶ Press the REPEAT button. Select A-. Press the ENTER button at the point where you want the repeat play to start.
- ❷ Press the LEFT/RIGHT◀▶ button to select B. Press the ENTER button at the point where you want the repeat play to stop.
- ❸ To return to normal play, press the LEFT/RIGHT◀▶ button to select Off and press the ENTER button.

## DVD OPERATION

### 4

Press the LEFT/RIGHT ◀▶ button to select the chapter, title or A-B.  
Press the ENTER button.

#### DVD

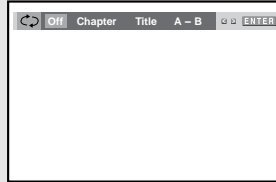

#### VCD/CD



#### **Note**

- DVD repeats playback by chapter or title, CD and VCD repeat playback by disc or track.
- Depending on the disc, the Repeat function may not work.
- If the title or track is completed before marking the end (B), the end of title or track becomes B automatically.



## DVD OPERATION

### Using the EZ View (Depending on the model)

You can adjust the screen setting (aspct ratio) which best corresponds to your viewing requirements.

- 1**  
Press the DVD MENU button during play.



- 2**  
Press the UP/DOWN▲▼ button to select Function.  
Press the ENTER button.  
  
Press the UP/DOWN▲▼ button to select EZ View.  
Press the ENTER button.

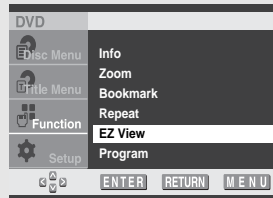

- 3**  
Select the appropriate option (Wide, Screen Fit, Normal/LB, or Normal/PS) by pressing the LEFT/RIGHT ◀▶ button.



- **Wide, Normal/LB, Normal/PS**

Refer to page 22.

- **SCREEN FIT**

The top and bottom of the screen are cut off.  
When playing a 2.35:1 aspect ratio disc, the black bars at top and bottom of the screen will disappear. The picture will look vertically stretched. (Depending on the type of disc, the black bars may not disappear completely.)

## DVD OPERATION

### Program Play (CD)

#### Program Playback

- 1**  
Press the DVD MENU button during play.



- 2**  
Press the UP/DOWN▲▼ button to select Function. Press the ENTER button.  
  
Press the UP/DOWN▲▼ button to select Program. Press the ENTER button.

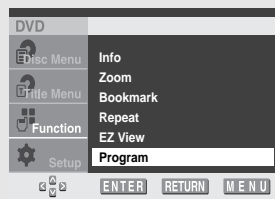

- 3**  
Press the numeric buttons to select the first track to add to the program.

Selected numbers are displayed in the first track.

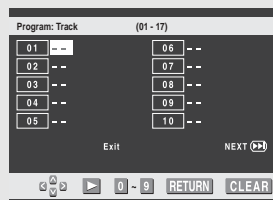

- 4**  
Press the UP/DOWN▲▼ or LEFT/RIGHT◀▶ button to move the next tray. Follow the above instruction for programming.

Press the PLAY/PAUSE (▶/||) button.

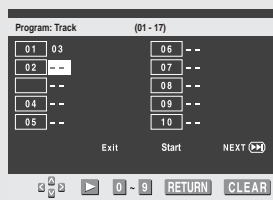

◀ The disc will be played in programmed order.

- Depending on the disc, this function may not work.
- Press the STOP button twice to cancel Program Play during playback.
- Opening the tray by pressing the OPEN/CLOSE button cancels Program Play.

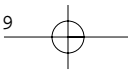

# DVD OPERATION

## Changing the Camera Angle

When a DVD contains multiple angles of a particular scene, you can select the Angle function.

**1**  
Press the ANGLE button.  
Press the LEFT/RIGHT ◀▶ button to select the desired screen angle.  
To turn off the display, press the ANGLE button again.

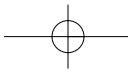
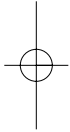
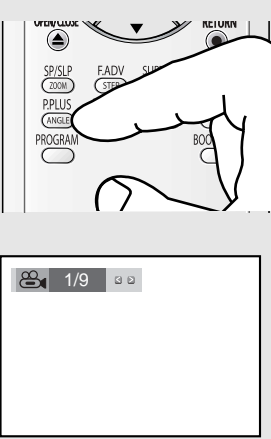

## DVD OPERATION

### Setting up the Language Features

If you set the player menu, disc menu, audio and subtitle language in advance, they will come up automatically every time you watch a movie.

- 1**  
Press the DVD MENU button during play.



- 2**  
Press the UP/DOWN▲▼ button to select Setup.  
Press the ENTER button.  
The Language Setup menu is selected.  
Press the ENTER button again.

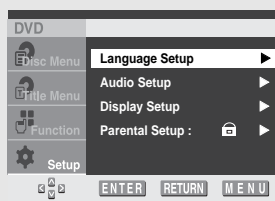

- 3**  
Press the UP/DOWN▲▼ button to select the required menu (Player Menu, Disc Menu, Audio, or Subtitle).  
Press the ENTER button.  
Select the appropriate language by pressing the UP/DOWN▲▼ button.  
Press the ENTER button.

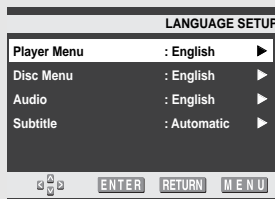

◀ This function depends on what languages are encoded on the disc and may not work with all DVDs. If the selected language is not recorded on the disc, the original pre-recorded language is selected.

- **Player Menu**  
Use the Player preference menu to select the language for the player's on-screen displays.
  - **Disc Menu**  
Use the Menu preference menu to select the language you want a DVD's disc menu to be displayed in.  
- Select Others if the language you want is not listed.
  - **Audio**  
Use the Audio preference menu to select the sound-track language.  
- Select Original if you want the default soundtrack language to be the original language the disc is recorded in.  
- Select Others if the language you want is not listed.
  - **Subtitle**  
Use the Subtitle preference menu to select the language the disc's subtitles are to be displayed in.  
- Select Automatic if you want the subtitle language to be the same as the language selected as the audio preference.  
- Select Others if the language you want is not listed. Some discs may not contain the language you select as your initial language; in that case the disc will use its original language setting.
- You can select by simply pressing the SUBTITLE button on the remote control.

## DVD OPERATION

### Setting up the Audio Options

If you set the player menu, disc menu, audio and subtitle language in advance, they will come up automatically every time you watch a movie.

**1**

Press the DVD MENU button during play.



**2**

Press the UP/DOWN▲▼ button to select Setup. Press the ENTER button.

Press the UP/DOWN▲▼ button to select Audio Setup. Press the ENTER button.

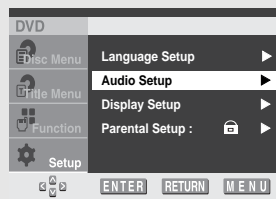

**3**

Press the UP/DOWN▲▼ button to select the required menu (Digital Output or Dynamic Compression).

Select the appropriate option by pressing the LEFT/RIGHT◀▶ button.

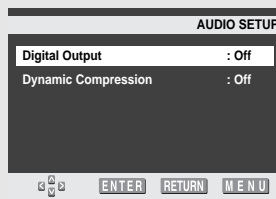

---

• **Digital output : Off, Bitstream, PCM**

Select **Bitstream** when using the Digital Audio Output. Converts to Dolby Digital Bitstream - 5.1CH (in case of MPEG-2, 5.1CH or 7.1CH).

Select **PCM** when using the Analog Audio Outputs. Converts to PCM(2CH) audio.

---

• **Dynamic Compression**

- **Off** : To select the standard range.
- **On** : To select dynamic compression.

---

Manufactured under license from Dolby Laboratories. "Dolby" and the double-D symbol are trademarks of Dolby Laboratories.

"DTS" and "DTS Digital Out" are trademarks of Digital Theater Systems, Inc.

## DVD OPERATION

### Setting up the TV Aspect

You can adjust the screen setting (aspect ratio) which best corresponds to your viewing requirements.

- 1**  
Press the DVD MENU button during play.



- 2**  
Press the UP/DOWN▲▼ button to select Setup.  
Press the ENTER button.

- Press the UP/DOWN▲▼ button to select Display Setup.  
Press the ENTER button.

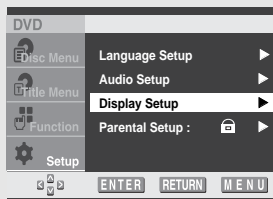

- 3**  
The options available in the Display Setup group are displayed with the TV Aspect selected.  
Press the ENTER button.

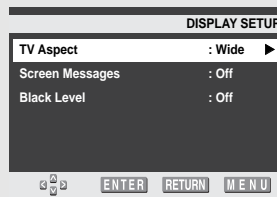

- 4**  
Select the required aspect by pressing the UP/DOWN▲▼ button.  
Press the ENTER button.

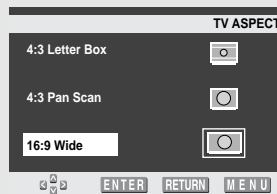

**4:3 Letter Box** : Select when you want to see the total 16:9 ratio screen DVD supplies. Black bars will appear at the top and bottom of the screen.

**4:3 Pan Scan** : Select this for conventional size TVs when you want to see the central portion of the 16:9 screen. (Extreme left and right side of movie picture will be cut off.)

**16:9 Wide** : You can view the full 16:9 picture on your widescreen TV.

## DVD OPERATION

### Setting up the Display Options

- 1**  
Press the DVD MENU button during play.



- 2**  
Press the UP/DOWN▲▼ button to select Setup.  
Press the ENTER button.

Press the UP/DOWN▲▼ button to select Display Setup.  
Press the ENTER button.

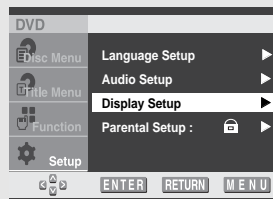

- 3**  
Press the UP/DOWN▲▼ button to select the required menu (Screen Messages, Black Level).  
Select the appropriate option by pressing the LEFT/RIGHT◀▶ button.

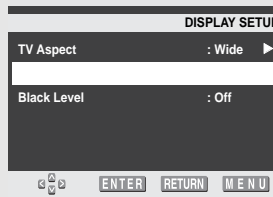

**Screen Messages : On or Off.**

Use to turn on-screen messages on or off.

**Black Level : On or Off.**

Adjusts the brightness of the screen.

## DVD OPERATION

### Setting up the Parental Control

- 1**  
Press the DVD MENU button during play.



- 2**  
Press the UP/DOWN▲▼ button to select Setup. Press the ENTER button.

Press the UP/DOWN▲▼ button to select Parental Setup. Press the ENTER button.

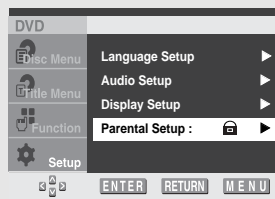

- 3**  
Enter the default password (0000) by using the numeric buttons.

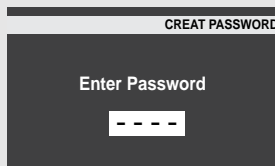

- 4**  
Select Yes by pressing the RIGHT ► button to use a password.

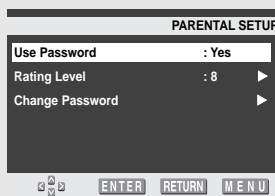

◀ The options available in the Parental Setup group are displayed with the Use Password selected. If you have lost your password, enter the master password (1369).



## DVD OPERATION

### 5

About the Rating Level;

- 1 Press the UP/DOWN ▲▼ button to select Rating Level. Press the ENTER button.

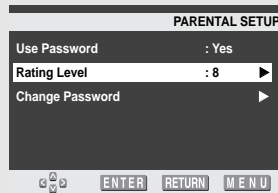

- 2 Press the UP/DOWN ▲▼ button to select the level (e.g. Level 8) and press the ENTER button. Discs that contain Level 7 will now not play.

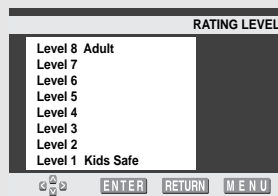

To cancel the rating level, select No in the Use Password pressing the RIGHT ► button.

### 6

About Change Password;

- 1 Press the UP/DOWN ▲▼ button to select Change Password. Press the ENTER button.

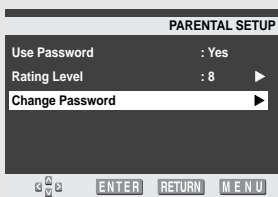

- 2 Enter your new password.

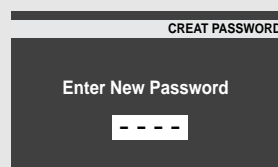

- 3 Enter your new password again to confirm.

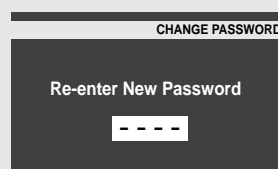

# Chapter Five

## VCR OPERATION

In this chapter, you will learn how to play a video cassette tape, how to use the time counter and memory stop features, and how to record a program as you are watching TV.

### Inserting and Ejecting a Video Cassette Tape

To insert a video cassette tape,

**1**

Hold the video cassette tape window-side up with the arrow pointing away from you.

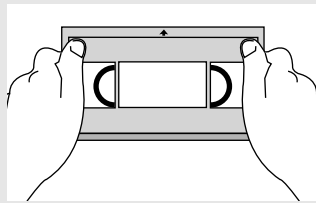

**2**

Gently push the tape through the compartment door until you feel the VCR pull it.

The VCR loads the tape automatically.

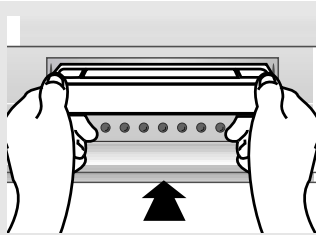

◀ Don't try to insert a tape upside down or backwards.

Use only video tapes labeled "VHS." European PAL VHS video tapes and S-VHS pre-recorded tapes aren't compatible with this unit. Choose brand name, high quality tapes for best results.

◀ If the power is off when you insert a tape, the TV turns on automatically.

If the safety tab of your video tape has been removed, the tape begins to play automatically. You don't have to press PLAY. For more information on the safety tab, see page A.3.

To eject a video cassette tape,

**1**

Press the **STOP** (■) button to stop playing the tape.



**2**

Press the **STOP/EJECT** button on the front control to eject the tape.



◀ When you're finished playing a pre-recorded video tape, it's best to rewind it to the beginning and remove it from the VCR to protect it from wear and tear.

◀ After ejecting a tape, you should remove it completely from the compartment and turn off the VCR.

## VCR OPERATION

### Playing a Pre-Recorded Video Cassette Tape

#### Playing the Tape

- 1**  
Insert the video cassette tape.

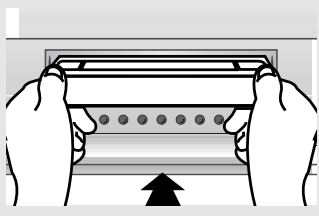

◀ For information on inserting a video tape, see page 5.1.

- 2**  
If the tape doesn't begin to play automatically, press the **PLAY/PAUSE** (▶/||) button.



#### Pausing

- 1**  
While a tape is playing, press the **PLAY/PAUSE** (▶/||) button when you want to interrupt play.

The tape pauses temporarily.



◀ The VCR does not play sound while a video tape is paused.

See "Using Automatic Tracking" on the next page.

- 2**  
Press the **PLAY/PAUSE** (▶/||) button to resume playing the tape.



If the tape is still paused after five minutes, the TV/VCR automatically play the tape and switches to the TV mode to protect the video heads from excessive wear.

## VCR OPERATION

### Using Picture Search

Picture search lets you quickly search a pre-recorded video tape for a particular scene.

**1**

While playing a tape, press and release the **FWD(▶▶)** or **REW(◀◀)** button.

The images from the tape are displayed on the screen at a high speed.



◀ For information on inserting and playing a tape, see page 5.1 and 5.2.

There's no sound while you search for a picture at high speeds.

There may be some horizontal streaks on the screen while you search.

**2**

When you find the scene you want, press and release the **FWD(▶▶)** or **REW(◀◀)** button again to resume playing the tape at regular speed.



This technique is good if you're searching through only a small amount of tape. If you want to search through a large amount of tape, stop the tape before pressing FF or REW.

### Using Automatic Tracking

Automatic tracking adjusts a video tape's tracking automatically in just a few seconds.

**1**

Insert and play a video cassette tape.

As soon as the tape begins to play, the VCR begins automatic tracking.

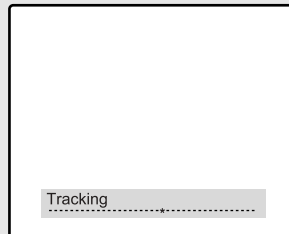

◀ For information on inserting and playing a tape see page 5.1 and 5.2.

The tracking display will appear the first time a tape is played after being placed in the VCR, when there is a change in tape speed, or when you press the TRK buttons.

**2**

If automatic tracking doesn't remove the streaks from the picture, press and hold the **TRK ^** or **TRK v** button until the streaks disappear.



◀ These two buttons can also be used to do vertical lock control.

**Vertical Lock Control**  
To reduce vertical jitter of the image in STD.L mode.

## VCR OPERATION

### Using the Time Counter

The time counter allows you to keep track of how much time (in hours, minutes, and seconds) has elapsed on the video tape you're watching. The counter can also be useful if you want to find a specific point on a pre-recorded tape.

**1**

While a tape is playing, press the **INFO** button twice.



◀ For information on inserting and playing tapes see page 5.1 and 5.2.

**2**

The time counter appears in the upper left corner of the screen.

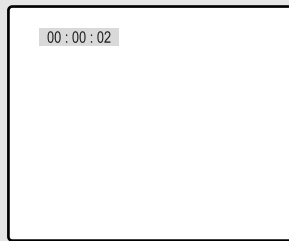

◀ The counter displays time only for recorded sections of tape. Blank tapes or blank sections of tapes do not affect the counter display.

**3**

Press the **CLEAR** button to set the counter to "00:00:00."

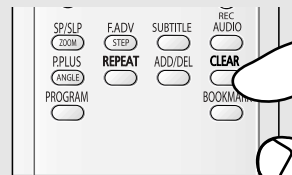

◀ The VCR automatically resets the counter to "00:00:00" when you eject a tape.

**4**

Press the **INFO** button twice again to remove the time counter from the screen.



## VCR OPERATION

### Using Memory Stop

Memory stop makes it easy for you to find a particular scene in a video tape. The VCR automatically stops rewinding or fast forwarding when the memory counter is at "00:00:00," so you simply need to mark the desired scene as "00:00:00." Then, you'll be able to search for that place the next time you watch the tape.

**1**

While playing a tape, when you reach the scene you want, press the **INFO** button twice.



◀ For information on inserting and playing a tape see page 5.1 and 5.2.

**2**

The time counter appears in the upper left corner of the screen.

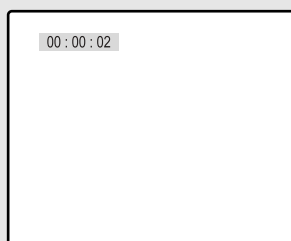

**3**

Press the **CLEAR** button to reset the timer to "00:00:00."

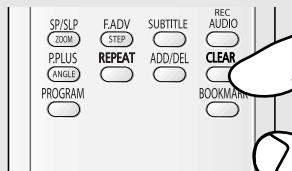

**4**

Press **INFO** again to enter the scene into memory.



**5**

The letter "M" appears beside the time counter.



◀ If you want to remove the time counter memory from the screen and cancel the memory stop feature, just press the **INFO** button again.

## VCR OPERATION

To return to the scene you marked,

- 1**  
Press the **STOP** (■) button.



- 2**  
Press the **FWD** (▶▶) or **REW** (◀◀) button to return to the scene you marked.

The VCR stops the tape when the counter reaches "00:00:00M."



- 3**  
Press the **PLAY/PAUSE** (▶/||) button to view the scene again.



◀ For this feature to work, the time counter and the letter "M" must still be on the screen. If this isn't the case, press the INFO button until the time counter and the letter "M" are both on the screen.

## Using P.PLUS

Press P.PLUS to compensate for a poor rental tape.

- 1**  
Insert a tape and press the **PLAY/PAUSE** (▶/||) button.



- 2**  
Press the **P.PLUS** button, and "Picture plus Off" appears on the screen.

Press the **P.PLUS** button again to turn to "Picture plus On". The Picture Plus functions only when a tape is being played.

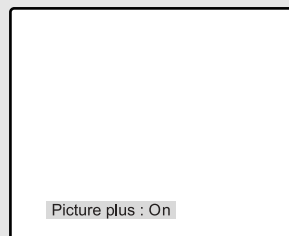

◀ If the tape is ejected and reinserted, the Picture Plus feature will be Off.

## VCR OPERATION

### Recording TV Programs As You Watch

#### Recording

**1**

With your VCR turned on, and with a tape in the unit, press the **SP/SLP** button.

The tape speed appears in the the screen.

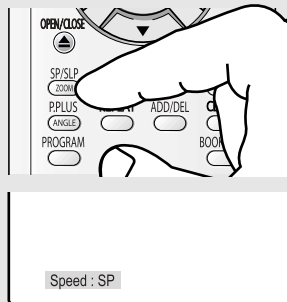

◀ For information on inserting a video tape, see page 5.1.

Be sure the record safety tab is in place. For information on the record safety tab, see page A.2.

**2**

Press the **SP/SLP** button repeatedly until the speed you want (SLP or SP) appears.

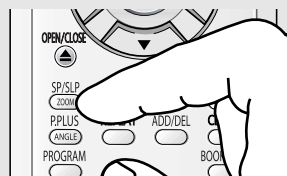

◀ SP (Standard Play) is the most common speed for recording. For more information on tape speeds, see page A.2.

**3**

Select the TV channel you want by pressing the **CH**  $\wedge$  or **CH**  $\vee$  button or by using the number buttons.



◀ If you are using the number buttons to select the channel, press 0 before a single-digit channel number. For example, to select channel 5, press 0, 5.

**4**

Press the **REC** button. The record indicator on the control panel illuminates and the VCR begins recording.

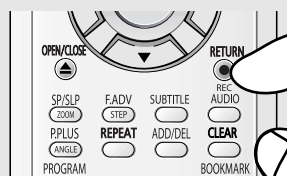

#### Notes:

- The VCR automatically stops recording and rewinds when it reaches the end of the tape.
- Press the **STOP** button at any time to stop recording.
- We don't recommend changing tape speeds while a recording is in progress. Doing so may cause distortion of the picture during playback.
- When you're finished recording, rewind the tape to the beginning and remove it from the VCR to protect the tape.
- When pressing the **REC** button on the front panel during DVD playback, the DVD will be recorded on the VCR tape. If your DVD title has been equipped with a Copy Protect technology, it can't be recorded on the VCR tape.
- You can play a DVD by switching into the DVD mode during channel recording.
- You can't play a DVD by switching into DVD mode during A/V recording.
- Mode Switching doesn't operate during recording in DVD mode.



## VCR OPERATION

### Editing While Recording

You can edit while recording, selecting only those scenes you want to record from the current television program. This is especially helpful if you want to record a program without the commercials.

**1**

Be sure you have begun recording and that the record indicator light on the front panel is illuminated.

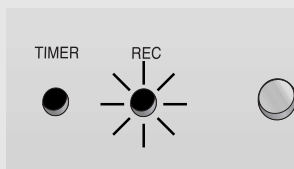

◀ For information on recording, see page 5.6.

**2**

Press the **PLAY/PAUSE** (▶/||) button on the front panel to temporarily stop recording.



◀ After ten minutes in the pause mode, the VCR automatically stops the tape and switches to TV mode to protect the video heads from excessive wear. If this happens, press REC to resume recording.

**3**

To resume recording, press the **REC** button on the front panel or remote control again.

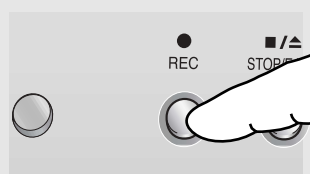

## VCR OPERATION

### Using Advanced Recording Features

#### Using One-Touch Recording

One-touch recording (OTR) lets you record television programs with the touch of a button. You can even program the length of time (up to four hours) that you want to record.

**1**

Insert a video cassette tape, set the tape speed, and select the channel you want to record.

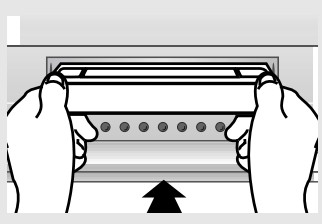

◀ For information, see “Recording Programs As You Watch” on page 5.7

The VCR won't record on a video cassette tape if the record safety tab on the tape has been removed. For information on the record safety tab, see page A.3.

**2**

Press the **REC** button repeatedly until the time you want appears.

The VCR begins recording.



Your recording time options are: 30 minutes, 1 hour, 1 hour and 30 minutes, 2 hours, 3 hours, or 4 hours.

You can increase the length of time you want to record at any time during the recording process by pressing the **REC** button again and choosing additional time.

If you want to stop recording before the time is up, press the **REC** button until the OTR display shows “0:00.” The recording stops after a few seconds. Or, press the **POWER** button on the front panel, then immediately press the **STOP/EJECT** button.

**Note:** In DVD mode, the OTR function doesn't operate with the **REC** button on the front panel. A normal recording only operates.

## VCR OPERATION

### Recording at a Later Time

You can set the built-in timer for unattended recording of up to eight different TV programs. The timer can turn on the TV at the time you select, record for a selected length of time, and then turn off the TV – all without you being there.

You can also choose to record a program one time, daily (every day, Monday through Friday), or weekly (the same day every week.)

#### 1

Press the **MENU** button.

Press the **UP/DOWN▲▼** button to select "VCR Setup", then press the **LEFT/RIGHT◀▶** button.

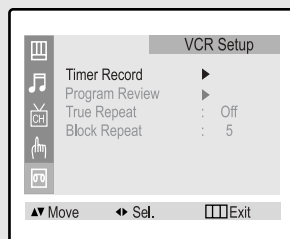

◀ The clock must be set to the correct time and date before you program the timer. For more information on setting the clock, see page 3.19 and 3.20.

#### 2

Press the **UP/DOWN▲▼** button to select "Timer Record", then press the **LEFT/RIGHT◀▶** button.

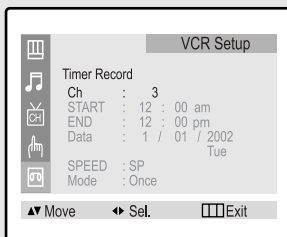

#### 3

Press the **RIGHT▶** button. Press the **UP/DOWN▲▼** buttons to select the channel you want to record.

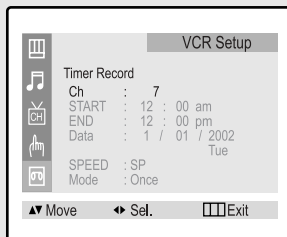

#### 4

Press the **UP/DOWN▲▼** button to select "START".

Press the **RIGHT▶** button. The Starting hour will select. Press the **UP/DOWN▲▼** buttons to select the hour when you want to begin recording.

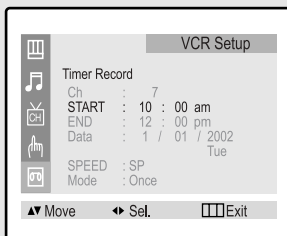

## VCR OPERATION

### 5

Press the RIGHT ► button, then press the UP/DOWN▲▼ buttons to select the minute when you want to begin recording.

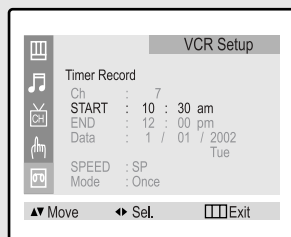

◀ The VCR automatically selects am or pm for the starting time.

### 6

Press the UP/DOWN▲▼ button to select "END".

Press the RIGHT ► button. The ending hour will select.

Press the UP/DOWN▲▼ buttons to select the hour when you want to end recording.

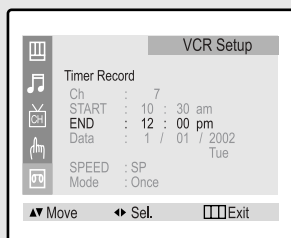

### 7

Press the RIGHT ► button, then press the UP/DOWN▲▼ buttons to select the minute when you want to end recording.

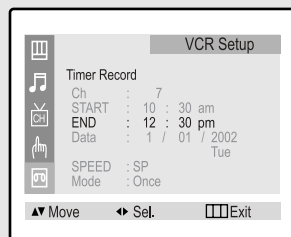

◀ The VCR automatically selects am or pm for the ending time.

### 8

Press the RIGHT ► button. The month will select. Press the UP/DOWN▲▼ buttons to select the month when you want to begin recording.

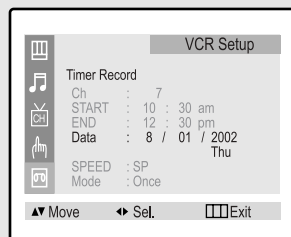

### 9

Press the RIGHT ► button, then press the UP/DOWN▲▼ buttons to select the day when you want to begin recording.

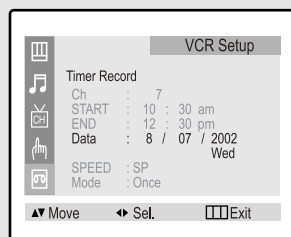

◀ If you enter two program times that overlap, a program overlap warning appears on the TV screen, along with instructions for fixing the overlap.

The REC indicator on the front panel of the VCR is lit when program times are stored.

## VCR OPERATION

### 10

Press the UP/DOWN▲▼ button to select "SPEED", then press the LEFT/RIGHT◀▶ buttons to select speed at which you want to record.

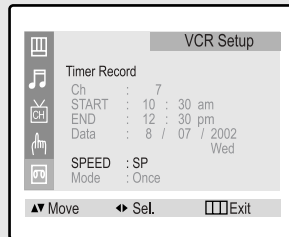

◀ For more information on selecting tape speeds, see pages 5.6, 5.7, and A.2.

### 11

Press the UP/DOWN▲▼ button to select "Mode", then press the UP/DOWN▲▼ buttons to select "Once", "Wkly", or "Dly".

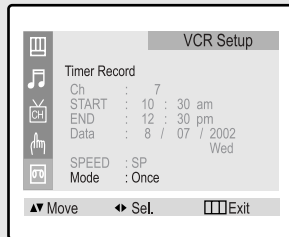

### 12

Press the **MENU** button to exit the menu system and return to normal viewing.

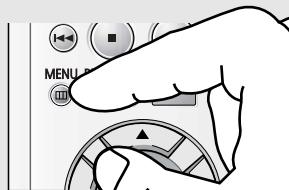

◀ To enter additional program recording times, repeat steps 1-11.

If you enter two program times that overlap, a program overlap warning appears on the TV screen, along with instructions for fixing the overlap.

The timer indicator on the front panel of the TV illuminates when program times have been stored.

The TV should be turned off to record the programs you've chosen.

### 13

Press the **POWER** button to turn off the VCR.

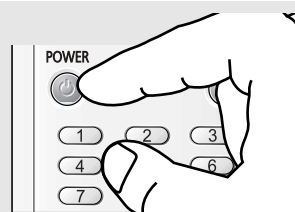

#### IMPORTANT:

- The TV should be off to record the programs you've chosen. But, if you are recording a channel that comes through a cable box, be sure to leave the cable box turned on and tuned to the channel you want to record.
- When a timer recording is in progress, there is no picture on the monitor because the power is off. If you want to watch the channel while it's being recorded, press **POWER on the remote control only**.
- One-time timer programs clear from memory automatically when the recording is finished. Daily and weekly programs remain in the timer until you remove them. If power to the TV is interrupted, timer program will be removed from memory. The clock and calendar, however, must be reset.

## VCR OPERATION

### Using Program Review

Program Review allows you to review all of the programmed recordings currently stored in the VCR's memory and to remove a programmed recording quickly and easily.

**1**

Press the **MENU** button.

Press the UP/DOWN▲▼ button to select "VCR Setup", then press the LEFT/RIGHT◀▶ button.

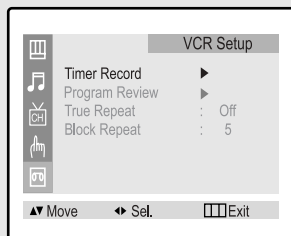

**2**

Press the UP/DOWN▲▼ button to select "Program Review", then press the LEFT/RIGHT◀▶ button.

The information for the first program appears on the screen.

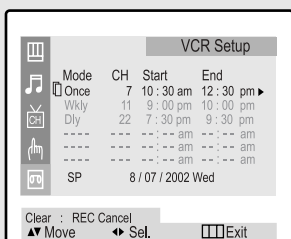

◀ Program Review is only available if you have programmed your VCR to record at a later time.

**3**

To see the information for the program number, press the RIGHT▶ button.

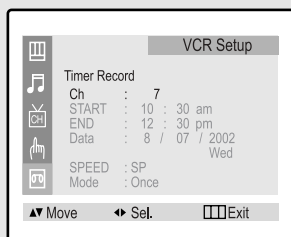

◀ If you're recording through a cable box, the Program Review screen displays the output channel of the cable box as the channel number to be recorded.

**4**

If you want to remove a program from memory, press the **CLEAR** button when the program you want to erase appears on the screen. That program is erased from memory.

Press the **MENU** button to exit.

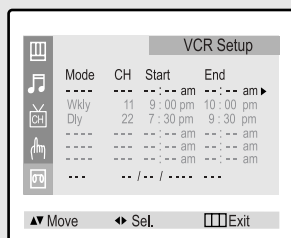

◀ The VCR is equipped with a program memory backup that saves all the timer program information if the power to the VCR is interrupted. If the unit has been without power, all of the timer program information will be disabled, until you reset the clock. When the clock is reset, the programs will be restored.

## VCR OPERATION

### Using True Repeat

You can set your VCR to automatically repeat a tape or a section of tape. When you use True Repeat, your VCR will play until it reaches the end of a tape. Then, it will rewind to the beginning of the tape and begin playing again.

**1**

Press the **MENU** button.

Press the **UP/DOWN▲▼** button to select "VCR Setup", then press the **LEFT/RIGHT◀▶** button.

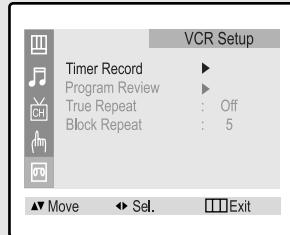

◀ For information on viewing the main menu, see page 3.1. For information on viewing the VCR setup menu, see page 5.10.

**2**

Press the **UP/DOWN▲▼** button to select "True Repeat", then press the **LEFT/RIGHT◀▶** button to select "On".

Press **MENU** to return to normal viewing.

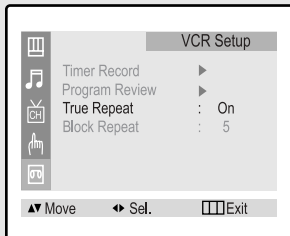

**3**

Insert and play a pre-recorded video cassette tape.

The VCR will play the tape until it reaches the end of the tape. Then, the VCR will stop the tape, rewind it to the beginning, and begin playing again.

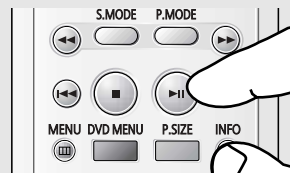

◀ For information on inserting and playing a tape, see pages 5.1 and 5.2.

If the VCR reaches an unrecorded section of tape before it reaches the end, it will search forward and check the tape again. If it finds a recorded section of tape, it will begin playing. If the tape is still blank, it will continue to search forward, until it reaches the end of the tape.

**4**

Press the **STOP** button to end the repeat.

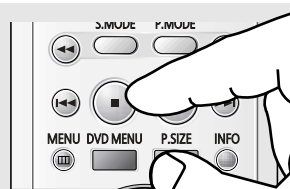

## VCR OPERATION

### Using Block Repeat

Block repeat allows you to repeat a section of tape that you select. You can repeat this section of tape (the "block") from one to ten times, or endlessly.

**1**

Press the **MENU** button.

Press the **UP/DOWN** button to select "VCR Setup", then press the **LEFT/RIGHT** button.

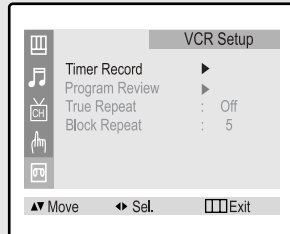

◀ For information on viewing the menu, see page 3.1. For information on viewing the VCR setup menu, see page 5.10.

You can choose to have your "block" repeat from one to ten times, or endlessly.

**2**

Press the **UP/DOWN** button to select "Block Repeat", then press the **LEFT/RIGHT** button to select the number of times you want your "block" to repeat.

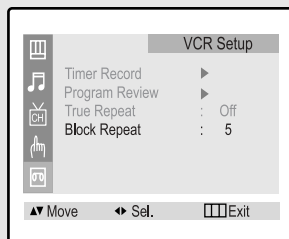

Press the **MENU** button to return to normal viewing.

**3**

Insert and play a pre-recorded video cassette tape.

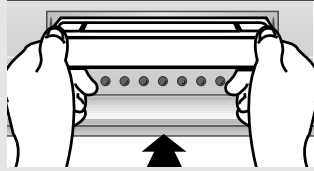

◀ For information on inserting and playing a tape, see pages 5.1 and 5.2.

**4**

Press the **REPEAT** button at the beginning of the "block" you want to repeat.

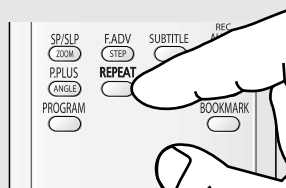

◀ "Repeat" section should be set up at a minimum five-second interval.

**5**

When you reach the end of the "block," press the **REPEAT** button again.

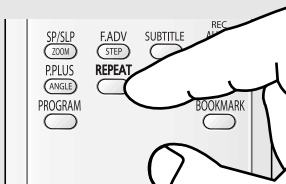

◀ The word "Repeat" will appear on the screen.

The VCR will rewind the tape to beginning of the block and repeat it.  
The VCR will repeat the block as many times as the number you set in step 2.

To stop block repeat, press the **STOP**, or **POWER** buttons. You can also cancel block repeat by fast forwarding or rewinding to a point outside the "block."



## VCR OPERATION

### Using the HiFi Stereo

You can record or listen to a program in HiFi stereo.

#### Selecting the HiFi Mode

**1**

Insert the video cassette tape.  
If the tape doesn't begin to play automatically, press the **PLAY/PAUSE** (▶/||) button.

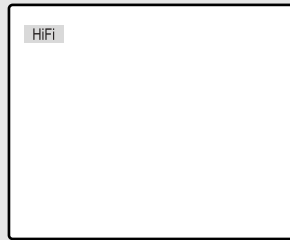

◀ HiFi: High Fidelity which produces better sound than standard stereo VCR.

**2**

Press the MTS button repeatedly to select "Mono," "Stereo," "Left" or "Right".



#### MTS Recording / Monitor Mode

Type of broad	Display on the TV screen	Stereo/SAP Selection	Hi-Fi audio tack (2-channel)		Normal audio track
			L-channel	R-channel	
Regular (Normal audio)	None	Invalid	Mono	Mono	Mono
Stereo broadcast	Stereo	Invalid	L	R	L+R
Bilingual broadcast	SAP	Stereo	Main audio program	Main audio program	Main audio program
		SAP	Sub audio program	Sub audio program	Sub audio progrma
Stereo & Bilingual broadcast	Stereo	Stereo	L	R	L+R
	SAP	SAP	Sub audio program	Sub audio program	Sub audio program

## VCR OPERATION

### Video Dubbing

You can make a copy of another video cassette tape. This is called “dubbing.” To dub, you need:

- your VCR,
- a separate VCR (or camcorder), and
- two A/V cables with connectors. (You can find these at most electronics supply stores.)

We recommend that you play the pre-recorded tape in the separate VCR (or camcorder) and record on your TV.

### Making the Connections

Attach one end of the first cable to the VIDEO/AUDIO OUT connector of the playback VCR (or camcorder) and the other end to the VIDEO/AUDIO IN connector of the TV.

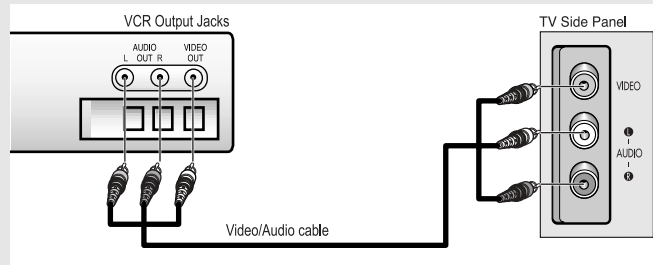

## VCR OPERATION

### Video Dubbing

**1**

Insert the video cassette tape you want to copy into the playback VCR (or camcorder).

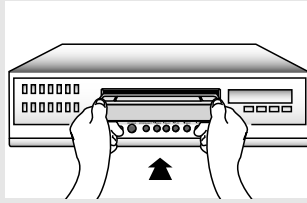

**2**

Insert a blank video tape (or any video tape with the record safety tab intact) into the recording VCR.

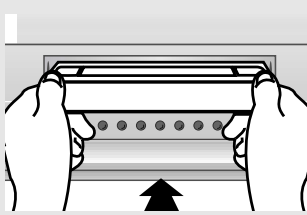

**3**

Press the **INPUT** button on the remote control of the recording VCR.



The words "AV" appear in the upper left corner of the TV screen.

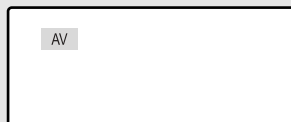

**4**

To begin recording, simultaneously press the **REC** button on the recording TV's remote control and the **PLAY/PAUSE** (▶/||) button on the playback VCR (or camcorder).

**5**

When you are finished, press the **STOP** (■) button on both the VCR (or camcorder) and the TV to stop recording.

**6**

Press the **INPUT** button to return to normal TV viewing.



◀ Important Warning: One Federal Court has held that unauthorized recording of copyrighted TV programs may be an infringement of copyright laws.

◀ The VCR will be recording from the incoming line rather than from the normal broadcast signal.

"AV" will remain on-screen until the **PLAY** button is pressed on the playback VCR.

## VCR OPERATION

### Using Special Playback Features

Your VCR provides you with special features that are available when you are playing a tape. These features are Frame Advance, and Slow Motion.

#### Frame Advance

Frame Advance allows you to watch a tape frame-by-frame.

**1**

While a tape is playing, press the **PLAY/PAUSE** (▶/⏸) button on the remote. If the picture jitters, press the **TRK +/-** button.



**2**

Press the **F.ADV** button repeatedly to move forward frame-by-frame. Do not hold the button down. Press the **PLAY/PAUSE** (▶/⏸) button to resume normal playback.

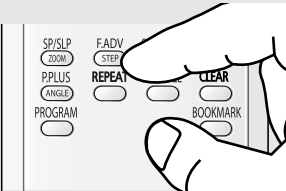

#### Slow motion

You can watch a tape at various slow-motion speeds.

**1**

While a tape is playing, press the **SLOW +** or **SLOW -** button on the remote. If the picture is jittery or shows noise, try using the **TRK** buttons to clear the picture.



**2**

Press the **SLOW +** or **SLOW -** button to adjust the slow motion speed between 1/5 and 1/60 normal speed.



**3**

Press the **PLAY/PAUSE** (▶/⏸) button to resume normal play. There is no sound during slow motion.



◀ It is normal to occasionally see some streaks or jitter during slow motion play.

If slow motion continues for more than five minutes, the VCR may play automatically to protect the tape and video heads.

# Chapter Six

## TROUBLESHOOTING

If the TV seems to have a problem, first try this list of possible problems and solutions. If none of these troubleshooting tips apply, then call your nearest service center.

### Identifying TV Problems

Problem	Possible Solution
Poor picture	Try another channel. Adjust the antenna. Check all wire connections.
Poor sound quality	Try another channel. Adjust the antenna.
No picture or sound	Try another channel. Press the TV/VIDEO button. Make sure the TV is plugged in. Check the antenna connections.
No color, wrong colors or tints.	Make sure the program is broadcast in color. Adjust the picture settings. If the set is moved or turned in a different direction, the power should be OFF for at least 30 minutes.
Picture rolls vertically.	Adjust the antenna. Check all wire connections.
The TV operates erratically	Unplug the TV for 30 seconds, then try operating it again.
The TV won't turn on.	Make sure the wall outlet is working.
Disc does not play.	Ensure that the disc is installed with the label side facing up. Check the region number of the DVD. This player cannot play CD-ROMs, DVD-ROMs, CD-R, etc. Insert a DVD, a VIDEO-CD or a CD.
5.1 channel sound is not being reproduced.	5.1 channel sound is reproduced only when the following conditions are met. : 1) The DVD player is connected with the proper amplifier. 2) The disc is recorded with 5.1 channel sound. <ul style="list-style-type: none"> <li>• Check whether the disc being played has the "Dolby 5.1 ch" mark on the outside.</li> <li>• Check if your audio system is connected and working properly.</li> </ul>

## TROUBLESHOOTING

## Identifying DVD Problems

Problem	Possible Solution
Disc does not play.	Ensure that the disc is installed with the label side facing up. Check the region number of the DVD. This player cannot play CD-ROMs, DVD-ROMs, CD-R, etc. Insert a DVD, a VIDEO-CD or a CD.
5.1 channel sound is not being reproduced.	5.1 channel sound is reproduced only when the following conditions are met. : 1) The DVD player is connected with the proper amplifier. 2) The disc is recorded with 5.1 channel sound. <ul style="list-style-type: none"> <li>• Check whether the disc being played has the “Dolby 5.1 ch” mark on the outside.</li> <li>• Check if your audio system is connected and working properly.</li> </ul>
The  icon appears on screen.	The features or action cannot be completed at this time because : 1) The DVD's software restricts it. 2) The DVD's software doesn't support the feature (e.g., angles). 3) The feature is not available at the moment. 4) You've requested a title or chapter number or search time that is out of range.
Disc Menu doesn't appear.	Check if the disc has a Menu.
Playback mode differs from the Setup Menu selection.	Some of the functions selected in the Setup Menu may not work properly if the disc is not encoded with the corresponding function.
The screen ratio can not be changed.	The Screen Ratio is fixed on your DVDs.
No audio.	Make sure you have selected the correct Digital Output in the Audio Options Menu.
If you experience other problems.	Go to the contents and find the section of the instruction book that contains the explanations regarding the current problem, and follow the procedure once again. If the problem still cannot be solved, please contact your nearest authorized service center.

## TROUBLESHOOTING

### Identifying VCR Problems

Problem	Possible Solution
Unit won't turn on.	Make sure the unit is plugged into a working wall outlet. Press the POWER button.
Unit won't take video tape	Make sure the tape is window-side up with the arrow pointing away from you. Make sure there is no other tape in the compartment.
Unit didn't record a program.	Make sure the antenna or cable is connected and that the TV/VCR is receiving the broadcast signal. Make sure the record safety tab is intact.
Unit didn't record a timer program.	Make sure the unit was turned off. Check the programmed start and stop times. Make sure the time is set correctly.
There is no picture, the picture is distorted during video tape playback, or there is noise or streaks in the picture.	Adjust the tracking. Clean the video heads. Make sure there has been a recording on the tape.
You can't receive regular broadcasts.	Check the antenna or cable connections.
Rewind command doesn't work.	Make sure the VCR is not in pause mode. Make sure the tape hasn't already been rewound.
Fast forward command doesn't work.	Make sure the VCR is not in pause mode. Make sure the tape hasn't already been forwarded.
Picture is streaked during pause mode.	This is normal for SP and LP recordings.



## APPENDIX

### **Cleaning and Maintaining Your 3Way Combination Unit**

With proper care, your 3way combination unit will give you many years of service. Please follow these guidelines to get the maximum performance from your 3way combination.

#### **Placement**

- Do not place the 3way combination near extremely hot, cold, humid or dusty places.
- Do not place the 3way combination near appliances with electric motors that create magnetic fields, such as vacuum cleaners.
- Keep the ventilation openings clear; do not place the 3way combination on a soft surface, such as cloth or paper.
- Place the 3way combination in a vertical position only.

#### **Liquids**

- Do not handle liquids near or on the 3way combination. Liquids that spill into it can cause serious damage.

#### **Cabinet**

- Never open the cabinet or touch the parts inside.
- Wipe your 3way combination with a clean, dry cloth. Never use water, cleaning fluids, wax, or chemicals.
- Do not put heavy objects on top of the cabinet.

#### **Temperature**

- If your 3way combination is suddenly moved from a cold to a warm place, unplug the power cord, and allow at least two hours for moisture that may have formed inside the unit to dry completely.

### **Using Your 3Way Combination Unit in Another Country**

If you plan to take your 3way combination with you to a foreign country, please be aware of the different television systems that are in use around the world. A 3way combination designed for one system may not work properly with another system due to differences in the 3way combination channel frequencies



## APPENDIX

# Learning About Video Cassette Tapes

## Choosing the Proper Tapes

Use only video cassette tapes marked VHS with this VCR. Choose good quality tapes for best results.

## Caring for Video Cassette Tapes

- Keep the tapes away from direct sunlight, heat or extreme cold.
- Insert tapes with the window side up and the arrow pointing away from you.
- Do not subject tapes to violent vibrations or shocks.
- Never try to take apart or splice a video tape.
- Do not open the cassette, touch the tape, or put anything inside the video tape cartridge.
- Read the instructions supplied with a video tape

## Choosing the Correct Recording Speed

Your VCR is equipped with variable tape speed. You can play or record a tape at:

- **SP** (Standard Play)—the fastest speed,
- **SLP** (Super Long Play)—the slowest speed.

When you are playing a tape, your VCR automatically selects the proper speed, even if segments of the tape have been recorded at a different speed.

When you are recording, the slower the tape speed you use, the longer the tape runs and the more program material it holds. SP provides the clearest record/playback picture, but special effects such as still picture work best in the SLP mode.

Use this chart to determine which tape speed to select when you are recording:

TAPE	SP	SLP
T-60	1hr.	3hrs.
T-120	2hrs.	6hrs.
T-160	2hrs. 40 mins.	8hrs.

## APPENDIX

### Using the Record Safety Tab

Most video cassette tapes have a safety tab that prevents accidental erasure. The safety tab is on the end of the tape opposite from where the arrow points.

The tab must be intact to record. You can record over and over on the same tape as long as the tab is intact. If you want to protect a tape from accidental erasure, break off the tab with a screwdriver, as shown here.

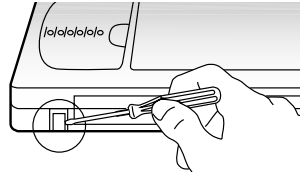

If you wish to erase a recorded tape or to record on a cassette with the tab removed, cover the hole with cellophane tape.

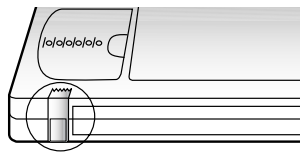

### Sending Tapes to Another Country

Because various TV standards are used throughout the world, we recommend that you check for compatibility before sending your tapes to a foreign country. Tapes made on machines sold in the U.S.A. can be played back only on units that use the NTSC television system.

### Specifications

Model	CFTD2785/CFTD2085
Voltage	AC 120V
Frequency of Operation	60Hz
Power Consumption	150 watts/130 watts
Dimension	CFTD2785: 758 x 504 x 638 mm/29.84 x 19.84 x 25.12 inches CFTD2085: 584 x 492 x 515 mm/22.99 x 19.37 x 20.28 inches
Weight	CFTD2785: 47.2 kg/104.06 lbs CFTD2085: 28.5 kg/62.83 lbs

## Free Manuals Download Website

<http://myh66.com>

<http://usermanuals.us>

<http://www.somanuals.com>

<http://www.4manuals.cc>

<http://www.manual-lib.com>

<http://www.404manual.com>

<http://www.luxmanual.com>

<http://aubethermostatmanual.com>

Golf course search by state

<http://golfingnear.com>

Email search by domain

<http://emailbydomain.com>

Auto manuals search

<http://auto.somanuals.com>

TV manuals search

<http://tv.somanuals.com>