

SAMSUNG

SAMSUNG DIGIT*all*
everyone's invited™

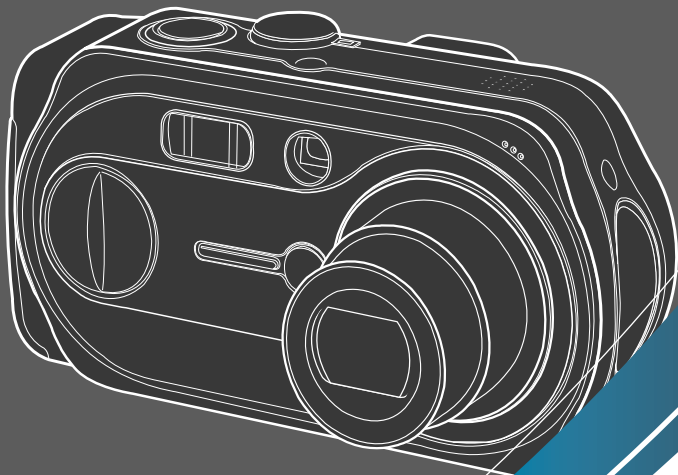

ENGLISH

• **Digimax A63**

SAMSUNG CAMERA

User's Manual

Digimax A6

Thank you for buying a Samsung Camera.

This manual will guide you through using the camera, including capturing images, downloading images and using the application software. Please read this manual carefully before using your new camera.

※ Figures (Images) used for the manual are based on model Digimax A6.

Download from Www.Somanuals.com. All Manuals Search And Download.

Instructions

- Use this camera in the following order

Set up the camera driver

Before connecting the camera to a PC, via the USB cable, you will need to set up the camera driver. Install the camera driver that is contained in the Application S/W CD-ROM.(p.97)

Take a picture

Take a picture (p.21)

Insert the USB cable

Insert the supplied USB cable into the PC's USB port and the camera's USB connection terminal.(p.105)

Check the camera's power

Check the camera's power. If the power is turned off, press the camera button to turn on.

Check [Removable Disk]

Open Window's EXPLORER and search for [Removable Disk].(p.106)

- If you use a card reader to copy the images on the memory card to your PC, the images could be damaged. When transferring the images taken with the camera to your PC, be sure to use the supplied USB cable to connect the camera to your PC. Please note that the manufacturer holds no responsibility for loss or damage of images on the memory card due to the use of a card reader.

Contents

READY

● Getting to know your camera	5
● About the icons	5
● Danger	6
● Warning	6
● Caution	7
● An FCC warning	7
● This digital camera can be used for	8
● Manufacturer's contents	10
● Identification of features	11
■ Front & Top	11
■ Back & Bottom	11
■ Side/ 5-function button	12
■ Mode dial	12
● Connecting to a Power Source	15
■ Using the AC power adapter (3.3V 2.0A)	15
■ Using the batteries	16
● Instructions on how to use the memory card	17
■ Maintenance of the memory card	17
■ Preserving the memory card data	17
● Inserting the memory card	19
● Removing the memory card	19

RECORDING

● LCD monitor indicator	20
● Starting the recording mode	21
■ How to use the AUTO mode	21
■ How to use the PROGRAM mode	22
■ How to use the AS mode	22
■ How to use the M mode	23
■ How to use the VOICE RECORDING mode	23
■ How to use the MOVIE CLIP mode	24
■ Pausing while recording a movie clip (Successive Recording)	24

■ NIGHT SCENE mode	25
■ How to use the SCENE mode	25
● Things to Watch Out for When Taking Pictures	26
● Using the camera buttons to adjust the camera	27
■ POWER button	27
■ SHUTTER button	27
● ZOOM W/T button	27
● Voice memo/ UP button	29
● Macro/ Down button (Focusing)	30
● Focus lock	31
● FLASH/ LEFT button	32
● Self-timer/ Right button	34
● MENU/ OK button	35
● +/- button	36
● ASM button(Manual & Scene mode button)	39
● LCD button	41
● Using the LCD monitor to adjust the camera settings	42
● How to use the menu	44
■ Size	44
■ Quality	45
■ Metering	46
■ Continuous shot	46
■ Effect	47
■ Sharpness	48
■ Save / Load the camera configuration (MYSET)	49
■ Scene	50

PLAY

● Starting play mode	51
■ Playing back a still image	51
■ Playing back a movie clip	52
■ Playing back a recorded voice	52

Contents

●LCD monitor indicator	53	●Function lamp	81
●Using the camera buttons to adjust the camera	54	●Sound	82
■Thumbnail/ Enlargement button	54	●Selecting an External Device (USB)	83
■Voice memo / Up button	55	●LCD brightness	83
■Play & Pause/ Down button	56	●Quick view	84
■LEFT/ RIGHT/ MENU/ OK button	57	●Initialization(RESET ALL)	84
■LCD button	57	●Setting up the MYCAM menu	85
■Delete button	58	●Start up image	85
●Setting up the play back function using the LCD monitor	59	●Shutter sound	86
●Starting the slide show	62	●Start up sound	86
●Rotating an image	63	●Important notes	87
●Resize	64	●Warning indicator	89
●Protecting images	65	●Before contacting a service center	90
●Deleting all images	66	●Specifications	93
●DPOF	66		
●DPOF : STANDARD	67		
●DPOF : INDEX	67		
●DPOF : PRINT SIZE	68		
●DPOF : CANCEL	68		
●COPY TO CARD	69		
●PictBridge	70		
●PictBridge: Picture Selection	71		
●PictBridge: Printing	72		
●PictBridge: Print Setting	73		
●PictBridge : RESET	74		

SETUP

●Setup menu	75
●File name	76
●Auto power off	77
●Language	78
●Formatting a memory card	79
●Setting up the Date/ Time	80
●Date type	80
●Imprinting the recording date	81

SOFTWARE

●Software Notes	95
●System Requirements	95
●About the software	96
●Setting up the application software	97
●Starting PC Mode	105
●Removing the USB Driver for Windows 98SE	108
●Removable Disk	109
●Removing the removable disk	110
●Setting up the USB Driver for MAC	111
●Using the USB Driver for MAC	111
●Digimax Viewer 2.1	112
●Using PhotoImpression	113
●Digimax Reader	114
●FAQ	116

Getting to know your camera

Thank you for buying a Samsung Digital Camera.

- Prior to using this camera, please read the user manual thoroughly.
 - When you require After Sales service, please bring the camera and the cause of the camera malfunction (such as Batteries, Memory card etc.) to the A/S center.
 - Please check that the camera is operating properly prior to when you intend to use it (e.g. for a trip or an important event) to avoid disappointment. Samsung camera takes no responsibility for any loss or damages that may result from camera malfunction.
 - Keep the manual in a safe place.
- * Microsoft, Windows and Windows logo are registered trademarks of Microsoft Corporation incorporated in the United States and/or other countries.
- * All brand and product names appearing in this manual are registered trademarks of their respective companies.

About the icons

This manual contains instructions on using this camera that will help you to use this camera safely and correctly. This will help prevent danger and injury to others.



DANGER

DANGER

DANGER indicates an imminently hazardous situation which, if not avoided, will result in death or serious injury.



WARNING

WARNING

WARNING indicates a potentially hazardous situation, which, if not avoided, could result in death or serious injury.



CAUTION

CAUTION

CAUTION indicates a potentially hazardous situation, which, if not avoided, may result in a minor or moderate injury.

Danger

- Do not attempt to modify this camera in any way. This may result in fire, injury, electric shock or severe damage to you or your camera. Internal inspection, maintenance and repairs should be carried out by your dealer or Samsung Camera Service Center.
- Please do not use this product in close proximity to flammable or explosive gases, as this could increase the risk of explosion.
- Should any form of liquid or a foreign object enter the camera, do not use it. Switch off the camera, and then disconnect the power source (batteries or AC Power Adapter). You must contact your dealer or Samsung Camera Service Center. Do not continue to use the camera as this may cause a fire or electric shock.
- Do not insert or drop metallic or inflammable foreign objects into the camera through access points e.g. the memory card slot and battery chamber. This may cause a fire or electric shock.
- Do not operate this camera with wet hands. This could pose a risk of electric shock.

DANGER

Warning

- Do not use the flash in close proximity to people or animals. Positioning the flash too close to your subject's eyes, may cause eyesight damage.
- When taking photographs, never point the lens of the camera directly into very strong light. This may result in permanent damage to your eyesight.
- For safety reasons keep this product and accessories out of reach of children or animals to prevent accidents e.g.:
 - Swallowing batteries or small camera accessories. If an accident should occur, please consult a doctor immediately.
 - There is the possibility of injury from the camera's moving parts.
- Batteries and camera may become hot during prolonged use and it may result in camera malfunction. Should this be the case, allow the camera to sit idle for a few minutes to allow it time to cool.
- Do not recharge non rechargeable batteries. This may cause an explosion.
- Do not leave this camera in places subject to extremely high temperatures, such as a sealed vehicle, direct sunlight or other places of extreme variances in temperature. Exposure to extreme temperatures may adversely affect the camera's internal components and could cause a fire.
- When in use, do not cover the camera or AC Power Adapter. This may cause heat to build up and distort the camera body or cause a fire. Always use the camera and its accessories in a well-ventilated area.

Caution

- Leaking, overheating, or burst batteries could result in fire or injury.
 - Use batteries with the correct specification for the camera.
 - Do not short circuit, heat or dispose of batteries in fire.
 - Do not insert the batteries with the reverse polarities.
- Remove the batteries when not planning to use the camera for a long period of time. Batteries may leak corrosive electrolyte and irreparably damage the camera's components.
- Do not fire the flash while it is in contact with hands or objects.
Do not touch the flash after using it continuously. It may cause burns.
- Do not move the camera while it is switched on, if you are using the AC Power Adapter. After use, always switch off the camera before unplugging the adapter from the wall socket. Then make sure that any connector cords or cables to other devices are disconnected before moving the camera. Failure to do so may damage the cords or cables and cause a fire or electric shock.

CAUTION

An FCC warning

- This device has been tested in accordance with the limits of a class B digital device under item 15 of the FCC rules. These limits are designed to provide protection against harmful interference in commercial installation. This equipment generates, absorbs and can emit radio frequency energy. If it is not installed and used in accordance with the instructions, it may cause harmful interference to radio communication.

There is however, no guarantee that interference will not occur in some situations. Should any interference occur when this device is in operation, please try one or more of the following measures.

- Change the location and direction of any aerial.
 - Increase distance between the camera and the affected device.
 - Use a different socket away from the affected device.
 - Please contact a Samsung agent or a radio/TV engineer.
- This device complies with part 15 of the FCC Rules.
 - Changes or modifications not expressly approved by the party responsible for compliance could void user's authority to operate the equipment.

This digital camera can be used for



Printing images using a dedicated printer, DPOF and PictBridge compatible printer or a DPOF-equipped photo lab.
(refer to page 66~74)



Down loading image files
from camera to computer.
(refer to page 106)



Taking a picture.
(refer to page 21)



Editing images on a PC.
(refer to page 113)

This digital camera can be used for

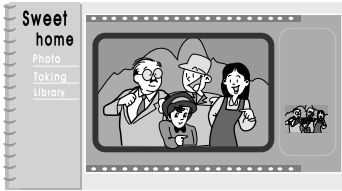

Creation of a digital photo album.

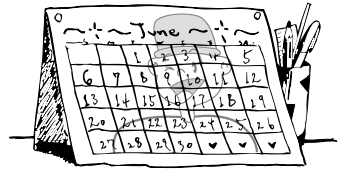

Taking a favourite image and creating your own personalized calendar with it.



Recording your voice.
(refer to page 23)

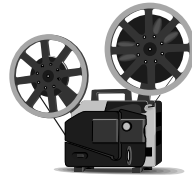

Recording a movie clip.
(refer to page 24)

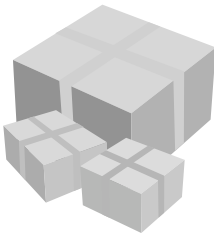

You can even create your own unique gift wrap paper by using your digital images.



Inserting images directly into any electronic document.

Manufacturer's contents

Please check that you have the correct contents before using this product.

marked contents are optional.

Digital Camera



Pouch



USB cable



Camera strap



User manual



Product warranty



Software CD



SD memory card



AC adapter
(SAC-32, 3.3V)



2 AA Alkaline
Batteries



Digimax Battery I-Pack : SNB-2312 KIT

Battery
charger

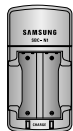

Rechargeable
battery



AC cord



Digimax Battery I-Pack : SBP-1303 KIT

Battery
charger



Rechargeable
battery



AC cord



Identification of features

Front & Top

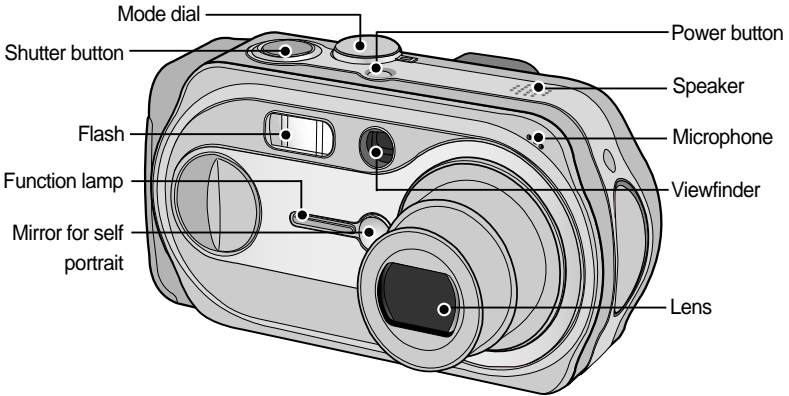

Back & Bottom

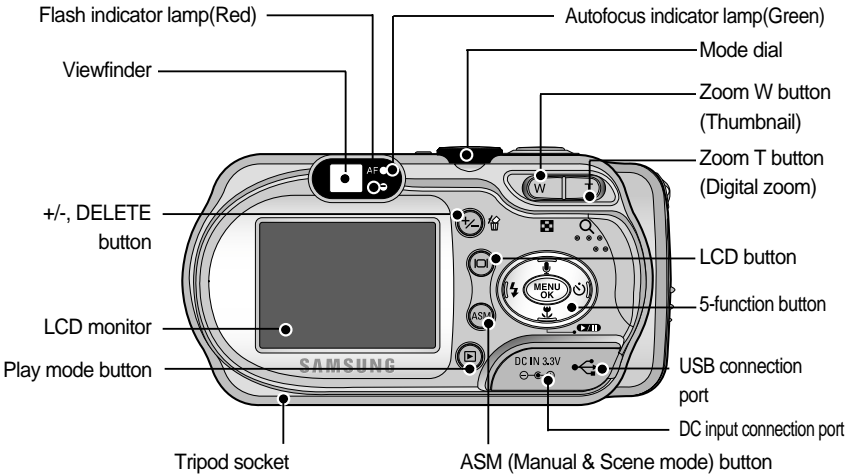

* When using the digital zoom to take a picture, the composition of the picture may be different depending on whether you are using the LCD monitor or the viewfinder. The picture will be taken in the composition of the picture as it appears on the LCD monitor.

Identification of features

Side/ 5-function button

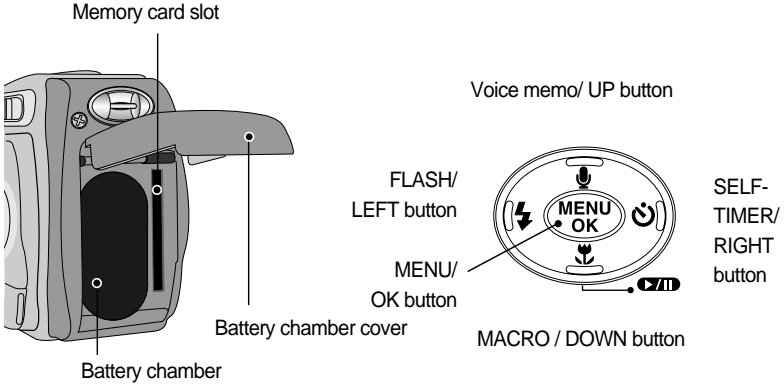

Mode dial

- You can select the desired working mode by using the mode dial located on the top of the camera. This digital camera has 8 recording modes. These are listed below.

● AUTO mode

Please select this mode for quick and easy picture taking with minimal user interaction.

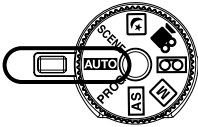

● PROGRAM mode

Selecting the automatic mode will configure the camera with optimal settings. You can still manually configure all functions except the iris and shutter speed.

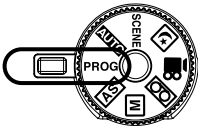

Identification of features

● AS mode

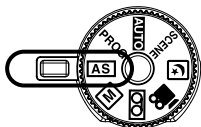

Aperture priority/ Shutter priority mode

The Aperture and Shutter can be set manually in the AS mode.

● M mode

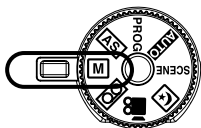

Manual mode

The Aperture value, Shutter speed and various functions can be set manually in this mode.

● VOICE RECORDING mode

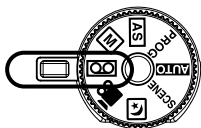

A voice recording can be recorded for as long as the available recording time of the memory capacity allows.(Max : 1 hour)

- Voice recording file type : *.wav

● MOVIE CLIP mode

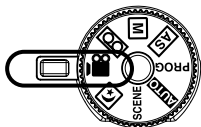

A movie clip can be recorded for as long as the available recording time of the memory capacity allows.

- Image size : 640X480, 320X240, 160X120(user selectable)

- Movie clip file type : *.avi

● NIGHT SCENE mode

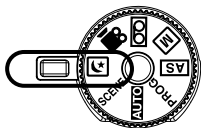

This mode is used at night or against a dark background.

● SCENE mode

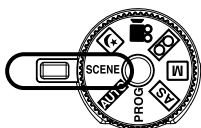

Use the menu to easily configure optimal settings for a variety of shooting situations including portrait, children, landscape, text recognition, close-up, sunset, dawn, backlight, fireworks, beach scenes, and snowscape.

Identification of features

■ Function lamp & Self-timer lamp

Function	Description
Power on	Function lamp blinks and then turns off when the camera is ready to take a picture
After taking a picture	Function lamp blinks once
While movie recording	Function lamp blinks at a 1-second interval
While voice recording.	
While the self timer is functioning	For the first 7 seconds, the lamp blinks at 1 second intervals. For the final 3 seconds, the lamp blinks quickly at 0.25-second intervals. *The lamp will function while using the self-timer even if the configuration is set to off the lamp.(Based on 10-second Self-timer; see p. 34)

■ Auto focus indicator lamp

Color	Status	Camera Status
Green	Blinking	Recording Mode (lightly press the shutter button): Not focused PC Mode: Transmitting Data
	On	Recording Mode (lightly press the shutter button): Focused.



















■ Mode dial lamp

Color	Status	Camera Status
Green	On	Turned off the LCD with the LCD button. PC Mode: When the USB cable is inserted.

■ Flash indicator lamp

Color	Status	Camera Status
Red	Blinking	Flash in the process of charging
	On	Flash ready

■ Mode icons

MODE	AUTO	PROGRAM	AS	M	VOICE RECORDING	MOVIE CLIP	NIGHT SCENE	PLAY		
Icon										
MODE	SCENE									
	PORTRAIT	CHILDREN	LANDSCAPE	TEXT	CLOSE UP	SUNSET	DAWN	BACKLIGHT	FIREWORKS	BEACH & SNOW
Icon										

Connecting to a Power Source

- There are two ways in which to provide the camera with power. You can use batteries or alternatively, you can use an AC(100 ~ 250V) Adapter (DC 3.3V 2.0A).
- We recommend using batteries for a digital camera (Within a year from the date of manufacture). The batteries are listed below.

Non rechargeable batteries	: AA type	- Alkaline, Ni-Mn, Ni-Zn, Lithium
	CR-V3 type	- Lithium
Rechargeable batteries	: AA type	- Ni-MH(Samsung SNB-2312 recommended) Ni-Cd(over 1000mAh)
	CR-V3 type	- Samsung SBP-1303(Lithium Ion battery)

INFORMATION

Important information about battery usage

- It is easy to buy alkaline batteries. However, the duration for using batteries varies in accordance with the battery manufacturer or the photographic conditions.
- When the camera is not used, turn off the camera power.
- Do not recharge the non rechargeable batteries. It may cause an explosion.
- Please remove the batteries if the camera will not be used for long periods. Batteries can lose power over time and are prone to leaking if kept inside the camera.
- We recommend high capacity ALKALINE batteries as manganese batteries cannot deliver sufficient power.
- Low temperatures (below 0 °C) can affect the performance of the batteries and you may experience reduced battery life.
- Batteries will usually recover at normal temperatures.
- Do not use old and new batteries at the same time.
- During extended use of the camera, the camera body may become warm.
This is perfectly normal.

Using the AC power adapter (3.3V 2.0A)

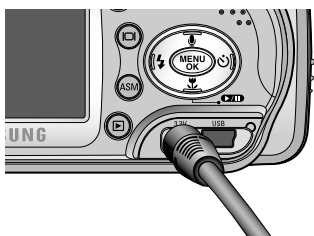

If you have access to a mains supply, using an AC Adapter (3.3V 2.0A) allows the camera to be used for long periods of time.

Plug the adapter into the connection point (DC IN 3.3V) on the camera.

Remove the batteries from the camera when using an AC adapter.

Connecting to a Power Source

DANGER

- Always turn off the power before taking the AC adapter out of the mains supply.
- As with all mains powered devices, safety is important. Ensure that neither the camera nor adapter comes into contact with water or metallic materials.
- Please ensure that you use an AC adapter (3.3V 2.0A) with the correct specification for the camera. Failure to do so may affect your warranty.

Using the batteries

: If the camera does not turn on after you have inserted batteries, please check whether the batteries are inserted with the correct polarity(+/-).

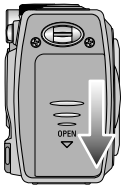

1. Open the battery chamber cover by pushing in the direction of the arrow.

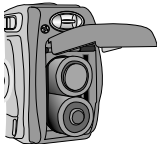

[Inserting the AA type battery]



[Inserting the CR-V3 type battery]

2. Insert the batteries taking note of the polarity (+ / -).

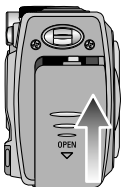

3. To close the battery chamber cover, push it until it clicks.

■ There are 3 indicators for battery condition that are displayed on the LCD monitor.

Battery indicator			
Battery status	The batteries are fully charged.	Prepare new batteries.	There is no battery capacity. Replace with new batteries.

Instructions on how to use the memory card

Maintenance of the memory card

- Be sure to format the memory card (see p. 79) if you are using a newly purchased memory for the first time, if it contains data that the camera cannot recognize, or if it contains images captured with a different camera.
- Turn off the camera power whenever the memory card is being inserted or removed.
- Repeated use of the memory card will eventually reduce the memory card's performance. Should this be the case, you will need to purchase a new memory card.
Wear and tear on the memory card is not covered by the Samsung warranty.
- The memory card is an electronic precision device.
Do not bend, drop or subject the memory card to any heavy impact.
- Do not store the memory card in an environment with strong electronic or magnetic fields, e.g. near loud speakers or TV receivers.
- Please do not use or store in an environment where there are extremes in temperature.
- Do not allow the memory card to become dirty or to come into contact with any liquid.
Should this happen, clean the memory card with a soft cloth.
- Please keep the memory card in its case when not in use.
- During and after periods of extended use, you may notice that the memory card is warm.
This is perfectly normal.
- Do not use a memory card that is used in another digital camera or memory card reader.
- Do not use a memory card formatted by another digital camera or memory card reader.

Preserving the memory card data

- If the memory card is subjected to any of the following, the recorded data may become corrupted :
 - When the memory card is used incorrectly.
 - If the power is switched off or the memory card is removed while recording, deleting (formatting) or reading.
- Samsung cannot be held responsible for lost data.
- It is advisable to copy important data onto other media as back-up e.g. floppy disks, hard disks, CD etc.
- If there is insufficient memory available : If you press the shutter button for the shot, a [CARD FULL !] message will appear and the camera will not operate. To optimize the amount of memory in the camera, replace the memory card or delete unnecessary images stored on the memory.

Instructions on how to use the memory card

INFORMATION

- If you open the battery chamber cover when the camera power is turned on, the power will turn off automatically.
- Don't remove the memory card when the Auto focus lamp(Green) is blinking as this may cause damage to data in the memory card.

- The camera can use SD Memory Cards and MMC (Multi Media Card).

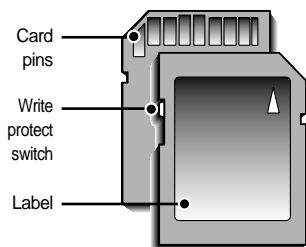

[SD(Secure Digital) memory card]

The SD memory card has a write protect switch that prevents image files from being deleted or formatted.

By sliding the switch to the bottom of the SD memory card, the data will be protected.

By sliding the switch to the top of the SD memory card, the data protection will be canceled.

Slide the switch to the top of the SD memory card before taking a picture.

- When using a 32MB internal memory, the specified shooting capacity will be as follows. These figures are approximate as image capacities can be affected by variables such as subject matter.

Mode	STILL IMAGE mode						MOVIE CLIP mode		
	2816	2272	2048	1600	1024	640	640	320	160
SUPER FINE	8	13	16	26	64	162	-	-	-
FINE	16	26	32	52	127	322	-	-	-
NORMAL	25	39	48	78	191	488	-	-	-
30FPS	-	-	-	-	-	-	44SEC	1MIN 37SEC	5MIN
15FPS	-	-	-	-	-	-	1MIN 13SEC	3MIN	8MIN 50SEC

Inserting the memory card

1. Turn off the camera's power and pull the battery chamber cover in the direction of the arrow to open.

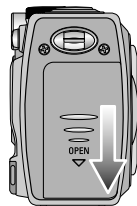

2. Have the front of the memory card facing toward the back of the camera (LCD monitor) and the card pins toward the front of the camera (lens), and then push the memory card into the card slot until you hear a click.

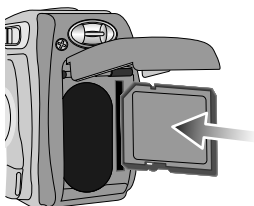

3. To close, push the battery chamber cover until you hear a click.

If the memory card does not slide in smoothly, do not attempt to insert it by force. Check the direction of insertion, and then insert it correctly. Do not insert the memory card the wrong way round. Doing so may damage the memory card slot.

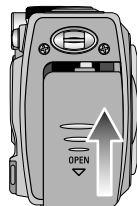

Removing the memory card

1. Turn the power off using the power button.
Open the battery chamber cover and press the memory card as shown in the image and release.
2. Remove the memory card and close the battery chamber cover.

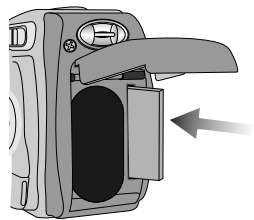

LCD monitor indicator



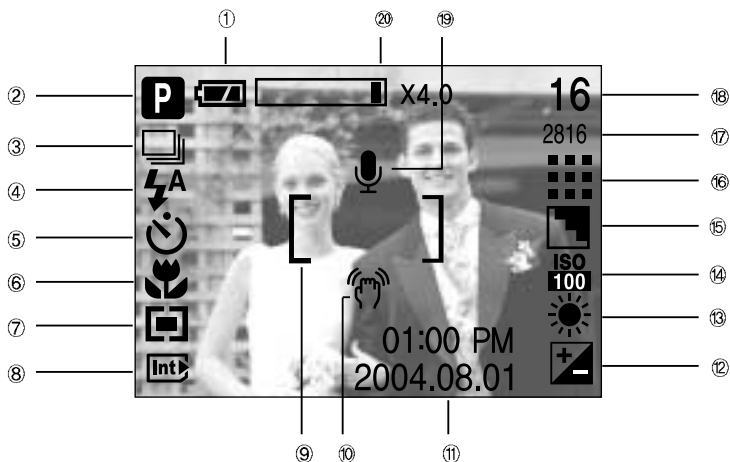









■ The LCD monitor displays information about the shooting functions and selections.



[Image & Full Status]

No.	Description	Icons	Page
1	Battery		p.16
2	Recording mode		p.12-13 p.49
3	Continuous shot		p.46
4	Flash		p.32
5	Self-timer		p.34
6	Macro		p.30
7	Metering		p.46
8	Card inserted indicator		
9	Auto focus frame		
10	Camera shake warning		p.26
11	Date/ Time	2004.08.01 01:00 PM	
12	Exposure compensation		p.38
13	White Balance	AWB	p.38

LCD monitor indicator

14	ISO	   	p.36
15	Sharpness	  	p.48
16	Image quality	  	p.45
17	Image size	2816, 2272, 2048, 1600, 1024, 640	p.44
18	Number of available shots remaining	16	
	Remaining time (Movie clip/ Voice recording)	00:00:44/ 00:59:00	
19	Voice memo		p.29
20	Optical zoom/ Digital Zoom rate	 X4.0	

Starting the recording mode

■ How to use the AUTO mode (**AUTO**)

1. Insert the batteries.(p.16) Insert the batteries taking note of the polarity (+ / -).
2. Insert the memory card (p.19).
3. Close the battery chamber cover.
4. Press the power button to turn on the camera.
(If the date/time that is displayed on the LCD monitor is incorrect, reset the date/time before taking a picture.)
5. Select the AUTO mode by rotating the mode dial.
6. Point the camera towards the subject and compose the image by using either the viewfinder or LCD monitor.
7. Press the shutter button to capture an image.

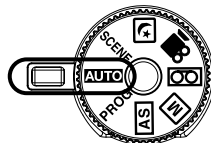

[AUTO mode]

INFORMATION

- If the auto focus frame turns to red when you press the shutter button down half way, it means that the camera cannot focus on the subject. Should this be the case, the camera is unable to capture an image clearly.

Starting the recording mode

■ How to use the PROGRAM mode (**PROG**)

Selecting the automatic mode will configure the camera with optimal settings. You can still manually configure all functions except the iris and shutter speed.

Steps from 1-4 are the same as those for AUTO mode.

5. Select the PROGRAM mode by rotating the mode dial.

6. Press the menu button to configure advanced functions such as image size (p.44), quality (p.45), metering (p.46), continuous shooting (p.46), picture effects (p.47), sharpness(p.48) and MYSET(p.49) settings.

7. Point the camera towards the subject and compose the image by using either the viewfinder or LCD monitor.

8. Press the shutter button to capture an image.

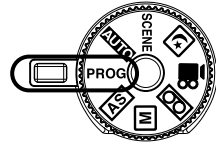

[PROGRAM mode]

■ How to use the AS mode (**AS**)

The Aperture and Shutter can be set manually in this mode.

Steps from 1-4 are the same as those for AUTO mode.

5. Select the AS mode by rotating the mode dial.

6. Use the ASM, Up/Down/Left/Right buttons to select Aperture Value and Shutter speed.

* Please see page 39 for details on Aperture and Shutter speed setting.

7. Point the camera towards the subject and compose the image by using either the viewfinder or LCD monitor.

8. Press the shutter button to capture an image.

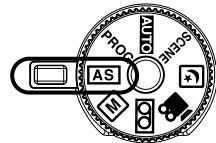

[AS mode]

Starting the recording mode

■ How to use the M mode ()

The Aperture and Shutter can be set manually in this mode.

Steps from 1-4 are the same as those for AUTO mode.

5. Select the M mode by rotating the mode dial.

6. Use the ASM, Up/Down/Left/Right buttons to select Aperture Value and Shutter speed.

* Please see page 40 for details on Aperture and Shutter speed setting.

7. Point the camera towards the subject and compose the image by using either the viewfinder or LCD monitor.

8. Press the shutter button to capture an image.

* If the M mode is selected, a bar to indicate the exposure value will display on the bottom of the LCD monitor.

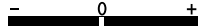
()

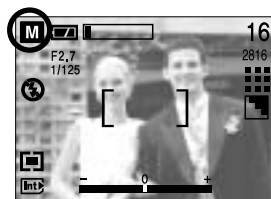
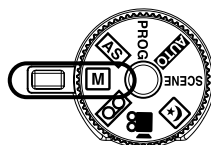

[M mode]

■ How to use the VOICE RECORDING mode ()

Steps from 1-4 are the same as those for AUTO mode.

5. Select the VOICE RECORDING mode by rotating the mode dial.

6. Press the shutter button to record a voice.

- Press the shutter button once and voice is recorded for as long as the available recording time(Max : 1 hour) allows. The recording time will be displayed on the LCD monitor. Voice will still be recorded if the shutter button is released.

- If you wish to stop recording, press the shutter button again.

- File type : *.wav

* A distance of 40cm between you and the camera (microphone) is the best distance to record sound.

* The auto focus indicator lamp(Green) blinks during voice recording.

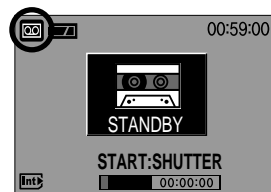
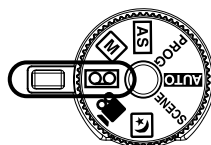

[VOICE RECORDING mode]

Starting the recording mode

■ How to use the MOVIE CLIP mode ()

Steps from 1-4 are the same as those for AUTO mode.

5. Select the MOVIE CLIP mode by rotating the mode dial.

6. The MOVIE CLIP mode icon and available recording time will display on the LCD monitor.

7. Point the camera towards the subject and compose the image by using either the viewfinder or LCD monitor.

Press the shutter button and movie clips are recorded for as long as the available recording time.

Movie clips will still be recorded if the shutter button is released.

Recording time will display on the LCD monitor.

• If you wish to stop recording, press the shutter button again.

• Image size and type are listed below.

- Image size : 640x480, 320 x 240, 160x120(Selectable)

- File type : *.avi

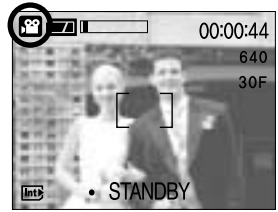

[MOVIE CLIP mode]

■ Pausing while recording a movie clip (Successive Recording)

This camera allows you to temporarily stop during unwanted scenes, while recording a movie clip. Using this function, you can record your favorite scenes into a movie clip without having to create multiple movie clips.

● Using Successive Recording

Steps from 1-6 are the same as those for MOVIE CLIP mode.

7. Point the camera towards the subject and compose the image by using either the viewfinder or LCD monitor. Press the shutter button and movie clips are recorded for as long as the available recording time. Movie clips will still be recorded if the shutter button is released.

8. Press the Pause button() to pause recording.

9. Press the Pause button() again to resume the recording.

10. If you wish to stop recording, press the shutter button again.

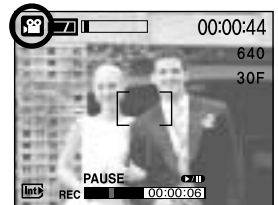

[Successive recording of a movie clip]

Starting the recording mode

■ NIGHT SCENE mode()

This mode is used at night or against a dark background.

It is possible that camera shake will occur. If this is the case, use a tripod to eliminate this.

Use the ASM, Up/Down/Left/Right buttons to select Aperture Value and Shutter speed. Please see page 39 for details on Aperture and Shutter speed setting.

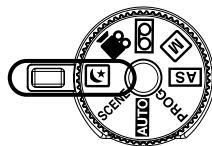

[NIGHT SCENE mode]

■ How to use the SCENE mode (**SCENE**)

Use the menu to easily configure optimal settings for a variety of shooting situations including portrait, children, landscape, text recognition, close-up, sunset, dawn, backlight, fireworks, beach scenes, and snowscape.

Steps from 1-4 are the same as those for AUTO mode.

5. Select the SCENE mode by rotating the mode dial.
6. Press the ASM(Manual & Scene mode) button and use the Left/Right buttons to select the sub menu.
7. After selecting a desired sub menu, press the ASM(Manual & Scene mode) button or OK button.
8. The current scene icon is displayed at the top left of the LCD.
9. Point the camera towards the subject and compose the image by using either the viewfinder or LCD monitor.
10. Press the shutter button to capture an image.

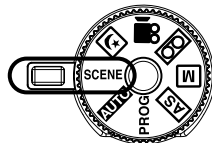

[SCENE mode]

Things to Watch Out for When Taking Pictures

- Pressing the shutter button down half way
Lightly press the shutter button to confirm focus and flash battery charge.
Press the shutter button all way down to take the picture.

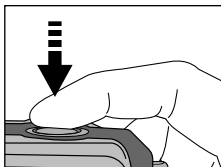

[Lightly press the shutter button]

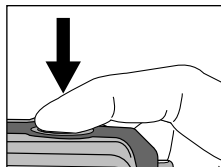

[Press the shutter button]

- The available recording time may vary depending on shooting conditions and camera settings.
- When the Flash Off or Slow synchro mode is selected in a low lighting condition, the camera shake warning indicator () may appear on the LCD monitor. In this case, use a tripod, support the camera on a solid surface or change the flash mode to flash shot mode.
- Backlight compensated shots: When taking an outdoor shot, avoid facing the sun, as the image may be dark because of the strong backlight. To take a picture against the sun, please use the [BACKLIGHT] in the scene shooting mode (see page 50), Fill-in flash (see page 32), Spot metering (see page 46), or Exposure compensation (see page 38).
- Avoid obstructing the lens or the flash when you capture an image.
- As there can be some differences between what is seen through the Viewfinder and the resulting image when taken at a range closer than 1.5m, it is recommended that you use the LCD monitor to compose these shots.
- Using the LCD monitor extensively will drain the batteries.
We recommend turning off the LCD monitor and using the optical viewfinder as often as possible in order to extend battery life.
- Under certain conditions the auto focus system may not perform as expected.
 - When photographing a subject that has little contrast.
 - If the subject is highly reflective or shiny.
 - If the subject is moving at high speed.
 - When there is strong reflected light, or when the background is very bright.
 - When the subject matter has only horizontal lines or the subject is very narrow (such as a stick or flagpole).
 - When the surroundings are dark

Using the camera buttons to adjust the camera

- The RECORDING mode function can be set up by using the camera buttons.

POWER button

- Used for turning the camera's power on / off.
To turn on the camera power, press the power button.
- If there is no operation during the specified time, the camera's power will be turned off automatically to save battery life.

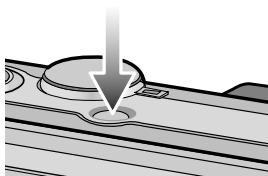

SHUTTER button

- Used for taking an image or recording voice in the RECORDING mode.
- In MOVIE CLIP mode :
Pressing the shutter button down fully starts the process for recording a movie clip. Press the shutter button once and the movie clip is recorded for as long as the available recording time in the memory allows. If you wish to stop recording, press the shutter button again.
- In STILL IMAGE mode
Pressing the shutter button down halfway activates the auto focus and checks the condition of the flash. Pressing the shutter button down fully takes the image and stores the relevant data regarding the shot. If you select voice memo recording, the recording will start after the camera has finished storing the image data.

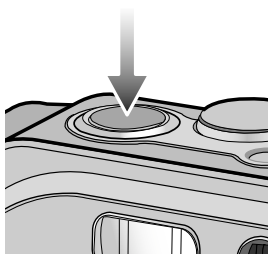

ZOOM W/T button

- If the menu is not displayed, this button works as the OPTICAL ZOOM or DIGITAL ZOOM button.

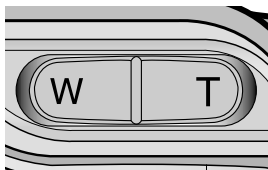

ZOOM W/T button

- This camera has a 3X optical zoom and a 4X digital zoom function. Using both will offer a total zoom ratio of 12X.

● TELE Zoom

Optical zoom TELE

: Pressing the ZOOM T button. This will zoom into the subject i.e. the subject will appear nearer.

Digital zoom TELE

: When the maximum (3X) optical zoom is selected, pressing the ZOOM T button activates the digital zoom software. Releasing ZOOM T button stops the digital zooming at the required setting. Once the maximum digital zoom (4X) is achieved, pressing the ZOOM T button will have no effect.

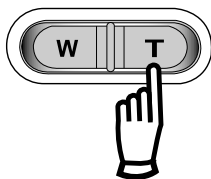

● WIDE Zoom

Optical zoom WIDE

: Pressing the ZOOM W button. This will zoom out from the subject i.e. the subject will appear further away. Pressing the ZOOM W button continuously will set the camera to its minimum zoom setting i.e. the subject appears at its furthest from the camera.

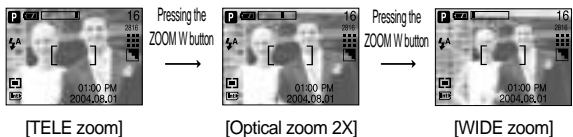
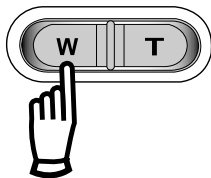

Digital zoom WIDE

: When the digital zoom is in operation, pressing the ZOOM W button will reduce the digital zooming in steps. Releasing ZOOM W button stops digital zooming. Pressing the ZOOM W button will reduce the digital zoom and then it will continue to reduce the optical zoom until the minimum setting is reached.

Optical zoom

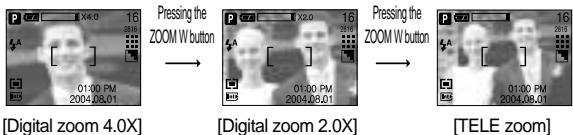
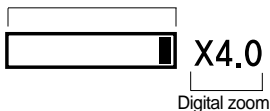

ZOOM W/T button

INFORMATION

- To use the digital zoom the LCD monitor has to be turned on.
- Images taken using the digital zoom may take a little longer for the camera to process. Allow time for this to take place.
- Digital Zoom will not work in Night Scene mode.
- You may notice a decrease in image quality when using the digital zoom.
- The zoom function can't be activated during the movie clip recording.
- Take care not to touch the lens to avoid taking an unclear image and possibly causing camera malfunction. If the image is dim, turn the camera power off and on again to modify the lens position.
- Take care not to press the lens as this may cause a camera malfunction.
- When the camera is turned on, take care not to touch the camera's moving lens parts as this may cause the resulting image to be dim and unclear.
- Take care not to touch the lens during zoom operation as this may cause damage.

Voice memo(🗣️)/ UP button

- While the menu is showing, press the UP button to move up the submenu cursor.
- When the menu is not displayed on the LCD monitor, the UP button operates as the voice memo button. You can add your voice-over to a stored still image.
- Recording a voice memo
 1. Rotate the MODE DIAL to select a RECORDING mode with the exception of MOVIE CLIP and VOICE RECORDING modes.
 2. Press the VOICE MEMO(🗣️) button. If the voice memo indicator is displayed on the LCD monitor, the setting is completed.

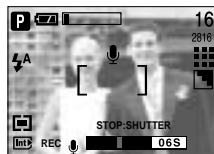

Voice memo() / UP button

3. Press the shutter button and take a picture. The picture is stored on the memory card.
4. Voice memo will be recorded for ten seconds from the moment the picture is stored. In the middle of the sound recording, pressing the shutter button will stop the voice memo.

INFORMATION

- A distance of 40cm between you and the camera (microphone) is the best distance to record sound.

Macro() / Down button (Focusing)

- While the menu is showing, press the DOWN button to move from the main menu to a submenu, or to move down the submenu cursor.
- When the menu is not showing, you can use the MACRO/ DOWN button to take macro pictures (within the distance range of 4-80 cm).



[Auto focus]



[Macro]

- Types of focus modes and focus ranges (W: Wide, T: Tele)

Focus type	Auto	Macro ()	
Focus range	80cm ~ Infinity	W : 4 ~ 80cm	T : 25 ~ 80cm

INFORMATION

- When the macro mode is selected, it is possible that camera shake will occur. If this is the case, use a tripod to eliminate this.
- When you take a picture within 25cm(MACRO focus), select the FLASH OFF mode.

Macro(🌸) / Down button (Focusing)

■ Available focusing method, by recording mode

(O : Selectable , X : Not selectable, ∞: Infinity focus range)

Mode		P	A_S	M	My					
Auto	O	O	O	O	O	O	O			
Macro	O	O	O	O	O	O	X			
Mode				T						
Auto	O	O	∞	X	X	∞	∞	O	∞	O
Macro	X	X	X	O	O	X	X	X	X	X

Focus lock

■ To focus on the subject positioned outside of the center, use the focus lock function.

● Using the Focus Lock

1. Ensure the subject in the center of the autofocus frame.
2. Press the SHUTTER button halfway. When the green auto lights up, it means the camera is focused on the subject. Be careful not to press the SHUTTER button all the way down to avoid taking an unwanted pictured.
3. With the SHUTTER button still pressed down only halfway, move the camera to recompose your picture as desired, and then press the SHUTTER button completely to take the picture. If you release your finger from the SHUTTER button, the focus lock function will be canceled.

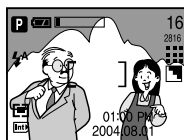

[The image to be captured]

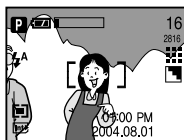

[Press the SHUTTER button]
halfway and focus on the subject

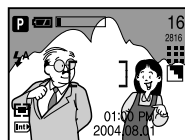

[Recompose the picture]
and fully depress the SHUTTER button

FLASH() / LEFT button

- When the menu is displayed on the LCD monitor, pressing the LEFT button makes the cursor shift to the left tab.
- When the menu is not displayed on the LCD monitor, the LEFT button operates as the FLASH () button.



[Selecting the Auto flash]

- Selecting the flash mode
 1. Rotate the MODE DIAL to select a RECORDING mode with the exception of MOVIE CLIP and VOICE RECORDING modes.
 2. Press the Flash button until the desired flash mode indicator displays on the LCD monitor.
 3. A flash mode indicator will be displayed on the LCD monitor. Use the correct flash to suit the environment.

● Flash range

Unit : m







ISO	AUTOFOCUS		MACRO	
	WIDE	TELE	WIDE	TELE
AUTO	0.8~3.0	0.8~2.0	0.25~0.8	0.25~0.8

INFORMATION

















- Using the flash frequently will reduce the life of the batteries.
- Under normal operating conditions the charging time for the flash is normally within 6 seconds. If the batteries are weak, the charging time will be longer.
- During the continuous shot, movie clip mode, the flash function will not operate.
- Take photographs within the flash range.
- The image quality is not guaranteed if the subject is too close or highly reflective.
- The LCD monitor is turned off for a while after using the flash to recharge it.

FLASH () / LEFT button

● Flash mode indicator

Icon	Flash mode	Description
	Auto flash	If the subject or background is dark, the camera flash will operate automatically.
	Auto & Red eye reduction	If a subject or background is dark, the camera flash will work automatically and will reduce the red-eye effect by using the red-eye reduction function.
	Fill in flash	The flash fires regardless of available light. The intensity of the flash will be controlled, according to the prevailing conditions. The brighter the background or subject is, the less intense the flash will be.
	Slow synchro	The flash will operate in conjunction with a slow shutter speed in order to obtain the correct exposure. We recommend using a tripod for this function. When you take an image in a condition with poor light, the camera shake warning indicator () will display on the LCD monitor.
	Flash off	The flash does not fire. Select this mode when capturing images in a place or situation where flash photography is prohibited. When you capture an image in a poorly lit condition, the camera shake warning indicator () will display on the LCD monitor.

● Available flash mode, by recording mode

		P	A_s	M	My					T						
	○	○	X	X	○	X	X	X	X	X	X	X	X	X	X	X
	○	○	X	X	○	X	○	○	X	X	X	X	X	X	X	X
	X	○	○	○	○	X	X	X	X	X	X	X	X	○	X	○
	X	○	○	○	○	○	X	X	X	X	X	X	X	X	X	X
	○	○	○	○	○	○	○	○	○	○	○	○	○	○	○	○

Self-timer(☺) / Right button

- When the menu is displayed on the LCD monitor, pressing the Right button makes the cursor shift to the right tab.
- When the menu is not displayed on the LCD monitor, the RIGHT button operates as the Self-timer(☺) button. This function is used when the photographer would also like to be in the image.

● Selecting the self-timer

1. Rotate the MODE DIAL to select a RECORDING mode with the exception of VOICE RECORDING mode.
2. Press the SELF-TIMER button until the desired mode indicator displays on the LCD monitor.

A 2 second, 10 second or double self-timer icon appears on the LCD monitor. In Movie Clip mode, only the 10-second self-timer will work.

· 2SEC self-timer (☺^{2S})

: Pressing the shutter button will allow an interval of 2 seconds before the image is taken.

· 10SEC self-timer (☺)

: Pressing the shutter button will allow an interval of 10 seconds before the image is taken.

· Double self-timer (☺[⊖])

: A picture will be taken after about 10 seconds and 2 seconds later a second picture will be taken. When using the flash, the 2-second self-timer may be delayed for longer than 2 seconds depending on the flash charge time.

3. When you press the SHUTTER button, the picture will be taken after the specified time has elapsed.

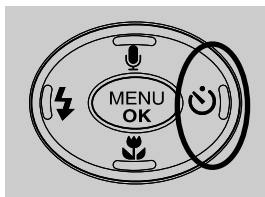

[Selecting the 10 SEC self-timer]

INFORMATION

- The default is OFF.
- When taking a picture using the self-timer, the function lamp works as follows:
 - 2 second self-timer setting : The function lamp blinks at 0.25 second interval for 2 seconds.
 - 10 second self-timer setting : The function lamp blinks at 1 second interval for the first 7 seconds. It blinks at 0.25 second interval for the remaining 3 seconds.
- If you operate the Power button, Mode dial, Play mode button, Self-timer button and shutter button during the self-timer operation, the self-timer function is cancelled.

MENU/ OK button

■ MENU button

- When you press the MENU button, a menu related to each camera mode will be displayed on the LCD monitor. Pressing it again will return the LCD to the initial display.
- A menu option can be displayed when the following are selected. AUTO, PROGRAM, AS, M, MOVIE CLIP, NIGHT SCENE and SCENE. There is no menu available when the VOICE RECORDING mode is selected.

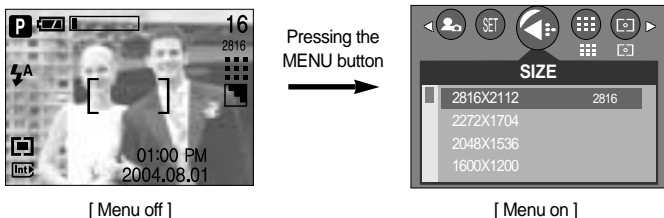

■ OK button









- When the menu is displayed on the LCD monitor, this button is used for shifting the cursor to the sub menu or for confirming data.

INFORMATION

- The menu will not be displayed on the LCD monitor in the following circumstances:
 - When another button is being operated.
 - While image data is being processed.
(when the green LED next to the viewfinder blinks)
 - When there is no battery capacity.
- When the menu is showing on the LCD monitor, it is not possible to operate the shutter button i.e. capture an image. To capture an image, simply cancel the menu display by pressing the MENU button.

+/- button

- You can use the +/- button to adjust the values for the ISO, white balance and exposure compensation.

Main menu	Sub menu	Available camera mode
ISO	AUTO, 100, 200, 400	P A_S M
WHITE BALANCE	AUTO, DAYLIGHT, CLOUDY, FLUORESCENT H, FLUORESCENT L, TUNGSTEN, CUSTOM.	P A_S M  SCENE ( )
Exposure compensation	-2.0~0.0~+2.0(0.5EV steps)	P A_S M  SCENE (   )

- ISO: You can select the ISO sensitivity when taking pictures.
The speed or specific light-sensitivity of a camera is rated by ISO numbers.

● Selecting an ISO Sensitivity

1. Press the +/- button, and then use the UP and DOWN buttons to select the ISO icon(). The ISO menu bar will appear as shown.
2. Use the LEFT and RIGHT buttons to select the desired ISO sensitivity value.

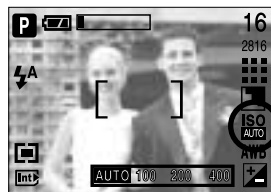

- AUTO : The camera's sensitivity is automatically changed by variables such as lighting value or subject brightness.
 - 100, 200, 400 : You can increase the shutter speed while the same amount of light is present, by increasing the ISO sensitivity. However, the image may be saturated in high luminance. The higher the ISO value, the higher the camera's sensitivity to light is and therefore the greater its capacity to take pictures in dark conditions. However, the noise level in the image will increase as the ISO value increases, making the image appear coarse.
3. When you press the +/- button again, the value you set will be saved and ISO setup mode will end.

+/- button

- White balance : The white balance control allows you to adjust the colours to appear more natural looking.

- Selecting a White Balance

1. Press the +/- button, and then use the UP and DOWN buttons to select the white balance icon (AWB).
The white balance menu bar will appear as shown.
2. Use the LEFT and RIGHT buttons to set the white balance to the desired value. The value you set will be displayed on the LCD monitor.



- AUTO AWB : The camera automatically selects the appropriate white balance settings, depending on the prevailing lighting conditions.
- DAYLIGHT ☀ : For taking images outside.
- CLOUDY ☁ : For taking images under a cloudy and overcast sky.
- Fluorescent H 📺 : For shooting under daylight fluorescent types of three-way fluorescent lighting.
- Fluorescent L 📺 : Shooting under white fluorescent lighting.
- TUNGSTEN ⚡ : For shooting under tungsten (standard light bulb) lighting.
- CUSTOM 📺 : Allows the user to set the white balance according to the shooting condition.

Different lighting conditions may cause a colour cast on your images.

3. Press the +/- button again. The value you set will be saved and White Balance setup mode will end.

+/- button

● Using the Custom White Balance

White balance settings may vary slightly depending on the shooting environment.

You can select the most appropriate white balance setting for a given shooting environment by setting up the custom white balance.

1. Select the CUSTOM () menu of the White Balance and press the OK button.
2. Place a sheet of white paper in front of the camera so that the LCD monitor shows only white, and then press the SHUTTER button.
3. Press the OK button and your custom white balance value is stored.

- The custom white balance value will be applied, starting with the next picture you take.
- The user configured white balance will remain effective until it is overwritten.

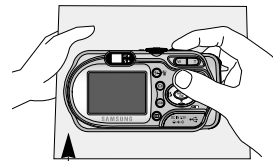
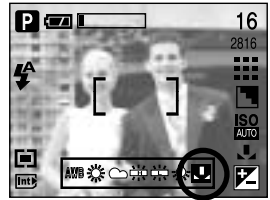



[White paper]

■ Exposure compensation : This camera automatically adjusts the exposure according to the ambient lighting conditions.

You can also select the exposure value by using the +/- button.

● Compensating Exposure

1. Press the +/- button, and then use the UP and DOWN buttons to select the exposure compensation icon (). The exposure compensation menu bar will appear as shown.
2. Use the LEFT and RIGHT buttons to set the desired exposure compensation factor.
3. Press the +/- button again. The value you set will be saved and the Exposure Compensation setup mode will close. If you change the exposure value, the exposure indicator () will be displayed on the bottom of the LCD monitor.

* A negative exposure compensation value reduces the exposure.

Note that a positive exposure compensation value increases the exposure and the LCD monitor will appear white or you may not get good pictures.

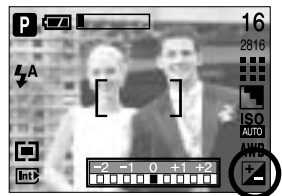

ASM button(Manual & Scene mode button)

■ You can use the ASM button to select the Aperture Value and Shutter speed in the Night scene mode.

● Using the ASM button in the Night scene mode

1. Rotate the MODE DIAL to select the NIGHT SCENE mode
2. Press the ASM button and the aperture value or shutter speed is turned green.
3. Press the UP/DOWN button to select the shutter speed. The aperture value will be changed automatically. Press the RIGHT/LEFT button to select the aperture value. The shutter speed will be changed automatically.
4. Press the ASM button again. The value you set will be saved and the mode will switch to NIGHT SCENE mode. Press the SHUTTER button to take the picture.

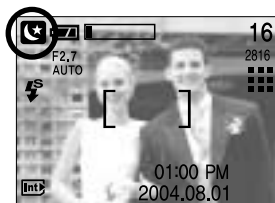

■ You can use the ASM button to select the Aperture Value and Shutter speed in the AS and M mode.

● Using the ASM button in the AS mode

1. Rotate the MODE DIAL to select the AS mode
2. Press the ASM button and the aperture value or shutter speed is turned green.
3. Press the UP/DOWN button to select the shutter speed(Shutter priority mode) and press the RIGHT/LEFT button to select the aperture value(Aperture priority mode).
4. Press the ASM button again. The value you set will be saved and the mode will switch to AS mode. Press the SHUTTER button to take the picture.



ASM button(Manual & Scene mode button)

- Using the ASM button in the M mode
 1. Rotate the MODE DIAL to select the M mode
 2. Press the ASM button and the aperture value or shutter speed is turned green.
 3. Press the UP/DOWN/LEFT/RIGHT button to select the aperture value and shutter speed.
 - UP/DOWN button : selecting the shutter speed
 - LEFT/RIGHT button : selecting the aperture value
 4. Press the ASM button again. The value you set will be saved and the mode will switch to M mode. Press the SHUTTER button to take the picture.

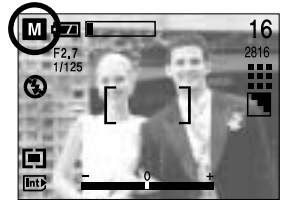

- Aperture values and shutter speeds changed by zoom scale are listed below.

Supported Aperture Values: AUTO, F2.7 ~ F11

Supported Shutter Speeds: AUTO, 1/2000 ~ 15S

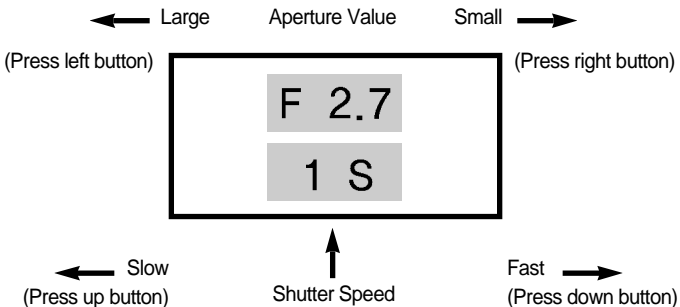

ASM button(Manual & Scene mode button)

■ You can use the ASM button to select the desired scene in the Scene mode.

● Using the ASM button in the Scene mode

1. Rotate the MODE DIAL to select the Scene mode
2. Press the ASM button and then a menu will be displayed as shown alongside. Press the left/right button to select a desired scene.

- Selectable scene menu :

Portrait, Children, Landscape, Text, Close-up, Sunset, Dawn, Backlight, Fireworks and Beach & Snow.

Please see page 50 for details on each scene menu

3. Press the ASM or OK button to confirm the selection.



LCD button

■ You can check the recording status in the LCD monitor.

Toggle the LCD button in shooting mode (except in voice recording mode) to display the next LCD information displayed.

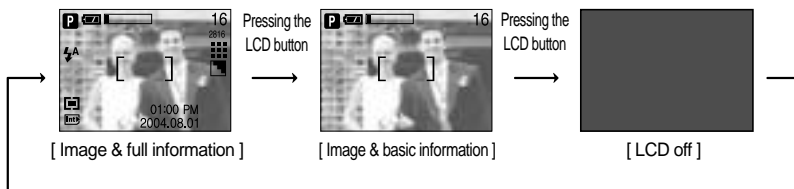
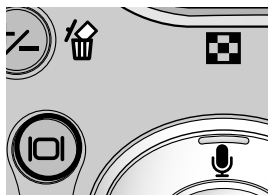

Pressing the LCD button

■ If the LCD monitor is turned off, the mode dial lamp will light up.

Using the LCD monitor to adjust the camera settings

- You can use the menu on the LCD monitor to set up recording functions. In any mode with the exception of VOICE RECORDING mode, pressing the MENU button displays the menu on the LCD monitor.













INFORMATION

- The menu will not be displayed on the LCD monitor in the following circumstances:
 - When another button is being operated.
 - While image data is being processed.
(when the green LED next to the viewfinder blinks)
 - When there is no battery capacity.
- When the menu is showing on the LCD monitor, it is not possible to operate the shutter button i.e. capture an image. To capture an image, simply cancel the menu display by pressing the MENU button.

- The following functions are available, depending on the mode you have selected.
The items indicated by are default settings.

Menu tab	Main menu	Sub menu	Camera working mode	Page
	SIZE	2816X2112		p.44
		2272X1704		
		2048X1536		
		1600X1200		
		1024X768		
		640X480		
		640X480		
		320X240		
		160X120		
FINE				
NORMAL				
30FPS				
15FPS				
	METERING	MULTI		p.46
		SPOT		

Using the LCD monitor to adjust the camera settings

Menu tab	Main menu	Sub menu	Camera working mode	Page	
	SHOOTING	SINGLE	PROG  	p.46	
		2 SHOTS			
		4 SHOTS			
		8 SHOTS			
		AEB			
	EFFECT	NORMAL	PROG   	p.47	
		B & W			
		SEPIA			
		RGB			
	SHARPNESS	SOFT	PROG  	p.48	
		NORMAL			
		VIVID			
	MYSET	LOAD	PROG	p.49	
		SAVE			MYSET1
					MYSET2
	SCENE	PORTRAIT, CHILDREN , LANDSCAPE , TEXT, CLOSE UP, SUNSET, DAWN, BACKLIGHT, FIREWORKS, BEACH&SNOW	SCENE	p.50	

* Menus are subject to change without prior notice.

How to use the menu

1. Turn on the camera and press the MENU button. A menu for each camera mode appears. However, there is no menu for Voice Recording mode ().
2. Use the LEFT and RIGHT buttons to navigate through the menus.



3. Use the UP and DOWN buttons to select a sub menu.

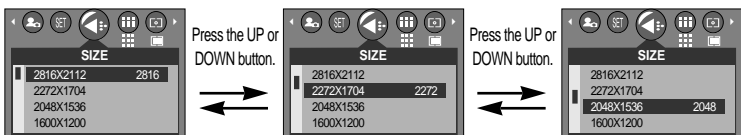

4. Select a sub menu, and then press the OK button. The value you set will be saved and the menu will disappear.

Size

- You can select the image size appropriate for your application.

Mode	STILL IMAGE mode						MOVIE CLIP mode		
Icon	2816	2272	2048	1600	1024	640	640	320	160
Size	2816X2112	2272X1704	2048X1536	1600X1200	1024X768	640X480	640X480	320X240	160X120



[PROGRAM mode]

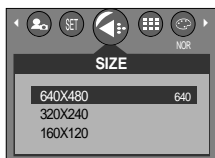

[MOVIE CLIP mode]



Size

INFORMATION

- The higher the resolution, the lower the number of available shots will be because high resolution images require more memory than lower resolution images.
- The selectable image sizes in the AUTO mode are listed below.
 - P(2816X2112) : For printing the image
 - M(1600X1200) : For saving the image to a PC
 - E(640X480) : For sending the image by e-mail

Quality

- You can select the compression ratio appropriate for your application of the captured images. The higher the compression ratio, the lower the picture quality.

Mode	STILL IMAGE mode			MOVIE CLIP mode	
Icon				30F	15F
Sub menu	S.FINE	FINE	NORMAL	30FPS	15FPS
File Format	jpeg	jpeg	jpeg	avi	avi



[PROGRAM mode]

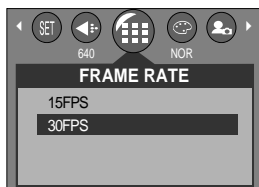

[MOVIE CLIP mode]

INFORMATION

- S.FINE is the highest quality and NORMAL is the lowest setting. Choose the setting appropriate for your needs.
- This file format complies with the DCF (Design rule for Camera File system).
- JPEG (Joint Photographic Experts Group): JPEG is the image compression standard developed by the Joint Photographic Experts Group. This type of compression is most commonly used for compressing photos and graphics because it can compress the files efficiently without damaging the data.

Metering

■ If you cannot obtain suitable exposure conditions, you can change the metering method to take brighter pictures.

MULTI () : Exposure will be calculated based on an average of the available light in the image area. However, the calculation will be biased towards the centre of the image area. This is suitable for general use.

SPOT () : Only the rectangular area in the center of the LCD monitor will be metered for light. This is suitable when the subject in the center is exposed correctly, regardless of the back lighting.

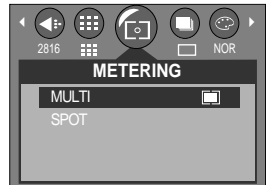

INFORMATION

- The default metering mode is Multi pattern metering.
- If the subject is not the centre of the focus area, do not use the spot metering as this may result in an exposure error. In this circumstance, rather use exposure compensation.

Continuous shot

■ Select the number of pictures in continuous shooting.

- [SINGLE] : Take one picture only
- [2, 4, 8 SHOTS] : Take the set number of pictures with one push of the shutter. Continuous shooting mode is cleared after one shooting.
- [AEB] : Take three pictures in a series in different exposures: short exposure (-0.5EV), standard exposure (0.0EV) and over exposure (+0.5EV). Use the mode if it is hard to decide exposure of the object.



[PROGRAM mode]

Continuous shot

- Available maximum number of continuous shots, by image size/ quality type (Unit : shot)

size \ quality	S.FINE	FINE	NORMAL
2816X2112	2	2	2
2272X1704	2	2	2
2048X1536	2	2	2
1600X1200	4	8	8
1024X768	8	8	8
640X480	8	8	8

- * High resolution and picture quality increases file saving time, which increases stand-by time.
- * If the [2, 4, 8 SHOTS] or [AEB] sub menu is selected, the flash will be off automatically.
- * If you change the image size and quality after selecting the number of continuous shots, the [SHOOTING] sub menu will be changed to the [SINGLE] automatically.

Effect

- By using the camera's digital processor, it is possible to add special effects to your images.

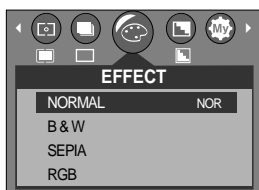

[PROGRAM mode]

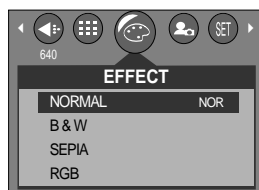

[MOVIE CLIP mode]

- NORMAL** : No effect is added to the image.
- B & W** : Converts the image to black and white.
- SEPIA** : Captured images will be stored in a sepia tone (a gradient of yellowish brown colours).
- RGB** : Allows the user to adjust the R (Red), G (Green), and B (Blue) values of the images to be captured.

Effect

● Setting RGB Values

1. Select the [RGB] sub menu and then press the OK button. The RGB menu bar will appear as shown.
2. Use the UP/ DOWN/ LEFT and RIGHT buttons to select the desired RGB value.
 - Up/Down Button: Navigates between R, G, and B icons.
 - Left/Right Button: Changes value of each icon.
3. When you press the OK button, the value you set will be saved and RGB setup mode will end.

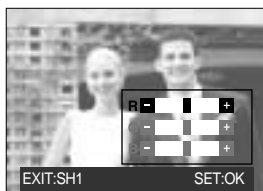

Sharpness

- You can adjust the sharpness of the picture you want to take. You cannot check the sharpness effect on the LCD monitor before you take a picture, because this function is applied only when the captured image is stored on the memory.

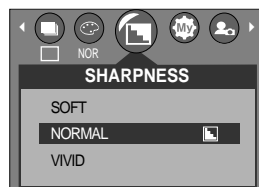

[PROGRAM mode]

Sub menu	Icon	Description
SOFT		The edges of the image are softened. This effect is suitable for editing images on your PC.
NORMAL		The edges of the image are sharp. This is suitable for printing.
VIVID		The edges of the image are emphasized. The edges will appear sharp, but noise may occur in the recorded image.

Save / Load the camera configuration (MYSET)

- Use the MYSET mode to save frequently used camera settings (SAVE) and use it later (LOAD)

- Saving the camera configuration: Available in the PROGRAM mode.

1. Rotate the MODE DIAL to select the PROGRAM mode and press the menu button.
2. Press the Left/Right buttons to select the [MYSET] menu tap.
3. Press the Up/Down buttons to select the [SAVE] menu and press the right button.
4. Press the Up/Down buttons to select desired MYSET slot number to save.
5. Press the OK button to save the current configuration in the selected MYSET slot.

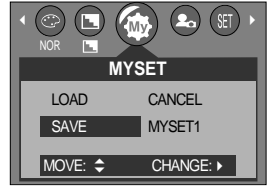

[PROGRAM mode]

- Loading the saved camera configuration: available in the PROGRAM mode.

1. Rotate the MODE DIAL to select the PROGRAM mode and press the menu button.
2. Press the Left/Right buttons to select the [MYSET] menu tap.
3. Press the Up/Down buttons to select the [LOAD] menu and press the right button.
4. Press the Up/Down buttons to select desired MYSET slot number to load.
5. Press the OK button to set the camera configuration as saved in the MYSET slot.



[PROGRAM mode]

- * The current MYSET slot number is displayed in the top left of the LCD.
- * If you select [CANCEL] in the [LOAD] menu, the MYSET mode will be canceled.

Scene

- Select the [SCENE] submenu to automatically configure optimal settings, depending on the selected scene.
Only available in the Scene Mode.



Sub menu	Icon	Description
PORTRAIT		To take picture of a person.
CHILDREN		Take a still picture of capturing moving children.
LANDSCAPE		Scenery with green woods or blue sky. Portrait with scenery background.
TEXT		Use this mode to shoot a document.
CLOSE UP		Close-up shooting for small objects such as plants and insects.
SUNSET		Splendor of the setting sun.
DAWN		Daybreak scenes.
BACKLIGHT		Portrait without shadows caused by back light.
FIREWORKS		Firework scenes.
BEACH & SNOW		For ocean, lake, and beach scenes and snowscapes.

INFORMATION

- When close-up, sunset, dawn, fireworks scene mode are selected, it is possible that camera shake will occur. If you think this will happen, use a tripod.

Starting play mode

- If the memory card is inserted in the camera, all the camera functions apply only to the memory card.
- If the memory card is not inserted in the camera, all the camera functions apply only to the internal memory.
- If you have turned on the camera by pressing the POWER button, you can press the PLAY MODE button once to switch to Play mode and press it again to switch to Recording mode.
- You can turn the power on with the play mode button. The camera is turned on in play mode. Press the play mode button again to switch to shooting mode.
- You can set up the PLAY mode function by using the camera buttons and LCD monitor.

● Playing back a still image

1. Select the PLAY mode by pressing the play mode button ().

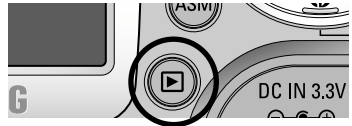

2. The last image stored on the memory is displayed on the LCD monitor.



3. Select an image that you want to play back by pressing the LEFT / RIGHT button.

※ Press and hold the Left or Right button to fast forward the images played.

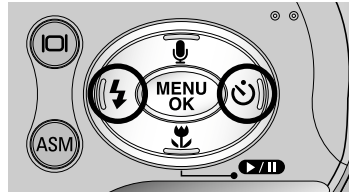

INFORMATION

- Even if the camera's power is off, you can start the play mode by pressing the play mode button.
- Lightly press the shutter button in Play mode to switch to the currently set shooting mode with the mode dial.

Starting play mode

■ Playing back a movie clip

Steps from 1-2 are the same as those to play back a still image.

3. Select the recorded movie clip that you want to play back by using the LEFT/RIGHT button. If you select a movie clip, the movie clip indicator () will be displayed on the LCD monitor.

4. Press the play & pause button () to play back a movie clip file.

- To pause a movie clip file while playing it back, press the play & pause button again.

- Pressing the play & pause button again will cause the movie clip file will restart.

- To rewind the movie clip while it is playing, press the LEFT button. To fast forward the movie clip, press the RIGHT button.

- To stop playback of the movie clip, press the play & pause button, and then press the LEFT or RIGHT button.



■ Playing back a recorded voice

Steps from 1-2 are the same as those to play back a still image.

3. Select the recorded voice that you want to play back by using the LEFT/RIGHT button. If you select a recorded voice file, the voice indicator () will be displayed on the LCD monitor.

4. Press the play & pause button () to play back a recorded voice file.

- To pause a recorded voice file, while playing it back, press the play & pause button again.

- To resume playback of the voice file, press the play & pause button.

- To rewind the voice file while it is playing, press the LEFT button.

To fast forward the voice file, press the RIGHT button.

- To stop playback of the voice file, press the play & pause button, and then press the LEFT or RIGHT button.



LCD monitor indicator

■ The LCD monitor displays information about the shooting conditions.

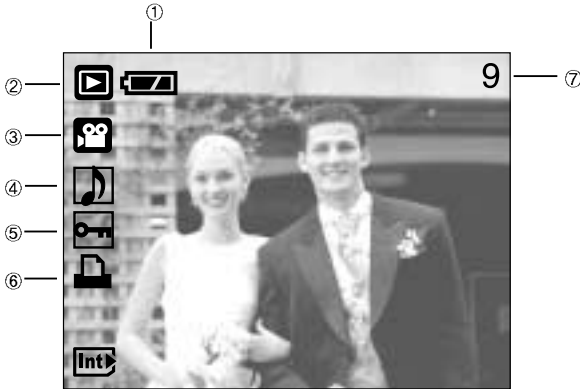

No.	Description	Icon	Page
1	Battery		p.16
2	Play mode		
3	File Type		
4	Voice memo		p.55
5	Protect indicator		p.65
6	DPOF indicator		p.66
7	Stored image number	9	

■ If you press the LCD button, you can check the following recording information:

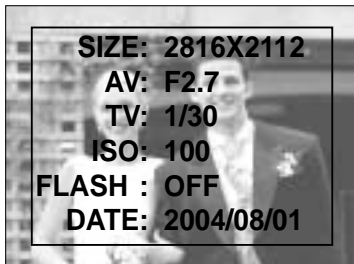

SIZE	: 2816X2112	Size
AV	: F2.7	Aperture value
TV	: 1/30	Shutter speed
ISO	: 100	ISO sensitivity
FLASH	: OFF	Whether or not the flash is used.
DATE	: 2004/08/01	Recording date

Using the camera buttons to adjust the camera

- In Play mode, you can use the buttons on the camera to conveniently set up the Play mode functions.

Thumbnail() / Enlargement() button

- You can view multiple pictures, enlarge a selected picture, and crop and save a selected area of an image.
- Thumbnail display
 1. While an image is displayed full screen, press the thumbnail button.
 2. The thumbnail display will highlight the image that had been showing at the time the thumbnail mode was selected.
 3. Press the 5 function button to move to a desired image.
 4. To view an image separately, press the enlargement button.

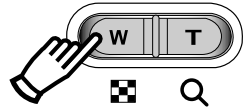

[Normal display mode]

Pressing the thumbnail button()

Pressing the enlargement button()

Highlighted image

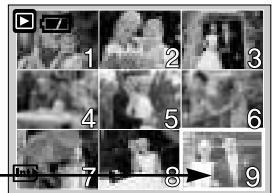

[Thumbnail display mode]

● Image enlargement

1. Select an image that you want to enlarge and press the enlargement button.
2. Different parts of the image can be viewed by pressing the 5 function button.
3. Pressing the thumbnail button will zoom back to the original full sized image.
 - You can tell whether the image displayed is an enlarged view by checking the image enlargement indicator shown at the bottom left of the LCD monitor. (If the image is not an enlarged view, the indicator will not be displayed.) You can also check the area of enlargement.
 - Movie clips and WAV files can't be enlarged.
 - If an image is enlarged, a loss of quality may occur.

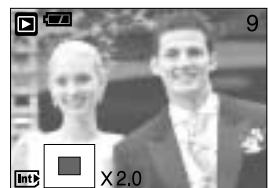
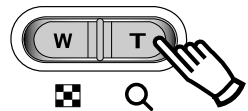

Thumbnail() / Enlargement() button

- The maximum enlargement rate in proportion to the image size.

Image size	2816/2272/2048/1600	1024	640
Maximum enlargement rate	X5.0	X3.2	X2.0

- Trimming : You can extract part of the image that you want and save it separately.

1. Select an image that you want to enlarge and press the enlargement button.
2. Different parts of the image can be viewed by pressing the 5 function button.
3. Press the MENU button and a message will be displayed as shown alongside.
4. Select the submenu values by pressing the UP/DOWN button and then press the OK button.
TRIM : trimmed images are saved in their last file names.
CANCEL : cancels trimming.

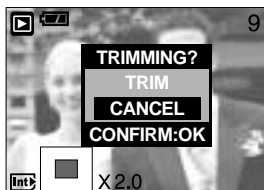

- If there is little memory space to save the trimmed image, the image can't be trimmed.

Voice() memo / Up button

- When the menu is displayed on the LCD monitor, pressing the UP button makes the menu cursor move up.
- When the menu is not displayed on the LCD monitor, the UP button operates as the voice memo button. You can add your audio to a stored still image.

- Adding a Voice Memo to a Still Image

1. Press the LEFT/ RIGHT button to select an image that you wish to add sound to.
2. Press the voice memo button () and the voice memo indicator will display. The camera is now ready to record a voice memo.

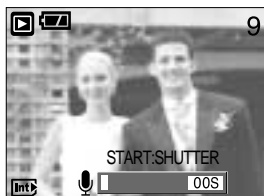

Voice () memo / Up button

3. Press the shutter button to start recording and voice will be recorded to the still image for 10 seconds.
While the voice is recording, the recording status window will be displayed as shown alongside.



4. The recording can be stopped by pressing the shutter button again.

5. The () icon will be displayed on the LCD monitor after voice memo recording has finished.

- Voice memos can't be recorded onto movie clip files.
- A distance of 40cm between you and the camera (microphone) is the best distance to record sound.
- The voice memo will be saved in *.wav format, but has the same file name as the still image to which it corresponds.
- If you add a new voice memo to the still image that already has a voice memo, the existing voice memo will be erased.



Play & Pause () / Down button

- In Play mode, the play & pause/ down button works as follows:

- If the menu is displayed
Press the DOWN button to move from the main menu to a sub menu, or to move down the sub menu cursor.
- If a still image with a voice memo, a voice file, or a movie clip is playing
In Stop mode : Plays a still image with a voice memo, a voice file, or a movie clip.
During playback : Temporarily stops playback.
In Pause mode : Resumes playback



[Voice recording is stopped]



[Voice recording is playing]



[Voice recording is paused]

LEFT/ RIGHT/ MENU/ OK button

■ LEFT / RIGHT/ MENU/ OK buttons activate the following.

- LEFT button : While the menu is showing, press the LEFT button to select the menu tab to the left of the cursor.
- RIGHT button : While the menu is showing, press the RIGHT button to select the menu tab to the right of the cursor, or to move an secondary menu.
- MENU button : When you press the MENU button, the play mode menu will be displayed on the LCD monitor. Pressing it again will return the LCD to the initial display.
- OK button : When the menu is displayed on the LCD monitor, the OK button is used for confirming data that is changed by using the 5 function button.

LCD (|O|) button

■ The shooting information will be displayed on the LCD monitor.

The last image stored in the memory is displayed on the LCD monitor by pressing the play mode button.

Pressing the LCD (|O|) button in the PLAY mode will change the display as shown below. [Image & Icons] → [Image & Information] → [Image only]

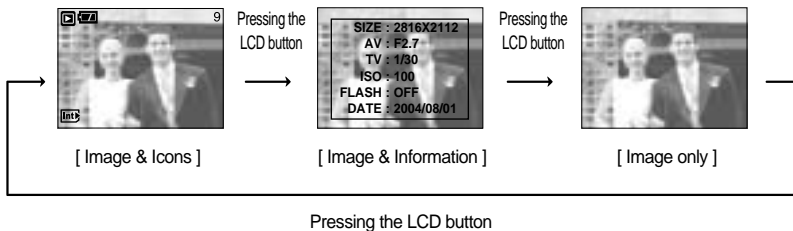

* The LCD button is not available for voice recording in play mode.

Delete() button

■ This deletes images stored on the memory card.

● Deleting Images in Play Mode

1. Select an image that you want to delete by pressing the LEFT / RIGHT button and press the DELETE() button.
2. A message will display as shown alongside on the LCD monitor.
3. Select the submenu values by pressing the UP/DOWN button and then press the OK button.
If [DELETE] is selected: deletes the selected images.
If [CANCEL] is selected: cancels "Delete Image"

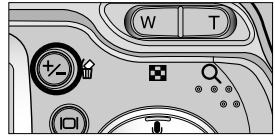

● Deleting Images in Thumbnail Display Mode

1. Use the UP, DOWN, LEFT, and RIGHT buttons to select the image you want to delete, and then press the DELETE button.
2. The following message will be displayed on the LCD monitor.

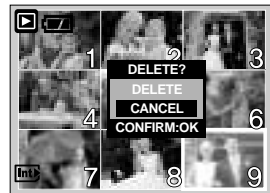
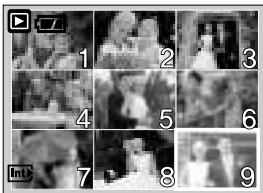

3. Select the submenu values by pressing the UP/DOWN button and then press the OK button.
If [DELETE] is selected: deletes the selected images.
If [CANCEL] is selected: cancels "Delete Image"







INFORMATION

- Before deleting images from the camera, you should protect or download images to your computer that you wish to keep.

Setting up the play back function using the LCD monitor





- PLAY mode functions can be changed by using the LCD monitor. In the PLAY mode, pressing the MENU button displays the menu on the LCD monitor. The menus you can set up in Play mode are as follows. To capture an image after setting up the play menu, press the PLAY button.

The items indicated by are default settings.



Menu tab	Main menu	Sub menu	Secondary menu	Page
	SLIDE	INTERVAL	1, 3, 5, 10SEC	p. 62
		REPEAT	ON / OFF	
		START		
	ROTATE	RIGHT90	-	p. 63
		LEFT90	-	
		180	-	
		HORIZONTAL	-	
		VERTICAL	-	
	RESIZE	2272X1704		p. 64
		2048X1536	-	
		1600X1200	-	
		1024X768	-	
		640X480	-	
		LOGO	-	
	PROTECT	ONE PIC	UNLOCK / LOCK	p. 65
		ALL PICS	UNLOCK / LOCK	
	DELETE ALL	NO	-	p. 66
		YES	-	
	DPOF	STANDARD	ONE PIC/ALL PICS	p. 66 ~ p. 68
		INDEX	NO/ YES	
		SIZE	DEFAULT/3X5/4X6/5X7/8X10	
		CANCEL	STANDARD/INDEX/SIZE	
	COPY	NO	-	p.69
		YES	-	

Setting up the play back function using the LCD monitor

- This menu is available while the camera is connected to a PictBridge supporting printer (direct connection to the camera, sold separately) with a USB cable.

Menu tab	Main menu	Sub menu	Secondary menu	Page
	IMAGES	SELECT	-	p. 71
		ALL	-	
	PRINT	STANDARD	-	p. 72
		INDEX	-	
	DPOF PRINT	NO	-	p. 72
		YES	-	
	AUTO SET	NO	-	p. 73
		YES	-	
	CUSTOM SET	SIZE	AUTO	p. 73
			POSTCARD	
			4X6	
			8X10	
			A6	
			A4	
			B5	
		LAYOUT	AUTO	
			INDEX	
			1	
			FULL	
			2	
			4	
			6	
8				

Setting up the play back function using the LCD monitor

Menu tab	Main menu	Sub menu	Secondary menu	Page
	CUSTOM SET	TYPE	AUTO	p. 73
			PLAIN	
			PHOTO	
			FAST PHO.	
		QUALITY	AUTO	
			DRAFT	
			NORMAL	
			FINE	
		DATE	AUTO	
			OFF	
			ON	
		FILE NAME	AUTO	
OFF				
ON				
	RESET	NO	-	p. 74
		YES	-	

※ Menus are subject to change without prior notice.

Starting the slide show

- Images can be displayed continuously at pre-set intervals.

1. Press the play mode button and press the menu button.
2. Press the LEFT/ RIGHT button and select the [SLIDE] menu tab.



- Setting play interval: Set the slide show play interval.
 1. Use the Up/Down buttons to select the [INTERVAL] menu and press the Right button.
 2. Use the Up/Down buttons to select the desired interval.
 3. Press the OK button to save the configuration.
- Repeat setting : Repeat or not the slide show after finishing the first cycle.
 1. Use the Up/Down buttons to select the [REPEAT] menu and press the Right button.
 2. Use the Up/Down buttons to select the desired sub menu.
 - [OFF] Selected : The slide show is closed after one cycle.
 - [ON] selected : The slide show is repeated until canceled.
 3. Press the OK button to save the configuration.
- Start the slide show: The slide show can start only in the [START] menu.
 1. Use the Up/Down buttons to select the [START] menu.
 2. Press the OK button to start the slide show.
 - Press the Pause button to pause the slide show.
 - Press the Pause button () again to resume the slide show.
 - Press the Menu button to stop the slide show.

INFORMATION

- The loading time depends on the image size and quality.
- The slide show will start from an image that was displayed on the LCD monitor. The [PWR SAVE] function can't be activated.
- While the slide show is playing, only the first frame of an MOVIE file is displayed.

Rotating an image

■ You can rotate the stored images by various degrees.

1. Press the play mode button and press the menu button.
2. Press the LEFT/ RIGHT button and select the [ROTATE] menu tab.
3. Select a desired sub menu by pressing the UP/ DOWN button.

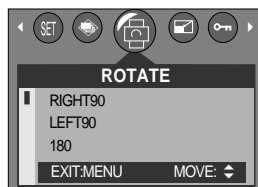

[RIGHT 90] :
Rotate picture in a clock-wise
direction



[LEFT 90] :
Rotate picture in a counter-
clock-wise direction



[180] :
Rotate picture 180 degrees



[HORIZONTAL] :
Rotate picture horizontally



[VERTICAL] :
Rotate picture vertically

4. Press the OK button. The rotated image will be saved with a new file name and the menu will disappear. If you display the rotated image on the LCD monitor, empty spaces may appear to the left and right of the image.

Resize

- Change the resolution (size) of pictures taken. Select [LOGO] to save an image to be the start-up image. The resized image will have a new file name.

1. Press the play mode button and press the menu button.
2. Press the LEFT/ RIGHT button and select the [RESIZE] menu tab.
3. Select a desired sub menu by pressing the UP/ DOWN button and press the OK button.



● Image Resize Types

Resize	2272X 1704	2048X 1536	1600X 1200	1024X 768	640X 480	LOGO
2816	O	O	O	O	O	O
2272	X	O	O	O	O	O
2048	X	X	O	O	O	O
1600	X	X	X	O	O	O
1024	X	X	X	X	O	O
640	X	X	X	X	X	O

INFORMATION

- A large sized image can be resized to a smaller sized image, but not vice versa.
- Only JPG images can be resized. MOVIE and WAV files can't be resized.
- You can change the resolution of only those files compressed in the JPEG 4:2:2 format.
- The resized image will have a new file name. The [LOGO] image is stored not on the memory card but on the internal memory.
- Only one [LOGO] image can be saved. If you save a new [LOGO] image, the existing startup image will be deleted.
- If the memory capacity is insufficient to store the resized image, a [CARD FULL!] message will display on the LCD monitor and the resized image will not be stored.

Protecting images

- This is used to protect specific shots from being accidentally erased (LOCK). It also unprotects images that have been previously protected (UNLOCK).

● Protecting Images

1. Press the play mode button and press the menu button.
2. Press the LEFT/ RIGHT button and select the [PROTECT] menu tab.
3. Select a desired sub menu by pressing the UP/ DOWN button and press the OK button.

[ONE PIC] : Only an image that is displayed on the LCD monitor is protected or unprotected.

[ALL PICS] : All of the stored images are protected or unprotected.

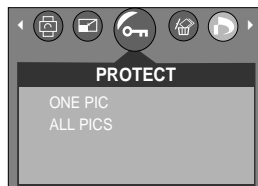

4. Select the desired secondary menu by pressing the UP/DOWN button and press the OK button.

[UNLOCK] : Cancels the protect function.

[LOCK] : Sets up the protect function.

- If you select the [ONE PIC] sub menu at step 3, you can protect or unprotect another image by pressing the LEFT/ RIGHT button. If you press the SHUTTER button, the Image Protection menu will disappear.

- If you selected [ALL] in Step 3, the Image Protection menu will disappear.

- If you protect an image, the protect icon() will be displayed on the LCD monitor.

(An unprotected image has no indicator)

- An image in LOCK mode will be protected from [DELETE] or [DELETE ALL] functions, but will NOT be protected from the [FORMAT] function.

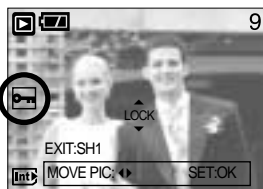

Deleting all images

- Of all the files stored in the memory card, the unprotected files in the DCIM subfolder will be deleted. Remember that this will permanently delete unprotected images. Important shots should be stored on a computer before deletion takes place. The startup image is stored in the camera's internal memory (i.e., not on the memory card) and it will not be deleted even if you delete all files on the memory card.

● Deleting all images

1. Press the play mode button and press the menu button.
2. Press the LEFT/ RIGHT button and select the [DELETE ALL] menu tab.
3. Select a desired sub menu by pressing the UP/ DOWN button and press the OK button.

Selecting [NO] : cancels "Delete All"

Selecting [YES] : Displays the dialogue box to confirm the delete.

- If [DELETE] is selected : press the OK button and all unprotected pictures are deleted.

- If [CANCEL] is selected : press the OK button and images are not deleted.



DPOF

- DPOF(Digital Print Order Format) allows you to embed printing information on your memory card's MISC folder. Select the pictures to be printed and how many prints to make.
- The DPOF indicator will display on the LCD monitor when an image that has DPOF information plays back. Images can then be printed on DPOF printers, or at an increasing number of photo labs.
- This function is not available for Movie clips and Voice recording files.

DPOF : STANDARD

■ This function allows you to embed print quantity information on a stored image.

1. Press the play mode button and press the menu button.
2. Press the LEFT/ RIGHT button and select the [DPOF] menu tab.
3. Select the [STANDARD] menu by pressing the UP/ DOWN button and press the RIGHT button.
4. Use the UP and DOWN buttons to select [ONE PIC] or [ALL PICS], and then press the OK button. A window for selecting number of copies.

[ONE PIC] : Set the number of copies to print for the current picture only.

[ALL PICS] : Set the number of copies to print for each picture, excluding movie clips and voice recordings.

5. Use the UP and DOWN buttons to select the number of copies and then press the OK button.

- The DPOF icon () will appear by the pictures for which the number of copies to print is set.

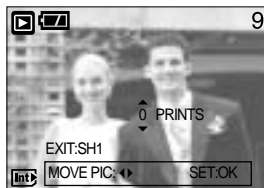

DPOF : INDEX

■ Images (except for movie clips and voice file) are printed as index type.

1. Press the play mode button and press the menu button.
2. Press the LEFT/ RIGHT button and select the [DPOF] menu tab.
3. Select the [INDEX] menu by pressing the UP/ DOWN button and press the RIGHT button.
4. Select a desired sub menu by pressing the UP/ DOWN button.

If [NO] is selected : The image will not be printed in index format.

If [YES] is selected : The image will be printed in index format.

5. Press the OK button to confirm the setting.
6. Press the menu button twice and the menu will disappear.



DPOF : PRINT SIZE

- You can specify the print size when printing images stored on the memory card.
The [SIZE] menu is available only for DPOF 1.1 compatible printers.

- Setting the Print Size

1. Press the play mode button and press the menu button.
2. Press the LEFT/ RIGHT button and select the [DPOF] menu tab.
3. Select the [SIZE] menu by pressing the UP/ DOWN button and press the RIGHT button.
4. Select a desired sub menu by pressing the UP/ DOWN button and press the OK button.



* PRINT SIZE : DEFAULT, 3X5, 4X6, 5X7, 8X10

* The [DEFAULT] print size varies depending on the printer manufacturer.

For your printer's default value, please refer to the user's guide that came with your printer.

DPOF : CANCEL

- You can cancel the [STANDARD], [INDEX], or [SIZE] settings. Cancel the setting to reset the value to its default.

1. Press the play mode button and press the menu button.
2. Press the LEFT/ RIGHT button and select the [DPOF] menu tab.
3. Select the [CANCEL] menu by pressing the UP/ DOWN button and press the RIGHT button.
4. Select a desired sub menu by pressing the UP/ DOWN button.

If [STANDARD] is selected : Cancels the standard print setting.

If [INDEX] is selected : Cancels the index print setting.

If [SIZE] is selected : Cancels the print size setting.

5. Press the OK button to confirm the setting.



COPY TO CARD

- This enables you to copy image files to the memory card.
- Copying to the Memory Card
 1. Press the play mode button and press the menu button.
 2. Select the [COPY TO CARD] menu tab by pressing the LEFT/ RIGHT button.
 3. Select a desired sub menu by pressing the UP/ DOWN button and press the OK button.
 - [NO] : The Play mode screen is displayed
 - [YES] : All images saved in the internal memory are copied to the memory card after the [PLEASE WAIT!] message is displayed. After copying has been completed, the screen will return to play mode.

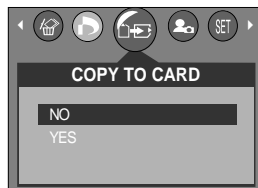

INFORMATION

- When this menu is selected without inserting a memory card, you can't select the [COPY TO CARD] sub menus.
- If there is not enough space available in the memory card to copy saved images in the internal memory (32MB), the [COPY TO CARD] command will copy only some of the images and display [CARD FULL!] message. Then the system will return to the playback mode. Please be sure to delete any unnecessary images to free up space before inserting the memory card into the camera.

PictBridge

■ You can use the USB cable to connect this camera to a printer that supports PictBridge (sold separately) and print the stored images directly. Movie clips and voice files cannot be printed. You can set up the following settings from the PictBridge menu.

IMAGES	: Select the pictures to be printed.
PRINTER SETUP	: Setting up printing(AUTO SET/CUSTOM SET)
PRINT	: Printing pictures
DPOF AUTO PRINT	: Printing the DPOF files
RESET	: Initializing the PictBridge functions

● Connecting the Camera to a Printer

1. Press the power button to turn the camera power on.
2. In a mode other than Voice Recording mode, press the MENU button.
3. Press the LEFT/ RIGHT button and select [SETUP] menu tab.
4. Select [USB] menu by pressing the UP/ DOWN button and press the RIGHT button.
5. Select [PRINTER] menu by pressing the UP/ DOWN button and press the OK button.
6. Press the menu button twice and the menu will disappear.
7. Use the supplied USB cable to connect the camera to the printer as shown below.
8. Turn on the printer to connect the camera to the printer.

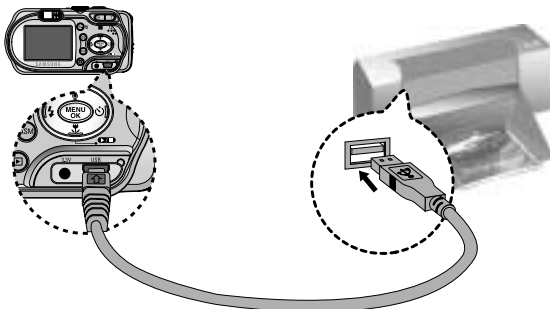
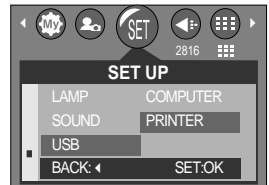

※ If you selected [COMPUTER] in Step 5, when you connect the camera to your printer, the Mode dial lamp(Green) will illuminate and the connection will not be established. In this case, disconnect the USB cable, and then follow the procedure from Step 2 and onward.

PictBridge: Picture Selection

■ Select pictures to print

1. Connect the camera to your printer. The USB menu must be set to [PRINTER] before you connect the camera to the printer. (See p.70)
2. The [IMAGES] menu will appear.
3. Use the UP and DOWN buttons to select the desired submenu value, and then press the OK button.

When [SELECT] is selected : The PictBridge function will be applied only to the picture currently displayed.

When [ALL] is selected : The PictBridge function will be applied to all pictures, excluding movie clips and voice files.

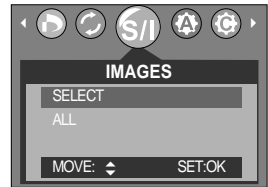

● Setting the Number of Copies to Print

- Select [SELECT] or [ALL]. A screen where you can set the number of copies to print will appear as shown below.

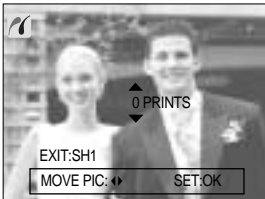

[When [SELECT] is selected]

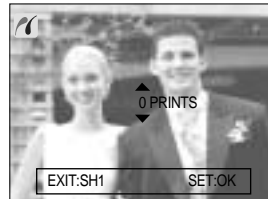

[When [ALL] is selected]

- Press the Up/Down button to select the number of prints. Maximum 30 prints.
- Use the Left/Right button to select another picture and select the number of prints for another picture.
- After setting the number of prints, press the OK button to save.
- Press the Shutter button to return to the menu without setting the number of prints.

PictBridge: Printing

■ Printing Pictures

1. Connect the camera to your printer. The USB menu must be set to [PRINTER] before you connect the camera to the printer.(See p.70)
2. Use the LEFT and RIGHT buttons to select the [PRINT] menu tab.
3. Use the UP and DOWN buttons to select the desired submenu value, and then press the OK button.

[STANDARD] : Print the pictures stored in the memory card in set numbers. One picture is printed on one piece of paper.

[INDEX] : Print multiple images on one sheet of paper.

4. The screen shown on the right will appear and the picture will be printed. If no picture is selected, the [NO IMAGE!] message will be displayed. Press the shutter button while printing to cancel the printing and the [IMAGES] menu is displayed.

※ Number of pictures in a index print varies depends on the printer used.

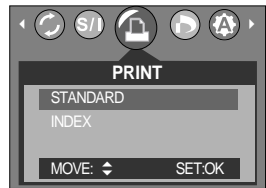

■ DPOF PRINT : This allows you to directly print the files with DPOF information.

1. Connect the camera to your printer. The [USB] menu must be set to [PRINTER] before you connect the camera to the printer.(See p.70)
2. Use the LEFT and RIGHT buttons to select the [DPOF PRINT] menu tab.
3. Use the UP and DOWN buttons to select the desired submenu value, and then press the OK button.

[NO] : Cancel the printing

[YES]: Directly print the file with the DPOF information

※ Depending on the manufacturer and printer model, some menus may not be available. With a printer without supporting the DPOF, the menu is still displayed but not available.

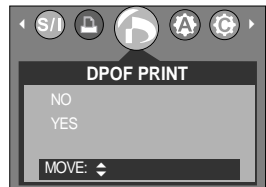

PictBridge: Print Setting

■ AUTO SET

1. Connect the camera to your printer. The USB menu must be set to [PRINTER] before you connect the camera to the printer. (See p.70)
2. Use the LEFT and RIGHT buttons to select the [AUTO SET] menu tab.
3. Use the UP and DOWN buttons to select the desired submenu value, and then press the OK button.
[NO] : [CUSTOM SET] values are kept.
[YES]: All values in the [CUSTOM SET] are automatically changed.



■ CUSTOM SET : You can select the Paper Size, Print Format, Paper Type, Print Quality, Date Print, and File Name Print menus for printed pictures.

1. Connect the camera to your printer. The [USB] menu must be set to [PRINTER] before you connect the camera to the printer. (See p.70)
2. Use the LEFT and RIGHT buttons to select the [CUSTOM SET] menu tab.
3. Use the UP and DOWN buttons to select the desired submenu value, and then press the RIGHT button.
4. Use the UP and DOWN buttons to select the desired submenu value, and then press the OK button.



■ The menus you can set up are as follows:

Menu	Function	Sub menu
SIZE	Setting the size of the printing paper	AUTO, POSTCARD, 4x6, 8x10, A6, A4, B5
LAYOUT	Setting the number of pictures to be printed on a sheet of paper	AUTO, INDEX, 1, FULL 2, 4, 6, 8
TYPE	Setting the quality of the printing paper	AUTO, PLAIN, PHOTO, FASTPHO.
QUALITY	Setting the quality of the picture to be printed	AUTO, DRAFT, NORMAL, FINE
DATE	Setting whether to print the date	AUTO, OFF, ON
FILE NAME	Setting whether to print the file name	AUTO, OFF, ON

- ※ Some menu options are not supported in all manufacturer and printer models.
- ※ If the setting values are not changed in the automatic/manual setting, the setting values are automatically kept.

PictBridge : RESET

■ Initializes user-changed configurations.

1. Connect the camera to your printer. The [USB] menu must be set to [PRINTER] before you connect the camera to the printer.(See p.70)
2. Use the LEFT and RIGHT buttons to select the [RESET] menu tab.
3. Use the UP and DOWN buttons to select the desired submenu value, and then press the OK button.
 - If [NO] is selected : Settings will not be reset.
 - If [YES] is selected : All print and image settings will be reset.



※ Default print setting varies depending on the printer manufacturer.

For your printer's default setting, refer to the user's guide that came with your printer.

Setup menu

■ In this mode, you can set up basic settings. You can use the setup menu in all camera modes, except Voice Recording mode.

The items indicated by are default settings.

Menu tab	Main menu	Sub menu	Secondary menu	Page		
	FILE	RESET	-	p.76		
		SERIES	-			
	PWR SAVE	OFF, 1, 3 , 5, 10MIN	-	p.77		
	LANGUAGE	A T Y P E	ENGLISH	B T Y P E	ENGLISH	p.78
			한국어		简体中文	
			FRANÇAIS		繁體中文	
			DEUTSCH		DANSK	
			ESPAÑOL		SVENSKA	
			ITALIANO		THAI	
			РУССКИЙ		MELAYU	
			DUTCH		عربي	
			PORTU.			
	FORMAT	NO		-	p.79	
		YES		-		
	DATE&TIME	04/08/01 13:00		-	p.80	
	DATE TYPE	YY/MM/DD		-	p.80	
		DD/MM/YY		-		
		MM/DD/YY		-		
	IMPRINT	DATE		-	p.81	
		D & TIME		-		
		OFF		-		
LAMP	ON		-	p.81		
	OFF		-			
SOUND	OFF		-	p.82		
	LOW		-			
	MEDIUM		-			
	HIGH		-			

Setup menu

Menu tab	Main menu	Sub menu	Secondary menu	Page
	USB	COMPUTER		p.83
		PRINTER		
	LCD	DARK		p.83
		NORMAL		
		BRIGHT		
	Q.VIEW	OFF, 1, 2, 3SEC		p.84
	RESET	YES		p.84
		NO		

* Menus are subject to change without prior notice.

File name

■ This function allows the user to select the file naming format.

● Assigning File Names

1. In any mode with the exception of Voice Recording mode, press the MENU button.
2. Press the LEFT/ RIGHT button and select the [SETUP] menu tab.
3. Select the [FILE] menu by pressing the UP/ DOWN button and press the RIGHT button.
4. Select a desired sub menu by pressing the UP/ DOWN button and press the OK button.

[RESET] : After using the reset function, the next file name will be set from 0001 even after formatting, deleting all or inserting a new memory card.

[SERIES] : New files are named using numbers that follow the previous sequence, even when a new memory card is used, or after formatting, or after deleting all pictures

5. Press the menu button twice and the menu will disappear.



File name

INFORMATION

- The first stored folder name is 100SSCAM, and the first file name is STA60001.
- File names are assigned sequentially from STA60001 → STA60002 → ~ → STA69999.
- The folder number is assigned sequentially from 100 to 999 as follows: 100SSCAM → 101SSCAM → ~ → 999SSCAM.
- The files used with the memory card conform to the DCF(Design rule for Camera File systems) format.

Auto power off

- This function switches the camera off after a set amount of time in order to prevent unnecessary battery drainage.

● Setting Power Off

1. In any mode with the exception of Voice Recording mode, press the MENU button.
2. Press the LEFT/ RIGHT button and select the [SETUP] menu tab.
3. Select the [PWR SAVE] menu by pressing the UP/ DOWN button and press the RIGHT button.
4. Select a desired sub menu by pressing the UP/ DOWN button and press the OK button.

Selecting [OFF] : The power off function will not operate.

[1, 3, 5, 10 MIN] : The power will turn off automatically if not used for the period of time specified.

5. Press the menu button twice and the menu will disappear.



INFORMATION

- Even if the batteries or AC adapter are removed and inserted again, the power off setting will be preserved.
- Note that the automatic power off function will not operate if the camera is in PC mode, slide show, playing back a voice recording or movie clip.

Language

- There is a choice of languages that can be displayed on the LCD monitor. Even if the batteries or AC adapter are removed and inserted again, the language setting will be preserved.

● Setting Language

1. In any mode with the exception of Voice Recording mode, press the MENU button.
2. Press the LEFT/ RIGHT button and select the [SETUP] menu tab.
3. Select the [LANGUAGE] menu by pressing the UP/ DOWN button and press the RIGHT button.
4. Select a desired sub menu by pressing the UP/ DOWN button and press the OK button.



LANGUAGE sub menu

Type A : English, Korean, French, German, Spanish, Italian, Russian, Dutch and Portuguese.

Type B : English, S. Chinese, T. Chinese, Danish, Swedish, Thai, Malaysian and Arabic.

5. Press the menu button twice and the menu will disappear.

Formatting a memory card

- This is used for formatting the memory card. If you run [FORMAT] on the memory card, all images, including the protected images, will be deleted. Be sure to download important images to your PC before formatting the memory card.
- If the memory card is not inserted, the internal memory will be formatted.

● Formatting a Memory Card

1. In any mode other than Voice Recording mode, press the MENU button.
2. Press the LEFT/ RIGHT button and select the [SETUP] menu tab.
3. Select the [FORMAT] menu by pressing the UP/ DOWN button and press the RIGHT button.
4. Select a desired sub menu by pressing the UP/ DOWN button and press the OK button.
If [NO] is selected: The memory card will not be formatted.

Press the menu button twice and the menu display will disappear.

- If [YES] is selected: Select the [FORMAT] menu by pressing the UP/DOWN button and press the OK button. A [PLEASE WAIT!] message appears and the memory card will be formatted. If you ran FORMAT in Play mode, a [NO IMAGE!] message will appear.



INFORMATION

- Be sure to run [FORMAT] on the following types of memory card.
 - A new memory card, or an unformatted memory card.
 - A memory card that has a file this camera can't recognize or one that has been taken from another camera.
- Always format the memory card using this camera. If you insert a memory card that has been formatted using other cameras, memory card readers, or PCs, you will get a [CARD ERROR!] message.

Setting up the Date/ Time

- You can change the date and time that will be displayed on the captured images.

● Setting Date/Time

1. In any mode with the exception of Voice Recording mode, press the MENU button.
2. Press the LEFT/ RIGHT button and select the [SETUP] menu tab.
3. Select the [DATE&TIME] menu by pressing the UP/ DOWN button and press the RIGHT button.
4. Use the UP, DOWN, LEFT, and RIGHT buttons to select the desired submenu value, and then press the OK button.
RIGHT button : Selects the year/month / day/hour / minute.
LEFT button : Moves the cursor to the [DATE&TIME] main menu if the cursor is at the first item of the date and time setup. In all other cases, the cursor will be shifted to the left of its current position.
UP and DOWN buttons : Changes the setting value.
5. Press the menu button twice and the menu will disappear.



Date type

- You can change the date type that will be displayed on the captured images.

● Setting up the Date type

- Steps from 1-2 are the same as those for Setting up the Date/ Time .
3. Select the [DATE TYPE] menu by pressing the UP/ DOWN button and press the RIGHT button.
 4. Use the UP/DOWN buttons to select the desired submenu value, and then press the OK button.
- Date type : [YY/MM/DD]/ [MM/DD/YY]/ [DD/MM/YY]
 5. Press the menu button twice and the menu will disappear.

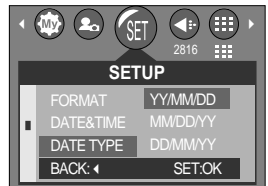

Imprinting the recording date

- There is an option to include DATE/TIME on still images.

- Date Imprinting

1. In any mode with the exception of Voice Recording mode, press the MENU button.
2. Press the LEFT/ RIGHT button and select the [SETUP] menu tab.
3. Select the [IMPRINT] menu by pressing the UP/ DOWN button and press the RIGHT button.
4. Use the UP and DOWN buttons to select the desired date imprint type, and then press the OK button.

[DATE] : Only the DATE will be imprinted on the image file.

[D&TIME] : The DATE & TIME will be imprinted on the image file.

[OFF] : The DATE & TIME will not be imprinted on the image file.

5. Press the menu button twice and the menu will disappear.



INFORMATION

- The Date & Time are imprinted at the bottom right side of the still image.
- The date will be imprinted as a DATE TYPE setting.
- TIME is imprinted in the following way : [Hour : Minute] and hours are shown using the 24 hour clock.
- The imprint function is applied only to still images.

Function lamp

- You can turn on and off the function lamp located on the front of the camera.

- Setting the function lamp

1. In any mode with the exception of Voice Recording mode, press the MENU button.
2. Press the LEFT/ RIGHT button and select the [SETUP] menu tab.
3. Select the [LAMP] menu by pressing the UP/ DOWN button and press the RIGHT button.
4. Select a desired sub menu by pressing the UP/ DOWN button and press the OK button.

If [ON] is selected : The function lamp will light up.

If [OFF] is selected : The function lamp will not light up.

5. Press the menu button twice and the menu will disappear.



Function lamp

● Description of the Function lamp

Function	Description
During power-on	Function lamp blinks and then turns off when the camera is ready to take a picture
After an image is captured	Function lamp will blink once.
During voice recording	Function lamp will blink at a 1-second interval.
While recording a movie clip	Function lamp will blink at a 1-second interval.
When the self-timer is activated	Even if the function lamp is set to OFF, the self-timer lamp will work. (See page 34.)

Sound

■ If you set the operation sound to ON, various sounds will be activated for camera startup, when buttons are pressed, and if there is a card error, so that you can be aware of the camera operation status.

● Setting Operation Sounds

1. In any mode with the exception of Voice Recording mode, press the MENU button.
2. Press the LEFT/ RIGHT button and select the [SETUP] menu tab.
3. Select the [SOUND] menu by pressing the UP/ DOWN button and press the RIGHT button.
4. Select a desired sub menu by pressing the UP/ DOWN button and press the OK button.
[SOUND] sub menu : OFF/ LOW/ MEDIUM/ HIGH
5. Press the menu button twice and the menu will disappear.



Selecting an External Device (USB)

■ You can select an external device to which you want to connect the camera using the USB cable.

● Selecting an External Device

1. In any mode with the exception of Voice Recording mode, press the MENU button.
2. Press the LEFT/ RIGHT button and select the [SETUP] menu tab.
3. Select the [USB] menu by pressing the UP/ DOWN button and press the RIGHT button.
4. Select a desired sub menu by pressing the UP/ DOWN button and press the OK button.



[COMPUTER] : Select this if you want to connect the camera to your PC.

Refer to page 105 for instructions on how to connect the camera to your PC.

[PRINTER] : Select this if you want to connect the camera to your printer.

Refer to page 70 for instructions on how to connect the camera to your printer.

5. Press the menu button twice and the menu will disappear.

LCD brightness

■ You can adjust the LCD brightness.

● Adjusting LCD Brightness

1. In any mode with the exception of Voice Recording mode, press the MENU button.
2. Press the LEFT/ RIGHT button and select the [SETUP] menu tab.
3. Select the [LCD] menu by pressing the UP/ DOWN button and press the RIGHT button.
4. Select a desired sub menu by pressing the UP/ DOWN button and press the OK button.



[LCD] sub menu : DARK, NORMAL, BRIGHT

5. Press the menu button twice and the menu will disappear.

Quick view

- If you enable Quick View before capturing an image, you can view the image you just captured on the LCD monitor for the duration set in the [Q.VIEW] setup. Quick view is possible only with still images.

● Setting Quick View

1. In any mode with the exception of Voice Recording mode, press the MENU button.
2. Press the LEFT/ RIGHT button and select the [SETUP] menu tab.
3. Select the [Q.VIEW] menu by pressing the UP/ DOWN button and press the RIGHT button.
4. Select a desired sub menu by pressing the UP/ DOWN button and press the OK button.

[OFF] : The quick view function can't be activated.

[1 ~ 3 SEC] : The captured image is briefly displayed during the selected time.

5. Press the menu button twice and the menu will disappear.



Initialization(RESET ALL)

- All camera menu and function settings will be restored to their default values. However, values for DATE/TIME and LANGUAGE will not be changed.

● Initializing the Camera

1. In any mode with the exception of Voice Recording mode, press the MENU button.
2. Press the LEFT/ RIGHT button and select the [SETUP] menu tab.
3. Select the [RESET] menu by pressing the UP/ DOWN button and press the RIGHT button.
4. Select a desired sub menu by pressing the UP/ DOWN button and press the OK button.

If [YES] is selected : All settings will be restored to their defaults.

If [NO] is selected : Settings will not be restored to their defaults.

5. Press the menu button twice and the menu will disappear.



Setting up the MYCAM menu

- You can set up a start up image, start up sound and shutter sound. Every camera working mode (with the exception of Voice recording mode) has the MyCAM menu. The items indicated by  are default settings.

Menu tab	Main menu	Sub menu		Page
	S.IMAGE	OFF	IMAGE 1	p.85
		IMAGE 2	USER IMAGE	
	SH.SOUND	OFF	SH.SOUND 1	p.86
		SH.SOUND 2	SH.SOUND 3	
	S.SOUND	OFF	SOUND 1	p.86
		SOUND 2	SOUND 3	

* Menus are subject to change without prior notice.

Start up image

- You can select the image that is first displayed on the LCD monitor whenever the camera is turned on.
- Setting a Startup Image
 1. In any mode with the exception of Voice Recording mode, press the MENU button.
 2. Press the LEFT/ RIGHT button and select the [MYCAM] menu tab.
 3. Select the [S.IMAGE] menu by pressing the UP/ DOWN button and press the RIGHT button.
 4. Select a desired sub menu by pressing the UP/ DOWN button and press the OK button.
 5. Press the menu button twice and the menu will disappear.



INFORMATION

- Use a saved image for the start-up image with the [LOGO] in the [RESIZE] menu in the play mode.
- The start-up image will not be deleted by deleting all images or [FORMAT] menu.

Shutter sound

■ You can select the shutter sound.

● Selecting the Shutter Sound

1. In any mode with the exception of Voice Recording mode, press the MENU button.
2. Press the LEFT/ RIGHT button and select the [MYCAM] menu tab.
3. Select the [SH.SOUND] menu by pressing the UP/ DOWN button and press the RIGHT button.
4. Select a desired sub menu by pressing the UP/ DOWN button and press the OK button.
5. Press the menu button twice and the menu will disappear.



Start up sound

■ You can select the sound that is activated whenever the camera is turned on.

● Setting the Startup Sound

1. In any mode with the exception of Voice Recording mode, press the MENU button.
2. Press the LEFT/ RIGHT button and select the [MYCAM] menu tab.
3. Select the [S.SOUND] menu by pressing the UP/ DOWN button and press the RIGHT button.
4. Select a desired sub menu by pressing the UP/ DOWN button and press the OK button.
5. Press the menu button twice and the menu will disappear.



Important notes

Be sure to observe the following precautions!

- This unit contains precision electronic components. Do not use or store this unit in the following locations.
 - Areas exposed to severe changes in temperature and humidity.
 - Areas exposed to dust and dirt.
 - Areas exposed to direct sunlight or the inside of a vehicle in hot weather.
 - Environments where there is high magnetism or excessive vibration.
 - Areas with high explosives or highly flammable materials.

- Do not let the unit come into contact with dust, vinyl goods, or chemicals, such as insecticides, for an extended period of time.

- Sand can be particularly troublesome to cameras.
 - Do not let sand get inside the unit when using it on beaches, coastal dunes, or other areas where there is lots of sand.
 - Doing so may result in failure or may permanently render the unit unusable.

- Extremes in temperature may cause problems.
 - If the camera is transferred from a cold to a warm and humid environment, condensation can form on the delicate electronic circuitry. If this occurs, turn the camera off and wait for at least 1 hour until all moisture is dispersed. Moisture build up can also occur in the memory card. If this happens, turn off the camera and remove the memory card. Wait until the moisture has dispersed.

- Caution on Using the Lens
 - If the lens is subjected to direct sunlight, it could result in discoloration and deterioration of the image sensor.
 - Pay attention not to get fingerprints or foreign substances on the surface of the lens.

- If the digital camera is not used for a long period, an electric discharge can occur. It is a good idea to remove the batteries and the memory card if you do not intend using the camera for an extended period of time.

Important notes

- If the camera is exposed to an electronic interference, it will turn itself off to protect the memory card.

- Camera Maintenance
 - Use a soft brush (available from photo stores) to gently clean the lens and LCD assemblies. If this does not work, lens-cleaning paper with lens cleaning fluid can be used.
 - Clean the camera body with a soft cloth. Do not allow this camera to come into contact with solvent materials such as benzol, insecticide, thinners etc. This may damage the body shell of the camera and also affect its performance. Rough handling can damage the LCD monitor. Take care to avoid damage and keep the camera in its protective carry case at all times when not in use.

- Do not attempt to disassemble or modify the camera.

- Under certain conditions, static electricity can cause the flash unit to fire. This is not harmful to the camera and is not a malfunction.

- When images are uploaded or downloaded, the data transfer may be affected by static electricity. In this case, disconnect and re-connect the USB cable before trying the transfer again.

Warning indicator

There are several warnings that may appear on the LCD display

Warning indicator	Causes	Remedy
CARD ERROR !	<ul style="list-style-type: none">- Memory card error	<ul style="list-style-type: none">- Turn off the camera power and turn it on again- Insert the memory card again- Format the memory card (p.79)
CARD FULL !	<ul style="list-style-type: none">- There is insufficient memory capacity to take an image	<ul style="list-style-type: none">- Insert a new memory card- Delete unnecessary image files to free up some memory
NO IMAGE !	<ul style="list-style-type: none">- There are no images stored on the memory card	<ul style="list-style-type: none">- Take images- Insert a memory card that is holding some images
NO CARD !	<ul style="list-style-type: none">- A memory card is not inserted- The camera can't recognize the memory card	<ul style="list-style-type: none">- Insert a memory card- Insert the memory card again- Turn off the camera power and turn it on again
FILE ERROR !	<ul style="list-style-type: none">- File error- Memory card error	<ul style="list-style-type: none">- Format the memory card- Contact a camera service center
LOW BATTERY !	<ul style="list-style-type: none">- There is low battery capacity	<ul style="list-style-type: none">- Insert fresh batteries
CARD LOCKED !	<ul style="list-style-type: none">- The memory card is locked	<ul style="list-style-type: none">- Slide the write protect switch to the top of the memory card
LOW LIGHT !	<ul style="list-style-type: none">- When taking pictures in dark places	<ul style="list-style-type: none">- Use a tripod and take pictures in Flash Photography mode
SET USB	<ul style="list-style-type: none">- [USB] sub menu and connected device are not matched.	<ul style="list-style-type: none">- Reconfigure [USB] in the [SETUP] menu.

Before contacting a service center

Please check the following

Symptom	Causes	Remedy
The camera doesn't switch on	<ul style="list-style-type: none"> - There is low battery capacity - An AC Power Adapter is not connected - Batteries are inserted incorrectly with the reverse polarities 	<ul style="list-style-type: none"> - Insert fresh batteries - Connect an AC Power Adapter - Insert the batteries according to the polarity marks (+, -)
The camera power ceases whilst in use	<ul style="list-style-type: none"> - The batteries are exhausted - The Camera is turned off automatically - The Adapter plug is not connected securely 	<ul style="list-style-type: none"> - Insert fresh batteries - Press the power button to reactivate camera - Remove and re-insert the plug
Batteries drain quickly	<ul style="list-style-type: none"> - The Camera is being used in low temperatures 	<ul style="list-style-type: none"> - Keep the camera in warm conditions (i.e. inside a coat or jacket) and only remove it in order to take images
Camera does not take images when pressing the Shutter button	<ul style="list-style-type: none"> - There is insufficient memory capacity - The memory card has not been formatted - The memory card is exhausted - The camera's power is off - The batteries are exhausted - The memory card is locked - Batteries are inserted incorrectly with the reverse polarities 	<ul style="list-style-type: none"> - Delete unnecessary image files - Format the memory card (p.79) - Insert a new memory card - Turn the camera power on - Insert fresh batteries - Refer to [CARD LOCKED!] error message (p.89) - Insert the batteries according to the polarity marks (+, -)
The camera suddenly stops working while in use	<ul style="list-style-type: none"> - The camera was stopped due to a malfunction 	<ul style="list-style-type: none"> - Remove /re-insert batteries and switch the camera on

Before contacting a service center

Symptom	Causes	Remedy
The images are unclear	<ul style="list-style-type: none">- A picture was taken within 0.8 m from the subject without setting an appropriate macro mode- Taking a picture beyond the flash range- The lens is smudged or dirty	<ul style="list-style-type: none">- If the subject is closer than 0.8m, select macro shot mode- Take a picture within the flash range- Clean the lens
The flash does not fire	<ul style="list-style-type: none">- Flash off mode has been selected	<ul style="list-style-type: none">- Dis-engage flash off mode
Incorrect date and time is displayed	<ul style="list-style-type: none">- The date and time have been set incorrectly or the camera has adopted the default settings	<ul style="list-style-type: none">- Reset the date and time correctly
The camera buttons do not operate	<ul style="list-style-type: none">- Camera malfunction	<ul style="list-style-type: none">- Remove /re-insert batteries and switch the camera on
A card error has occurred while the memory card is in the camera.	<ul style="list-style-type: none">- Incorrect memory card format	<ul style="list-style-type: none">- Re-format the memory card (p.79)
The images don't play back	<ul style="list-style-type: none">- Incorrect file name (Violation of DCF format)	<ul style="list-style-type: none">- Do not change the image file name

Before contacting a service center

Symptom	Causes	Remedy
Colour of image is different to the original scene	<ul style="list-style-type: none"> - White balance setting is incorrect 	<ul style="list-style-type: none"> - Select appropriate White balance
Images are too bright	<ul style="list-style-type: none"> - Exposure is excessive 	<ul style="list-style-type: none"> - Reset exposure compensation
When using the PC's explorer, the [Removable Disk] file does not show	<ul style="list-style-type: none"> - Cable connection is incorrect - The camera is off - There are no batteries, the batteries are exhausted or the AC adapter is not connected. - The operating system is not Windows 98, 98SE, 2000, ME, XP/ Mac OS 9.0~10.2. Alternatively the PC does not support USB - The camera driver is not installed 	<ul style="list-style-type: none"> - Check the connection - Turn the camera on - Insert new batteries or check the adapter connection - Install Windows 98, 98SE, 2000, ME, XP/ Mac OS 9.0~10.2 to PC that supports USB - Install a [USB Storage Driver]

Specifications

Image Sensor	Type	1/1.8" CCD
	Effective Pixel	Approx. 6.0 Mega-pixel
	Total Pixel	Approx. 6.2 Mega-pixel
Lens	Focal Length	SHD Lens f = 7.7 ~ 23.1mm (35mm film equivalent : 38~114mm)
	F No.	F2.7 ~ F4.9
	Digital Zoom	Still Image mode : 1.1X ~ 4.0X Play mode : 1.0X ~ 5.0X (depends on image size)
Viewfinder	Optical Viewfinder	Real image optical viewfinder
	LCD Monitor	1.8" color TFT LCD
Focusing	Type	TTL auto focus
	Range	Normal : 80cm ~ infinity Macro : 4-80 cm(Wide), 25-80cm(Tele)
Shutter	Type	Mechanical and Electronic shutter
	Speed	15 ~ 1/2,000 sec
Exposure	Control	Program AE, Aperture priority AE, Shutter Speed priority AE, Manual AE, Metering: Multi, Spot
	Compensation	±2.0EV (0.5EV steps)
	ISO Equivalent	Auto, 100, 200, 400
	Manual	Shutter Speed : 15 ~ 1/2000 sec. selectable F No. : F2.7 ~ F4.9 selectable
Flash	Modes	Auto, Auto & Red-eye reduction, Fill-in flash, Slow sync, Flash off
	Range	0.25~3.0m(Wide), 0.25~2.0m(Tele)
	Recharging Time	About 6.0sec
Sharpness		Soft, Normal, Vivid
Effect		Normal, B&W, Sepia, RGB
White Balance		Auto, Daylight, Cloudy, Fluorescent_H, Fluorescent_L Tungsten, Custom
Voice Recording		Voice Recording (Max. 1hour) Voice Memo in Still Image (max. 10 sec.)
Date Imprinting		Date&Time, Date, Off (user selectable)
Shooting	Still Image	Modes : Program, Auto, Scene, AS priority, Manual, Voice Recording, Night Continuous : Single, Continuous, AEB Self-timer : 2 sec., 10 sec., Double self timer (10sec. & 2sec)
	Movie Clip	With audio (recording time : memory capacity dependent) Size : 640x480, 320x240, 160x120 Frame rate : 30 fps, 15 fps Pause Function in Movie Clip
Storage	Media	Internal : 32MB flash memory External Memory Slot : SD Card/MMC (Up to 512MB guaranteed)

Specifications

Storage	File Format	Still Image : JPEG (DCF), EXIF 2.2, DPOF 1.1, PictBridge 1.0 Movie Clip : AVI (MJPEG) Audio : WAV
	Image Size	2816 : 2816x2112 pixels, 2272 : 2272x1704 pixels, 2048 : 2048x1536 pixels, 1600 : 1600x1200 pixels, 1024 : 1024x768 pixels, 640 : 640x480 pixels
	Capacity (32MB)	2816: Superfine 8, Fine 16, Normal 25 2272: Superfine 13, Fine 26, Normal 39 2048: Superfine 16, Fine 32, Normal 48 1600: Superfine 26, Fine 52, Normal 78 1024: Superfine 64, Fine 127, Normal 191 640 : Superfine 162, Fine 322, Normal 488 * These figures are measured under Samsung's standard conditions and may vary depending on shooting conditions and camera settings.
Image Play	Type	Single image, Thumbnails, Slide show, Movie Clip
	Editing	Trimming, Rotating, Resizing
Interface		Digital output connector : USB 1.1 Audio : Mono DC power input connector : 3.3V
Power Source		Primary Batteries: 2 x AA alkaline, or CR-V3(Lithium) battery Secondary Batteries: 2 x Ni-MH(Samsung SNB-2312 recommended), Samsung SBP-1303(Lithium Ion) AC Adapter(optional): SAC-32 (DC 3.3V, 2A) * Included battery may vary depending on sales region.
Dimensions (WxHxD)		109.8 x 56.8x 34.1 mm
Weight		166g (without batteries and card)
Operating Temperature		0 ~40 °C
Operating Humidity		5 ~ 85%
Software	Camera Driver	Storage Driver (Windows98/98SE)
	Application	Arcsoft PhotoImpression, Digimax Viewer, Digimax Reader
Special Features		Power Movie Clip(Pause Function in Movie Clip & VGA 30fps), One touch Manual Function(A/S/M Button), 4cm Macro, Bright Pilot Lamp(Communication with user), Various Scene Modes, RGB Color Effect, Voice Recording, Samsung High Definition(SHD) Lens, Self Photo Mirror, Pictbridge Printing, 32MB Internal Memory

* Specifications are subject to change without prior notice.

* All trademarks are the property of their respective owners.

Software Notes

Please ensure that you read the instruction manual carefully before use.

- . The attached software is a camera driver and image editing software tool for Windows.
- . Under no circumstances should all or part of either the software or the user manual be reproduced.
- . Copyrights for software are licensed only for use with a camera.
- . In the unlikely event of a manufacturing fault, we will repair or exchange your camera. We cannot, however, be held responsible in any way for damage caused by inappropriate use.
- . Using a Hand-made PC or a PC and OS that has not been guaranteed by the manufacturer is not covered by the Samsung warranty.
- . Before reading this manual, you should have a basic knowledge of computers and O/S (Operating Systems).

System Requirements

For Windows	For Macintosh
PC with processor better than MMX Pentium 233MHz (XP : Pentium II 300MHz)	Power Mac G3 or later
Windows 98/98SE/2000/ME/XP	Mac OS 9.0 ~ 10.2
Minimum 32MB RAM (XP : 128MB) 140MB of available hard-disk space	Minimum 64MB RAM 110MB of available hard-disk space
USB port	USB port
CD-ROM drive	CD-ROM drive
800x600 pixels, 16-bit colour display compatible monitor (24-bit color display recommended)	QuickTime 6.01 or later for Movie Clip

About the software

After inserting the CD-ROM provided with this camera into the CD-ROM drive, the following window should automatically run.



Before connecting the camera to the PC, you should first install the camera driver.

※ Figures (Images) used for the manual are based on model Digimax A6.

- **Camera driver** : This enables images to transfer between the camera and PC.
This camera uses the USB Storage Driver as the camera driver. You can use the camera as a USB card reader. After installing the driver and connecting this camera to the PC, you can find [Removable Disk] in [Windows Explorer] or [My computer]. A USB Storage Driver is provided only for Windows. A USB Driver for MAC is not included with the Application CD. But you can use the camera with Mac OS 9.0 ~ 10.2.
- **Digimax Viewer** : This is a program for viewing stored images.
You can see the stored images in the memory directly on a PC monitor. You can also copy, move or delete the images and enlarge/downscale the image sizes with Digimax Viewer. This software is only compatible with Windows.
- **PhotoImpression** : Image editing program.
You can edit or store still images that you download from the camera. This software is only compatible with Windows.
- **Digimax Reader** : Text recognition program
You can save an image file that was captured in the TEXT mode as a text file with this program. This software is only compatible with Windows.

INFORMATION

- Be sure to check the system requirements (p.95) before installing the driver.
- You should allow 5~10 seconds for running the automatic setup program according to the capability of the computer. If the frame does not show, run the [Windows Explorer] and select [Samsung.exe] in the CD-ROM Drive root directory.

Setting up the application software

To use this camera with a PC, install the application software first. After this has been done, the stored images in the camera can be moved to the PC and can be edited by an image editing program.

INFORMATION

- Close other programs before installing the application software.
- Before installing the application software, disconnect the USB connection.

You can visit the Samsung web-site through the internet.

<http://www.samsungcamera.com> : English

<http://www.samsungcamera.co.kr> : Korean

1. Click the [Install] menu in the Autorun frame.
The camera driver is installed automatically.



2. Camera driver installation is complete.
Click the [Finish] button.



Setting up the application software

3. A window for which you can select application software will be displayed. Select the application program and click the [Install] button.

Refer to page 96 for more information about the application program.

[Click!]



INFORMATION

- If you select [Exit] at the step 3, the application program installation will be cancelled.

4. Install Digimax Viewer.
Click [Next >] button.

[Click!]



INFORMATION

- If you select [Cancel] at step 4, a window for installing PhotoImpression will be displayed.

5. The Software License Agreement window will be displayed. If you agree to this, click [Yes], the window will then move to the next step. If you disagree, click [No] and the installation program will be canceled.

[Click!]

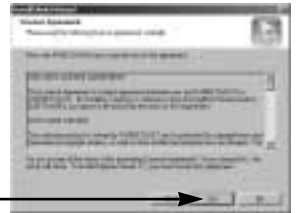

6. A destination selection window will open.
Click [Next >]. To copy the files to another folder, click [Browse...] and choose a folder you want.

[Click!]



Setting up the application software

7. A window will open, asking you to choose a folder to which program icons will be added. Click [Next >] button. If you want to add the program icons to a different folder, choose another folder, and then click [Next >] button.

[Click!]



8. Digimax Viewer installation is successfully completed. Click the [Finish] button to install Photolmpression. The system will not reboot even the [Yes, I want to restart the computer now] option is selected.

* The frame 8 may not appear according to the system requirements.

[Click!]



9. The Photolmpression installation window will be displayed as shown alongside. Click the [OK] button.

[Click!]

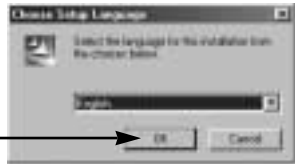

INFORMATION

- If you select [Cancel] at step 9, a window for installing Digimax Reader will be displayed.

10. A Welcome window will be displayed. Click the [Next >] button.

[Click!]



Setting up the application software

11. The Software License Agreement window will be displayed. If you agree to this, click [Yes], the window will then move to the next step. If you disagree, click [No] and the installation program will be canceled.

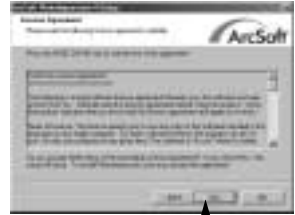

[Click!]

12. A destination selection window will open. Click [Next >]. To copy to the files to another folder, click [Browse...] and choose a folder you want.



[Click!]

13. The [Select Components] window will appear. Click [Next >] button.



[Click!]

14. A window will open, asking you to choose a folder to which program icons will be added. Click [Next >] button. If you want to add the program icons to a different folder, choose another folder, and then click [Next >] button.

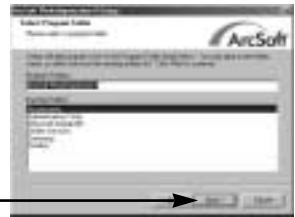

[Click!]

Setting up the application software

15. PhotoImpression installation is successfully completed. Click the [Finish] button to install Digimax Reader.

* The system will not reboot even the [Yes, I want to restart the computer now] option is selected.

* The frame 15 may not appear according to the system requirements.

[Click!]

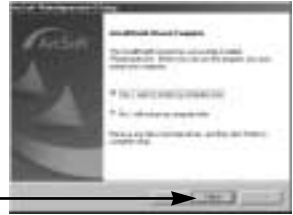

16. Digimax Reader installation window will be displayed as shown alongside.

17. A window will be displayed as shown alongside. Click the [INSTALL] button.

- Check the [MANUAL] button. Instructions for using Digimax reader will be displayed.
- Click the [EXIT] button and Digimax reader installation will be canceled and the Restart window will appear.

[Click!]



18. A window will open. Click the [Next(N)>] button.

[Click!]



Setting up the application software

19. The Software License Agreement window will be displayed. If you agree to this, click [Yes], the window will then move to the next step. If you disagree, click [No] and the installation program will be canceled.



20. A destination selection window will open. Click [Next >]. To copy to the files to another folder, click [Browse...] and choose a folder you want.



21. Installation is complete. To apply changes, you must restart the computer. Select [Yes, I want to restart my computer now], and then click [OK].



* The frame 21 may be displayed according to the system requirements. Click the [Finish] button to restart the computer.

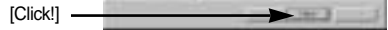

Setting up the application software

22. After restarting the computer, connect the PC to the camera with the USB cable.

23. Turn the camera power on. [Found New Hardware Wizard] will open and the computer will recognize the camera.

* If you have ever installed an image viewer program or your OS is Windows XP, an image viewer program will open. If the image viewer program opens, the camera driver was setup successfully.



24. If you can see [Removable Disk] under [My computer], the camera driver installation was successful. Now you can transfer image files from the camera to PC via the USB cable.



Setting up the application software

INFORMATION

- If you have installed the camera driver, [Found New Hardware Wizard] may not open.
- On a Windows 98 or 98 SE system, the Found New Hardware Wizard dialog box opens and a window asking you to select a driver file may appear. In this case, specify "USB Driver" in the CD supplied.
- When connecting the camera to your PC, it is recommended that you use an AC power adapter.
- Before connecting the camera to the PC, You should first install the camera driver.
- After installing the camera driver, you have to restart your PC.
- If you connect the camera to the PC before installing the camera driver, the [Found New Hardware Wizard] will open.
In this case, cancel the [Found New Hardware Wizard] and disconnect the camera. Install the camera driver and connect the camera to the PC again.
- Should the computer not find the camera driver after installation, please try one or more of the following measures.
 1. Delete the camera driver (p.108), and re-install the driver.
 2. Refer to FAQ (p.116) to check for a possible solution to the problem.
 3. If your PC's central processing unit is VIA chip (This is shown in the USB Host Controller), download the patch file from the Samsung Camera web page.
(<http://www.samsungcamera.com>)

Starting PC Mode

- If you connect the USB cable to a USB port on your PC and then turn on the power, the camera will automatically switch to "computer connection mode".
- In this mode, you can download stored images to your PC through the USB cable.
- The LCD monitor is always turned off in PC mode.
- The auto focus lamp will blink when the files are transferring via the USB connection.

■ Connecting the camera to a PC

1. Turn the PC power on.
2. Turn the camera power on.
3. In any mode other than Voice Recording mode, press the MENU button.
4. Press the LEFT/ RIGHT button and select the [SETUP] menu tab.
5. Select the [USB] menu by pressing the UP/ DOWN button and press the RIGHT button.
6. Use the UP and DOWN buttons to select [COMPUTER], and then press the OK button.
7. Press the menu button twice and the menu will disappear.
8. Connect the PC and the camera via the USB cable.
 - Insert the small plug of the USB cable into the camera USB connection terminal.
 - Insert the large connector of the USB cable into the USB port of the PC.
 - The plugs must be firmly inserted.



- ※ If you selected [PRINTER] in Step 6, when you connect the camera to your computer, the [CONNECTING...USB I/F : PRINTER] message will be displayed on the LCD monitor and the connection will not be established. In this case, disconnect the USB cable, and then follow the procedure from Step 3 and onward.

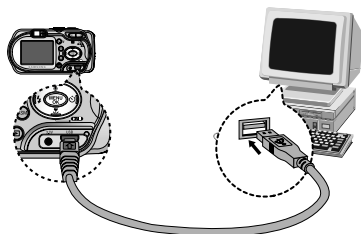

- Disconnecting the camera and PC : Refer to page 110 (Removing the removable disk).

INFORMATION

- The camera driver must be installed before using PC mode.
- To save battery power, it is recommended that you use an AC adapter (Optional) when connecting the camera to a computer.

Starting PC Mode

■ Downloading stored images

You can download the still images stored on the camera to your PC's hard disk and print them or use a photo editing software to edit them.

1. Connect the camera to your PC with the USB cable.

2. On your computer's desktop display, select [My computer] and double click [Removable Disk] → DCIM → 100SSCAM].

The image files will then be displayed.



3. Select an image and press the right mouse button.



4. A pop-up menu will open.

Click [Cut] or [Copy] menu.

- [Cut] : cuts a selected file.

- [Copy] : copies files.



5. Click a folder where you want to paste the file.

Starting PC Mode

6. Press the right mouse button and a pop-up menu will open. Click [Paste].



7. An image file is transferred from the camera to your PC.



- By using [Digimax Viewer], you can see the stored images in the memory directly on the PC monitor and you can copy or move the image files.

Removing the USB Driver for Windows 98SE

■ To remove the USB driver, refer to the process shown below.

1. Trace [Start → Settings] and click [Control Panel].



2. Double-click [Add/Remove programs].

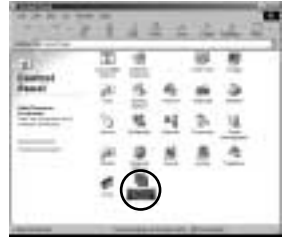

3. The [Add/Remove Programs Properties] window will open. Click [Digimax A6] and click the [Add/Remove] button.

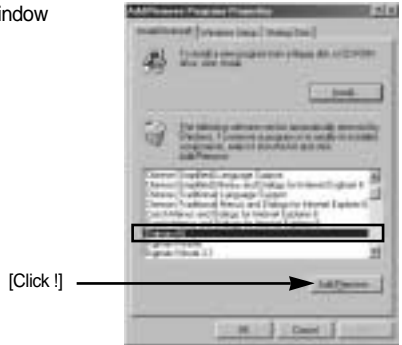

4. Uninstallation is complete.

Click the [Finish] button and the window will disappear.



Removable Disk

■ To use this camera as a Removable Disk, install (p.97) the USB Driver.

1. Before turning the camera power on, connect the camera to the PC with the USB cable.
2. Click [Removable Disk] under [My computer] or [Windows Explorer].
3. Image files stored in the Removable Disk (DCIM →100SSCAM) can be transferred to the PC.

INFORMATION

Important information whilst using the Removable Disk

- The [Removable Disk] indicator will not show when the camera power is off or the USB cable is removed.
- We recommend that you should copy the images to the PC to view them. Opening images directly from the removable disk may be subject to unexpected disconnection.
- When uploading images from the PC to the camera, ensure that the uploaded file names are not the same as those already stored on the memory.
- When you upload a file that is not taken by this camera to Removable Disk, the [FILE ERROR!] message will be displayed on the LCD monitor in the PLAY mode, and nothing is displayed in THUMBNAIL mode.
- The auto focus lamp will blink, when a file is transferred (copy or deletion) between the PC and the camera. Do not remove the USB cable until the lamp stops blinking. To remove the USB cable in Windows 2000/ME/XP, use the [Unplug or Eject Hardware] icon on the task bar.

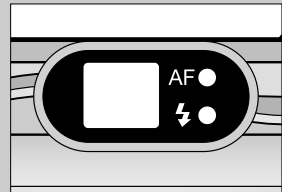

Removing the removable disk

■ Windows 98SE

1. Check whether the camera and PC are transferring a file. If the auto focus lamp blinks, you have to wait until the lamp is turned off.
2. Unplug the USB cable.

■ Windows 2000/ME/XP

(The illustrations may be different from the real display in accordance with the Windows O/S.)

1. Check whether the camera and PC are transferring a file. If the auto focus lamp blinks, you have to wait until the lamp is turned off.

2. Double-click the [Unplug or Eject Hardware] icon on the task bar.



[Double-click!]

3. The [Unplug or Eject Hardware] window will open. Select the [USB Mass Storage Device] and click the [Stop] button.



4. The [Stop a Hardware device] window will open. Select the [USB Mass Storage Device] and click the [OK] button.

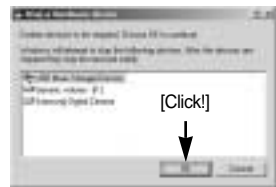

5. A [Safe to Remove Hardware] window will open. Click the [OK] button.



[Click!]

Removing the removable disk

6. A [Unplug or Eject Hardware] window will open.
Click the [Close] button and the removable disk will be removed safely.



7. Unplug the USB cable.

[Click!]

Setting up the USB Driver for MAC

1. A USB Driver for MAC is not included with the software CD as MAC OS supports the camera driver.
2. Check the MAC OS. You can check the MAC OS version during MAC OS start-up.
This camera is compatible with MAC OS 9.0 ~ 10.2.
3. Connect the camera to the Macintosh and turn the camera power on.
4. A new icon will be displayed on the desktop after connecting the camera to the MAC.

Using the USB Driver for MAC

1. Double click a new icon on the desktop and the folder in the memory will be displayed.
2. Select an image file and copy or move it to MAC.

INFORMATION

- For Mac OS 10.0 or later: First complete uploading from computer to camera and then remove the removable disk with the Extract command

Digimax Viewer 2.1

■ This software is only compatible with Windows.

1. To open Digimax Viewer, click the [Start → Programs → Samsung → Digimax Viewer 2.1 → Digimax Viewer 2.1] and Digimax Viewer 2.1 will then open.



2. If the [Auto Launch] option is selected, this program will be executed automatically with recognizing the camera.



3. You can easily use the Digimax viewer 2.1 program as it offers a FILE menu and TOOL bar. And, you can use the pop up menu. Click an image and press the right mouse button.



Digimax Viewer functions are listed below.

- Basic functions : Copy, Move, Delete, Rotate, Rename, changing file type, Resize, Property.
- Advanced functions : Print, Slide show, Export, Sending e-mail, On-line print, Web album etc.

INFORMATION

- Before deleting images from the camera, you should protect or download images to your computer that you wish to keep.
- Refer to the [Help] menu in Digimax viewer 2.1 for further information.

Using Photolmpression





With Photolmpression, you can edit or store still images that you downloaded from the camera. This software is only available in Windows version.

To start the program, click [Start → Programs → ArcSoft Photolmpression → Photolmpression]. The following screen will appear.













You can use Photolmpression to perform the following tasks.

■ Command Button

Button	Description
	Imports a picture from an album, a source folder, or the camera/scanner, or captures screen shots of what is being viewed on the current monitor.
	Selects Cut, Resize, Edit Image, Insert Text, Enhance Picture, Insert Effects, or Layer.
	Performs Insert Frame, Insert Borders, Insert Calendar, Insert Greeting Cards, Insert Template, or Connect with Other Software.
	Saves the edited picture, and sends an e-mail or uses it as the background image.
	Outputs the edited picture according to your preferences.

Using Photolmpression

■ Tool Bar

Button	Description	Button	Description
	Resize Layer		Rotate Layer
	Flip Layer Horizontally		Rotate All Layers
	Undo		Redo
	Copy		Paste
	Delete Layer		Close Picture

INFORMATION

- For detailed instructions on how to use Photolmpression, please refer to the program's Help.

Digimax Reader

- Digimax Reader is a Text recognition program. You can save an image file that is captured in the Text mode, as a text file with this program.
This software is only compatible with Windows.
- To start the program, click [Start → Programs → Digimax Reader]. The following screen will appear.



Digimax Reader

■ How to use the Digimax Reader

1. Connect the camera and the PC with a USB cable and download the images that were stored in the camera to the PC.

* Please see page 105~107 for details on Connecting a camera and PC, Downloading images.

2. Run the Digimax Reader.

3. Click the Open() icon as shown alongside.



4. Select the image you want to save as a text file.

* Only an image that was taken with SAMSUNG camera can be opened.

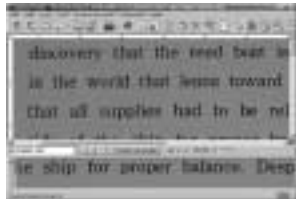

5. Click the Area Analysis() icon to scan the image.

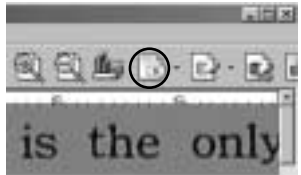

6. Part of the image you selected will be displayed as shown.

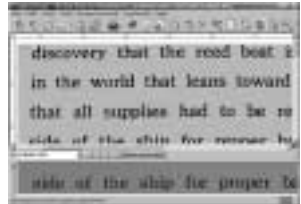

7. Click the Character Recognition() icon.

The part selected in the previous step will be recognized as text.

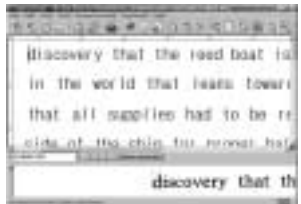

Digimax Reader

8. To save the section as a text, click the Save() icon. A window as shown alongside will be displayed.



9. Select a file type that you want to. Selectable file type : *.TXT, *.HWP, *.DOC, *.RTF

INFORMATION

- To get an image that can be recognized as a text :
 - Keep a distance of 20cm between the subject and the camera.
 - The subject need to be centered.
 - Avoid the camera shake to get a good image.
- Refer to the [Help] menu in Digimax Reader for further information.

FAQ

- Please check the following if the USB connection malfunctions.

[Case 1] The camera power is off.
→ Turn the camera power on. We recommend using an AC power adapter in PC mode.

[Case 2] USB Driver is not installed correctly.
→ Install the USB Driver correctly. Refer to page 97.

[Case 3] The USB cable is not connected or you are using a cable with an incorrect specification.
→ Use a USB cable with the correct specification.

FAQ

[Case 4]

The camera is not recognized by your PC.
Sometimes, the camera may appear under [Unknown Devices] in Device Manager.

- Install the camera driver correctly.
Turn off the camera, remove the USB cable, plug in the USB cable again, and then turn on the camera.

[Case 5]

There is an unexpected error during file transfer

- Turn the camera power off and on again. Transfer the file again.

[Case 6]

How do I know my computer supports a USB Interface?

- Check the USB port in your computer or keyboard.
- Check the OS version. A USB Interface is available in Windows 98, 98SE, 2000, ME .XP.
- Check [Universal Serial Bus controllers] in Device Manager. Do the following to check [Universal Serial Bus controllers].

Win 98/ME : Trace [Start → Settings → Control Panel → System → Device Manager → Universal Serial Bus controllers].

Win 2000 : Trace [Start → Settings → Control Panel → System → Hardware → Device Manager → Universal Serial Bus controllers].

Win XP : Trace [Start → Control Panel → System → Hardware → Device Manager → Universal Serial Bus controllers].

There must be USB Host Controller and USB root hub under [Universal Serial Bus controllers].

In addition, double-click on the USB Universal Host Controller and the USB Root Hub to check if the Device Status states "This device is working properly". If the Device Status says the device is "not working properly", click the "Driver" tab and then click [Update Driver] or [Reinstall Driver].

- When all the conditions mentioned above are met, the computer can support the USB interface.

[Case 7]

When using the USB hub.

- There may be a problem in connecting the camera to the PC through the USB hub if the PC and the hub are not compatible.
Wherever possible, connect the camera to the PC directly.

[Case 8]

Are other USB cables connected to the PC?

- The camera may malfunction when it is connected to the PC at the same time as another USB cable. In this case, disconnect the other USB cable, and connect only one USB cable to the camera.

FAQ

[Case 9]

When I open the Device Manager (by clicking Start → (Settings) → Control Panel → (Performance and Maintenance) → System → (Hardware) → Device Manager), there are 「Unknown Devices」 or 「Other Devices」 entries with a yellow question mark(?) beside them or devices with an exclamation mark(!) beside them.

- Right-click on the entry with the question(?) or exclamation (!) mark and select "Remove". Restart the PC and connect the camera the again.
For Windows 98 PC, remove the camera driver also, restart the PC, and then reinstall the camera driver.
- Double-click on the entry with the question (?) or exclamation (!) mark, click the "Driver" tab, and click [Update Driver] or [Reinstall Driver]. If a message appears asking you to specify the location of the appropriate device driver, specify "USB Driver" in the CD supplied.

■ Please check the following if the movie clip doesn't play back.

※ If you installed an incorrect codec onto your PC, the movie clip may not play back on the PC.

1. Check whether the JPEG Decoder provided with the camera is installed.

→ If you didn't install the camera driver, please install the JPEGCODE included in the application S/W CD-ROM. If not, the movie clip may not play back on the PC.

[Installing the JPEG Decoder]

- 1) Insert the CD provided with the camera.
- 2) Run the windows explorer and select the CD-ROM drive.
- 3) Select the JPEG_Decoder folder and double click the Setup.exe file.

The codec will be installed.

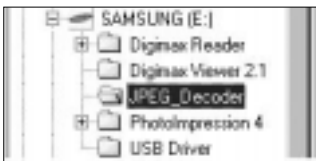

FAQ

2. Compatible problems with the codecs installed onto the PC.

→ If the movie clip doesn't play back after installing the JPEG Decoder, refer to the following.

1) When the movie clip plays back, only the sound plays back without the image.

It isn't compatible with the Mogen MJPEG Decoder. Uninstall the Mogen MJPEG Decoder as following order. Click [Start → Run] and a window will open.

Type "regsrv32 /u m3jpgdec.ax" and press the Enter key.

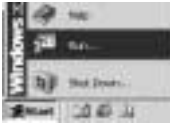

2) When the movie clip plays back, the blue and red colors are reversed or the movie clip doesn't open. It isn't compatible with the ffdshow Codec or K-lite Codec Pack.

① Disable the ffdshow program.

Trace [Start → Programs → ffdshow

→ Disable ffdshow].



② Uninstall the K-Lite Codec Pack or set the default program of the AVI file as the Windows Media Player.

Trace [Start → Control Panel → Add/ Remove Programs → Select the K-Lite Codec Pack → Click the Change/ Remove button].



Run the windows explorer → Select AVI file → Click the right mouse button → Select the "Open with" menu → Click the Windows Media Player → Check the "Always use this program to open these files" option → Click the [OK] button.



Most problems will be solved with those remedies. If the movie clip doesn't play back continuously, install the JPEGCODE provided with the camera again.

※ For more information, visit the samsung website(www.samsungcamera.com) and see the FAQ page.



SAMSUNG

SAMSUNG TECHWIN CO., LTD.
OPTICS & DIGITAL IMAGING DIVISION
145-3, SANGDAEWON 1-DONG, JUNGWONGU,
SUNGNAM-CITY, KYUNGKI-DO, KOREA
462-121
TEL : (82) 31-740-8086,8088, 8090, 8092, 8099
FAX : (82) 31-740-8398, 8111

SAMSUNG OPTO-ELECTRONICS AMERICA, INC.
HEADQUARTERS
40 SEAVIEW DRIVE, SECAUCUS, NJ07094, U.S.A.
TEL : (1) 201-902-0347
FAX : (1) 201-902-9342

WESTERN REGIONAL OFFICE
18600 BROADWICK ST.,
RANCHO DOMINGUEZ, CA 90220, U.S.A.
TEL : (1) 310-900-5263/5264
FAX : (1) 310-537-1566

SAMSUNG OPTO-ELECTRONICS UK LIMITED
SAMSUNG HOUSE
1000 HILLSWOOD DRIVE
HILLSWOOD BUSINESS PARK
CHERTSEY KT16 OPS U.K.
TEL : 00800 12263727
FAX : 002711 4619110

SAMSUNG OPTO-ELECTRONICS GMBH
AM KRONBERGER HANG 6
D-65824 SCHWALBACH/TS., GERMANY
TEL : (49) 6196 66 53 03
FAX : (49) 6196 66 53 66

SAMSUNG FRANCE S.A.S.
BP 51 TOUR MAINE MONTPARNASSE
33, AV. DU MAINE
75755, PARIS CEDEX 15, FRANCE
HOTLINE PHOTO NUMÉRIQUE :
00 800 22 26 37 27 (Numéro Vert-Appel Gratuit)
TEL : (33) 1-4279-2282/4
FAX : (33) 1-4320-4510

SAMSUNG TECHWIN MOSCOW OFFICE
RUSSIA, 125167, MOSCOW LENNINGRADSKY,
PR-KT, 37-A, KORP14
TEL : (7) 095-258-9299/96/98
FAX : (7) 095-258-9297
<http://www.samsungcamera.ru>

TIANJIN SAMSUNG OPTO-ELECTRONICS CO.,LTD.
7 PINGCHANG ROAD NANKAI DIST., TIANJIN
P.R CHINA
POST CODE:300190
TEL : (86) 22-2761-8867
FAX : (86) 22-2761-8864

* Internet address - <http://www.samsungcamera.com/>



The CE Mark is a Directive conformity
mark of the European Community (EC)

6806-2249

Free Manuals Download Website

<http://myh66.com>

<http://usermanuals.us>

<http://www.somanuals.com>

<http://www.4manuals.cc>

<http://www.manual-lib.com>

<http://www.404manual.com>

<http://www.luxmanual.com>

<http://aubethermostatmanual.com>

Golf course search by state

<http://golfingnear.com>

Email search by domain

<http://emailbydomain.com>

Auto manuals search

<http://auto.somanuals.com>

TV manuals search

<http://tv.somanuals.com>