

SAMSUNG

SAMSUNG CAMERA

User Manual

Digital Camera

Digimax 201

Thank you for buying a Samsung Camera. This manual will guide you through using the Digimax 201, including taking images, downloading images and using the MGI PhotoSuite III SE software.

Please read this manual before using your new camera.

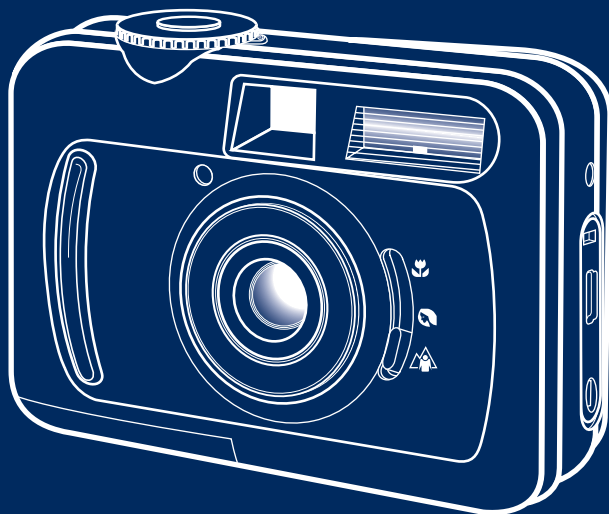

ENGLISH



INSTRUCTIONS

- Use this camera in the following order

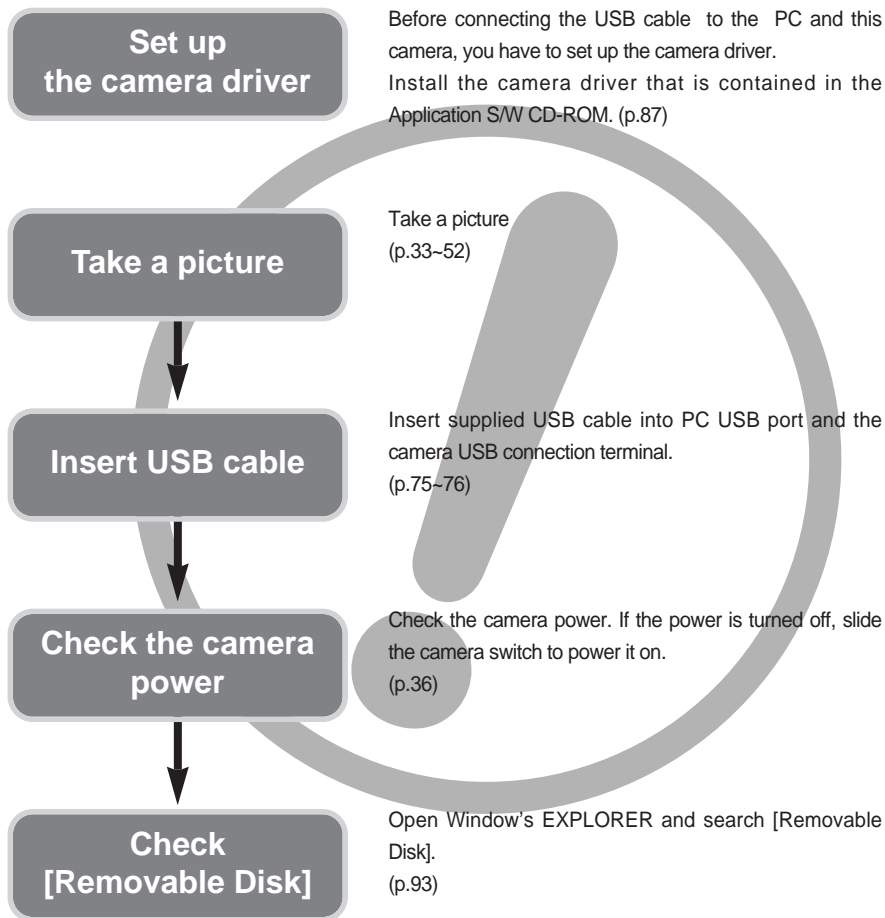



SPECIAL FEATURES

This digital camera has the following features.

- A fine resolution of 2.0 mega pixels
- 2 X digital zoom lens
- Movie clip recording function
- Date imprinting on a still image
- Multiple language support

An FCC warning

- This device has been tested in accordance with the limits of a class B digital device under item 15 of the FCC rules. These limits are designed to provide protection against harmful interference in commercial installation. This equipment generates, absorbs and can emit radio frequency energy. If it is not installed and used in accordance with the instructions, it may cause harmful interference to radio communication. There is however, no guarantee that interference will not occur in a some situations. Should any interference occur when this device is in operation, please try one or more of the following measures.
 - Change the location and direction of any aerial.
 - Increase distance between camera and affected device.
 - Use a different socket away from the affected device.
 - Please contact a Samsung agent or a radio/TV engineer.
- This device complies with part 15 of the FCC Rules.



CONTENTS

Ready

- Getting to know your camera 6
- Safety note 7
- This digital camera can be used for 10
- Manufacturer' s contents 12
- Identification of features 13
 - Product Exterior (Front / Top / Bottom) ... 13
 - Product Exterior (Back) 14
 - Camera status LED 15
 - LCD monitor indicator 17
 - Camera mode definition 19
 - STILL IMAGE mode 19
 - PLAY mode 19
 - MOVIE CLIP mode 19
 - SETUP mode 19
 - LCD monitor menu indicator 21
- Preparation 25
 - Connecting to Power 25
 - Using the batteries 25
 - Battery condition indicator 25
 - Using the AC power adapter 27
 - Attaching the strap 27
 - Inserting the SD memory card 28
 - Removing the SD memory card 30
 - Instructions on how to use the SD memory card 30

Advanced

- Recording mode 33
 - Starting Recording Mode 33
 - Recording a still image 33
 - Recording a Movie clip 34
 - Using the camera button to adjust the camera 36
 - POWER switch 36
 - SHUTTER button 36
 - LCD button 36
 - MENU button 37
 - Focus switch 38
 - 4-function button 39
 - SET/ RIGHT button 40
 - THUMBNAIL/ LEFT button 41
 - SELF-TIMER / UP button 41
 - FLASH / DOWN button 42
 - Using the LCD monitor to adjust the camera 45
 - IMAGE SIZE 46
 - IMAGE QUALITY 47
 - WHITE BALANCE 49
 - EV COMPENSATION 50
 - Movie clip recording time 52
- Play mode 53
 - Starting the Play Mode 53
 - Playing back a still image 53
 - Playing back a movie clip 54
 - Setting up the play back function by using the camera button 56
 - Power switch 56
 - LCD button 56

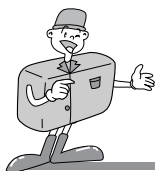

CONTENTS

Advanced

- MENU button 57
- 4-function button 57
- THUMBNAIL / LEFT button 58
- SET / RIGHT button 59
- UP button 60
- DOWN button 60
- Setting up the play back function using the LCD monitor 61
 - Image deletion 61
 - Slide show 64
 - Protect 65
 - # of prints 66
- SETUP mode 67
 - Starting the SETUP mode 67
 - Beep 67
 - POWER OFF 68
 - DATE IMPRINT 69
 - DATE TYPE 70
 - DATE SETUP 71
 - QUICK VIEW 72
 - LANGUAGE 73
 - RESET 74
- PC mode 75
 - Starting the PC mode 75
- Important notes 77
 - Caution! 77
 - Warning indicator 79
- Before contacting a service center 80
 - Please check the following 80
- Specifications 82

Software

- Software manual 84
 - Software Notes 84
 - About software 85
 - Setting up the USB driver for
 - Windows 98SE 87
 - Setting up DirectX 8.1 88
 - Removing the USB Driver for Windows ... 91
 - Removable Disk 93
 - Removing the removable disk 94
 - Windows 98SE 94
 - Windows 2000/ME/XP 94
 - Setting up the USB Driver for MAC 96
 - Using the USB Driver for MAC 96
 - Setting up Digimax Viewer 97
 - Digimax Viewer 99
 - Setting up MGI PhotoSuite III SE 100
 - MGI PhotoSuite III SE 103
 - MGI PhotoSuite III SE functions 104
 - Using MGI PhotoSuite III SE 106
 - GET 106
 - PREPARE 110
 - COMPOSE 111
 - ORGANIZE 112
 - SHARE 116
 - PRINT 117
- FAQ 118

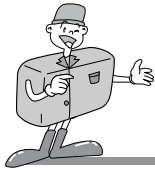

GETTING TO KNOW YOUR CAMERA

Thank you for buying a Samsung Digital Camera.

- Prior to using this camera, please read the user manual thoroughly.
- Keep the manual in a safe place.

About the symbols

This manual contains instructions on using this camera that will help you to use this camera safely and correctly.

This will help prevent danger and injury to others.



DANGER

DANGER

DANGER indicates an imminently hazardous situation which, if not avoided, will result in death or serious injury.



WARNING

WARNING

WARNING indicates a potentially hazardous situation, which, if not avoided, could result in death or serious injury.



CAUTION

CAUTION

CAUTION indicates a potentially hazardous situation, which, if not avoided, may result in a minor or moderate injury.



NOTICE

NOTICE indicates a factor, which, if not avoided, may result in camera malfunction or poor image quality.



INFORMATION

INFORMATION indicates a factor, which should assist further in the operation of the camera.



SAFETY NOTE



DANGER

- Do not attempt to modify this camera in any way. This may result in fire, injury, electric shock or severe damage to you or your camera. Internal inspection, maintenance and repairs should be carried out by your dealer or Samsung Camera Service Center.
- Please do not use this product in close proximity to flammable or explosive gases, as this could increase the risk of explosion.

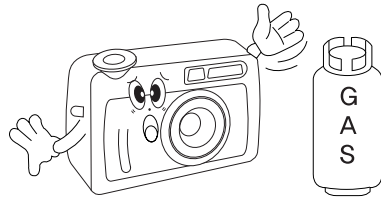
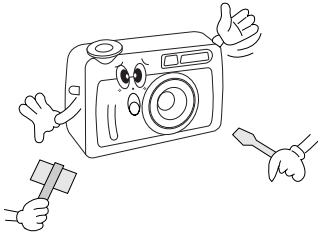

- Should any form of liquid or a foreign object enter the camera, do not use it. Switch off the camera, and then disconnect the power source (batteries or AC Power Adapter). You must contact your dealer or Samsung Camera Service Center. Do not continue to use the camera as this may cause a fire or electric shock.
- Do not insert or drop metallic or inflammable foreign objects into the camera through access points e.g. CARD slot and battery chamber. This may cause a fire or electric shock.
- Do not operate this camera with wet hands. This could pose a risk of electric shock.

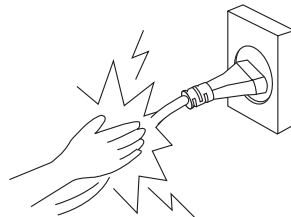



SAFETY NOTE



WARNING

- Do not use the flash in close proximity to people or animals. Positioning the flash too close to your subject's eyes, may cause eyesight damage. Do not attempt to photograph children using a flash closer than a meter in proximity.
- When taking photographs, never point the lens of the camera directly into very strong light. This may result in permanent damage to the camera or your eyesight.

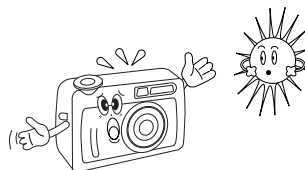
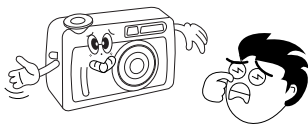

- For safety reasons keep this product and accessories out of reach of children or animals to prevent accidents e.g.:
 - Swallowing batteries or small camera accessories. In case of accidents, please consult a doctor immediately.
 - There is a risk of permanent eye damage if the flash is operated at a distance of less than one meter from a person's eyes.
 - There is a possibility of injury from the camera's moving parts.
- Do not leave this camera in places subject to extremely high temperatures, such as a sealed vehicle, direct sunlight or other places of extreme variances in temperature. Exposure to extreme temperatures may adversely affect the camera's internal components and could cause a fire.
- When in use, do not cover the camera or AC Power Adapter. This may cause heat to build up and distort the camera body or cause a fire. Always use the camera and its accessories in a well-ventilated area.

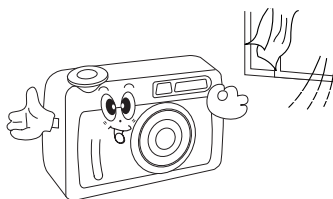



SAFETY NOTE



CAUTION

- Leaking, overheating, or burst batteries could result in fire or injury.
 - Use batteries with the correct specification for the camera.
 - Do not short circuit, heat or dispose of batteries in fire.
 - Do not use old batteries with new ones, or mix brands of batteries.
 - Ensure the batteries are positioned correctly with regard to polarity (+ / -).
- When the camera is not in use for long periods, always unplug the camera from its power source.
- Do not fire the flash while it is in contact with hands or objects. Do not touch the flash after using it continuously. It may cause burns.
- Do not move the camera while it is switched on, if you are using the AC Power Adapter. After use, always switch off the camera before unplugging the adapter from the AC Power wall socket. Then make sure that any connector cords or cables to other devices are disconnected before moving the camera. Failure to do so may damage the cords or cables and cause a fire or electric shock.

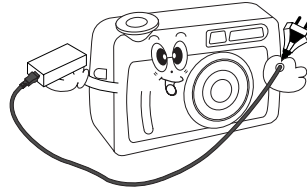



THIS DIGITAL CAMERA CAN BE USED FOR

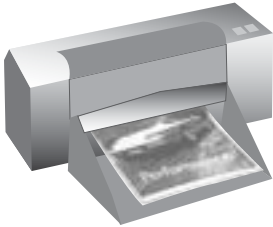

Printing images using a dedicated printer, DPOF-compatible printer or DPOF-equipped photo lab . (p.66)



Taking a picture. (p.33-52)



Down loading image files from camera to computer. (p.75-76)



Editing images on a PC (p.103-117)



THIS DIGITAL CAMERA CAN BE USED FOR

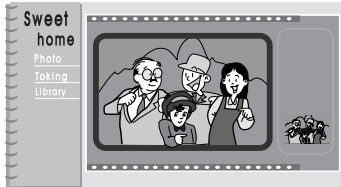

Creation of a digital photo album



Inserting images directly into any electronic document

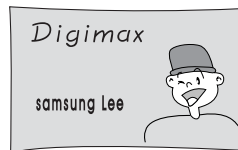

Taking a self-portrait and using the image to personalize name cards

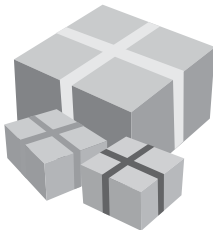

You can even create your own unique gift-wrap paper by using your digital images



MANUFACTURER'S CONTENTS

Manufacturer's contents

Please check that you have the correct contents before using this product.

Digital camera



2 AA Alkaline
Batteries



Pouch



USB cable



Camera strap



Applications S/W-
Driver CD-ROM



User manual



Product warranty



Accessories (optional)

AC Adapter



SD memory card





IDENTIFICATION OF FEATURES

READY

Product Exterior(Front / Top / Bottom)

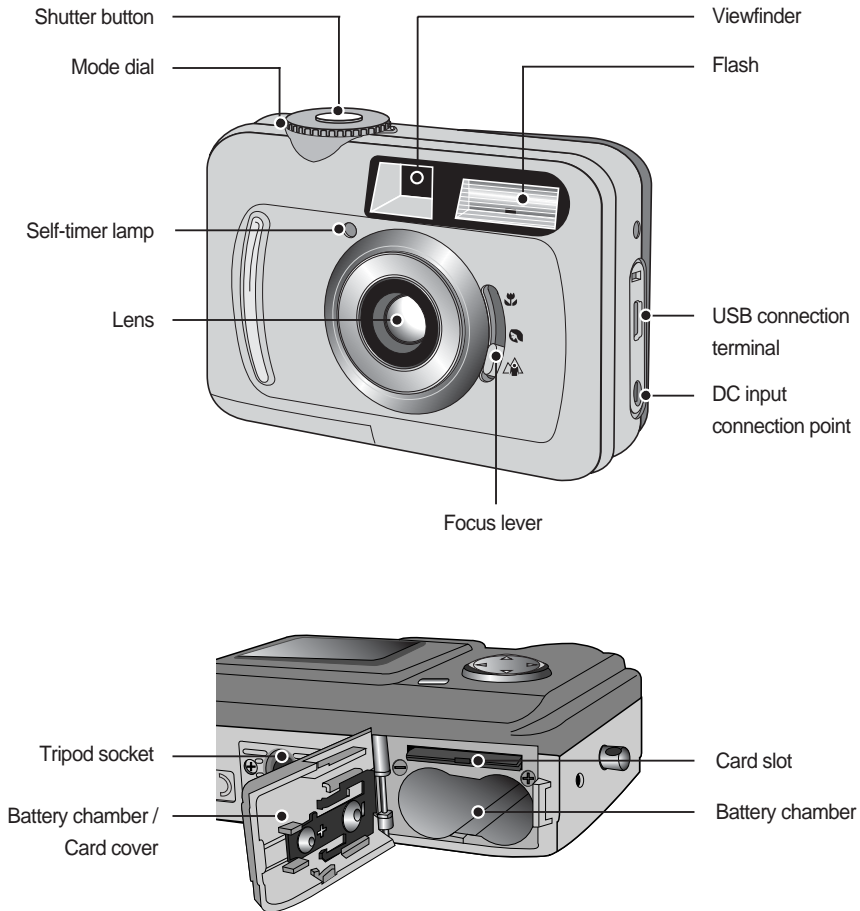



IDENTIFICATION OF FEATURES

Product Exterior (Back)

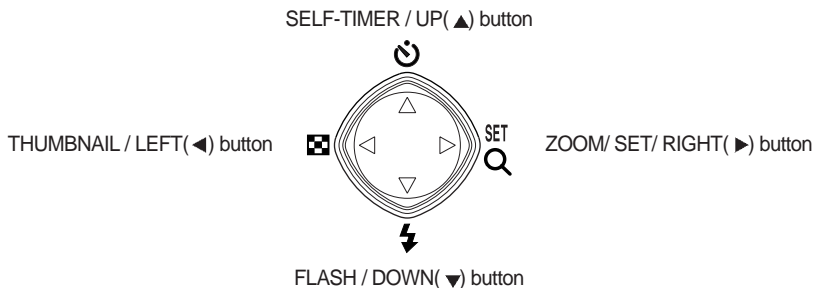
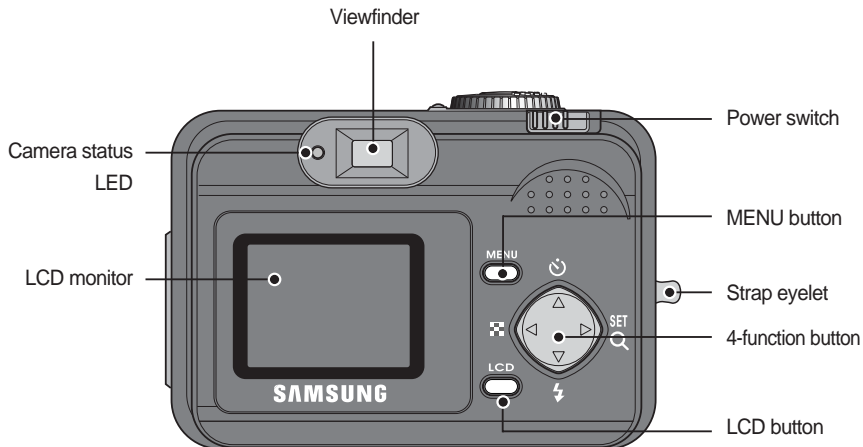

【 4-function button 】



IDENTIFICATION OF FEATURES

Camera status LED

Camera status LED

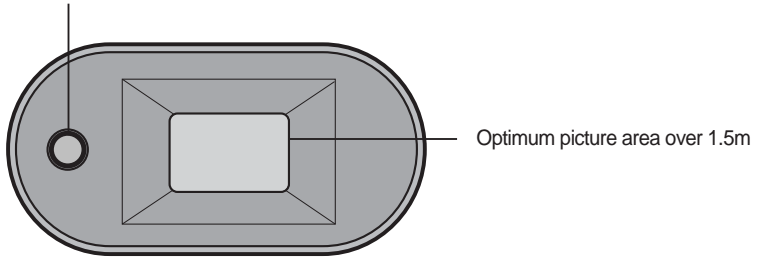

■ Camera status LED

Color	Status	Camera condition
Green	Blinking and off	Power on processing
	On	When the LCD monitor is turned off When the USB cable is connected
	Blinking slowly	Flash charge processing
	Blinking fast	Image processing(compression/decompression) USB busy



IDENTIFICATION OF FEATURES



Information

■ Self-timer lamp

Color	Status	Camera condition
Red	Blinking	For the first seven seconds, the LED blinks at 1 second intervals. For the final three seconds, the LED blinks quickly at 0.5-second intervals.
	Blinking 1 time	When the camera power is on / when the shutter button is released from pressing.

■ Beep

Beep sound	Camera condition
Power beep	When the camera power is turned on/off.
Normal beep (a short beep)	Rotating the mode dial/ pressing the shutter button/ pressing the camera buttons
Error beep (long beep twice and short beep twice)	When an error occurs
Self-timer beep	A beep will sound when the self-timer lamp blinks

- To hear the beep sound, you have to set the beep sound to on in the setup mode menu.



IDENTIFICATION OF FEATURES







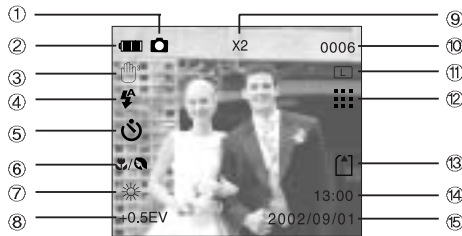













LCD monitor indicator

The LCD monitor displays information about the shooting conditions.

■ Recording mode



[Image & Full Status]

No.	Description	Icons	Page
1	Recording mode	 	p.33 / 34
2	Battery	  	p.25
3	Camera shake warning		p.35 / 43
4	Flash	    	p.43 / 44
5	Self-timer		p.41
6	Focus mode	 	p.38
7	White balance	AUTO    	p.50
8	Exposure compensation	+0.5 EV	p.50
9	Digital zoom	X2	p.40
10	Number of available shots remaining (Still image)	0006	
	Available recording time (Movie clip)	00:10	
11	Image size	  	p.46



IDENTIFICATION OF FEATURES

No.	Description	Icons	Page
12	Quality		p.47
13	SD memory card indicator		p.28
14	Time	13:00	
15	Date	2002/09/01	

■ Play mode

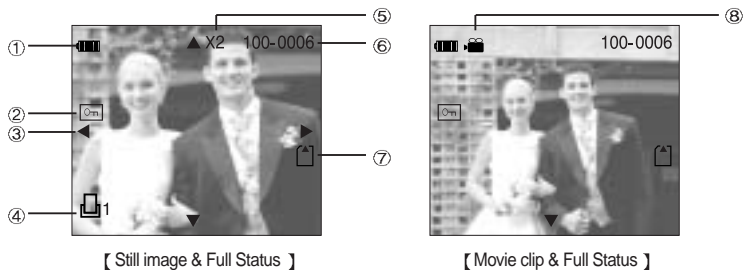

No.	Description	Icons	Page
1	Battery		p.25
2	Protect		p.65
3	4-Direction icons		p.40
4	Print set indicator		p.66
5	Digital zoom	X2	p.40
6	Stored image number	100-0006	
7	SD memory card indicator		p.28
8	Movie clip indicator		p.34



IDENTIFICATION OF FEATURES

Camera mode definition

You can select the desired working mode by using the mode dial located on the top of the camera. This digital camera has 4 working modes. These are listed below.

■ STILL IMAGE mode ()

This camera has 3 kinds of fixed focus modes. The focus ranges are :

1. Macro () : 0.18m ~ 0.25m
2. Portrait () : 0.8m ~ 1.3m
3. Normal () : 1.3m ~ Infinity

■ PLAY mode ()

In this mode, the stored images on the memory can be viewed on the LCD monitor on the back of the camera. You can select single image play back, 9 thumbnail screen, slide show, one image deletion, all image deletion, format, protect, number of prints setting and digital zoom in this mode.

■ MOVIE CLIP mode ()

Movie clips are recorded for as long as the available recording time or pre-set time allows in this mode. The flash is changed to FLASH OFF when this mode is selected.

■ SETUP mode ()

In this mode, you can set up basic settings such as BEEP , POWER OFF, DATE IMPRINT, DATE TYPE, DATE & TIME SETUP, QUICK VIEW, LANGUAGE, RESET.

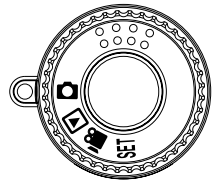

[Mode dial indicator]



INFORMATION

■ PC mode

Your computer will recognize the camera as a Removable Disk when connected by the USB cable. You can transfer images between the computer and the camera. If you are using Windows 98/98SE, you have to install the camera driver before connecting the USB cable. The camera working mode will be changed to PC mode by connecting the USB cable.

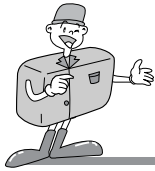

IDENTIFICATION OF FEATURES

■ Selecting camera mode and menu

You can select a camera mode or a camera mode menu by rotating the MODE dial or pressing the MENU button as below.

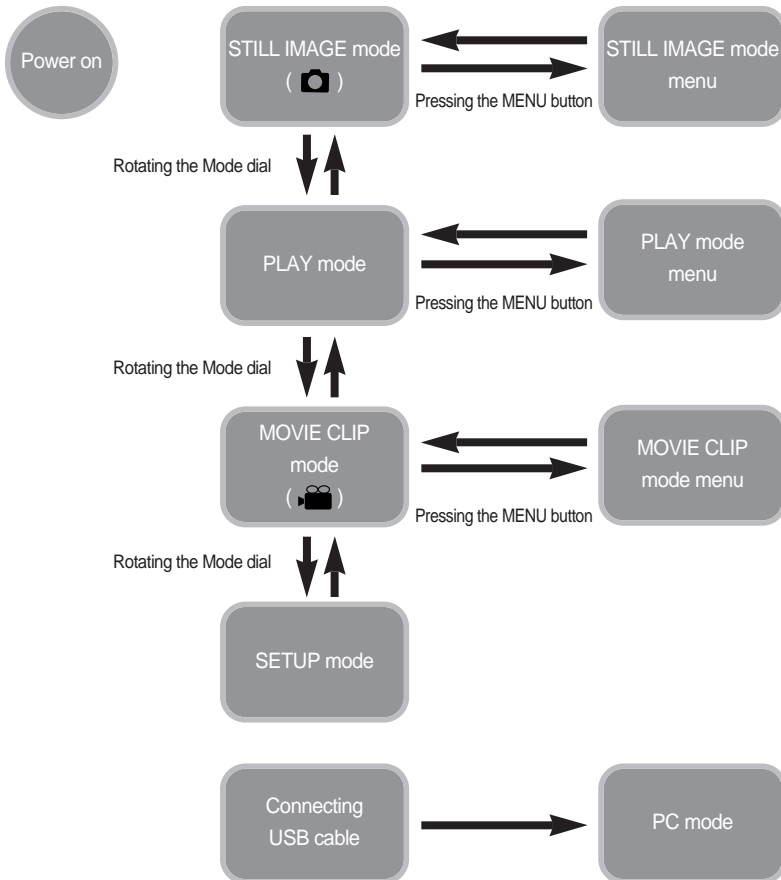



IDENTIFICATION OF FEATURES

LCD monitor menu indicator

Each mode has a menu as shown below. * marked sub menu is the default setting.

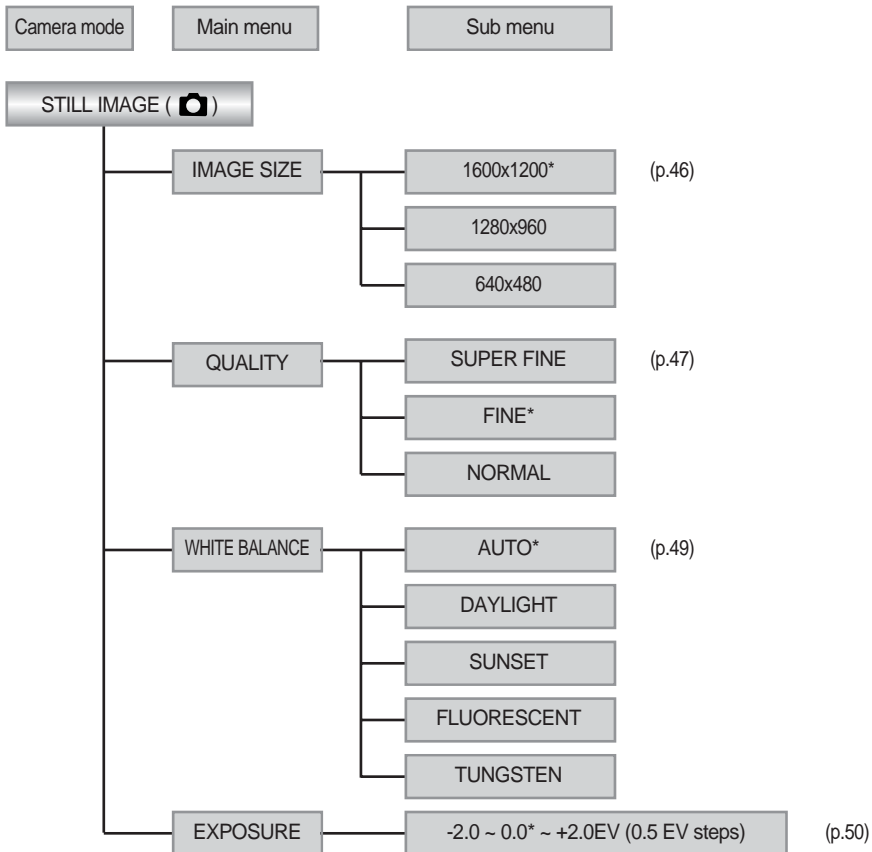

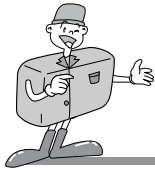

IDENTIFICATION OF FEATURES

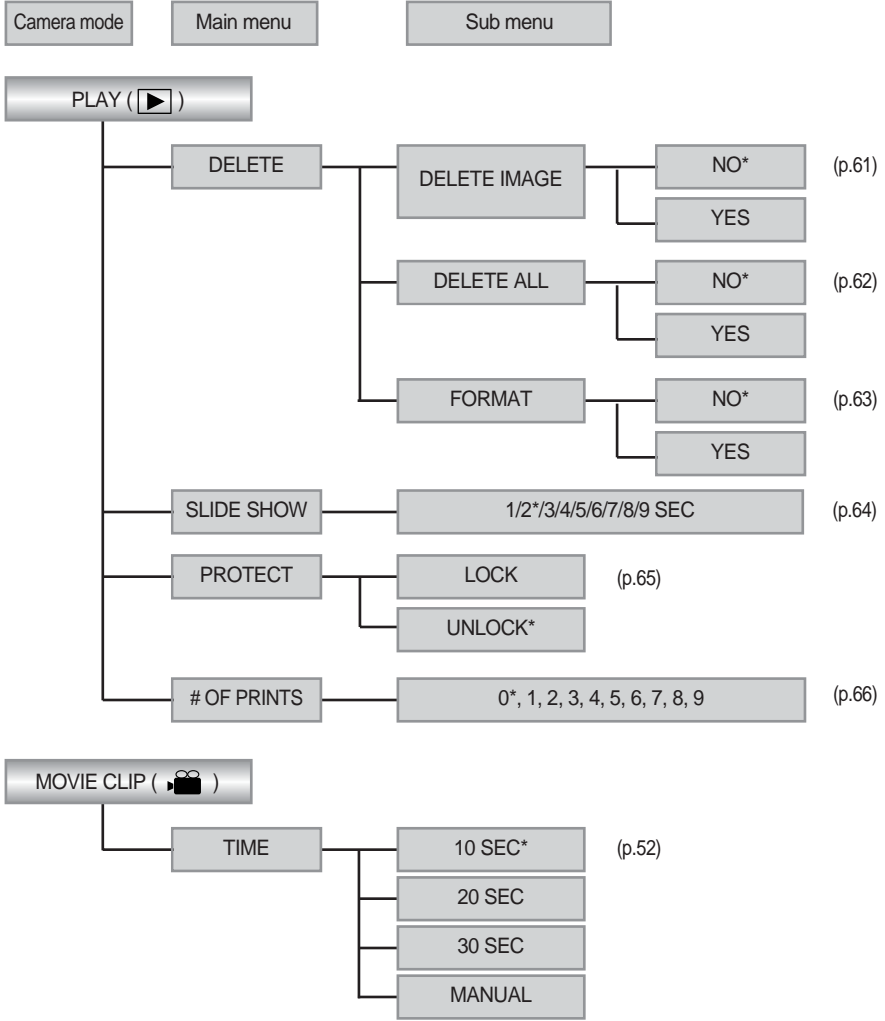



IDENTIFICATION OF FEATURES

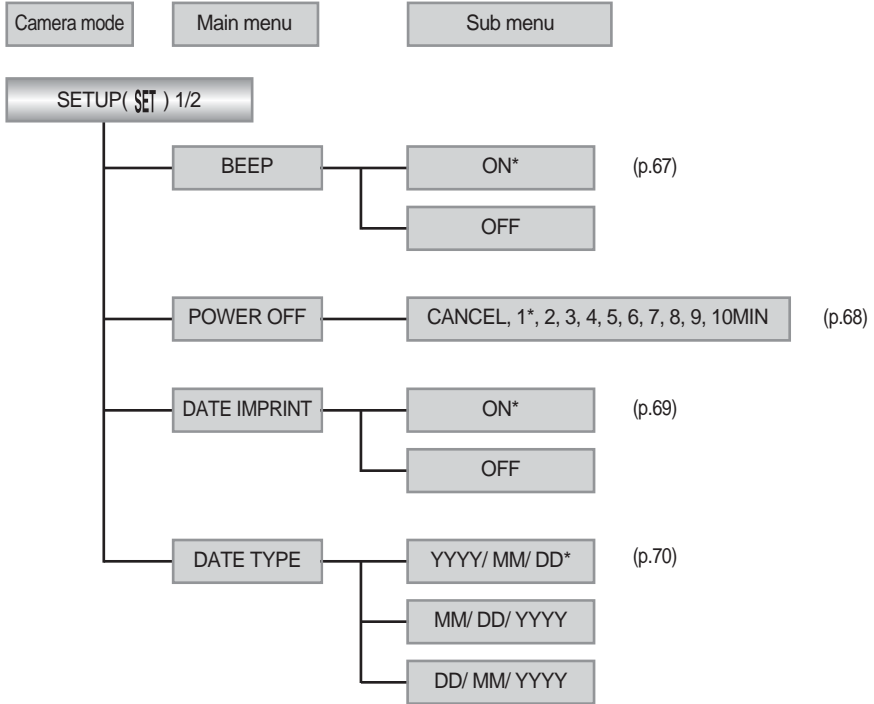



IDENTIFICATION OF FEATURES

Camera mode

Main menu

Sub menu

SETUP(SET) 2/2

DATE SETUP

2000/01/01~2099/12/31

(p.71)

QUICK VIEW

OFF

(p.72)

1 SEC*

2 SEC

3 SEC

LANGUAGE

ENGLISH

ESPAÑOL

(p.73)

한국어

ITALIANO

FRANÇAIS

简体中文

DEUTSCH

繁體中文

RESET

NO*

(p.74)

YES



INFORMATION

- There is no associated menu in the PC mode and the LCD monitor is always turned off in the PC mode.



PREPARATION

Connecting to Power

There are two ways in which to provide the camera with power. You can use batteries(AA Alkaline), or alternatively, you can use an AC Adapter (DC 3.3V / 2.0A).

■ Using the batteries

1. Open the battery chamber cover by pushing in the direction of the arrow.

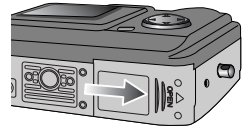

2. Insert the batteries taking note of the polarity (+ / -).

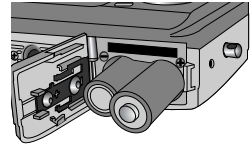

3. To close the battery chamber cover, push it until it clicks.

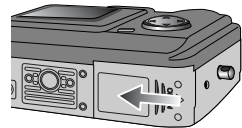

■ Battery condition indicator

There are 3 indicators for battery condition that are displayed on the LCD monitor.

 : The batteries are fully charged

 : Prepare new batteries

 : There is no battery capacity. Replace with new batteries.

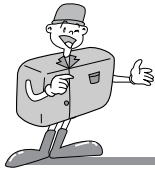

PREPARATION



INFORMATION

- This camera will automatically switch off when not in use for a period of time. Refer to [POWER OFF] function (p.68).



NOTICE

- Important information about battery usage
 - Please remove the batteries if the camera will not be used for long periods. Batteries can lose power over time and are prone to leaking if kept inside the camera.
 - We recommend high-capacity ALKALINE batteries as manganese batteries cannot deliver sufficient power.
 - Low temperatures (below 0°C) can affect the performance of the batteries and you may experience reduced battery life.
 - Batteries will normally recover at normal temperatures.
 - Do not use old and new batteries at the same time.
 - During extended use of the camera, the camera body may become warm. This is perfectly normal. If you are planning to use this camera for long periods of time, it is advisable to use an AC adapter.



PREPARATION

■ Using the AC power adapter

- If you have access to a mains supply, using an AC Adapter allows the camera to be used for long periods of time. If you connect the camera to a computer, it is advisable to use an AC adapter, as this will enable extended use.
- Plug the adapter into the connection point (DC IN 3.3V) on the camera.

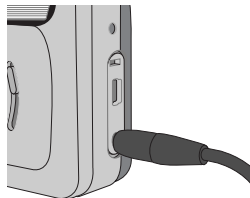

DANGER



DANGER/ NOTICE

- Always turn off the power before taking the AC adapter out of the mains supply.
- As with all mains powered devices, safety is important. Ensure that neither the camera nor adapter comes into contact with water or metallic materials.
- Please ensure that you use an AC adapter with the correct specification for the camera (3.3v /2.0A). Failure to do so may affect your warranty.

Attaching the strap

To prevent accidental damage to the camera, always use the strap.

Refer to the illustrations below

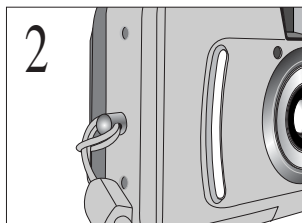
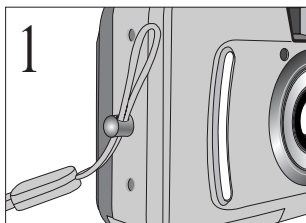



PREPARATION

Inserting the SD memory card

The camera comes with 8MB of internal flash memory, allowing you to store images and movie clips in the camera. However, you can expand the memory capacity by using an optional SD memory card ([CARD] stands for the SD memory card) so that you can store more images and movie clips.

1. Turn off the camera power and pull the card cover in the direction of the arrow to open.

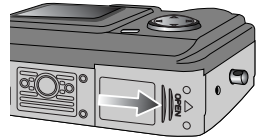

2. Insert the card all the way into the card slot. The card pins and the LCD monitor should face in the same direction. The card will be fitted.

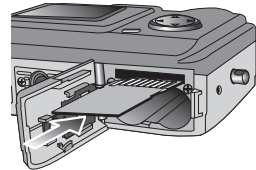

3. To close, push the card cover toward the arrow until you hear a click.

- Once the CARD is inserted, the SD memory card indicator will appear on the LCD monitor.
- If the CARD does not fit, check that it is inserted correctly. Do not force the card.

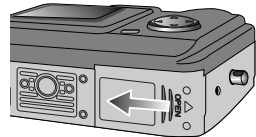

NOTICE

- Insert the Multi Media Card(MMC) in the same way as the SD memory card is inserted. Should you insert the Multi Media Card in the opposite direction, it may still slide in, but part of it will project from the slot and it will not fit correctly. Do not force the card and don't close the battery chamber cover. Check the directions and re-insert the card correctly.

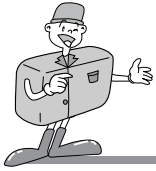

PREPARATION

The CARD has a write protect switch that prevents image files from being deleted or formatted. By sliding the switch to the bottom of the card, the data will be protected. By sliding the switch to the top of the card, the data protection will be canceled. Check the switch position before taking an image.

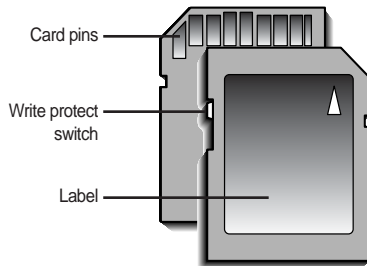

【 SD(Secure Digital) memory card 】

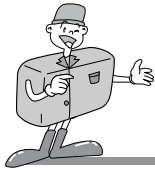

PREPARATION

Removing the SD memory card

1. Turn the power off using the power switch.
2. Open the card cover and press the CARD as shown in the image and release.
3. Remove the CARD and close the card cover.

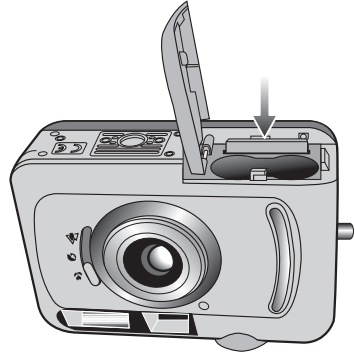

NOTICE

- Don't remove the CARD when the camera status LED(green) is blinking as this may cause damaged data in the CARD.

Instructions on how to use the SD memory card

- Using a new CARD for the first time
 - Before using the CARD, it must be initialized.
 - Initializing prepares the memory for recording data.
 - Refer to page 63 for information on [FORMAT].

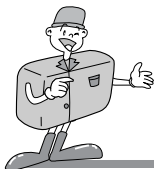

PREPARATION

■ Memory capacity

- When using a 16/ 32MB SD memory card or the internal memory, the specified shooting capacity will be as follows. (These figures are intended as an indication of expected performance)

Recorded image size	Recorded image quality	Number of shots		
		Internal Memory	SD memory card	
		8MB	16MB	32MB
1600X1200 (Large)	Super Fine	10	20	43
	Fine	18	34	74
	Normal	26	50	109
1280X960 (Medium)	Super Fine	15	29	63
	Fine	28	53	116
	Normal	43	85	185
640X480 (Small)	Super Fine	48	95	206
	Fine	83	172	372
	Normal	153	286	621

- These figures are approximate as image capacities can be affected by variables such as the memory performance and subject matter.

■ Maintenance of the SD memory card

- Turn off the camera power whenever the CARD is being inserted or removed.
- Repeated use of the CARD will eventually reduce the card's performance. Should this be the case, you will need to purchase a new CARD. Wear and tear on the CARD is not covered by the Samsung warranty.
- The CARD is an electronic precision device. Do not bend, drop or subject the card to any heavy impact.
- Do not store the CARD in an environment with strong electronic or magnetic fields, e.g. near loud speakers or TV receivers.
- Please do not use or store in an environment where there are extremes in temperature.
- Do not allow the CARD to become dirty or to come into contact with any liquid. Should this happen, clean the card with a soft cloth.
- Please keep the CARD in its case when not in use.
- During and after periods of extended use, you may notice that the CARD is warm. This is perfectly normal.

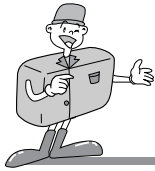

PREPARATION

■ Preserving the SD memory card data

- If the card is subjected to any of the following, the recorded data may become corrupted :
 - When the CARD is used incorrectly.
 - If the power is switched off or the CARD is removed while recording, deleting(formatting) or reading.
- Samsung cannot be held responsible for lost data.
- It is advisable to copy important data onto other media as back-up e.g. floppy disks, hard disks, CD etc.



INFORMATION

- If there is no card, the SD memory card indicator will not be displayed in the LCD monitor.
- If there is insufficient memory available:
 - If you press the shutter button for the shot, the following message is displayed and the camera will not operate.

MEMORY FULL!

- To optimize the amount of memory in the camera, replace the CARD or delete unnecessary images stored on the memory.



RECORDING MODE

Starting Recording Mode

- If the CARD is inserted in the camera, all the camera functions are applied only to the CARD.
- If the CARD is not inserted in the camera, all the camera functions are applied only to the internal memory.

■ Recording a still image

1. Insert the batteries (p.25). Insert the batteries taking note of the polarity (+ / -).
2. Insert the CARD (p.28). As this camera has an 8MB internal memory, you do not need to insert the SD memory card. If the CARD is not inserted, an image will be stored in the internal memory. To expand memory capacity, insert the CARD. If the CARD is inserted, an image will be stored on the CARD.
3. Close the card cover.
4. Slide the power switch to turn on the camera.
5. Select the STILL IMAGE mode by rotating the mode dial.
6. Point the camera towards the subject and compose the image by using either the viewfinder or LCD monitor.
7. Press the shutter button to capture an image.

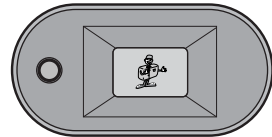

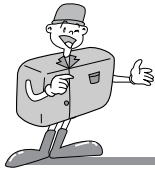

RECORDING MODE



INFORMATION

- Check the Date & Time in the following circumstances and correct it.
 - When you use this camera for the first time.
 - Whenever AC adapter and batteries are removed.

■ Recording a Movie clip

Steps from 1 - 4 are the same as those for recording a still image.

5. Select the MOVIE CLIP mode by rotating the mode dial.
6. The MOVIE CLIP mode icon and available recording time will display on the LCD monitor.
7. Point the camera towards the subject and compose the image by using either the viewfinder or LCD monitor.
8. Press the shutter button and movie clips are recorded for as long as the available recording time. Movie clips will still be recorded if the shutter button is released. The movie clip icon will blink during recording.
 - If you wish to stop recording, press the shutter button again.
(In case of selecting [MANUAL] sub menu in the Movie clip mode menu)
 - Image size and type are listed below.
 - Image size : QVGA (320 x 240)
 - File type : *.AVI



[Movie clip mode]



NOTICE

- Even though you can select any movie clip recording time in the MOVIE CLIP mode menu, the available recording time will be determined by available memory capacity.



RECORDING MODE



NOTICE

- Camera shake warning.

When the Flash Off mode is selected, the camera shake warning indicator () may appear on the LCD monitor. In this case, use a tripod, support the camera on a solid surface or change the flash mode to flash shot mode.

- Backlight compensated shot

When taking an outdoor shot, avoid facing the sun, as the image may be dark because of the strong backlight. In backlight conditions, please use the exposure compensation (refer to page 50).

- Avoid obstructing the lens or the flash when you take an image.

- As there can be some differences between what is seen through the Viewfinder and the resulting image when taken at a range closer than 1.5m, it is recommended that you use the LCD monitor to compose the shot.

- Using the LCD monitor extensively will drain the batteries.

We recommend turning off the LCD monitor and using the optical viewfinder as often as possible in order to extend battery life.

- Images can be dim under the following circumstances.

- In Macro focus mode, if the distance from a subject is closer than 0.18m or farther than 0.25m. Keep the distance between 0.18m~0.25m in Macro focus mode.
- In Portrait focus mode, if the distance from a subject is closer than 0.8m or farther than 1.3m. Keep the distance between 0.8m~1.3m in Portrait focus mode.
- In Normal focus mode, if the distance from a subject is closer than 1.3m. Keep the distance between 1.3m ~ Infinity in Normal focus mode.



RECORDING MODE

Using the camera button to adjust the camera

- The STILL IMAGE/MOVIE CLIP mode function can be set up by using the camera button.

POWER switch

- Used for turning the camera power on / off.
- The camera power will be turned off automatically during periods of inactivity. This is done to reduce battery drain. The camera can be reactivated by sliding the power switch again.

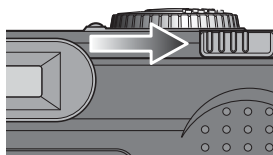

SHUTTER button

- Used for taking images for RECORDING (STILL IMAGE/ MOVIE CLIP).

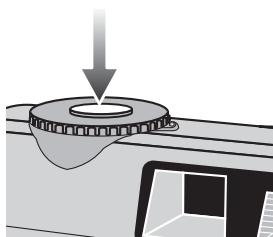

LCD button

- Pressing the LCD button in the RECORDING (STILL IMAGE, MOVIE CLIP) mode will change the display as shown below.

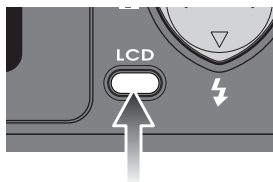



RECORDING MODE

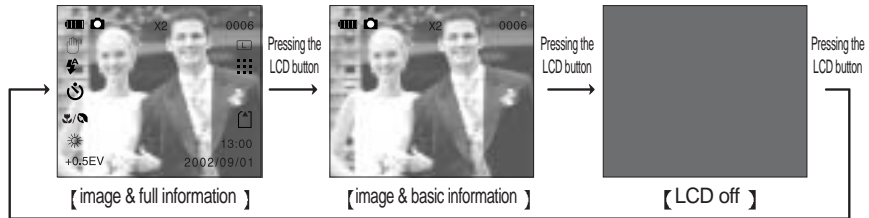

MENU button

- When you press the MENU button, a menu related to each camera mode will be displayed on the LCD monitor. Pressing it again will return the LCD to the initial display.

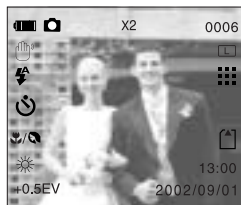
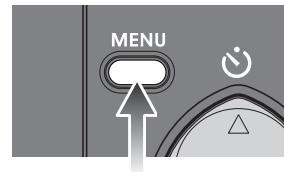

【 menu off 】

Pressing the
MENU button

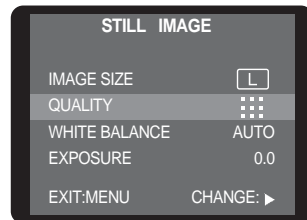

【 menu on 】

- A menu option can be displayed when the following are selected : STILL IMAGE mode, MOVIE CLIP mode, PLAY mode and SETUP mode. There is no menu available when the PC mode is selected. Refer to page 19 for information on the camera mode menu.



RECORDING MODE



Focus switch

Before taking an image, you have to check that the Focus switch is in the desired position. As there can be some differences between what is seen through the Viewfinder and the resulting image when taken at a range closer than 1.5m, it is recommended that you use the LCD monitor to compose the shot.



There are 3 kinds of focus options in the STILL IMAGE mode.

■ Macro () focus mode

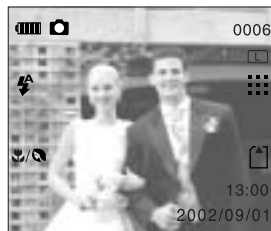

The focus range is 0.18m ~ 0.25m. A Macro/Portrait icon ( / ) will display on the LCD monitor when you select this focus mode.



NOTICE

To prevent the image from being dim, maintain the focus range at 0.18m ~ 0.25m.

■ Portrait() focus mode

The focus range is 0.8m ~ 1.3m. A Macro/Portrait icon ( / ) will display on the LCD monitor when you select this focus mode.



NOTICE

To prevent the image from being dim, maintain the focus range at 0.8m ~ 1.3m.



RECORDING MODE

■ Normal() focus mode

The focus range is 1.3m ~ infinity.

No icons will display on the LCD monitor when you select this focus mode.

NOTICE



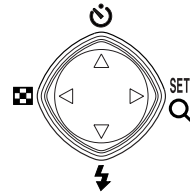

To prevent the image from being dim, maintain the focus range at 1.3m ~ infinity.

4-function button

Explanation of the 4-function button



[4-function button]

BUTTON	MENU DISPLAY	STILL IMAGE mode	MOVIE CLIP mode	page
UP() button	ON	Makes the menu cursor move up	Makes the menu cursor move up	p.41
	OFF	Selecting the self-timer mode	Selecting the self-timer mode	
DOWN() button	ON	Makes the menu cursor move down	Makes the menu cursor move down	p.42
	OFF	Selecting the flash mode	No function	
LEFT() button	ON	No function	No function	p.41
	OFF	No function	No function	
RIGHT() button	ON	Confirming the selection	Confirming the selection	p.40
	OFF	Activating digital zooming in	No function	

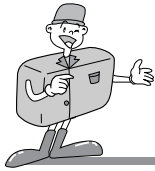

RECORDING MODE

SET/ RIGHT(▶) button

- When the menu is displayed on the LCD monitor, this button is used for confirming data that is changed by using ▲ / ▼ buttons.
- When the menu is not displayed on the LCD monitor, pressing this button activates digital zooming in.
- The maximum zoom magnification is 2X for recording images and viewing images.

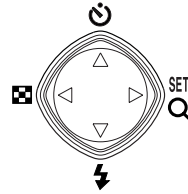

■ Digital zoom

- To use the digital zoom, the LCD monitor has to be turned on.
1. Turn the camera power on.
 2. Select the STILL IMAGE mode by rotating the mode dial.
 3. Do not turn the LCD monitor off.
 4. Press the SET(▶) button and a twice magnified image will display on the LCD monitor.
 5. Press the SET(▶) button again and the digital zoom function is cancelled.

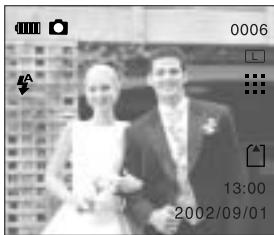

[A normal image]

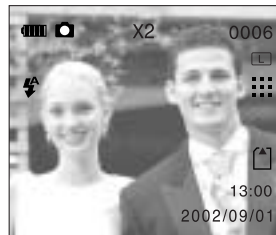
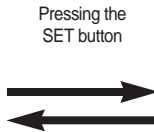

[Digital zoomed image]



INFORMATION

- Images taken using the digital zoom may take a little longer for the camera to process. Allow time for this to take place.
- The digital zoom cannot be used in the MOVIE CLIP mode.
- You may notice a decrease in image quality when using digital zoom.



RECORDING MODE

THUMBNAIL/ LEFT(◀) button

- In RECORDING(STILL IMAGE, MOVIE CLIP) mode, there are no functions in the LEFT(◀) button.
- When the menu is not displayed on the LCD monitor, pressing the RIGHT(▶) button activates as a Thumbnail button.
- You can view 9 images at a time on the LCD monitor in thumbnail mode.

SELF-TIMER(⌚)/ UP(▲) button

- When the menu is displayed on the LCD monitor, pressing the UP button (▲) makes the menu cursor move up.
- When the menu is not displayed on the LCD monitor, the LEFT (▶) button operates as the SELF-TIMER button in RECORDING(STILL IMAGE/ MOVIE) mode.
- This function is used when the photographer would also like to be in the image.

■ Selecting the self-timer

- The self-timer activates only in RECORDING(STILL IMAGE/ MOVIE CLIP) mode.
- Use a tripod or place the camera on a stable surface.

1. Do not turn the LCD monitor off.
2. Select RECORDING(STILL IMAGE/ MOVIE CLIP) mode by rotating the mode dial.
3. If the self-timer indicator is displayed on the LCD monitor by pressing the SELF-TIMER button, the setting is completed.

Press the self-timer button again, and the self-timer is canceled.

4. Pressing the shutter button will allow an interval of ten seconds before the image is taken. After that, the self-timer is cancelled.
- If you select [MANUAL] sub menu in [TIME] MOVIE CLIP mode menu, the movie clip can be recorded as long as the memory allows. To stop the recording, press the shutter button.

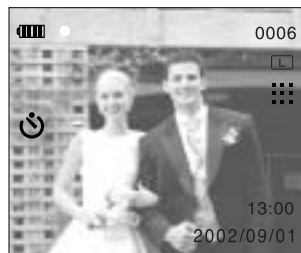



RECORDING MODE



INFORMATION

- The default is OFF.
- The self-timer LED lamp(red) will blink for 10 seconds after the SELF-TIMER button has been pressed.
 - For the first seven seconds, the LED blinks at 1 second intervals.
 - For the final three seconds, the LED blinks quickly at 0.5-second intervals.
- The remaining time to take an image will be shown on the LCD monitor.

FLASH(⚡) / DOWN(▼) button

- When the menu is displayed on the LCD monitor, pressing the DOWN button (▼) makes the menu cursor move down or changes the sub menu.
- When the menu is not displayed on the LCD monitor, the DOWN (▼) button operates as the FLASH button.

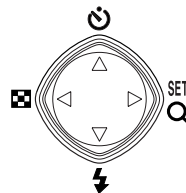

■ Selecting the flash mode

- The flash activates only in the STILL IMAGE mode.
1. Do not turn the LCD monitor off.
 2. Select the STILL IMAGE mode by rotating the mode dial.
 3. Press the FLASH button(⚡) until the desired FLASH mode indicator displays on the LCD monitor. Use the correct flash to suit the environment.

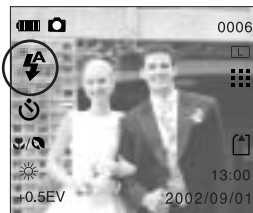

【 Selecting the Auto flash 】









■ The default of each mode is listed below.

- STILL IMAGE mode : Auto flash
- MOVIE CLIP mode : Flash off(fixed)







RECORDING MODE

■ Flash mode indicator

FLASH MODE	Indicator	Definition
Auto flash		If the subject or background is dark, the camera flash will operate automatically.
Auto & Red eye reduction		<p>If a subject or background is dark, the camera flash will work automatically and will reduce the red-eye effect by using the red-eye reduction function.</p> <div style="text-align: center;">  →  </div>
Slow synchro	 	<p>When you take an image of a subject at night, a slow shutter speed results in the background and the subject being bright. We recommend using a tripod.</p> <p>When you take an image in a low light condition, the camera shake warning indicator () will display on the LCD monitor.</p> <div style="text-align: center;">  →  </div>

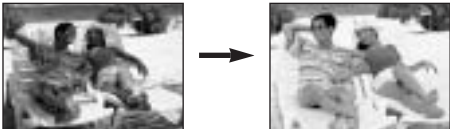

RECORDING MODE

<p>Fill in flash</p>		<p>The flash fires regardless of available light.</p> 
<p>Flash off</p>	 	<p>The flash does not fire. Select this mode when capturing images at a place where the flash photography is prohibited.</p> <p>When you take an image in a low light condition, the camera shake warning indicator () will display on the LCD monitor.</p>



NOTICE

- Using the flash frequently will reduce the life of the batteries. Under normal operating conditions the charging time for the flash is normally within 10 seconds.
If the batteries are weak, the charging time will be longer.
- Take photographs within the flash range.

■ The flash range

The flash ranges are listed below

Mode	ISO	Flash range
STILL IMAGE mode	AUTO(100, 200)	0.8 ~3m

- The image quality is not guaranteed if the subject is too close or highly reflective.



RECORDING MODE

Using the LCD monitor to adjust the camera

- Recording functions can be changed by using the LCD monitor.
- In the RECORDING(STILL IMAGE/MOVIE CLIP) mode, pressing the MENU button displays the menu on the LCD monitor.
- The following functions are available, depending on the mode you have selected (STILL IMAGE, MOVIE CLIP).

Mode	STILL IMAGE mode	MOVIE CLIP mode	PAGE
IMAGE SIZE	O	X	p.46
QUALITY	O	X	p.47
WHITE BALANCE	O	X	p.49
DIGITAL ZOOM	O	X	p.40
EV COMPENSATION	O	X	p.50
MOVIE CLIP RECORDING TIME	X	O	p.52



INFORMATION

- The menu will not be displayed on the LCD monitor in the following circumstances:
 - When another button is being operated.
 - While image data is being processed. (when the red LED next to the viewfinder blinks)
 - When there is no battery capacity.
- When the menu is showing on the LCD monitor, it is not possible to operate the shutter button i.e. take an image. To take an image, simply cancel the menu display by pressing the MENU button. The menu will no longer show and the camera is ready to take an image.

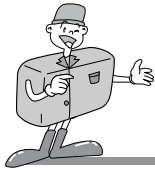

RECORDING MODE

IMAGE SIZE

- In the STILL IMAGE mode, you can select the image size.
- A large image uses more memory, so increasing image size will reduce the total number of shots you can store on a memory.
- The image sizes are listed below.

L 1600x1200

M 1280x960

S 640X480

■ Selecting the image size

1. Turn the camera power on.
2. Select the STILL IMAGE mode by rotating the mode dial.
3. Do not turn the LCD monitor off.
4. Press the MENU button to display the menu on the LCD monitor.
5. Press the UP(▲)/ DOWN(▼) button and select [IMAGE SIZE].
6. Press the SET(▶) button and the sub menu will display.
7. Press the UP(▲)/ DOWN(▼) button and select [L], [M] or [S].
8. Press the SET(▶) button to confirm the setting.
The default is [1600x1200 (L)].
9. Press the MENU button to cancel the menu display.



【 STILL IMAGE mode 】



RECORDING MODE

IMAGE QUALITY

- In the STILL IMAGE mode, you can select the image quality(Data compression rate).
- The higher the QUALITY setting, the better the final image will be. However, the high quality setting will require more memory and therefore reduce the number of images you can store on the memory. SUPER FINE is the highest quality and NORMAL is the lowest setting. Choose the setting appropriate for your needs. The image qualities are listed below.



SUPER FINE



FINE



NORMAL

■ Selecting the image quality

1. Turn the camera power on.
2. Select the STILL IMAGE mode by rotating the mode dial.
3. Do not turn the LCD monitor off.
4. Press the MENU button to display the menu on the LCD monitor.
5. Press the UP(▲)/ DOWN(▼) button and select [QUALITY].
6. Press the SET(▶) button and the sub menu will be displayed.
7. Press the UP(▲)/ DOWN(▼) button and select [SUPERFINE], [FINE] or [NORMAL].
8. Press the SET(▶) button to confirm the setting.
The default is [FINE].
9. Press the MENU button to cancel the menu display.



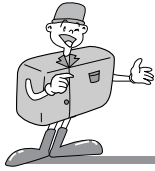

RECORDING MODE



NOTICE

- The image file is stored as a *.jpg.
- This file format complies with DCF(Design rule for Camera File system)

JPEG

JPEG [Joint Photographic Experts Group] : The name of the committee that designed the standard image compression algorithm. The JPG file format is designed for compressing digital images without harmful influence to the original image. It is the most common type of compressed image file format used in the world wide web.



RECORDING MODE

WHITE BALANCE

- Different lighting conditions may cause a color cast on your images.
- The white balance control allows you to adjust the colors to appear more natural looking.
- The changed white balance value is maintained until the camera power is off.
- There are 5 white balance menus : AUTO/ DAYLIGHT/ SUNSET/ FLUORESCENT / TUNGSTEN

■ Selecting the white balance

1. Turn the camera power on.
2. Select the STILL IMAGE mode by rotating the mode dial.
3. Do not turn the LCD monitor off.
4. Press the MENU button to display the menu on the LCD monitor.
5. Press the UP(▲)/ DOWN (▼) button and select [WHITE BALANCE].
6. Press the SET(▶) button and the sub menu will be displayed.
7. Press the UP(▲)/ DOWN (▼) button and select the desired white balance sub menu..
8. Press the SET(▶) button to confirm the setting.
The default is [AUTO].
9. Press the MENU button to cancel the menu display.

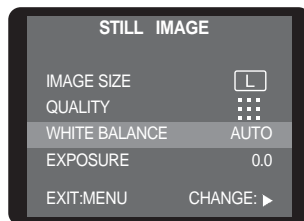



RECORDING MODE



INFORMATION

- **AUTO** : The camera automatically selects the appropriate white balance settings, depending on the prevailing lighting conditions.
 - **DAYLIGHT** : For taking images outside on a bright day.
 - **SUNSET** : For taking images at sunset
 - **FLUORESCENT** : For taking images under fluorescent lighting
 - **TUNGSTEN** : For taking images under tungsten (standard light bulb) lighting.
- * If you change the white balance value in the STILL IMAGE mode, the changed value is also applied to the MOVIE CLIP mode.

EV COMPENSATION

- This camera automatically adjusts the exposure according to the ambient lighting conditions. However, you can select the exposure value by using the [EXPOSURE] sub menu.
- In the STILL IMAGE mode, you can select the exposure value.
- If you increase the exposure value, the image will be brighter.
- If you decrease the exposure value, the image will be darker.

■ Selecting the exposure value

1. Turn the camera power on.
2. Select the STILL IMAGE mode by rotating the mode dial.
3. Do not turn the LCD monitor off.
4. Press the MENU button to display the menu on the LCD monitor.

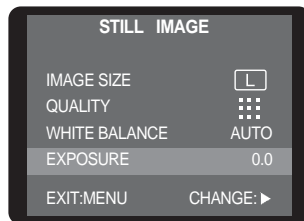



RECORDING MODE

5. Press the UP(▲)/ DOWN (▼) button and select [EXPOSURE].
6. Press the SET(▶) button and the sub menu will be displayed.
7. Press the UP(▲)/ DOWN (▼) button and select the desired [EXPOSURE] sub menu.
8. Press the SET(▶) button and the sub menu will be displayed.
The default is [0.0EV].
9. Press the MENU button to cancel the menu display.

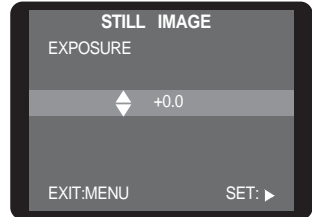

NOTICE

- Exposure compensation setting range : -2.0 ~ +2.0 EV (0.5 EV steps)
- This change to the exposure will remain until the camera is switched off. When the camera is turned on again, the exposure compensation setting returns to 0.0EV (discarding the exposure compensation).
- When you have selected a change in exposure value, the value is displayed on the LCD.
- Decreasing or increasing the exposure value may lead to images being under or over exposed (too dark or too bright). Review your images using the LCD monitor to check that they have been successful.
- * If you change the exposure compensation value in the STILL IMAGE mode, the changed value is also applied to the MOVIE CLIP mode.



RECORDING MODE

Movie clip recording time

- This menu will display only in the MOVIE CLIP mode
- You can select the movie clip recording time.

■ Selecting the movie clip recording time

1. Turn the camera power on.
2. Select the MOVIE CLIP mode by rotating the mode dial.
3. Do not turn the LCD monitor off.
4. Press the MENU button to display the menu on the LCD monitor.
5. Press the UP(▲)/ DOWN button (▼) and select the desired movie clip recording time.
6. Press the SET(▶) button to confirm the setting.
The default is [10SEC].

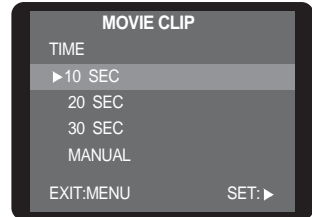

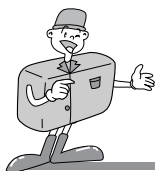

PLAY MODE

Starting the Play Mode

- Turn the camera on and select the PLAY mode by pressing the mode dial. The camera can now play back the images stored on the memory.
- You can set up the PLAY mode function by using the camera buttons and LCD monitor.

■ Playing back a still image

1. Slide the power switch to turn on the camera.

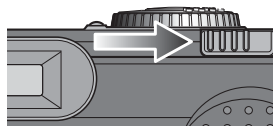

2. Select the PLAY mode by rotating the mode dial.

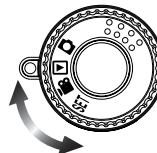

3. The last image stored on a memory is displayed on the LCD monitor.

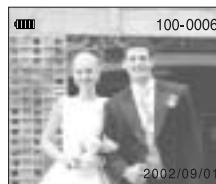

4. Select an image that you want to play back by pressing the UP(▲) / DOWN(▼) button.

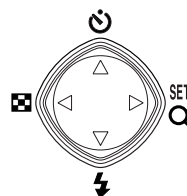



PLAY MODE

■ Playing back a movie clip

Steps from 1-3 are the same as those to play back a still image.

4. Select the movie clip that you want to play back by using the UP(▲) / DOWN(▼) button. If you select a movie clip file, the movie clip indicator(▶) will be displayed on the LCD monitor.
5. Press the SET(▶) button to play back a movie clip
 - To pause playing back a movie clip, press the SET(▶) button again.
 - To stop play back, press the MENU button.
 - Press the UP(▲)/ DOWN(▼) button and other images will play back.

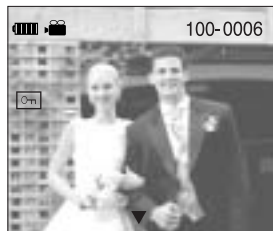

■ The PLAY mode functions are listed below

Camera button		Thumbnail, Digital zoom, Image information display
LCD monitor	Play back	Image deletion, Delete all, Format Slide show, Protect image
	Print setting	Number of prints



PLAY MODE



NOTICE

- If there are no images stored on the internal memory or SD memory card, a [NO IMAGE!] message will display on the LCD monitor.



INFORMATION

- If the CARD is inserted in the camera, all the camera functions are applied only to the CARD.
- If the CARD is not inserted in the camera, all the camera functions are applied only to the internal memory.
- The last image stored on the internal memory will be displayed on the LCD monitor.
- If the SD memory card is inserted, the last image stored on the SD card will be displayed.
- The LCD monitor will remain in operation until the camera is switched off in PLAY mode.
- The menu will not display on the LCD monitor under the following circumstances:
 - When another button is being pressed.
 - While image data is being processed.
(while the green LED next to the viewfinder is being blinking)
 - When there is no battery capacity.



PLAY MODE

Setting up the play back function by using the camera button

- You can set up the PLAY mode function by using the camera buttons.

Power switch

- Used for turning the camera power on / off.
- The camera power will be turned off automatically during periods of inactivity. This is done to reduce battery drain. The camera can be reactivated by sliding the power switch again.

LCD button

- Pressing the LCD button in the PLAY mode will change the display as shown below.

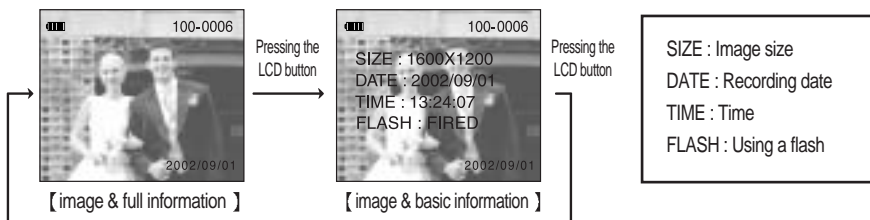

You can check the image information(image size, recording date, time, flash) in the [image & basic information] display.

Ex) SIZE : 1600x1200 → Image size DATE : 2002/09/01 → Recording date
TIME : 13:24:07 → Time FLASH : FIRED → FIRED



PLAY MODE

MENU button

- When you press the MENU button, a menu related to each camera mode will be displayed on the LCD monitor. Pressing it again will return the LCD to the initial display.



【 menu off 】

Pressing the
MENU button

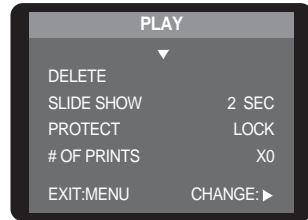

【 menu on 】

4-function button

- Explanation of the 4-function button

BUTTON	MENU DISPLAY	PLAY mode	Page
UP(▲) button	ON	Makes the menu cursor move up	p.60
	OFF	Selects a previous image(Normal or thumbnail display) Moves to the upper part of the image(Digital zoom)	
DOWN(▼) button	ON	Makes the menu cursor move down	p.60
	OFF	Selects the next image(Normal or thumbnail display) Moves to the lower part of the image(Digital zoom)	
LEFT(◀) button	ON	No function	p.58
	OFF	Starts / Stops the thumbnail display mode Moves to the left part of the image(Digital zoom)	
RIGHT(▶) button	ON	Confirming the selection.	p.59
	OFF	Normal display → 2X digital zoom display Moves to the right part of the image(Digital zoom) Starts or Pauses a thumbnail playing back Starts or Pauses a movie clip playing back	



PLAY MODE

THUMBNAIL/ LEFT(◀) button

- You can view up to 9 images at a time by using the THUMBNAIL function.
- When the menu is not displayed on the LCD monitor, pressing the LEFT(◀) button activates the following.
 - Normal display : Starts / stops the thumbnail display
 - Digital zoom : Moves to the left part of the image

■ Thumbnail display

1. Turn the camera power on.
2. Select the PLAY mode by rotating the mode dial.
3. A stored image will show in single display mode.
4. Press the THUMBNAIL/LEFT(◀) button.

9-images will be displayed at the same time on the LCD monitor. The thumbnail display will highlight the image that had been showing at the time the thumbnail mode was selected.



【Normal display mode】



Pressing the THUMBNAIL /LEFT(◀) button.

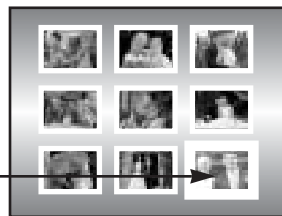

Highlighted image (selected image)



【Thumbnail display mode】

5. Press the UP(▲)/ DOWN(▼) button to move to the desired image.

The selected image is highlighted. Icons are displayed to indicate the type of file selected.

() : Movie clip file () : Print setting indicator

() : Protect indicator

6. When viewing a thumbnail image, press the SET(▶) button and the selected shot will show in single display mode.



PLAY MODE

SET/ RIGHT(▶) button

- When the menu is displayed on the LCD monitor, the SET button is used for confirming data that is changed by using the ▲/▼/◀/▶ buttons.
- When the menu is not displayed on the LCD monitor, pressing the OK button activates the following.
 - Normal display : Whenever you press the OK button, a still image will be enlarged to a 2X scale of enlargement.
 - Thumbnail display : The thumbnail display is changed to Normal display by pressing the SET(▶) button.
 - When A movie clip is selected : A movie clip is played back or paused by pressing the SET(▶) button.
 - When the slide show is selected : the slide show is started or paused by pressing the SET(▶) button.

■ Image enlargement

1. Turn the camera power on.
2. Select the PLAY mode by rotating the mode dial.
3. Select the desired image by pressing ▲/▼ button.
4. A 2X enlarged image is displayed by pressing the SET(▶) button.
5. Different parts of the image can be viewed by pressing the ▲/▼/◀/▶ buttons.
6. Pressing the MENU button will zoom back to the original full sized image.

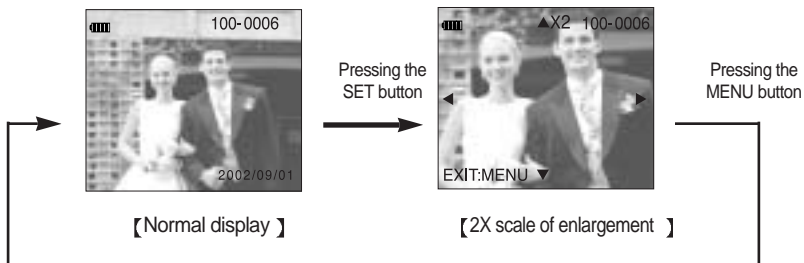

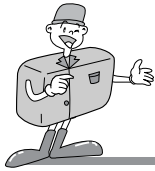

PLAY MODE



NOTICE

- When you enlarge an image, the digital zoom indicator will display on the LCD monitor.
- The digital zoom cannot be used in the MOVIE CLIP mode.
- You may notice a decrease in image quality when using the digital zoom.

UP(▲) button

- When the menu is displayed on the LCD monitor, pressing the UP (▲) button makes the menu cursor move up.
- When the menu is not displayed on the LCD monitor, pressing the UP (▲) button activates the following.
 - Normal / Thumbnail display : moves to previous image
 - Digital zoom : Moves to the upper part of the image
 - When a movie clip is playing : cancels the playing and displays a previous image.

DOWN(▼) button

- When the menu is displayed on the LCD monitor, pressing the DOWN (▼) button makes the menu cursor move down.
- When the menu is not displayed on the LCD monitor, pressing the DOWN (▼) button activates the following.
 - Normal / Thumbnail display : moves to next image
 - Digital zoom : Moves to the lower part of the image
 - When a movie clip is playing : cancels the playing and displays a next image.



PLAY MODE

Setting up the play back function using the LCD monitor

- The PLAY mode functions can be changed by using the LCD monitor.
- In the PLAY mode, pressing the MENU button displays the menu on the LCD monitor.

Image deletion

■ Deleting an image

- An unprotected image can be deleted in this menu.
(A protected image can't be deleted.)

1. Turn the camera power on.
2. Select the PLAY mode by rotating the mode dial.
3. Do not turn the LCD monitor off.
4. Press the MENU button to display the menu on the LCD monitor.
5. Press the UP(▲)/ DOWN(▼) button and select [DELETE].
6. Press the SET(▶) button and the sub menu will be displayed.
7. Select [DELETE IMAGE] by pressing the UP(▲)/ DOWN(▼) button and press the SET(▶) button
8. Select [NO] or [YES] and press the SET(▶) button.
 - [Selecting NO] : The image will be displayed on the LCD monitor.
 - [Selecting YES] : A [PLEASE WAIT!] message is displayed and a selected image is deleted.

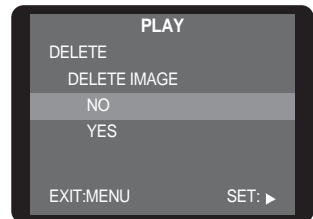
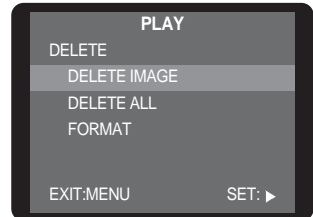
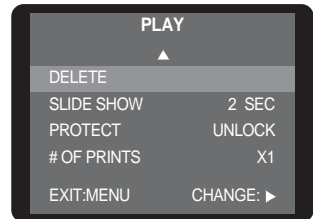

NOTICE

- Before deleting an image from the camera, you should download (p.75) the image to your computer or protect (p.65) the image, if you want to keep it.



PLAY MODE

■ Delete all

- This enables you to clear all unprotected images from the memory.
- Remember that this will permanently delete unprotected images. Important shots should be stored on a computer before deletion takes place.

1. Turn the camera power on.
2. Select the PLAY mode by rotating the mode dial.
3. Do not turn the LCD monitor off.
4. Press the MENU button to display the menu on the LCD monitor.
5. Press the UP(▲)/DOWN(▼) button and select [DELETE].
6. Press the SET(▶) button and the sub menu will be displayed.
7. Select [DELETE ALL] by pressing the UP(▲)/DOWN(▼) button and press the SET(▶) button
8. Select [NO] or [YES] and press the SET(▶) button.
 - [Selecting NO] : The image will be displayed on the LCD monitor.
 - [Selecting YES] : A [Please wait!] message is displayed and all of unprotected images are deleted.

(If there are no protected images, all of the stored images are deleted and a [NO IMAGE!] message will display.)

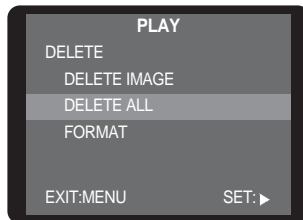
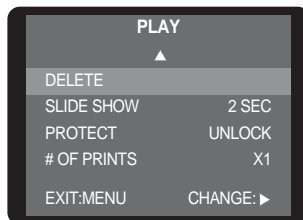



PLAY MODE

■ Format

- Internal memory format : Remove the SD memory card to format the internal memory.
- SD memory card format : Insert the SD memory card to format the SD memory card.
- All the files in the memory are deleted by the [FORMAT] function.

Before formatting the memory, it is advisable to copy important data onto other media as back-up e.g. floppy disks, hard disks, CD etc.

1. Turn the camera power on.
2. Select the PLAY mode by rotating the mode dial.
3. Do not turn the LCD monitor off.
4. Press the MENU button to display the menu on the LCD monitor.
5. Press the UP(▲)/ DOWN(▼) button and select [DELETE].
6. Press the SET(▶) button and the sub menu will display.
7. Select [FORMAT] by pressing the UP(▲)/DOWN(▼) button and press the SET(▶) button
8. Select [NO] or [YES] and press the SET(▶) button.

- [Selecting NO] : The image will be displayed on the LCD monitor.
- [Selecting YES] : A [PLEASE WAIT!] message is displayed and all of images are deleted.

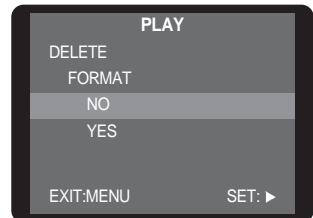
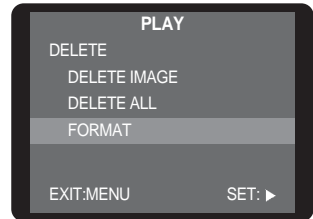
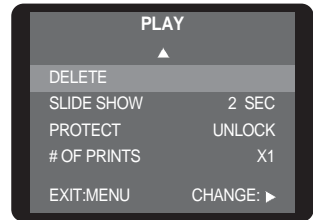

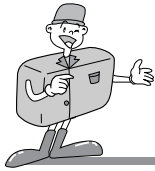

PLAY MODE

Slide show

- Images can be displayed continuously at pre-set intervals.
- This is useful and convenient for checking recorded images and for presentations.
- You can select the slide show play back time(between 1 and 9 sec)

1. Turn the camera power on.
2. Select the PLAY mode by rotating the mode dial.
3. Do not turn the LCD monitor off.
4. Press the MENU button to display the menu on the LCD monitor.
5. Press the UP(▲)/ DOWN (▼) button and select [SLIDE SHOW].
6. Press the SET(▶) button and the sub menu will display.
7. Press the UP(▲)/ DOWN (▼) button and select the desired slide show play back time. Press the SET(▶) button and the slide show will start.
8. To pause or restart the slide show, press the SET(▶) button.
9. If the slide show is finished, the last stored image will be displayed.

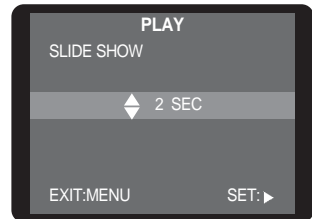
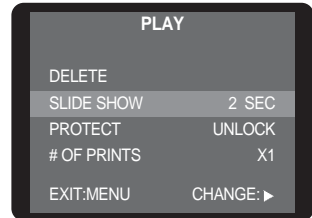



PLAY MODE

Protect

- This is used to protect specific shots from accidental erasing (LOCK).
It also releases images that have been previously protected (UNLOCK).

1. Turn the camera power on.
2. Select the PLAY mode by rotating the mode dial.
3. Do not turn the LCD monitor off.
4. Select an image that you want to protect by pressing the UP(▲)/ DOWN (▼) button.
5. Press the MENU button to display the menu on the LCD monitor.
6. Press the UP(▲)/ DOWN (▼) button and select [PROTECT].
7. Press the SET(▶) button and the sub menu will display.
8. Select [LOCK] or [UNLOCK] by pressing the UP(▲)/ DOWN (▼) button and press the SET(▶) button.
 - LOCK : Sets up the PROTECT function.
 - UNLOCK : Discards the protect function
9. When you protect an image, the protect indicator will display on the LCD monitor.

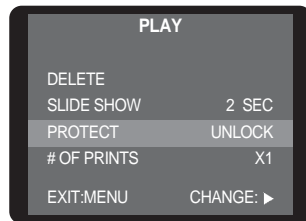

ADVANCED

Protect indicator →
The unprotected image does not have indicator.

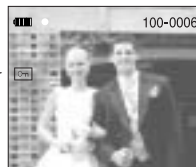

NOTICE

- An image in LOCK mode will be protected from [DELETE] or [DELETE ALL] functions, but will NOT be protected from the [FORMAT] function.



PLAY MODE

of prints

- This function allows you to embed print quantity information on your memory card.
- Images can then be printed on DPOF printers, or at an increasing number of photo laboratories.
- This function is not available for Movie clips.
- The DPOF file is only stored on the card.

■ Setting up the number of prints

1. Turn the camera power on.
2. Select the PLAY mode by rotating the mode dial.
3. Do not turn the LCD monitor off.
4. Select an image that you want to print quantities of by pressing the UP(▲)/ DOWN (▼) button.
5. Press the MENU button to display the menu on the LCD monitor.
6. Press the UP(▲)/ DOWN (▼) button and select [# OF PRINTS].
7. Press the SET(▶) button and the sub menu will display.
8. Select the number that you want and press the SET(▶) button to confirm the setting.
9. Print the setting indicator and the number of prints will be displayed on the LCD monitor after pressing the SET button.
Selectable the number of prints : 0 ~ 9
(If you select '0(zero)', you can't print an image.)

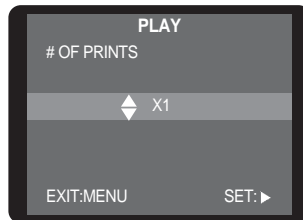
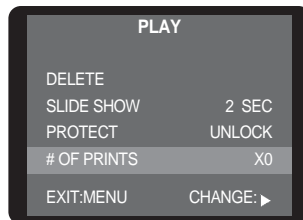



SETUP MODE

Starting the SETUP mode

Rotate the mode dial to the SETUP mode, allowing you to set up the basic camera settings.

Beep

- A beep will sound when you press the camera button and you can check the camera conditions.

1. Turn the camera power on.
2. Select the SETUP mode by rotating the mode dial.
3. [SETUP 1/2] menu will be displayed.
4. Select [BEEP] by pressing the UP (▲)/ DOWN (▼) button.
5. Press the SET (▶) button and the sub menu will be displayed.
6. Press the UP (▲)/ DOWN (▼) button and select [ON] or [OFF].
Press the SET (▶) button to confirm the setting.
7. The default is [ON].

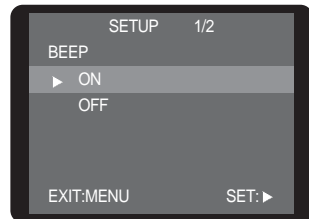
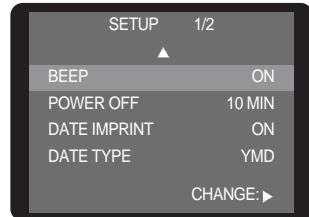
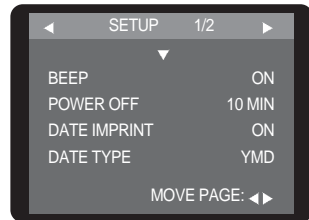

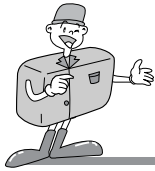

SETUP MODE

POWER OFF

- This function switches the camera off after a set amount of time in order to prevent unnecessary battery drainage.
- You can set the power to switch off at any specified time(1 ~ 10MIN, 1MIN interval) from the last operation.
- If you select [CANCEL], the power off function will not operate.
- Note that the automatic power off does not operate if the camera is in slide show or playing a movie clip.

1. Turn the camera power on.
2. Select the SETUP mode by rotating the mode dial.
3. [SETUP 1/2] menu will be displayed.
4. Press the UP (▲)/ DOWN (▼) button and select [POWER OFF].
5. Press the SET(▶) button and the sub menu will be displayed.
6. Select the desired sub menu by pressing the UP(▲)/ DOWN (▼) button. Press the SET(▶) button to confirm the setting.
7. The default is [1 MIN].

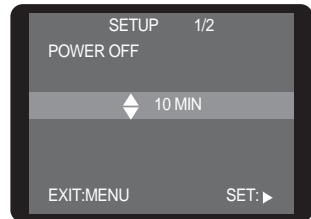
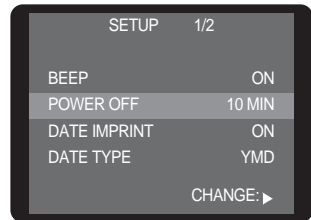
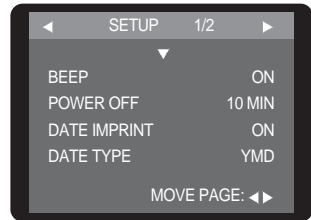

INFORMATION

- Even if the batteries or AC adapter are removed and inserted again, the power off setting will be preserved.



SETUP MODE

DATE IMPRINT

- There is an option to include DATE/TIME on still images.

1. Turn the camera power on.
2. Select the SETUP mode by rotating the mode dial.
3. [SETUP 1/2] menu will be displayed.
4. Press the UP (▲)/ DOWN (▼) button and select [DATE IMPRINT].
5. Press the SET(▶) button and the sub menu will be displayed.
6. Select [ON] or [OFF] by pressing the UP (▲)/ DOWN (▼) button. Press the SET(▶) button to confirm the setting.
7. The default is [ON].

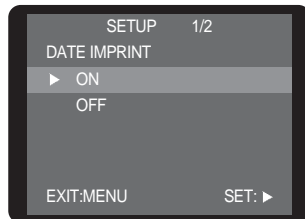
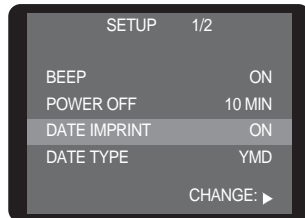
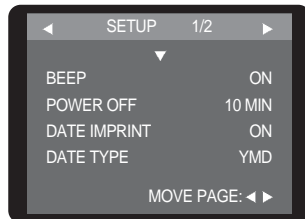

ADVANCED



INFORMATION

- This function is not available in the movie clip mode.
- Date will be imprinted as DATE TYPE setting.
- The DATE IMPRINT function is unaffected by the camera being switched on and off.
- The date can be set in [DATE SETUP].
- Even though the [DATE IMPRINT] menu is set to [OFF], the date will be displayed on the LCD monitor in the RECORDING(STILL IMAGE, MOVIE CLIP) mode.

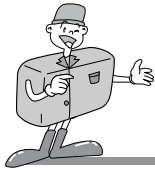

SETUP MODE

DATE TYPE

- You can select the date type that is to be imprinted on the image.
 - YYYY/MM/DD : year /month/ day
 - MM/DD/YYYY : month/ day /year
 - DD/MM/YYYY : day /month /year

1. Turn the camera power on.
2. Select the SETUP mode by rotating the mode dial.
3. [SETUP 1/2] menu will be displayed.
4. Press the UP(▲)/ DOWN(▼) button and select [DATE TYPE].
5. Press the SET(▶) button and the sub menu will be displayed.
6. Select your desired date type by pressing the UP(▲)/ DOWN(▼) button.
Press the SET(▶) button to confirm the setting.
7. The default is [YYYY/MM/DD].

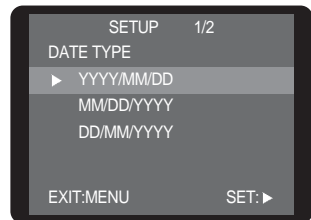
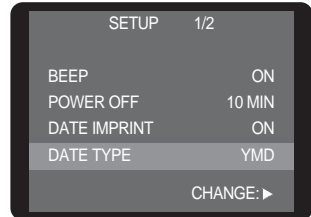
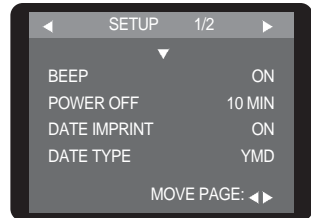



SETUP MODE

DATE SETUP

• You can change the imprinted date/time

1. Turn the camera power on.
2. Select the SETUP mode by rotating the mode dial.
3. [SETUP 1/2] menu will be displayed.
4. To shift menu cursor to [SETUP 2/2], press the RIGHT(▶) button.
5. Press the UP(▲)/ DOWN(▼) button and select [DATE SETUP].
6. Press the SET(▶) button and the sub menu will be displayed.

LEFT(◀) / RIGHT(▶) button : you can select year/month/day, hour/minute by pressing these buttons.

UP(▲) button :Increases the number of items

DOWN(▼) button : Decreases the number of items

To confirm the setting, shift the cursor to [MINUTE] and press the SET(▶) button.

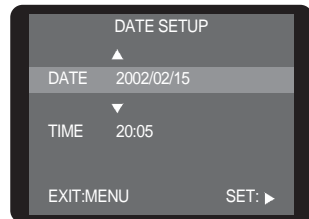
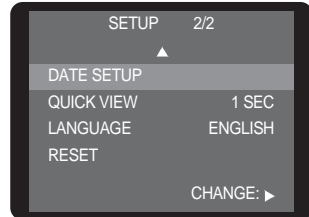
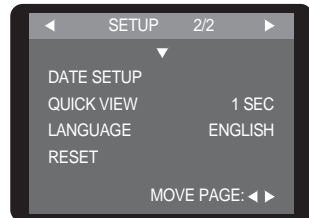

ADVANCED



INFORMATION

- The selection range for date/time setup covers from 2000~2099. (It is automatically programmed to allow for a leap year/ month)



NOTICE

- If the batteries or AC adapter are removed, it is necessary to reset the time /date.
- The Recording date is displayed on the LCD monitor in PLAY mode.(DATE IMPRINT : ON)

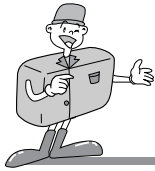

SETUP MODE

QUICK VIEW

- You can briefly review the last image captured.
- You can select the review time from a choice of CANCEL/ 1/ 2/ 3 SEC.

1. Turn the camera power on.
2. Select the SETUP mode by rotating the mode dial.
3. [SETUP 1/2] menu will be displayed.
4. To shift the menu cursor to [SETUP 2/2], press the RIGHT(▶) button.
5. Press the UP(▲)/ DOWN(▼) button and select [QUICK VIEW].
6. Press the SET(▶) button and the sub menu will be displayed.
7. Select the desired review time by pressing the UP(▲)/ DOWN(▼) button.
Press the SET(▶) button to confirm the setting.
8. The default is [1 SEC].

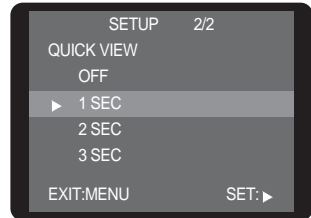
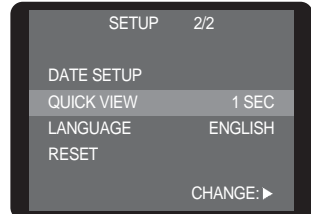



SETUP MODE

LANGUAGE

- There is a choice of languages that can be displayed on the LCD monitor.
- You can select English/ Korean/ German/ French/ Spanish/ Italian/ Taiwanese/ Chinese.

1. Turn the camera power on.
2. Select the SETUP mode by rotating the mode dial.
3. [SETUP 1/2] menu will be displayed.
4. To shift the menu cursor to [SETUP 2/2], press the RIGHT(▶) button.
5. Press the UP(▲)/ DOWN (▼) button and select [LANGUAGE].
6. Press the SET(▶) button and the sub menu will be displayed.
7. Select the desired language by pressing the UP(▲)/ DOWN(▼) button.

Press the SET(▶) button to confirm the setting.

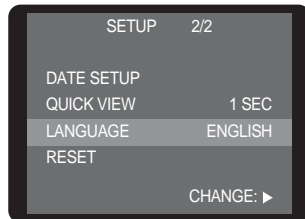

ADVANCED



INFORMATION

- The changed language is maintained until a new language is selected.

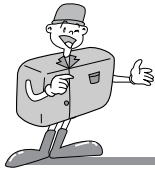

SETUP MODE

RESET

• This menu allows you to reset all the camera settings to the default.

1. Turn the camera power on.
2. Select the SETUP mode by rotating the mode dial.
3. [SETUP 1/2] menu will be displayed.
4. To shift the menu cursor to [SETUP 2/2], press the RIGHT(▶) button.
5. Press the UP(▲)/ DOWN(▼) button and select [RESET].
6. Press the SET(▶) button and the sub menu will be displayed.
7. Select [NO] or [YES] by pressing the UP(▲)/ DOWN(▼) button. Press the SET(▶) button to confirm the setting.
 - [Selecting NO] : The SETUP menu will display without resetting the camera system
 - [Selecting YES] : All the camera settings are changed to the camera default settings.
8. The default is [NO].

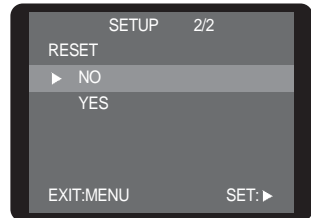
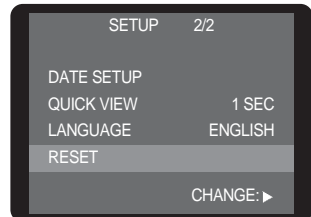
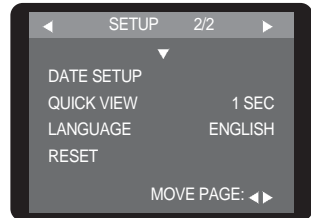



PC MODE

Starting the PC mode

- If you insert the USB cable into a USB connection terminal, the camera working mode will change to the PC mode automatically.
- In this mode, you can download stored images to your PC through the USB cable.
- There is no menu available when the PC mode is selected.
- The camera status LED lamp blinks when the files are transferring via the USB connection.

■ Connecting the camera to a PC

1. Turn the PC power on.
2. Turn the camera power on.
3. Connect the PC and the camera with the USB cable.
 - Insert the small plug of the USB cable to the camera USB connection terminal.
 - Insert the large plug of the USB cable to the USB port of PC
 - The plugs must be firmly inserted.

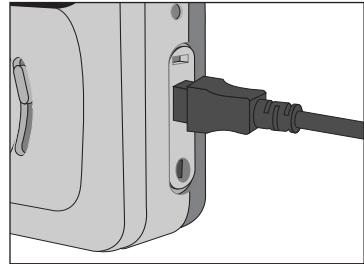

■ Disconnecting the camera and PC

Refer to the following page.

- WIN 98SE : p.94
- WIN 2000/ ME/ XP : p.94



PC MODE



INFORMATION

- The USB Storage Driver must be installed before using the PC mode in Windows 98/ 98SE. Refer to page 87 regarding installation.
- To save battery power, it is recommended that you use an AC adaptor(Optional) when connecting the camera to a computer.

■ Downloading stored images

Once you have downloaded images to your PC, they can be edited and printed.

1. Connect the camera to your PC with the USB cable.
2. On your computer's desktop display, select [My computer] and double click [Removable Disk → Dcim → 100sscsm]. The image files will then be displayed.
 - If the card is inserted, images that are stored on the card will be displayed.
 - If the card is not inserted, images that are stored on the internal memory will be displayed.
 - Use the COPY or MOVE function to download the images to your PC.
 - By using [Digimax Viewer], you can see the stored images in the memory directly on the PC monitor and you can copy or move the image files.
 - Refer to the software part of this manual (p.99) regarding image viewer software installation and usage.
 - If you wish to edit downloaded images, you can use [MGI PhotoSuite III SE].
 - Refer to the software part of this manual (p.106) regarding editing software installation and usage.



IMPORTANT NOTES

Caution!

- ▶ Your new Samsung camera is a precision instrument. Whilst it is designed to withstand general wear and tear, there are some important points that will help you get maximum service and reliability from your camera.
The following should be avoided :
 - Severe changes in temperature and humidity.
 - Dust and dirt.
 - Direct sunlight or the inside of a vehicle in hot weather.
 - Environments where there is high magnetism or excessive vibration.
 - Areas with high explosives or which are highly flammable materials.
 - Pesticides, etc.

- ▶ Sand can be particularly troublesome to cameras.
 - Sand or other small particulates can cause severe malfunctions.
Ensure that there is no contact with sand or similar particles.

- ▶ Extremes in temperature may cause problems.
 - If the camera is transferred from a cold to a warm and humid environment, condensation can form on the delicate electronic circuitry. If this occurs, turn the camera off and wait for at least 1 hour until all moisture is dispersed. Moisture build up can also occur in the CARD. If this happens, turn off the camera and remove the CARD. Wait until the moisture has dispersed.

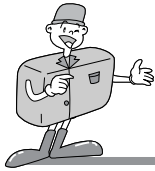

IMPORTANT NOTES

- ▶ If the digital camera is not used for a long period, an electric discharge can occur. It is a good idea to remove the batteries and the CARD, the camera is not used for some time.
- ▶ If the camera is exposed to electronic interference, it will turn itself off to protect the CARD.
- ▶ Maintenance
 - Use a soft brush (available from photo stores) to GENTLY clean the lens and LCD assemblies. If this does not work, lens-cleaning paper with lens cleaning fluid can be used.
 - Clean the camera body with a soft cloth. Do not allow this camera to come into contact with solvent materials such as benzol, insecticide, thinners etc.
This may damage the body shell of the camera and also affect its performance.
 - Rough handling can damage the LCD monitor. Take care to avoid damage and keep the camera in its protective carry case at all times when not in use.
- ▶ DO NOT attempt to disassemble or modify the camera. It contains delicate parts and there are high voltage circuits that can cause electric shocks.
- ▶ Under certain conditions, static electricity can cause the flash unit to fire.
This is not harmful to the camera and is not a malfunction.
- ▶ When images are uploaded or downloaded, the data transfer may be affected by static electricity. In this case, disconnect and re-connect the USB cable before trying the transfer again.

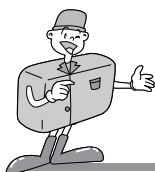

IMPORTANT NOTES

Warning indicator

- There are several warnings that may appear in the LCD display

Warning indicator	Mode	Causes	Remedy
CARD FULL !	STILL IMAGE/ MOVIE CLIP mode	<ul style="list-style-type: none">• There is insufficient memory capacity to take an image.	<ul style="list-style-type: none">• Insert a new CARD or delete stored images to free up some memory.
PROTECT	PLAY mode	<ul style="list-style-type: none">• Protected images can't be deleted.	<ul style="list-style-type: none">• Select [UNLOCK] in the play mode menu.
CARD LOCKED!	STILL IMAGE/ MOVIE CLIP/ PLAY mode	<ul style="list-style-type: none">• The SD memory card is locked	<ul style="list-style-type: none">• Unlock the card.
NO IMAGE!	PLAY mode	<ul style="list-style-type: none">• There are no images stored on the internal memory or the CARD.	<ul style="list-style-type: none">• Take images.• Insert a CARD that is holding some images.
MEMORY ERROR!	STILL IMAGE/ MOVIE CLIP/ PLAY mode	<ul style="list-style-type: none">• Memory error	<ul style="list-style-type: none">• Insert a new card or format the memory.
USB ERROR!	STILL IMAGE/ MOVIE CLIP/ PLAY/ SETUP mode	<ul style="list-style-type: none">• USB error	<ul style="list-style-type: none">• Check the USB connection
A battery indicator blinks!	STILL IMAGE/ MOVIE CLIP/ PLAY mode	<ul style="list-style-type: none">• There is no battery capacity	<ul style="list-style-type: none">• Replace with new batteries
Camera shake warning indicator!	STILL IMAGE mode	<ul style="list-style-type: none">• The flash mode is set to flash off	<ul style="list-style-type: none">• Disengage the FLASH OFF mode (For ordinary shots)• use a tripod (For taking shots in more unusual circumstances (museum, art center))



BEFORE CONTACTING A SERVICE CENTER

Please check the following

Symptom	Causes	Remedy
The camera doesn't switch on	<ul style="list-style-type: none"> • There is low battery capacity • An AC Power Adapter is not connected 	<ul style="list-style-type: none"> • Insert fresh batteries • Connect an AC Power Adapter
The camera powers down whilst in use	<ul style="list-style-type: none"> • The batteries are exhausted • The Camera is turned off automatically due to the Auto power function • The Adapter plug is not connected securely 	<ul style="list-style-type: none"> • Insert fresh batteries • Slide the power switch to reactivate camera • Remove and re-insert the plug
Batteries drain quickly	<ul style="list-style-type: none"> • The Camera is being used in low temperatures • Mixing old and new batteries or battery types 	<ul style="list-style-type: none"> • Keep the camera in warm conditions (i.e. inside a coat or jacket) and only remove it in order to take images • Insert fresh batteries (all of which should be of the same type)
Camera does not take images when pressing the Shutter button	<ul style="list-style-type: none"> • The internal memory is full • The CARD has not been formatted. • The memory is exhausted • The camera power is off • The batteries are exhausted • The mode dial is positioned incorrectly 	<ul style="list-style-type: none"> • After turning the camera off, insert a new card or delete a stored image. • Format the memory • Insert a new card • Turn the camera power on • Insert fresh batteries • Change the camera working mode to the RECORDING mode.
The images are unclear	<ul style="list-style-type: none"> • An Incorrect focus mode is selected. 	<ul style="list-style-type: none"> • Select a correct focus mode related to the distance
The flash does not fire	<ul style="list-style-type: none"> • FLASH OFF mode has been selected 	<ul style="list-style-type: none"> • Disengage FLASH OFF mode
Incorrect date and time is displayed	<ul style="list-style-type: none"> • The date and time have been set incorrectly. 	<ul style="list-style-type: none"> • Reset the date and time correctly (p.71)



BEFORE CONTACTING A SERVICE CENTER

Please check the following

Symptom	Causes	Remedy
The camera buttons do not operate	<ul style="list-style-type: none"> Camera malfunction 	<ul style="list-style-type: none"> Remove /re-insert batteries and switch camera on
The card error	<ul style="list-style-type: none"> Incorrect card format 	<ul style="list-style-type: none"> Re-format the card (p.63)
Color of image different to original scene	<ul style="list-style-type: none"> WHITE BALANCE setting is incorrect 	<ul style="list-style-type: none"> Select appropriate WHITE BALANCE. (p.49)
Images are too bright	<ul style="list-style-type: none"> Exposure is excessive 	<ul style="list-style-type: none"> Reset exposure compensation (p.50)
The play back display is not very clear	<ul style="list-style-type: none"> The lens or LCD monitor is smudged or dirty 	<ul style="list-style-type: none"> Clean the lens or LCD
Date is not displayed on the LCD monitor in the PLAY mode	<ul style="list-style-type: none"> Date imprint function is set to OFF 	<ul style="list-style-type: none"> Switch the Date imprint function ON (p.69)
When using the PC's explorer, 'Removable Disk' file does not show	<ul style="list-style-type: none"> Cable connection is incorrect The camera is off There are no batteries, the batteries are exhausted or the AC adapter is not connected The operating system is not Windows 98, 98SE, 2000, ME, XP/ Mac OS 9.0~10.2. Alternatively the PC does not support USB USB driver is not installed(WIN 98, 98SE only) 	<ul style="list-style-type: none"> Check the connection Turn the camera on Insert new batteries or check the adapter connection Install Windows 98, 98SE, 2000, ME, XP/ Mac OS 9.0~10.2 to PC that supports USB Install "USB Storage Driver"



SPECIFICATIONS

Image Sensor	Type	1/3.2" CCD
	Effective Pixels	Approx. 2.0 Mega pixels
	Total Pixels	Approx. 2.1 Mega pixels
Lens	Focal Length	Samsung Lens f=5.6mm (35mm film equivalent : 43mm)
	F No.	F3.5/F8.0
	Digital Zoom	STILL IMAGE : 2X , PLAY mode : 2X
Viewfinder	Optical Viewfinder	Optical viewfinder
	LCD Monitor	1.6" color TFT LCD
Focusing	Type	Pan focus
	Range	Macro : 0.18~0.25m, Portrait: 0.8~1.3m, normal: 1.3m ~ infinity
Shutter	Type	Mechanical and Electronic shutter
	Speed	1/4 ~ 1/1,000 sec.
Exposure	Control	Program AE
	Compensation	±2EV (0.5EV steps)
	ISO Equivalent	Automatic (100, 200)
Flash	Modes	Auto/ Auto&Red-eye reduction/ Slow sync/ Fill-in flash/ Flash off
	Range	0.8m~3.0m
	Recharging Time	Approx. 10 sec.
White Balance		Auto/ Daylight/ Sunset/ Fluorescent/ Tungsten
Movie Clip		Size : 320x240 Recording time : Memory capacity dependent(10/20/30sec preset available)
Self-timer		10 sec.
Storage	Media	Internal memory : 8MB flash memory
		External memory (optional) : SD / MMC card (up to 256MB Guaranteed)
	File Format	Still image : JPEG(DCF), DPOF Movie Clip : AVI (MJPEG)
	Image Size	L :1600x1200 pixels, M :1280x960 pixels, S :640x480 pixels



SPECIFICATIONS

	Capacity (8/16MB)	<p>L : Super fine 10/20, Fine 18/34, Normal 26/50</p> <p>M : Super fine 15/29, Fine 28/53, Normal 43/85</p> <p>S : Super fine 48/95, Fine 83/172, Normal 153/286</p> <ul style="list-style-type: none"> • These figures are measured under Samsung's standard conditions and may vary depending on shooting conditions and camera settings.
Image Play		Single image/ Thumbnails/ Slide show/Movie clip
Interface		<p>Digital output connector : USB</p> <p>DC power input connector : 3.3V</p>
Power Source		<p>2 x AA alkaline / 2 x Ni-MH batteries</p> <p>AC adapter(Optional)</p>
Dimensions (WxHxD)		94x66x40mm / 3.7x2.6x1.6in
Weight		Approx. 141g/5.0oz (without batteries and card)
Software	Camera Driver	Storage Driver (Windows98/98SE/2000/ME/XP, Mac OS 9.0~10.2)
	Application	MGI PhotoSuite, Digimax Viewer

System Requirements	Digimax 201
For Windows	<p>PC with processor better than MMX Pentium 233MHz (XP : Pentium II 300MHz)</p> <p>Windows 98/98SE/2000/ME/XP</p> <p>Minimum 32MB RAM (XP : 128MB)</p> <p>110MB of available hard-disk space</p> <p>USB port, CD-ROM drive</p> <p>800X600 pixels, 16-bit color display compatible monitor (24-bit color display recommended)</p>
For Macintosh	<p>Power Mac G3 or later</p> <p>Mac OS 9.0~10.2</p> <p>Minimum 64MB RAM</p> <p>110MB of available hard-disk space, USB port</p> <p>CD-ROM drive</p> <p>QuickTime 4.0 or later for Movie Clip</p>

* Specifications are subject to change without prior notice.

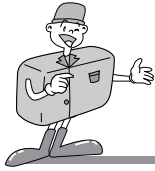

SOFTWARE MANUAL

Software Notes

Please ensure that you read the instruction manual carefully before use.

- The attached software is a camera driver and image editing software tool for Windows.
 - Under no circumstances should all or part of either the software or the user manual be reproduced.
 - Copyright for both software is licensed only for use with a camera.
 - In the unlikely event of a manufacturing fault, we will repair or exchange your camera. We cannot, however, be held responsible in any way for damage caused by inappropriate use.
 - Using a Hand-made PC or a PC that has not been guaranteed by the manufacturer is not covered by the Samsung warranty.
 - Before reading this manual, you should have a basic knowledge of computers and O/S (Operating Systems).
-
- ※ Windows is a registered trademark of Microsoft.
 - ※ Macintosh, Mac is the registered trademark of Apple computer, USA.



SOFTWARE MANUAL

About software

After inserting the CD-ROM provided with this camera into the CD-ROM drive, the following frame is automatically run.

Before connecting the camera to the PC, you should first install the camera driver.

It is not necessary to install the camera driver if your computer runs on Windows 2000/ ME/ XP.

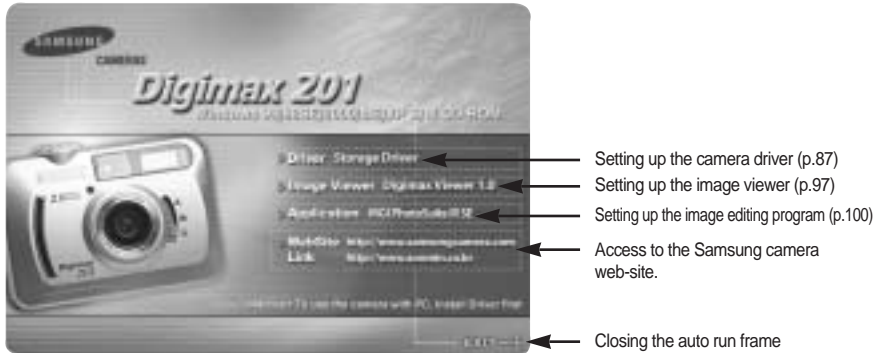

- **Driver Storage Driver** : This enables images to transfer between the camera and PC.

This camera uses the USB Storage Driver as the camera driver.

You can use the camera as a USB card reader. After installing the driver and connecting this camera to the PC, you can find [Removeable Disk] in [Windows Explorer] or [My computer].

A USB Storage Driver is provided only for Windows.

A USB Driver for MAC is not included with the Application CD. But you can use the camera with Mac OS 9.0~10.2.

- Setting up the camera driver for WINDOWS (p.87)

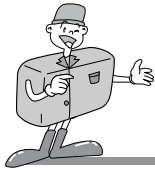

SOFTWARE MANUAL

■ Image Viewer Digimax Viewer 1.0 : Program for viewing a stored image

You can see the stored images in the memory directly on the PC monitor. And you can copy, move, delete the images and scale up /downscale the image sizes with Digimax Viewer.

For windows only.

- Setting up Digimax Viewer (p.97)
- Using Digimax Viewer (p.99)

■ Application MGI PhotoSuite III SE : Image editing program for downloaded images.

For Windows only.

- Setting up MGI PhotoSuite III SE (p.100)
- Using MGI PhotoSuite III SE (p.106)

■ Internet link : You can visit the Samsung web-site through the internet.

- <http://www.samsungcamera.com> : English
- <http://www.samsungcamera.co.kr> : Korean



INFORMATION

- Check the system requirements (p.82) before setting up the driver.
- You should allow 5~10 seconds for running the automatic setup program according to the capability of the computer. If the frame does not show, run the [Windows Explorer] and select [Camera.exe] in the CD-ROM Drive root directory.



SOFTWARE MANUAL

Setting up the USB driver for Windows 98SE

To use this camera with a PC, install the Camera Driver first. After this has been done, the stored images in the camera can be moved to the PC and can be edited by an image editing program. Before connecting the camera to the PC, you should first install the camera driver. It is not necessary to install the camera driver if your computer runs on Windows 2000/ ME/ XP.

1. Click [Storage Driver] menu (p.85) on the Autorun frame.

[Click!]



2. A [Welcome] window will open. Click the [Next>] button.

[Click!]

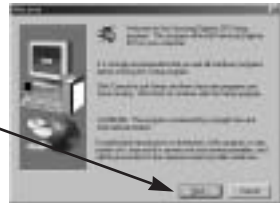

3. Installation is complete. Click the [Finish] button and the [Microsoft DirectX8.1 Setup] window will open to install DirectX8.1

[Click!]





SOFTWARE MANUAL

Setting up DirectX 8.1

DirectX is a windows technology that enables higher performance in graphics and sound when you're playing games or watching video on your PC.

1. After driver installation, [Microsoft DirectX 8.1 Setup] window will open automatically. Click [Yes].

[Click!]

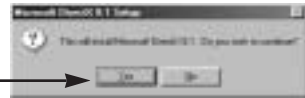

2. The software license agreement window will open.

If you agree to it, click [Yes]. This will take you to the next step. If you disagree, click [No] and the installation program will be canceled.



3. Installation is complete.

Click the [OK] button and the PC will restart.





SOFTWARE MANUAL

4. After restarting the computer, connect the PC to the camera with the USB cable.
5. Turn the camera power on. [Found New Hardware Wizard] will open and the computer will recognize the camera.

* If you have ever installed an image viewer program, the program will open. If the image viewer program opens, the camera driver was setup successfully.



6. If you can see [Removable Disk] under [My computer], the camera driver installation is successful. Now you can transfer image files from the camera to PC via the USB cable.



INFORMATION

- If you have installed the camera driver, [Found New Hardware Wizard] may not open.
- After the [Found New Hardware Wizard] window opens, a window may open to select the camera driver file location.

In this case, select [C:\WINDOWS\INF\OTHER] folder. If you can't find [INF\OTHER] folder, check [Show all files] button in [Window's Explorer → View → Folder option → View].

- It is recommended that you use an AC adaptor(Optional) when connecting the camera to a computer.



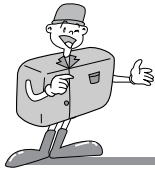

SOFTWARE MANUAL



INFORMATION

- Before connecting the camera to the PC, You should install the camera driver first.
- After installing the camera driver, you have to restart your PC.
- If you connect the camera to the PC before installing the camera driver, the [Found New Hardware Wizard] will open. In this case, cancel the [Found New Hardware Wizard] and disconnect the connection. Install the camera driver and connect the camera and PC again.
- Should the computer not find the camera driver after installation, please try one or more of the following measures.
 1. Delete the camera driver (p.91), and re-install the driver.
 2. Refer to FAQ (p.118) to check for a possible solution to the problem.
 3. If your PC's central processing unit is VIA chip(This is shown in the USB Host Controller), download the patch file from the Samsung Camera web page.
(<http://www.samsungcamera.com>)

- To view an image that is stored in the camera, install Digimax Viewer (p.97).
- To edit an image that is downloaded to PC, install PhotoSuite III SE (p.100).



SOFTWARE MANUAL

Removing the USB Driver for Windows

1. Trace [Start →Setting] and double-click [Controller]



2. Double-click [Add/Remove programs].





SOFTWARE MANUAL

3. The [Add/Remove Programs Properties] window will open. Click [Samsung Digimax 201] and click [Add/Remove] button.

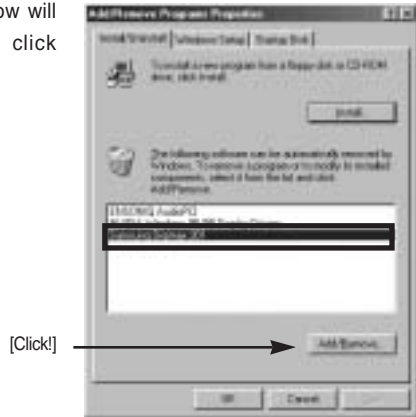

4. To uninstall the camera driver, click the [Yes] button.

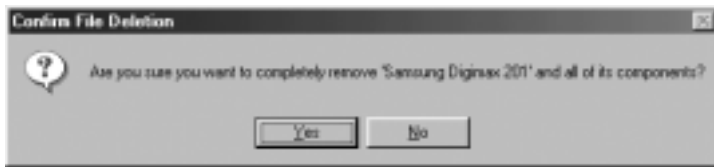

5. Press [OK] button.





SOFTWARE MANUAL

Removable Disk

To use this camera as a Removable Disk, install(p.87) the USB Driver.

1. Before turning the camera power on, connect the camera to the PC with the USB cable.
2. Click [Removable Disk] under [My computer] or [Windows Explorer].
3. Image files stored in the Removable Disk(Dcim → 100sscam) can be transferred to the PC.



NOTICE

Important information whilst using the Removable Disk

- The [Removable Disk] indicator will not show when the camera power is off.
- We recommend that you should copy the images to the PC to view them. Opening images directly from the removable disk may be subject to unexpected disconnection.
- When uploading images from the PC to the camera, ensure that the uploaded file names are not the same as those already stored on the memory.
- When you upload a file that is not taken by this camera to Removable Disk, the ERROR FILE message will be displayed on the LCD monitor in the PLAY mode, and nothing is displayed in THUMBNAIL mode.
- The green lamp next to the viewfinder will blink, when a file is transferred (copy or deletion) between the PC and the camera. Do not remove the USB cable until the lamp stops blinking. To remove the USB cable in Windows 2000/ME/XP, use the [Unplug or Eject Hardware] icon on the task bar.

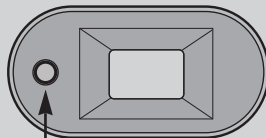

[Green lamp]

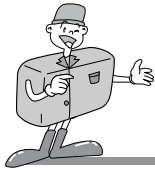

SOFTWARE MANUAL

Removing the removable disk

■ Windows 98SE

1. Check whether the camera and PC are transferring a file. If the green camera status LED (next to viewfinder) blinks, you have to wait until the LED is off.
2. Unplug the USB cable.

■ Windows 2000/ME/XP

1. Check whether the camera and PC are transferring a file. If the green camera status LED (next to viewfinder) blinks, you have to wait until the LED is off.
2. Double-click the [Unplug or Eject Hardware] icon on the task bar.



[Double-click]

3. The [Unplug or Eject Hardware] window will open. Select the [Samsung USB Mass Storage Device] and click the [Stop] button.



[Click!]



SOFTWARE MANUAL

4. The [Stop a Hardware device] window will open. Select the [Samsung D-201 USB Device] and click the [OK] button.

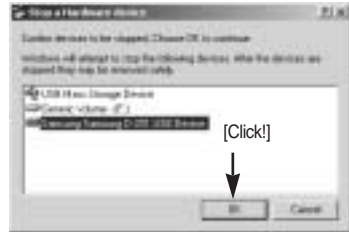

5. A [Safe to Remove Hardware] window will open. Click the [OK] button.



6. A [Unplug or Eject Hardware] window will open. Click the [Close] button and the removable disk will be removed safely.



7. Unplug the USB cable.

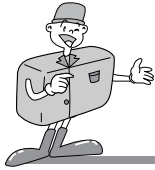

SOFTWARE MANUAL

Setting up the USB Driver for MAC

1. A USB Driver for MAC is not included with the Application CD as MAC OS support the camera driver.
2. Check the MAC OS. You can check the MAC OS version during MAC OS start-up.
This camera is compatible with MAC OS 9.0-10.2.
3. Connect the camera to the Macintosh and turn the camera power on in PC mode.
4. A new icon (Untitled) will be displayed on the desktop after connecting the camera to the MAC.

Using the USB Driver for MAC

1. Double click a new icon (Untitled) on the desktop and the folder in the memory will be displayed.
2. Select an image file and copy or move it to MAC.



NOTICE

If you use Mac OS 10.0 or later, you may experience happening an error when you transfer files from the PC to the camera.



SOFTWARE MANUAL

Setting up Digimax Viewer

This software is only compatible with Windows.

1. Click [Digimax Viewer 1.0] on the Autorun frame.



2. An installation window will be displayed as shown alongside. Click [Next].

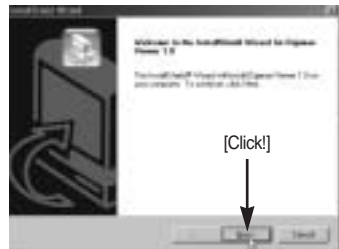

3. The Software License Agreement window will display. If you agree to it, click [Yes]. This will take you to the next step. If you disagree, click [No] and the installation program will be canceled.



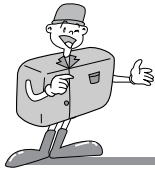

SOFTWARE MANUAL

4. Select a destination folder and click [Next].

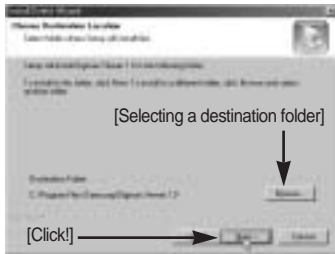

5. Select the Program folder and click [Next].

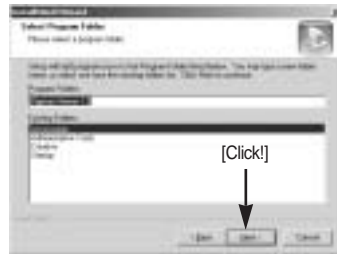

6. Installation is completed. If you wish to open this program automatically whenever the camera is connected to the PC, click the [I would like to launch Digimax Viewer] Checkbox. And click [Finish].

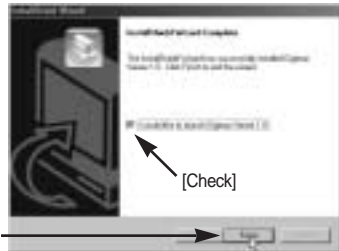

7. Digimax Viewer will start. Click the Exit button to finish the program.



To edit a downloaded image, set up MGI PhotoSuite III SE (p.100)



SOFTWARE MANUAL

Digimax Viewer

This software is only compatible with Windows.

To open Digimax Viewer, click the [Start → Programs → Samsung Digimax Viewer 1.0 → Digimax Viewer 1.0] and Digimax Viewer 1.0 will then open.

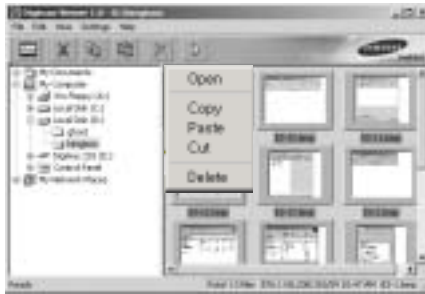

Select an image and press the right mouse button. A pop-up menu will open.

Open : allows you to view a selected sequence of images, one at a time.

Copy : copies files. After copying a file, select a folder where you want to paste the copied file. Click the right mouse button and a pop-up menu will open. Select [Paste] and the copied file is pasted.

Paste : pastes a copied file

Cut : cuts a selected file.

Delete : deletes a selected file

If the Auto Launch option is selected, this program will be executed automatically with recognizing the camera.

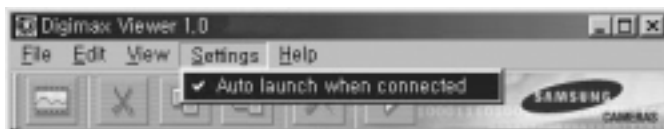

※ Refer to the [Help] menu in Digimax viewer about further information.

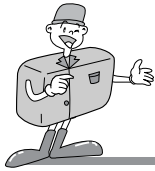

SOFTWARE MANUAL

Setting up MGI PhotoSuite III SE

This software is only compatible with Windows.

1. Click the MGI PhotoSuite III SE menu on the autorun frame.

[Click!]



2. The [Choose Setup Language] window will open. Select language.

[Click!]

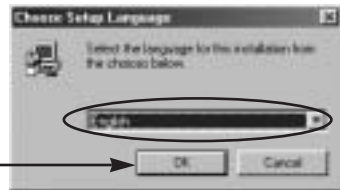

3. A [Welcome] window will be displayed. Click [Next>] to move to the next step.

[Click!]

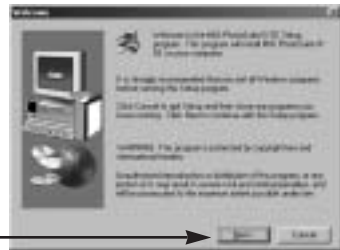



SOFTWARE MANUAL

4. The Software License Agreement window will be displayed. If you agree to this, click [Yes], the window will then move to the next step. If you disagree, click [No] and the install program will be canceled.



5. A [Setup Type] window will open. Select setup type and click [Next >] button.

- Full : the program will be installed with all the options.
- Custom : you can choose what you would like to install.



6. If installation is completed correctly, Autoplay is registered automatically into the start menu program as shown alongside.

Click [Next>] button.



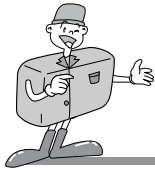

SOFTWARE MANUAL

7. The MGI Registration window will be displayed. Click the [Continue] button.



↑
[Click!]

8. The [Online Registration Utility] window will be displayed. Fill in the blanks and click the [Register] button.

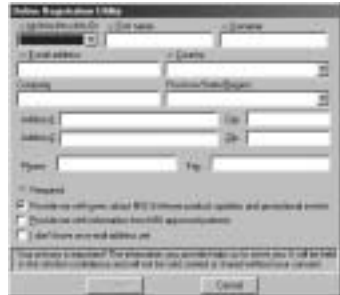

9. Installation is complete. Click the [Finish] button.

*A [Read me] file will open.

Click [Close button] to close the file.



↑
[Click!]



SOFTWARE MANUAL

MGI PhotoSuite III SE

This software is only compatible with Windows.

To open MGI PhotoSuite III SE, click the [Start → Programs → MGI PhotoSuite III SE → MGI PhotoSuite III SE] and MGI PhotoSuite III SE will then open.











SOFTWARE MANUAL

MGI PhotoSuite III SE functions

- An introduction to the Welcome screen









	<p>Get</p> <p>Get images.</p>
	<p>Prepare</p> <p>A number of photo editing activities can be performed within this module.</p>
	<p>Compose</p> <p>Use your photos in a variety of fun, creative and interesting ways.</p>
	<p>Organize</p> <p>Organize your photos and other media files into albums.</p>
	<p>Share</p> <p>Save your results to show to others.</p>
	<p>Print</p> <p>Print hard copies of photos and projects.</p>

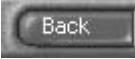

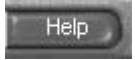
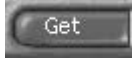
SOFTWARE MANUAL

■ Introduction to navigation bar

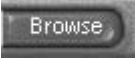

	Back Return to the previous step.
	Home Return to Welcome screen.
	Help Display help window.
	Get Get images.
	Prepare A number of photo editing activities can be performed within this module.
	Compose Use your photos in a variety of fun and interesting ways.
	Organize Organize your photos and other media files into albums.
	Share Save your results to show to others.
	Print Print hard copies of photos and projects.
	Browse Browse the web site.



SOFTWARE MANUAL

Using MGI PhotoSuite III SE

GET

■ To obtain images from the computer

1. To acquire images, Click the large [Get] button on the Welcome screen, or the [Get] button on the Navigation bar. Click [Computer] from the list of options displayed on the activity panel.



2. The Open file selector is displayed. Now select the image file and click [open].



3. The Welcome screen will change to the next work step, with the selected image displayed.

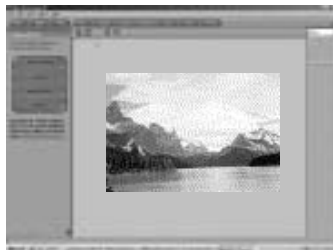



SOFTWARE MANUAL

■ When you obtain images from the digital camera.

Before transferring an image file, check the USB connection.

1. To acquire images, click the large [Get] button on the Welcome screen, or the [Get] button on the Navigation bar. Click [Computer] from the list of options displayed on the activity panel.



2. The Open file selector is displayed. Click [Look in :] to choose [Removable Disk(:)] and click [open] for the open file window to be displayed.



3. Select the [Dcim -> 100sscarn] folder. Then select an image and click [Open].



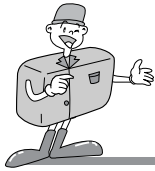

SOFTWARE MANUAL

4. The Welcome screen will change to the next work step, with the selected image displayed.



Note

When you use the Digimax camera, only [Computer] and [Album] from the list of options displayed are available. You will be able to obtain images from the digital camera.



[Computer and Album Only]



SOFTWARE MANUAL

■ Acquiring images from an Album.

1. To acquire images, click the large [Get] button on the Welcome screen, or the [Get] button on the Navigation bar. Click [Album] from the list of options displayed on the activity panel.



2. After selecting Album on the [1]Choose a photo album], click an image in the album and click [Open].



3. The Welcome screen will change to the next work step, with the selected image displayed.

※ Refer to page 113 for more information about creating an Album.



SOFTWARE MANUAL

PREPARE

When the image is loaded, the step changes to Prepare automatically.

■ Menu of [PREPARE] steps

Rotate & Crop

You can rotate, flip or crop images along with a host of others.



Touchup

Remove Red eye, Remove Scratches etc.. are available in this menu.

Special Effects

A number of special effects can be applied.

Stitching

Join a series of photos together to create a sweeping panoramic effect.



SOFTWARE MANUAL

COMPOSE

Add text, Compound Images etc. are available in this step.

■ Menu of [COMPOSE] steps

- Collages** : A collage consists of several photos or sections of photos arranged together on a common background.
- Photo Layouts** : The Photo Layouts activity includes many collage and layout options.
- Cards & tags** : Use your photos to create items such as Gift Tags, Greeting Cards, Invitations, Postcards, and Sports Cards.
- Calendars** : Use your photos to create a variety of calendars (monthly, quarterly, seasonal, yearly).
- Collections** : Photos can also be used to create a variety of items for business purposes.
- Fun stuff** : You can make magazine covers, Backgrounds, etc. in this menu.
- Business** : You can make business items such as business cards, certificates, signs, labels, promotions, name tags, stationary
- Frames & Edges** : Add frames and edge effects to your photos according to predefined templates.



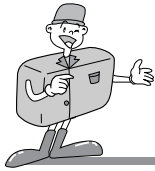

SOFTWARE MANUAL

ORGANIZE

Organize your photos and other media files into albums.

■ Menu of [ORGANIZE] steps

[① Choose a photo album to view or edit]

Select Album : To create an Album, click [Organize] in the welcome screen or navigation bar.

Album... : Open Master Album.

[② Select a photo, and choose an action below.]

- Open : Open selected image.
- Delete : Delete selected image.
- Properties... : view image information.

[③ Choose an action to manage your album.]

- Add : click [Add] to add an image to an Album.
- Sort : click [Sort] to Sort saved images.
- Search : click [Search] to Search saved images.
- Reset : click [Reset] to reset the setting.
- Update : click [Update] to update images.
- Create Slide Show : click [Create Slide Show] to create a Slide Show.

Always start on this page : If you select this option, the program will start in [Organize].

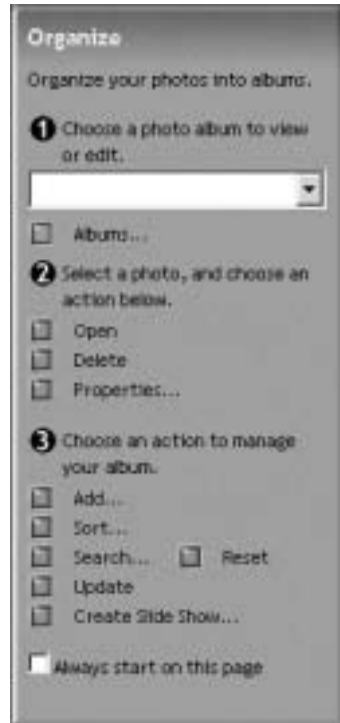



SOFTWARE MANUAL

■ Creating an Album

1. To create an Album, click the large Organize button on the Welcome screen, or the Organize button on the Navigation bar.
2. Click [Album..] in [①Choose a photo album to view or edit.]
3. The Master Album window will be displayed, then click [New..].
4. Put a new Album name in the New Album window and click [OK]. A new album will now be created.
5. [Master Album] window will open. Click [OK] button.





SOFTWARE MANUAL

■ Add images to the album

1. Select [③Choose an action to manage your album. → Add..] to add images to the album.

[Click!]

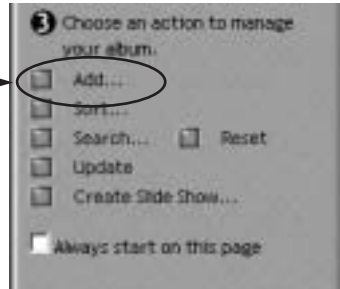

2. Click [Computer] in Add Photos menu.

[Click!]



NOTICE

[Digital Camera(Direct)], [Scanner(TWAIN)], [Digital Camera(TWAIN)] sources can't be used.



SOFTWARE MANUAL

3. [Add photo to Album] window will open. Select images that you want to add. Click [Add] button.



↑
[Click!]

4. Adding images is complete.





SOFTWARE MANUAL

SHARE

Saving or sharing images.

■ Menu of [SHARE] step

Save

To save the active file according to its current name and path.

Save As

To assign a new name or path to the file.

Send E-mail

e-mailing images.

Slide Show

Viewing images as a slide show.





SOFTWARE MANUAL

PRINT

You can print images.

■ Menu for the [PRINT] step

Print

Printing images.

Print Multiples

Print multiple copies of a photo or project, or one copy of each of the photos included in an album, according to a predefined template.

- * Choose a printer, an orientation, the print size, and the number of copies. You can then print the images.



Reference

For more information, please refer to the Help file in [Help MGI PhotoSuite III help].



FAQ

About USB

Please check the following if the USB connection malfunctions.

- [Case 1] The camera power is off.
→ Turn the camera power on. We recommend using an AC power adapter in PC mode. If you use batteries, check the battery condition.
- [Case 2] USB Driver is not installed correctly.
→ Install the USB Driver correctly. Refer to pages 87.
- [Case 3] The USB cable is not connected or you are using a cable with an incorrect specification.
→ Use a USB cable with the correct specification.
- [Case 4] Occasionally the computer recognizes the USB as another device.
→ Install the camera driver correctly. Turn the camera power off and remove the USB cable.
Connect the USB cable again and turn the camera power on. The computer should now recognize the camera.
- [Case 5] There is an unexpected error during file transfer.
→ Turn the camera power off and on again. Transfer the file again.



FAQ

About USB

[Case 6]

How do I know my computer supports a USB Interface?

- Check the USB port in your computer or keyboard.
 - Check OS version. USB Interface is available in Windows 98, 98SE, 2000, ME .XP.
 - Check [Universal serial bus controller] in Device Manager. Do the following to check [Universal serial bus controller].
Win 98/ME : Trace [Start → Setting → Controller → System → Device Manager → Universal serial bus controller]
 - Win 2K : Trace [Start → Setting → Controller → System → Hardware Device Manager Universal serial bus controller].

 - Win XP : Trace [Start → Control Panel → Performance and Maintenance → System → Hardware Device Manager → Universal Serial Bus controller].
- There must be USB Host Controller and USB root hub under [Universal serial bus controller].
- When all the conditions mentioned above are met, the computer can support the USB interface.

[Case 7]

When using USB hub.

- There may be a problem in connecting the camera to the PC through the USB hub if the PC and the hub are not compatible. Wherever possible, connect the camera to the PC directly.

[Case 8]

Are other USB cables connected to the PC?

- The camera may malfunction when it is connected to the PC at the same time as another USB cable.. In this case, disconnect the other USB cable, and connect only one USB cable to the camera.



SAMSUNG TECHWIN CO., LTD.
OPTICS & DIGITAL IMAGING DIVISION
145-3, SANGDAEWON 1-DONG, JUNGWON-
GU, SUNGNAM-CITY, KYUNGKI-DO, KOREA 462-121
TEL : (82) 31-740-8086, 8088, 8090, 8092, 8099
FAX : (82) 31-740-8398, 8111

SAMSUNG OPTO-ELECTRONICS AMERICA, INC.
HEADQUARTERS
40 SEAVIEW DRIVE, SECAUCUS, NJ07094, U.S.A.
TEL : (1) 201-902-0347
FAX : (1) 201-902-9342

WESTERN REGIONAL OFFICE
18600 BROADWICK ST.,
RANCHO DOMINGUEZ, CA 90220, U.S.A.
TEL : (1) 310-537-7000
FAX : (1) 310-537-1566

SAMSUNG OPTO-ELECTRONICS UK LTD.
SAMSUNG HOUSE, 3 RIVERBANK WAY,
GREAT WEST ROAD, BRENTFORD,
MIDDLESEX, TW8 9RE, U.K.
TEL : (44) 20-8232-3280
FAX : (44) 20-8569-8385

SAMSUNG OPTO-ELECTRONICS GMBH
AM KRONBERGER HANG 6
D-65824 SCHWALBACH/TS., GERMANY
TEL : (49) 6196 66 53 03
FAX : (49) 6196 66 53 66

SAMSUNG FRANCE S.A.S.
BP 51 TOUR MAINE MONTPARNASSE
33, AV .DU MAINE
75755, PARIS CEDEX 15, FRANCE
HOTLINE PHOTO NUMÉRIQUE : (33) 1-44757389
TEL : (33) 1-4279-2282/5
FAX : (33) 1-4320-4510

SAMSUNG TECHWIN MOSCOW OFFICE
KORP. 14 37-A LENNINGRADSKY PRO-KT
MOSCOW, 125167, RUSSIA
TEL : (7) 095-258-9296, 9298, 9299
FAX : (7) 095-258-9297

TIANJIN SAMSUNG OPTO-ELECTRONICS CO., LTD.
7 PINGCHANG ROAD NANKAI DIST., TIANJIN
P.R CHINA
POST CODE: 300190
TEL : (86) 22-2761-8867
FAX : (86) 22-2761-8864

* Internet address - [http : //www.samsungcamera.com/](http://www.samsungcamera.com/)



The CE Mark is a Directive conformity
mark of the European Community (EC)

6806-1400

Free Manuals Download Website

<http://myh66.com>

<http://usermanuals.us>

<http://www.somanuals.com>

<http://www.4manuals.cc>

<http://www.manual-lib.com>

<http://www.404manual.com>

<http://www.luxmanual.com>

<http://aubethermostatmanual.com>

Golf course search by state

<http://golfingnear.com>

Email search by domain

<http://emailbydomain.com>

Auto manuals search

<http://auto.somanuals.com>

TV manuals search

<http://tv.somanuals.com>