

**SAMSUNG**



**SAMSUNG Inkjet Telephone Fax User's Guide**

**SF-370 series**

# Important Precautions and Safety Information

When using this fax machine, these basic safety precautions should always be followed to reduce risk of fire, electric shock, and injury to persons:

- 1** Read and understand all instructions.
- 2** Use common sense whenever operating electrical appliances.
- 3** Follow all warnings and instructions marked on the product and in the literature accompanying the product.
- 4** If an operating instruction appears to conflict with safety information, heed the safety information. You may have misunderstood the operating instruction. If you cannot resolve the conflict, contact your sales or service representative for assistance.
- 5** Unplug the fax machine from the AC wall socket and telephone jack before cleaning. Do not use liquid or aerosol cleaners. Use only a damp cloth for cleaning.
- 6** Do not place the fax machine on an unstable cart, stand, or table. It may fall, causing serious damage.
- 7** Your fax machine should never be placed on, near, or over a radiator, heater, air conditioner, or ventilation duct.
- 8** Do not allow anything to rest on the power or telephone cords. Do not locate your fax machine where the cables may be damaged by people walking on them. Do not place the machine where the power or telephone cord may be bent. Any case of above may cause the hazardous result or malfunction.
- 9** Do not overload wall outlets and extension cords. This can diminish performance, and may result in the risk of fire or electric shock.
- 10** Do not allow pets to chew on the AC power, telephone, or PC interface cords.
- 11** Never push objects of any kind into the fax machine through case or cabinet openings. They may touch dangerous voltage points, creating a risk of fire or shock. Never spill liquid of any kind onto or into the fax machine.
- 12** To reduce the risk of electric shock, do not disassemble the fax machine. Take it to a qualified service technician when repair work is required. Opening or removing covers may expose you to dangerous voltages or other risks. Incorrect reassembly could cause electric shock when the unit is subsequently used.

- 13** Unplug the machine from the telephone jack, PC, and AC wall outlet, and refer servicing to qualified service personnel under the following conditions:
- *When any part of the power cord, plug, or connecting cable is damaged or frayed.*
  - *If liquid has been spilled into the product.*
  - *If the product has been exposed to rain or water.*
  - *If the product does not operate properly after instructions have been followed.*
  - *If the product has been dropped, or the cabinet appears damaged.*
  - *If the product exhibits a sudden and distinct change in performance*
- 14** Adjust only those controls covered by the operating instructions. Improper adjustment of other controls may result in damage, and may require extensive work by a qualified service technician to restore the product to normal operation.
- 15** Avoid using this fax machine during a lightning storm. There may be a remote risk of electric shock from lightning. If possible, unplug the AC power and telephone for the duration of the lightning storm.
- 16** Do not install the machine on a wet place. This may raise a risk of fire or shock.
- 17** CAUTION: For electrical safety reasons disconnect from telecommunications network before touching metal/conductive parts.
- 18** CAUTION: To reduce the risk of fire, use only No.26 AWG or larger telecommunication line cord.
- 19** CAUTION: Use only the cords and other accessories supplied with the product. Using others may cause the hazardous result or malfunction.
- 20** SAVE THESE INSTRUCTIONS.

# Contents

## Chapter 1: Setup and Copying

|  |     |
|--|-----|
| List of features .....                             | 1.2 |
| Familiarizing yourself with your new machine ..... | 1.3 |
| Front view .....                                   | 1.3 |
| Rear view .....                                    | 1.3 |
| Control Panel .....                                | 1.4 |
| Loading paper .....                                | 1.5 |
| Paper type and sizes .....                         | 1.5 |
| Making a copy .....                                | 1.6 |
| Setting date and time .....                        | 1.6 |
| Setting fax number/name .....                      | 1.7 |
| How to enter letters .....                         | 1.7 |
| Copying/receiving in Ink Save mode .....           | 1.8 |
| Adjusting ring volume .....                        | 1.8 |
| Adjusting speaker volume .....                     | 1.8 |

## Chapter 2: Programming and Dialling

|   |     |
|---|-----|
| Making a phone call .....                                 | 2.2 |
| Speaker Phone dialling .....                              | 2.2 |
| Phone book dialling .....                                 | 2.2 |
| Storing a number in the Phonebook .....                   | 2.2 |
| Editing a number in the Phonebook .....                   | 2.3 |
| One-Touch dialling .....                                  | 2.3 |
| Speed dialling .....                                      | 2.3 |
| Deleting a number in the Phonebook .....                  | 2.4 |
| Redialling .....  | 2.4 |
| To redial the last number called .....                    | 2.4 |
| To redial the number in memory .....                      | 2.4 |
| To find a number received via the Caller ID service ..... | 2.4 |

## Chapter 3: The Fax Machine

|  |     |
|--|-----|
| Sending a fax .....                            | 3.2 |
| Loading documents .....                        | 3.2 |
| Acceptable documents .....                     | 3.2 |
| Setting document resolution and contrast ..... | 3.3 |
| Sending a fax manually .....                   | 3.3 |
| Sending a fax automatically .....              | 3.3 |
| Automatic redial .....                         | 3.4 |
| Receiving a fax .....                          | 3.4 |
| Reception modes .....                          | 3.4 |
| Receiving in FAX mode .....                    | 3.5 |
| Receiving in TEL mode .....                    | 3.5 |
| Receiving in AUTO mode .....                   | 3.5 |
| Receiving in TAM mode (SF-375TP only) .....    | 3.5 |
| Receiving in DRPD mode .....                   | 3.6 |

## Chapter 4: The Answering Machine

|   |     |
|---|-----|
| Recording your TAM message .....                  | 4.2 |
| Checking your TAM message .....                   | 4.2 |
| Monitoring an incoming call .....                 | 4.2 |
| Playing back messages .....                       | 4.3 |
| Playing back newly received caller messages ..... | 4.3 |
| Playing back all messages .....                   | 4.3 |
| Skipping backward or forward .....                | 4.3 |
| Erasing old messages you've heard .....           | 4.4 |
| To erase a selected message .....                 | 4.4 |

|   |     |
|---|-----|
| To erase all recorded messages .....                  | 4.4 |
| Using the answering machine from a remote phone ..... | 4.5 |
| Accessing the machine .....                           | 4.5 |
| Using remote commands .....                           | 4.5 |

## Chapter 5: Advanced Fax

|  |     |
|--|-----|
| Broadcasting .....                                     | 5.2 |
| Delayed fax .....                                      | 5.2 |
| Using My Favorites .....                               | 5.3 |
| Saving documents .....                                 | 5.3 |
| Deleting stored documents .....                        | 5.3 |
| Sending stored documents .....                         | 5.3 |
| Printing stored documents .....                        | 5.3 |
| Polling .....  | 5.4 |
| Setting send polling .....                             | 5.4 |
| Setting receive polling .....                          | 5.4 |
| To cancel the scheduled job .....                      | 5.4 |
| Forwarding a fax or message .....                      | 5.5 |
| Fax forwarding .....                                   | 5.5 |
| Message forwarding (SF-375TP only) .....               | 5.5 |
| Received fax remote notification (SF-375TP only) ..... | 5.6 |

## Chapter 6: Special Features

|   |     |
|---|-----|
| Inserting a pause .....                         | 6.2 |
| Using Caller ID .....                           | 6.2 |
| Using the Mute .....                            | 6.2 |
| To mute a call .....                            | 6.2 |
| To release the mute .....                       | 6.2 |
| Recording a conversation (SF-375TP only) .....  | 6.3 |
| Sound setup .....                               | 6.3 |
| User reports .....                              | 6.4 |
| To print a report .....                         | 6.4 |
| Re-Printing faxes .....                         | 6.5 |
| Registering/deleting the junk fax numbers ..... | 6.5 |
| Entering junk fax setup mode .....              | 6.5 |
| Using Short Message Service (SMS) .....         | 6.6 |
| Reading SMS messages .....                      | 6.6 |
| Sending SMS messages .....                      | 6.6 |
| Printing SMS messages .....                     | 6.7 |
| Deleting stored SMS messages .....              | 6.7 |
| Setup SMS messages .....                        | 6.7 |
| .....   | 6.8 |
| Clearing memory .....                           | 6.9 |
| User options .....                              | 6.9 |
| Setting system/TAM options .....                | 6.9 |

## Chapter 7: Using Printing

|                                   |     |
|-----------------------------------|-----|
| Making Connection .....           | 7.2 |
| Installing Printer Software ..... | 7.2 |
| System Requirements .....         | 7.2 |
| Installing Printer Software ..... | 7.2 |
| Setting the default printer ..... | 7.4 |
| Reinstalling Software .....       | 7.4 |
| Removing Printer Software .....   | 7.5 |
| Printing a Document .....         | 7.5 |
| Cancelling a Print Job .....      | 7.7 |
| Using Help .....                  | 7.7 |

## Chapter 8: Care and Maintenance

|   |      |
|---|------|
| Cleaning the document scanner .....           | 8.2  |
| Replacing the print cartridge .....           | 8.3  |
| Cleaning the printhead .....                  | 8.4  |
| Aligning the printhead .....                  | 8.4  |
| Ink level view .....                          | 8.4  |
| Shading adjustment .....                      | 8.4  |
| Self testing .....                            | 8.5  |
| Print cartridge maintenance .....             | 8.5  |
| Cleaning the cartridge .....                  | 8.5  |
| Wiping the print nozzles and contacts .....   | 8.5  |
| Cleaning the cartridge carrier contacts ..... | 8.6  |
| LCD error messages .....                      | 8.7  |
| Fixing Problems .....                         | 8.10 |
| Fax problems .....                            | 8.10 |
| Print quality problems .....                  | 8.11 |
| Paper feeding problems .....                  | 8.11 |
| Clearing jams .....                           | 8.12 |
| Document jams during transmission .....       | 8.12 |
| Paper jams during printing .....              | 8.12 |

## Chapter 9: Appendix

|  |      |
|--|------|
| Specifications .....   | 9.2  |
| General specifications .....   | 9.2  |
| Printer specifications (SF-371P and SF-375TP only) .....                         | 9.2  |
| Scanner and copier specification .....   | 9.3  |
| Facsimile specifications .....   | 9.3  |
| A sample of ITU #1 chart (reduced to 60.5%) .....                                | 9.4  |
| Font List for Print .....  | 9.5  |
| Font List for LCD .....  | 9.6  |
| Replacing the fitted plug (UK) .....   | 9.7  |
| Notes for use of this device (New Zealand) .....                                 | 9.7  |
| Declaration of conformity (European countries) .....                             | 9.8  |
| In case of interference (US) .....   | 9.10 |
| Fax branding (US) .....  | 9.10 |
| Telephone company information (US) .....   | 9.11 |
| Correct Disposal of This Product (Waste Electrical & Electronic Equipment) ..... | 9.12 |

## Index

# Contact SAMSUNG WORLD WIDE

If you have any comments or questions regarding Samsung products, contact the SAMSUNG customer care center.

| Country        | Customer Care Center  | Web Site                     |
|----------------|---|------------------------------|
| ARGENTINE      | 0800-333-3733   | www.samsung.com/ar           |
| AUSTRALIA      | 1300 362 603  | www.samsung.com/au           |
| AUSTRIA        | 0800-SAMSUNG (726-7864)   | www.samsung.com/at           |
| BELGIUM        | 0032 (0)2 201 24 18   | www.samsung.com/be           |
| BRAZIL         | 0800-124-421<br>4004-0000   | www.samsung.com/br           |
| CANADA         | 1-800-SAMSUNG (7267864)   | www.samsung.com/ca           |
| CHILE          | 800-726-7864 (SAMSUNG)  | www.samsung.com/cl           |
| CHINA          | 800-810-5858<br>010- 6475 1880  | www.samsung.com.cn           |
| COLOMBIA       | 01-8000-112-112   | www.samsung.com/co           |
| COSTA RICA     | 0-800-507-7267  | www.samsung.com/latin        |
| CZECH REPUBLIC | 844 000 844<br>Distributor pro Ěeskou republiku : Samsung Zrt., ěeska organizaění sloŕka Vyskoěilova 4, 14000 Praha 4 | www.samsung.com/cz           |
| DENMARK        | 70 70 19 70   | www.samsung.com/dk           |
| ECUADOR        | 1-800-10-7267   | www.samsung.com/latin        |
| EL SALVADOR    | 800-6225  | www.samsung.com/latin        |
| ESTONIA        | 800-7267  | www.samsung.ee               |
| KAZAHSTAN      | 8-10-800-500-55-500   | www.samsung.kz               |
| KYRGYZSTAN     | 00-800-500-55-500   |                              |
| FINLAND        | 030-6227 515  | www.samsung.com/fi           |
| FRANCE         | 3260 SAMSUNG or<br>08 25 08 65 65 (€0,15/min)   | www.samsung.com/fr           |
| GERMANY        | 01805 - 121213<br>(€0,14/min)   | www.samsung.de               |
| GUATEMALA      | 1-800-299-0013  | www.samsung.com/latin        |
| HONG KONG      | 3698 4698   | www.samsung.com/hk           |
| HUNGARY        | 06-80-SAMSUNG (7267864)   | www.samsung.com/hu           |
| INDIA          | 3030 8282<br>1800 110011  | www.samsung.com/in/          |
| INDONESIA      | 0800-112-8888   | www.samsung.com/id           |
| ITALIA         | 800-SAMSUNG(7267864)<br>800-048989  | www.samsung.com/it           |
| JAMAICA        | 1-800-234-7267  | www.samsung.com/latin        |
| JAPAN          | 0120-327-527  | www.samsung.com/jp           |
| LATVIA         | 800-7267  | www.samsung.com/lv/index.htm |
| LITHUANIA      | 8-800-77777   | www.samsung.com/lt           |
| LUXEMBURG      | 0035 (0)2 261 03 710  | www.samsung.com/be           |
| MALAYSIA       | 1800-88-9999  | www.samsung.com/my           |
| MEXICO         | 01-800-SAMSUNG (7267864)  | www.samsung.com/mx           |
| NETHERLANDS    | 0900 20 200 88 (€0,10/min)  | www.samsung.com/nl           |
| NEW ZEALAND    | 0800SAMSUNG(726-7864)   | www.samsung.com/nz           |
| NORWAY         | 815-56 480  | www.samsung.com/no           |
| PANAMA         | 800-7267  | www.samsung.com/latin        |
| PHILIPPINES    | 1800-10-SAMSUNG<br>(7267864)  | www.samsung.com/ph           |
| POLAND         | 0 801 801 881<br>022-607-93-33  | www.samsung.com/pl           |
| PORTUGAL       | 80 8 200 128  | www.samsung.com/pt           |
| PUERTO RICO    | 1-800-682-3180  | www.samsung.com/latin        |
| REP. DOMINICA  | 1-800-751-2676  | www.samsung.com/latin        |

| Country             | Customer Care Center        | Web Site              |
|---------------------|-----------------------------|-----------------------|
| REPUBLIC OF IRELAND | 0818 717 100                | www.samsung.com/uk    |
| RUSSIA              | 8-800-555-55-55             | www.samsung.ru        |
| SINGAPORE           | 1800-SAMSUNG (7267864)      | www.samsung.com/sg    |
| SLOVAKIA            | 0800-SAMSUNG (726786)       | www.samsung.com/sk    |
| SOUTH AFRICA        | 0860 726 7864 (SAMSUNG)     | www.samsung.com/za    |
| SPAIN               | 902 10 11 30                | www.samsung.com/es    |
| SWEDEN              | 0771-400 200                | www.samsung.com/se    |
| SWITZERLAND         | 0800-7267864                | www.samsung.com/ch/   |
| TAIWAN              | 0800-329-999                | www.samsung.com/tw    |
| THAILAND            | 1800-29-3232<br>02-689-3232 | www.samsung.com/th    |
| TRINIDAD & TOBAGO   | 1-800-7267-864              | www.samsung.com/latin |
| TURKEY              | 444 77 11                   | www.samsung.com.tr    |
| U.A.E               | 800-SAMSUNG (7267864)       | www.samsung.com/mea   |
| U.K                 | 0870 SAMSUNG (7267864)      | www.samsung.com/uk    |
| U.S.A.              | 1-800-SAMSUNG (7267864)     | www.samsung.com       |
| UKRAINE             | 8-800-502-0000              | www.samsung.ua        |
| UZBEKISTAN          | 8-800-120-0400              | www.samsung.com.uz    |
| VENEZUELA           | 0-800-100-5303              | www.samsung.com/latin |
| VIETNAM             | 1 800 588 889               | www.samsung.com/vn    |

# CHAPTER 1

## SETUP AND COPYING

This chapter describes the preliminary setup procedure. A full installation instruction is explained in the separate Quick Install Guide. If you are installing or reinstalling the machine from the beginning, refer to the Quick Install Guide provided with the machine.



# List of features

---

This machine was designed using the latest technology. It is a full-featured, high-performance machine that not only meets, but also exceeds industry standards. The following is a list of its many exciting features:

## **Common features to SF-370 Series (SF-370/SF-371P/SF-375TP)**

- *Save Ink (See "Copying/receiving in Ink Save mode" on page 1.8.)*
- *Inkjet printing on plain paper*
- *14.4Kbps high speed faxing*
- *150 page holding memory (SF-370/SF-371P), 200 page holding memory (SF-375TP)*
- *Multilingual display and report (See "Language" on page 6.10.)*
- *Stand-alone, full-function fax machine*
- *Convenient 50 page desktop copier*
- *15 page Skew Free Document Feeder*
- *100 Speed Dialling locations (10 One-Touch included)*
- *Five reception modes; TEL, FAX, AUTO, TAM<sup>1</sup> (Telephone Answering Machine) and DRPD*
- *Broadcasting to send the same document to multiple destinations*
- *Delayed FAX to send the document at a later time*
- *Send/Receive Polling*
- *Automatic Telephone line checking*
- *Last 10 number redial*
- *Report management; sending confirmation, Journal report and Phonebook, etc.*
- *Transmit and Receive short messages*
- *Stored FAX to send the document without original document*
- *My Favorites*
- *Wake up Sound*

## **Features for SF-371P/SF-375TP**

- *PC printing capability*
- *Network sharing*

## **Features for SF-375TP only**

- *Built-in digital Answer (Telephone Answering Machine)*
- *Access from a remote telephone*
- *Message Forwarding (you can have the machine transfer a call when the caller leaves a message).*
- *Call monitor*
- *FAX Receiving Notice (you can know with Voice Message when the machine receives a new fax).*
- *Speaker Phone*

---

*SF-370: Inkjet Facsimile*

*SF-371P/SF-375TP: Inkjet Multi Function Device*

1. SF-375TP only.

# Familiarizing yourself with your new machine

Take a moment to familiarise yourself with your new machine by looking at the pictures on the next few pages.

## Front view<sup>2</sup>

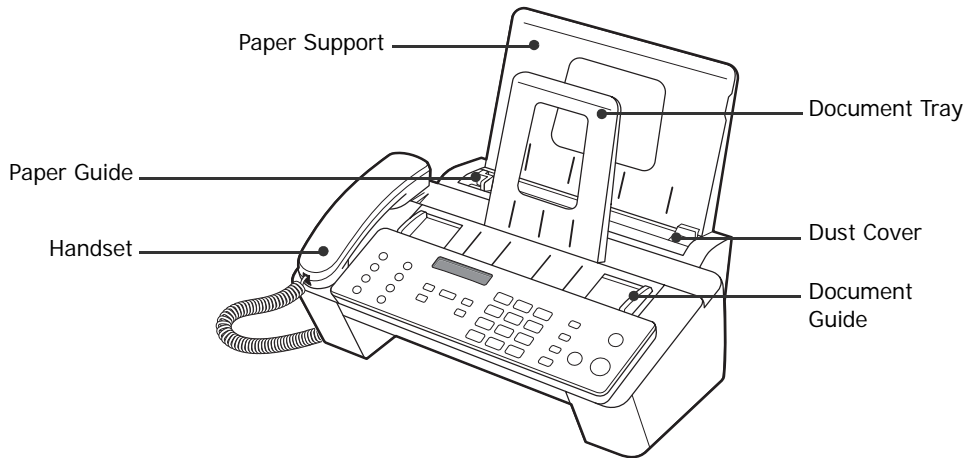

## Rear view

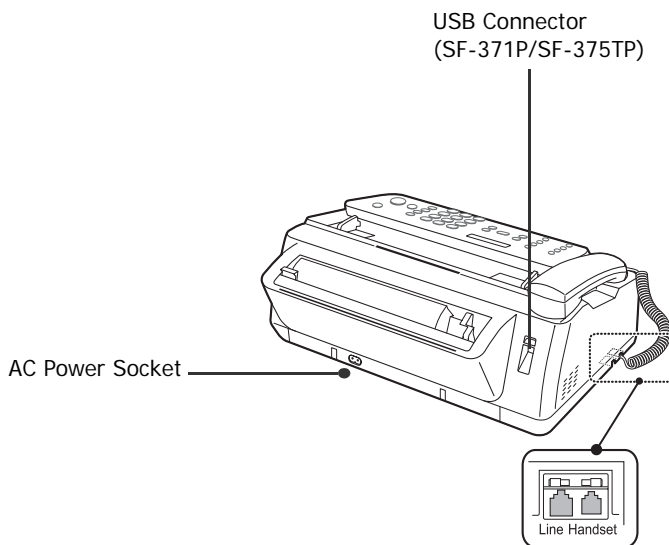

2. Note that all of illustrations on this User's Guide are from SF-375TP, so some parts may be different from your machine.

## Control Panel

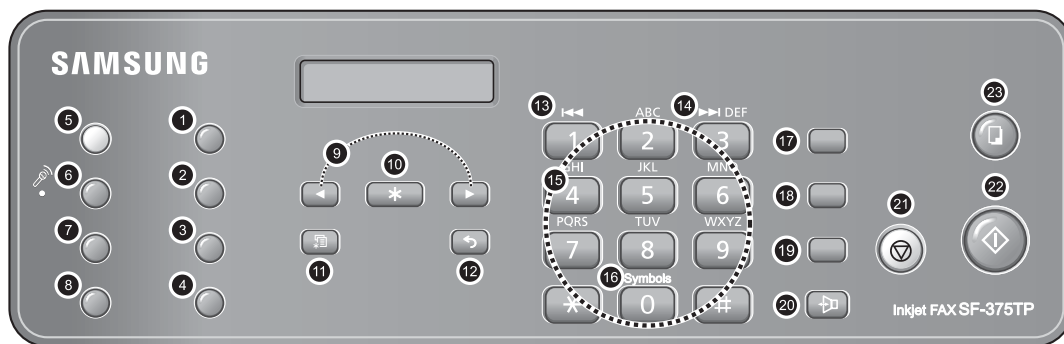

| No | Button name  | Function   |
|----|--|--|
| 1  | <b>Rcv.mode/Darkness</b>                           | This button has two functions:<br>When no document is loaded, pressing this button changes the Receive Mode. When a document is loaded, the pressing this button changes the darkness. |
| 2  | <b>Resolution</b>                                  | Improves the clarity of a document you are sending or copying.   |
| 3  | <b>Cartridge Change</b>                            | Used to install a new cartridge or replace an old one.   |
| 4  | <b>My Favorites</b>                                | Used to store the document used frequently and send it conveniently.   |
| 5  | <b>Answer (SF-375TP only)</b>                      | Switches the TAM (Telephone Answering Machine) mode on/off. It lights when in TAM Mode and blinks when a new message is received.  |
| 6  | <b>Greeting (SF-375TP only)</b>                    | Use to record or play the outgoing message used in TAM (Telephone Answering Machine) Mode.   |
| 7  | <b>Play/Record (SF-375TP only)</b>                 | Plays incoming messages. Used to record a phone conversation.  |
| 8  | <b>Erase (SF-375TP only)</b>                       | Used to erase a message or all messages.   |
| 9  | <b>Left/right arrow</b>                            | Used to display the previous or next menu item, to adjust the volume, or to move the cursor to the digit you want to edit.   |
| 10 | <b>OK</b>  | Used to activate the selection shown in the display.   |
| 11 | <b>Menu</b>  | Used to choose special functions such as system setup and maintenance, etc.  |
| 12 | <b>Back</b>  | Used to return to the previous menu level.   |
| 13 | <b>⏮ (1)</b>                                       | Used to repeat the current message, or to skip back to the previous one.   |
| 14 | <b>⏭ (3)</b>                                       | Used to skip forward to the next message.  |
| 15 | <b>Number keypad</b>                               | Dial numbers manually as you would usually do with the telephone, or enter letters while setting up your machine.  |
| 16 | <b>Symbols</b>                                     | Used to enter special characters when entering a name in edit mode.  |
| 17 | <b>Phone Book</b>                                  | To search for a number in memory.  |
| 18 | <b>Redial/Pause</b>                                | Used to redial the last number called. You can also use it to add a pause while storing a number in memory.  |
| 19 | <b>Mute</b>  | To mute the phone while you are speaking via the microphone.   |
| 20 | <b>Speaker Phone (or On Hook Dial)<sup>a</sup></b> | Used to speak without picking up the handset, or dial numbers.   |
| 21 | <b>Stop/Clear</b>                                  | Stops an operation at any time. Or used to delete digits in the edit mode.   |
| 22 | <b>Start Copy</b>                                  | Used to copy a document.   |
| 23 | <b>Start Fax</b>                                   | Used to start a job.   |

a. Speaker Phone: SF-375TP  
On Hook Dial: SF-370, SF-371P

# Loading paper

To receive faxes or make copies, you should load the paper in the ASF<sup>3</sup>. You can load approximately 50 sheets of paper. Before loading the paper, see if the paper size is set correctly in the System Setup.

For more information, see "Paper Size" on page 6.10.

- 1 Put in the **Paper Support**.
- 2 Pull the **Dust Cover** toward you.
- 3 Fan the papers and insert them into the ASF with the print side face up.
- 4 Squeeze the Paper Guide, and move it to the right to match the width of the paper.
- 5 When completed, replace the Dust Cover to its original position.

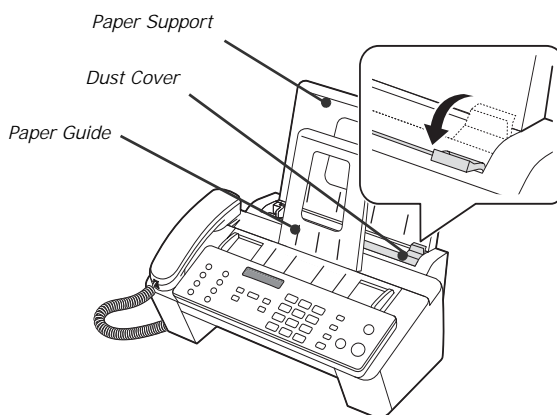

## Paper type and sizes

Satisfactory print and receive quality can be obtained with many types of plain paper. Since the quality of plain paper varies widely, test the print quality before buying large quantities of paper. Your machine uses a variety of papers including:

- Xerographic paper
- Bond paper
- Dual-purpose paper

Because all paper varies in physical characteristics, you can receive mixed results from different packages of paper even though the packages contain the same type of paper. If you encounter undesirable results, try the other side of the paper, a different type, or another package of the same kind of paper.

**DO NOT** use the following types of paper with your machine:

- Continuous form feed paper
- Synthetic paper
- Thermal paper
- Multi-sheet forms and documents
- Chemically treated paper
- Papers with raised, embossed lettering

The following print media can be used with your machine:

| Paper size | Dimensions      | Paper weight             |
|------------|-----------------|--------------------------|
| A4         | 210 mm x 297 mm | 60 ~ 90 g/m <sup>2</sup> |
| Letter     | 216 mm x 279 mm |                          |
| Legal      | 216 mm x 356 mm |                          |

3. Automatic Sheet Feeder.

# Making a copy

---

If you want to save ink while copying or receiving a fax, see "Copying/receiving in Ink Save mode" on page 1.8.

- 1 Turn the page face down and insert it into the document feeder.
- 2 Adjust the **document guide** to match the width of the document.
- 3 Feed the document into the machine.
- 4 Adjust the resolution by pressing **Resolution**.
- 5 Press **Start Copy**.
  - The display shows Number of Copies.
- 6 Enter the **number of copies** you want, and press **OK**.
  - The display shows Zoom Rate.
  - If you want one copy without specific copy options, you can press **Start Copy** again at this time, and copying will start immediately.
- 7 Select the zoom rate you want by pressing **Left/right arrow** buttons, and then press **OK**.
  - You can scale the document from 50% to 150% by selecting a pre-defined rate. The default rate is 97%.
- 8 Choose if you want to collate document.
  - When collation is selected, you need to select the sorting order; Normal, Reverse.
- 9 Press **OK** when all options have been selected.
  - When the machine runs out of paper, Load paper and press **OK** appears in the display. Supply additional paper and press **OK**.

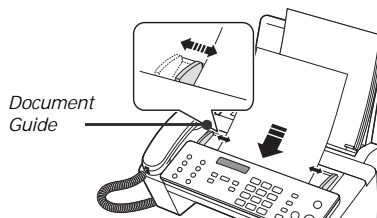

## Setting date and time

---

The current date and time are shown in the display when the machine is on and ready for use (Standby Mode). The date and time will be printed on all faxes you send.

- 1 Press **Menu**.
- 2 Press **Left/right arrow** buttons to choose SET DATE & TIME and press **OK**.
- 3 Press **OK** when the display shows Date Format.
- 4 Press **Left/right arrow** buttons to select either Europe (D-M-Y) or USA (M-D-Y) and press **OK**.
- 5 Press **OK** when the display shows Date & Time.
- 6 Set the date and time. You can move the cursor by pressing **Left/right arrow** buttons.
  - If you enter an invalid number, the machine beeps and doesn't proceed to the next step. If this happens, just re-enter the correct number.
  - When entering the hour, you should enter it in 24-hour format.
- 7 Press **OK** when the date and time appear correctly.
  - The display shows the date and time you have set, then returns to Standby Mode.

# Setting fax number/name

---

If this option is not selectable even though you followed the described steps, you have to consult the service technician or your dealer.

This is very useful information for the recipient. It allows them to see who sent a fax and what number they should send a response to.

- 1 Press **Menu**.
- 2 Press **Left/right arrow** buttons to choose SET SYSTEM ID and press **OK**.
- 3 Press **OK** when the display shows Fax Number.
- 4 Enter the fax number to which your machine is connected.
  - You can enter up to 20 digits, and include special characters (space, plus sign, etc.)
  - To enter a delimiter, press #.
  - To enter plus symbol (+), press \*.
  - If you enter a wrong number, use **Left/right arrow** buttons to move to the number and correct it. Or, use **Stop/Clear** button to delete the number you entered, then enter the correct digit.
- 5 Press **OK** when finished.
- 6 Press **OK** when the display shows Fax Name.
- 7 Enter the fax name (up to 40 characters) by using the number keypad.
  - You can include special characters (space, plus sign, etc.).
- 8 Press **OK** when the name in the display is correct.
  - The machine returns to Standby Mode when you have finished or when **Stop/Clear** has been pressed.

## How to enter letters

These instructions assume that the display is asking you to enter a name.

- 1 Press the appropriate button for the letter you want.
  - To enter an O, for example, press the 6 button three times. Each time you press the button, the display shows a different letter: first M, then N, an O, and finally 6.
  - For a list of letters and corresponding buttons, see "Keypad character assignments" on page 1.8.
- 2 Select the next letter in the same way.
  - The blinking cursor moves right and the next letter appears in the display.
  - If the letter is assigned to the same button you have pressed in step 1, then first move the cursor by pressing **Left/right arrow** buttons, then press the button.
- 3 Press **OK** when you're finished entering letters.

## Keypad character assignments

| Key | Assigned numbers, letters, or characters | Key         | Assigned numbers, letters, or characters |
|-----|--|-------------|--|
| 1   | (Space) 1                                | 6           | M N O 6                                  |
| 2   | A B C 2                                  | 7           | P Q R S 7                                |
| 3   | D E F 3                                  | 8           | T U V 8                                  |
| 4   | G H I 4                                  | 9           | W X Y Z 9                                |
| 5   | J K L 5                                  | 0 (Symbols) | + - , . ' / * # & 0                      |

## Copying/receiving in Ink Save mode

---

Your machine has an Ink Save mode to optimize consumption of ink when copying and receiving a fax.

- 1 Press **Menu**.
- 2 Press **Left/right arrow** buttons to choose SETUP SYSTEM and press **OK**.
- 3 Press **Left/right arrow** buttons to choose Ink Save and press **OK**.
- 4 Press **Left/right arrow** buttons to choose On and press **OK**.
  - If you feel the print quality is not good enough, change the Ink Save mode Off and then try to print again.

## Adjusting ring volume

---

Your machine has several levels of ring volume. Adjust it as you prefer.

Press **Left/right arrow** buttons with machine in standby.

- Whenever you press the button, different ring is ringing.
- The volume 0 indicates that the machine will not ring when the call is received.

## Adjusting speaker volume

---

When you are speaking via the speaker phone, you can adjust the volume as you follows:

- 1 Press **Speaker Phone** (or **On Hook Dial**).
  - You can adjust it when you are talking as well.
- 2 Press **Left/right arrow** buttons as many times as you want.
  - Whenever you press the button, it will increase or decrease the volume.



# **CHAPTER 2**

## **PROGRAMMING AND DIALLING**



# Making a phone call

---

Your new machine provides many ways for making a phone call. You can use either of following:

- *On-Hook dialling*
- *Phone book dialling (One-Touch and Speed dial)*
- *redialling*
- *manual dialling via the handset as you do with a regular telephone*

## Speaker Phone dialling

---

You do not need to pick up the handset to make a phone call. When dialling, just press the **Speaker Phone** (or **On Hook Dial**) button and enter the numbers. Depending on your machine, you need to pick up the handset or keep speaking through the microphone.

### **If you have an SF-370 or an SF-371P**

- *You have to pick up the handset to speak after the call is answered.*
- *If you want to share the conversation with somebody beside you, pick up the handset and press **On Hook Dial**. The line is still connected and everybody can listen to the conversation. This is called a 1-way conversation.*
- *While you are using 1-way conversation, do not place the handset beside the speaker, as this may result in howling.*

### **If you have an SF-375TP**

- *You do not need to pick up the handset. Speak into the microphone on the Control Panel when the call is answered.*

## Phone book dialling

---

There are two types of Phonebook dialling; One-Touch and Speed dial. The way to programme numbers into memory is the same for both but how you dial stored numbers is different. To One-Touch dial, you just press and hold a number (0 ~ 9) on the keypad and the number will be dialled.

**Phone Book** dialling provides you with quick access to your most frequently used numbers.

Before using **Phone Book** dialling, you must first programme the numbers into the memory.

### **Storing a number in the Phonebook**

- 1 Press **Phone Book** button.
- 2 Press **Left/right arrow** buttons to choose **New & Edit** and press **OK**
  - *The display shows Speed [00-99]>##.*
- 3 Enter a two-digit (00 ~ 99) number and press **OK**.
  - *From 00 to 09 will be used for One-Touch dialling, and from 00 to 99 for Speed dialling.*
- 4 Enter the telephone/fax number you want to store (up to 40 digits) and press **OK**.
  - *If you want a pause between numbers, press **Redial/Pause**; a 'P' appears in the display.*
  - *If you make a mistake while entering a number, use **Left/right arrow** buttons to move the cursor under the digit, then enter the correct digit. Or, use **Stop/Clear** button to delete the number you entered, then enter the correct digit.*

- 5 Enter the name and press **OK**.
  - If you do not want a name, just skip this step by pressing **OK**. If you have subscribed to a Caller ID service, it is recommended you enter a name.
  - You can assign up to 20 characters to a name. See "How to enter letters" on page 1.7.
- 6 Press **Stop/Clear** to exit.

## Editing a number in the Phonebook

- 1 Press **Phone Book** button.
- 2 Press **Left/right arrow** buttons to choose New & Edit and press **OK**
  - The display shows Speed [00-99]>##.
- 3 Enter a two-digit (00 ~ 99) number you want to edit and press **OK**.
- 4 Change the telephone/fax number and press **OK**.
- 5 Change the name and press **OK**.
- 6 Press **Stop/Clear** to exit.

## One-Touch dialling

- 1 Place document(s) if you are sending a fax.
- 2 Press and hold one of the number keypad (0 through 9).
  - The display briefly shows the name or number and the number is then automatically dialled. You hear the dialling process through the speaker.
  - When the remote fax machine answers, the machine scans the document into memory and begins to transmit if a document is loaded in the document feeder.
  - To send a fax directly without scanning into memory, turn off the Send From Memory option. (See "Send From Memory" on page 6.10.)
  - You can refer to the number assigned to each location by printing the Phonebook. See "To print a report" on page 6.4.
  - Regardless of the setting of the Send From Memory option, the machine will first dial and then send a fax if you set the resolution to Super Fine.

## Speed dialling

- 1 Press **Phone Book**.
- 2 Select Search & Dial and press **OK**.
  - The display shows Press <, >, A-Z.
  - Press **Left/right arrow** buttons until the name (or number) you want appears or enter the first letters of the name you want.
- 3 Press **OK** to dial the number.
  - The display briefly shows the name or number and the number is then automatically dialled. You hear the dialling process through the speaker.
  - When the remote fax machine answers, the machine scans the document into memory and begins to transmit if a document is loaded in the document feeder.
  - To send a fax directly without scanning into memory, turn off the Send From Memory option. (See "Send From Memory" on page 6.10.)
  - You can refer to the number assigned to each location by printing the Phonebook. See "To print a report" on page 6.4.
  - Regardless of the setting of the Send From Memory option, the machine will first dial and then send a fax if you set the resolution to Super Fine.

## Deleting a number in the Phonebook

- 1 Press **Phone Book**.
- 2 Press **Left/right arrow** buttons to choose Delete and press **OK**.
  - *The display shows Speed [00-99]>##.*
- 3 Enter a two-digit (00 ~ 99) number you want to delete and press **OK**.
  - *Select 'Y' and press OK when asked Delete? Y/N*
- 4 Press **Stop/Clear** to exit.

## Redialling

---

You can redial the number last called or one of ten unique numbers recently stored in memory.

### To redial the last number called

- 1 Press **Redial/Pause**.
  - *The number is dialled automatically.*
  - *If a document is loaded, the machine automatically begins to send. If there is no number stored, the machine will beep.*
- 2 Speak into the microphone when the call is answered.
  - *Pick up the handset, if you are SF-370 or SF-371P user.*

### To redial the number in memory

- 1 Press and hold **Redial/Pause** for about two seconds.
- 2 Select Recent Numbers and press **OK**.
  - *The display shows the most recent numbers.*
- 3 Press **Left/right arrow** buttons to find the number you are dialling.
- 4 Press **Start Fax** when the correct number appears.
  - *If a document is loaded, the machine automatically begins to send.*

### To find a number received via the Caller ID service

You sometimes need to see who has called you. To see the number or name follow the instructions below:

- 1 Press and hold **Redial/Pause** for about two seconds.
- 2 Press **Left/right arrow** buttons to choose Caller ID and press **OK**.
- 3 Scroll through the numbers by pressing **Left/right arrow** buttons.
  - *The Caller ID displays in two ways. One is by name and other is by number. If the number is the same as the one you saved to a One-Touch or Speed dial location and you assigned a name to that location, the machine shows the name instead of the number.*



# **CHAPTER 3**

## **THE FAX MACHINE**

# Sending a fax

Sending a fax is very simple if you follow the instructions starting from here. They will describe how to load the document, set the resolution/contrast and dial the number.

## Loading documents

1 Load your document(s) top down in the document tray with the printed side facing away from you.

- Be sure that your document is dry and free of staples, paper clips, and other foreign objects.
- For more information on what kind of paper you can use for documents, see "Acceptable documents" on page 3.2.

2 Adjust the document guides to match the width of the document, and load document consisting of up to 15 sheets until the Automatic Document Feeder seizes and pulls it in. The display will indicate Document Ready when it senses that a document has been loaded.

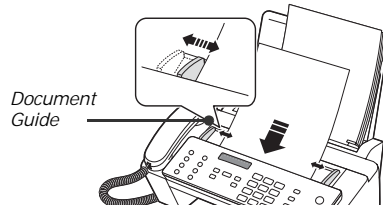

- If you are sending more than one sheet, make sure the bottom sheet enters first. Insert the sheets with a slight push to ensure smooth feeding.
- If you're loading pages that are unusually thick or thin, feed one sheet at a time. If the document doesn't feed correctly, open the Control Panel, remove the document, and try loading it again.

3 Choose the proper resolution and contrast by pressing **Rcv.Mode/Darkness** and **Resolution** respectively.

## Acceptable documents

|  |      | Single sheet                         | 2 or more sheets        |
|--|------|--------------------------------------|-------------------------|
| Document size                                  | Max  | 216 mm (W) x 390 mm (L) <sup>a</sup> | 216 mm (W) x 297 mm (L) |
|  | Min. | 148 mm (W) x 128 mm (L)              |                         |
| Effective scanning width                       |      | 210 mm                               |                         |
| Number of sheets which can be loaded at a time |      | -                                    | Up to 15                |
| Thickness of document                          |      | 0.07 mm ~ 0.15 mm                    | 0.075 mm ~ 0.12 mm      |
| Paper quality                                  |      | Uncoated on both sides               |                         |

a. When sending a document that is longer than A4 in size, you must immediately take out each sheet as soon as it has been scanned. Otherwise, the document may jam.

For multiple sheets, all pages of the document must be the same size and paper type.

**DO NOT** try to send documents that are:

- wet
- covered with wet ink or paste
- wrinkled, curled, or folded
- too thin (less than 0.07 mm thick-onionskin, airmail paper, etc.)
- too thick (more than 0.15 mm thick)
- chemically processed (pressure-sensitive paper, carbon-coated paper, etc.)
- coated (glossy, etc.)
- too small or short (such as a label, voucher, etc.)
- made of cloth or metal

To send these documents, use an office copier to make a photocopy first, and then send the copy.

## 3.2

## Setting document resolution and contrast

We recommend you send documents printed using a typewriter, felt tip pen, black ink, or LaserWriter. The paper should be white or very light, and of normal weight not cardboard.

Blue lines on a ruled pad don't fax well. For more information on what kind of paper you can use for documents, see "Paper type and sizes" on page 1.5. When you send/copy normal documents, you need not adjust the resolution and the contrast.

If you send/copy documents with unusual contrast characteristics, including photographs, you can adjust the resolution and contrast to send a high-quality transmission of the documents.

### To adjust the resolution and contrast

- 1 Turn the page face down and insert it into the document feeder.  
For more information, see "Loading documents" on page 3.2.
- 2 Press **Resolution** as many times as you want to adjust the sharpness and clarity.
  - *STANDARD works well for printed or typewritten originals with normal-sized characters.*
  - *FINE is good for documents containing a lot of detail.*
  - *SUPER FINE works well for documents containing extremely fine detail. SUPER FINE only works if the remote machine also has the SUPER FINE feature.*
  - *SUPER FINE mode is not used when sending documents scanned into memory (i.e. Smart Sending, Broadcasting and Delayed Fax).*
  - *If you are sending document by using memory (broadcasting, delayed tx, for example), SUPER FINE will be changed back to FINE even though you selected SUPER FINE.*
- 3 Press **Rcv.Mode/Darkness** as many times as you want to adjust the darkness.
  - *NORMAL works well for normal handwritten, typed, or printed documents.*
  - *LIGHTEN works with very dark print.*
  - *PHOTO is used when faxing photographs or other documents containing color or gray shades. When Photo is chosen, the resolution is automatically set to FINE.*
  - *DARKEN works with light print or faint pencil markings.*
  - *When sending/copying is executed, resolution/contrast automatically returns to default.*

## Sending a fax manually

- 1 Turn the page face down and insert it into the document feeder.  
For more information, see "Loading documents" on page 3.2.
- 2 Pick up the handset or press **Speaker Phone** (or **On Hook Dial**).
- 3 Enter the number of the remote fax machine by using the number keypad.
- 4 Press **Start Fax** when you hear the fax tone.
- 5 Replace the handset.

## Sending a fax automatically

To send a fax automatically, you must have already stored numbers into Speed Dial locations. To learn how to register One-Touch Dial or Speed Dial, see "Storing a number in the Phonebook" on page 2.2.

- 1 Turn the page face down and insert it into the document feeder.  
For more information, see "Loading documents" on page 3.2.
- 2 Enter the One-Touch or Speed Dial location.  
If you are using the Speed Dial, you have to press **OK**.
  - *The machine scans the document into memory and begins to transmit. If you turned off the Send From Memory option, the machine will first dial and send.*
  - *You can set your machine to print out a Sending Confirm automatically. For more information, see "Sending*

Confirm" on page 6.4.

## Automatic redial

When you send a fax, if the number you have dialled is busy or there is no answer, the machine will attempt to redial the number every three minutes up to two times.

Before redialling, the display shows *To redial now, press* **Start Fax**.

If you want to redial the number immediately, press **Start Fax**.

Or, press **Stop/Clear** to cancel redialling and then the machine returns to Standby Mode.

## Receiving a fax

---

Before you receive a fax, be sure to load one of the supported paper sizes for receiving faxes. For information on what paper types you can use, see "Paper type and sizes" on page 1.5.

### Reception modes

Your fax machine has various reception modes; FAX, TEL, AUTO, TAM<sup>4</sup> and DRPD. For DRPD Mode, see "DRPD Mode" on page 6.10. first. If you are an SF-375TP user, you have to press the **Answer** button to select TAM mode. Do not press the **Rcv.Mode/Darkness** button. You can change the reception mode by pressing **Rcv.Mode/Darkness** when no document is loaded. The following chart describes how each reception mode works:

| Reception mode | Your model | How it works   | Reference section                                  |
|----------------|------------|--|--|
| FAX            | All        | The machine answers an incoming call and immediately goes into receive mode, expecting a fax to be received.   | Receiving in FAX mode on page 3.5.                 |
| TEL            |            | The automatic fax reception is turned off. You can receive a fax only by manually pressing <b>Start Fax</b> .  | Receiving in TEL mode on page 3.5.                 |
| AUTO           |            | Your fax machine will answer faxes automatically after the number of rings you specify. If the machine does not pick up a fax signal, it will give another ringing tone to tell you it is a phone call. You should lift the handset to answer the call. If you do not pick up the handset on your fax machine, it will switch to the automatic reception mode. | Receiving in AUTO mode on page 3.5.                |
| TAM            | SF-375TP   | Your machine plays a greeting message to callers, and then the caller can leave an incoming message on your machine as well as a fax.  | Receiving in TAM mode (SF-375TP only) on page 3.5. |

If you rarely use the fax line for voice conversation, set the machine to receive faxes automatically by selecting either FAX or AUTO Mode.

---

<sup>4</sup>TAM: Telephone Answering Machine. SF-375TP only.

## Receiving in FAX mode

To set the machine to FAX Mode, press **Rcv.Mode/Darkness** repeatedly until Fax Mode is displayed.

- In Standby Mode, FAX appears in the right hand corner of the display.
- When you get a call, the machine answers after the second ring, and receives the fax automatically. When reception is complete, the machine returns to Standby Mode.
- If you want to change the 'Rings to Answer' option, see "Rings To Answer" on page 6.10.

## Receiving in TEL mode

To set the machine to TEL Mode, press **Rcv.Mode/Darkness** repeatedly until Tel Mode is displayed.

In Standby Mode, TEL appears in the right hand corner of the display.

- 1 Pick up the handset and answer it when the telephone rings.  
If your machine is an SF-375TP, and you do not answer the call within pre-defined rings<sup>5</sup>, the ANSWER Greeting will be played.
- 2 Press **Start Fax** if you hear a fax tone, or if the person on the other end asks you to receive a document. Be sure there is no document loaded, or the document will be sent to the caller's fax showing 'Send' in the display.
- 3 Hang up the handset.

## Receiving in AUTO mode

To set the machine to AUTO Mode, press **Rcv.Mode/Darkness** repeatedly until Auto Mode is displayed.

- In Standby Mode, AUTO appears in the right hand corner of the display.
- When a call comes in, the machine answers it. If a fax is being received, the machine goes into receive mode. If the machine does not sense a fax signal, it will continue ringing to tell you it is a phone call. You should pick up the handset to answer the call, or it will switch to automatic reception mode, after approximately 25 seconds.

## Receiving in TAM mode (SF-375TP only)

If you are an SF-375TP user, you have to activate/deactivate the TAM (Telephone Answering Machine) Mode by pressing the **Answer** button, not by **Rcv.Mode/Darkness**. Once you press **Answer** to turn TAM Mode on, the machine returns to Standby Mode after playing the message back. TAM appears in the right hand corner of the display and the **Answer** button lights.

- When you get a call, the machine answers the call with the ANSWER greeting message.
- The machine records the caller's message. If a fax tone is sensed, the machine goes into receive mode.
- Anytime the greeting message is playing, or an incoming message is being recorded, you can talk to the other person by picking up the handset. If the memory becomes full while recording, your machine beeps a warning and disconnects the line. The machine will not function as an answering machine unless you make space by erasing unwanted recorded messages.
- If there is a power failure while recording a caller's message, it will not be recorded.
- When you want to talk to a caller on another telephone on the same line while recording an incoming message (ICM), lift its handset and press '#' (hash) and '\*' (asterisk).

---

<sup>5</sup>.UK: 20, other countries: 13



## Receiving in DRPD mode

DRPD stands for Distinctive Ring Pattern Detection, which is a telephone company service. It enables a user to use a single telephone line to answer several different telephone numbers. To receive a fax in DRPD mode, you should first set DRPD and activate it. Once you have activated DRPD mode it can be one of the receiving modes which can be selectable by pressing the **Rcv.Mode/Darkness** button as FAX, TEL and AUTO. To set up DRPD, see "DRPD Mode" on page 6.10.

Press **Rcv.Mode/Darkness** repeatedly until DRPD Mode appears in the display.

- Now, the machine will manage faxes and call as programmed.
- In Standby Mode, DRPD appears in the right hand corner of the display.

*DRPD must be set up again if you reassign your fax number, or connect the machine to another telephone line. After DRPD has been set up, call your fax number again to verify that the machine answers with a fax tone, then have a call placed to a different number assigned to that same line to be sure the machine answers the normal phone call.*



# CHAPTER 4

## THE ANSWERING MACHINE

This chapter is only for SF-375TP users.

In this chapter, you will learn how to check your TAM (Telephone Answering Machine) greeting message, monitor incoming calls, play/erase messages, and access your machine from a remote telephone. All the instructions in this chapter assume that your fax machine is set to TAM Mode. The SF-375TP uses electronic memory as a recording medium. Recording time is dependent on the content of the message. The total recording time which consists of TAM greeting and ICM (InComing Message), is about 30 minutes.

# Recording your TAM message

---

The TAM (Telephone Answering Machine) message is an greeting message which plays whenever a call comes in and the machine is in TAM Mode. For more information about reception modes, see "Receiving in TAM mode (SF-375TP only)" on page 3.5.

- 1 Press and hold **Greeting** until you hear a beep.
- 2 Speak into the microphone on the Control Panel within 30 cm range from the time you see Record in the display.
  - You can record a message which lasts up to 20 seconds.
  - You are advised to record a message of less than 15 seconds in duration to prevent the incoming faxes from malfunctioning due to a long message.
  - Press **Stop/Clear** or **Greeting** if you want to stop recording before the time is up.
  - After the message has been recorded, the machine briefly displays the date and time when the message was recorded. Then, it displays the elapsed time as the message plays back automatically.

# Checking your TAM message

---

The TAM (Telephone Answering Machine) message plays back when your machine is in TAM Mode and receives a call.

Press **Greeting**.

- The display shows the time when the message was recorded. The display then counts down the seconds as the message is playing back.

# Monitoring an incoming call

---

Call Monitoring is useful for screening calls in case you do not want to be disturbed by the person calling. To use this feature, you have to first set Call Monitoring ON through the TAM (Telephone Answering Machine) Options. To learn how to set this feature on or off, see "Call Monitor" on page 6.11.

- 1 When the call monitor option is on and an incoming message is being recorded, you hear the caller's voice through the speaker.
- 2 Lift the handset to speak to the caller.
  - The machine stops recording the caller's message and you can speak directly to the caller.
  - If there is a power failure while recording a caller's message, it will not be recorded.

# Playing back messages

---

When there are messages waiting to be heard, the **Answer** button flashes and the display shows that you have new messages, for example, New: 1 ICM: 3. ('New: 1' indicates there's one new message, and 'ICM: 3' says that there are three incoming messages recorded in total.)

## Playing back newly received caller messages

Simply press **Play/Record**.

- The machine briefly displays recorded time then starts to play the message. This procedure is repeated for all NEW messages.
- When the display reads 50s(01/03), '01' is the number of the caller message currently being played and '03' is the total number of new caller messages in memory. '50s' is the play back time for the message currently playing. This time counts down as the message plays back.

## Playing back all messages

Press and hold **Play/Record** until you hear a beep.

- All the messages are played back. The display briefly shows recorded time of each message, then plays ALL the messages recorded.
- When the display reads 50s(01/03), '01' is the number of the caller message currently being played and '03' is the total number of caller messages in memory. '50s' is the play back time for the message currently playing. This time counts down as the message plays back.
- Press **Stop/Clear** or **Play/Record** to stop before the last message. While the message is playing back, the display shows a variety of useful information.

## Skipping backward or forward

### To skip backward

Press **⏮** (1) while listening to the message.

- If you press **⏮** (1) while playing back the message, the machine will replay it.
- The machine skips back to the previous message and plays it if you press **⏮** (1) twice.

### To skip forward

Press **⏭** (3) while listening to a message.

- The machine skips forward to the next message and plays it.
- If you press **⏭** (3) while playing the last message, the machine beeps and returns to the Standby Mode.

# Erasing old messages you've heard

---

The memory of your machine fills up as messages are recorded. Make room for new messages by erasing old messages that you have already listened to. If the memory becomes full while recording, your machine beeps a warning and disconnects the line. The machine will not function as an answering machine unless you make space by erasing unwanted recorded messages. This is why you should erase old messages.

## To erase a selected message

Press **Erase** while the message is playing.

- **BE CAREFUL!** Once you have pressed **Erase** while a message is playing, there's no way to cancel or recover it.
- The selected message is erased and Erasing is displayed.

## To erase all recorded messages

**1** Press **Erase**. The display asks if you want to erase ALL messages.

**2** Press **OK** if you're sure.

- All messages in memory are erased while Erasing is displayed.
- If you do not want to erase all messages, press **Stop/Clear** when asked and the machine returns to Standby Mode.

# Using the answering machine from a remote phone

You don't need to be at the machine's Control Panel to operate the answering machine. If you have access to a Touch-Tone phone, you can operate many features, such as message playback, regardless of where you are.

To operate your machine from a remote phone, you need to enter a five-character remote Password. The Remote Password is preset at the factory to '#139#' and you can change the password to any number you want, through the User Options. For more information, see "Remote Password" on page 6.11.

## Accessing the machine

- 1 Place a call to your fax machine from a Touch-Tone phone.
- 2 Enter your Remote Password when the machine answers with the greeting.
  - When the correct password is recognized by the machine, you will hear two short beeps (the confirmation tone).
- 3 Enter the Remote Command corresponding to the operation within 15 seconds.
  - When the specified operation is complete, you hear a short beep. You can then enter another command for another operation. If you enter a remote code while the machine is responding to your command, the unit stops the current operation and performs new operation. For the Remote Commands, see "Using remote commands" on page 4.5.
- 4 Press #0 to finish the remote session.  
If you don't enter '#0', your machine might not hang up for several minutes.

## Using remote commands

The chart below describes which Remote Code you have to enter for remote operation:

| Code; | Operation;  |
|-------|---|
| #0    | Exits remote control mode.  |
| #1    | Skips a message backward. The machine skips the current message and plays the previous one.   |
| #2    | Plays back new messages. The machine beeps and plays messages one by one. When a message is played back, the machine waits for another command. To listen to next message, press * within 15 seconds. If there are no messages, the machine beeps four times and waits for another command to be entered. |
| #3    | Skips a message forward. The machine skips the current message and plays the next one.  |
| #4    | Changes the TAM (Telephone Answering Machine) message. After entering the command, speak into the handset. When you finish, press #. If you run out of recording time, the machine stops and plays back the message.  |
| #5    | Plays back all messages. The machine beeps and plays messages one by one. When a message is played back, the machine waits for another command. To listen to next message, press * within 15 seconds. If there are no messages, the machine beeps four times and waits for another command to be entered. |
| #6    | Changes the Paging Greeting message. The machine beeps and is ready to record new message. Speak into the handset. When you finish, press #.  |
| #7    | Erases the message currently playing, and plays back the next message.  |
| #8    | Turns TAM (Telephone Answering Machine) Mode on/off. The machine plays the greeting message when TAM Mode is turned on. Each time you press #8 thereafter, TAM mode is turned off, then back on.  |
| #9    | Erases all the messages.  |
| *     | Plays the next incoming message (ICM) message if you entered the #5 or #2 command.  |
| #*    | Exits the fax machine from answering mode. This code is used at a phone extension connected to the same line as your fax machine  |



# CHAPTER 5

## ADVANCED FAX

In this chapter, you will learn how to use the advanced fax features of your machine. For example, how to send the same documents to many different locations (Broadcasting) or how to set up your machine to send faxes at a preset time (Delayed Fax).



# Broadcasting

---

With Broadcasting you can programme your machine to automatically scan and send documents to a number of different recipients. The documents are automatically erased from memory when Broadcasting is finished.

- 1 Turn the document face down and feed it into the machine.
- 2 Press **Menu**.
- 3 Press **Left/right arrow** buttons to choose **ADVANCED FAX** and press **OK**.
- 4 Select **Set Broadcasting** by pressing **Left/right arrow** buttons, and press **OK**.
- 5 Enter the fax number.
  - By pressing **Phone Book**, you can enter a *One-Touch* or *Speed Dial* location number, which consists of two digits.
  - You can enter 5 fax numbers into one job.
- 6 Press **OK** when the correct number appears in the display.
  - If you have more destinations, select 'Y' and press **OK** when asked *Another? Y/N* and repeat steps from 5.
  - If you have finished entering all the numbers, answer 'N' and press **OK**.
- 7 Press **Start Fax**.
  - The document will be scanned into memory before transmission.

## Delayed fax

---

You can set your machine to send a fax at a later time when you will not be present. Normally it is cheaper to send a fax at night because telephone rates are lower than they are during the day.

- 1 Turn the document face down and feed it into the machine.
- 2 Press **Menu** repeatedly until **ADVANCED FAX** appears, and press **OK**.
- 3 Select **Set Delayed Fax** by pressing **Left/right arrow** buttons, and press **OK**.
- 4 Enter the fax number.
  - By pressing **Phone Book**, you can enter a *One-Touch* or *Speed Dial* location number, which consists of two digits.
  - You can enter 5 fax numbers into one job.
- 5 Press **OK** when the number appears in the display.
  - If you have more destinations, select 'Y' and press **OK** when asked *Another? Y/N* and repeat steps from 5.
  - If you have finished entering all the numbers, answer 'N' and press **OK**.
- 6 Enter the name if you want to name the transmission.  
If not, skip this step.
- 7 Press **OK**.
- 8 Enter the time the transmission starts, in 24-hour format.
  - For example, Enter 2230 for 10:30 P.M.
- 9 Press **OK** when the time appears correctly in the display.
  - The document will be scanned into memory before transmission, and be sent at programmed time.

# Using My Favorites

---

My Favorites enables you to store documents that are frequently faxed and send them to selected fax numbers without the originals. Store a document into memory and give the document an ID name. When you use this feature, set contrast to *PHOTO* by pressing **Rcv.Mode/Darkness** is not supported.

## Saving documents

- 1 Turn the document face down and feed it into the machine.
- 2 Press **My Favorites** repeatedly and press **OK** when *Save* appears.
- 3 Enter the document ID name (upto 15 characters by using the number keypad).
  - *The document will be scanned into memory.*
  - *It shows "Exceeded Job Memory" message, when you save more than three **My Favorites**.*

## Deleting stored documents

- 1 Press **My Favorites** repeatedly and press **OK** when *Delete* appears.
- 2 You can select one or all to delete the stored documents.
- 3 Select the document to delete by pressing **Left/right arrow** buttons, and when the correct document ID is displayed, press **OK**.
  - *The document will be deleted.*

## Sending stored documents

- 1 Press **My Favorites** repeatedly and press **OK** when *Send* appears.
- 2 Select the document to be sent by pressing **Left/right arrow** buttons, and when the correct document ID is displayed, Press **OK**.
- 3 Enter the fax number.
  - *By pressing **Phone Book**, you can enter a One-Touch or Speed Dial location number, which consists of two digits.*
  - *You can enter 5 fax numbers into one job.*
- 4 Press **OK** when the correct number appears on the display.
  - *If you have more destinations, select 'Y' and press **OK** when asked Another? Y/N and repeat from step 3.*

## Printing stored documents

- 1 Press **My Favorites** repeatedly and press **OK** when *Print* appears.
- 2 Select the document to be printed by pressing **Left/right arrow** buttons, you can select one or all to printout the stored document and when the correct document ID is displayed, press **OK**.
  - *The document will be printed.*

# Polling

---

Polling enables you (or a remote fax machine) to retrieve a document. This is useful when a person who has a document to be sent is leaving the office. The person who wants to receive the document at a later time places a call to the machine holding the original, and requests that the document be sent. In other words, it “requests” the machine holding the original.

## Setting send polling

You can programme your fax machine to send documents in your absence when it is requested by a remote fax machine.

- 1 Turn the document face down and feed it into the machine.
- 2 Press **Menu** repeatedly, and press **OK** when ADVANCED FAX appears.
- 3 Select Set Polling Send by pressing **Left/right arrow** buttons, and press **OK**.
- 4 Enter the poll code and press **OK**.
  - The poll code is used to prevent your document from being retrieved by the unauthorized caller.
  - Your machine starts scanning the document(s) into memory and shows POLLING SEND in the display. If the receiving mode was TEL, the machine changes it to FAX mode automatically for being polling.
  - The poll code is preset to 0000 at the factory, which represents no poll code.
  - When it is polled, the page in memory will be deleted automatically and receiving mode returns to the state before setting polling. To cancel Send Polling, see "To cancel the scheduled job" on page 5.4.

## Setting receive polling

- 1 Lift the handset or press **Speaker Phone (or On Hook Dial)** and enter the telephone number of the remote machine which is in Send Polling state.
- 2 Press **Menu** when you hear a fax tone from the remote machine.
  - The display shows To poll documents press Start Fax.
- 3 Press **Start Fax**.
- 4 Enter the Poll Code to retrieve the document, and press **OK**.
  - The machine starts to receive document and prints.

*Not all fax machines have polling capability, and polling incompatibility sometimes occurs between fax machines made by different manufacturers.*

# To cancel the scheduled job

---

All scheduled jobs remain in memory after they have been set. Cancel unnecessary scheduled jobs to make more memory available.

- 1 Press **Menu** repeatedly, and press **OK** when ADVANCED FAX appears.
- 2 Select Cancel Schedule by pressing **Left/right arrow** buttons, and press **OK**.
- 3 Select the reserved transmission you want to cancel by pressing **Left/right arrow** buttons repeatedly.
- 4 Press **OK** to cancel the selected schedule.

## 5.4

# Forwarding a fax or message

## Fax forwarding

While you are away from your home or office, you do not have to miss important faxes. Your machine can forward any faxes it receives to a fax machine at your new location, and it can print a copy for you to review when you get back as well.

- 1 Press **Menu** repeatedly, and press **OK** when **ADVANCED FAX** appears.
- 2 Select **Set Fax Forward** by pressing **Left/right arrow** buttons, and press **OK**.  
The display shows **Off**, **Forward** or **Forward & Print** whenever you press **Left/right arrow** buttons.
  - *Off*: disables fax forwarding
  - *Forward*: forwards a fax to your new location
  - *Forward & Print*: forwards a fax and prints it to your new location
- 3 Press **OK** after selecting **Forward** or **Forward & Print**.
- 4 Enter the fax number and press **OK**.
- 5 Enter the start time and press **OK**.
- 6 Enter the end time and press **OK**.
  - *The machine returns to Standby Mode and FWD will appear in the display at Fax Forward start time and every fax will be forwarded to your new location till the end time.*
  - *During forwarding time, the receive mode temporarily changes to:*

| If your model is | Receive mode     | In case                 |
|------------------|------------------|-------------------------|
| SF-370/SF-371P   | Fax              | -                       |
| SF-375TP         | TAM <sup>a</sup> | TAM message is recorded |
|                  | Fax              | no TAM message          |

a.TAM: Telephone Answering Machine

## Message forwarding (SF-375TP only)

When you're out of the office or home and you want to be notified whenever there's a new message left on your machine, you need to use the Message Forwarding feature supplied with your machine.

- 1 Press **Menu** repeatedly, and press **OK** when **SETUP TAM** appears.
- 2 Select **Message Forward** by pressing **Left/right arrow** buttons, and press **OK**.  
The display shows **Off** or **On** whenever you press **Left/right arrow** buttons.
  - *Off*: disables message forwarding
  - *On*: forwards a message to your new location
- 3 Press **OK** after selecting **On**.
- 4 Enter the fax number and press **OK**.  
If you have ever recorded any outgoing message (OGM) before, the machine asks if you want to change.  
If there is no recorded outgoing message (OGM), the machine asks to record OGM.
- 5 To change or record the Greeting press **OK**, and speak into the microphone.  
Or, press **Stop/Clear** to keep as it is.

# Received fax remote notification (SF-375TP only)

---

While you are away from your home or office, you can know if there is a new fax or not. Your machine can send a voice message with a recorded number you select when the new fax comes in.

- 1 Press **Menu** repeatedly, and press **OK** when ADVANCED FAX appears.
- 2 Select Set Fax Notice by pressing **Left/right arrow** buttons, and press **OK**.  
The display shows Off or On whenever you press **Left/right arrow** buttons.
  - *Off: disables auto fax notice*
  - *On: dials the number and leaves the voice message to notify the new fax*
- 3 Press **OK** after selecting On.
- 4 Enter the telephone number and press **OK**.  
If you have ever recorded a Fax auto notice outgoing message (OGM) before, the machine asks if you want to change.  
If there is no recorded outgoing message (OGM), the machine asks to record OGM.
- 5 To change or record the OGM press **OK**, and speak into the microphone.  
Or, press **Stop/Clear** to keep as it is.



# CHAPTER 6

## SPECIAL FEATURES

# Inserting a pause

---

With some private telephone systems, you must dial an access code (9, for example) and listen for a second dial tone before dialling an outside number. In such cases, you need to insert a pause in the number when you are registering Auto Dial such as a One-Touch or Speed Dial number.

If you are asked for the number when setting up Auto Dial, follow this procedure:

Press **Redial/Pause** to insert a pause while entering the number.

- A 'P' is inserted at the point where you pressed **Redial/Pause**. If you need a longer pause, press **Redial/Pause** as many times you want.

# Using Caller ID

---

The Caller ID system enables the receiver to view the numbers or names of callers. Once you have subscribed to Caller ID services, your machine can display caller information. To switch the Caller ID feature on:

- 1 Press **Menu** repeatedly until **SETUP SYSTEM** appears, and press **OK**.
- 2 Select Caller ID by pressing **Left/right arrow** buttons, and press **OK**.
- 3 Choose the desired option, and press **OK**.

- On: Activates the Caller ID feature.
- On /w Junk Fax: Activates Caller ID and ignores any fax registered as a junk fax (see "Registering/deleting the junk fax numbers" on page 6.5).
- Off: Deactivates the Caller ID feature.

**NOTE:** It depends on the country whether Caller ID system is supported or not.

# Using the Mute

---

While talking on the phone via speaker phone or handset, you may want to mute your voice for secret.

## To mute a call

Press **Mute** while speaking.

- The display shows **MUTE** to indicate it is activated.

## To release the mute

Press **Mute** to resume conversation.

# Recording a conversation (SF-375TP only)

---

While you are talking on the phone via speaker phone you may need to record the conversation for tracking a story. Your machine provides this convenience for your purpose.

## **To record the conversation**

Press **Play/Record** while you are speaking.

- *The machine starts to record the conversation, and recording time is unlimited before memory is full.*
- *The recorded conversation will be treated as an incoming message (ICM).*

## **To stop recording**

Press **Stop/Clear** to stop recording.

# Sound setup

---

You can set the alarm, key and wakeup sound.

- 1 Press **Menu** repeatedly until SETUP SOUND appears, and press **OK**.
  - *The display shows the three options you can set: Wakeup Sound, Alarm Sound and Key Sound.*
- 2 Press **Left/right arrow** buttons to select the option you want, and press **OK**.
- 3 Select On or Off and press **OK**.
- 4 If you selected Off, the alarm or key click does not make any sound.
- 5 If you selected On in the WakeUp Sound option, enter the time when the wakeup signal is ringing.
  - *The wakeup signal is sound even though Silent mode is enabled.*



# User reports

---

Your fax machine can print reports containing useful information — Scheduled Info, System Data, Help report, etc.

## To print a report

- 1 Press **Menu** respectively until **REPORTS** appears, and press **OK**.
- 2 Choose the report you want by using **Left/right arrow** buttons.
- 3 Press **OK** when the desired report is displayed.

The selected report will be printed. The available reports are shown below:

| Report name             | Content   | How it prints    |
|-------------------------|---|------------------|
| Help List               | This report covers the machine's basic functions and commands. It can also be used as a quick reference guide.  | Manual           |
| Sent Journal            | This report shows information concerning the transmission activities. They can be printed on command or if the machine is set to do so. It will automatically print after every 40 transmissions.   | Manual/Automatic |
| Received Journal        | This report shows information concerning the reception activities. They can be printed on command or if the machine is set to do so. It will automatically print after every 40 receptions.   | Manual/Automatic |
| Phonebook               | This report shows all of the numbers currently stored in the fax machine's memory as One-Touch Dial and Speed Dial.   | Manual           |
| Sending Confirm         | This report shows the fax number, the number of pages, elapsed time of the operation, the communication mode, and the communication results. Set up your machine as described in "Sending Confirm" on page 6.10 to automatically print Sending Confirm. | Manual/Automatic |
| Schedule Inform         | This report shows the document currently stored for Delayed FAX and Send Polling along with the operation number, starting time and type of operation, etc.   | Manual           |
| System Data             | This report shows the status of the User Options. After you have changed any setting, print this report to check your changes.  | Manual           |
| Caller ID               | This report shows the information of the most recent 30 callers who have called your machine.   | Manual           |
| Junk Fax                | This report shows the 20 telephone numbers which were marked as a junk fax.   | Manual           |
| TAM Status <sup>a</sup> | This report shows the status of the recorded messages. You can see when you have received a message and if you've listened to it or not.  | Manual           |
| Print Fax               | Your machine stores fax data into memory as far as the memory is available and lets you print it at later time. For more information, see "TAM:Telephone Answering Machine. SF-375TP only" on page 6.4.   | Manual           |

a. TAM:Telephone Answering Machine. SF-375TP only

# Re-Printing faxes

---

You may sometimes need to re-print a received fax. Your machine stores the most recently received faxes in memory. As this memory is filled, old faxes that have been printed will be erased to make room for new faxes. To access this facility:

- 1 Press **Menu** respectively until REPORTS appears, and press **OK**.
- 2 Press **Left/right arrow** buttons to choose Print Fax, and press **OK**.
  - If there are only old faxes, the machine will automatically print and returns to Standby mode without moving to the next step.
  - If there are no faxes in memory, the machine will inform you by displaying Memory Empty.
- 3 Select between Print New Fax OR Reprint Old Fax and press **OK**.
  - Print New Fax: *The machine prints all new faxes which have never been printed.*
  - Reprint Old Fax: *The machine prints all old faxes which have been previously printed.*

## Registering/deleting the junk fax numbers

---

Provided you have entered a junk fax number and activated the Caller ID option by selecting On /w Junk Fax, your machine will not receive any faxes registered as a junk fax. To set up the Caller ID, see "Using Caller ID" on page 6.2.

**NOTE:** It depends on the country whether Caller ID system is supported or not.

### Entering junk fax setup mode

- 1 Press **Menu** repeatedly until SETUP SYSTEM appears, and press **OK**.
- 2 Select Set Junk Fax No.
- 3 Press **OK** and follow the instructions below depending on the setup type.

#### To add a number

- 1 Choose Add and press **OK**.
  - The machine shows the first CID (Caller ID) number.
  - If the number is the same as one you have programmed in a One-Touch or Speed dial location and you assigned the name to that location, the machine shows the name instead of the number.
- 2 Select the CID number you want to register as a junk fax, and press **OK**.
  - You can scroll to the next one by pressing **Left/right arrow** buttons.
  - You can enter up to 20 numbers. Numbers which have already been entered as a junk numbers are marked by '\*' at the end of the display.

#### To delete a number

- 1 Choose Delete and press **OK**.
  - The machine shows the first junk number.
- 2 Select the junk fax number you want to delete, and press **OK**.
  - You can scroll to the next one by pressing **Left/right arrow** buttons.

# Using Short Message Service (SMS)

---

Your machine supports the short message service. Using this feature, you can transmit short messages sending to other machine and receive short messages coming from other machines such as faxes, computers, or mobile phones.

When you read or print your messages, the font not supported by your machine appears as blank. See page 9.5 and page 9.6 for information about font available with your machine.

## Reading SMS messages

You can read sent and received messages .

- 1 Press **Menu** repeatedly until SHORT MESSAGE appears, and press **OK**.
- 2 The first available option, Read, appears, then press **OK**.
- 3 Press **Left/right arrow** buttons until the menu item you want appears, and press **OK**.
  - You can choose Sent SMS or Received SMS .
- 4 The list of messages appears. Select the message you want to read by pressing **Left/right arrow** buttons and press **OK**.
  - The messages you do not read are marked with an asterisk(\*).
  - The machine can save up to 30 messages. Messages will not be lost even if power is disrupted.

## Sending SMS messages

You can send new SMS messages .

- 1 Press **Menu** repeatedly until SHORT MESSAGE appears, and press **OK**.
- 2 Select Send by pressing **Left/right arrow** buttons and press **OK**.
- 3 The first available option, New SMS, appears, then press **OK**.
- 4 Enter the text, and press **OK**.
  - See "How to enter letters" on page 1.7.
- 5 Enter the machine number you want to send SMS messages, and press **OK**.
- 6 Then Sending... appears in the display.

You can re-send SMS messages .

- 1 Press **Menu** repeatedly until SHORT MESSAGE appears, and press **OK**.
- 2 Select Send by pressing **Left/right arrow** buttons and press **OK**.
- 3 Press **Left/right arrow** buttons to choose Recall SMS, and press **OK**.
- 4 The list of messages appears.
- 5 If you want to send the same SMS messages you have just sent, then press **OK**.
  - Otherwise, if you want to send new SMS messages, then edit the text and press **OK**.
  - See "How to enter letters" on page 1.7.
- 6 Enter the machine number you want to send SMS messages, and press **OK**.

## 6.6

7 Then Sending... appears in the display.

## Printing SMS messages

You can print sent and received messages .

- 1 Press **Menu** repeatedly until SHORT MESSAGE appears, and press **OK**.
- 2 Select Print by pressing **Left/right arrow** buttons and press **OK**.
- 3 Press **Left/right arrow** buttons until the menu item you want appears, and press **OK**.
  - *You can choose* Print Sent SMS, Print RCV. SMS.
- 4 The selected menu item prints out.

## Deleting stored SMS messages

You can delete sent and received messages.

- 1 Press **Menu** repeatedly until SHORT MESSAGE appears, and press **OK**.
- 2 Select Delete by pressing **Left/right arrow** buttons and press **OK**.
- 3 Press **Left/right arrow** buttons until the menu item you want appears, and press **OK**.
  - *You can choose* Delete All, Delete Sent SMS or Delete RCV. SMS.  
*If you select* Delete All, *then all messages stored in the machine will be deleted.*
- 4 Press **Left/right arrow** buttons until the menu item you want appears, and press **OK**.
  - *You can choose* Delete All or Delete One in Delete Sent SMS or Delete RCV. SMS menu.
  - *If you select* Delete All, *then all sent or received messages stored in the machine will be deleted.*
- 5 The list of messages appears. Select one by pressing **Left/right arrow** buttons and press **OK**. The selected message is deleted.

## Setup SMS messages

The Message Transmitting and Receiving Center number is preset when you buy your machine. When you need to change SMS settings including the message transmitting center, receiving center number and a subaddress number, you can change settings.

To change the SMS center number:

- 1 Press **Menu** repeatedly until SHORT MESSAGE appears, and press **OK**.
- 2 Select Set SMS by pressing **Left/right arrow** buttons and press **OK**.
- 3 Using **Left/right arrow** buttons keys, scroll to SMS Center No.1, and press **OK**.
- 4 Enter the SMS Center number.
- 5 Press **OK** when the center number appears correctly in the display.

To change the subaddress number:

- 1 Press **Menu** repeatedly until SHORT MESSAGE appears, and press **OK**.
- 2 Select SET SMS by pressing **Left/right arrow** buttons and press **OK**.
- 3 Using **Left/right arrow** buttons keys, scroll to SMS Center No.1 or SMS Center No.2, and press **OK**.
- 4 Enter the SMS Center No.1 or SMS Center No.2 number of the machine.

### ***Register flow:***

Your machine is capable of transmitting and receiving SMS text messages from any SMS capable device.

Prior to transmitting and receiving SMS messages you must subscribe to the Caller Display Service on the line that the facsimile device is to be connected to. Please contact your telecoms provider to have this service enabled.

Having subscribed to the Caller Display Service, your machine must be registered with your telecoms provider. The Default SMS Center Number and Registration Number are preset on your fax machine. To register the device, please follow the instructions below:

- 1** Press **Menu** button repeatedly until SHORT MESSAGE appears, press **OK**.
- 2** Using **Left/right arrow** buttons keys, scroll along to SET SMS, press **OK**.
- 3** REGISTER is displayed in LCD, press **OK**.
- 4** Send Register is displayed, press **OK**.

The fax machine will send a registration SMS to the SMS Center and register the device.

Registration is now complete.

### ***Editing Registration Number:***

- 1** Press **Menu** button repeatedly until SHORT MESSAGE appears, press **OK**.
- 2** Using **Left/right arrow** buttons keys, scroll along to SET SMS, press **OK**.
- 3** REGISTER is displayed in LCD, press **OK**.
- 4** Using **Left/right arrow** buttons keys, scroll to Edit Register, press **OK**.
- 5** Enter registration number (provided by telecoms company), press **OK**.

### ***Editing SMS Center Number(s):***

- 1** Press **Menu** button repeatedly until SHORT MESSAGE appears, press **OK**.
- 2** Using **Left/right arrow** buttons keys, scroll along to SET SMS, press **OK**.
- 3** Using **Left/right arrow** buttons keys, scroll to SMS Center No.1, press **OK**.
- 4** Enter new SMS center number (provided by telecoms company), press **OK**.
- 5** A second SMS center number can be added by editing the SMS Center No.2 field

# Clearing memory

---

You can selectively clear information stored in your machine's memory.

- 1 Press **Menu** repeatedly until **MEMORY CLEAR** appears, and press **OK**.  
The display shows the type of information you can clear from memory.
- 2 Select what you want to delete by pressing **Left/right arrow** buttons, and press **OK**.
- 3 Select 'Y' and press **OK** when the machine asks if you are sure.

- The types of information you can clear are:

| Item           | It will  |
|----------------|--|
| System ID      | Delete your system ID.   |
| Dial/Schedule  | Clear the stored numbers in the Phonebook. In addition, all the Scheduled Jobs are also cancelled. |
| Journal        | Clear all records of transmissions and receptions.   |
| Default System | Restore user-selectable options to factory default value.  |

## User options

---

Your fax machine has various user-selectable features. These options are preset at the factory, but you may need to change them. To find out how the options are currently set, print the System Data List. For more information on printing a report, see "To print a report" on page 6.4.

### Setting system/TAM options

The System Setup includes settings related to fax operation, and TAM (Telephone Answering Machine) Setup has settings related to answering machine operations.

- 1 Press **Menu**.
- 2 Select **SETUP SYSTEM** or **SETUP TAM**<sup>6</sup> by pressing **Left/right arrow** buttons.
- 3 Press **OK** to enter specified Setup mode.
- 4 Scroll up or down by pressing **Left/right arrow** buttons to select the option you want to change.
- 5 Press **OK** when the option you want appears in the display.
- 6 Press **Left/right arrow** buttons to choose the desired status.
- 7 Press **OK** for the status you want.

- To exit Setup mode at any time, press **Stop/Clear**.
- When you press **Stop/Clear**, the machine stores the options you've changed, and returns to the Standby Mode.

### System setup options

The chart below shows the options in the left column and their suboptions in the right column.

---

6.TAM: Telephone Answering Machine. SF-375TP only

When you have entered System Setup, now you can see one of the options in the display by selecting **Left/right arrow** buttons. The right column shows the suboptions belonging to the options.

| Option                       | Suboption   |
|------------------------------|---|
| Ink Save                     | Used for less ink consumption. It toggles On and Off.   |
| Silent Mode                  | Used when you want to turn off all sounds made by the machine.  |
| Language                     | The LCD Language setting determines the language of the text that appears on the control panel display and information printing.  |
| Sending Confirm              | A confirmation report shows whether the transmission was successful or not, how many pages were sent, etc. Choose ON to print a confirmation report automatically each time you send a fax. Choose OFF not to print whatever the result is. Choose ERROR to print only when an error occurs, and the transmission was unsuccessful. Note that a confirmation report of a memory transmission includes the Image TCR (Transmission Confirmation Report) which shows the image of the first page with the various information depending on the value you made as described in "Image TCR" on page 6.11. |
| Paper Size                   | Select the paper size you will use for fax receive, and copying.  |
| Auto Reduction               | When receiving a document as long as or longer than the paper loaded, the machine can reduce the data to fit your paper. If the fax machine cannot fit the data into one page with the feature enabled, the data is divided and printed in actual size on two or more sheets.   |
| Discard Size                 | If you turn the Automatic Reduction feature off, you can set the fax machine to discard any excess image at the bottom of the page when receiving a document as long as or longer than the paper loaded in your machine. If the incoming fax is out of the margin you have set, it will be printed on two sheets of paper. Enter the desired Discard Size in millimeter.  |
| Rings To Answer              | You can select the number of rings before answering an incoming call. If you are using your machine as both a telephone and a fax machine, we suggest you set the ring count to at least 4 to give you time to answer.  |
| ECM Mode <sup>a</sup>        | This mode compensates for poor line quality and ensures accurate, error-free transmission with any other ECM-equipped facsimile machine. If the line quality is poor, transmission time may be increased when ECM is enabled.   |
| Send From Memory             | This determines how to transmit the document manually. If it is on, the machine will scan documents into memory and then send a fax. If it is off, the machine will first dial and send.  |
| Caller ID <sup>b,d</sup>     | You can see the number of the person calling you. Before using the Caller ID feature, Caller ID service must be installed on your telephone line by the telephone company. For more information, see "Using Caller ID" on page 6.2.   |
| Short Message <sup>b,d</sup> | You can use the short message service. Before using the Short Message service, it must be installed on your telephone line by the telephone company. For more information, see "Using Short Message Service (SMS)" on page 6.6.   |
| Set Junk Fax No.             | You can prohibit your machine from uncertified or unwanted junk faxes like spam mail. To add a number as a junk fax you should have at least one Caller ID detected by the machine. Even though you have added junk fax numbers, if you turned off the Caller ID option above, the Junk Fax protection will be removed. For more information, see "Registering/deleting the junk fax numbers" on page 6.5.  |
| Auto Journal                 | A journal report shows the specific information concerning transmission or reception activities, the time and date of most recent 40 transmissions or receptions.   |
| DRPD Mode <sup>c</sup>       | DRPD (Distinctive ring) is a service provided by some telephone companies that assigns two phone numbers to one phone line, each of which makes your phone ring differently. If you subscribe to this service, you can program your machine to learn one phone number and distinctive ring for incoming faxes.<br>As the display shows, call this fax from other fax machine. The machine will learn the ring pattern and displays DRPD OK when finished. Now, you can use the <b>Rcv.Mode/Darkness</b> to select DRPD receiving mode.  |
| Remote Test                  | This lets the service center check the status of your machine to find out if there is anything wrong.   |
| Resolution                   | Sets the default resolution when copying and faxing.  |

## 6.10

| Option                   | Suboption   |
|--------------------------|---|
| Darkness                 | Sets the default contrast when copying and faxing.  |
| Image TCR                | You can prevent the Image TCR (Transmission Confirmation Report) from being included in the confirmation report for privacy or security protection. |
| Dial Mode <sup>d</sup>   | Set the dialling mode to the type of the exchange to which you are connected.   |
| Behind PABX <sup>d</sup> | If your machine is connected to the line from PABX (Private Automatic Branch eXchange), you need to enable this option by selection On.             |

a. Error Correction Mode

b. This option may not work when connected to a PABX.

c. Distinctive Ring Pattern Detection

d. One or more options may not appear in the display depending on your country. If so, it is not applicable to your machine.

### **TAM<sup>7</sup> options (SF-375TP only)**

| Options         | Suboption  |
|-----------------|--|
| Save Charge     | Lets you dial into your machine from a remote phone and check whether anyone has left a message without being charged. When Save Charge is On, the machine answers your call on the number of rings you have specified in the Rings to Answer option. If there is no message, the machine answers on the second ring after the number of Rings to Answer. This gives you time to hang up the phone before the machine answers and saves the price of the call. |
| Call Monitor    | Enables you to hear callers leave messages on your machine.  |
| ICM Record Time | You can select the maximum time allowed for caller's incoming message (ICM) messages.  |
| Remote Password | You can change the three-character password used to access your machine from a remote phone. The password is preset to "#139#" at the factory. The first and the last #'s are fixed, but you can change the three middle numbers.  |
| Silence Action  | In TAM mode, the machine decides the next action when silence is detected for 10 seconds. Available suboptions are: <ul style="list-style-type: none"> <li>• Receive Fax: Switches to FAX Receive Mode.</li> <li>• Record Silence: Keeps the recording silent.</li> <li>• Disconnect: Disconnects the line and returns to Standby Mode.</li> </ul>   |
| Howler Action   | In TAM mode, the machine decides the next action when a howling is detected for 9 seconds. Available suboptions are: <ul style="list-style-type: none"> <li>• Record Howler: Disregards howling.</li> <li>• Disconnect: Disconnects the line and returns to Standby Mode.</li> </ul>   |
| Message Forward | Forwards a message to your new location whenever a caller leaves a message. For more information, see "Message forwarding (SF-375TP only)" on page 5.5.  |

---

7.TAM: Telephone Answering Machine





# CHAPTER 7

## USING PRINTING

This chapter is only for SF-371P and SF-375TP users.

# Making Connection

---

Connect the USB cable which came with your machine.

- The “New Hardware found” message is shown, click the “cancel” button.

## Installing Printer Software

---

This printer supports only black print.

You must install software using the supplied **Printer Software CD** after you have set up your machine and connected it to your computer.

### System Requirements

Verify the following:

- At least 128 MB (Windows 2000), 256 MB (Windows XP), 1024 MB (Windows Vista) or more of RAM is installed on your PC.
- There is at least 300 MB of free disk space on your PC.
- All applications are closed on your PC before beginning installation.
- You are using Windows 2000, Windows XP or Windows Vista.
- You are using at least Internet Explorer 5.0.

### Installing Printer Software

For Windows 2000/XP/Vista users, cancel the “New Hardware Found” screen when the computer boots up. Make sure that your machine is plugged in and connected to your computer’s USB port **before installing Printer Software** from the **Printer Software CD**.

**1** Insert the supplied **Printer Software CD** into your CD-ROM drive.

- The **Printer Software CD** should automatically run and the opening window appear.
- If the installation window does not appear, click **Start**, and then **Run**. Type **X:\setup.exe**, replacing “X” with the letter which represents your drive and click **OK**.
- If you use Windows Vista, click **Start** > **All Programs** > **Accessories** > **Run**, and type **X:\Setup.exe**.
- If the **AutoPlay** window appears in Windows Vista, click **Run**.
- **Setup.exe** in **Install or run program** field, and click **Continue** in the **User Account Control** window.



**2** Click **Next**.

- If necessary, select a language from the drop-down list.

## 7.2

**NOTE:** If your machine is not already connected to the computer, the following window will appear.



- If the machine is already connected and turned on, this screen does not appear. Skip to the next step.
- After connecting the machine, click **Next**.
- If you don't want to connect the machine at this time, click **Next**, and **No** on the following screen. Then the installation will start and a test page will not be printed at the end of the installation.

- 3 After the installation is finished, a window asking you to print a test page appears. If you choose to print a test page, select the checkbox and click **Next**.
- 4 If the test page prints out correctly, click **Yes**.  
If not, click **No** to reprint it.
- 5 To register yourself as a user of Samsung Printers in order to receive information from Samsung, select the checkbox and click **Finish**. You are now sent to the Samsung web site.  
Otherwise, just click **Finish**.



**NOTE:** After setup is complete, if your printer driver doesn't work properly, reinstall the printer driver.  
(See "Reinstalling Software" on page 7.4.)

# Setting the default printer

---

To set your printer as the default printer, follow the below steps:

- 1 Click the Windows **Start** menu.
- 2 For Windows 2000, select **Settings** and then **Printers**.  
For Windows XP, select **Printers and Faxes**.  
For Windows Vista, select **Control Panel > Hardware and Sound > Printers**.
- 3 Select Samsung SF-370\_CF-370 Series printer.
- 4 Click the right mouse button on the printer icon and:
- 5 For Windows 2000/XP/Vista, select **Set as Default Printers**.

## Reinstalling Software

---

You can reinstall the software if installation fails.

- 1 You can select **Start > All Programs > Samsung SF-370\_CF-370 Series > Maintenance**.
- 2 Select **Repair** and click **Next**.



**NOTE:** If your machine is not already connected to the computer, the following window will appear.



- If the machine is already connected and turned on, this screen does not appear. Skip to the next step.
- After connecting the machine, click **Next**.
- If you don't want to connect the machine at this time, click **Next**, and **No** on the following screen. Then the installation will start and a test page will not be printed at the end of the installation.

- 3 When the reinstallation is done, click **Finish**.

## 7.4

# Removing Printer Software

---

- 1 You can select **Start > Programs > Samsung SF-370\_CF-370 Series > Maintenance**.
- 2 Select **Remove** and click **Next**.
- 3 After the software is removed, click **Finish**.

## Printing a Document

---

The following procedure describes the general steps required for printing from various Windows applications. The exact steps for printing a document may vary depending on the application program you are using. Refer to the user's guide of your software application for the exact printing procedure.

- 1 Open the document you want to print.
- 2 Select **Print** from the **File** menu. The Print window is displayed. It may look slightly different depending on your application. Make sure that Samsung SF-370\_CF-370 Series is selected as your default printer.
  - *The basic print settings are selected within the Print window. These settings include the number of copies and the print range.*
- 3 Click **Features** if you want to make any adjustments that are appropriate for printing your document.
- 4 Now you see the Samsung SF-370\_CF-370 Series Printing Preferences window, which allows you to access all of information you need when using your machine.

The **Features** tab first displays.

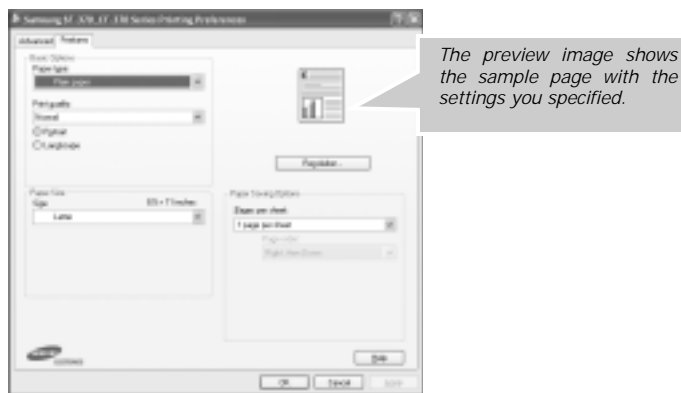

You can choose only in the plain paper in the **Paper Type**.

You can select the printing quality by choosing from **Fast Draft**, **Normal** or **Best**. The higher the setting, the sharper the printed characters and graphics. Higher settings may increase the time it takes to print a document.

The orientation option allows you to select the direction in which information is printed on a page.

- **Portrait** prints across the width of the page, letter style.
- **Landscape** prints across the length of the page, spreadsheet style.



▲ Landscape

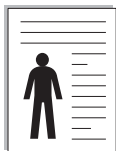

▲ Portrait

The **Pages per Sheet** option allows you to select the number of pages to print on a single sheet of paper. To print more than one page per sheet, the pages are smaller. When you select more than 2 pages per sheet, you can also select the page order among among **Right, then Down**, **Down then Right**, **Left then Down** or **Down then Left**.

Click the **Advanced** tab.



The **Poster Printing** option allows you to print a single-page document onto 4, 9, 16 or 25 sheets of paper, for the purpose of pasting the sheets together to form one poster-sized document.

The **Mirror Image** option allows you to print the page mirror view.

The **Page Order** option allows you to select the printing order in all pages **Front to Back** or **Back to Front**.

**5** Click **OK** to close the printer Preferences window.

**6** Click **OK** to start printing.

The printer's Preferences window may differ, depending on your operating system. This User's Guide shows the Preferences window on windows XP.

**NOTE:** Most Windows applications overrides the settings you specified in the printer driver. Change all of the print settings available in the software application first, and change any remaining settings using the printer driver.

The settings you change remain in effect only while you are using the current program. To make your changes permanent, make them in the **Printers** folder. Follow these steps:

- Click the Windows **Start** menu.
- For Windows 2000, select **Settings** and then **Printers**.  
For Windows XP, select **Printers and Faxes**.
- For Windows Vista, select **Control Panel** > **Hardware and Sound** > **Printers**.
- Select the **Samsung SF-370\_CF-370 Series** printer.

## 7.6

- Click the right mouse button on the printer icon and:
- For Windows 2000/XP, select **Printing Preferences**.  
For Windows Vista, select **Properties**.
- Change the settings on each tab and click **OK**.

## Cancelling a Print Job

To stop a print job from the Printers folder:

If the print job is waiting in a print queue or print spooler, such as the Printer group in Windows, delete the job as follows:

- Click the Windows **Start** menu.
- For Windows 2000, Select **Settings** and then **Printers**.  
For Windows XP, select **Printers and Faxes**.  
For Windows Vista, select **Control Panel > Hardware and Sound > Printers**.
- Double-click the Samsung SF-370\_CF-370 Series icon.
- From the **Document** menu, select **Cancel**.

**NOTE:** You can access this window simply by double-clicking the printer icon at the bottom right corner of the Windows desktop.

## Using Help

Your machine has a help screen that can be activated using the **Help** button in the printer's Preferences window. The help screen gives detailed information about the printer features provided by the printer driver.

You can also click  in the upper right hand corner, and then click on any setting.





# **CHAPTER 8**

## **CARE AND MAINTENANCE**

# Cleaning the document scanner

---

To keep your machine working properly, occasionally clean the White Roller, ADF (Automatic Document Feeder) Rubber, and the Scanning Glass. If they are dirty, documents sent to another fax machine won't be clear. *If you turn the power off to clean the scanner, documents stored in memory will be lost.*

1 Open the Control Panel.

2 Remove the White Roller.

- *At the right-hand end of the White Roller there is a bushing that is secured with a small tab.*
- *Push the tab slightly inward, then rotate towards you. Then pull up the right-hand part to take it out.*

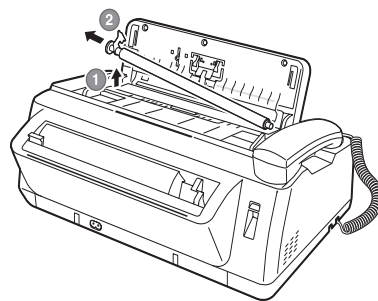
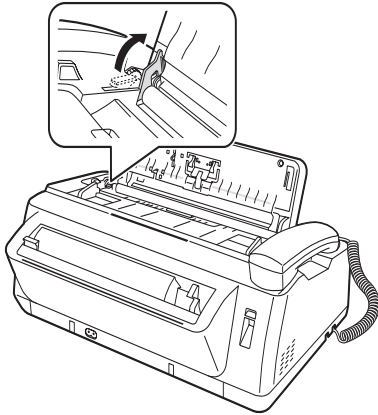

3 Wipe the roller surface with a soft cloth dampened with water.

4 Clean the ADF (Automatic Document Feeder) Rubber piece at the back of the Control Panel, too.

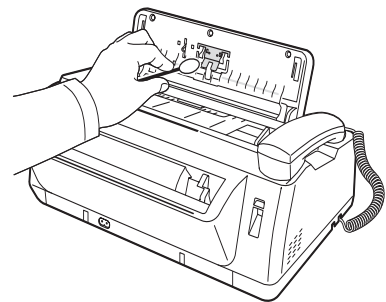

5 Carefully wipe the Scanning Glass with a soft, dry cloth.

- *If the glass is very dirty, first wipe it with a slightly dampened cloth, then with a dry one.*
- **BE CAREFUL!** *Be careful not to scratch the glass surface.*

6 Replace the roller in reverse order, and then close the Control Panel firmly until it clicks into place.

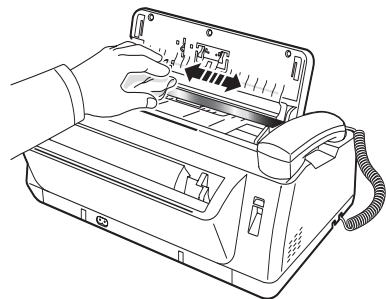

# Replacing the print cartridge

When you notice that the print becomes light or Ink Low. Install new ink cartridge appears in the display, replace the print cartridge. You should replace the cartridge with the same one which was provided with the machine.

The part number for replacement cartridges are:

- *mono*: INK-M41/41V for European countries.  
INK-M43 for India and South Africa.

**1** Prepare a cartridge.

- *Take out a cartridge from its packaging and carefully remove the tape covering the printhead.*
- *Hold the cartridge by the colored top or black areas only. Do not touch the copper area.*

**2** Press **Cartridge Change**.

The Cartridge Carrier moves to the install position.

**3** Open the Control Panel and Cartridge Compartment cover.

**4** Push down the cartridge, and remove it.

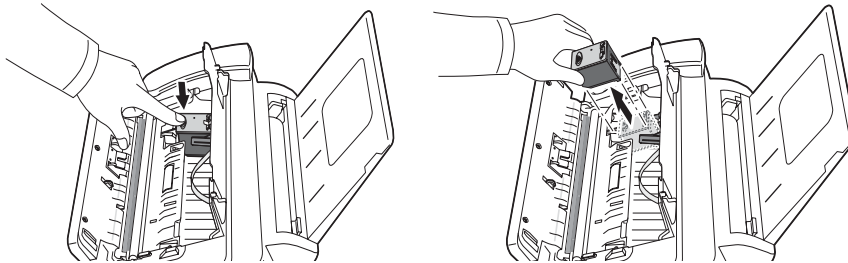

**5** To load the cartridge insert the cartridge below the metal clip and pointing down at the front. When the cartridge is pushed to the back of the cartridge carrier lift the front of the cartridge up until it clicks into place.

- *If the cartridge moves loosely in the Carrier, it has not clicked into place. Repeat this step.*

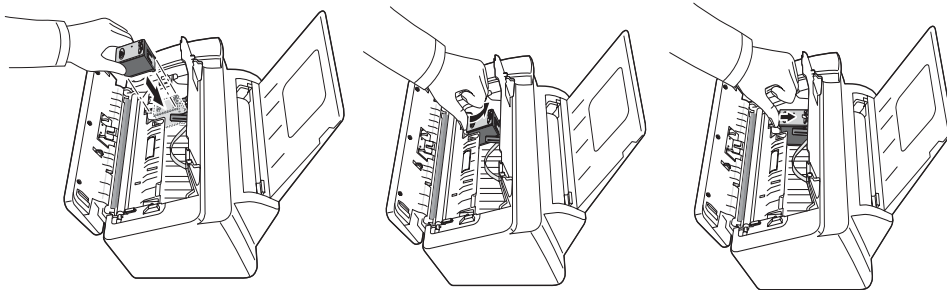

**6** Replace the Cartridge Compartment Cover and Control Panel.

**7** Press **OK**.

**8** Press 1 for new cartridge, or 2 for the old one.

- *In case you selected the 1:New, the alignment form will print.*
- *When you put in a new cartridge, you must choose 1:New.*
- *When you put in a used cartridge, choose 2:Used. This helps you to check the correct amount of ink you have left.*
- *If you mix up several used cartridges, it is not possible to check the correct amount of remaining ink. Once you have put in a new cartridge, use it until it is completely exhausted.*

**9** Enter the number which represents the straightest line, and press **OK**.

# Cleaning the printhead

---

If the nozzles seem to be clogged and characters are not printing completely, clean the printhead as described below:

- 1 Press **Menu** repeatedly until MAINTENANCE appears, and press **OK**.
- 2 Scroll to Clean Head by pressing **Left/right arrow** buttons, and press **OK**.
- 3 Examine the printed test pattern.
  - If print quality does not improve, reinstall the cartridge and repeat Clean Head.
  - If the line is still broken, wipe the nozzles and contacts.  
*For more information, see "Wiping the print nozzles and contacts" on page 8.5.*

# Aligning the printhead

---

When the vertical line does not seem to be straight or you want to improve the print quality, you may need to align the cartridge.

- 1 Press **Menu** repeatedly until MAINTENANCE appears, and press **OK**.
- 2 Scroll to Align Head by pressing **Left/right arrow** buttons, and press **OK**.
  - The machine prints a form.
- 3 Enter the number which represents the straightest line, and press **OK**.

# Ink level view

---

Your machine allows you to check the amount of ink remaining. To view the current ink level:

- 1 Press **Menu** repeatedly until MAINTENANCE appears, and press **OK**.
- 2 Scroll to View Ink Level by pressing **Left/right arrow** buttons, and press **OK**.
  - The machine displays a fractional number. For examples, '1/8' means that ink is low and you need to replace the cartridge. '8/8' means that a new cartridge is installed.

# Shading adjustment

---

The shading is adjusted at the factory. If, however, you drop and damage your machine while moving, we recommend you adjust shading for optimized lightness.

To adjust shading, do as follows:

- 1 Press **Menu** repeatedly until MAINTENANCE appears, and press **OK**.
- 2 Scroll to Adjust Scanner by pressing **Left/right arrow** buttons, and press **OK**.
- 3 Load a plain WHITE sheet of paper (no writing or graphics) into the loading slot, and press **OK**.
  - The machine starts to scan the document to adjust shading.
  - Printing quality may be unexpectedly worse if you do not use a plain WHITE paper for the adjustment.

# Self testing

---

When you want to test if the machine is working correctly, you can check it by running self test.

- 1 Press **Menu** repeatedly until MAINTENANCE appears, and press **OK**.
- 2 Scroll to Self Test by pressing **Left/right arrow** buttons, and press **OK**.
  - *The machine runs self test and prints a report which shows the current status of the machine.*

# Print cartridge maintenance

---

The print cartridge life is very sensitive to the content of the received fax or a copy you made. To increase its life, we recommend you follow the instructions below:

- *DO NOT unpack the cartridge until you are ready to use it.*
- *Store it in the same environment as the printer.*
- *If you have unpacked the cartridge but are not using it, store it in a storage unit. If you do not have a storage unit, store the cartridge in an airtight plastic bag.*
- *DO NOT leave it exposed for an extended period.*
- *DO NOT refill the cartridge. The warranty will not cover damage caused by using refilled cartridges.*

# Cleaning the cartridge

---

To maintain good printing quality, we recommend you occasionally wipe the Print Nozzles and Contacts as described below:

## Wiping the print nozzles and contacts

When the print is not clear or dots are missing, the problem may be caused by dried ink on the:

- *Print cartridge nozzles*
- *Print cartridge contacts*
- *Print cartridge carrier contacts*

- 1 Press **Cartridge Change**.
- 2 Open the Control Panel and Cartridge Compartment Cover and remove the cartridge.
- 3 Gently blot and wipe the contacts and nozzles dry.
  - **BE CAREFUL!** *Use a clean cloth dampened with water only to gently clean the entire copper-colored area, including the nozzles and contacts.*
  - *To dissolve any dried ink, hold the damp cloth against the nozzles for about three seconds.*
- 4 Reinstall the cartridge and close the Cover and Panel.
  - *If you spend a long time cleaning the cartridge, the cartridge carrier may have moved back to the original position. If so, press **Cartridge Change** again to move the carrier to the install position.*
- 5 Press 1 for new cartridge, or 2 for the old one.
  - *If the line is still broken, clean the Cartridge Carrier contacts. For more information, see "Cleaning the cartridge carrier contacts" on page 8.6.*

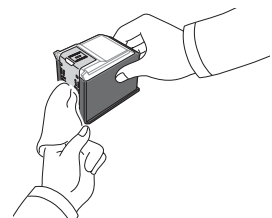

## Cleaning the cartridge carrier contacts

*Before cleaning these parts, there should be no scheduled job such as Delayed Fax, Send Polling, or faxes received into memory. Once you have unplugged the power cord from the machine, all data will be lost.*

- 1 Press **Cartridge Change**.
- 2 Open the Control Panel and Cartridge Compartment Cover and remove the cartridge.
- 3 Remove the print cartridge.
- 4 Unplug the power cord from the electrical outlet of the rear of the machine.
  - **BE CAREFUL!** *Once you have unplugged the power cord from the machine, all scheduled job such as Delayed Fax, Send Polling, or faxes received into memory will be lost.*
- 5 Clean the Cartridge Carrier contacts with clean and dry cloth.
- 6 Plug in the power cord and reinstall the cartridge.

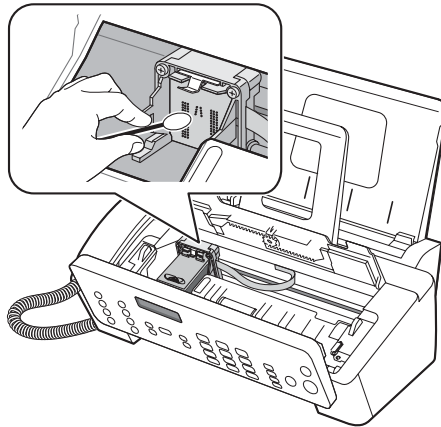

# LCD error messages

| Display  | Status/Solution  | Related to:            |
|--|--|------------------------|
| Adjust scanner first in Maintenance menu                                 | The shading waveform to be used as a reference is corrupted due to unknown reason. Adjust the scanner to fix this problem as described in "Shading adjustment" on page 8.4.  | Scanner                |
| Check white paper document and try again                                 | The scanning level is too low to compare with reference level. To adjust shading, you should use the plain and white paper.  | Scanner                |
| CID: No Number   | The detected Caller ID has no information about phone number.  | Fax/Telephone          |
| CID: Number Error  | The parity or checksum error was occurred in detected Caller ID.   | Fax/Telephone          |
| CID: Private   | The detected Caller ID is defined as Private.  | Fax/Telephone          |
| Clean white roller, glass and try again                                  | The scanning level is slightly low, which can affect the image quality. To clean concerned parts, see "Cleaning the document scanner" on page 8.2.   | Scanner                |
| Connect Tel Line   | The machine automatically checks a telephone line status during powering up whether it is correctly connected or not.  | Fax/Telephone          |
| Duplicated with [Speed No.xx]<br>The 'xx' indicates the location number. | The same number has already been registered into another speed dial location.  | Telephone              |
| Exceeded Job Memory  | The machine can hold 3 <b>My Favorites</b> but you tried to add more.  | Fax                    |
| Exceeded Job Memory<br>Cancel scheduled job and try again                | The broadcasting and delayed fax can hold 5 jobs in total. Cancel scheduled job and try again.   | Fax                    |
| Exceeded Total Message Memory  | The machine can hold up to 200 messages which include Greetings, ICM (InComing Messages) and recorded conversations. Erase old messages to make a room in the memory.  | TAM<br>(SF-375TP only) |
| ICM Memory Full  | The voice memory is full. No more caller's ICM (InComing Messages) can be recorded (Total recording time is about 30 minutes).   | TAM<br>(SF-375TP only) |
| Ink Low. Install new ink cartridge                                       | The print cartridge has run out of ink. To install a new Print Cartridge, see "Replacing the print cartridge" on page 8.3. Although this message is displayed, you can make a copy or print a report. But, stored data in memory can be printed by changing the cartridge. | Cartridge              |
| Install ink cartridge  | Print cartridge is not installed or improperly installed.  | Cartridge              |
| Invalid Time   | The time you set for fax forwarding is wrong.  | Fax                    |
| Job Not Assigned   | You attempted to cancel the scheduled job but there is no jobs scheduled. You attempted to delete or print send the My Favorites document when there is no document stored.  | Fax                    |
| Junk Fax Empty   | You attempted to delete the junk fax number when there is no junk fax number.  | Fax                    |
| Junk Fax Full  | The machine can hold 20 junk fax Full numbers but you tried to add more.   | Fax                    |
| Load Document  | You have tried to send a fax and there is no document loaded into the machine.   | Document               |
| Load paper and press ok  | You have tried to do any job and there is no paper loaded into the machine.  | Paper                  |



| Display  | Status/Solution   | Related to:            |
|--|---|------------------------|
| Memory Full  | Memory has become full while receiving a fax or short message.  | Fax/Telephone          |
| Memory Full<br>Press OK to continue  | Memory has become full while scanning a document. Press <b>OK</b> to send or copy the scanned pages only. To cancel the job press <b>Stop/Clear</b> and try again when memory becomes available, or split the new document into smaller parts.  | Fax/Copy               |
| Memory Received<br>When it toggles with:<br>Ink Low. Install new ink cartridge<br>Load paper and press OK<br>Install ink cartridge | The machine has data stored in memory. Depending on the message do as follows:<br>Replace the print cartridge with new one.<br><br>Load the paper, and press <b>OK</b> . There might be a jam. Clear the jam as described in "Paper jams during printing" on page 8.12.<br>Install a print cartridge. | Fax                    |
| No answer from remote fax  | The other machine has not answered after all your attempts to send a fax.   | Fax                    |
| No CID Number  | The machine could not detect the CID (Caller ID) number.  | Telephone              |
| No Dial Number   | There is no number in the redial memory, which is successfully dialled up to now.   | Telephone              |
| No Message   | There is no message to play or erase. There is no received short message to read or print.  | TAM<br>(SF-375TP only) |
| No New Message   | There is no new caller message. There is no received short message.   | TAM<br>(SF-375TP only) |
| Not available while reprinting fax   | The machine can not receive a new fax while printing the stored faxes.  | Fax                    |
| Not Found  | The number you are searching does not exist in memory.  | Telephone              |
| Number already registered  | The number you are trying to register already exists in the phonebook or junk fax list.   | Telephone              |
| Number Not Assigned  | There is no number assigned to the One-Touch or two-digit Speed number.   | Telephone              |
| OK Again   | The number that you entered is outside the range of speed dial number, i.e. more than 100.  | Fax/Telephone          |
| Poll Code Error  | The remote user entered wrong poll code.  | Fax                    |
| Poll job exists already  | You have programmed a polling send. Cancel scheduled job and try again.   | Fax                    |
| Polling Error<br>Check remote site   | The machine you want to poll is not ready to answer your poll. The person you are polling should have loaded their fax machine with a document and be in send poll state.   | Fax                    |
| Processing Job   | You attempt to enter My Favorites, while sending My Favorites document or printing My Favorites document.   | Fax                    |
| Receiving Error.<br>Ask sender to try again.   | There is an error while receiving a fax.  | Fax                    |
| Record TAM OGM   | To select TAM (Telephone Answering Machine) receive mode, you should record OGM (Out Going Message) prior to pressing the <b>Answer</b> button.   | TAM<br>(SF-375TP only) |
| Remove jammed document   | The document you are sending has jammed in the feeder. To clear the document jam, see "Document jams during transmission" on page 8.12.<br>You tried to copy or fax a document which is longer than 390 mm.   | Document               |

| Display  | Status/Solution  | Related to: |
|--|--|-------------|
| Remove jammed paper and press Stop/Clear.      | The paper has jammed during printing. To clear the paper jam, see "Paper jams during printing" on page 8.12.   | Paper       |
| System Busy<br>Try again later                 | There is no available resource to execute job you ordered.   | Fax         |
| Send Error. Try again.                         | There is an error while sending a fax.   | Fax         |
| System Initial                                 | It indicates that the machine is initializing when the power is on.  | System      |
| To Clear Carrier Stall Error, Press Stop/Clear | The cartridge carrier is stalled during printing or copying.   | Paper       |
| To redial now, press Start Fax                 | The machine is waiting to automatically redial the fax number that was busy or did not answer.   | Fax         |
| Used Cartridge is installed                    | You tried to install a used pen with selecting New option.<br>To remove this message, Install a new pen or select Used option for installing the used one. | Cartridge   |

# Fixing Problems

---

Your problem may be listed in "LCD error messages" on page 8.7. The chart below shows other problems you can solve yourself. If not, call the service company shown in the separate Warranty Card.

## Fax problems

| Problem   | Solution  |
|---|---|
| The machine is not working, there is no display and the buttons are not working.  | Unplug the power cord and plug it in again. Check that your socket is live.   |
| No dial tone.   | Check that the phone is connected properly. Check the phone socket in the wall by plugging in another phone.  |
| The numbers stored in memory do not dial correctly.   | Make sure the numbers are programmed correctly. To print a Phonebook Report, see "To print a report" on page 6.4.   |
| The document does not feed into the machine.  | Be sure the document is not wrinkled, and you are putting it in correctly. Check that the document is the right size and not too thick or too thin.   |
| You cannot receive faxes automatically.   | Check if TEL appears on the right side of the display. In TEL mode, you cannot receive a fax automatically. Be sure the handset is seated on the cradle properly.   |
| The machine cannot receive faxes manually.  | Do not hang up the handset before pressing <b>Start fax</b> .   |
| The machine does not send anything.   | Check that the document is loaded face down. Send should show up in the display. You may have hung up the handset before you pressed <b>Start fax</b> . Check if the machine to which you are sending can receive your fax. |
| You cannot poll another machine.  | The fax machine you are polling may be using a poll code.   |
| The fax you received has blank bits on it.  | The machine sending to you may be faulty. A noisy phone line can cause line errors. Check your machine by making a copy.  |
| Spots or lines missing from the fax you receive.  | Check if your phone line is noisy. Check if the printhead is clean by making a copy.  |
| You are receiving poor quality copies.  | The fax machine sending to you may have a dirty scan glass. Check for a noisy phone line.   |
| Some of the stretched words on the fax you receive  | The machine sending to you had a temporary document jam.  |
| Your machine does not make copies.  | Make sure your document is loaded face down.  |
| There are lines on copies or documents you send.  | Check your scan glass for marks and clean it (see "Cleaning the document scanner" on page 8.2).   |
| The machine dials a number, but fails to make a connection with a remote fax machine.   | The remote fax machine may be turned off, or unable to answer incoming calls. Speak with the remote operator and ask for the problem to be rectified.   |
| You cannot store a document in memory.  | There may not be enough memory available to hold the document you want to store. If the display shows a Memory Full message, delete any documents you no longer need, then retry the document.                              |
| Blank areas appear at the bottom of each page or on continuation pages, with only a small strip of material printed at the top. | You may have selected the wrong paper settings. To select the proper paper size, see "Paper Size" on page 6.10.   |

## Print quality problems

| Problem                                     | Solution  |
|---|---|
| Light or blurred characters.                | Check Ink Level View as described in "Ink level view" on page 8.4. If the printer cartridge has completely run out, Ink Low. Install new ink cartridge is displayed. To install a new print cartridge, see "Replacing the print cartridge" on page 8.3. Make sure the print cartridge is installed correctly. To clean the print cartridge, see "Cleaning the cartridge" on page 8.5. |
| Smudged or dark characters.                 | Make sure the paper is straight and unwrinkled. Let ink dry before handling the paper. To clean the print cartridge, see "Cleaning the cartridge" on page 8.5.  |
| Characters with white lines.                | If Ink Low. Install new ink cartridge is displayed, install a new print cartridge as described in "Replacing the print cartridge" on page 8.3. Remove and reinstall the print cartridge. Clean the print cartridge (see "Cleaning the cartridge" on page 8.5).  |
| Improperly formed or misaligned characters. | Clean the print cartridge (see "Cleaning the cartridge" on page 8.5).   |
| Abnormal black horizontal lines             | Clean the cartridge carrier (see "Cleaning the cartridge carrier contacts" on page 8.6).  |

## Paper feeding problems

| Problem   | Solution  |
|---|---|
| Paper is jammed during printing.                      | Clear paper jam as described in "Paper jams during printing" on page 8.12.  |
| Paper sticks together.                                | You can load up to 50 sheets in the ASF (Automatic Sheet Feeder). Check if you overloaded. Humid conditions may cause some paper to stick together.                                 |
| Paper fails to feed.                                  | Remove any obstructions inside the printer.   |
| Multiple sheets of paper feed.                        | When loading paper, do not force the paper down into the printer. If multiple sheets have caused a paper jam, clear the paper jam. (See "Paper jams during printing" on page 8.12.) |
| Paper skews or buckles in the automatic sheet feeder. | ASF can hold up to 50 sheets. Make sure the paper guides do not cause the paper to bow in the bin. When loading paper, do not force it down into the printer.                       |

# Clearing jams

---

## Document jams during transmission

If a document jams during transmission or copying, Remove jammed document appears in the display. **DO NOT** pull the document out of the slot. Doing so could harm your machine.

### To clear document jam:

- 1 Open the Control Panel.
- 2 Carefully remove the jammed document.
- 3 Close the Control Panel firmly until it clicks into place.

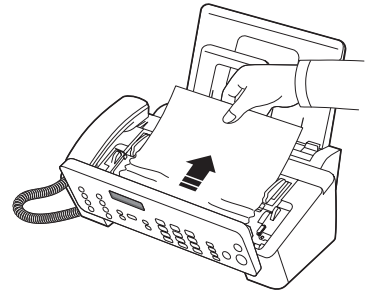

## Paper jams during printing

If the fax paper jams while you are receiving or printing, Remove jammed paper and press Stop/Clear appears in the message.

### If the paper is jammed in the Received Paper Output Area

- 1 Remove the jammed paper by pulling it out smoothly in the direction of the arrow as shown.
  - If the paper tears when it is being removed check to ensure that no small pieces have been left inside the machine.
- 2 Press **Stop/Clear**.

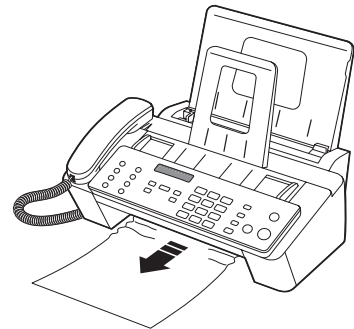

### If the paper is jammed in the Paper Feed Area

- 1 Remove the jammed paper as shown.
  - If the paper tears when it is being removed check to ensure that no small pieces have been left inside the machine.
- 2 Reload new paper with the print side facing toward you.
- 3 Press **Stop/Clear** when finished.

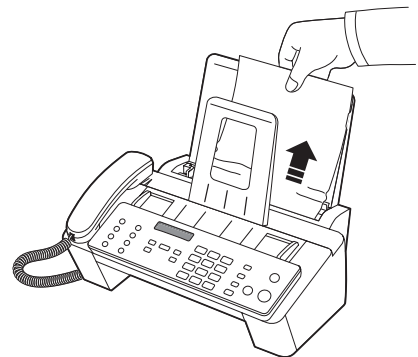

# CHAPTER 9

## APPENDIX

# Specifications

## General specifications

| Item  | Description   |
|---|---|
| ADF (Automatic Document Feeder)             | Up to 15 sheets (0.1 mm thickness, 75 g/m <sup>2</sup> bond)  |
| ADF document size                           | Width: 148 to 216 mm<br>Length: 128 to 390 mm   |
| ASF (Automatic Sheet Feeder)                | Up to 50 sheets (75 g/m <sup>2</sup> bond)  |
| ASF document size                           | A4 (210 x 297 mm), Letter (216 x 279 mm), Legal (216 x 356 mm)  |
| Consumables                                 | 1-piece Ink cartridge system  |
| Power rating                                | See Rating label attached on the back of the machine.   |
| Power consumption                           | Standby: 4.9 Wh<br>Printing mode: Maximum 15 Wh   |
| Noise level <sup>a</sup>                    | @ idle mode: 40 dB<br>Average: 55 dB<br>Maximum: 65 dB  |
| Operating environment                       | Temperature: 10 °C to 32 °C<br>Humidity: 20% to 80% RH  |
| Display                                     | 16 characters x 1 lines   |
| Ink cartridge life <sup>b</sup>             | Initial Cartridge (supplied with the machine; INK-M41S / 43S):<br>About 265 sheets (based on ITU #1 chart <sup>c</sup> - See "A sample of ITU #1 chart (reduced to 60.5%)" on page 9.4<br>Replacement Cartridge (to be purchased in the market; INK-M41/41V for European countries, INK-M43 for India and South Africa):<br>About 750 sheets (based on ITU #1 chart - See "A sample of ITU #1 chart (reduced to 60.5%)" on page 9.4 |
| External dimension with handset (W x D x H) | Without Handset and Paper Support: 355 x 232 x 118 mm (14.0 x 9.1 x 4.6 inches)<br>With Handset and Paper Support: 355 x 311 x 244 mm (14.0 x 12.2 x 9.6 inches)  |
| Weight with handset and ink cartridge       | 2.5 Kg  |
| Package weight                              | Paper: 0.81 Kg, Plastic: 0.14 Kg  |
| Duty cycle                                  | Monthly print: Up to 1,000 pages  |

a. Sound Pressure Level, ISO 7779, 9296

b. The number of pages may be affected by operating environment, printing interval, media type, and media size.

c. ITU #1 chart: Standardized test chart published by International Telecommunication Union for document facsimile transmissions.

## Printer specifications (SF-371P and SF-375TP only)

| Item                          | Description   |
|-------------------------------|---|
| Printing method               | Thermal Inkjet Printing   |
| Printing speed <sup>a</sup>   | Up to 4.0 ppm in A4 (mono print speed @ Draft mode)                 |
| Print resolution              | Up to 600 x 600 dpi effective output (mono print speed @ Best mode) |
| Printer language              | PCL 3   |
| OS Compatibility <sup>b</sup> | Windows 2000/XP/Vista   |
| Interface                     | USB 2.0 Full Speed (Compatible with USB 2.0 specification)          |

## 9.2

- a. Print speed will be affected by operating system used, computing performance, application software, connecting method, media size, and job complexity.
- b. Please visit [www.samsungprint.com](http://www.samsungprint.com) to download the latest software version.

## Scanner and copier specification

| Item                     | Description  |
|--------------------------|--|
| Scanning method          | CIS (Contact Image Sensor)   |
| Resolution               | Optical scan: 200 x 200 dpi  |
| Effective scanning width | Max 210 mm   |
| Copy speed <sup>a</sup>  | Up to 3 cpm in A4 (mono copy speed @ Draft mode)   |
| Copy resolution          | Scan: up to 200 x 200 dpi<br>Print: up to 600 x 300 dpi (mono copy resolution @ Best mode) |
| Zoom rate                | 50 ~ 150 %   |
| Multiple copies          | 1 ~ 50   |
| Grayscale                | 64 Grayscale   |

- a. Copy speed is based on single document multiple copy.

## Facsimile specifications

| Item               | Description  |
|--------------------|--|
| Compatibility      | ITU <sup>a</sup> T30   |
| Application line   | Public Switched Telephone Network (PSTN) or behind PABX  |
| Data coding        | MH/MR/MMR  |
| Modem speed        | 14400/12000/9600/7200/4800/2400 bps  |
| Transmission speed | About 6 seconds ( Standard mode) <sup>b</sup>  |
| Resolution         | Standard: 203 x 98 dpi<br>Fine: 203 x 196 dpi<br>Super fine: 203 x 392 dpi<br>Photo: 203 x 196 dpi   |
| Memory             | 2.5 Mbytes (capable of 200 pages at 4% print duty on A4: SF-375TP)<br>1.875 Mbytes (capable of 150 pages at 4% print duty on A4: SF-370 and SF-371P)<br>256 Kbytes (capable of 20 pages at 4% print duty on A4 and for My Favorites) |
| Halftone           | 64 level   |
| Auto dialer        | One-Touch buttons (up to 10 numbers)<br>Speed dialing (up to 100 numbers)  |

- a. ITU: International Telecommunication Union
- b. Transmission time applies to memory transmission of text data with ECM (Error Correction Mode) compression using only ITU-T No.1 Chart.



# A sample of ITU #1 chart (reduced to 60.5%)



# Font List for Print

|       |   |   |    |    |   |   |   |   |   |   |   |   |   |   |       |
|-------|---|---|----|----|---|---|---|---|---|---|---|---|---|---|-------|
| NUL   | ☺ | ☹ | ♥  | ♦  | ♣ | ♠ | • | ◼ | ○ | ◐ | ♂ | ♀ | ♪ | ♫ | €     |
| ▶     | ◀ | ↕ | !! | ¶  | § | ▬ | ↕ | ↑ | ↓ | → | ← | └ | ↔ | ▲ | ▼     |
| space | ! | " | #  | \$ | % | & | ' | ( | ) | * | + | , | - | . | /     |
| 0     | 1 | 2 | 3  | 4  | 5 | 6 | 7 | 8 | 9 | : | ; | < | = | > | ?     |
| @     | A | B | C  | D  | E | F | G | H | I | J | K | L | M | N | O     |
| P     | Q | R | S  | T  | U | V | W | X | Y | Z | [ | \ | ] | ^ | _     |
| `     | a | b | c  | d  | e | f | g | h | i | j | k | l | m | n | o     |
| p     | q | r | s  | t  | u | v | w | x | y | z | { |   | } | ~ | △     |
| Ç     | ü | é | â  | ä  | à | â | ç | ê | ë | è | ï | î | ì | Ä | Å     |
| È     | æ | Æ | ô  | ö  | ò | û | ù | ÿ | Ö | Ü | ø | £ | Ø | × | f     |
| á     | í | ó | ú  | ñ  | Ñ | ª | º | ¿ | ® | ¬ | ½ | ¼ | ¡ | « | »     |
| ▤     | ▥ | ▧ |    | †  | Á | Â | À | © | ℥ |   | ¶ | ⌘ | ¢ | ¥ | ₹     |
| ⊥     | ⊥ | τ | †  | -  | + | ã | Ã | ℓ | ℝ | ≡ | π | ‡ | = | ‡ | ¤     |
| ø     | Ð | Ê | Ë  | È  | ı | Í | Î | Ï | ⋈ | ı | ■ | ■ |   |   | ■     |
| Ó     | β | Ô | Ò  | õ  | Õ | μ | þ | Ɔ | Ú | Û | Ù | Ý | Ý | — | ´     |
| -     | ± | = | ¾  | ¶  | § | ÷ | , | ° | ¨ | . | ¹ | ³ | ² | ■ | space |

# Font List for LCD

|    |   |   |   |   |   |   |   |   |   |   |   |   |   |
|----|---|---|---|---|---|---|---|---|---|---|---|---|---|
| €  | 0 | @ | P | ` | p | Б | Ю | б | ю | À | Ð | à | đ |
| !  | 1 | A | Q | a | q | Г | Я | г | я | Á | Ñ | á | ñ |
| "  | 2 | B | R | b | r | Д | З | д | з | Â | Ò | â | ò |
| #  | 3 | C | S | c | s | Ж | У | ж | у | Ã | Ó | ã | ó |
| \$ | 4 | D | T | d | t | И | Ь | и | ь | Ä | Ô | ä | ô |
| %  | 5 | E | U | e | u | Й |   | й | в | Å | Õ | å | õ |
| &  | 6 | F | V | f | v | Л |   | л | к | Æ | Ö | æ | ö |
| '  | 7 | G | W | g | w | П |   | п | м | Ç | Œ | ç | œ |
| (  | 8 | H | X | h | x | Ф |   | ф | н | È | Ø | è | ø |
| )  | 9 | I | Y | i | y | Ц |   | ц | т | É | Ù | é | ù |
| +  | : | J | Z | j | z | Ч | Е | ч | т | Ê | Ú | ê | ú |
| +  | : | K | [ | k | { | Ш | У | ш | л | Ë | Û | ë | û |
| ,  | < | L | \ | l |   | Щ | Ö | щ | ó | Ì | Ü | ì | ü |
| -  | = | M | ] | m | } | Ъ | Û | ъ | ù | Í | Ý | í | ý |
| .  | > | N | ^ | n | → | Ы | Ğ | ы | ğ | Î | Þ | î | þ |
| /  | ? | O | _ | o | ← | Э | Ş | э | ş | Ï | В | ï | ƒ |

# Replacing the fitted plug (UK)

---

## IMPORTANT

The mains lead for this machine is fitted with a standard (BS 1363) 13 amp plug and has a 13 amp fuse. When you change or examine the fuse, you must re-fit the correct 13 amp fuse. You then need to replace the fuse cover. If you have lost the fuse cover, do not use the plug until you have another fuse cover.

Please contact the people from you purchased the machine.

The 13 amp plug is the most widely used type in the UK and should be suitable. However, some buildings (mainly old ones) do not have normal 13 amp plug sockets. You need to buy a suitable plug adaptor. Do not remove the moulded plug.

## WARNING

If you cut off the moulded plug, get rid of it straight away.

You cannot rewire the plug and you may receive an electric shock if you plug it into a socket.

IMPORTANT WARNING : You must earth this machine.

The wires in the mains lead have the following color code:

- Green and Yellow: Earth
- Blue: Neutral
- Brown: Live

If the wires in the mains lead do not match the colors marked in your plug, do the following:

You must connect the green and yellow wire to the pin marked by the letter "E" or by the safety 'Earth symbol' or colored green and yellow or green.

You must connect the blue wire to the pin which is marked with the letter "N" or colored black.

You must connect the brown wire to the pin which is marked with the letter "L" or colored red.

You must have a 13 amp fuse in the plug, adaptor, or at the distribution board.

# Notes for use of this device (New Zealand)

---

The grant of a Telepermit for any item of terminal equipment indicates only that Telecom has accepted that the item complies with minimum conditions for connection to its network. It indicates no endorsement of the product by Telecom, nor does it provide any sort of warranty. Above all, it provides no assurance that any item will work correctly in all respects with another item of Telepermitted equipment of a different make or model, nor does it imply that any product is compatible with all of Telecom's network services.

This equipment shall not be set up to make automatic calls to the Telecom '111' Emergency Service.

This equipment may not provide for the effective hand-over of a call to another device connected to the same line.

## **Important Notice**

Under power failure conditions, this telephone may not operate. Please ensure that a separate telephone, not dependent on local power, is available for emergency use.

# Declaration of conformity (European countries)

---

## *Approvals and Certifications*



The CE marking applied to this product symbolises Samsung Electronics Co., Ltd. Declaration of Conformity with the following applicable 93/68/EEC Directives of the European Union as of the dates indicated:

**January 1, 1995:** Council Directive 73/23/EEC Approximation of the laws of the member states related to low voltage equipment.

**January 1, 1996:** Council Directive 89/336/EEC (92/31/EEC), approximation of the laws of the Member States related to electromagnetic compatibility.

**March 9, 1999:** Council Directive 1999/5/EC on radio equipment and telecommunications terminal equipment and the mutual recognition of their conformity.

A full declaration, defining the relevant Directives and referenced standards can be obtained from your Samsung Electronics Co., Ltd. representative.

## ***EC Certification***

### **Certification to 1999/5/EC Radio Equipment & Telecommunications Terminal Equipment Directive (FAX)**

This Samsung product has been self-certified by Samsung for pan-European single terminal connection to the analogue public switched telephone network (PSTN) in accordance with Directive 1999/5/EC. The product has been designed to work with the national PSTNs and compatible PBXs of the European countries:

In the event of problems, you should contact the Euro QA Lab of Samsung Electronics Co., Ltd. in the first instance.

The product has been tested against TS 103 021 and TBR 38.



ELECTRONICS

## Declaration of Conformity

**Manufactured at:**

of Samsung Electronics Co., Ltd.  
#259, Gongdan-Dong, Gumi-City, Gyeongsangbuk-Do, 730-030 Korea  
of Samsung Electronics (Shandong) Digital Printing Co., Ltd.  
264209, Samsung Road, Weihai Hi-Tech. IDZ, Shandong Province, P.R.China  
of Intops(Weihai) Electronics Co.,Ltd.  
3,Huoju Road,Weilai,Hi-Tech,IDZ,Shandong Province,China

---

(Factory name, address)

**We hereby declare, that the product above is in compliance with the essential requirements of the R&TTE Directive (1995/5/EC) by application of:**

EN 60950-1:2001+A11:2004  
EN 55022:1998 + A1:2000 + A2:2003  
EN 55024:1998 + A1:2001 + A2:2003  
EN 61000-3-2:2000  
EN 61000-3-3:1995 + A1:2001  
TS103021, TBR38 , EG201121

The Technical documentation is kept at the below Manufacturer's address.

**Manufacturer**

---

Samsung Electronics Co., Ltd.  
#259, Gongdan-Dong, Gumi-City  
Gyungbuk, Korea 730-030

---

October 15, 2007

Whan-Soon Yim / S. Manager

---

**Representative in the EU:**

---

Samsung Electronics Euro QA Lab.  
Blackbushe Business Park  
Saxony Way, Yateley, Hampshire  
GU46 6GG, UK

---

October 15, 2007

(Place and date of issue)

Yong Sang Park / S. Manager

---

## In case of interference (US)

---

In normal operation, your SAMSUNG fax machine produces and uses radio-frequency energy. In some cases, this can cause interference to other electronic equipment. Part 15 of the FCC rules establishes guidelines limiting the amount of radio-frequency energy which may be produced by electronic equipment. Tests have proven that your Samsung FAX machine meets or exceeds these guidelines, and is classified a "Class B Digital Device" for operation in a residential environment. When installed and operated according to instructions, your SAMSUNG fax machine should not cause interference to the types of equipment expected to be found in a normal residential environment. Unauthorized changes or modifications could void the user's authority to operate the equipment.

In the event your SAMSUNG fax machine appears to cause interference to other electronic equipment, it can often be easily remedied. First determine if the source of interference really is your FAX machine. To do this, turn its power off and on while observing the equipment experiencing the interference. If the interference disappears when you turn the FAX machine off, the following steps can be very effective in correcting interference problems:

- Connect the FAX machine to an AC outlet which is on a different circuit breaker from the equipment experiencing interference.
- Increase the distance between the FAX machine and the equipment experiencing interference.
- Cable TV amplifiers and splitters are extremely prone to interference. Be certain that they are as far as possible from the FAX machine and its AC power and telephone cords.
- Replace "twin lead" antenna wire with shielded coaxial cable, and use proper connectors and adaptors.
- Turn or relocate the receiving antenna. In most cases this is easily done by simply moving a radio. A TV antenna may need to be reoriented or installed in another area of the building.
- Consult your dealer, a reputable radio/TV technician, or an Amateur Radio Operator for help.

## Fax branding (US)

---

The Telephone Consumer Protection Act of 1991 makes it unlawful for any person to use a computer or other electronic device to send any message via a telephone facsimile machine unless such message clearly contains in a margin at the top or bottom of each transmitted page or on the first page of the transmission the following information: the date and time of transmission identification of either business, business entity or individual sending the message; and telephone number of either the sending machine, business, business entity or individual.

See "Chapter 1" for instructions on how to enter this information into your Samsung FAX machine's memory.

The Telephone Company may make changes in its communications facilities, equipment operations, or procedures where such action is reasonably required in the operation of its business and is not inconsistent with the rules and regulations in FCC Part 68. If such changes can be reasonably expected to render any customer terminal equipment incompatible with telephone company communications facilities, or require modification or alteration of such terminal equipment, or otherwise materially affect its use or performance, the customer shall be given adequate notice in writing, to allow the customer an opportunity to maintain uninterrupted service.

# Telephone company information (US)

---

## **FCC identification number**

The Ringer Equivalence Number and FCC Registration Number for this equipment may be found on the label located on the bottom or rear of the machine. In some instances you may need to provide these numbers to the telephone company.

## **Ringer equivalence number**

The Ringer Equivalence Number (REN) is a measure of the electrical load placed on the telephone line, and is useful for determining whether you have “overloaded” the line. Installing several types of equipment on the same telephone line may result in problems making and receiving telephone calls, especially ringing when your line is called. The sum of all Ringer Equivalence Numbers of the equipment on your telephone line should be less than five in order to assure proper service from the telephone company. In some cases, a sum of five may not be usable on your line. If any of your telephone equipment is not operating properly, you should immediately remove it from your telephone line, as it may cause harm to the telephone network.

## **Warning**

FCC Regulations state that changes or modifications to this equipment not expressly approved by the manufacturer could void the user’s authority to operate this equipment.

In the event that terminal equipment causes harm to the telephone network, the telephone company should notify the customer that service may be stopped. However, where prior notice is impractical, the company may temporarily cease service, providing that they:

- a) *Promptly notify the customer.*
- b) *Give the customer an opportunity to correct the equipment problem.*
- c) *Inform the customer of the right to bring a complaint to the Federal Communication Commission pursuant to procedures set out in FCC Rules and Regulations Subpart E of Part 68.*

## **You should also know that:**

- Your Samsung FAX machine is not designed to be connected to a digital PBX system.
- Special features, such as “Call Waiting”, may interrupt FAX service, and we suggest that these services not be installed on the FAX line.
- If you intend to use a computer modem or fax modem on the same phone line as your FAX machine, you may experience transmission and reception problems with all the equipment. It is recommended that no other equipment, except for a regular telephone, share the line with your FAX machine.
- If your area experiences a high incidence of lightning or power surges, we recommend that you install surge protectors for both the power and the telephone lines. Surge protectors can be purchased from your dealer or telephone and electronic specialty stores.
- When programming emergency numbers and/or making test calls to emergency numbers, use a non-emergency number to advise the emergency service dispatcher of your intentions. The dispatcher will give you further instructions on how to actually test the emergency number.
- This equipment may not be used on coin service or party lines.
- This telephone provides magnetic coupling to hearing aids.
- You may safely connect this equipment to the telephone network by means of a standard modular jack, USOC RJ-11C.



# Correct Disposal of This Product (Waste Electrical & Electronic Equipment)

---

(Applicable in the European Union and other European countries with separate collection systems)



This marking shown on the product or its literature, indicates that it should not be disposed with other household wastes at the end of its working life. To prevent possible harm to the environment or human health from uncontrolled waste disposal, please separate this from other types of wastes and recycle it responsibly to promote the sustainable reuse of material resources.

Household users should contact either the retailer where they purchased this product, or their local government office, for details of where and how they can take this item for environmentally safe recycling.

Business users should contact their supplier and check the terms and conditions of the purchase contract. This product should not be mixed with other commercial wastes for disposal.



# INDEX

## A

ADF 8.2, 9.2  
alignment 8.3  
appearance 1.3  
ASF 1.5, 8.11  
auto journal 6.10  
auto reduction 6.10

## B

broadcasting 1.2, 3.3, 5.1, 5.2, 8.7

## C

call monitor 1.2, 4.2, 6.11  
caller id 2.3, 2.4, 6.2, 6.4, 6.5, 6.10, 8.8  
canceling  
    print 7.7  
cartridge  
    alignment 8.4  
    cleaning 8.4, 8.5, 8.6, 8.11  
    ink level 8.4  
    installation 8.7, 8.8, 8.11  
    maintenance 8.5  
    replacing 1.4, 8.3, 8.7, 8.9, 8.11  
contrast 3.2, 3.3  
control panel 1.4, 2.2, 3.2, 4.2, 4.5, 8.2,  
    8.3, 8.5, 8.6, 8.12

## D

Darkness 6.11  
darkness 1.4  
default printer 7.5  
delayed fax 1.2, 3.3, 5.1, 5.2, 6.4, 8.6,  
    8.7  
dialling 1.2, 1.4, 2.4, 3.4, 8.8, 8.9  
discard size 6.10

## E

ECM mode 6.10

## F

fax auto notice OGM 5.6  
fax forward 5.5

feeder 1.2, 1.5, 1.6, 2.3, 3.2, 3.3, 8.8,  
    8.11

## H

help, use 7.7  
howler action 6.11

## I

ICM record time 6.11  
image TCR 6.10, 6.11  
ink save mode 1.8  
installing software 7.2  
ITU #1 chart 9.4

## J

junk fax 6.2, 6.4, 6.5, 6.10, 8.7, 8.8

## K

keypad character 1.8

## L

language 6.10

## M

making a copy 1.6, 8.10  
message forward 4.5, 5.5, 6.11  
mute 1.4, 6.2

## O

OGM 5.5  
one-touch  
    caller ID 2.4  
    dialling 1.2, 2.2, 2.3, 8.8  
    junk fax 6.5  
    programming 2.2, 6.2, 6.4  
    sending 3.3, 5.2, 5.3

## P

paging OGM 4.5  
paper size 1.5, 6.10, 8.10  
pause 1.4, 2.2, 6.2  
phone book 2.2  
phonebook 1.2, 2.2, 2.3, 2.4, 6.4, 8.8,  
    8.10

polling 1.2, 5.4, 6.4, 8.6, 8.8, 8.10

printer driver

install 7.2

uninstall 7.5

## **R**

receive mode

auto mode 3.4, 3.5

DRPD 1.2, 3.4, 3.6, 6.10

fax mode 3.5, 5.4

TAM mode 1.4, 3.4, 3.5, 4.1, 4.2,  
4.5, 6.11

tel mode 3.5, 8.10

remote command 4.5

remote commands 4.5

remote password 4.5, 6.11

remote test 6.10

report 1.2, 6.4, 6.9, 6.10, 8.5, 8.7, 8.10

resolution 1.6, 2.3, 3.2, 3.3, 6.10

ring volume 1.8

rings to answer 3.5, 6.10, 6.11

## **S**

save charge 6.11

scanning glass 8.2

scheduled job 5.4, 8.6, 8.7, 8.8

search 1.4

send from memory 2.3, 3.3, 6.10

sending confirm 3.3, 6.4, 6.10

setting date and time 1.6

setting fax number 1.7

shading 8.4, 8.7

short message service 6.6

silence action 6.11

smart fax 5.3

software

install 7.2

Speaker Phone dial 2.2

speaker volume 1.8

specifications 9.2

speed dial

caller ID 2.4

dialling 2.2

junk fax 6.5

programming 2.2, 6.2, 6.4, 8.7

sending 3.3, 5.2, 5.3

## **T**

TAM message 4.2, 4.5, 5.5

## **U**

USB

connect 7.2

## **W**

wakeup sound 6.3

white roller 8.2, 8.7



[www.samsungprinter.com](http://www.samsungprinter.com)

P/N: JB68-01060A Rev.1.01

## Free Manuals Download Website

<http://myh66.com>

<http://usermanuals.us>

<http://www.somanuals.com>

<http://www.4manuals.cc>

<http://www.manual-lib.com>

<http://www.404manual.com>

<http://www.luxmanual.com>

<http://aubethermostatmanual.com>

Golf course search by state

<http://golfingnear.com>

Email search by domain

<http://emailbydomain.com>

Auto manuals search

<http://auto.somanuals.com>

TV manuals search

<http://tv.somanuals.com>