

SyncMaster 400MX,460MX,400MXn,460MXn

LCD Monitor

User Manual

Safety Instructions

Notational



Note

These safety instructions must be followed to ensure your safety and prevent property damage.

Make sure to read the instructions carefully and use the product in the correct manner.

Warning / Caution



Failure to follow directions noted by this symbol could result in bodily harm or damage to the equipment.

Notational Conventions



Prohibited



Important to read and understand at all times



Do not disassemble



Disconnect the plug from the outlet



Do not touch



Ground to prevent an electric shock

Power



When not used for extended period of time, set your computer to DPM.

If using screen saver, set it to active screen mode.

The images here are for reference only, and are not applicable in all cases (or countries).

Shortcut to Anti-Afterimage Instructions

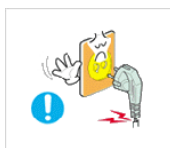

▶ Do not use a damaged power cord or plug or a damaged or loose power outlet.

- Otherwise, this may result in electric shock or fire.

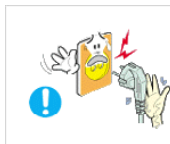

▶ Do not touch the power plug with wet hands when removing or plugging the plug into the outlet.

- Otherwise, this may result in electric shock.

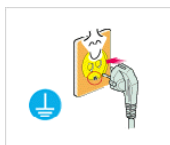

▶ Make sure to connect the power cord to a grounded power outlet.

- Otherwise, it may result in electric shock or personal injury.

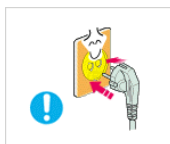

▶ Ensure that the power plug is plugged into the power outlet firmly and correctly.

- Otherwise, this may result in fire.

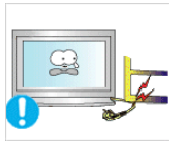

▶ Do not forcefully bend or pull the power plug and do not place any heavy material on it.

- Otherwise, this may result in fire.

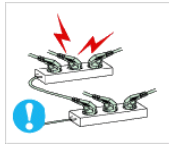

▶ Do not connect multiple appliances to the same power outlet.

- Otherwise, this may cause fire due to overheating.



▶ Do not disconnect the power cord while using the product.

- Otherwise, this may result in damage to the product due to electric shock.



▶ To disconnect the apparatus from the mains, the plug must be pulled out from the mains socket, therefore the mains plug shall be readily operable.

- This may cause electric shock or fire.



▶ Use only the power cord provided by our company. Do not use the provided power cord of another product.

- Otherwise, this may result in fire or electric shock.

Installation



Be sure to contact an authorized Service Center when installing your monitor in a location with heavy dust, high or low temperatures, high humidity, and exposed to chemical substances and where it operates for 24 hours such as at airports, train stations etc.

Failure to do so may cause serious damage to your monitor.



▶ Ensure that at least two persons lift and move the product.

- Otherwise, it may be dropped and cause personal injury, and/or damage the product.

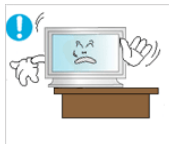

▶ When installing the product in a cabinet or rack, make sure that the front end of the bottom of the product does not project out.

- Otherwise, it may fall or cause personal injury.

• Use a cabinet or rack of a size appropriate to the product.

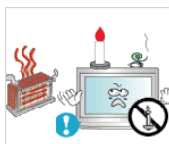

▶ DO NOT PLACE CANDLES, MOSQUITO REPELLANT, CIGARETTES AND ANY HEATING APPLIANCES NEAR THE PRODUCT.

- Otherwise, this may result in fire.

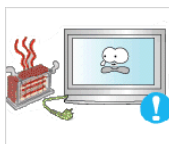

▶ Keep heating appliances as far away from the power cord or the product as possible.

- Otherwise, this may result in electric shock or fire.



- ▶ Do not install it in a badly ventilated location such as a bookcase or closet.
- Otherwise, this may result in fire due to an increase in the internal temperature.



- ▶ When putting the product down, make sure to put it down softly.
- Otherwise, this may result in damage to the screen display.



- ▶ Do not place the front of the product on the floor.
- Otherwise, this may result in damage to the screen display.



- ▶ Ensure that an authorized installation company installs the wall mount.
- Otherwise, it may fall and cause personal injury.
- Make sure to install the specified wall mount.

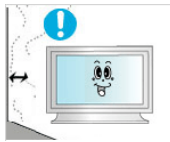

- ▶ Install your product in a well ventilated location. Ensure that there is a clearance of more than 10 cm from the wall.
- Otherwise, it may result in fire due to an increase in the internal temperature.

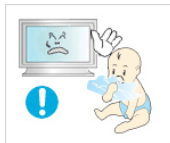

- ▶ Ensure that the packaging vinyl is kept away from children.
- Otherwise, it may result in serious harm (suffocation) if children play with it.

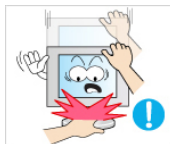

- ▶ If the height of your monitor is adjustable, do not place any object or part of your body on the stand when lowering it.
- This may cause damage to the product or the person carrying it.

Clean



When cleaning the monitor case or the surface of the TFT-LCD screen, wipe with a slightly moistened, soft fabric.



- ▶ Do not spray cleaner directly onto the surface of the product.
- Otherwise, this may result in the discoloration and distortion of the structure and the screen surface may peel off.

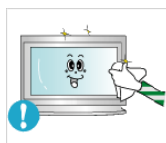

- ▶ Clean the product using a soft cloth with a monitor cleaner only. If you must use a cleaner other than the monitor cleaner, dilute it with water at a ratio of 1:10.



- ▶ When cleaning the power plug pins or dusting the power outlet, clean it with a dry cloth.
- Otherwise, it may result in fire.



▶ When cleaning the product, make sure to disconnect the power cord.

- Otherwise, it may result in electric shock or fire.



▶ When cleaning the product, disconnect the power cord and clean it softly with a dry cloth.

- (Do not use chemicals such as wax, benzene, alcohol, thinner, mosquito repellent, lubricant, or cleaner.) These may change the appearance of the product surface and peel off the indication labels on the product.

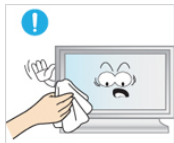

▶ Since the product housing is easily scratched, make sure to use the specified cloth only.

- Use the specified cloth adding only a little water. As the product may be scratched if there is any foreign material on the cloth, make sure to shake it thoroughly before using it.



▶ When cleaning the product, do not spray water directly onto the main body of the product.

- Ensure that water does not enter the product and that it is not wet.
- Otherwise, this may result in electric shock, fire or a malfunction.

Others

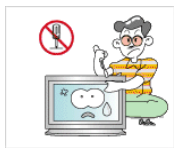

▶ The product is a high voltage product. Ensure that users do not disassemble, repair or modify the product themselves.

- Otherwise, this may result in electric shock or fire. If the product needs to be repaired, contact a Service Center.



▶ If there is a strange smell or a strange sound or smoke is coming from the product, disconnect the power plug immediately and contact a Service Center.

- Otherwise, this may result in electric shock or fire.



▶ Do not place this product in a location exposed to moisture, dust, smoke, water, or in a car.

- Otherwise, this may result in electric shock or fire.



▶ When you drop the product or the case is broken, turn the power off and disconnect the power cord. Contact a Service Center.

- Otherwise, this may result in electric shock or fire.



▶ If thunder or lightening is occurring, do not touch the power cord or antenna cable.

- Otherwise, this may result in electric shock or fire.

Safety Instructions

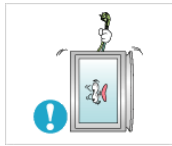

▶ Do not try to move the monitor by pulling only the wire or the signal cable.

- Otherwise, it may fall and result in electric shock, damage to the product or fire due to damage to the cable.

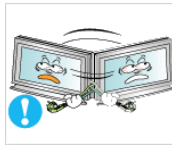

▶ Do not lift or move the product back and forwards or right and left while only holding the power cord or signal cables.

- Otherwise, it may fall and result in electric shock, damage to the product or fire due to damage to the cable.



▶ Make sure that the ventilating opening is not blocked by a table or curtain.

- Otherwise, it may result in fire due to an increase in the internal temperature.

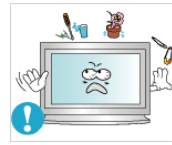

▶ Do not place any containers containing water, vases, flowerpots, medicines as well as any metal on the product.

- If water or a foreign material enters the product, disconnect the power cord and contact a Service Center.

- This may result in a product malfunction, electric shock, or fire.

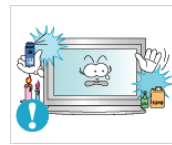

▶ Do not use or keep combustible spray or flammable material near the product.

- Otherwise, this may result in an explosion or fire.



▶ Do not insert any metal, such as chopsticks, coins, pins and steel, or flammable objects, such as matches or paper, inside the product (through the ventilating openings, input and output terminals, etc).

- If water or foreign material enters the product, disconnect the power cord and contact a Service Center.

- Otherwise, this may result in electric shock or fire.

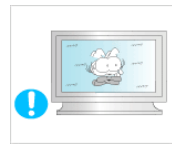

▶ When using a fixed screen for a long time, an afterimage or stain may occur.

- If you are not using your product for a long period of time, put it into sleep mode or use a moving screen saver.



▶ Set a resolution and frequency appropriate to the product.

- Otherwise, your eyesight may be damaged.



▶ When using headphones or earphones, do not turn the volume too high.

- Having the sound too loud may damage your hearing.



▶ If you continually move closer to the product screen, your eyesight may be failing.

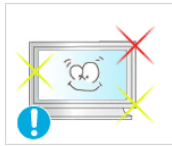

▶ Take a rest for at least five (5) minutes after using the monitor for one (1) hour.

This reduces the weariness of your eyes.



▶ Do not install it in an unstable location such as an unstable rack or uneven surface or a location exposed to vibrations.

- Otherwise, it may fall and cause personal injury and/or damage the product.
- If you use the product in a location exposed to vibrations, it may damage the product and result in fire.



▶ When moving the product, turn the power off and disconnect the power plug, antenna cable, and all the cables connected to the product.

- Otherwise, it may result in electric shock or fire.

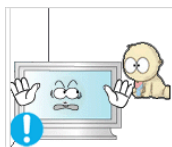

▶ Ensure that children do not hang onto the product or climb up onto the product.

- The product may fall and cause personal injury or death.



▶ If you do not use the product for a long period of time, disconnect the power cord from the power outlet.

- Otherwise, this may result in overheating or fire due to dust, and may result in fire due to electric shock or leakage.

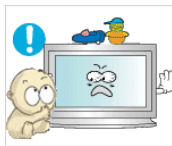

▶ Do not place any heavy items or toys or confectionery, such as cookies etc. that may attract the attention of children and to the product.

- Your children may hang onto the product causing it to fall and this may result in personal injury or death.

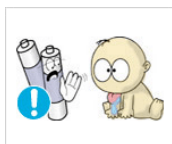

▶ Be careful that children do not place the battery in their mouths when removed from the remote control. Place the battery in a location that children or infants cannot reach.

- If children have had the battery in their mouths, consult your doctor immediately.

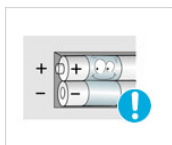

▶ When replacing the battery, insert it with right polarity (+, -).

- Otherwise, the battery may become damaged or it may cause fire, personal injury or damage due to leakage of the internal liquid.



▶ Use only the specified standardized batteries, and do not use a new battery and a used battery at the same time.

- Otherwise, the batteries may be damaged or cause fire, personal injury or damage due to a leakage of the internal liquid.



▶ The batteries (and rechargeable batteries) are not ordinary refuse and must be returned for recycling purposes. The customer is responsible for returning the used or rechargeable batteries for recycling.

- The customer can return used or rechargeable batteries to a nearby public recycling center or to a store selling the same type of the battery or rechargeable battery.

Safety Instructions



▶ Do not place the product in a location exposed to direct sunlight or near any heat such as a fire or heater.

- This may reduce the lifetime of the product, and may result in fire.

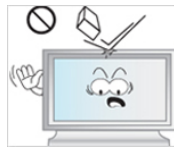

▶ Do not drop any objects onto the product or cause any impact to the product.

- Otherwise, this may result in electric shock or fire.



▶ Do not use a humidifier or kitchen table near the product.

- Otherwise, this may result in electric shock or fire.



▶ When there is a gas leak, do not touch the product or the power plug but ventilate immediately.

- If a spark occurs, it may cause an explosion or fire.

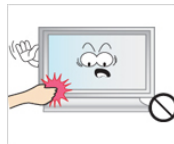

▶ If the product has been turned on for a long time, the display panel becomes hot. Do not touch it.

- Keep the small accessories in a location out of the reach of children.



▶ Be careful when adjusting the angle of the product or the height of the stand.

- This may result in personal injury as your hand or fingers may become caught.

- Also, if you tilt the product too far, it may fall and cause personal injury.

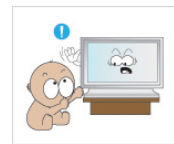

▶ Do not install the product in a location low enough for children to reach.

- Otherwise, it may fall and result in personal injury.

- Since the front part of the product is heavy, install the product on a level and stable surface.



▶ Do not put any heavy objects on the product.

- This may result in personal injury and/or damage to the product.

Introduction

Package Contents



Please make sure the following items are included with your LCD Display.

If any items are missing, contact your dealer.

Contact a local dealer to buy optional items.



This stand is not for the Floor Standing Type.

Unpacking



LCD Display

Manuals



Quick Setup Guide



Warranty Card



User's Guide

(Not available in all locations)

Cables



D-Sub Cable



Power Cord

Others



Others

Remote Control

Batteries (AAA X 2)

HDD Cover

(Not available in all locations)

Sold separately

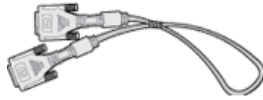

DVI Cable

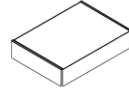

Wall Mount KIT



LAN Cable

(Applicable to the MXn model only)

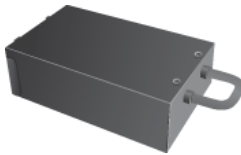

TV tuner box



NetWork Box



Semi Stand KIT

(Applicable to the MX model only)



Note

- You can purchase and connect a separate network box or TV tuner box. For information on how to use these, refer to their respective user manuals.
- You can only connect one external box.

Your LCD Display

Front

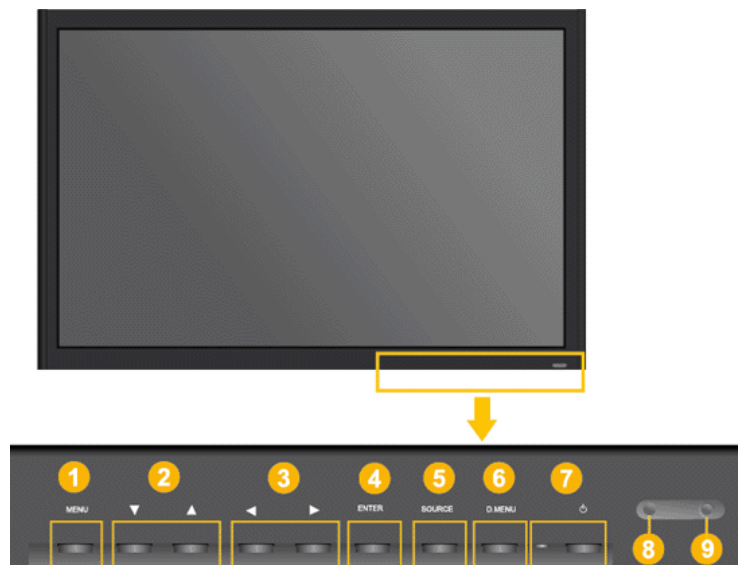

1 *MENU button [MENU]*

Opens the on-screen menu and exits from the menu. Also use to exit the OSD menu or return to the previous menu.

2 *Navigate buttons (Up-Down buttons)*

Moves from one menu item to another vertically or adjusts selected menu values.

3 *Adjust buttons (Left-Right buttons) / Volume buttons*

Moves from one menu item to another horizontally or adjusts selected menu values. When OSD is not on the screen, push the button to adjust volume.

4 *ENTER button [ENTER]*

Activates a highlighted menu item.

5 *SOURCE button [SOURCE]*

Switches from PC mode to Video mode. Changing the source is only allowed for external devices that are connected to the LCD Display at the time.

[PC] → [DVI] → [AV] → [HDMI] → [MagicInfo] → [TV]

 **Note**

- The **TV** menu is available when a TV tuner box is installed.
- The MagicInfo menu is available when a network box is installed in the MXn or MX model.

6 *D.MENU*

Opens the on-screen D.MENU.

 **Note**

- This is available when a TV tuner box is installed.

7 *Power button [⏻]*

Use this button for turning the LCD Display on and off.

8 *Power indicator*

Shows PowerSaver mode by blinking green

 **Note**

See PowerSaver described in the manual for further information regarding power saving functions. For energy conservation, turn your LCD Display OFF when it is not needed or when leaving it unattended for long periods.

9 *Remote Control Sensor*

Aim the remote control towards this spot on the LCD Display.

Rear

 **Note**

For detailed information concerning cable connections, refer to Connecting Cables under Setup. The LCD Display 's configuration at the back may vary slightly depending on the LCD Display model.

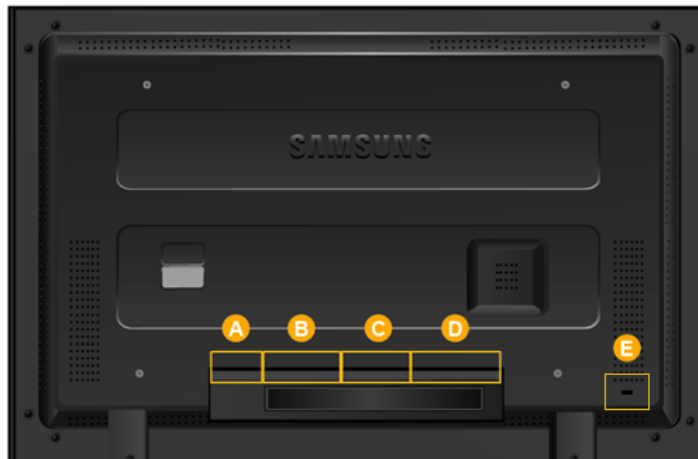

A



1 POWER S/W ON [|] / OFF [O]

Switches the LCD Display On/Off.

2 POWER IN

The power cord plugs into the LCD Display and the wall plug.

B

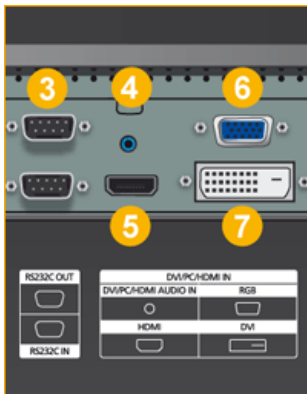

3 RS232C OUT/IN (RS232C Serial PORT)

MDC(Multiple Display Control) Program Port

4 DVI / PC / HDMI IN [DVI/PC/HDMI AUDIO IN] (PC/DVI/HDMI Audio Connection Terminal (Input))

5 DVI / PC / HDMI IN [HDMI]

Connect the HDMI terminal at the back of your LCD Display to the HDMI terminal of your digital output device using a HDMI cable.

6 DVI / PC / HDMI IN [RGB](PC Video Connection Terminal)

Using a D-Sub Cable (15 pin D-Sub) - PC mode (Analog PC)

7 DVI / PC / HDMI IN [DVI] (PC Video Connection Terminal)

Using a DVI Cable (DVI-D to DVI-D) - DVI mode (Digital PC)

C

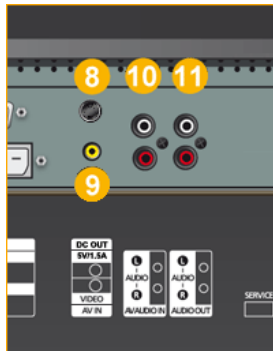

8 DC OUT [5V/1.5A]

Connect this to the **POWER** connector of a TV tuner box or network box.

9 AV IN [VIDEO] (VIDEO Connection Terminal)

Connect the [VIDEO] terminal of your monitor to the video output terminal of the external device using a VIDEO cable.

10 AV AUDIO IN [L-AUDIO-R] (LCD Display Audio Connection Terminal (Input))

11 AV AUDIO OUT [L-AUDIO-R] (LCD Display Audio Connection Terminal (Output))

D

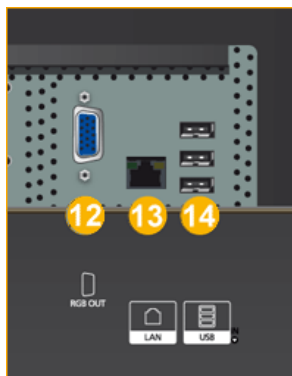

12 RGB OUT

(Applicable to the MXn model only)

13 LAN (LAN Connection Terminal)

(Applicable to the MXn model only)

14 USB (USB Connection Terminal)

Keyboard / Mouse, Mass Storage Device Compatible.

(Applicable to the MXn model only)

Note

The number of LCD Displays that can be connected to loopout may differ depending on the cables, signal source etc. With cables where there is no degradation or signal source, up to ten LCD Displays can be connected.

E

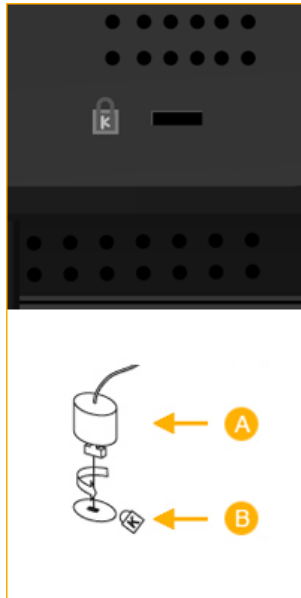

Kensington Lock

The Kensington Lock is a device used to physically fix the system when using it in a public place. The locking device has to be purchased separately. The appearance and locking method may differ from the illustration depending on the manufacturer. Refer to the manual provided with the Kensington Lock for proper use. The locking device has to be purchased separately.



Note

The location of the Kensington Lock may be different depending on its model.

Using the Anti-Theft Kensington Lock

1. Insert the locking device into the Kensington slot on the Monitor **B** and turn it in the locking direction **A**.
2. Connect the Kensington Lock cable.
3. Fix the Kensington Lock to a desk or a heavy stationary object.



Note

See Connecting Cables for further information regarding cable connections.

Remote Control



Note



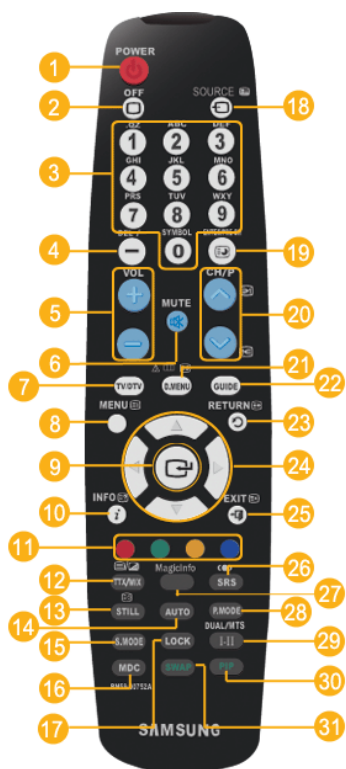







The performance of the remote control may be affected by a TV or other electronic device operating near the LCD Display, causing a malfunction due to interference with the frequency.





- 1 POWER
- 2 OFF
- 3 Number Buttons
- 4 DEL button
- 5 + VOL -
- 6 MUTE
- 7 TV/DTV
- 8 MENU
- 9 RETURN
- 10 INFO
- 11 COLOR BUTTONS
- 12 TTX/MIX
- 13 STILL
- 14 AUTO
- 15 S.MODE
- 16 MDC
- 17 LOCK
- 18 SOURCE
- 19 ENTER/PRE-CH
- 20 CH/P
- 21 D.MENU
- 22 GUIDE
- 23 RETURN
- 24 Up-Down Left-Right buttons
- 25 EXIT
- 26 SRS
- 27 MagicInfo
- 28 P.MODE
- 29 DUAL/MTS
- 30 PIP
- 31 SWAP

- 1. POWER
- 2. Off
- 3. Number Buttons

- Turns the product On.
- Turns the product Off.
- Press to change the channel.

4. DEL  button
The "-" button operates only for DTV. It is used to select MMS (multi-channel) for a DTV.
5. + VOL -
Adjusts the audio volume.
6.  MUTE
Pauses (mutes) the audio output temporarily. This is displayed on the lower left corner of the screen. The audio resumes if MUTE or - VOL + is pressed in the Mute mode.
7. TV/DTV
Selects the TV and DTV mode directly.
8. MENU
Opens the on-screen menu and exits from the menu or closes the adjustment menu.
9. 
Activates a highlighted menu item.
10.  INFO
Current picture information is displayed on the upper left corner of the screen.
11. COLOR BUTTONS
Press to add or delete channels and to store channels to the favorite channel list in the "Channel List" menu.
12.  TTX/MIX
TV channels provide written information services via teletext.
- Teletext Buttons

- For more information > TTX / MIX
13. STILL
Press the button once to freeze the screen. Press it again to unfreeze.
14. AUTO
Adjusts the screen display automatically in **PC** mode. By changing the resolution in the control panel, auto function is performed.
15. S.MODE
When pressing this button, the current mode is displayed at the bottom centre of the screen. The LCD Display has a built-in high fidelity stereo amplifier. Then press the button again to circle through available preconfigured modes. (**Standard** → **Music** → **Movie** → **Speech** → **Custom**)
16. MDC
MDC Quick Launch Button.
17. LOCK
Activates or deactivates all function keys on both the remote control and the LCD Display except for the Power and LOCK buttons.
18.  SOURCE
Press the button to change the input signal SOURCE.
Changing the SOURCE is only allowed for external devices that are connected to the monitor at the time.
19.  ENTER/PRE-CH
This button is used to return to the immediately previous channel.
20.  VCH/PA
In **TV** mode, selects TV channels.
21. D.MENU
DTV menu display
22. GUIDE
Electronic Program Guide (EPG) display.
23.  RETURN
Returns to the previous menu.

24. Up-Down Left-Right buttons
 Moves from one menu item to another horizontally, vertically or adjusts selected menu values.
25.  EXIT
 Exits from the menu screen.
26.  SRS
 SRS TS XT
27. MagicInfo
 MagicInfo Quick Launch Button.
28. P.MODE
 When you press this button, current picture mode is displayed on the lower center of the screen.

AV / HDMI / TV : P.MODE

The LCD Display has four automatic picture settings that are pre-set at the factory. Then push button again to circle through available preconfigured modes. (**Dynamic** → **Standard** → **Movie** → **Custom**)

PC / DVI / MagicInfo: M/B (MagicBright)

MagicBright is a feature providing the optimum viewing environment depending on the contents of the image you are watching. Then push button again to circle through available preconfigured modes. (**Entertain** → **Internet** → **Text** → **Custom**)

29.  DUAL/MTS

DUAL-

STEREO/MONO, DUAL I / DUAL II and MONO/NICAM MONO/NICAM STEREO can be operated depending on the broadcasting type by using the DUAL button on the remote control while watching TV.

MTS-

You can select MTS (Multichannel Television Stereo) mode.

	Audio Type	MTS/S_Mode	Default
FM Stereo	Mono	Mono	Manual Change
	Stereo	Mono ↔ Stereo	
	SAP	Mono ↔ SAP	Mono

30. PIP
 Every time you press the button, a PIP screen appears.

- This function does not work for this LCD Display.

31. SWAP
 Swaps the contents of the PIP and main image. The image in the PIP window will appear on the main screen, and the main screen image will appear in the PIP window.

- This function does not work for this LCD Display.

Mechanical Layout (400MX, 400MXn)

Mechanical Layout

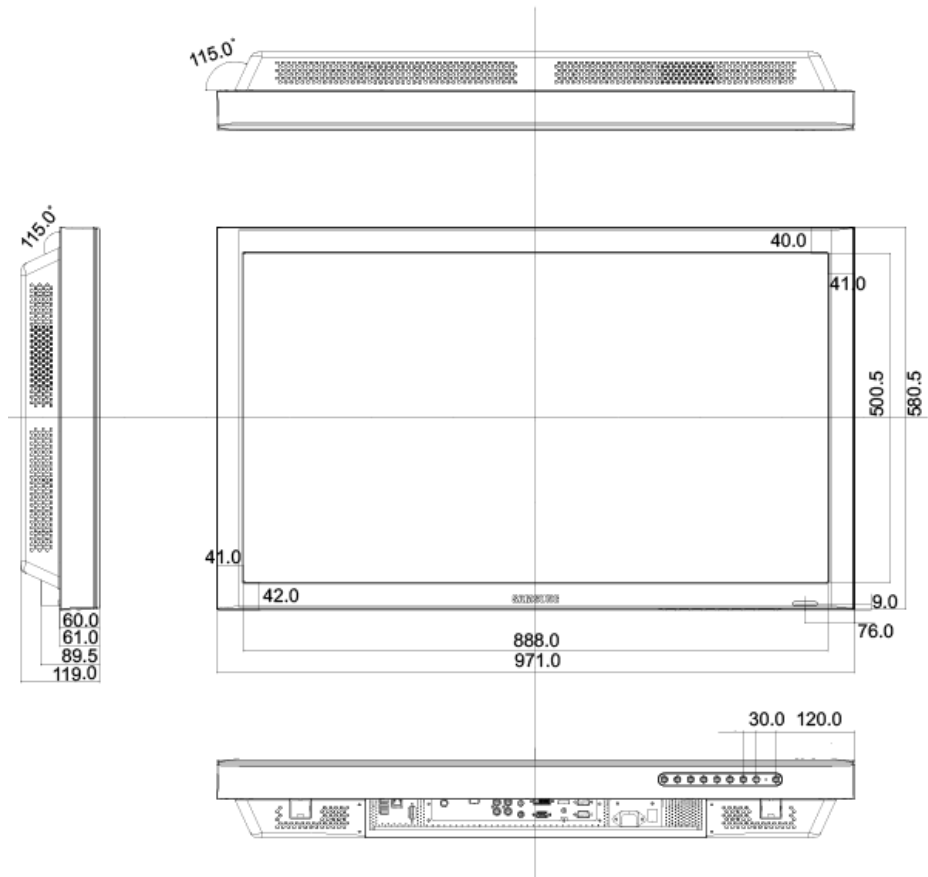

LCD Display Head

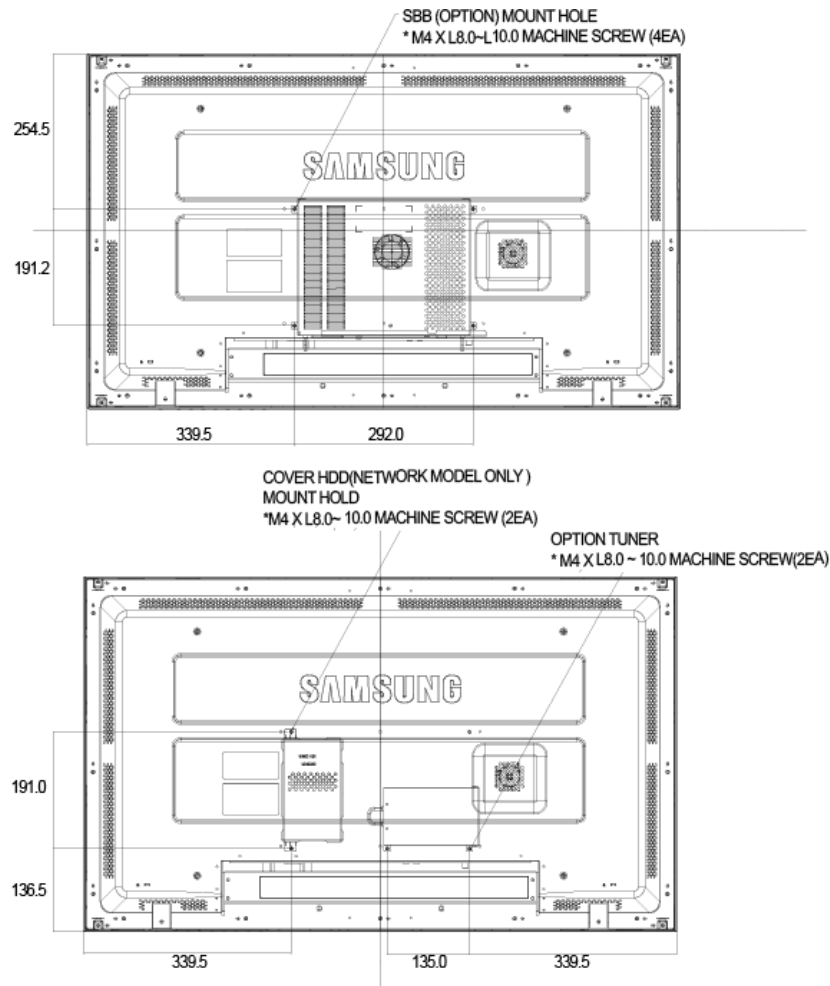

Installation VESA Bracket

- When installing VESA, make sure to comply with the international VESA standards.
- Purchasing VESA Bracket and Installation Information : Please contact your nearest SAMSUNG Distributor to place an order. After your order is placed, installation professionals will visit you and install the bracket.
- At least 2 persons are needed in order to move the LCD Display.
- SAMSUNG is not responsible for any product damage or any injury caused by installation at customer's discretion.

Dimensions

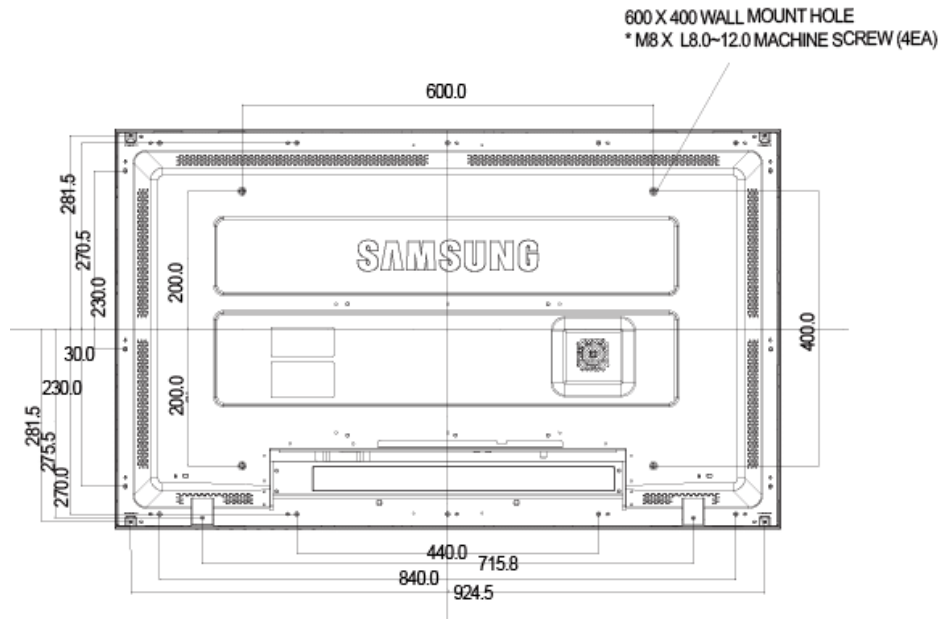

Notice

For securing the bracket on a wall, use only machine screws of 6 mm diameter and 8 to 12 mm length.

Wall Bracket Installation

- Contact a technician for installing the wall bracket.
- SAMSUNG Electronics is not responsible for any damages to the product or harm to customers when the installation is done by the customer.
- This product is for installing on cement walls. The product may not stay in place when installed on plaster or wood.

Components

Only use the components and accessories shipped with the product.

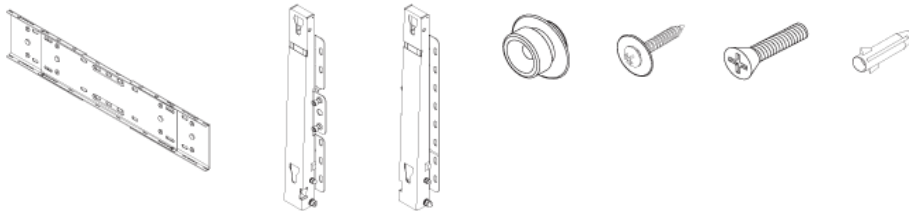

Wall Bracket(1)

Hinge(Left 1, Right Hanger
1) (4)

Screw
(A)(11)

Screw(B) Anchor
(4) (11)

Wall Bracket Assembly



Note

There are two hinges(left and right). Use the correct one.

1. Insert and tighten the Captive Screw in the direction of the arrow.

When done, mount the wall bracket on the wall.

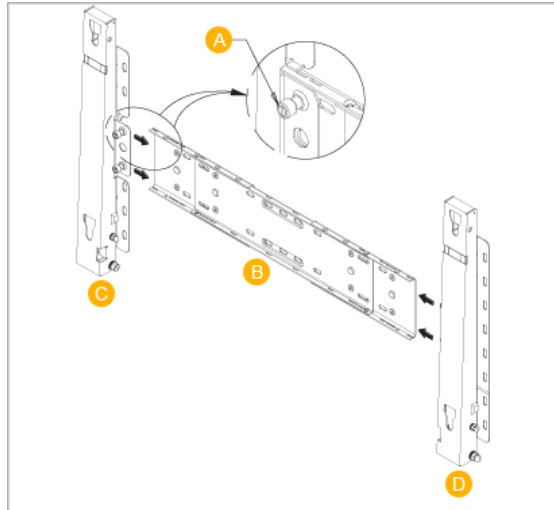

There are two hinges(left and right). Use the correct one.

- A - Captive Screw
- B - Wall Bracket
- C - Hinge (Left)
- D - Hinge (Right)

2. Before drilling into the wall, check if the length between the two locking holes at the back of the product is correct.

If the length is too short or long, loosen all or some of the 4screws on the wall bracket to adjust the length.

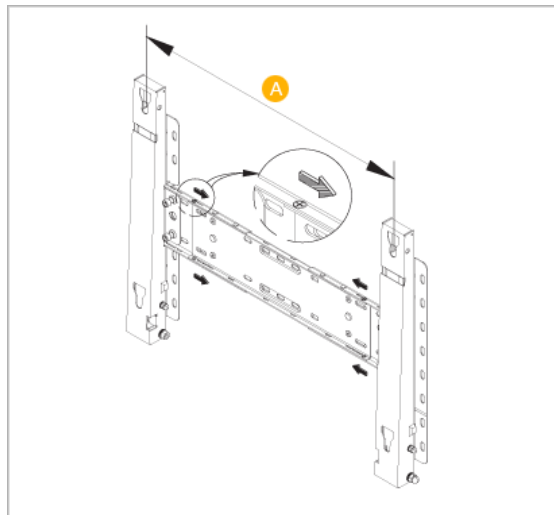

- A - Length between the two locking holes

3. Check the installation diagram and mark the drill points on the wall. Use the 5.0 mm bit to drill holes deeper than 35 mm. Fix each anchor in the corresponding hole. Match each of the brackets and hinge holes to the corresponding anchor holes and insert and tighten the 11 screws A.

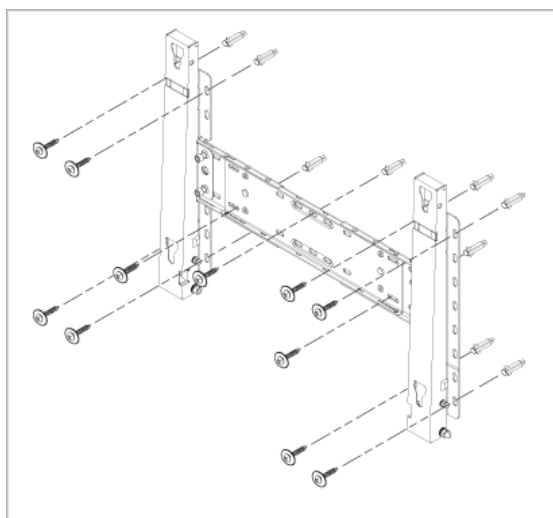

To mount the product on the wall bracket

The shape of the product may vary depending on the model. (The assemblies of the plastic hanger and the screw are the same)

1. Remove the 4 screws on the back of the product.

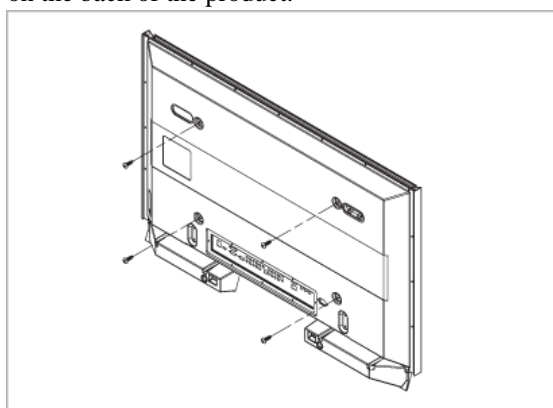

2. Insert the screw B into the plastic hanger.

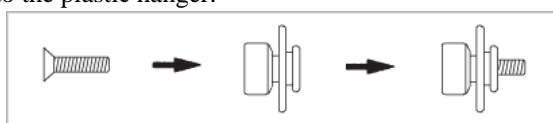

Notice

- Mount the product on the wall bracket and make sure it is properly fixed to the left and right plastic hangers.
 - Be careful when installing the product on the bracket as fingers can be caught in the holes.
 - Make sure the wall bracket is securely fixed to the wall, or the product may not stay in place after installation.
3. Tighten the 4 screws in step 2 (plastic hanger + screw B) to the rear holes of the product.

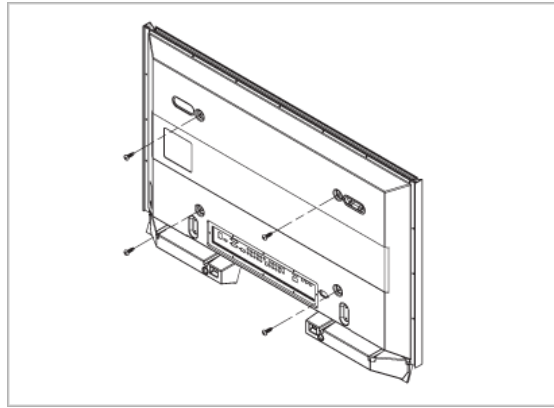

4. Remove safety pin (3) and insert the 4 product holders into the corresponding bracket holes (1). Then place the product(2) so that it is firmly fixed to the bracket. Make sure to re-insert and tighten the safety pin (3) to securely hold the product to the bracket.

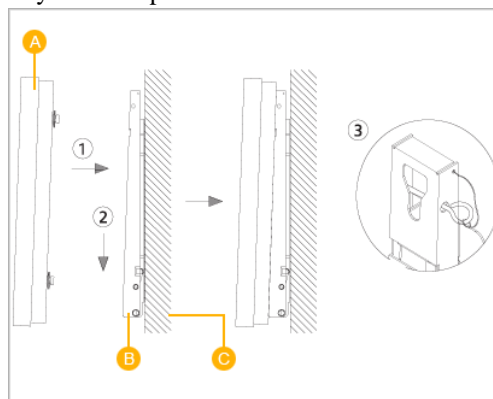

- A - LCD Display
- B - Wall Bracket
- C - Wall

Wall Bracket Angle Adjustment

Adjust the bracket angle to -2° before installing it on the wall.

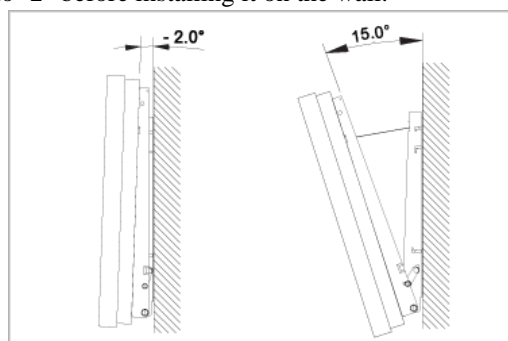

1. Fix the product to the wall bracket.
2. Hold the product at the top in the center and pull it forward (direction of the arrow) to adjust the angle.



You can adjust the bracket angle between -2° and 15° .

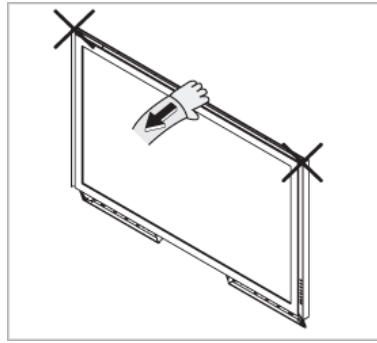

Make sure to use the top center, and not the left or the right side of the product to adjust the angle.

Mechanical Layout (460MX, 460MXn)

Mechanical Layout

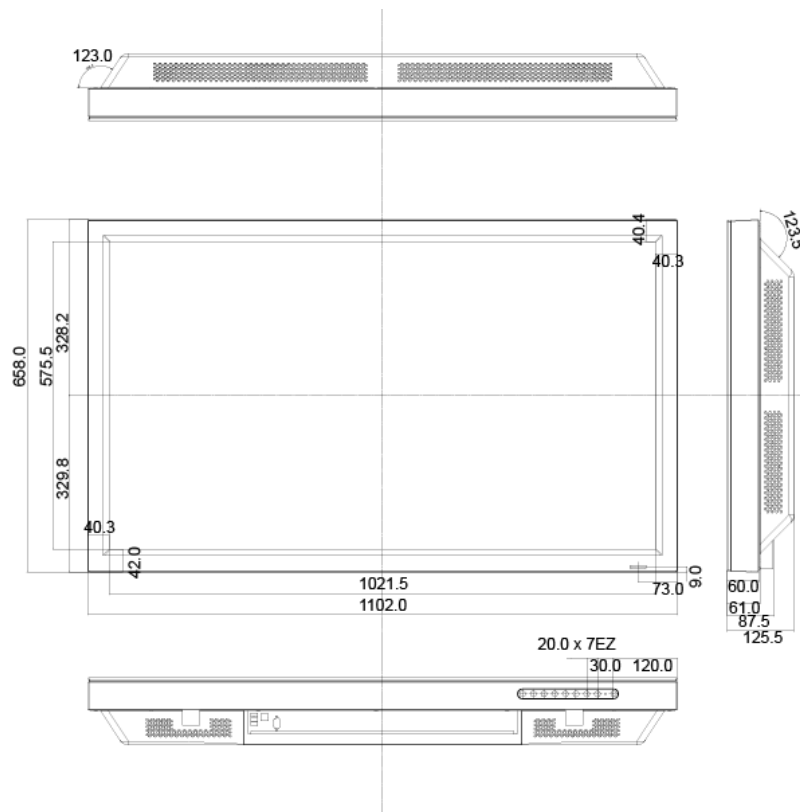

LCD Display Head

Introduction

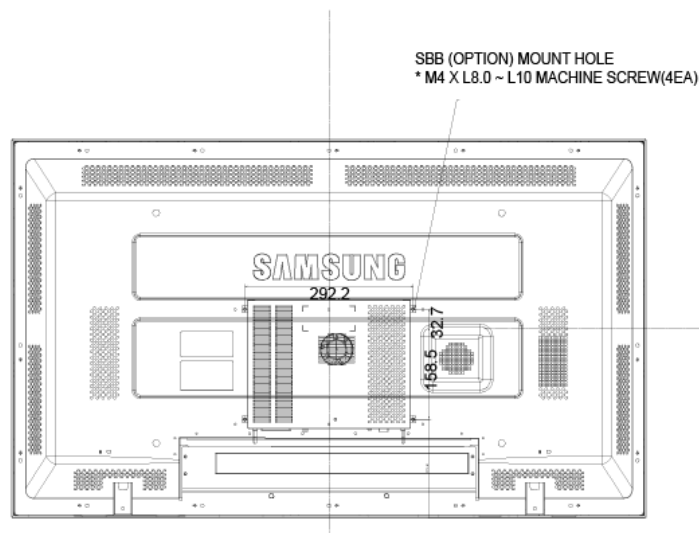
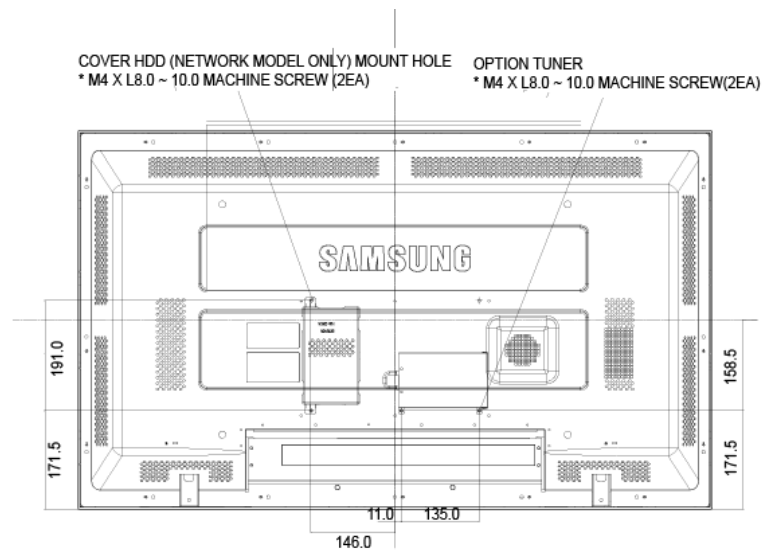

Installation VESA Bracket

- When installing VESA, make sure to comply with the international VESA standards.
- Purchasing VESA Bracket and Installation Information : Please contact your nearest SAMSUNG Distributor to place an order. After your order is placed, installation professionals will visit you and install the bracket.
- At least 2 persons are needed in order to move the LCD Display.
- SAMSUNG is not responsible for any product damage or any injury caused by installation at customer's discretion.

Dimensions

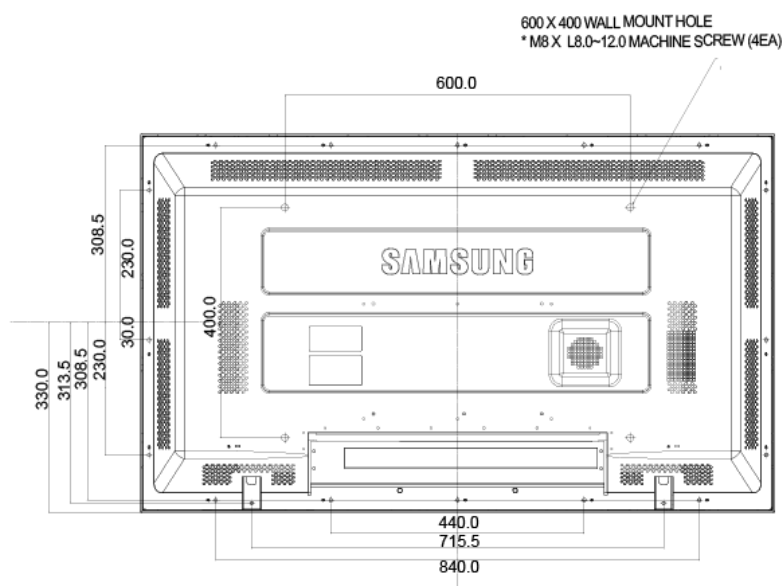

Notice

For securing the bracket on a wall, use only machine screws of 6 mm diameter and 8 to 12 mm length.

Wall Bracket Installation

- Contact a technician for installing the wall bracket.
- SAMSUNG Electronics is not responsible for any damages to the product or harm to customers when the installation is done by the customer.
- This product is for installing on cement walls. The product may not stay in place when installed on plaster or wood.

Components

Only use the components and accessories shipped with the product.

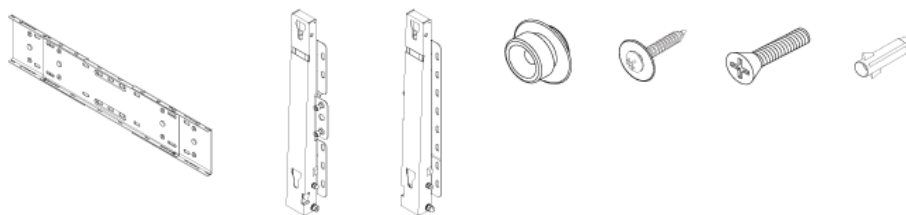

Wall Bracket(1)

Hinge(Left 1, Right
1) Plastic Hanger
(4)

Screw
(A)(11)

Screw(B) Anchor
(4) (11)

Wall Bracket Assembly



Note

There are two hinges(left and right). Use the correct one.

1. Insert and tighten the Captive Screw in the direction of the arrow.

When done, mount the wall bracket on the wall.

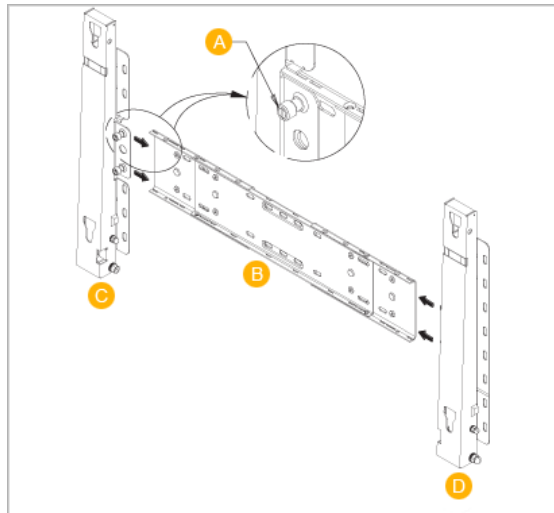

There are two hinges(left and right). Use the correct one.

- A - Captive Screw
- B - Wall Bracket
- C - Hinge (Left)
- D - Hinge (Right)

2. Before drilling into the wall, check if the length between the two locking holes at the back of the product is correct.

If the length is too short or long, loosen all or some of the 4screws on the wall bracket to adjust the length.

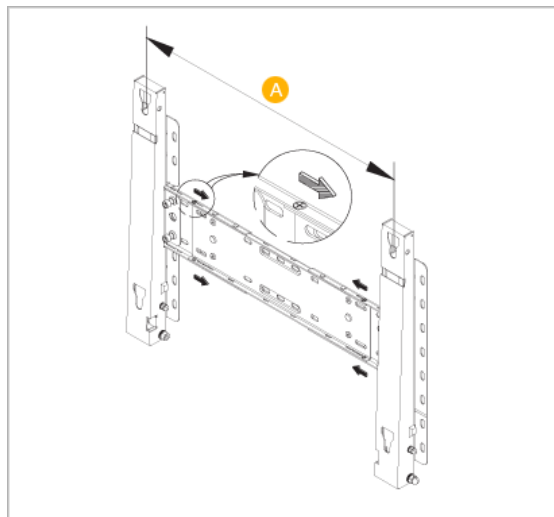

- A - Length between the two locking holes

3. Check the installation diagram and mark the drill points on the wall. Use the 5.0 mm bit to drill holes deeper than 35 mm. Fix each anchor in the corresponding hole. Match each of the brackets and hinge holes to the corresponding anchor holes and insert and tighten the 11 screws A.

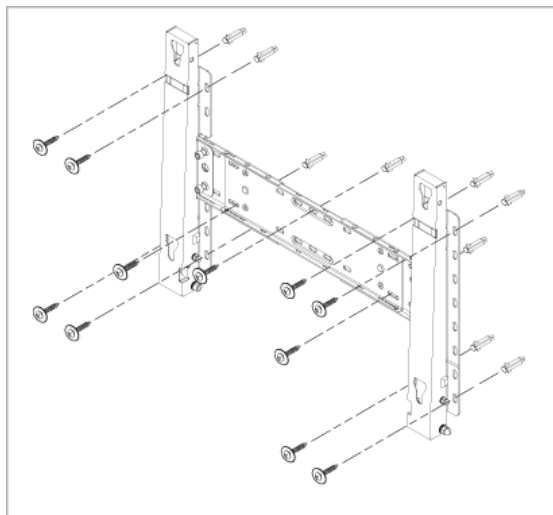

To mount the product on the wall bracket

The shape of the product may vary depending on the model. (The assemblies of the plastic hanger and the screw are the same)

1. Remove the 4 screws on the back of the product.

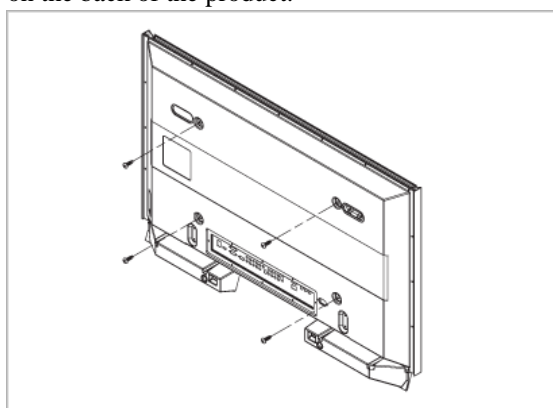

2. Insert the screw B into the plastic hanger.

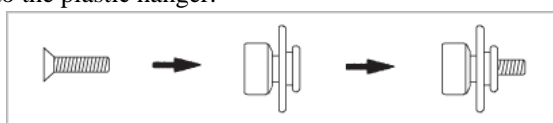

 **Notice**

- Mount the product on the wall bracket and make sure it is properly fixed to the left and right plastic hangers.
 - Be careful when installing the product on the bracket as fingers can be caught in the holes.
 - Make sure the wall bracket is securely fixed to the wall, or the product may not stay in place after installation.
3. Tighten the 4 screws in step 2 (plastic hanger + screw B) to the rear holes of the product.

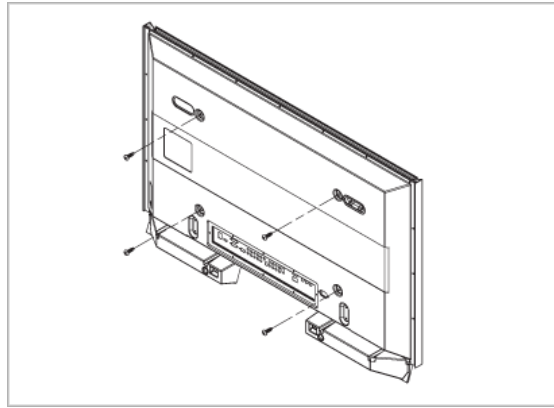

4. Remove safety pin (3) and insert the 4 product holders into the corresponding bracket holes (1). Then place the product(2) so that it is firmly fixed to the bracket. Make sure to re-insert and tighten the safety pin (3) to securely hold the product to the bracket.

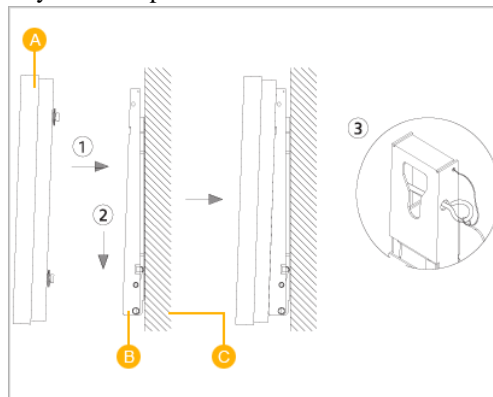

- A - LCD Display
- B - Wall Bracket
- C - Wall

Wall Bracket Angle Adjustment

Adjust the bracket angle to -2° before installing it on the wall.

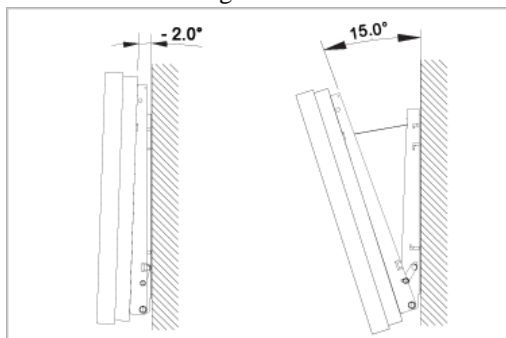

1. Fix the product to the wall bracket.
2. Hold the product at the top in the center and pull it forward (direction of the arrow) to adjust the angle.

Note

You can adjust the bracket angle between -2° and 15° .

Introduction

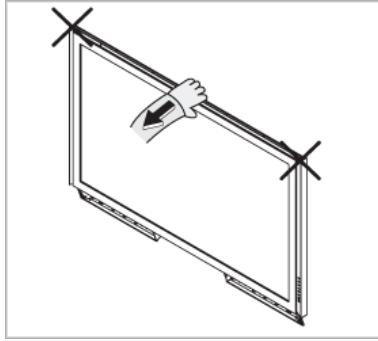

Make sure to use the top center, and not the left or the right side of the product to adjust the angle.

Connections

Connecting a Computer



Using a Power cord with Earth

- In the event of failure, the earth lead may cause electric shock. Make sure to wire the earth lead in correctly, before connecting the AC power. When unwiring the earth lead, make sure to disconnect the AC power in advance.



Note

AV input devices such as DVD players, VCR's or camcorders as well as your computer can be connected to the LCD Display. For detailed information on connecting AV input devices, refer to the contents under Adjusting Your LCD Display.

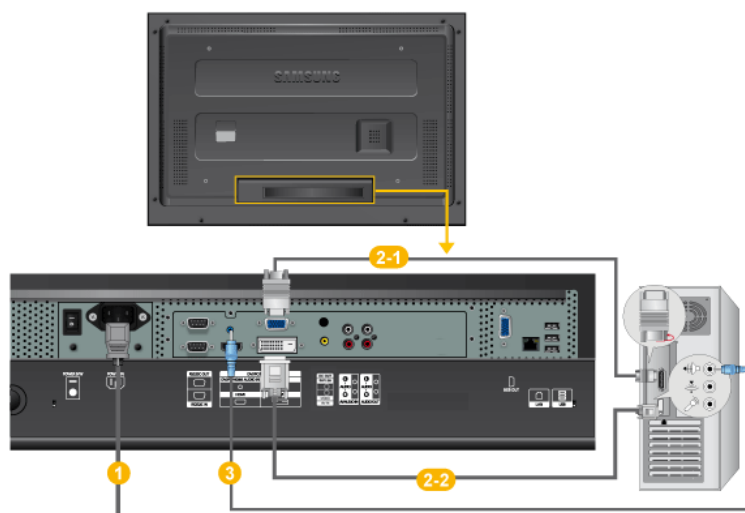

- 1 Connect the power cord for your LCD Display to the power port on the back of the LCD Display. Turn on the power switch.
- 2 There are 2 ways to connect the D-sub to your LCD Display. Choose one of the following:

2-1

Using the D-sub (Analog) connector on the video card.

- Connect the D-sub to the 15-pin, RGB port on the back of your LCD Display and the 15 pin D-sub Port on the computer.

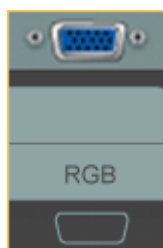

2-2

Using the DVI (Digital) connector on the video card.

- Connect the DVI Cable to the DVI port on the back of your LCD Display and the DVI port on the computer.



- 3 Connect the audio cable for your LCD Display to the audio port on the back of your computer.

 **Note**

- Turn on both your computer and the LCD Display.
- The DVI cable is optional.
- Contact a local SAMSUNG Electronics Service Center to buy optional items.

Connecting to Other devices

Using a Power cord with Earth

- In the event of failure, the earth lead may cause electric shock. Make sure to wire the earth lead in correctly, before connecting the AC power. When unwiring the earth lead, make sure to disconnect the AC power in advance.

 **Note**

AV input devices such as DVD players, VCR's or camcorders as well as your computer can be connected to the LCD Display. For detailed information on connecting AV input devices, refer to the contents under Adjusting Your LCD Display.

Connecting AV Devices

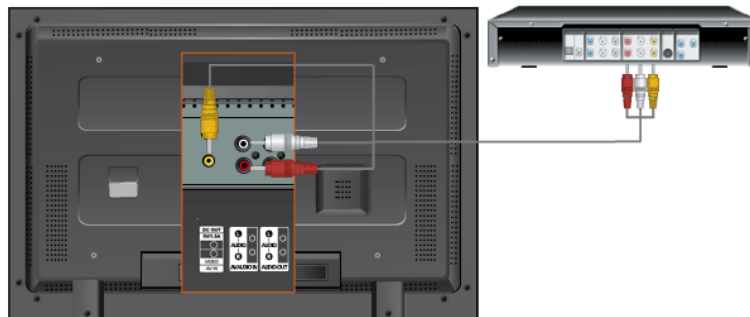

1. Connect the port of the DVD, VCR (DVD / DTV Set-Top Box) to the [R-AUDIO-L] port of the LCD Display.
2. Then, start the DVD, VCR or Camcorders with a DVD disc or tape inserted.
3. Select **AV** using the **SOURCE** .

 **Note**

The LCD Display has AV connection terminals to connect AV input devices like DVDs, VCRs or Camcorders. You may enjoy AV signals as long as the LCD Display is turned on.

Connecting to a Camcorder

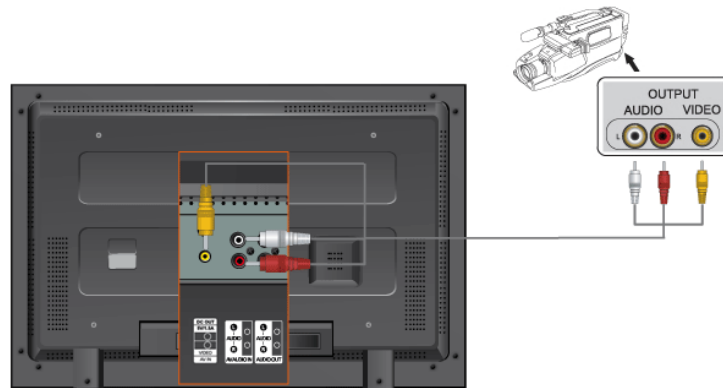

1. Locate the A/V output jacks on the camcorder. They are usually found on the side or back of the camcorder. Connect a set of audio cables between the AUDIO OUTPUT jacks on the camcorder and the AV AUDIO IN [L-AUDIO-R] on the LCD Display .
2. Connect a video cable between the VIDEO OUTPUT jack on the camcorder and the AV IN [VIDEO] on the LCD Display .
3. Select **AV** for the Camcorder connection using the Source button on the front of the LCD Display or on the remote control.
4. Then, start the Camcorders with a tape inserted.



Note

The audio-video cables shown here are usually included with a Camcorder. (If not, check your local electronics store.) If your camcorder is stereo, you need to connect a set of two cables.

Connecting Using a HDMI Cable

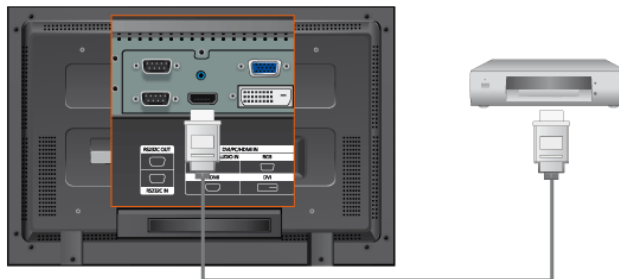

Note

- Input devices such as digital DVD are connected to the HDMI terminal of the LCD Display using the HDMI cable.
- You cannot connect a PC to the HDMI terminal.

Connecting Using a DVI to HDMI Cable

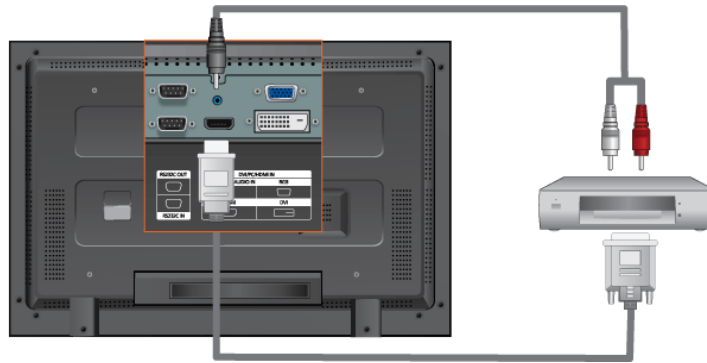

Note

- Connect the DVI output terminal of a digital output device to the HDMI terminal of the LCD Display using a DVI to HDMI cable.
- Connect the red and white jacks of an RCA to stereo (for PC) cable to the same colored audio output terminals of the digital output device, and connect the opposite jack to the DVI/PC/HDMI AUDIO IN terminal of the LCD Display.

Connecting to an Audio System

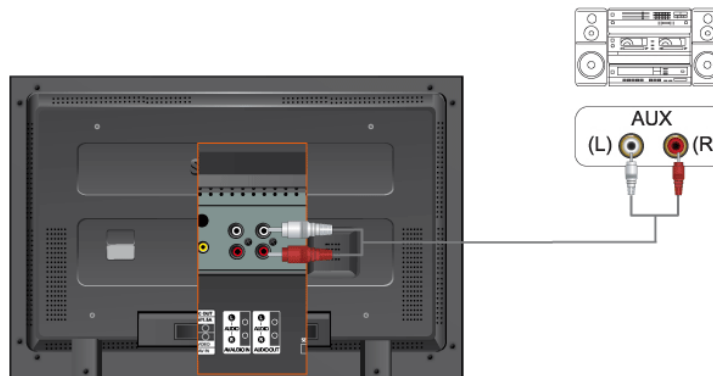

Note

- Connect a set of audio cables between the AUX L, R jacks on the AUDIO SYSTEM and AUDIO OUT [L-AUDIO-R] on LCD Display.

Connecting a LAN Cable



Using a Power cord with Earth

- In the event of failure, the earth lead may cause electric shock. Make sure to wire the earth lead in correctly, before connecting the AC power. When un-wiring the earth lead, make sure to disconnect the AC power in advance.

Note

AV input devices such as DVD players, VCR's or camcorders as well as your computer can be connected to the LCD Display. For detailed information on connecting AV input devices, refer to the contents under Adjusting Your LCD Display.

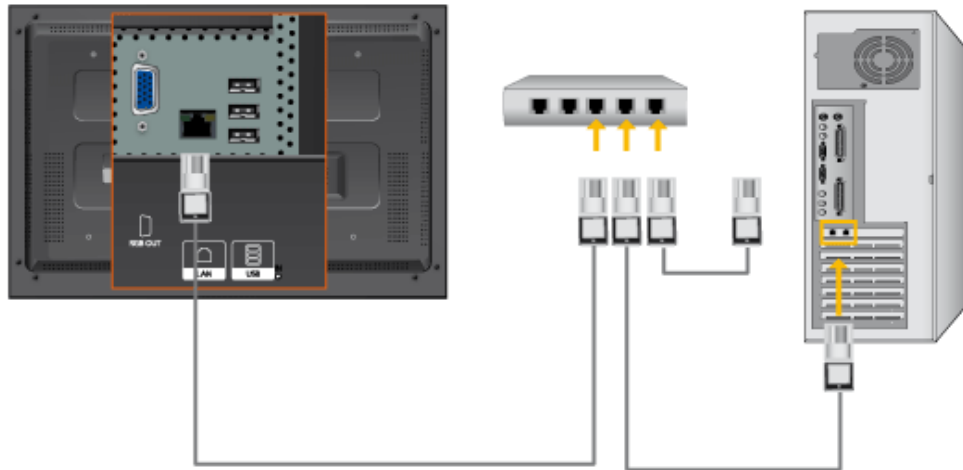

 **Note**

Connect the LAN cable.

(Applicable to the MXn model only)

Connecting a USB device



Using a Power cord with Earth

- In the event of failure, the earth lead may cause electric shock. Make sure to wire the earth lead in correctly, before connecting the AC power. When unwiring the earth lead, make sure to disconnect the AC power in advance.

 **Note**

AV input devices such as DVD players, VCR's or camcorders as well as your computer can be connected to the LCD Display. For detailed information on connecting AV input devices, refer to the contents under Adjusting Your LCD Display.

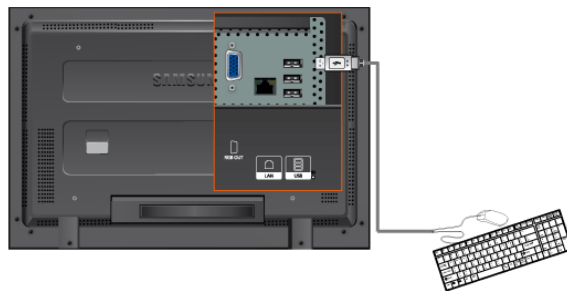

 **Note**

You can connect USB devices such as a mouse or keyboard.

(Applicable to the MXn model only)

Using the Software

Monitor Driver



Note

When prompted by the operating system for the monitor driver, insert the CD-ROM included with this monitor. Driver installation is slightly different from one operating system to another. Follow the directions appropriate for the operating system you have.

Prepare a blank disk and download the driver program file at the Internet web site shown here.

Internet web site :

<http://www.samsung.com/> (Worldwide)

Installing the Monitor Driver (Automatic)

1. Insert CD into the CD-ROM drive.
2. Click "Windows".
3. Choose your monitor model in the model list, then click the "OK" button.

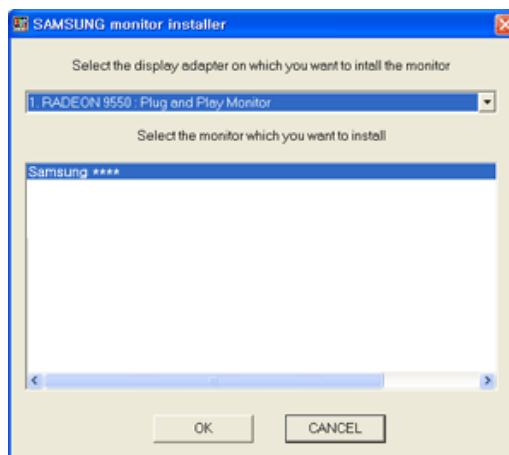

4. If you can see following message window, then click the "Continue Anyway" button. Then click "OK" button (Microsoft® Windows® XP/2000 Operating System).





Note

This monitor driver is under certifying MS logo, and this installation doesn't damage your system.

The certified driver will be posted on Samsung Monitor homepage.

<http://www.samsung.com/>

Installing the Monitor Driver (Manual)

Microsoft® Windows Vista™, Operating System

1. Insert your Manual CD into your CD-ROM drive.
2. Click  (Start) and "Control Panel". Then, double-click on "Appearance and Personalization".



3. Click "Personalization" and then "Display Settings".



4. Click "Advanced Settings...".



5. Click "Properties" in the "Monitor" tab. If the "Properties" button is deactivated, it means the configuration for your monitor is completed. The monitor can be used as is.

If the message "Windows needs..." is displayed, as shown in the figure below, click "Continue".



Note

This monitor driver is under certifying MS logo, and this installation doesn't damage your system. The certified driver will be posted on Samsung Monitor homepage.

6. Click "Update Driver..." in the "Driver" tab.

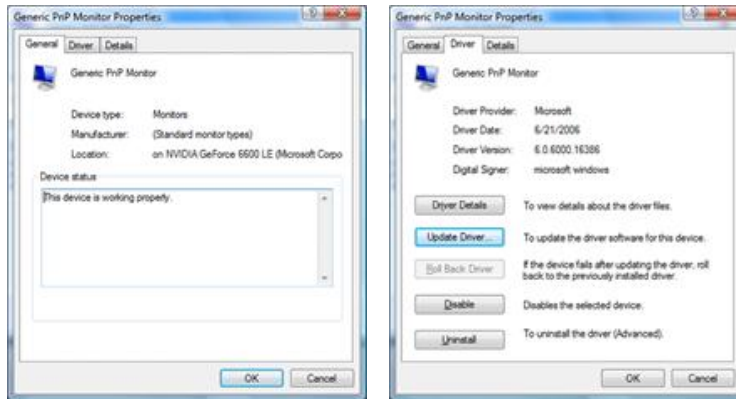

7. Check the "Browse my computer for driver software" checkbox and click "Let me pick from a list of device drivers on my computer".

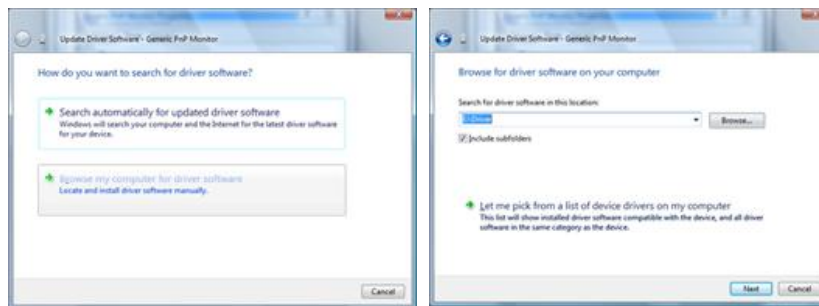

8. Click "Have Disk..." and select the folder (for example, D:\Drive) where the driver setup file is located, and click "OK".

Using the Software

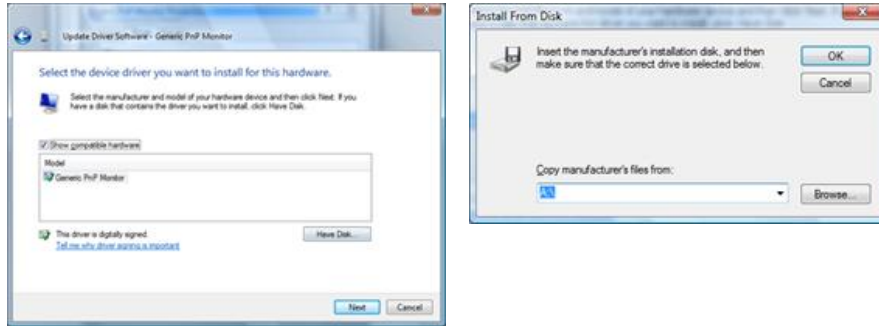

9. Select the model that matches your monitor from the list of monitor models on the screen, and click "Next".

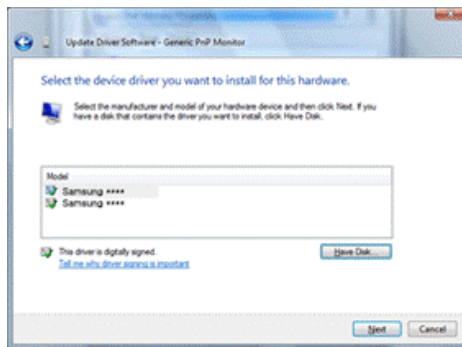

10. Click "Close" → "Close" → "OK" → "OK" on the following screens displayed in sequence.

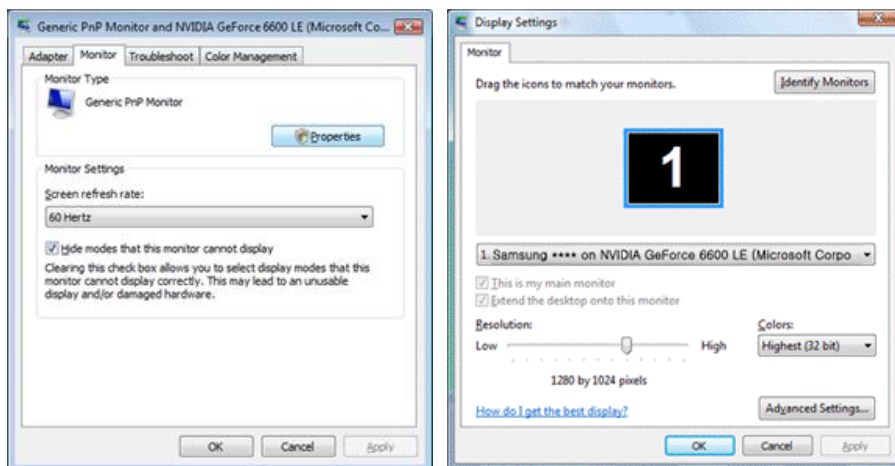
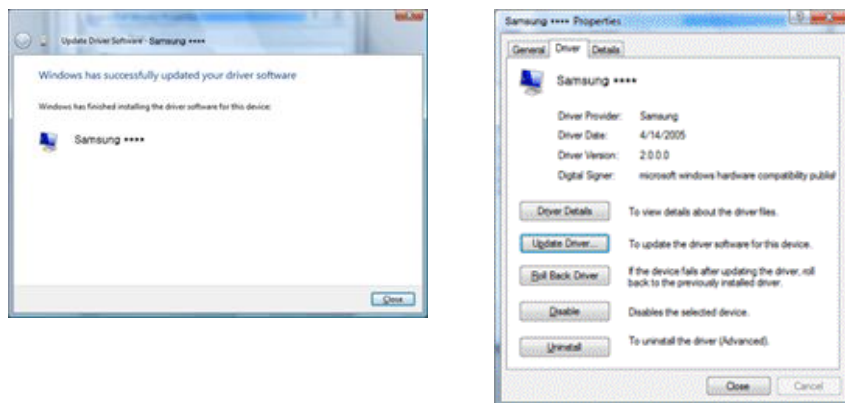

Microsoft® Windows® XP Operating System

1. Insert CD into the CD-ROM drive.
2. Click "Start" → "Control Panel" then click the "Appearance and Themes" icon.

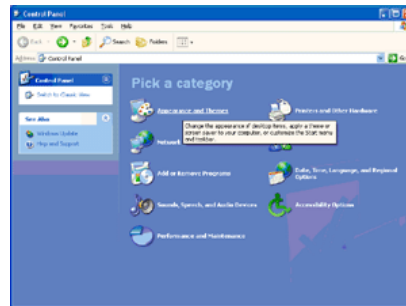

3. Click "Display" icon and choose the "Settings" tab then click "Advanced...".

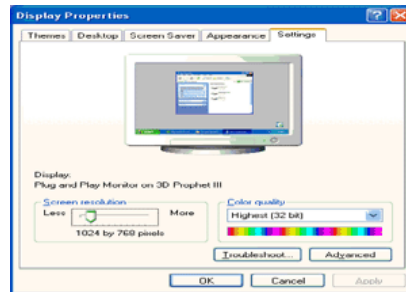
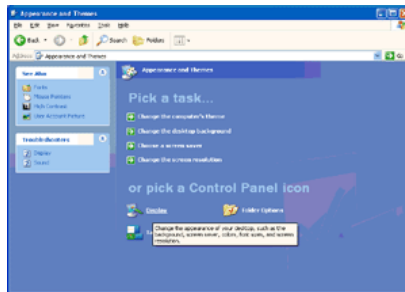

4. Click the "Properties" button on the "Monitor" tab and select "Driver" tab.

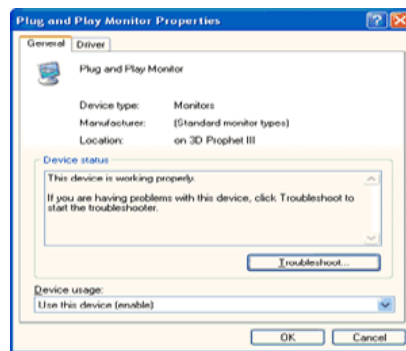
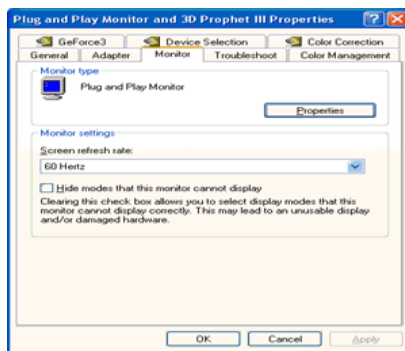

5. Click "Update Driver..." and select "Install from a list or..." then click "Next" button.

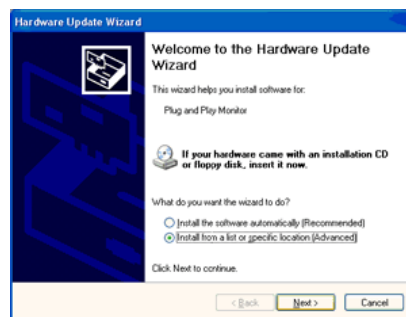
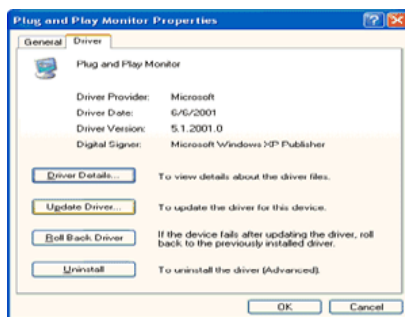

6. Select "Don't search, I will..." then click "Next" and then click "Have disk".

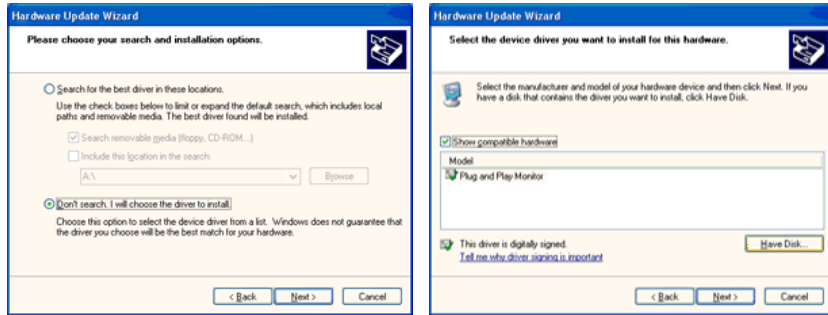

7. Click the "Browse" button then choose A:(D:\Driver) and choose your monitor model in the model list and click the "Next" button.

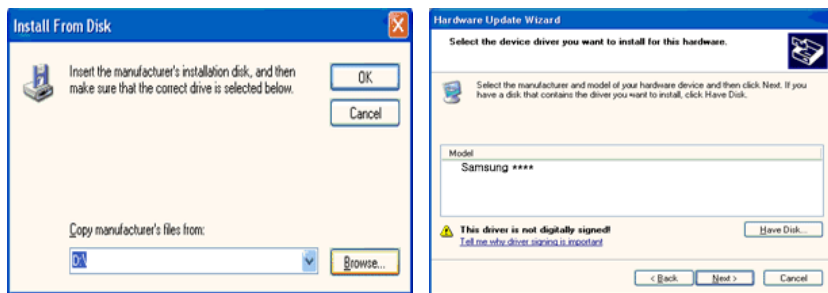

8. If you can see following message window, then click the "Continue Anyway" button. Then click "OK" button.



Note

This monitor driver is under certifying MS logo, and this installation doesn't damage your system.

The certified driver will be posted on Samsung Monitor homepage.

<http://www.samsung.com/>

9. Click the "Close" button then click "OK" button continually.

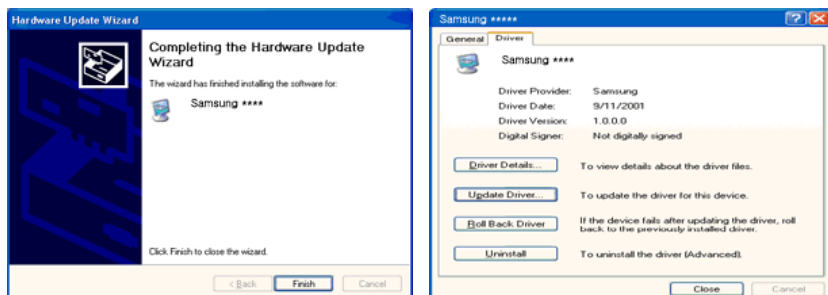

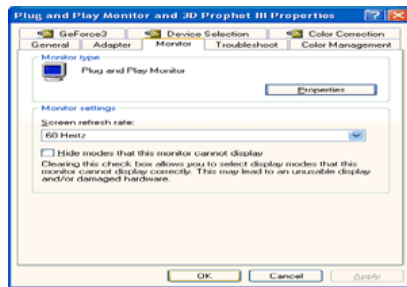

10. Monitor driver installation is completed.

Microsoft® Windows® 2000 Operating System

When you can see "Digital Signature Not Found" on your monitor, follow these steps.

1. Choose "OK" button on the "Insert disk" window.
2. Click the "Browse" button on the "File Needed" window.
3. Choose A:(D:\Driver) then click the "Open" button and then click "OK" button.

How to install

1. Click "Start", "Setting", "Control Panel".
2. Double click the "Display" icon.
3. Select the "Settings" tab and click "Advanced Properties" button.
4. Choose "Monitor".

Case1 : If the "Properties" button is inactive, it means your monitor is properly configured. Please stop installation

Case2 : If the "Properties" button is active, click the "Properties" button then follow next steps continually.

5. Click "Driver" and then click on "Update Driver..." then click on the "Next" button.
6. Choose "Display a list of the known drivers for this device so that I can choose a specific driver" then click "Next" and then click "Have disk".
7. Click the "Browse" button then choose A:(D:\Driver).
8. Click the "Open" button, then click "OK" button.
9. Choose your monitor model and click the "Next" button then click "Next" button.
10. Click the "Finish" button then the "Close" button.

If you can see the "Digital Signature Not Found" window then click the "Yes" button. And click the "Finish" button then the "Close" button.

Microsoft® Windows® Millennium Operating System

1. Click "Start", "Setting", "Control Panel".
2. Double click the "Display" icon.
3. Select the "Settings" tab and click "Advanced Properties" button.

4. Select the "Monitor" tab.
5. Click the "Change" button in the "Monitor Type" area.
6. Choose "Specify the location of the driver".
7. Choose "Display a list of all the driver in a specific location..." then click "Next" button.
8. Click the "Have Disk" button.
9. Specify A:\(D:\driver) then click "OK" button.
10. Select "Show all devices" and choose the monitor that corresponds to the one you connected to your computer and click "OK".
11. Continue choosing "Close" button and "OK" button until you close the Display Properties dialogue box.

Microsoft® Windows® NT Operating System

1. Click "Start", "Settings", "Control Panel", and then double-click "Display" icon.
2. In Display Registration Information window, click Settings Tab and then click "All Display Modes".
3. Select a mode that you wish to use (Resolution, Number of colors and Vertical frequency) and then click "OK".
4. Click "Apply" button if you see the screen working normally after clicking "Test". If the screen is not normal, change to a different mode (lower mode of resolution, colors or frequency).



Note

If there is no Mode at All Display Modes, select the level of resolution and vertical frequency by referring to the Preset Timing Modes in the user guide.

Linux Operating System

To execute X-Window, you need to make the X86Config file, which is a type of system setting file.

1. Press "Enter" at the first and the second screen after executing the X86Config file.
2. The third screen is for setting your mouse.
3. Set a mouse for your computer.
4. The next screen is for selecting a keyboard.
5. Set a Keyboard for your computer.
6. The next screen is for setting your monitor.
7. First of all, set a horizontal frequency for your monitor. (You can enter the frequency directly.)
8. Set a vertical frequency for your monitor. (You can enter the frequency directly.)
9. Enter the model name of your monitor. This information will not affect the actual execution of X-Window.
10. You have finished setting up your monitor. Execute X-Window after setting other requested hardware.

Installation MagicInfo Pro

Installation

1. Insert CD into the CD-ROM drive.
2. Click the MagicInfo Pro installation file.
3. When the Install Shield Wizard window appears, click "Next."

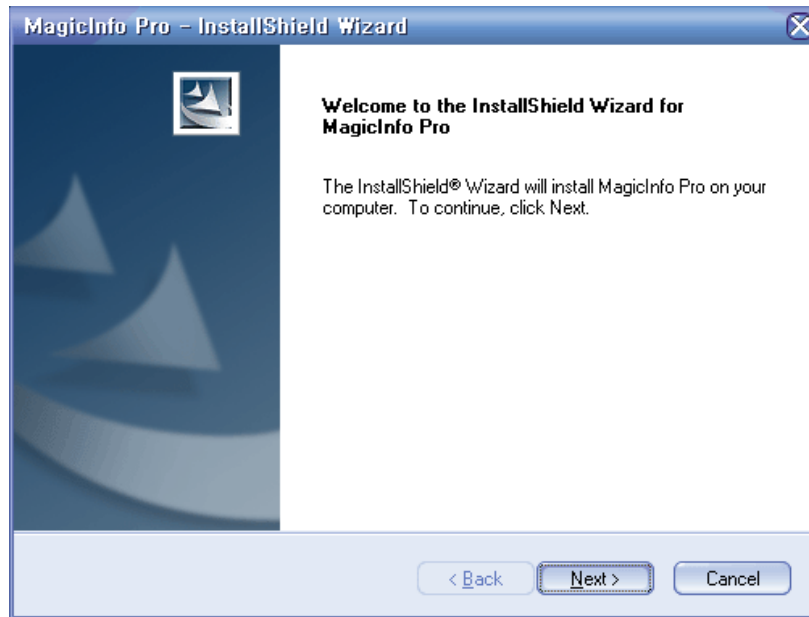

4. Select "I agree to the terms of the license agreement" to accept the terms of use.

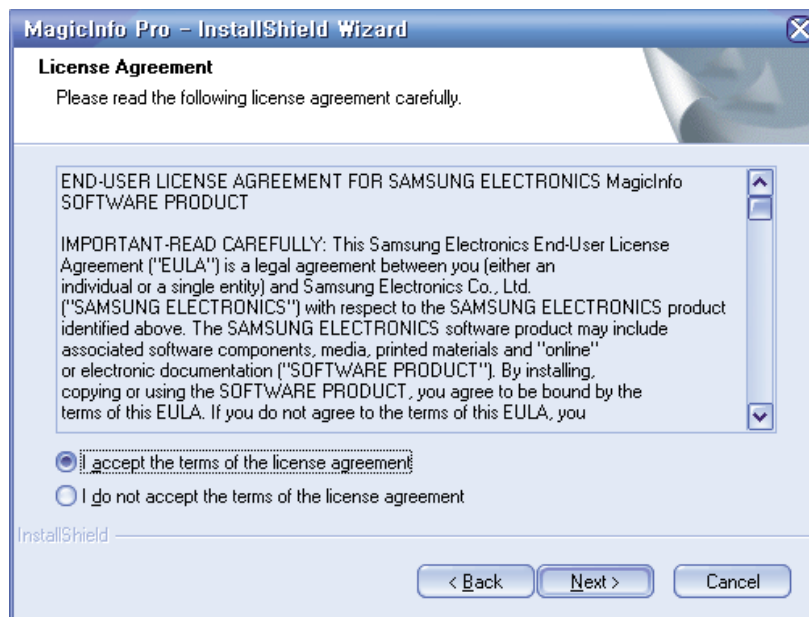

5. You are required to log in to the MagicInfo Pro Server program. Please enter the password to login. The password cannot be changed when you are logged in.



6. Choose a folder to install the MagicInfo Pro program.

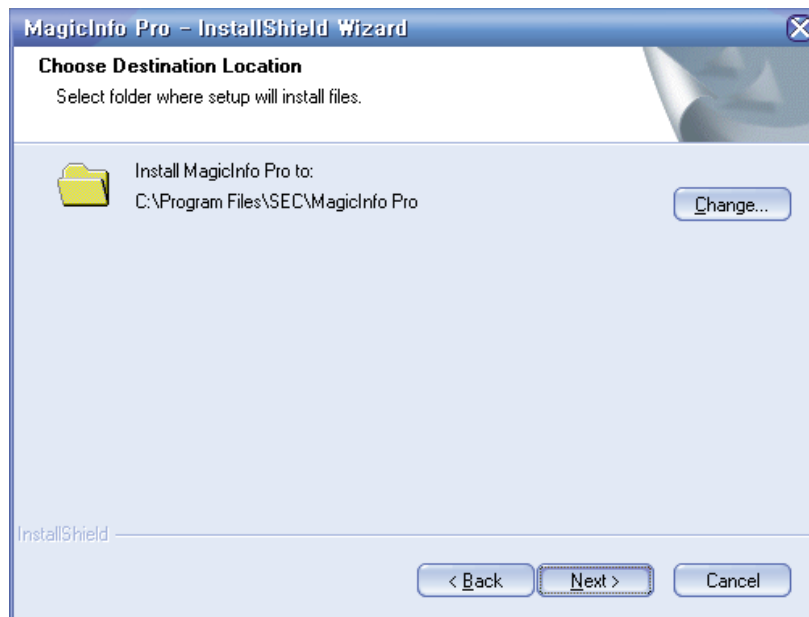

7. Click "Install."

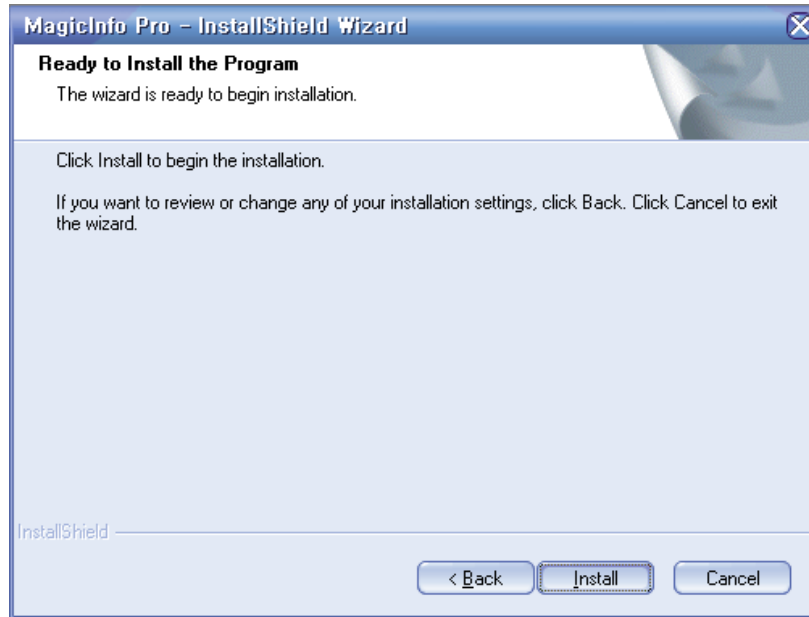

8. The "Installation Status" window appears.

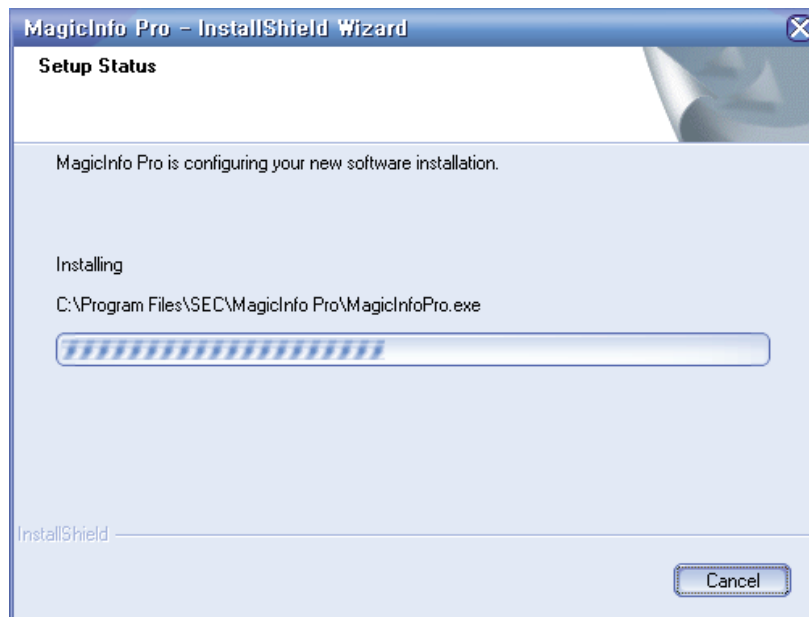

9. It is recommended restarting the system for the normal operation of the MagicInfo Pro Server program. Click "Finish".

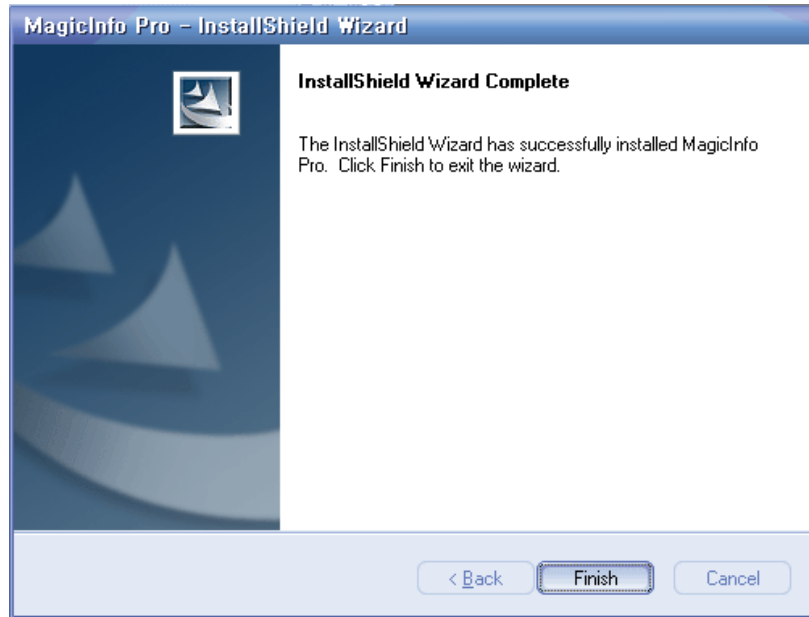

10. When the installation is complete, the MagicInfo Pro executable icon appears on your desktop.

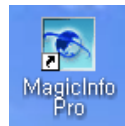

11. Double-click the icon to start the program.

System Requirements

	CPU	RAM	Ethernet	OS	Application
Minimum	P1.8	256M	100M/1G	Windows XP	WMP 9 or
Recommen- ded	P3.0GHz	512M		Windows 2000 (Serv- ice Pack 4)	later

Multiple Display Control

MDC System

Introduction

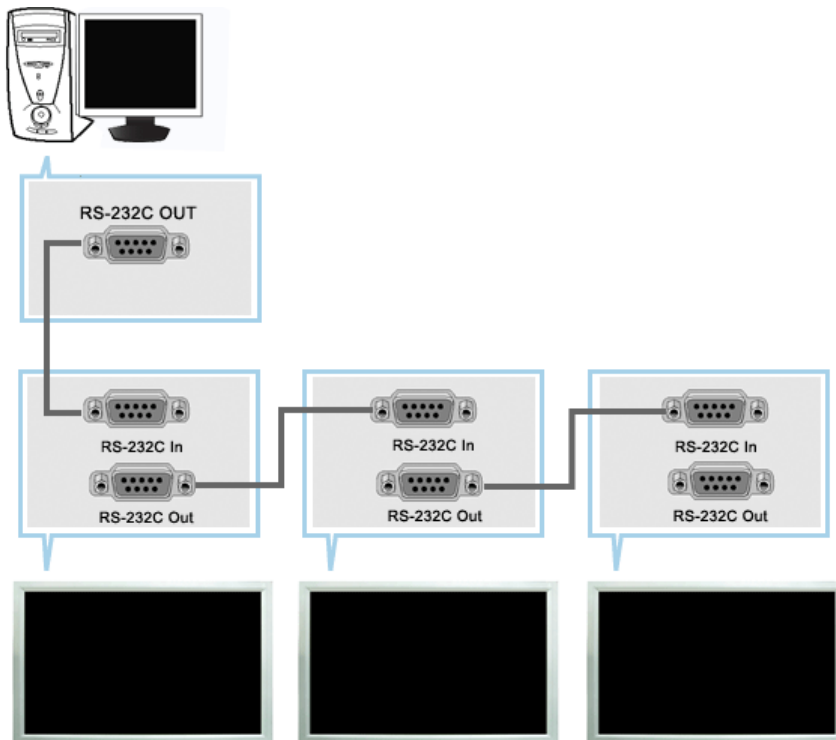

A Multiple Display Control (MDC) is an application allowing various displays to be easily and simultaneously operated on a PC. RS-232C, a standard of serial communication, is used for the communication between a PC and a display. Therefore, a serial cable should be connected between the serial port on a PC and the serial port on a display.

Main Screen

Click Start > Program > Samsung > MDC System to start the program.

Select a set to see the volume of the selected set within the slider.

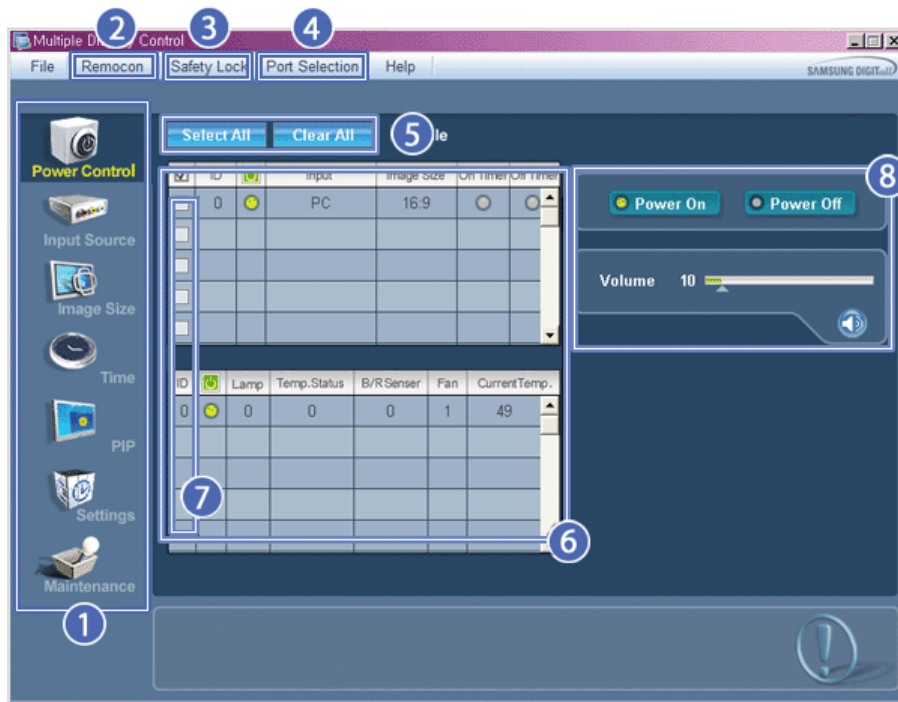

- | | |
|-------------------------|----------------------------|
| 1 Main Icons | 5 Select Button |
| 2 Remocon | 6 Info Grid |
| 3 Safety Lock | 7 Display Selection |
| 4 Port Selection | 8 Control Tools |

1. Use the main icons to switch into each screen.
2. Allows you to enable or disable the remote control signal receiving function of the display unit.
3. Set the Safety Lock function.
When setting the Lock function, you can only operate power and lock buttons on the remote control and set.
4. The setting for the PC Serial Port can change. The original value is COM1.
5. Click Select all or Clear to select or clear all displays.
6. Use Grid to view brief information on selected display.
7. Select a display from Display Selection.
8. Use Control Tools to control displays.

<Note> The remote control Enable/Disable function operates whether or not the power is On/Off, and this applies to all displays connected to the MDC. However, regardless of the status at the time the MDC is shut down, the remote control signal receiving function of all displays is initialized to Enable when the MDC is closed.

Port Selection

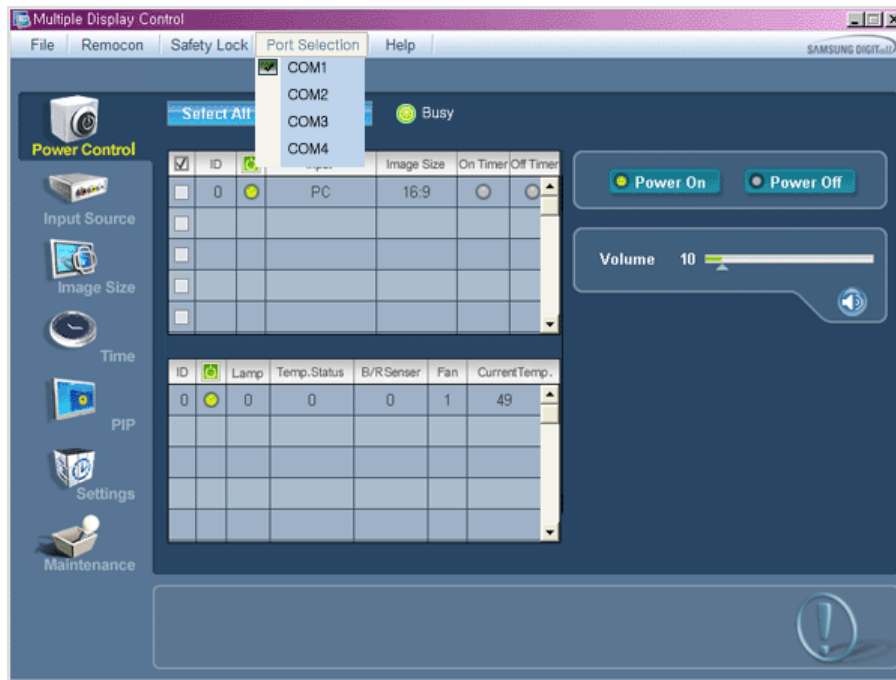

1. The Multiple Display Control is originally set to COM1.
2. If any port other than COM1 is used, COM1 through COM4 can be selected in the Port Selection Menu.
3. If the exact port name that is connected to the LCD Display using a serial cable is not selected, communication will be unavailable.
4. The selected port is stored in the program and used for the next program as well.



Power Control

1. Click Power Control of the main icons and the Power Control screen appears.

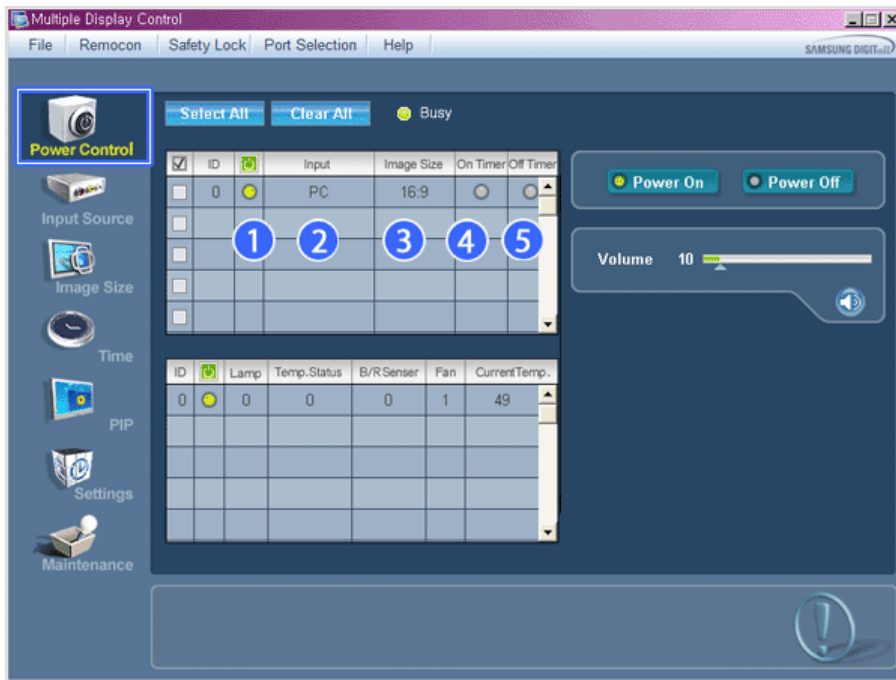

* Info Grid shows some basic information necessary to Power Control.

- 1) (Power Status)
- 2) Input
- 3) Image Size
- 4) On Timer
- 5) Off Timer

2. Use the Select All button or Check Box to choose a display to control.

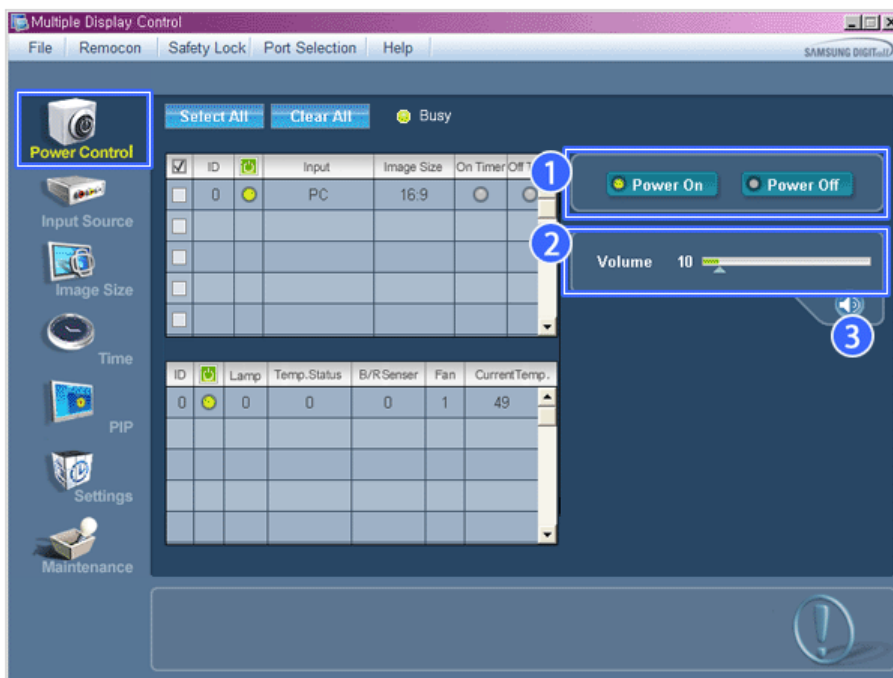

* Power Control allows controlling some of the functions of the selected display.

- 1) Power On/Off

- Turns the power of the selected display On/Off.
- 2) Volume
- Controls the volume level of the selected display.
 - It receives the volume value of the selected display from the sets and displays it in the slider.
 - (When you cancel the selection or choose Select All, the value returns to the default value 10)
- 3)  (Mute On/Off)
- Turns on/off the Mute function of the selected display.
 - When selecting one set at a time, turn on the Mute function for the selected set.
 - The Mute function is disabled automatically when you adjust the volume level.
 - (The values return to the default settings when you undo the selections or choose "Select All".)

* **The Power Control feature is available for all displays.**

* **The Volume Control and Mute features are available only for the displays whose power status is ON.**

Input Source

1. Click Input Source of the main icons and the Input Source control screen appears.
- Click Select All or use Check Box to select a display to control.

- TV Mode

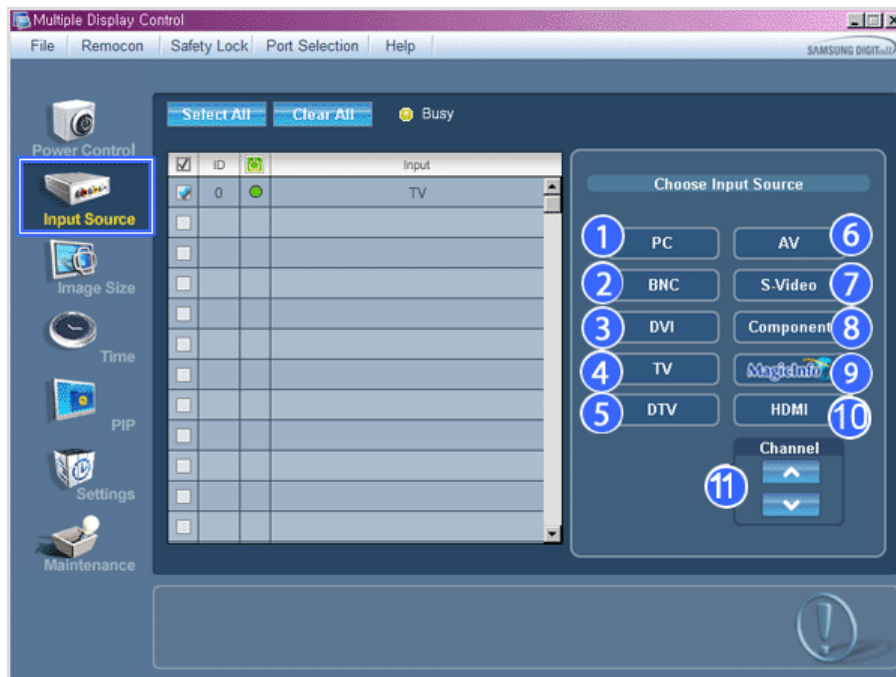

- PC Mode

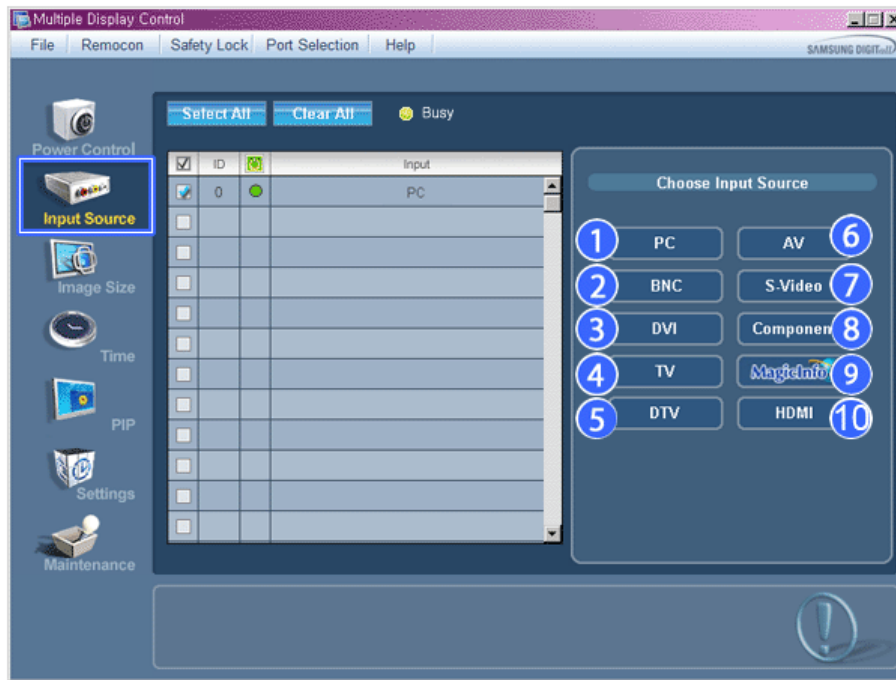

* Info Grid shows some basic information necessary to Input Source Control.

- 1) PC
- Changes the Input Source of the selected display to PC.
- 2) BNC
- Changes the Input Source of the selected display to BNC.
- 3) DVI
- Changes the Input Source of the selected display to DVI.
- 4) TV
- Changes the Input Source of the selected display to TV.
- 5) DTV
- Changes the Input Source of the selected display to DTV.
- 6) AV
- Changes the Input Source of the selected display to AV.
- 7) S-Video
- Changes the Input Source of the selected display to S-Video.
- 8) Component
- Changes the Input Source of the selected display to Component.
- 9) MagicInfo
- The Input source of MagicInfo works only on MagicInfo model.
- 10) HDMI
- Changes the Input Source of the selected display to HDMI.
- 11) Channel
- Channel arrow appears when the Input Source is TV.

* **TV Source can be selected only in products with TV and controlling channels is allowed only when Input Source is TV.**

* **The Input Source Control feature is available only for the displays whose power status is ON.**

Image Size

PC, BNC, DVI

1. Click Image Size of the main icons and the Image Size control screen appears.

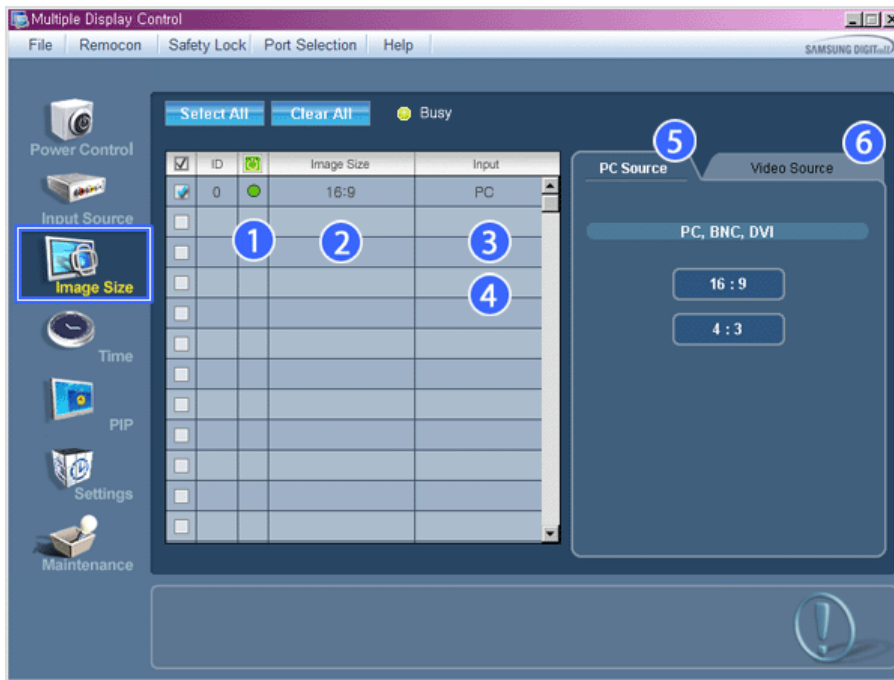

* Info Grid shows some basic information necessary to Image Size Control.

- 1)  (Power Status)
 - Shows the power status of the current display.
- 2) Image Size
 - Shows the current Image Size of the display in use.
- 3) Input
 - Shows the current Input Source of the display in use.
- 4) Info Grid displays only the displays whose Input Source is PC, BNC, DVI.
- 5) PC Source - When you click Image Size, the PC Source tab first appear.
 - The Image Size Control button controls Image Size available for PC, BNC, DVI.
- 6) Video Source
 - Click the Video Source tab to control Image Size for respective Input Source.

* **The Input source of MagicInfo works only on MagicInfo model.**

* **The Input source of TV works only on TV model.**

* **Image Size Control is available only for the displays for which power status is ON.**



Image Size

TV, AV, S-Video, Component, DVI(HDCP), HDMI, DTV

1. Click Image Size of the main icons and the Image Size control screen appears.

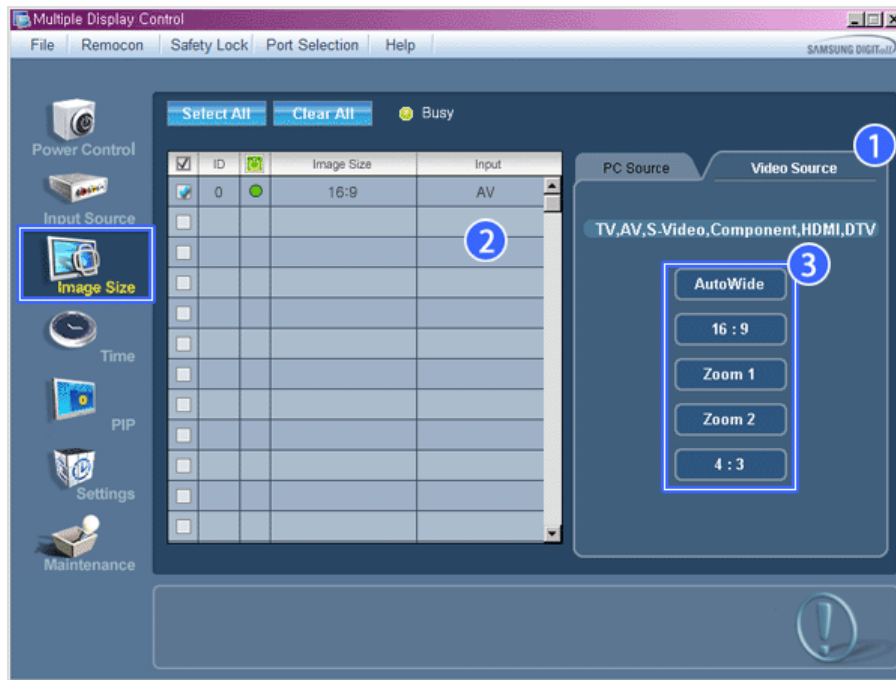

* Info Grid shows some basic information necessary to Image Size Control.

- 1) Click the Video Source tab to adjust Image Size for TV, AV, S-Video, Component, DVI(HDCP), HDMI, DTV. Click Select All or use Check Box to select a display to control.
- 2) Info Grid displays only the display having TV, AV, S-Video, Component or DVI(HDCP) as input source.
- 3) Switch Image Size of the selected display randomly.

Note: Auto Wide, Zoom1 and Zoom2 are not available for selection when the input signal type for Component and DVI (HDCP) is 720p or 1080i. (The Auto Wide mode is available only for TV, AV, and S-Video.)

* The Input source of MagicInfo works only on MagicInfo model.

* The Input source of TV works only on TV model.

* The Image Size Control feature is available only for the displays whose power status is ON.



Time

1. Click Time of the main icons and the Time Control screen appears.

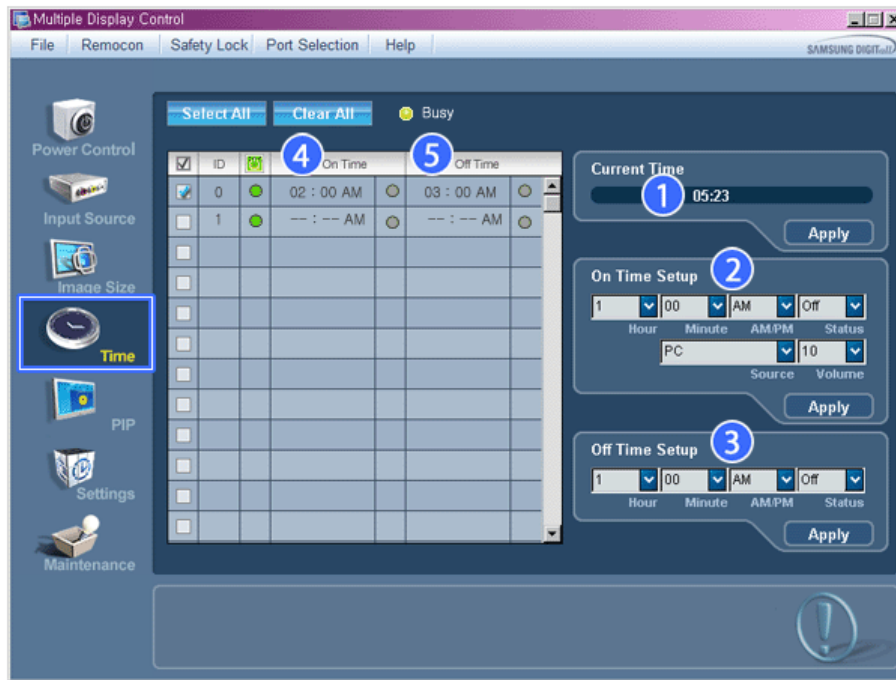

* Info Grid shows some basic information necessary to Time Control.

- 1) Current Time
 - Set the current time for the selected display (PC Time).
 - To change the current time, first change the PC Time.
- 2) On Time Setup
 - Set the Hour, Minute, AM/PM of On Time Setup, Status, Source, Volume of the selected display.
- 3) Off Time Setup
 - Set the Hour, Minute, and AM/PM, Status for Off Time Setup of the selected display.
- 4) Shows the On Time settings.
- 5) Shows the Off Time settings.

* **The Input source of MagicInfo works only on MagicInfo model.**

* **The Input source of TV works only on TV model.**

* **Time Control is available only for the displays for which the power status is ON.**

* **At On Time Setup, TV Source functions only for TV Model.**

* **At On Time Setup, MagicInfo Source functions only for MagicInfo Model.**



PIP

PIP Size

1. Click PIP of the main icons and the PIP control screen appears.
Click Select All or use Check Box to select a display to control.

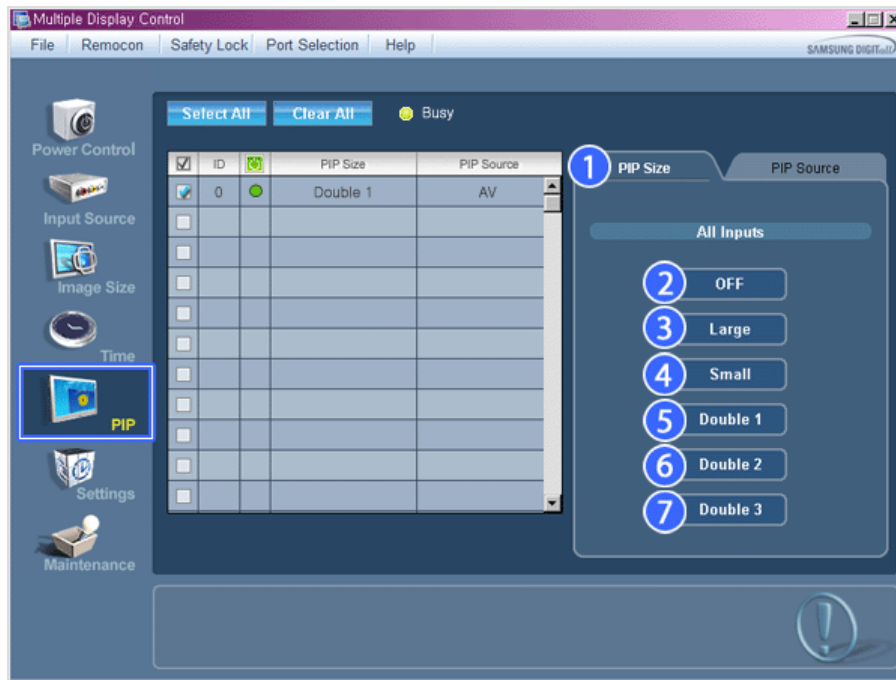

* Info Grid shows some basic information necessary to PIP Size Control.

- 1) PIP Size
 - Shows the current PIP Size of the display in use.
- 2) OFF
 - Turns off the PIP of the selected display.
- 3) Large
 - Turns on the PIP of the selected display and changes the size to Large.
- 4) Small
 - Turns on the PIP of the selected display and changes the size to Small.
- 5) Double 1
 - Turns on the PIP of the selected display and changes the size to Double 1.
- 6) Double 2
 - Turns on the PIP of the selected display and changes the size to Double 2.
- 7) Double 3 (Picture By Picture)
 - Turns on the PBP of the selected display and changes the size to Double 3.

- * **The Input source of MagicInfo works only on MagicInfo model.**
- * **The Input source of TV works only on TV model.**
- * **PIP Size can be controlled with turning on the LCD Display power.**



PIP Source

1. Click PIP of the main icons and the PIP control screen appears.

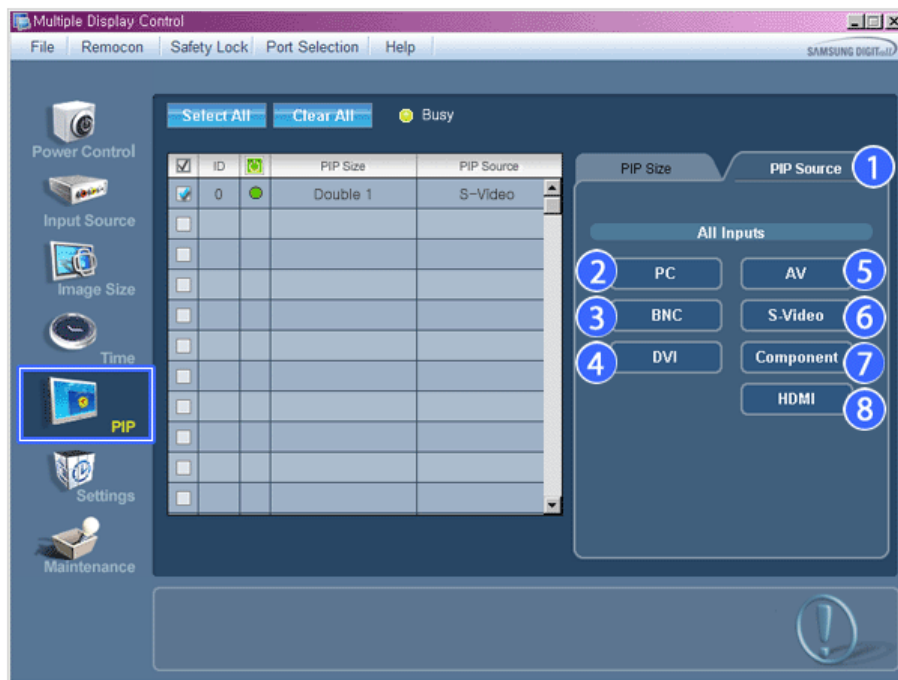

* Info Grid shows some basic information necessary to PIP Source Control.

- 1) PIP Source
 - PIP Source can be controlled with turning on the LCD Display power.
- 2) PC
 - Changes the source of the PIP of the selected display to PC.
- 3) BNC
 - Changes the source of the PIP of the selected display to BNC.
- 4) DVI
 - Changes the source of the PIP of the selected display to DVI.
- 5) AV
 - Changes the source of the PIP of the selected display to AV.
- 6) S-Video
 - Changes the source of the PIP of the selected display to S-Video.
- 7) Component
 - Changes the source of the PIP of the selected display to Component.
- 8) HDMI
 - Changes the source of the PIP of the selected display to HDMI.

Note: Some of the PIP Sources may not be available for selection, depending on the input source type of the Main Screen.

* The Input source of MagicInfo works only on MagicInfo model.

* The PIP Control feature is available only for the displays whose power status is ON and the PIP function is set to ON.



Settings

Picture

1. Click Settings of the main icons and the Settings Control screen appears.



* Info Grid shows some basic information necessary to Settings Control.
 When each function is selected, the set value of the selected function is displayed in the slide. When selected, each function fetches the value for the set and displays it on the slide bar. When "Select All" is chosen, the default value is displayed. Changing a value in this screen will automatically change the mode to "CUSTOM."

- 1) Picture
 - Available only for TV, AV, S-Video, Component, HDMI, DTV.
- 2) Contrast
 - Adjusts Contrast of the selected display.
- 3) Brightness
 - Adjusts Brightness of the selected display.
- 4) Sharpness
 - Adjusts Sharpness of the selected display.
- 5) Color
 - Adjusts Color of the selected display.
- 6) Tint
 - Adjusts Tint of the selected display.
 - Available only for NT.
- 7) Color Tone
 - Adjusts the Color Tone for the selected display.
- 8) Color Temp
 - Adjusts the Color Temp for the selected display.
- 9) Brightness Sensor
 - Adjusts the Brightness Sensor for the selected display.
- 10) Dynamic Contrast
 - Adjusts the Dynamic Contrast for the selected display.

* **The Input source of MagicInfo works only on MagicInfo model.**

* **Color Temp is only enabled if the Color Tone is set to Off.**

* **The Input source of TV works only on TV model.**

* **This feature is available only for the displays whose power status is ON and if no selection is made, the factory default is displayed.**



Picture PC

1. Click Settings of the main icons and the Settings Control screen appears.



* Info Grid shows some basic information necessary to Settings Control. When each function is selected, the set value of the selected function is displayed in the slide. When selected, each function fetches the value for the set and displays it on the slide bar. When "Select All" is chosen, the default value is displayed. Changing a value in this screen will automatically change the mode to "CUSTOM."

- 1) Picture PC
 - Available only for PC, BNC, DVI.
- 2) Contrast
 - Adjusts Contrast of the selected display.
- 3) Brightness
 - Adjusts Brightness for the selected display.
- 4) Red
 - Adjusts red Color of the selected display.
 - Available only for NT.
- 5) Green
 - Adjusts green Color of the selected display.
 - Available only for NT.
- 6) Blue
 - Adjusts blue Color of the selected display.
 - Available only for NT.
- 7) Color Tone
 - Adjusts the Color Tone for the selected display.
- 8) Color Temp
 - Adjusts the Color Temp for the selected display.
- 9) Brightness Sensor
 - Adjusts the Brightness Sensor for the selected display.

* **The Input source of MagicInfo works only on MagicInfo model.**

* **The Input source of TV works only on TV model.**

* **Color Temp is only enabled if the Color Tone is set to Off.**

* **This feature is available only for the displays whose power status is ON and if no selection is made, the factory default is displayed.**



Audio

1. Click Settings of the main icons and the Settings Control screen appears.

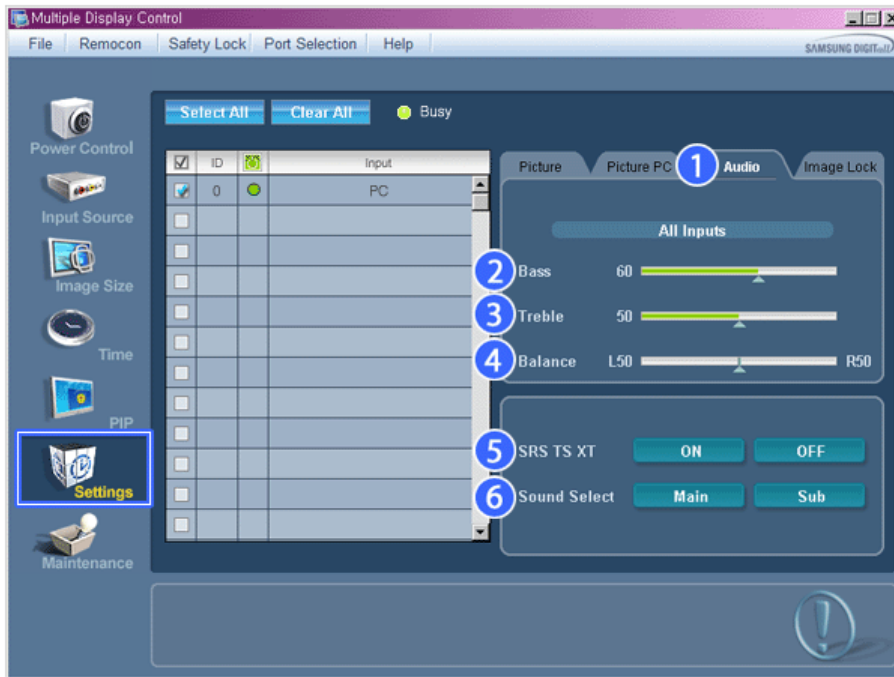

* Info Grid shows some basic information necessary to Settings Control. When each function is selected, the set value of the selected function is displayed in the slide. When selected, each function fetches the value for the set and displays it on the slide bar. When "Select All" is chosen, the default value is displayed. Changing a value in this screen will automatically change the mode to "CUSTOM."

- 1) Audio
 - Controls audio settings for all input sources.
- 2) Bass
 - Adjusts Bass of the selected display.
- 3) Treble
 - Adjusts Treble of the selected display.
- 4) Balance
 - Adjusts Balance of the selected display.
- 5) SRS TS XT
 - SRS TS XT Sound ON/OFF of the selected display.
- 6) Sound Select
 - Select either Main or Sub when PIP is On.

* **The Input source of MagicInfo works only on MagicInfo model.**

* **The Input source of TV works only on TV model.**

* **This feature is available only for the displays whose power status is ON and if no selection is made, the factory default is displayed.**



Settings

Image Lock

1. Click Settings of the main icons and the Settings Control screen appears.

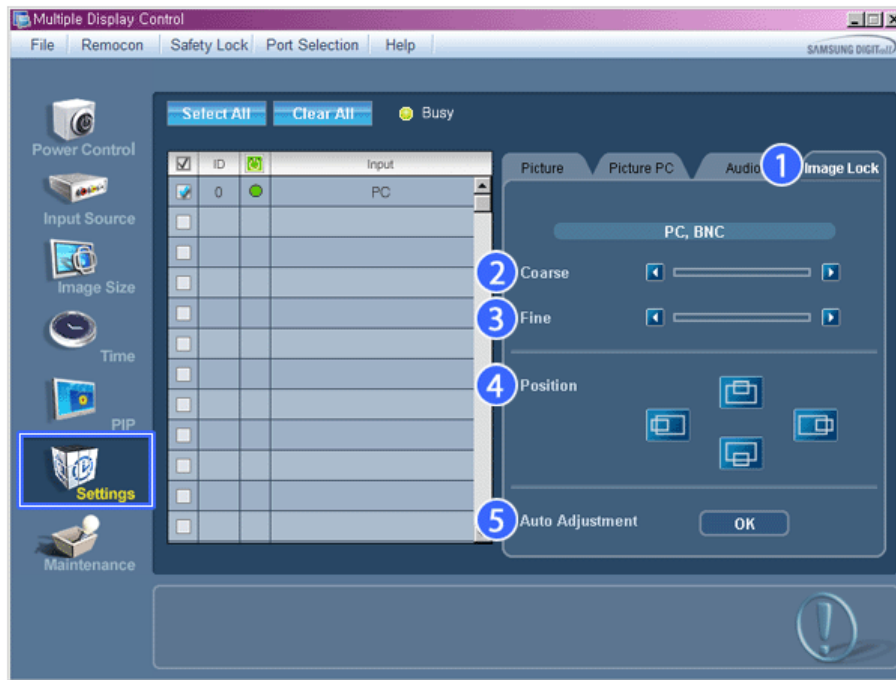

* Info Grid shows some basic information necessary to Settings Control.

- 1) Image Lock
 - Available only for PC, BNC.
- 2) Coarse
 - Adjusts Coarse of the selected display.
- 3) Fine
 - Adjusts Fine of the selected display.
- 4) Position
 - Adjusts Position of the selected display.
- 5) Auto Adjustment
 - Self-Adjust to the incoming PC signal.

* **The Input source of MagicInfo works only on MagicInfo model.**

* **The Input source of TV works only on TV model.**

* **Settings Control is available only for the displays for which the power status is ON.**



Maintenance

Lamp Control

1. Click on the "Maintenance" icon in the Main Icon column to display the Maintenance screen.

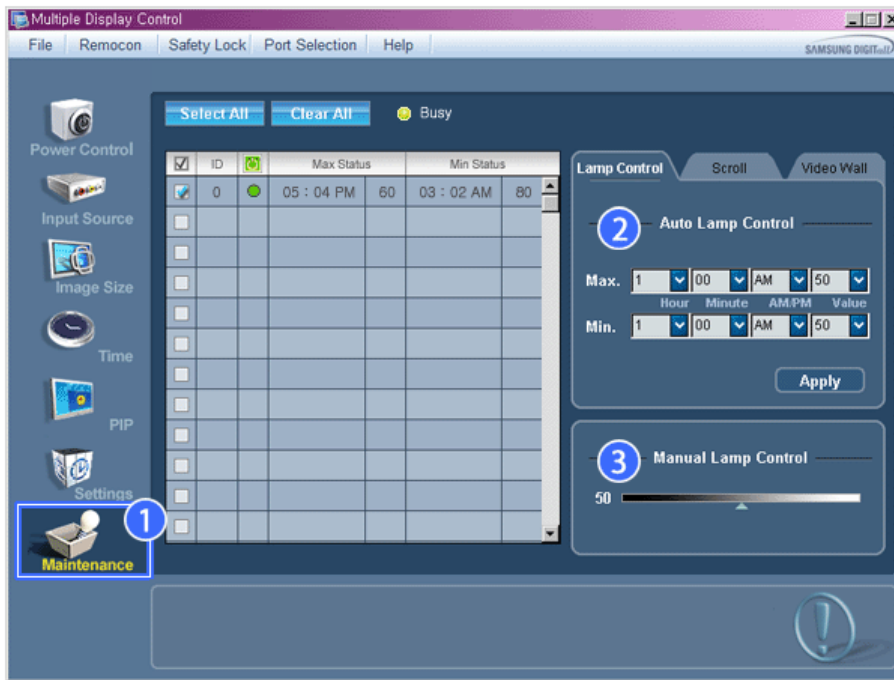

* An "Info Grid" showing several basic data items appears.

- 1) Maintenance
 - Allows the Maintenance Control function for all input sources.
- 2) Auto Lamp Control
 - Automatically adjusts the backlight of the selected display at a specified time.
 - The Manual Lamp Control automatically turns off if you adjust using the Auto Lamp Control.
- 3) Manual Lamp Control
 - Allows you to adjust the backlight of the selected display regardless of the time.
 - The Auto Lamp Control automatically turns off if you adjust using the Manual Lamp Control.

* **The Maintenance Control feature is available only for the displays whose power status is ON.**

* **The Input source of MagicInfo works only on MagicInfo model.**

* **The Input source of TV works only on TV model.**



Maintenance

Scroll

1. Click on the "Maintenance" icon in the Main Icon column to display the Maintenance screen.

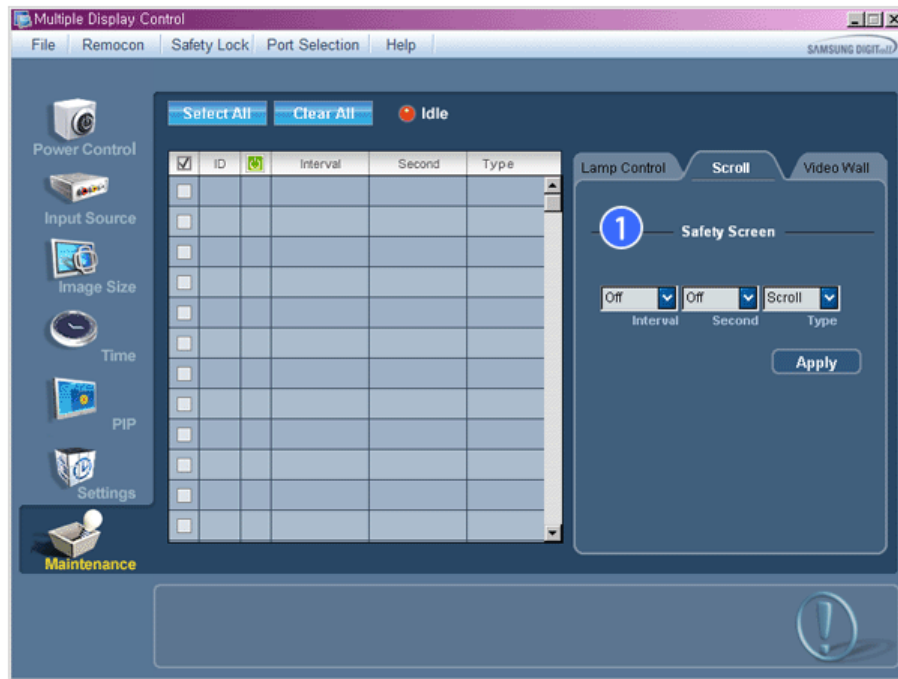

1) Safety Screen

- Eliminates the afterimages that can result when the selected display stays in Pause mode for an extended period of time. You can set the repeat cycle timer by selecting the "Interval" by hour and "Second" by second. It can be set to Scroll, Pixel, Bar and Eraser by Screen Type.

- * **The Input source of MagicInfo works only on MagicInfo model.**
- * **The Input source of TV works only on TV model.**
- * **Setting Second, you can set to 1, 2, 3, 4, 5 for Scroll Type and to 10, 20, 30, 40, 50 for Pixel, Bar, and Eraser Type.**
- * **The Maintenance Control feature is available only for the displays whose power status is ON.**



Maintenance

Video Wall

1. Click on the "Maintenance" icon in the Main Icon column to display the Maintenance screen.

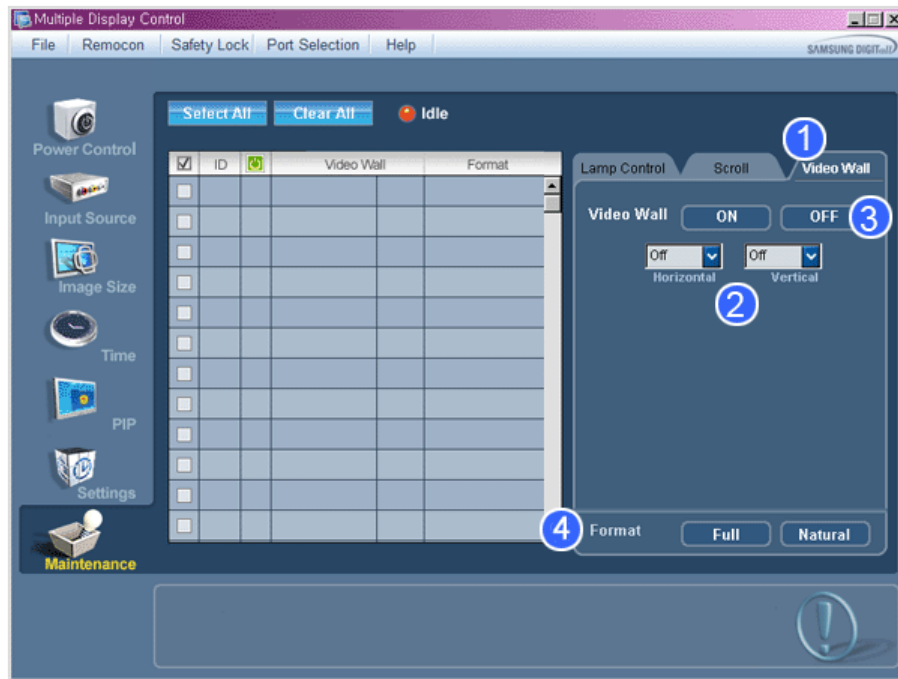

1) Video Wall

- A Video Wall is a set of video screens that are connected together, so that each screen shows a part of the whole picture or so that the same picture is repeated on each screen.

2) Video Wall (Screen divider)

- The screen can be divided into.
 - You can select a number of screens with a different layout when dividing.
 - Select a mode from Screen divider.
 - Select a display from Display Selection.
 - The place will be set up by pressing a number in the selected mode.
 - The MDC program supplied by Samsung supports up to 5x5 LCD Displays.

3) On / Off

- Turns on/off the Video Wall function of the selected display.

4) Format

- The format can be selected to see a divided screen.

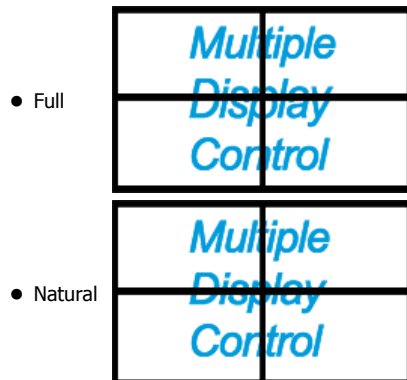

* You may not operate this function in MagicInfo.

* The Input source of TV works only on TV model.

* The Maintenance Control function is available only for the displays where the power status is ON.

Troubleshooting

- The display you wish to control does not appear on the Power Control Info Grid
 - Check the connection of RS232C. (Check if it is properly connected to the Com1 port)

- Check the displays to see if any of the other displays connected have the same ID. If more than one displays have the same ID, those displays are not properly detected by the program due to data conflict.
- Check if the Display Set ID is a number between 0 and **25**. (Adjust using the Display menu)

Note : A Display Set ID must be a value between 0 and **25** .

- The display you wish to control does not appear on the other Control Info Grids
 - Check to see if the display power is ON. (You can check this in Power Control Info Grid)
 - Check if you can change the input source of the display.
- The dialogue box appears repeatedly.
 - Check to see if the display you wish to control is selected.
- Both On Timer and Off Timer have been set but different time is showing.
 - Apply current time to synchronize the display clocks.
- The remote may not function properly when you turn off the remote Function, disconnect the RS-232C cable, or exit the program in an Irregular manner. Rerun the program and turn the remote function again to Restore normal functions.

<Note> This program may malfunction due to problems in communication circuits or interference from electronic appliances nearby.



Settings Value Display In Multiple Display Mode

✱ When there are more than one displays connected, the settings values are displayed as follows.

- No selection: Displays the Factory Default Value.
- Selected one display: Fetches and displays the settings value for the selected display.
- Selected one display (ID1) and add another display (ID3): The program, which was displaying the settings value of ID 1, fetches and displays the value of ID3.
- Selected all sets using Select All: Returns to the Factory Default Value.

MagicInfo Pro

What is MagicInfo Pro?	Using MagicInfo Pro	Library	Screen	Schedule
Remote Management	Message	Option	Client / Contents Server	Troubleshooting

What is MagicInfo Pro?



MagicInfo Pro uses an Ethernet network for servers and monitors, and transfers media files (image files, music files, and movies) and office files (HTML, PDF) from the server to the monitors over the network. Multiple monitors are connected to a server via a network and the server can transfer files to all the monitors at the same time or a single file to a single monitor. There are two ways to transfer files. The first is that the server registers a schedule to the monitors and then transfers files following that schedule. The second is that a monitor searches for the files registered in the library list of the server and receives and plays them. If more than one server is connected, the monitor can select a server and can receive a schedule from it. The monitor has a built-in Internet connection function. The servers and monitors are connected to the network. Each server or monitor has a unique name to identify itself on the network. A server and a monitor can only be connected if they have the same server name. For example, if the name of a server is 'MagicInfo Pro', only the monitors whose server name is 'MagicInfo Pro' can receive schedules from it. If a monitor cannot find a server whose name is the same as the server name configured in it, it waits until a server with that name appears. However, if Auto Connection is enabled, the monitor attempts to connect to other servers and connects to the first server that responds.



Major Functions of MagicInfo Pro

1. Free Screen Design
→ You can configure the screens to be displayed on the monitor by placing and playing multiple areas on them freely and changing the area properties.
2. Content Downloading or Streaming
→ You can select Stream or Download for the transfer mode to play content on the screens and thus play the screens according to your circumstances. The downloaded screens are played on the monitors at the scheduled time even though the monitors are not connected to the server.
3. Library Media File Management and Content Server
→ You can manage the registered content in the library efficiently by creating folders. You can play the content on the screens according to your circumstances by operating the content server in accordance with the network status.
4. Network/Local Schedules and Publishing
→ You can transfer the edited screens to selected monitors by using the publishing feature. You can also transfer screens to the monitors which are not connected to the network by using the local

schedules.

5. Instant message
→ You can display a message on selected monitors regardless of schedules.
6. MDC and System
→ The MDC and System functions allow you to control, view the status of, and diagnose monitors.
7. VNC
→ The VNC function allows you to connect to a monitor remotely and view the status of and control and diagnose it.
8. Update and PXE
→ The Update function allows you to easily update the programs on the monitor. The PXE allows you to recover the operating system image for a monitor.

Using MagicInfo Pro

● Running MagicInfo Pro

1. Click Programs -> MagicInfo Pro -> MagicInfo Pro.
2. When MagicInfo Pro runs, select Log In from the File menu.

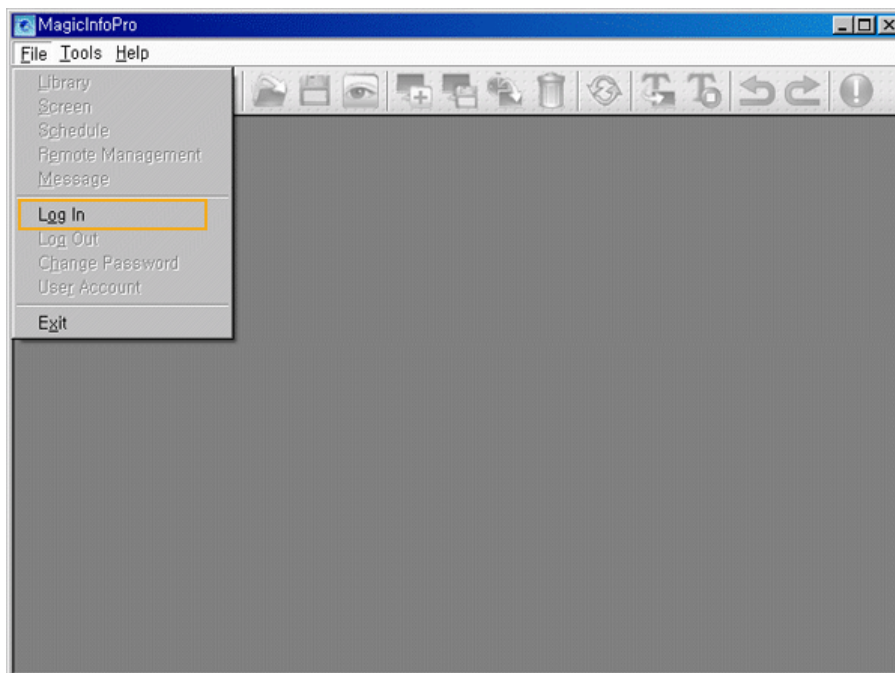

3. Enter the user name and password and click OK.

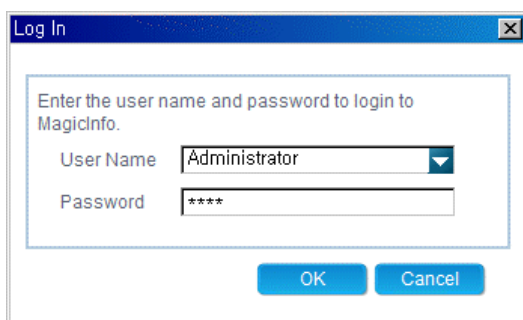

- If you log in for the first time, select 'Administrator' as enter the user name and the password you set when installing the program. (For information on how to install MagicInfo Pro, refer to Installing MagicInfo Pro, Using the Software.)

● Connecting a Monitor to a Server

● Setting Up a Server

1. Click Option from the Tools menu to open the Server Setup window.

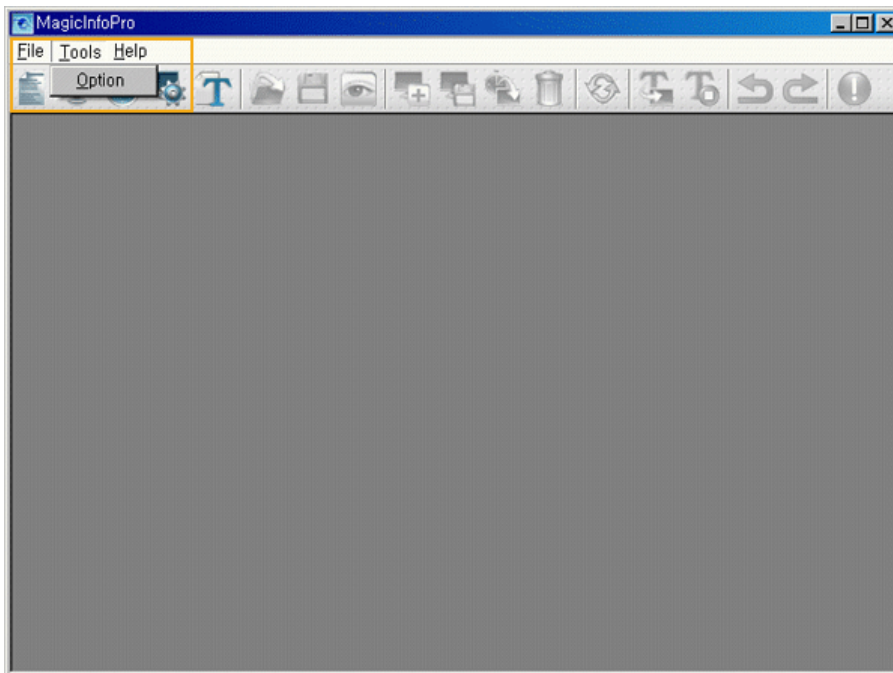

2. Configure the Network Connection settings In the General tab. Enter the server name on the monitor identical to the name of the server. To change the server name, double-click the Value field of the Server Name item.

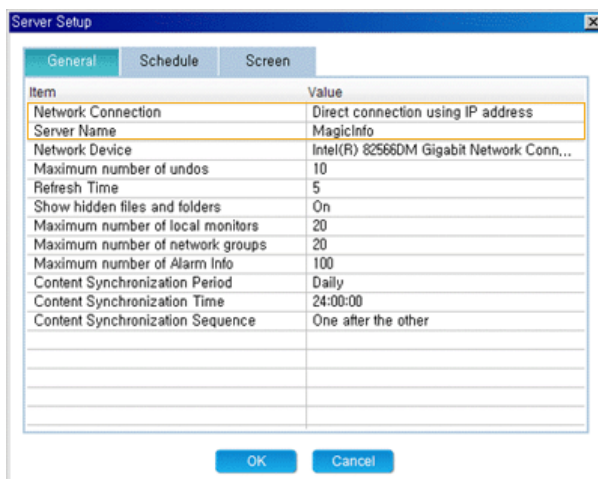

3. If there is more than one network card in the server, select a network card in the Network Device item.
4. If both the server and monitor are on the same network, make sure to select 'Automatic connection using a server name' in the Value field of the Network Connection item as the connection method. When setting up the monitor, make sure to use the same settings.
5. If the server and monitor are on different networks, make sure to select 'Direct connection using an IP address' in the Value field of the Network Connection item as the connection method. When setting up the monitor, make sure to use the same settings.

At this time, the IP address of the server which the monitor will connect to must be a public IP address. Make sure to enter this IP address in the Server IP Address item when setting up the monitor.

If the server is using a firewall, make sure to include the IP address of the monitor in the exceptions list for the firewall.

Setting up the Monitor

1. Set the source of the monitor to MagicInfo Pro and then enter the IP address and server name using the Setup menu or the Network Connection item. They must be the same as the IP address and the name of the server to connect to. (For more information, refer to the description of setting up

MagicInfo in the OSD pages.)

2. A message is displayed to notify that the monitor is successfully connected to the server.

● File Sub-Menus

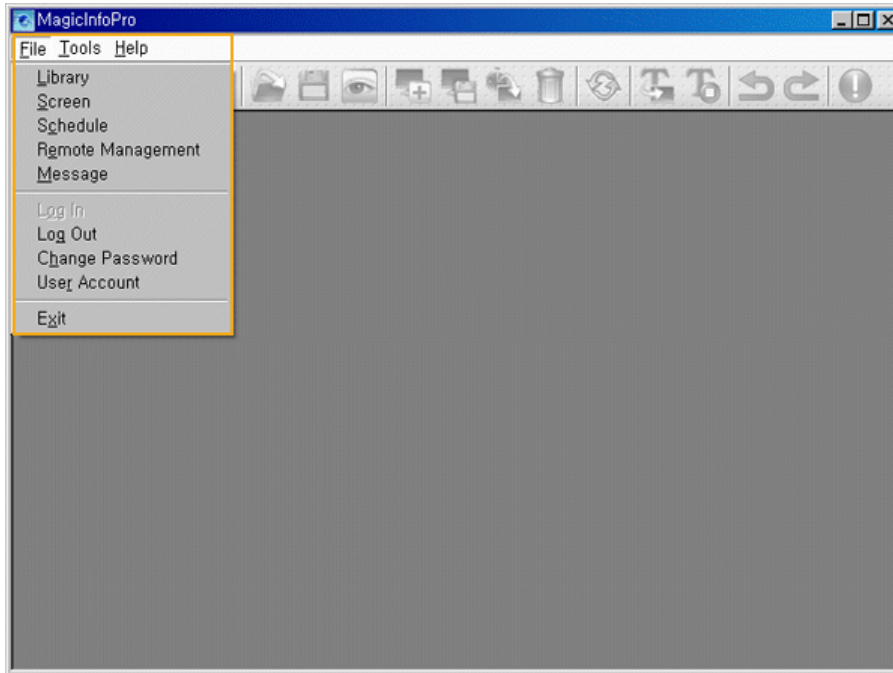

● Registering a Library

1. Select Library from the File menu to open the Library View.
2. Select a photo file, music file, movie file, document, or Flash file etc. on the server.
3. Right-click on the selected file and select Send To Library from the displayed menu to register it to the library.

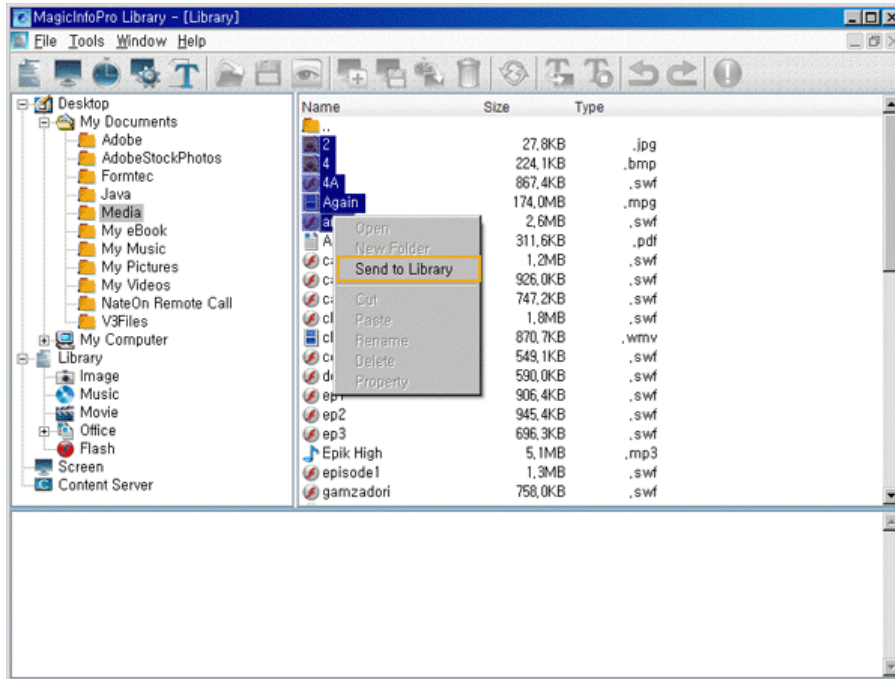

4. The registered library files are used by the monitor when the Operating Mode of the monitor is set to Player or is used when registering a screen.

● Registering a Screen

1. Select Screen from the File menu to open a Screen View.
2. Right-click on the background view. Click on the Area and click either Photo, Movie, Flash, Web, Text, or Source from the displayed menu.

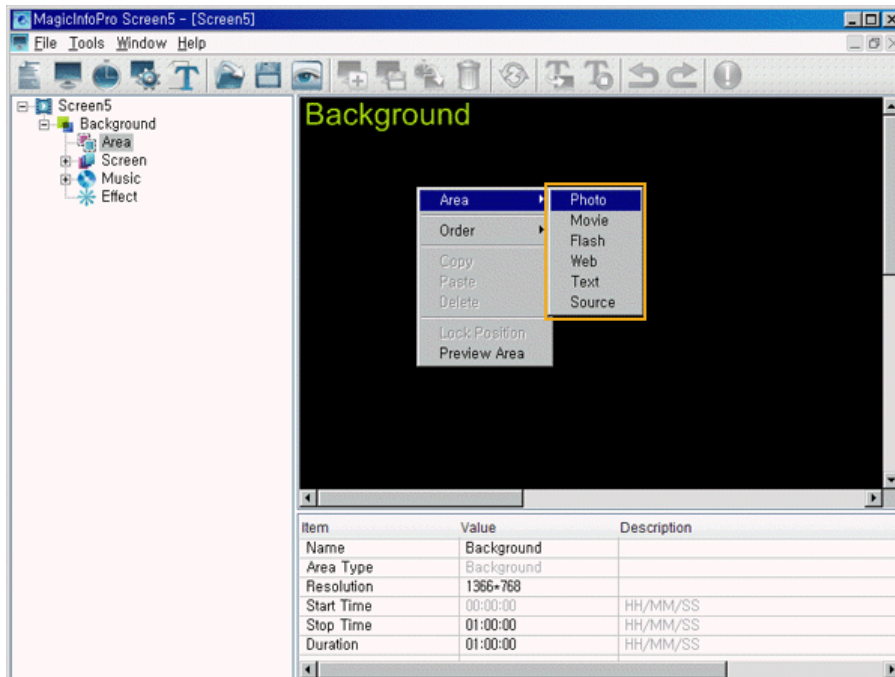

3. When the mouse pointer changes to the crosshair (+) icon, drag it to the Edit View to set the area for the file to be displayed.
4. When an area is set, tree items are added to the Tree View in the same order as shown under the Background item. The added tree items differ depending on the file type selected in step 2. You can select a file by selecting a screen item and then selecting an item below the Background item.

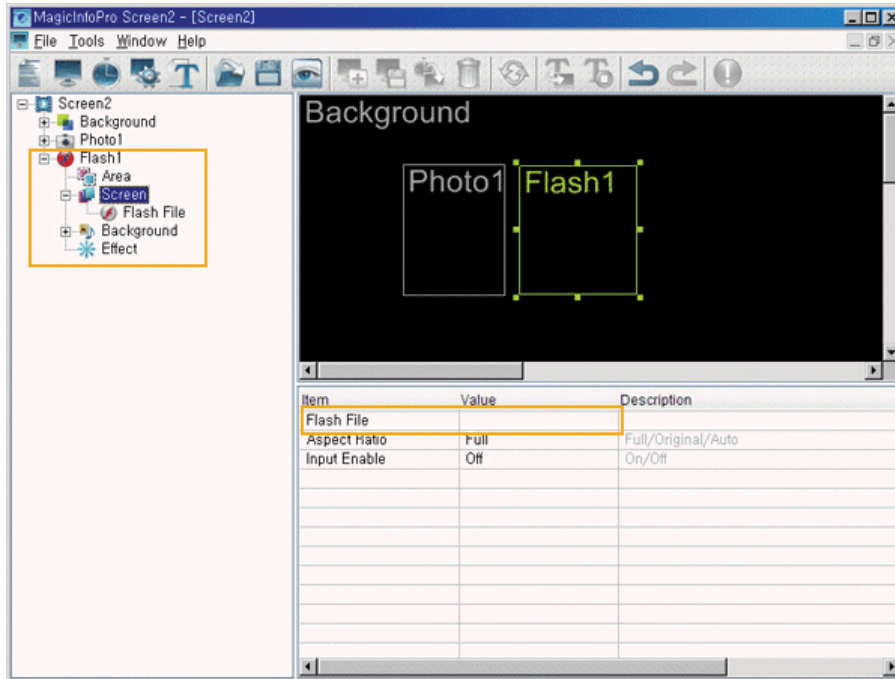

5. Repeat steps 2 to 4 to register other areas on a screen.
6. After finishing registering areas, select Save from the File menu to save the screen.
7. Register a schedule to display the saved screen on a monitor(s).

● Registering a Schedule

1. Select Schedule from the File menu to open the Schedule View.
2. Select the monitors to which the schedule is to be registered in the Tree View at the left. The Operating Mode of the selected monitors must be set to Schedule if they can display the schedule registered on the server.

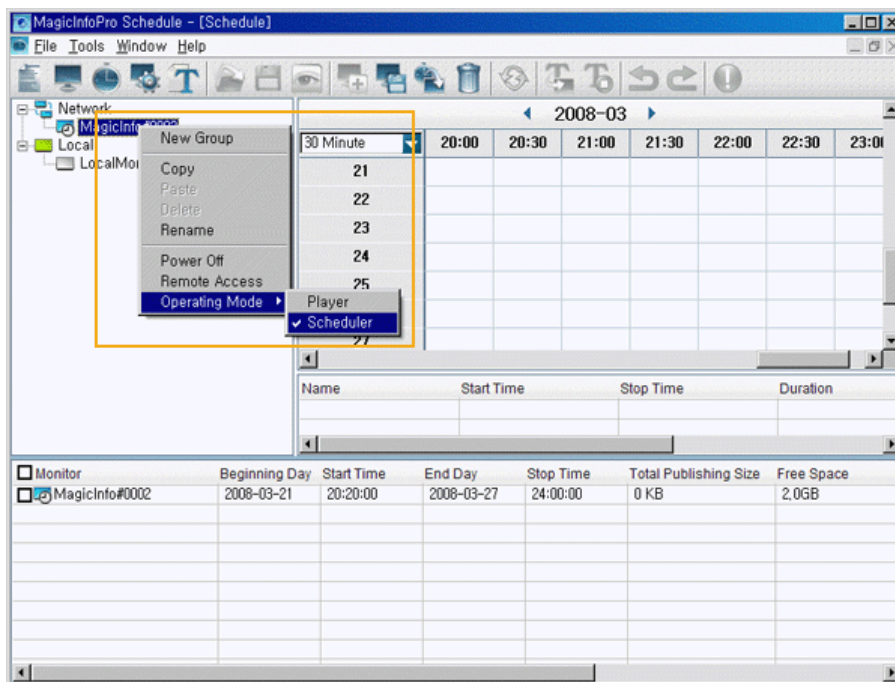

3. Click a date and time in the Edit View at the right to select the date and time when the schedule is to be performed. Right-click the Edit View and select Add from the displayed menu. At this time, you can only select the schedules for the screens you saved using the Screen menu.

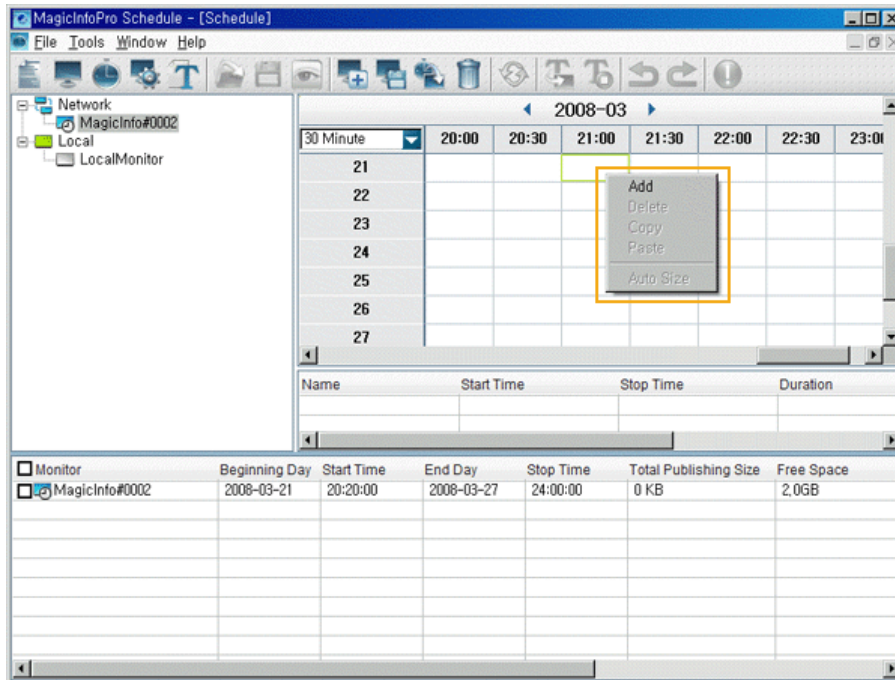

4. If you want to change the date or time of the schedule, drag it to a different date or time.
5. Select Publish from the Tools menu. Select the checkbox next to the monitors for which you want to register the selected schedule.

● Sending a Message

1. Select Message from the File menu to open the Message View.
2. Select the checkbox next to the monitors for which you want to register a message.
3. Configure the settings for the message in the List View at the bottom right. The text you enter here will be displayed on the selected monitors.

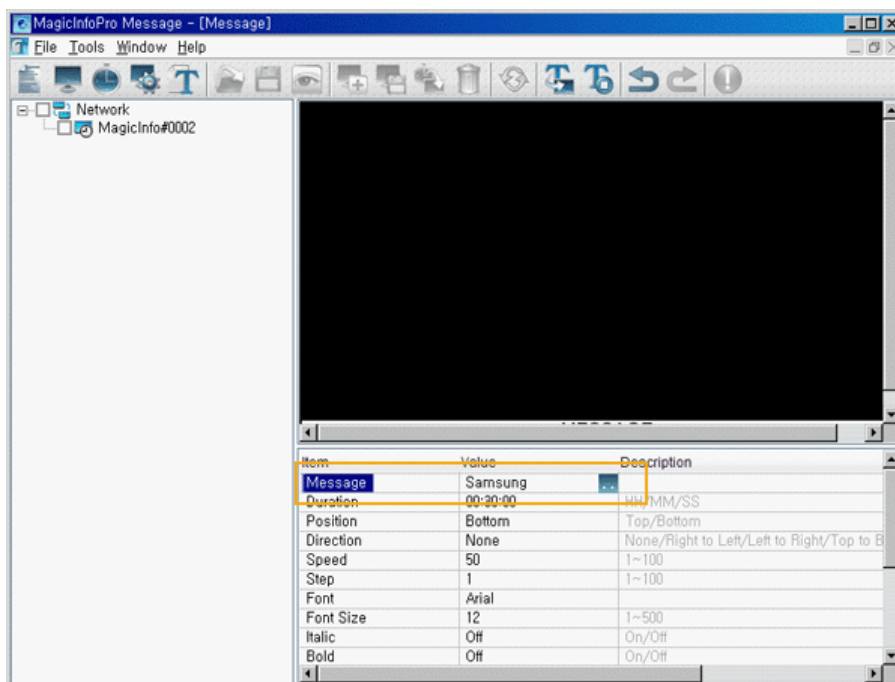

4. To display the message on the selected monitors, click the Send Message icon in the toolbar under the menu bar.
To hide the message which will be displayed on the selected monitors, click the Stop Message icon in the toolbar.

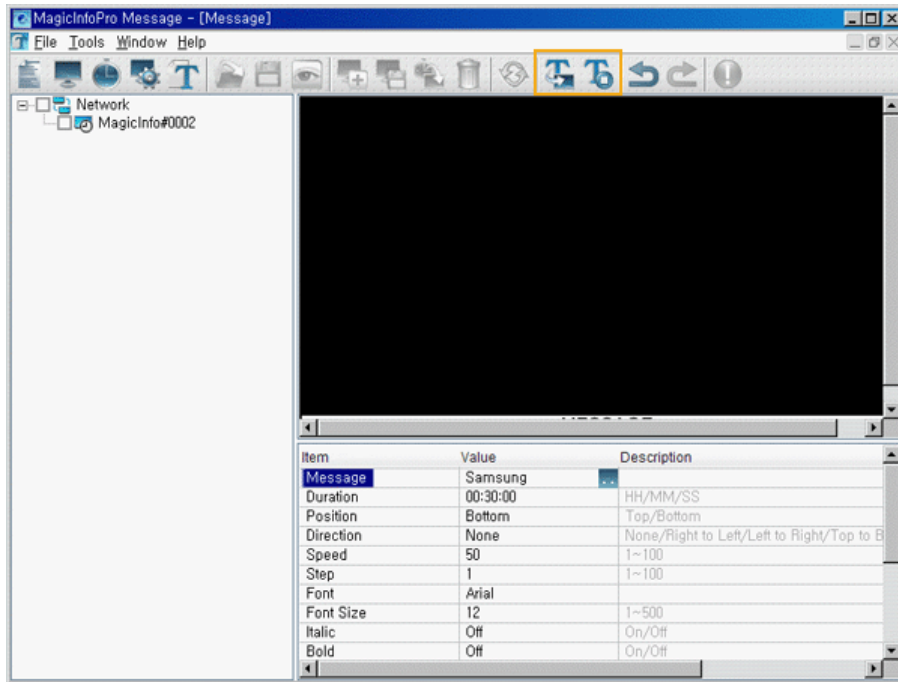

 Library

 File Menu

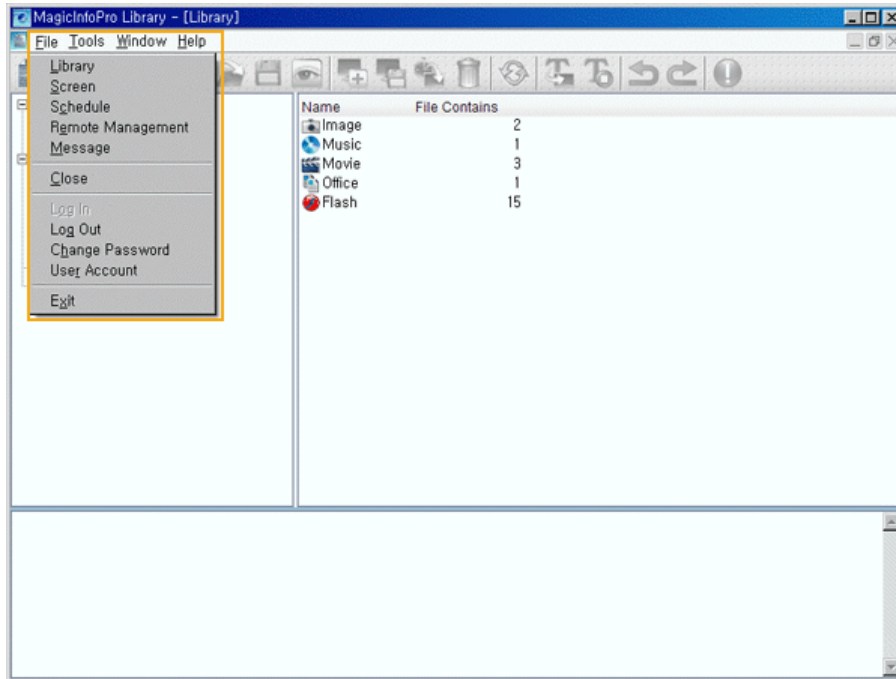

 **Library / Screen / Schedule / Remote Management / Message**

- Creates a view or selects a created view for each menu item so that you can perform a screen schedule and have basic control over the monitors from the server.

 **Close**

- Closes the screen view you are working in. If there are unsaved changes, a new window is displayed so that you can save them.

 **Log In**

- You must log onto the server before you can use any one of its functions. You can log onto the server to run a server program. The password you enter when installing MagicInfo Pro becomes the password of the Administrator account by default.

 **Log Out**

- Once you are logged onto the server, you can log out. If you log out from the server, all created views are closed and if there are any unsaved changes, a new window is displayed so that you can save them.

 **Change Password**

- Changes the password of the currently logged-in account.

 **User Account**

- Creates, deletes and changes the user accounts that can log onto the server. There are two types of accounts that can be created: Administrator and User Accounts.
 - Administrator : Has privileges for all server functions.
 - User : Has privileges for all functions except for changing the server options and user account features.

 **Exit**

- Exits the program. If there are any unsaved changes, a new window is displayed in which you can save the changes.

Tools Menu

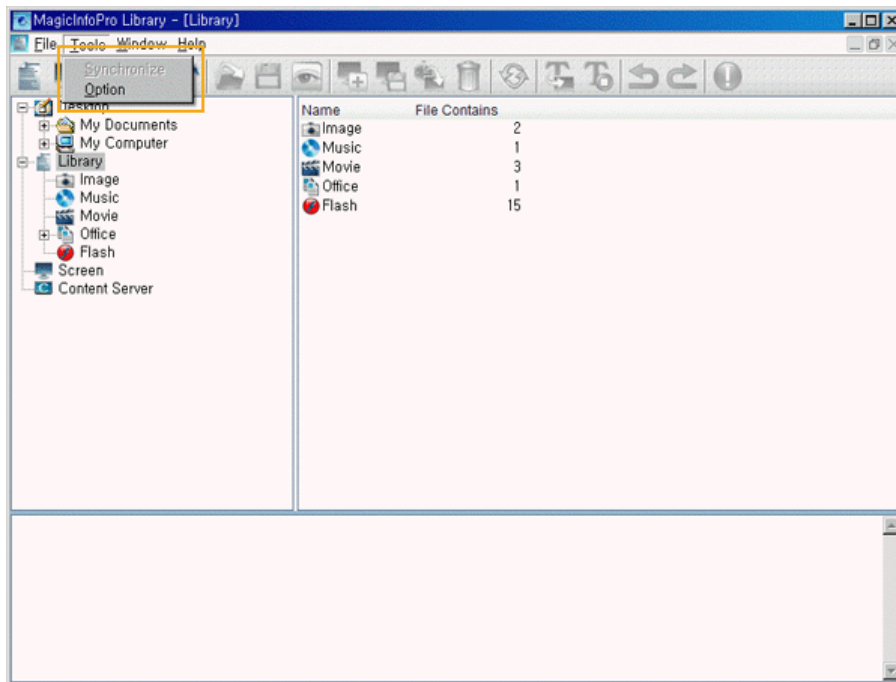

- **Synchronize**
 - Synchronizes the library files of the main server with the files of the content server.
- **Option**
 - Changes the server settings. For more information, refer to the Options section.

Library

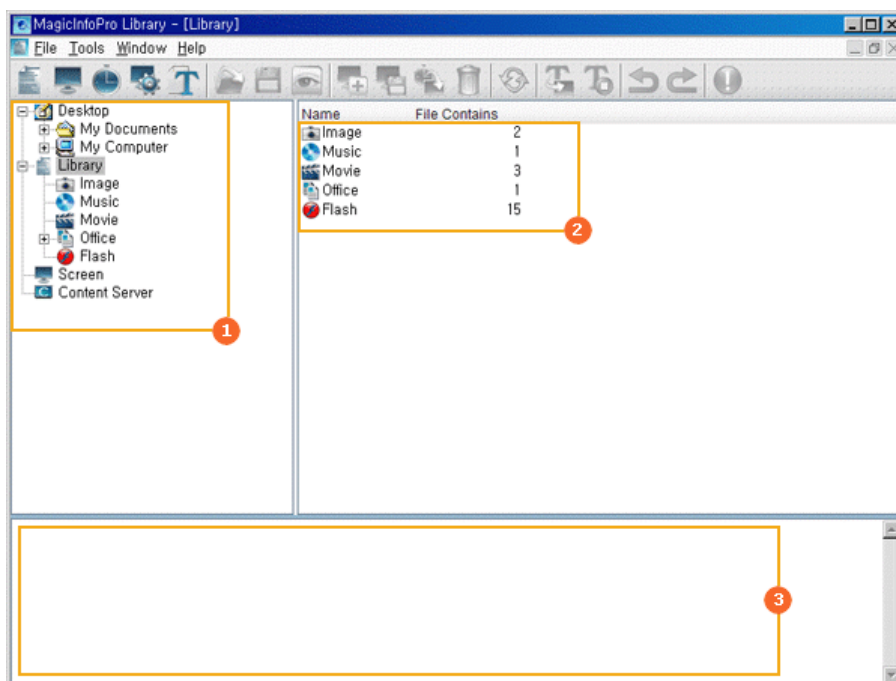

- 1 Tree View
- 2 List View
- 3 Output View

● Tree View

All the folders under My Computer on the Windows Desktop, library, screen, and content server are displayed in a tree view. If you select a folder, its subfolders and a list of files in it are displayed in the list view in the right pane.

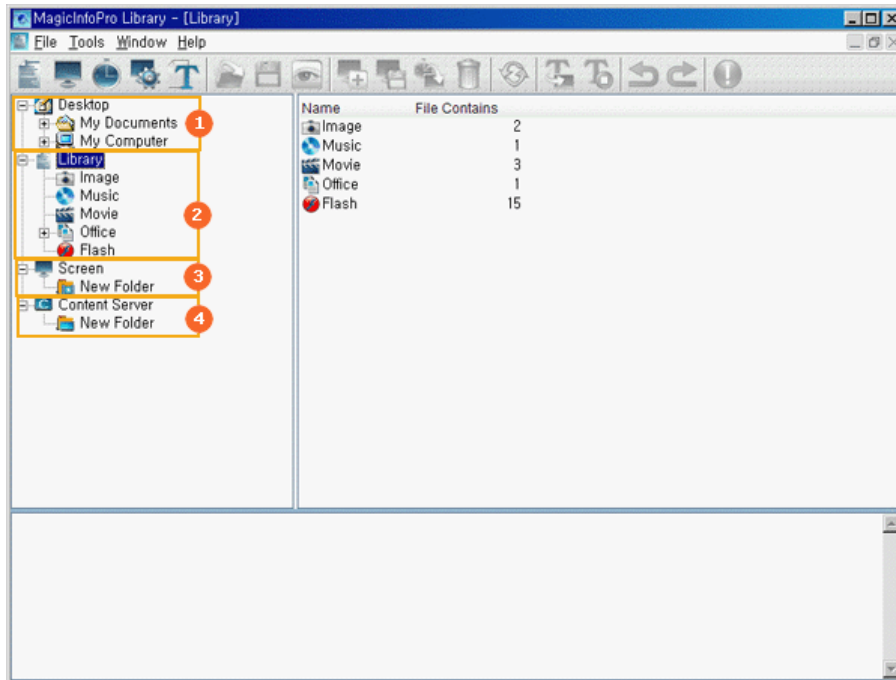

- 1 Exploring Normal Files
- 2 Exploring Libraries
- 3 Exploring Screen Files
- 4 Exploring Content Servers

● Exploring Normal Files

- Displays all the folders in the computer on which a server is installed in a tree view.
- Function: If you select a folder below the Desktop, its subfolders and the files that you can register to a library are displayed in the list view in the right pane.

● Exploring Libraries

- Displays all the folders which are created in the libraries in a tree view.
- Function:
 - If you select a folder, its subfolders and a list of library files are displayed in the list view in the right pane.
 - Hot Key
 - F2 key: Renames the selected folder.
 - Delete key: Deletes the selected folder, its subfolder(s), and all the files in the selected folder.
 - Drag & Drop
 - Desktop File: If you drag and drop a file from the list view to a library, a check is performed whether it can be registered to that library and if possible it is registered.
 - Library File: If you drag and drop a file from the list view into a library, it is moved to the library if the content types of both the file and library are the same.

● Exploring Screen Files

- Displays the screen management folders created with the Screen menu in a tree view.
- Function:
 - └─ Displays the subfolders and screen files below the selected folder in the list window on the right by selecting a folder.
 - └─ Hot Key
 - F2 key: Renames the selected folder.
 - Delete key: Deletes the selected folder, its sub folder(s) and all the files in the selected folder and subfolders.
 - └─ Drag & Drop
 - Screen File: If you drag and drop screen files in the list view, they are moved to that folder.

● Exploring Content Servers

- Displays the management folders for the content servers in a tree view.
- Function:
 - └─ If you select a folder, its subfolders and a list of content servers are displayed in the list view in the right pane.
 - └─ Hot Key
 - F2 key: Renames the selected folder.
 - Delete key: Deletes selected folder, its sub folder(s) and all the files under the selected folder and its subfolder.
 - └─ Drag & Drop
 - Contents Server: If you drag and drop the content servers onto a content server folder in the tree view, they are moved to that folder.



● List View

Displays all the folders and files or content servers under a folder selected in the tree window as a list. You can drag and drop items, use shortcut keys, and move, delete, and rename an item using the provided context menu.

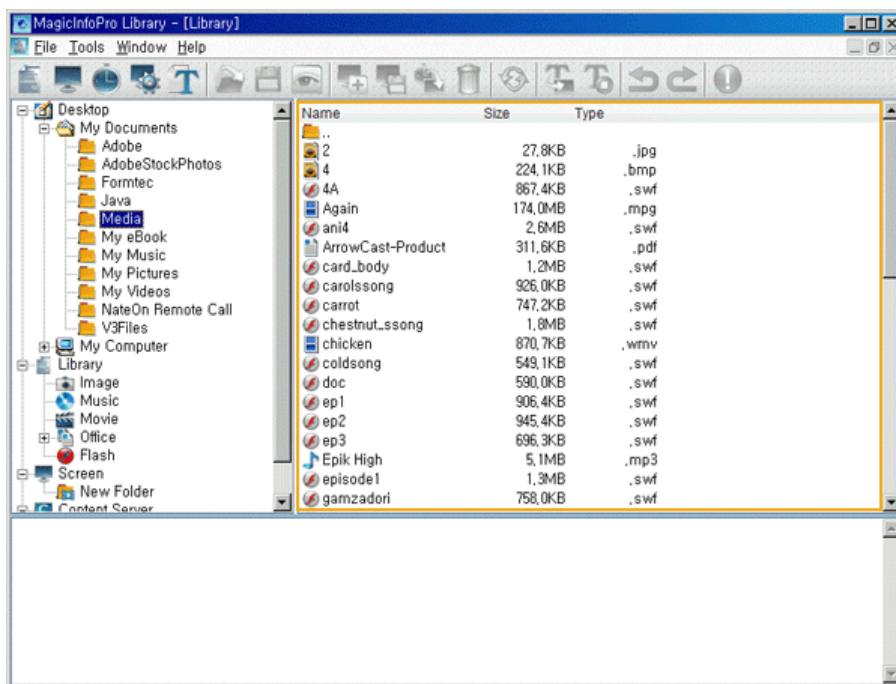
● Exploring Normal Files



- Displays the subfolders and files under the selected folder.
- Function:
 - └─ Double-Click

- Double-click  to move to the upper folder.
- Double-click  to move to the lower folder.
- Double-click a file to run the file.

Drag & Drop

- If you drag and drop a file from the list view into a library, it is registered to that library. However, the drag & drop function is not supported for folders.

Context Menu

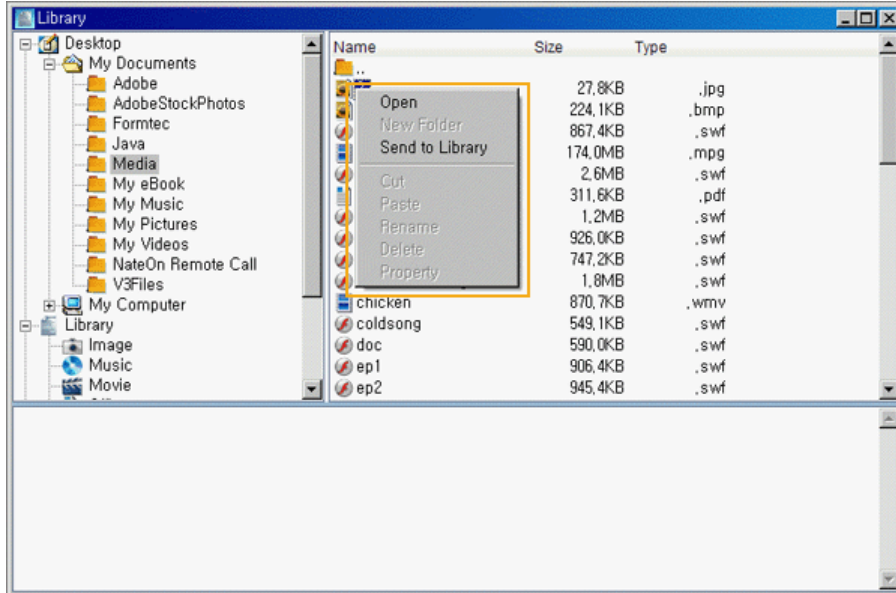

- Open: If you click Open for a folder, you are moved to that folder. If you click Open for a file, the file is run.
- Send To Library: If you click Send To Library for the selected files, they are registered to the library.

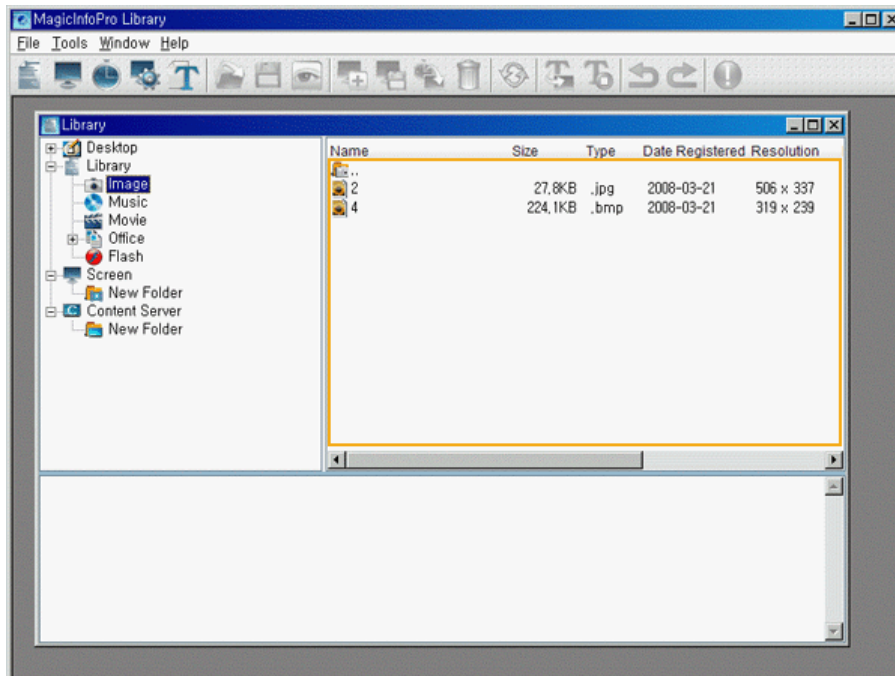

Exploring Libraries



- Displays the subfolders and files under the selected folder.

Function:

Double-Click

- Double-click  to move to the upper folder.
- Double-click  to move to the lower folder.
- Double-click a file to run the file.

Drag & Drop

Drag & Drop

- If you drag and drop library files into a library folder in the tree view or list view, they are moved to that folder if the content types of both the library files and the library folder are the same. However, the drag & drop function is not supported for folders.

Context Menu

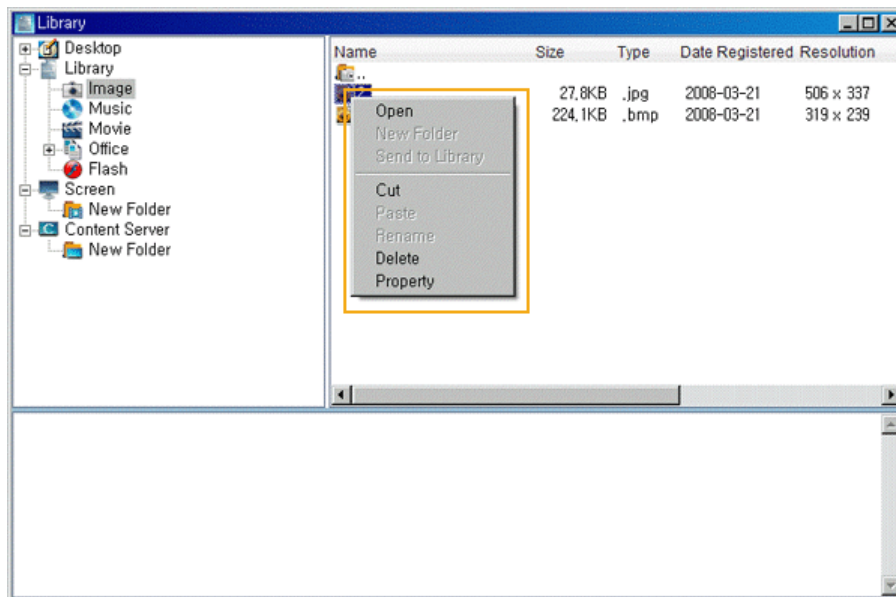

- Open: If you click Open for a folder, you are moved to that folder. If you click Open for a file, the file is run.
- Send To Library: Moves the selected library files to the topmost folder for each content item. However, this menu item is deactivated when a folder is selected.
- Cut: Cuts the selected screen files to the clipboard so that you can paste them to another location. However, this menu item is deactivated when a folder is selected.
- Paste: Pastes the files cut to the clipboard to the selected location. However, this menu item is deactivated when the folder selected in the tree view is a Library or Office folder.
- Rename: Renames the selected folder. However, this menu item is deactivated when a library or office folder is selected in the tree view. This menu item is not supported for library files.
- Delete: Deletes the selected folders and library files. However, this menu item is deactivated when a library or office folder is selected in the tree view and the selection includes ".." which refers to a higher level folder.
- Property: Displays detailed information for the selected library file. You can add a comment to it.

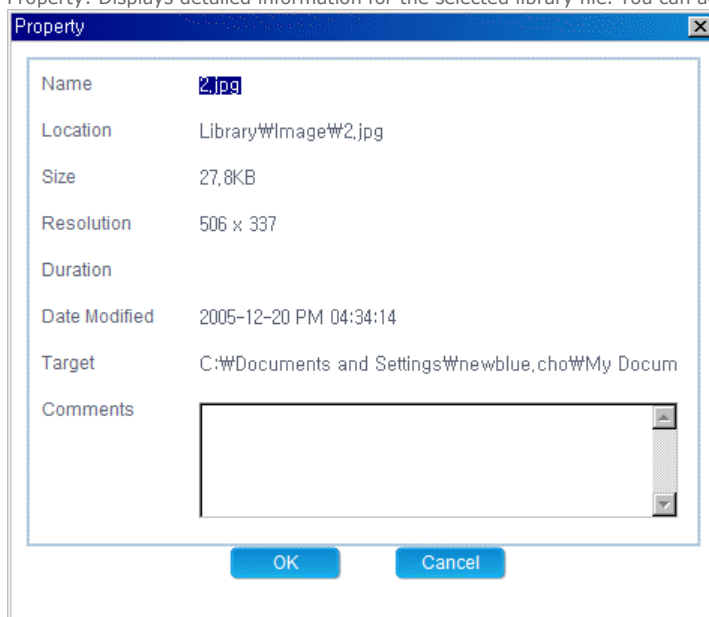

- Name: Name of the selected file
- Location: Location where the selected file is registered
- Size : Size of the selected file
- Resolution : The resolution of the selected file
- Duration : The playing time of the selected file
- Date Modified : The date when the selected file was last modified
- Target : The real location of the selected file.

- Comments : Comments entered by the user for the selected library file. You can edit them.

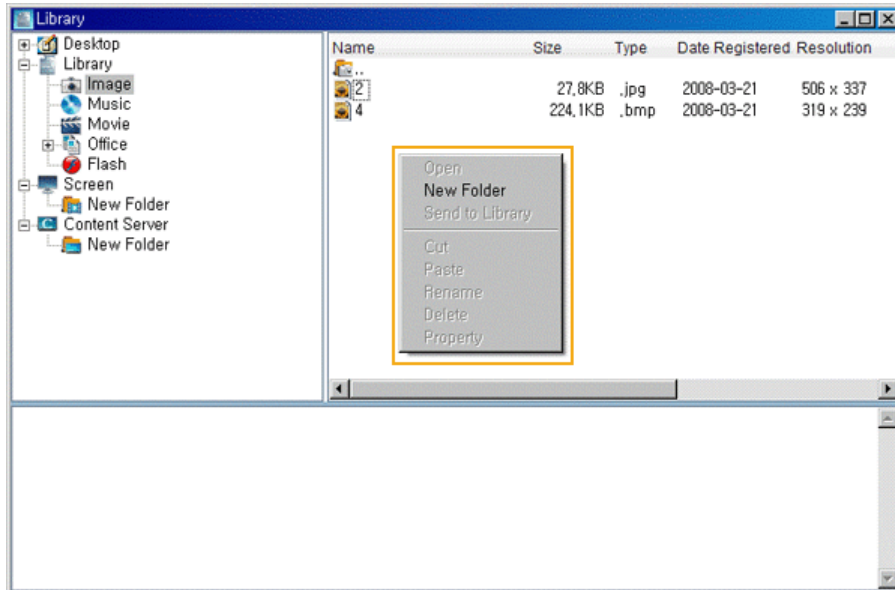

- New Folder: This menu item is only activated when neither a folder nor a file is selected. If you select this menu item, a new folder is created. However, it is deactivated when a library or office folder is selected in the tree view.

Hot Key

- F2 key: Renames the selected folder. However, you cannot rename a file.
- Delete key: Deletes the selected folders, subfolders, and library files.
- Ctrl + X keys: Cuts the selected library files to the clipboard so that you can paste them to other location. However, this hot key is not supported for folders.
- Ctrl + V keys: Pastes the library files cut to the clipboard to the selected location. However, you cannot paste them when a library or office folder is selected in the tree view.

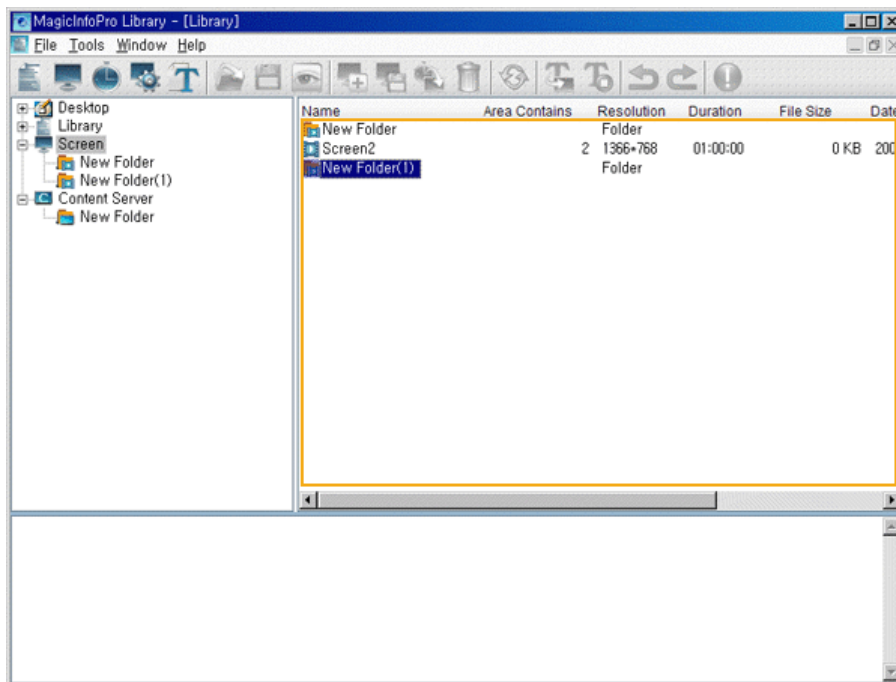

Exploring Screen



- Displays the subfolders and files under the selected folder.

Function:

Double-Click

- Double-click  to move to the upper folder.
- Double-click  to move to that lower folder.

Drag & Drop

- If you drag and drop screen files to a screen folder in the tree view or the list view, they are moved to that folder. However, the drag & drop function is not supported for folders.

Context Menu

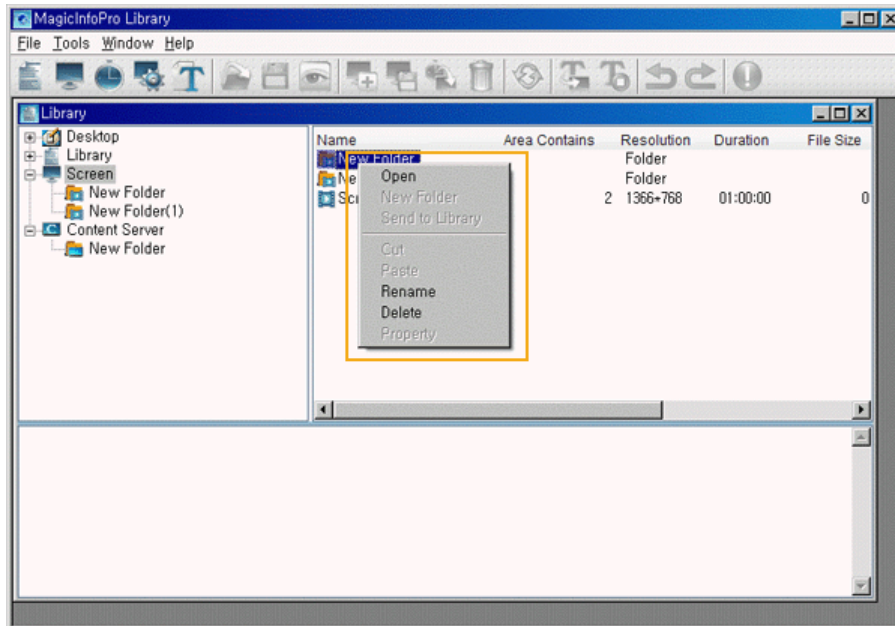

- Open: If you click Open for a folder, you are moved to that folder. However, this menu item is deactivated when a screen file is selected.
- Rename: Renames the selected folder. However, this menu item is not supported for a screen file.
- Delete: Deletes the selected screen files and folders. However, if the selection includes ".." which refers to a higher level folder, this menu item is deactivated.

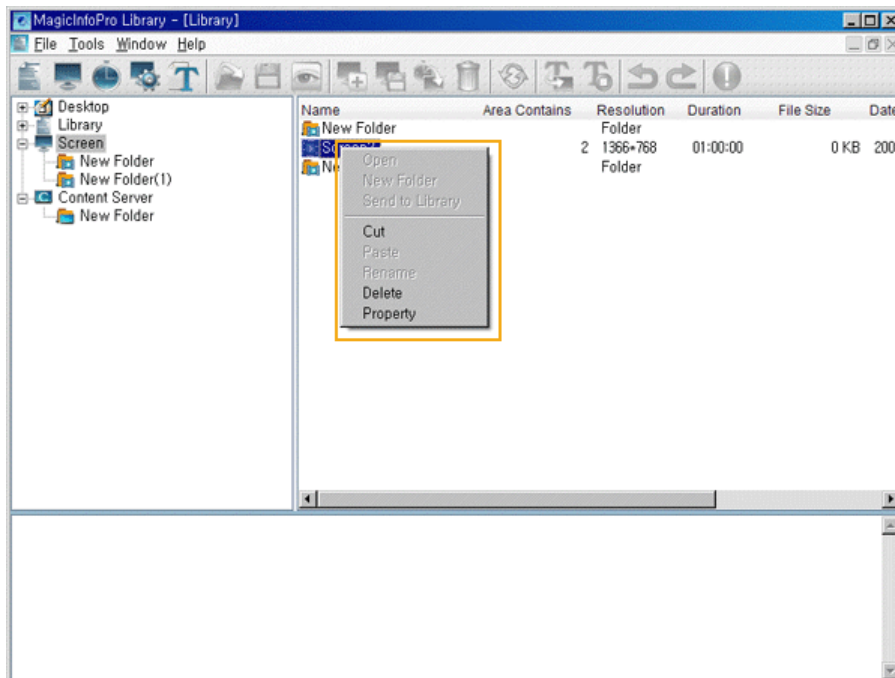

- Cut: Cuts the selected screen files to the clipboard so that you can paste them to another location. However, this menu item is deactivated when a folder is selected.
- Delete: Deletes the selected screen files and folders. However, if the selection includes ".." which refers to a higher level folder, this menu item is deactivated.
- Property: Displays detailed information for the selected screen file. You can enter a comment on it.

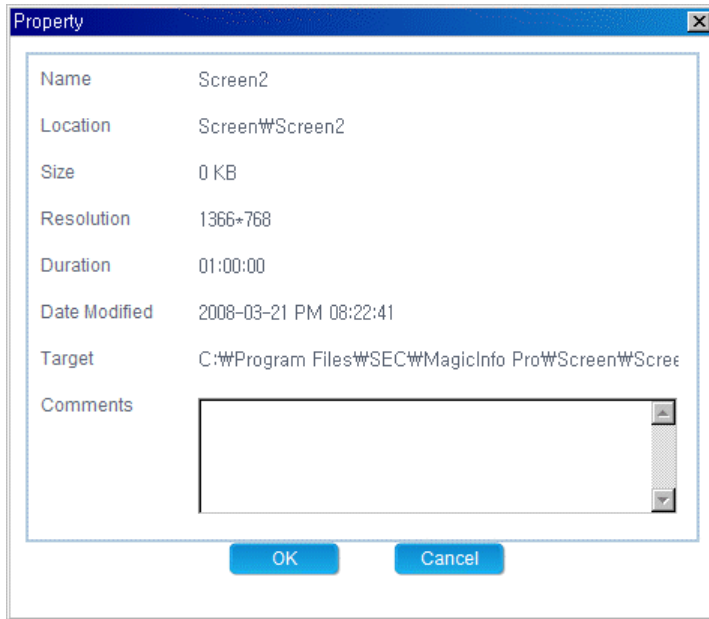

- Name: The name of the selected screen
- Location : The location where the selected screen is registered
- Size : The size of the selected screen
- Resolution : The resolution of the selected screen
- Duration : The playing time of the selected screen
- Date Modified : The date when the selected screen was last modified
- Target : The real location of the selected screen.
- Comments : Comments entered by the user for the selected screen. You can edit them.

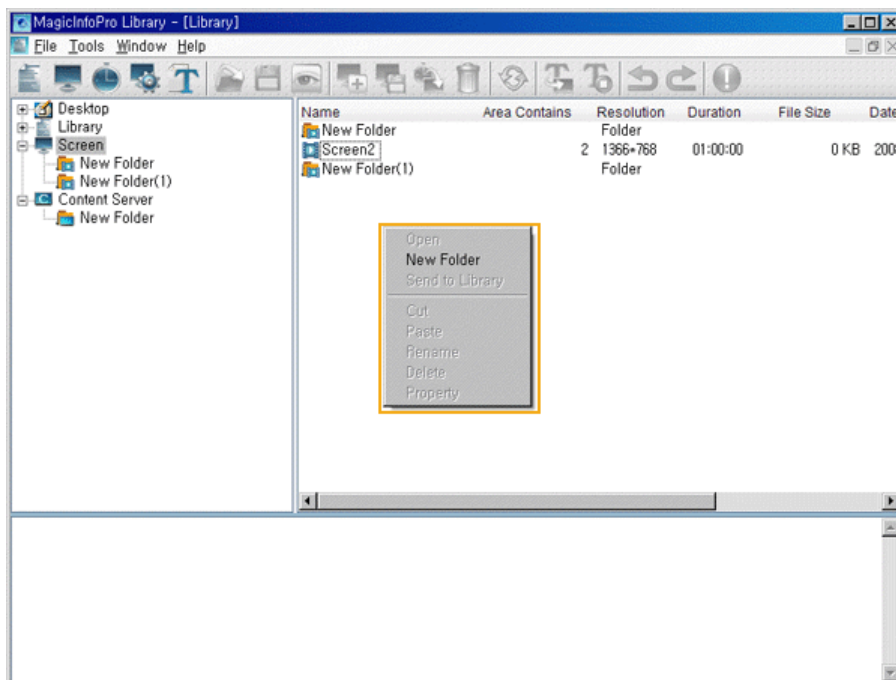



- New Folder: This is only activated when neither a folder nor a file is selected. If you select this menu item, a new folder is created in the selected location.

Hot Key

- F2 key: Renames the selected folder. However, you cannot rename a file.
- Delete key: Deletes the selected folders, subfolders, and screen files.
- Ctrl + X keys: Cuts the selected screen files to the clipboard so that you can paste them to another location. However, this hot key is not supported for a folder.
- Ctrl + V keys: Pastes the screen files cut to the clipboard to the selected location.

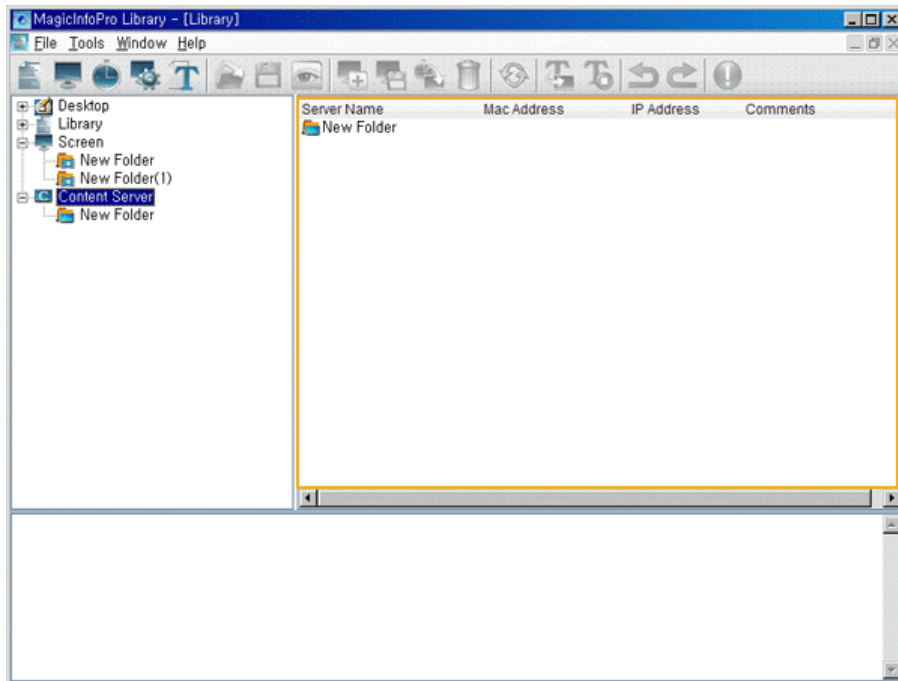
Exploring the Content Server



- Displays the subfolders and content servers below the selected folder.
- Function:
 - └ Double-Click
 - Double-click  to move to the upper folder.
 - Double-click  to move to the lower folder.
 - └ Drag & Drop
 - If you drag and drop content servers to a content server folder in the tree view or the list view, they are moved to that folder. However, the drag & drop function is not supported for folders.

Context Menu

- Open: If you click Open for a folder, you are moved to that folder. However, this menu item is deactivated when a content server is selected.
- New Server: Only activated when no folder or file is selected. You can enter the MAC address, server name, and comments for a new server using this menu item.

- Mac Address: The MAC address of the newly created content server
- Server Name: The name of the newly created content server
- Comments: Comments about the newly created content server
- New Folder: This is only activated when neither a folder nor a file is selected. If you select this menu item, a new folder is created in the selected location.
- Cut: Cuts the selected content servers to the clipboard so that you can paste them to another location. However, this menu item is deactivated when a folder is selected.
- Paste: Pastes the content servers cut to the clipboard to the selected location.
- Rename: Renames the selected folder. However, for a content server, you can only rename it using the Properties window.
- Delete: Deletes the selected content servers and folders. However, if the selection includes ".." which refers to a higher level folder, this menu item is deactivated.
- Property: Allows you to edit the MAC address, server name, and comments for the selected content server.

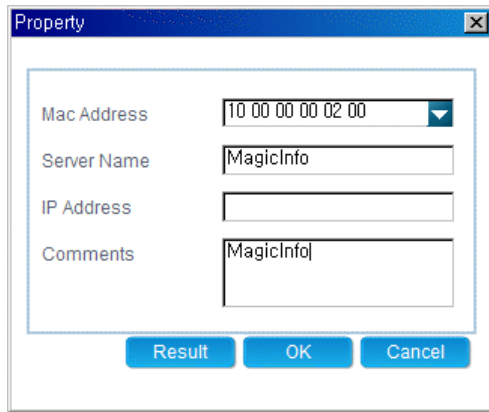





- 1) Mac Address: The MAC address of the selected content server. You can edit this.
- 2) Server Name: The server name of the selected content server. You can edit this.
- 3) IP Address: The IP address of the selected content server. You cannot edit this.
- * The IP address is displayed if the content server is connected at least once.
- 4) Comments: Comments about the selected content server.
- 5) History : Displays the synchronization history records for the content server.

Hot Key

- F2 key: Renames the selected folder. However, you cannot rename a file.
- Delete key: Deletes the selected folders, subfolders, and content servers.
- Ctrl + X keys: Cuts the selected content servers to the clipboard so that you can paste them to another location. However, this hot key is not supported for folders.
- Ctrl + V keys: Pastes the content servers cut to the clipboard to the selected location.

Content Server Status

-  This icon is displayed when the content server is connected.
-  This icon is displayed when the content server is synchronizing.
-  This icon is displayed when the content server fails to synchronize.
-  This icon is displayed when the content server is not connected.

Output View

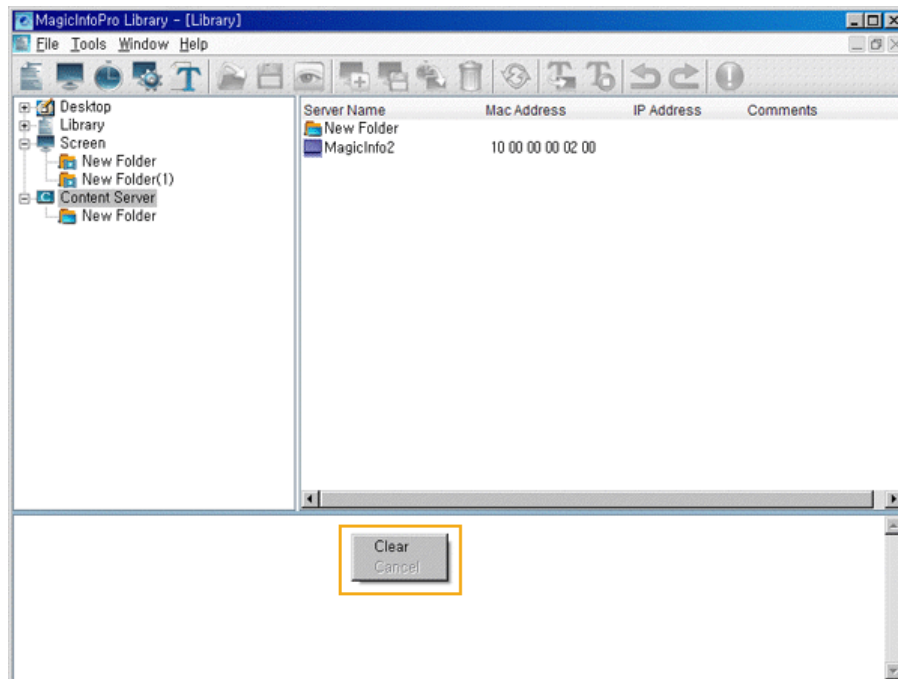

- Displays the progress and results of adding and deleting libraries. You can cancel an addition or deletion command using this view.
- Context Menu
 - Clear: Clears all library progress and result messages.
 - Cancel: You can select and cancel a library addition or deletion command which has not yet been completed.

● Hot Key

- Ctrl + C: Copies the selected message to the clipboard so that you can paste it to another location.



File Menu

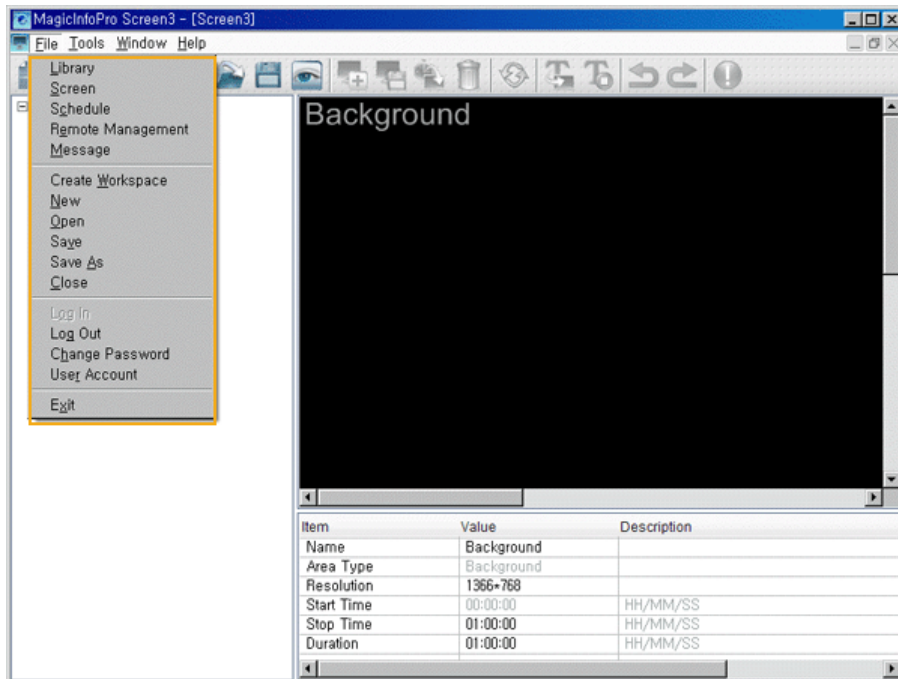

- Library / Screen / Schedule / Remote Management / Message
 - Creates a view or selects a created view for each menu item so that you can perform a screen schedule and performs basic control for the monitors from the server.
- Create Workspace
 - Creates a new screen view to design more than one screen view. You can only create one view for other types of views except for the screen view.
- New
 - Initializes the screen view you are currently working with. If there are any unsaved changes, a new window is displayed so that you can save them.
- Open
 - Opens a screen file. If there are any unsaved changes, a new window is displayed so that you can save them.
- Save / Save As
 - Saves the changes in the current screen file or as a new screen file.
- Close
 - Closes the screen view you are working with. If there are any unsaved changes, a new window is displayed so that you can save them.
- Log In
 - You must log in to the server before you can use any one of its functions. You can log in to the server to perform a server program. The password you enter when installing MagicInfo Pro becomes the password of the Administrator account by default.
- Log Out
 - Once you are logged into the server, you can log out. If you log out from the server, all created views are closed and if there are any unsaved changes, a new window is displayed so that you can save them.
- Change Password
 - Changes the password for the currently logged-in account.
- User Account
 - Creates, deletes and changes the user accounts able to log into the server. There are two types of

accounts that can be created: Administrator and User Accounts

- Administrator: Has privileges for all server functions.
- User: Has privileges for all server functions except for changing server options and user account features.

● Exit

- Exits the program. If there are any unsaved changes, a new window is displayed so that you can save them.

● Tool Menu

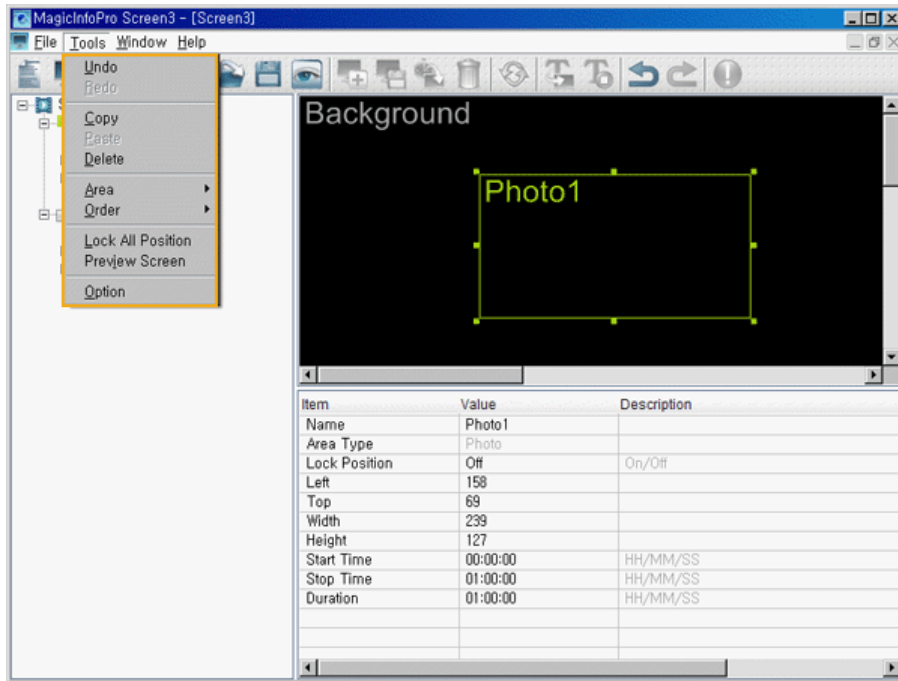

● Undo / Redo

- Cancels the previously performed command or performs the canceled command again. You can change the maximum number of commands that you can undo using the Options menu.

● Copy / Paste / Delete

- Copies, pastes, and deletes the currently selected area.

● Area

- Select the type of area you want to create. You can create an area by dragging and dropping it into the Screen Edit window.
 - More than one Source Area cannot be played at the same time. Therefore, if the playing time of a source area overlaps, the source area whose playing time ends later is played. (You can add areas for photo, movie, Flash, web, text, and source.)

● Order

- Changes the order of the currently selected area.
 - The source area is always at the topmost position. (Bring to Front, Send to Back, Bring Forward, Send Backward)

● Lock All Position

- Locks the position for all created areas. Once an area is locked, you cannot change its position and size using your mouse.

● Preview Screen

- Previews the current state. A separate preview window is displayed. To close the preview window, double-click on it or press the ESC key.
 - You cannot preview the office files for the source and background.

● Option

- Changes the server settings. For more information, refer to the Options section.

Screen

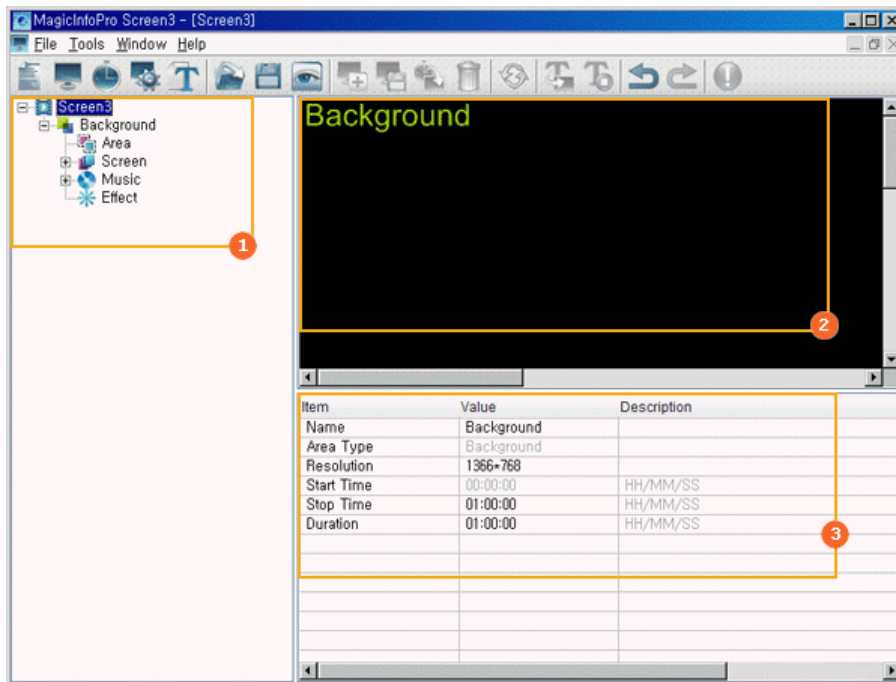

- 1 Tree View
- 2 Edit View
- 3 List View

Tree View

A tree is created in accordance with the order of the areas created in the Edit View. You can check the area currently selected in the Edit View using the Tree View. If you select a property of an area, the detailed property information is displayed in the List View.



Context Menu

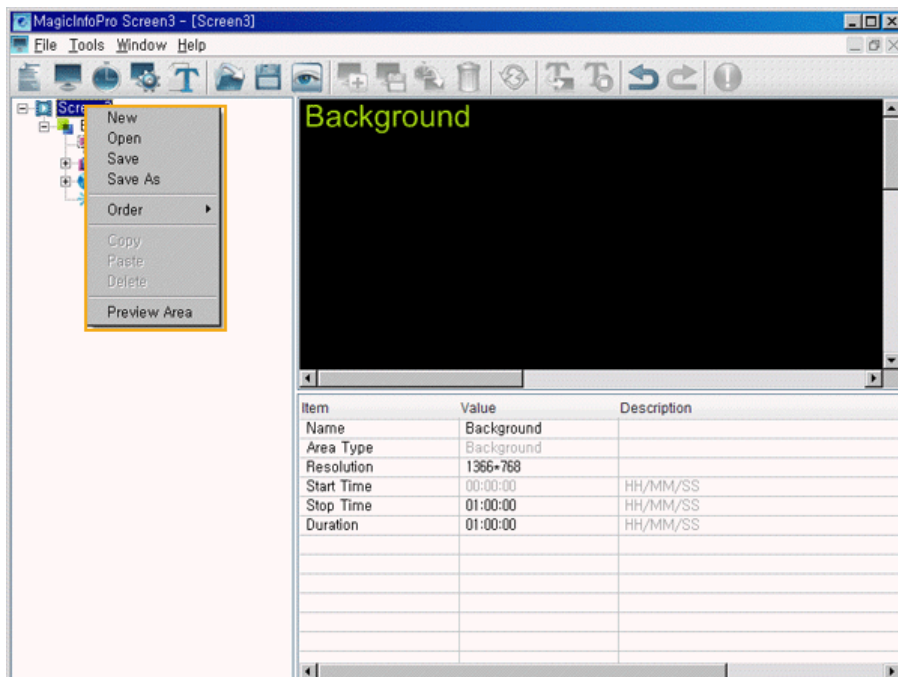

- New: Initializes the screen view you are currently working with. If there are any unsaved changes, a new window is displayed so that you can save them.
- Open: Opens a screen file. If there are any unsaved changes, a new window is displayed so that you can save them.
- Save / Save As: Saves the changes in the current screen file or as a new screen file.
- Order: Changes the order of the currently selected area.
 - + The source area is always at the topmost position. (Bring to Front, Send to Back, Bring Forward, Send Backward)
- Copy / Paste / Delete: Copies, pastes, and deletes the currently selected area.
- Preview Area: Previews the current state of the currently selected area.
 - + You cannot preview the office files for the source and background.

● Background

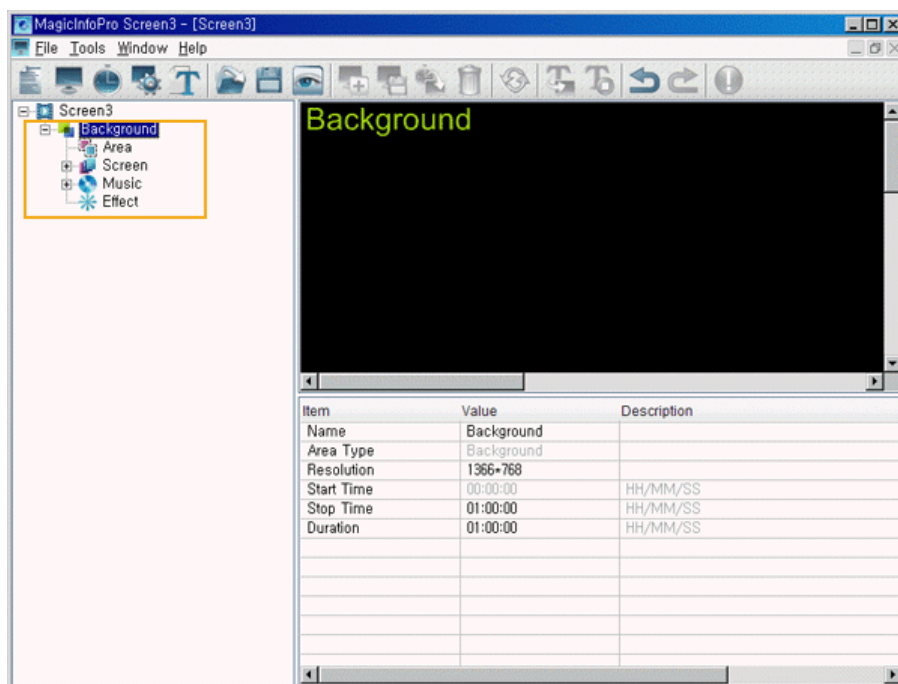

This is for configuring the background for all screens. The background consists of the Area, Screen, Music, and Effect functions. If a color or photo is used as the background, you can freely place other areas such as a movie and text on the background to compose a varied screen. If an office file or an external input is used as the background, you cannot place other areas on the background and will need to compose screens with the background only. The Area function allows you to set the size of the background and the total period of time that all screens are played. The Screen function allows you to set the background content you want to use. The Music function allows you to set the background music. The Effect function allows you to set the effect used when the background changes.

● Area

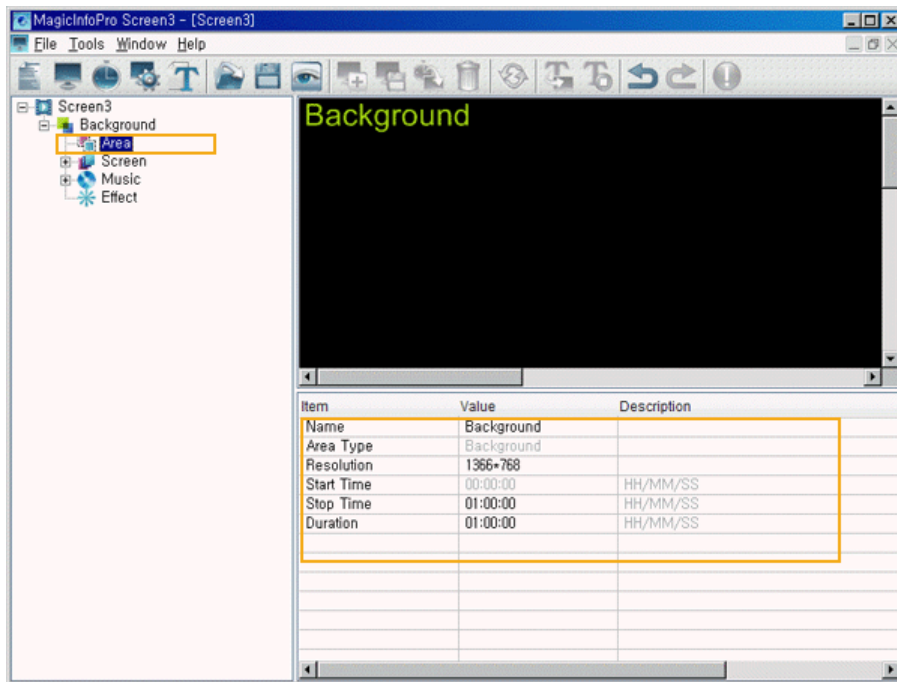

- ▶ Name: Changes the background name.
 - + You cannot use a name already used for another area name.
- ▶ Resolution: Changes the resolution for the background. You can add a new resolution and set the default resolution using the Options menu.
- ▶ Start Time, Stop Time, Duration: Sets the playing time of the background in minutes.
 - + The playing time of the background changes to that of the screen. It cannot be less than the playing time of the area contained in the background.

● Screen

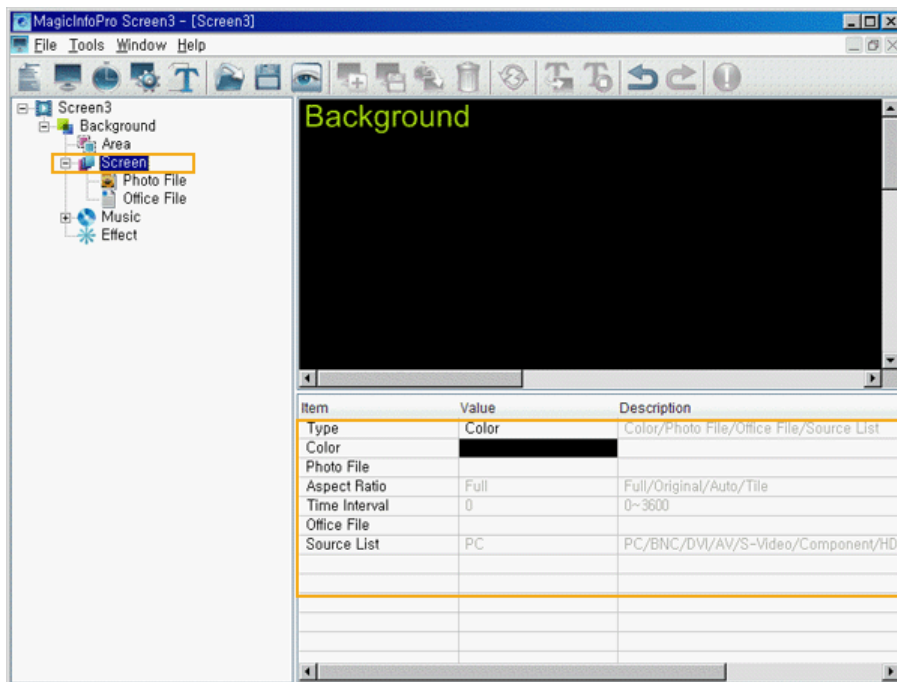

- ▶ Type: Sets the type of background (Color, Photo File, Office File, Source List).
 - + If Office File or Source List is selected, you cannot create another area.
- ▶ Color: Selects the color to use when the background type is set to Color.
- ▶ Photo File: Selects the photo file when the background type is set to Photo File.
- ▶ Aspect Ratio: Selects the aspect ratio for the photo file when the background type is set to Photo File.
 - Full: The photo file is enlarged or reduced to fit the entire background.
 - Original: The photo file is displayed at the original size.
 - Auto: The photo file is enlarged or reduced to fit the entire background and keeps the original aspect ratio.

- Tile: The photo file is tiled continuously across the entire background.
- ▢ Time Interval: Sets the slide show time between photo files when the background type is set to Photo File.
- ▢ Office File: Selects the office files when the background type is set to Office File.
 - You can create the background using a Power Point, Excel, Word, or PDF file. The office file used is not configured as an area and is just displayed in Full mode in the background. To use an office file, you must install the corresponding viewing program on your product.
 - You can select only one office file..
- ▢ Source List: Selects the source when the background type is set to Source List.
 - You can select only one source.

● Photo File / Office File / Music File

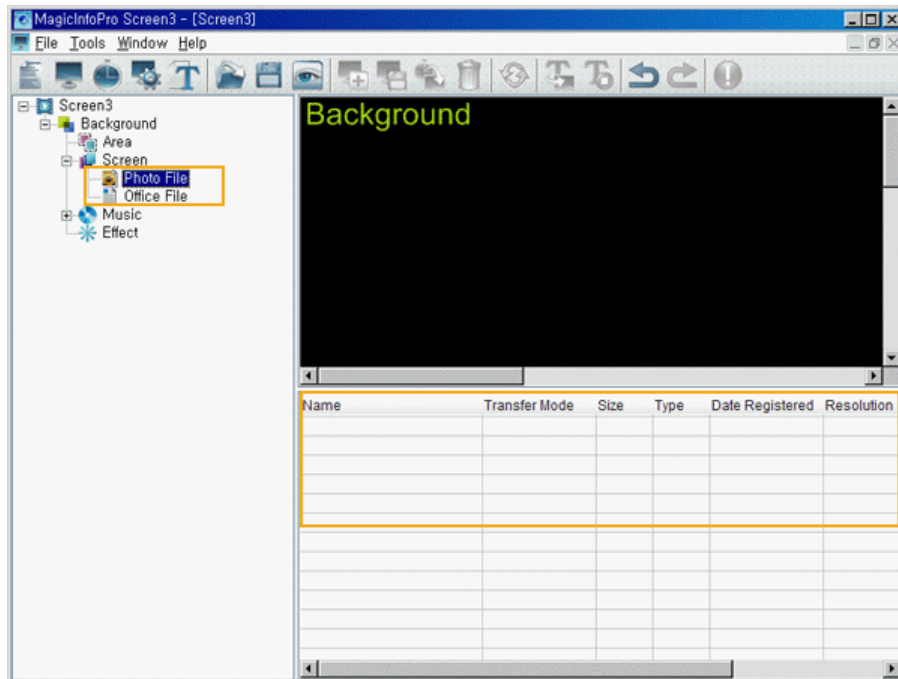

- ▢ Changes the detailed properties and transfer mode for the selected file of each type.
 - Transfer Mode: Changes the mode in which the selected file is transferred to the monitor.
 - Download: Downloads the file to the monitor and plays it.
 - Stream: Streams the file to the monitor.
 - Context Menu: Add, Delete, Up, Down: Adds and deletes a file and changes the playing order.

● Music

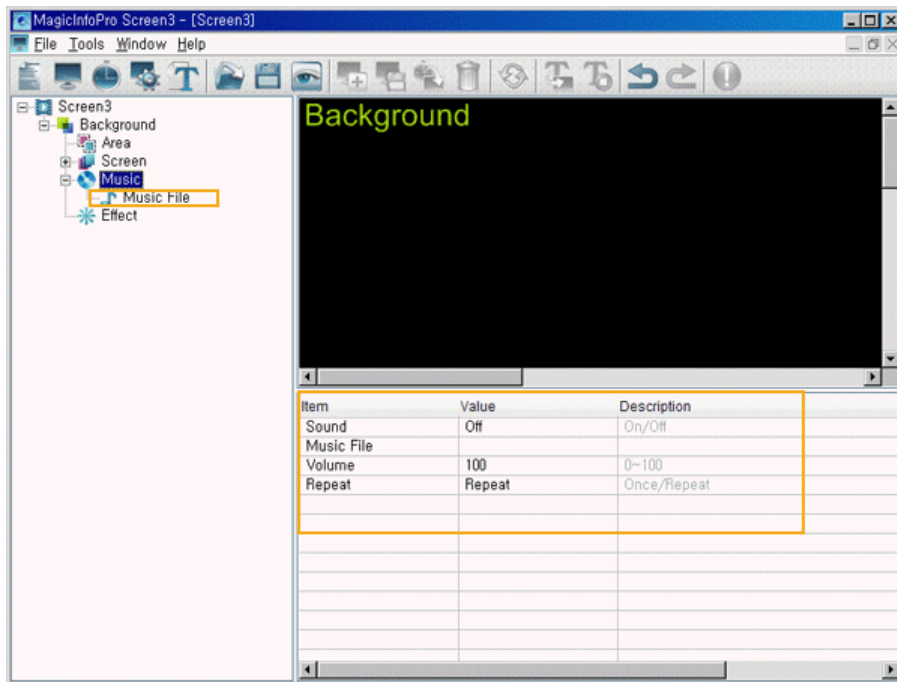

- Sound: Turns the background sound on or off.
- Music File: Selects a music file for the background.
- Volume: Controls the volume of the background music.
- Repeat: A music file can be played repeatedly. When set to Repeat, the music file is played repeatedly while the background is created.

● Effect

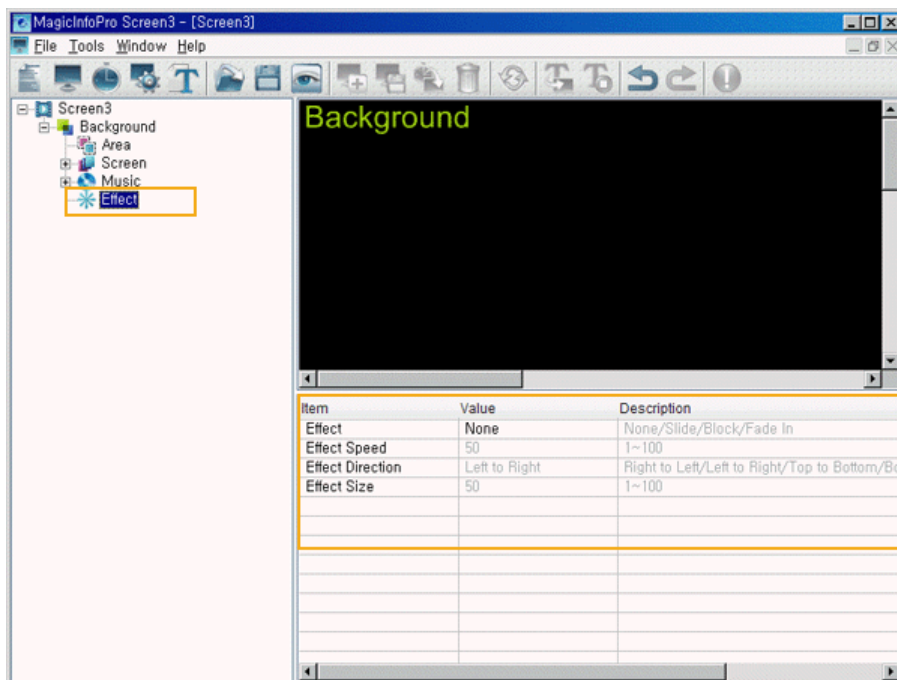

- Effect: Selects the type of effect to be applied when the background is created.
 - None: No effect is used.
 - Slide: The background is created while it is moving.
 - Block: The background is created with blocks.
 - Fade In: The background fades in when it is created.
- Effect Speed: Adjusts the speed of an effect being created.
- Effect Direction: Sets the direction when the Slide effect is selected.
- Effect Size: Sets the size of the blocks when the Block effect is selected.

Photo

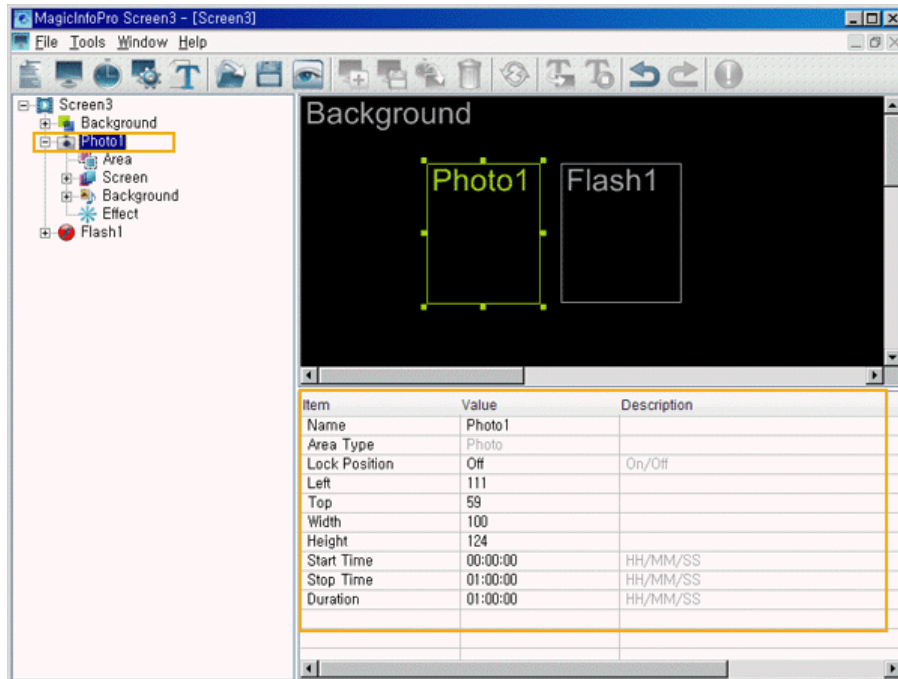

This function is for configuring screens using photo files and consists of the Area, Screen, Background, Effect functions. The Area function allows you to set the position where the photo is displayed and for how long it is displayed. The Screen function allows you to select photo files and how to display them. The Background function allows you to set the background image and music when the photo is displayed. The Effect function allows you to set an effect for when the background changes. The following section describes the detailed options used with the Photo function.

Area

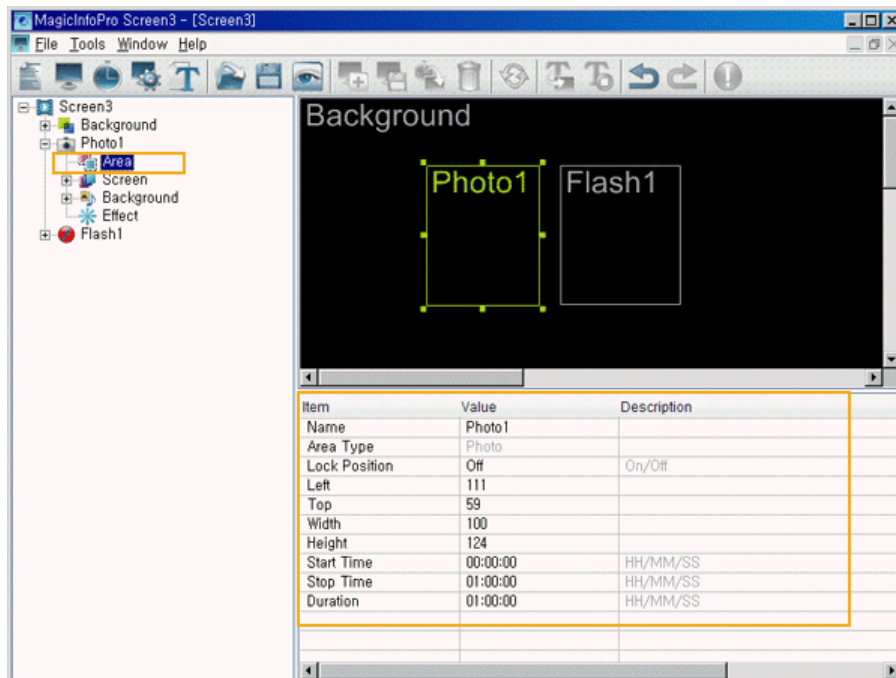

- Name: Changes the area name.
 - You cannot use a name already used for another area name.
- Lock Position: Locks the position of the area.
- Left, Top, Width, Height: Changes the position and size of the area.
 - The area positions must be within the background and the area size cannot be larger than the background size.
- Start Time, Stop Time, Duration: Sets the playing time in seconds.
 - It cannot be longer than the background playing time.

● Screen

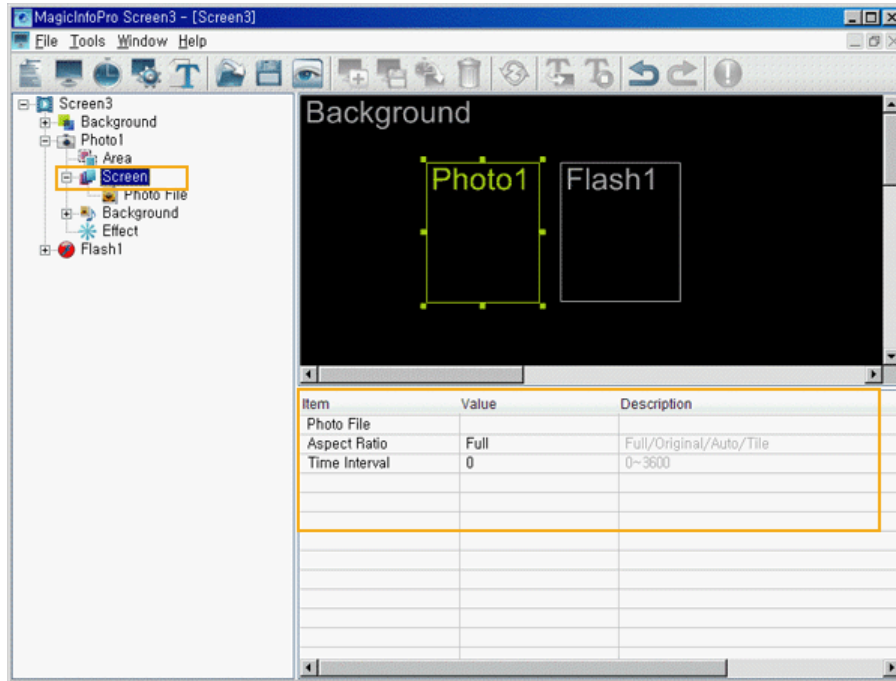

- └ Photo File: Selects a photo file to play in the Photo area.
- └ Aspect Ratio: Selects the aspect ratio for the photo files to be played in the Photo area.
 - Full: The photo file is enlarged or reduced to fit the entire background.
 - Original: The photo file is displayed at the original size.
 - Auto: The photo file is enlarged or reduced to fit the entire background and keeps the original aspect ratio.
 - Tile: The photo file is tiled continuously across the entire background.
- └ Time Interval: Sets the slide show time between selected photo files.

● Background

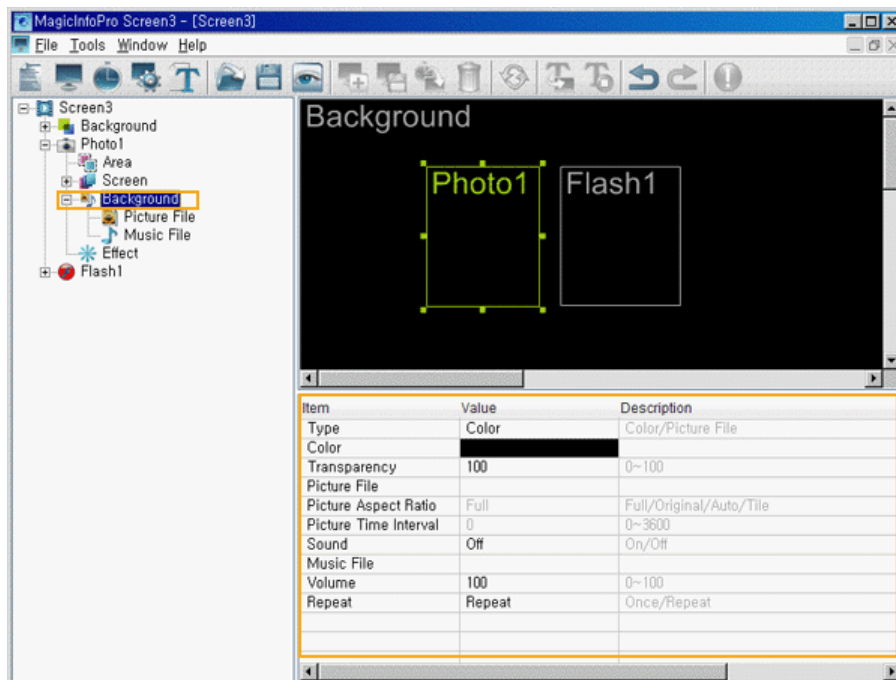

- └ Type: Sets the background type (Color, Picture File) for the Photo area.
- └ Color: Selects the color when the background type for the Photo area is set to Color.
- └ Transparency: Selects the degree of transparency when the background type for the Photo area is set to Color.
 - ⊕ If the Transparency is set to a value under 100, the area which is placed beneath the present area is shown transparently. However, if a Movie is playing in one of the areas, the transparency doesn't affect the movie area.

- Picture File: Selects the photo file when the background type for the Photo area is set to Picture File.
- Picture Aspect Ratio: Selects the aspect ratio for the photo file when the background type of the Photo area is set to Picture File.
 - Full: The photo file is enlarged or reduced to fit the entire background.
 - Original: The photo file is displayed at the original size.
 - Auto: The photo file is enlarged or reduced to fit the entire background and keeps the original aspect ratio.
 - Tile: The photo file is tiled continuously across the entire background.
- Picture Time Interval: Sets the slide show time between selected photo files when the background type for the Photo area is set to Picture File.
- Sound: Turns the background sound for the Photo area on or off.
- Music File: Selects a music file for the background in the Photo area.
- Volume: Controls the volume for the background music in the Photo area.
- Repeat: A music file can be played repeatedly. When set to Repeat, the music file is played repeatedly while the background for the Photo area is created.

● Photo File / Office File / Music File

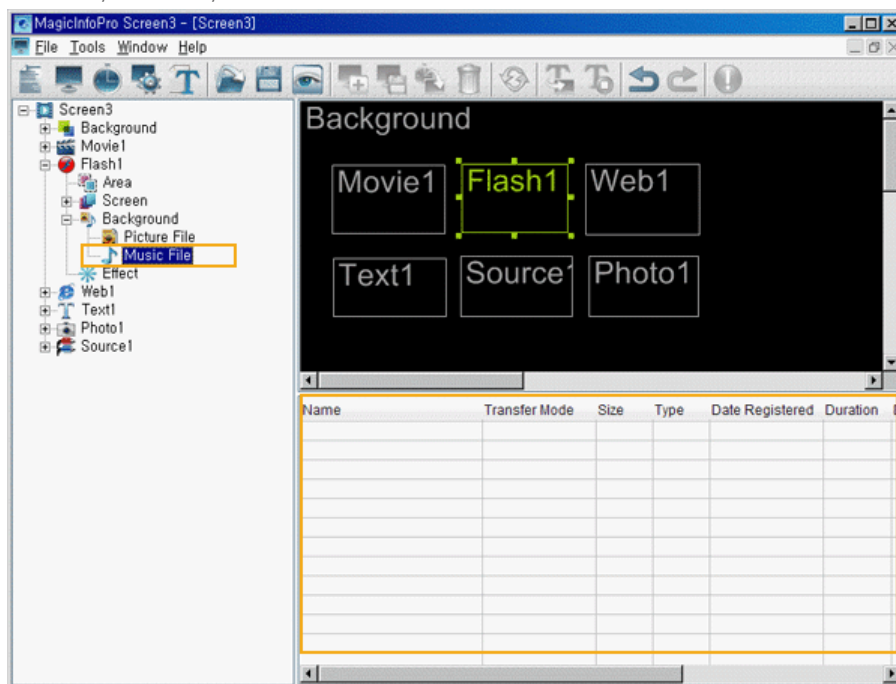

- Changes the detailed properties and the transfer mode for the selected file of each type.
 - Transfer Mode: Changes the mode in which the selected file is transferred to the monitor.
 - Download: Downloads the file to the monitor and plays it.
 - Stream: Streams the file to the monitor.
 - Context Menu: Add, Delete, Up, Down: Adds and deletes a file and changes the playing order.

● Effect

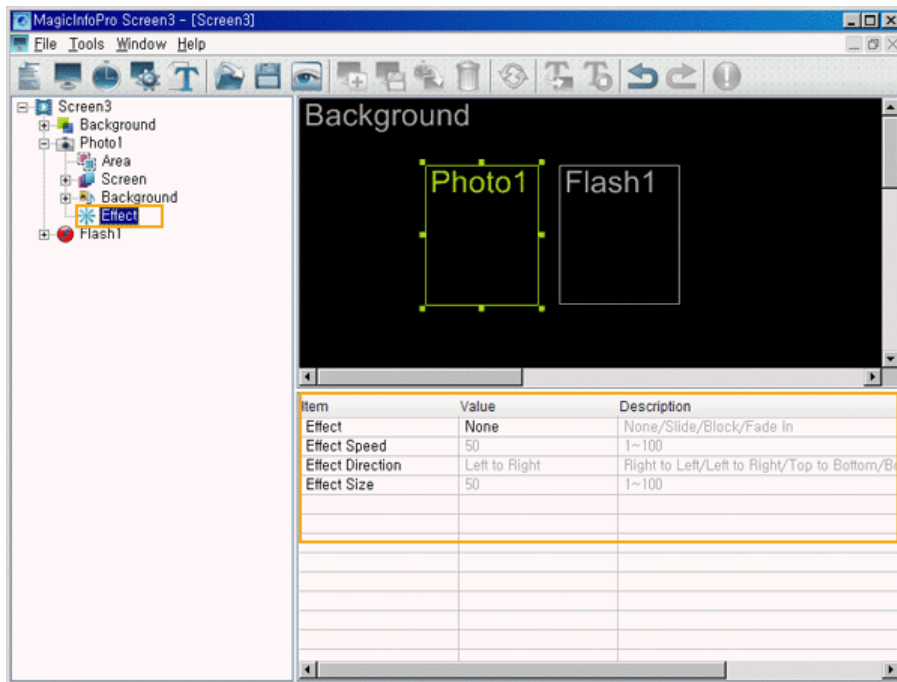

- Effect: Selects the type of effect to be applied when the Photo area is created.
 - None: No effect is used.
 - Slide: The Photo area is created while it is moving.
 - Block: The Photo area is created with blocks.
 - Fade In: The Photo Area fades in when it is created.
- Effect Speed: Adjusts the speed of an effect being created.
- Effect Direction: Sets the direction when the Slide effect is selected.
- Effect Size: Sets the size of the blocks when the Block effect is selected.

● Movie

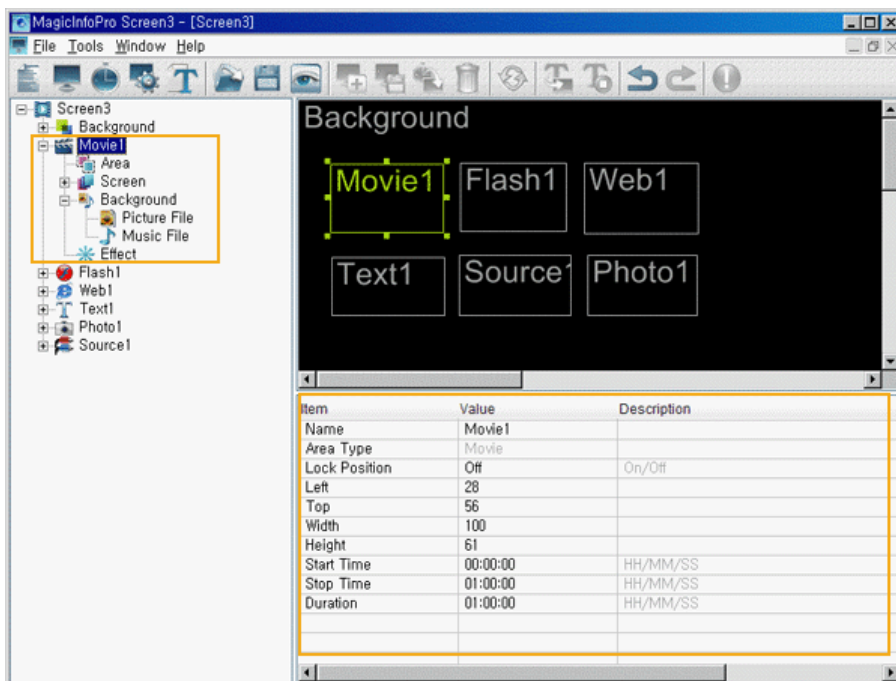

This function is for configuring screens using movie files and consists of Area, Screen, Background, Effect functions. The Area function allows you to set the position where the movie is played and when and for how long it is played. The Screen function allows you to select the movie file and how to play it. The Background function allows you to set the background image and music when the movie is displayed. The Effect function allows you to set an effect for when the background changes.

● Area

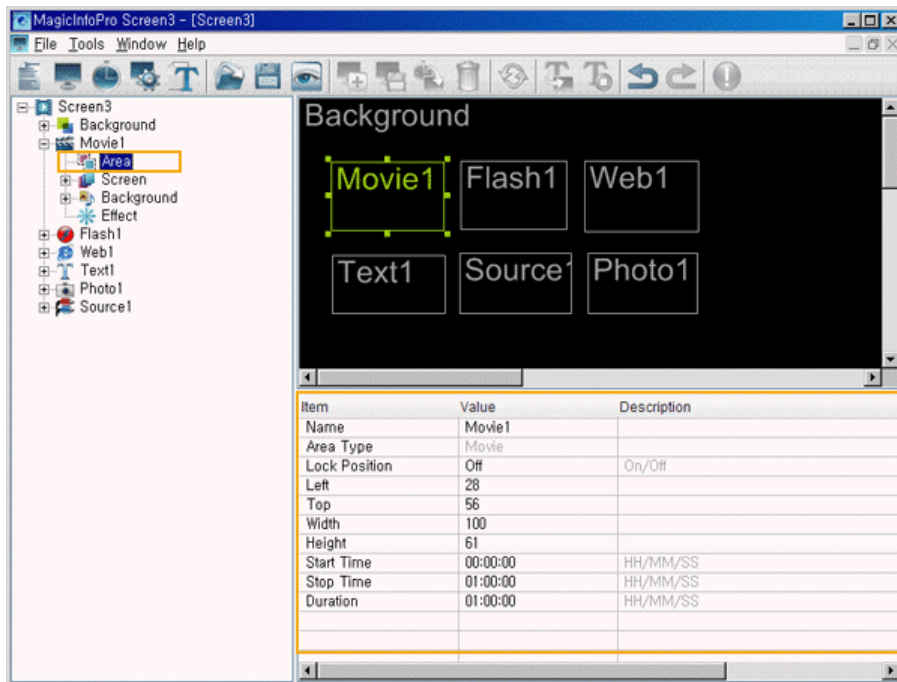

- Name: Changes the area name.
 - + You cannot use a name already used for another area name.
- Lock Position: Locks the position of the area.
- Left, Top, Width, Height: Changes the position and size of the area.
 - + The area positions must be within the background and the area size cannot be larger than the background size.
- Start Time, Stop Time, Duration: Sets the playing time in seconds.
 - + It cannot be longer than the background playing time.

● Screen

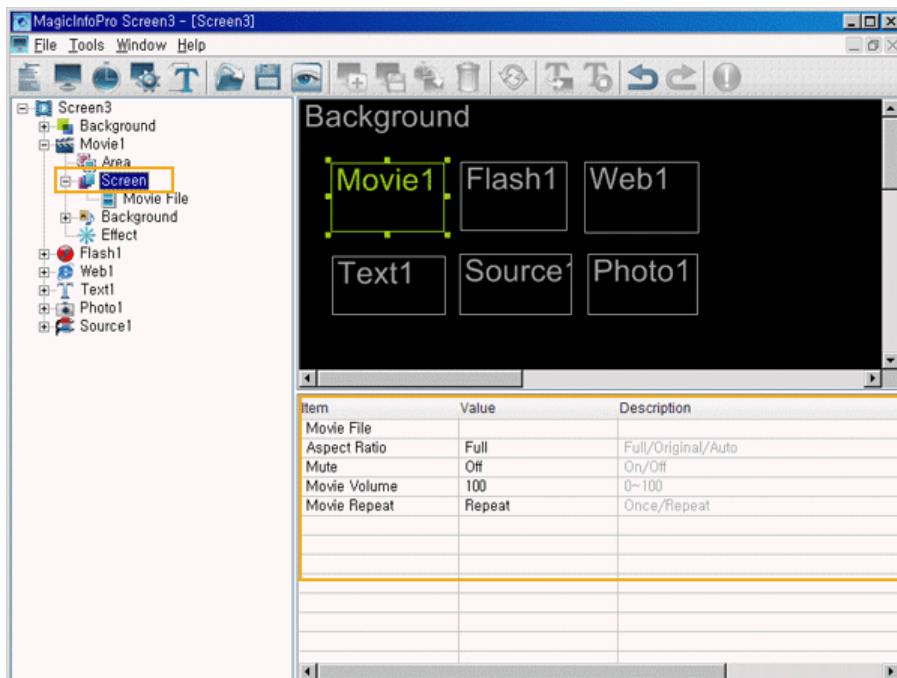

- Movie File: Selects the movie file to be played in the Movie area.
- Aspect Ratio: Selects the aspect ratio for the movie file to be played in the Movie area.
 - Full: The movie file is enlarged or reduced to fit the entire background.
 - Original: The movie file is displayed at the original size.
 - Auto: The movie file is enlarged or reduced to fit the entire background and keeps the original aspect ratio.
- Mute: Mutes the sound of the movie file to be played in the Movie area.
- Movie Volume: Controls the volume of the movie file to be played in the Movie area.

- Movie Repeat: A movie file can be played repeatedly. When set to Repeat, the movie file is played repeatedly while the background is created.

Background

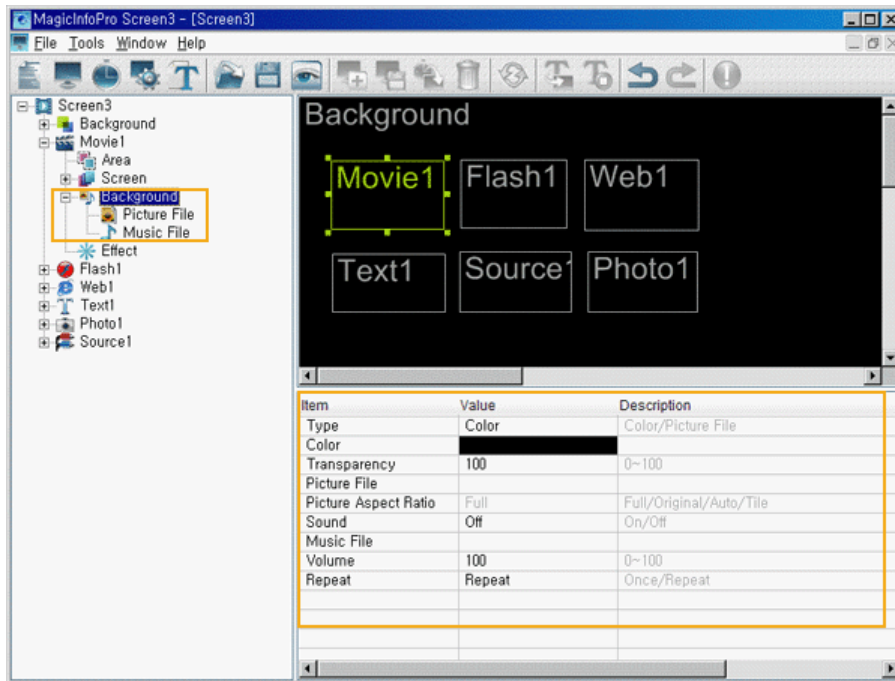

- Type: Sets the background type (Color, Picture File) for the Movie area.
- Color: Selects the color when the background type for the Movie area is set to Color.
- Transparency: Selects the degree of transparency when the background type for the Movie area is set to Color.
 - If the Transparency is set to a value under 100, the area which is placed beneath the present area is shown transparently. However, if a Movie is playing in one of the areas, the transparency doesn't affect the movie area.
- Picture File: Selects the photo file when the background type for the Movie area is set to Picture File.
 - Only one picture file can be selected in the Movie area.
- Picture Aspect Ratio: Selects the aspect ratio for the photo file to be played in the Movie area when the background type of the Movie area is set to Picture File.
 - Full: The photo file is enlarged or reduced to fit the entire background.
 - Original: The photo file is displayed at the original size.
 - Auto: The photo file is enlarged or reduced to fit the entire background, and keeps the original aspect ratio.
 - Tile: The photo file is tiled continuously across the entire background.
- Sound: Turns the background sound for the Movie area on or off.
- Music File: Selects a music file for the background in the Movie area.
- Volume: Controls the volume of background music in the Movie area.
- Repeat: A music file can be played repeatedly. When set to Repeat, the music file is played repeatedly while the background for the Movie area is created.

Movie File / Picture File / Music File

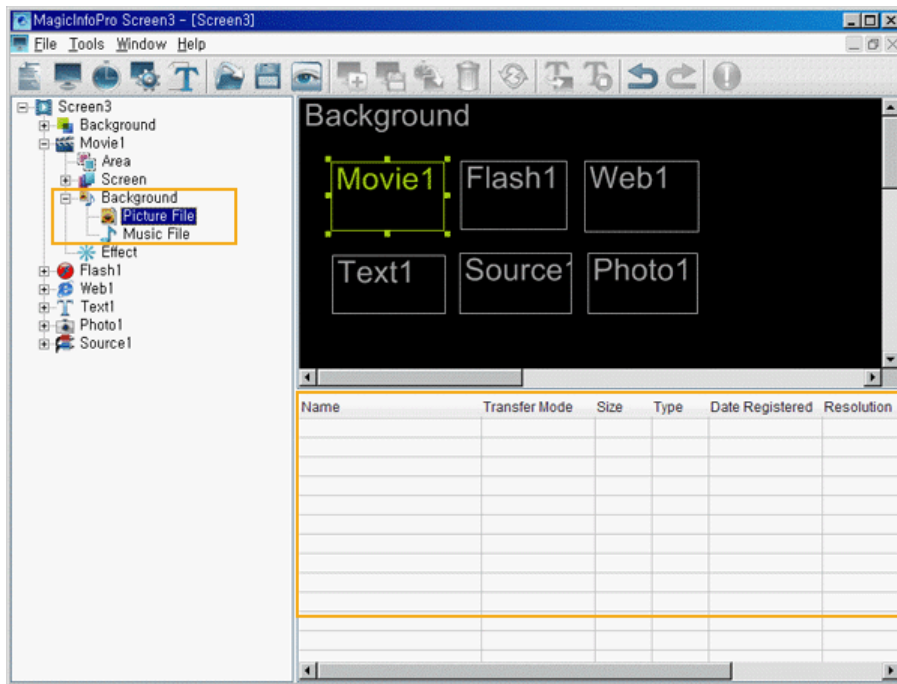

- Changes the detailed properties and the transfer mode for the selected file of each type.
 - Transfer Mode: Changes the mode in which the selected file is transferred to the monitor.
 - Download: Downloads the file to the monitor and plays it.
 - Stream: Streams the file to the monitor.
 - Context Menu: Add, Delete, Up, Down: Adds and deletes a file and changes the playing order.

● Effect

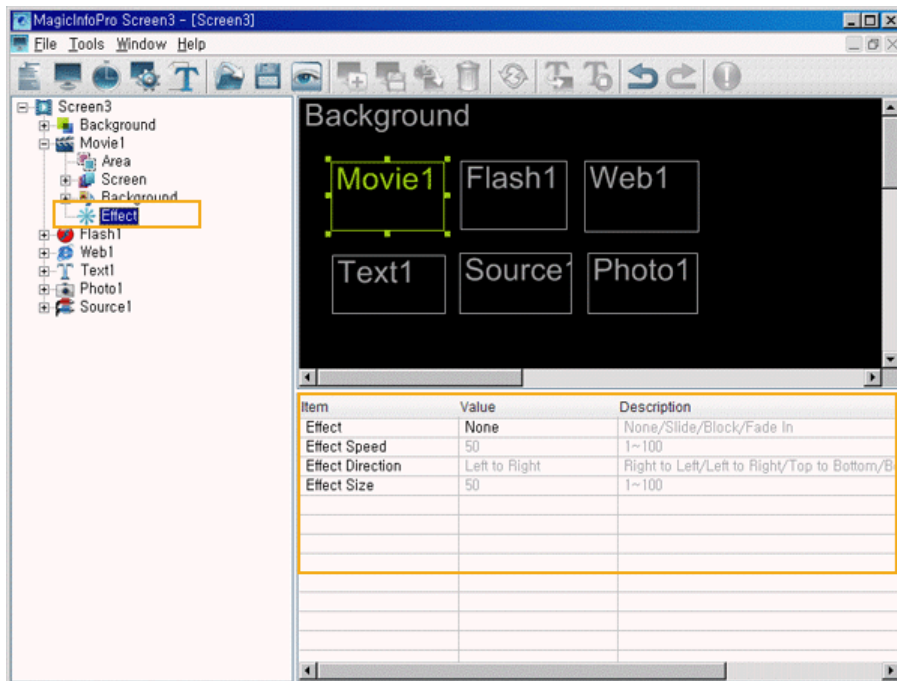

- Effect: Selects the type of effect to be applied when the Movie area is created.
 - None: No effect is used.
 - Slide: The Movie area is created while it is moving.
 - Block: The Movie area is created with blocks.
 - Fade In: The Movie area fades in when it is created.
- Effect Speed: Adjusts the speed of an effect being created.
- Effect Direction: Sets the direction when the Slide effect is selected.
- Effect Size: Sets the size of the blocks when the Block effect is selected.

● Flash

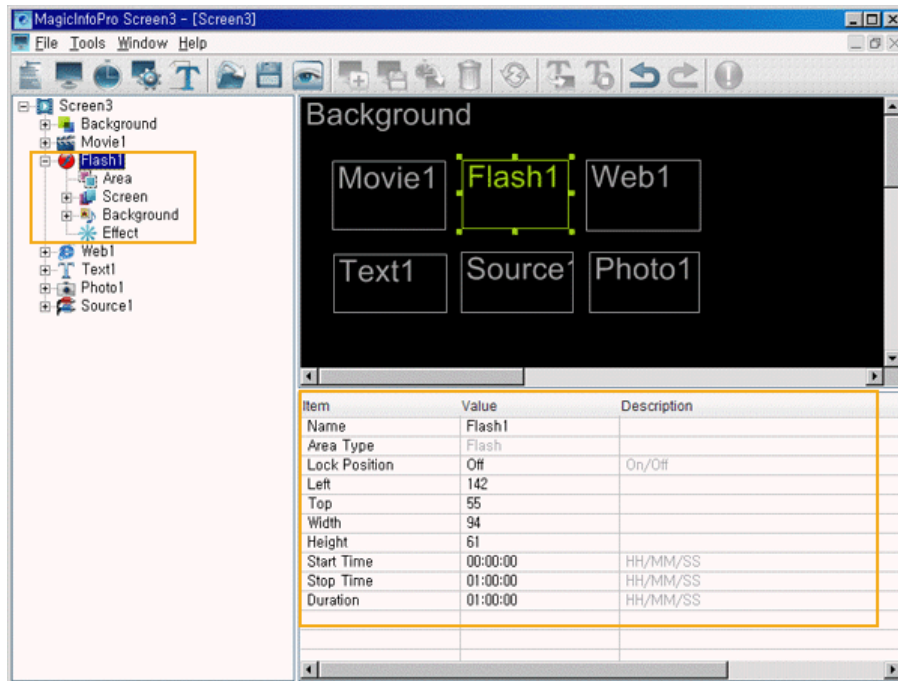

This function is for configuring screens using Macromedia flash files and consists of Area, Screen, Background, Effect functions. The Area function allows you to set the position where the movie is played and when and for how long it is played. The Screen function allows you to set the flash file and how to play it. The Background function allows you to set the background image and music when the flash file is played. The Effect function allows you to set the effect for when the background changes.

- ⊕ If no flash player is installed on the PC where the server is installed, the operation may not be normal. Make sure to install a flash player.

Area

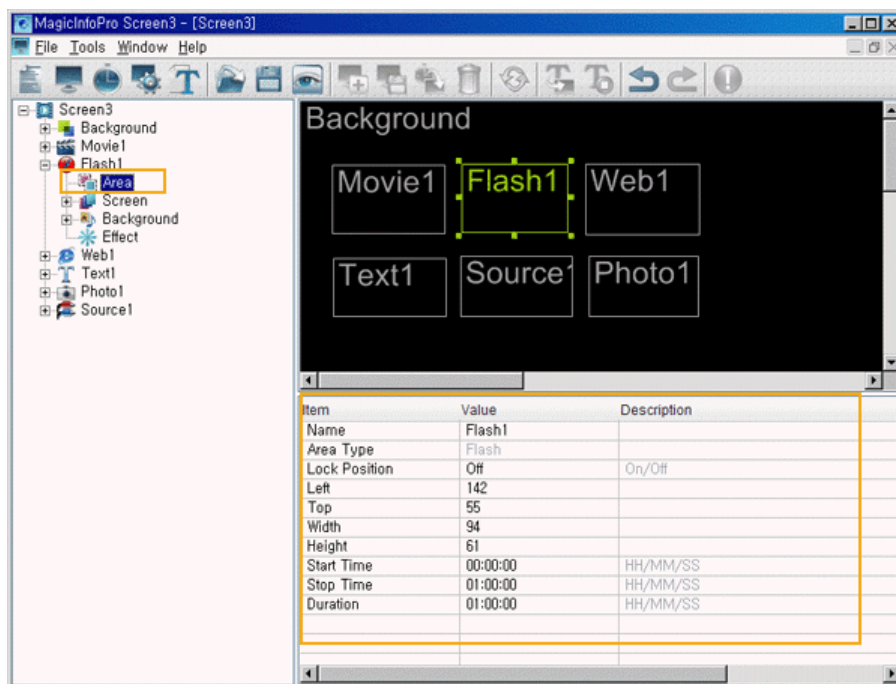

- ▢ Name: Changes the area name.
 - ⊕ You cannot use a name already used for another area name.
- ▢ Lock Position: Locks the position of the area.
- ▢ Left, Top, Width, Height: Changes the position and size of the area.
 - ⊕ The area positions must be within the background and the area size cannot be larger than the background size.
- ▢ Start Time, Stop Time, Duration: Sets the playing time in seconds.
 - ⊕ It cannot be longer than the background playing time.

● Screen

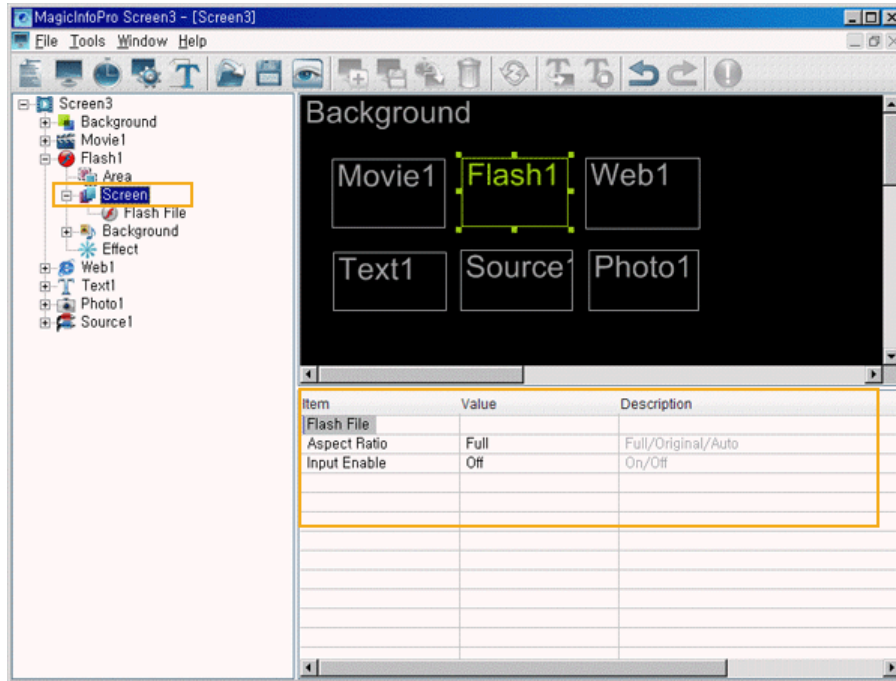

- └ Flash File: Selects the flash file to be played in the Flash area.
- └ Aspect Ratio: Selects the aspect ratio for the flash file to be played in the Flash area.
 - Full: The flash file is enlarged or reduced to fit the entire background.
 - Original: The flash file is displayed at the original size.
 - Auto: The flash file is enlarged or reduced to fit the entire background, and keeps the original aspect ratio.
- └ Input Enable: You can input using the mouse in the Flash area.

● Background

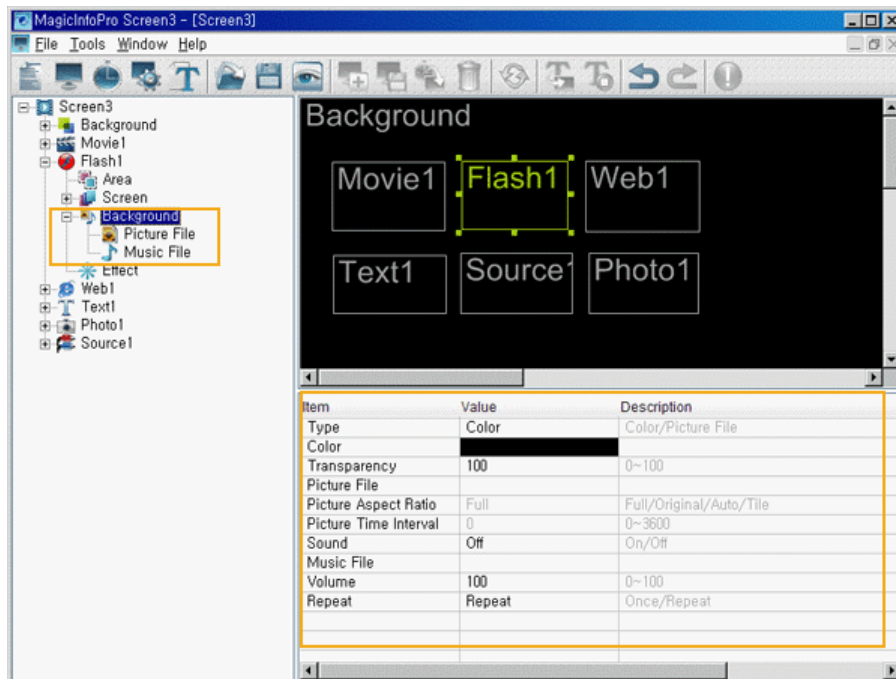

- └ Type: Sets the background type (Color, Picture File) for the Flash area.
- └ Color: Selects the color when the background type for the Flash area is set to Color.
- └ Transparency: Selects the degree of transparency when the background type for the Flash area is set to Color.
 - ➕ If the Transparency is set to a value under 100, the area which is placed beneath the present area is shown transparently. However, if a Movie is playing in one of the areas, the transparency doesn't affect the movie area.
- └ Picture File: Selects the photo file when the background type for the Flash area is set to Picture File.

- Picture Aspect Ratio: Selects the aspect ratio for the photo file to be played in the Flash area when the background type of the Flash area is set to Picture File.
 - Full: The photo file is enlarged or reduced to fit the entire background.
 - Original: The photo file is displayed at the original size.
 - Auto: The photo file is enlarged or reduced to fit the entire background and keeps the original aspect ratio.
 - Tile: The photo file is tiled continuously across the entire background.
- Picture Time Interval: Sets the slide show time between photo files when the background type for the Flash area is set to Picture File.
- Sound: Turns the background sound for the Flash area on or off.
- Music File: Selects a music file for the background in the Flash area.
- Volume: Controls the volume of the background music in the Flash area.
- Repeat: A music file can be played repeatedly. When set to Repeat, the music file is played repeatedly while the background for the Flash area is created.

Flash File / Picture File / Music File

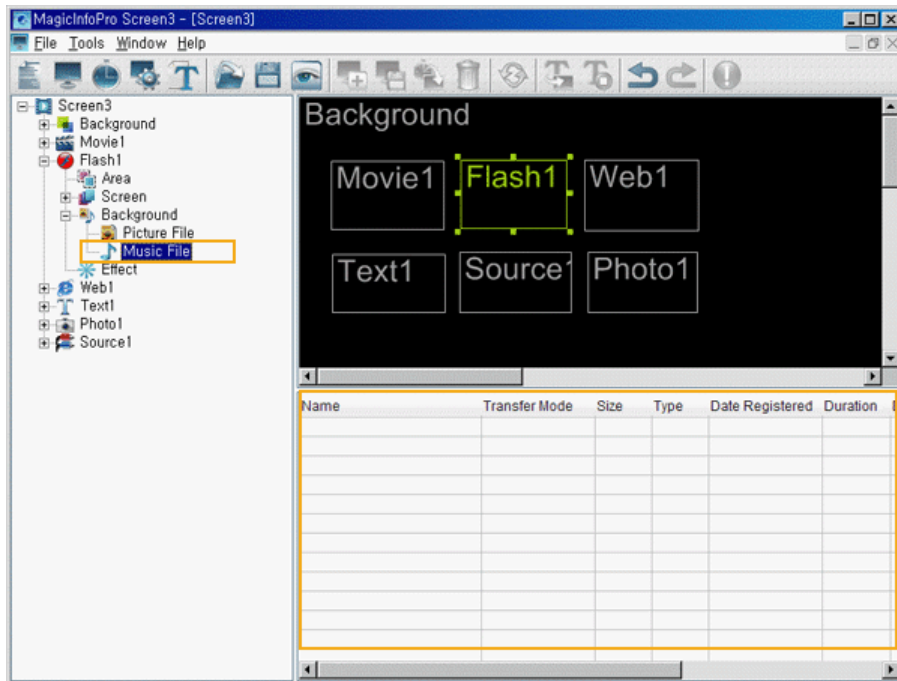

- Changes the detailed properties and the transfer mode for the selected file of each type.
 - Transfer Mode: Changes the mode in which the selected file is transferred to the monitor.
 - Download: Downloads the file to the monitor and plays it.
 - Stream: Streams to the monitor.
 - Context Menu: Add, Delete, Up, Down: Adds and deletes a file and changes the playing order.

Effect

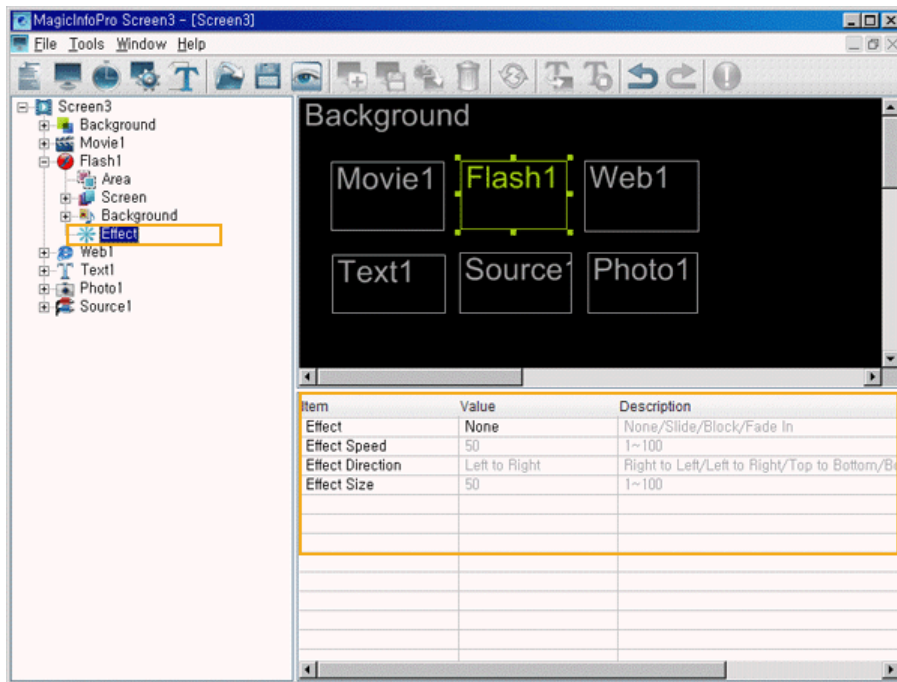

- Effect: Selects the type of effect to be applied when the Flash area is created.
 - None: No effect is used.
 - Slide: The Flash area is created while it is moving.
 - Block: The Flash area is created with blocks.
 - Fade In: The Flash area fades in when it is created.
- Effect Speed: Adjusts the speed of an effect being created.
- Effect Direction: Sets the direction when the Slide effect is selected.
- Effect Size: Sets the size of the blocks when the Block effect is selected.

● Web

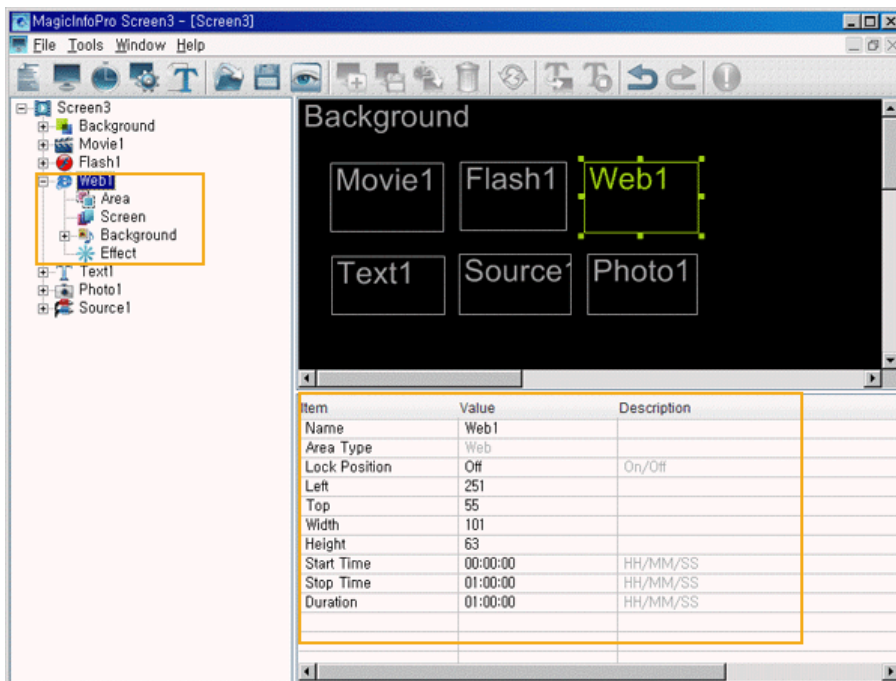

This function is for configuring screens by connecting website files and consists of the Area, Screen, Background and Effect functions. The Area function allows you to set the position of the webpage and when and for how long it is displayed. The Screen function allows you to set the website file to connect to and the location of the web page. The Background function allows you to set the background image and music when the web page is displayed. The Effect function allows you to set the effect for when the background changes.

● Area

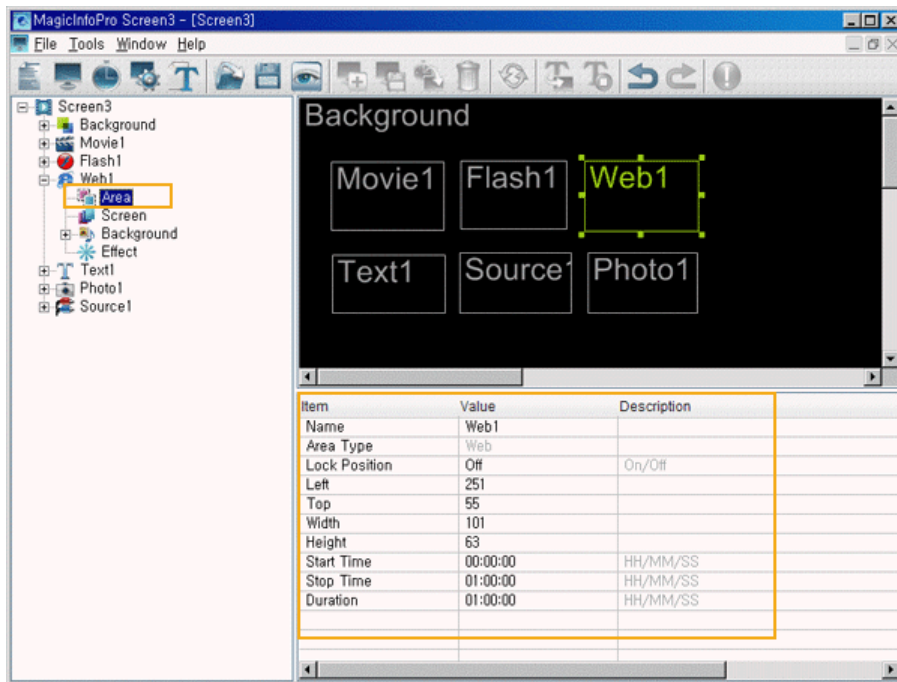

- Name: Changes the area name.
 - + You cannot use a name already used for another area name.
- Lock Position: Locks the position of the area.
- Left, Top, Width, Height: Changes the position and size of the area.
 - + The area positions must be within the background and the area size cannot be larger than the background size.
- Start Time, Stop Time, Duration: Sets the playing time in seconds.
 - + It cannot be longer than the background playing time.

● Screen

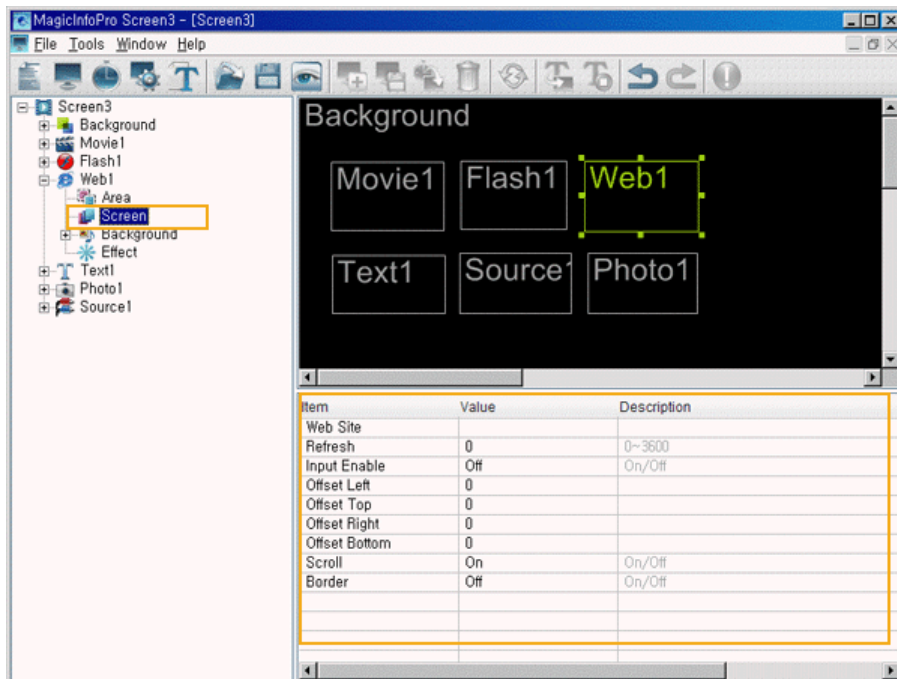

- Website: Sets a web page to display in the Web area.
 - + Only one URL can be selected in the Web Area.
- Refresh: Sets the refresh time for the URL displayed in the Web area.
- Input Enable: You can input using the mouse in the Web area.
- Offset Left /Top / Right / Bottom: Moves the position of the web page in the Web area.
- Scroll: Turns the scrollbar for web pages on or off.
- Border: Shows or hides the border for web pages in the Web area.

● Background

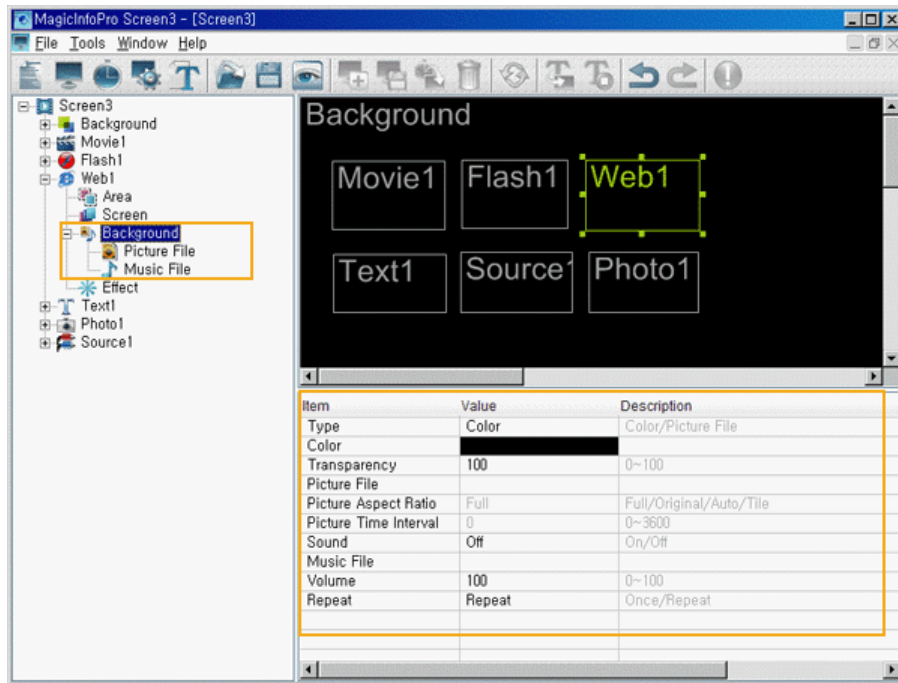

- └─ Type: Sets the background type (Color, Picture File) for the Web area.
- └─ Color: Selects the color when the background type for the Web area is set to Color.
- └─ Transparency: Selects the degree of transparency when the background type for the Web area is set to Color.
 - If the Transparency is set to a value under 100, the area which is placed beneath the present area is shown transparently. However, if a Movie is playing in one of the areas, the transparency doesn't affect the movie area.
- └─ Picture File: Selects the photo file when the background type for the web area is set to Picture File.
- └─ Picture Aspect Ratio: Selects the aspect ratio for the photo file to be played in the web area when the background type of the Web area is set to Picture File.
 - Full: The photo file is enlarged or reduced to fit the entire background.
 - Original: The photo file is displayed at the original size.
 - Auto: The photo file is enlarged or reduced to fit the entire background and keeps the original aspect ratio.
 - Tile: The photo file is tiled continuously across the entire background.
- └─ Picture Time Interval: Sets the slide show time between photo files when the background type for the Web area is set to Picture File.
- └─ Sound: Turns the background sound for the Web area on or off.
- └─ Music File: Selects a music file for the background in the Web area.
- └─ Volume: Controls the volume of the background music in the Web area.
- └─ Repeat: A music file can be played repeatedly. When set to Repeat, the music file is played repeatedly while the background for the Web area is created.

● Photo File / Music File

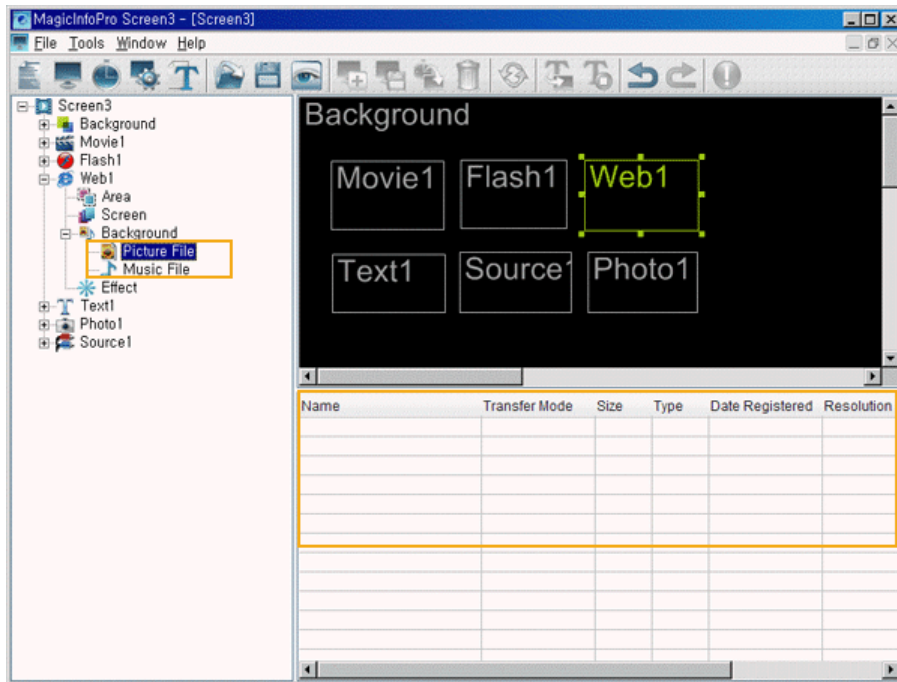

- Changes the detailed properties and the transfer mode for the selected file of each type.
 - Transfer Mode: Changes the mode in which the selected file is transferred to the monitor.
 - Download: Downloads the file to the monitor and plays it.
 - Stream: Streams the file to the monitor.
 - Context Menu: Add, Delete, Up, Down: Adds and deletes a file and changes the playing order.

● Effect

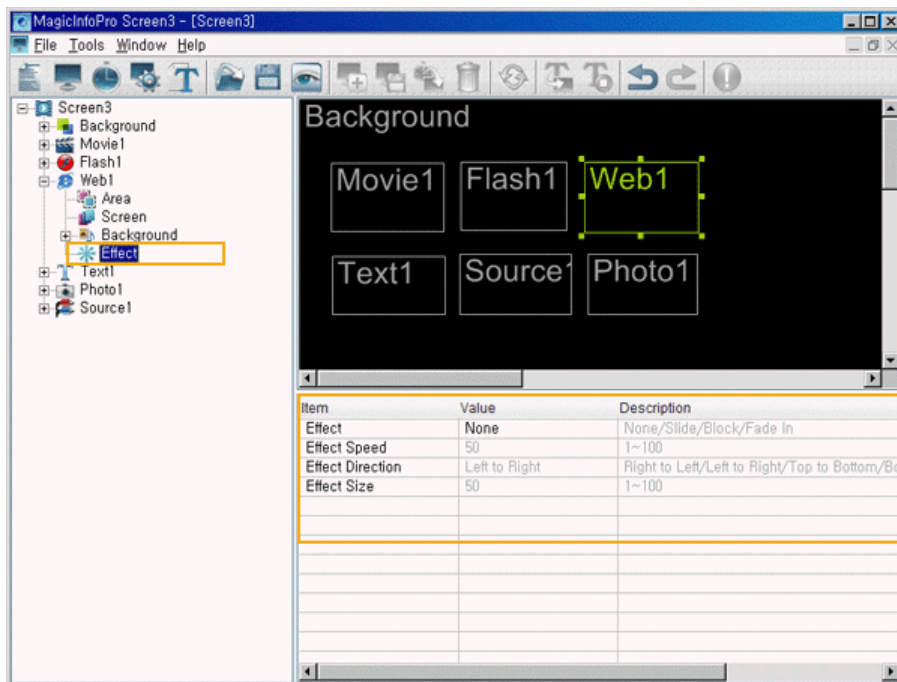

- Effect: Selects the type of effect to be applied when the Web area is created.
 - None: No effect is used.
 - Slide: The Web area is created while it is moving.
 - Block: The Web area is created with blocks.
 - Fade In: The Web area fades in when it is created.
- Effect Speed: Adjusts the speed of an effect being created.
- Effect Direction: Sets the direction when the Slide effect is selected.
- Effect Size: Sets the size of the blocks when the Block effect is selected.

● Text

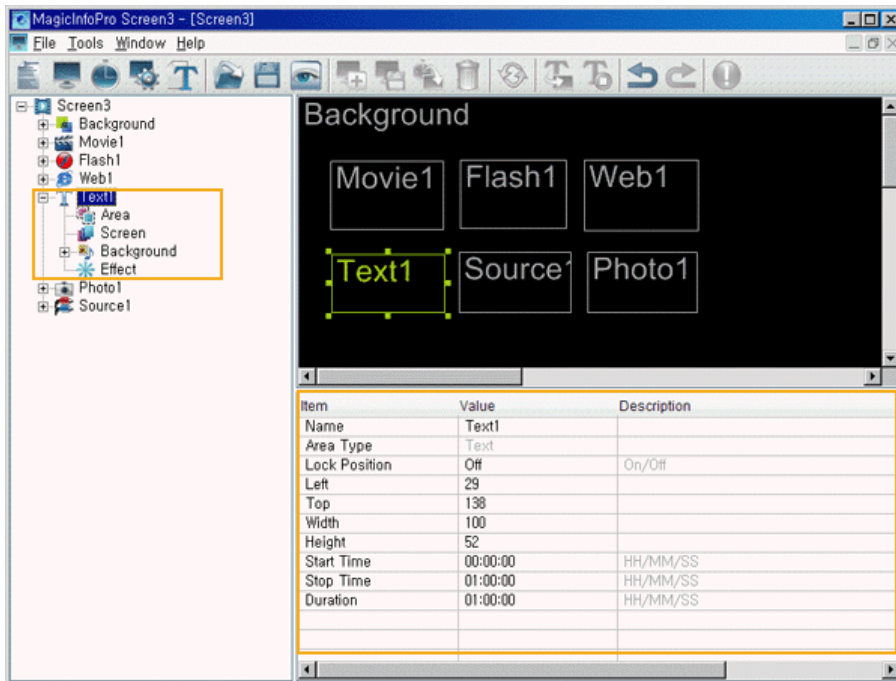

This function is for configuring screens by connecting text and consists of the Area, Screen, Background, Effect functions. The Area function allows you to set the position of the text and when and for how long it is displayed. The Screen function allows you to select the text and how to display it. The Background function allows you to set the background image and music when the text is displayed. The Effect function allows you to set the effect used when the background changes. The following section describes the detailed options used with the Text function.

Area

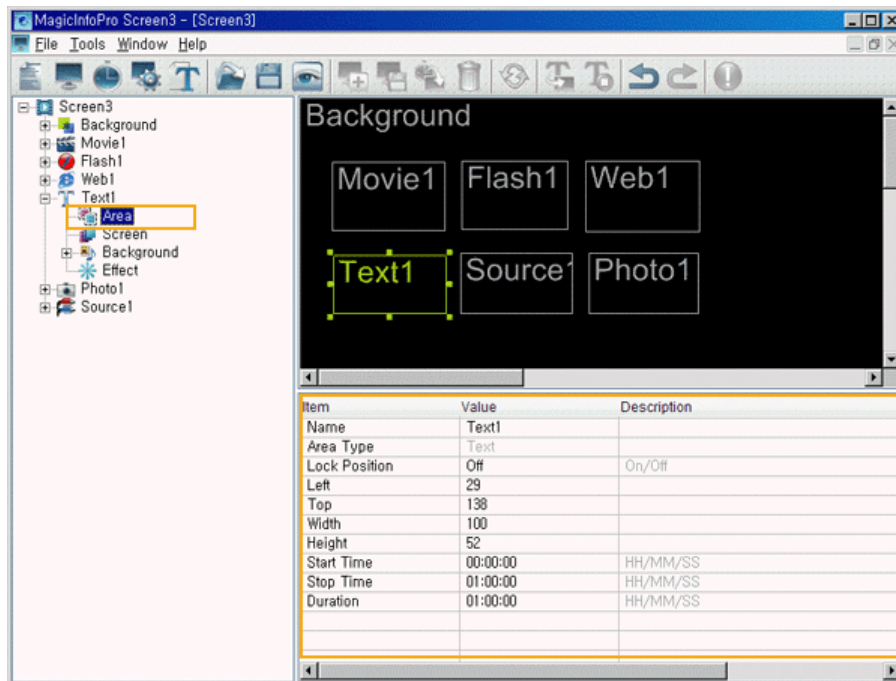

- Name: Changes the area name.
 - You cannot use a name already used for another area name.
- Lock Position: Locks the position of the area.
- Left, Top, Width, Height: Changes the position and size of the area.
 - The area positions must be within the background and the area size cannot be larger than the background size.
- Start Time, Stop Time, Duration: Sets the playing time in seconds.
 - It cannot be longer than the background playing time.

Screen

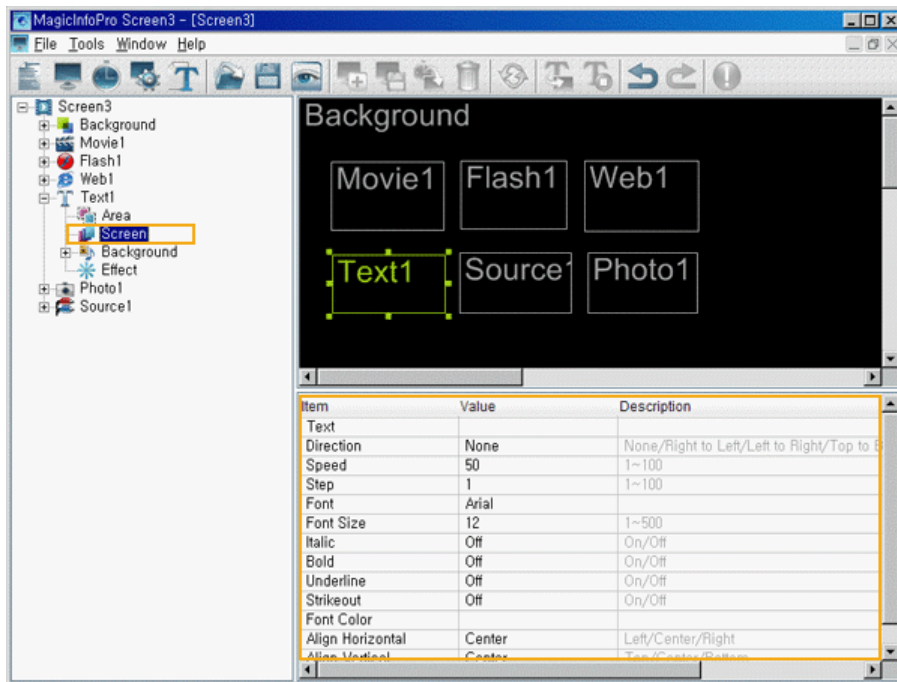

- ▣ Text: Sets the text to be displayed in the Text area.
- ▣ Direction: Sets the direction of the text flow in the Text area.
 - None
 - Right to Left
 - Left to Right
 - Top to Bottom
 - Bottom to Top Text
- ▣ Speed: Sets the speed of the text flow in the Text area.
- ▣ Step: Sets the interval of the text flow in the Text area.
- ▣ Font, Font Size, Italic, Bold, Underline, Strikeout, Font Color: Sets the formatting for the text in the Text area.
 - ⊕ The font type shows the font of the computer where the server is operating. The same font should be installed in the monitor so that the monitor can display the same font.
- ▣ Align Horizontal, Vertical: Aligns the text in the Text area.

● Background

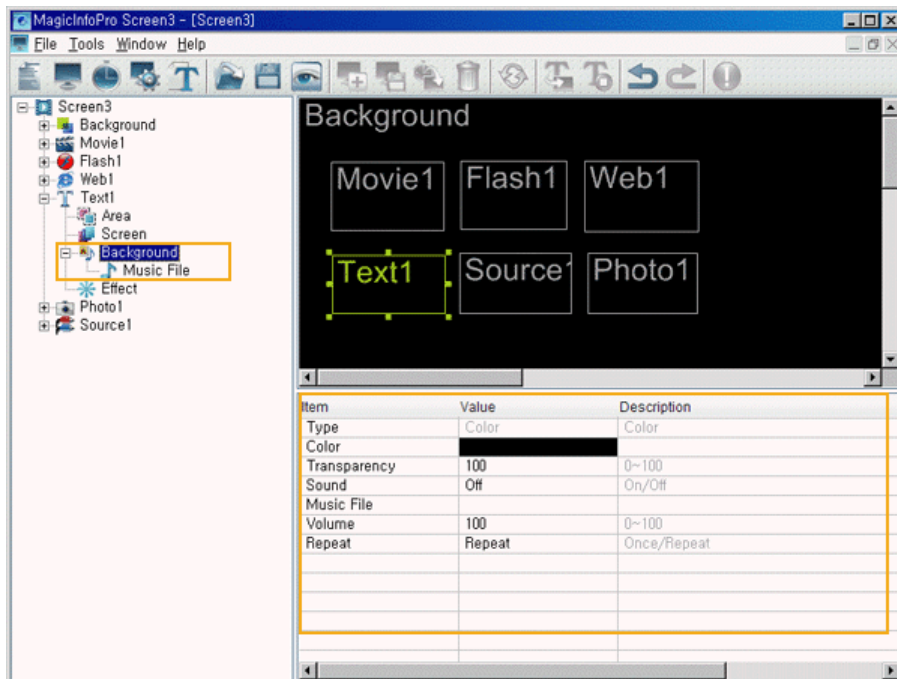

- ▣ Type: Sets the background type (Color) for the Text area.
 - ⊕ You can only select Color for the background type (Color) for the Text area.

- Color: Selects the color to use when the background type for the Text area is set to Color.
- Transparency: Selects the degree of transparency to be used when the background type for the text area is set to Color.
 - ➕ If the Transparency is set to a value under 100, the area which is placed beneath the present area is shown transparently. However, if a Movie is playing in one of the areas, the transparency doesn't affect the movie area.
- Sound: Turns the background sound for the Text area on or off.
- Music File: Selects a music file for the background in the Text area.
- Volume: Controls the volume of the background music in the text area.
- Repeat: A music file can be played repeatedly. When set to Repeat, the music file is played repeatedly while the background for the Text area is created.

● Music File

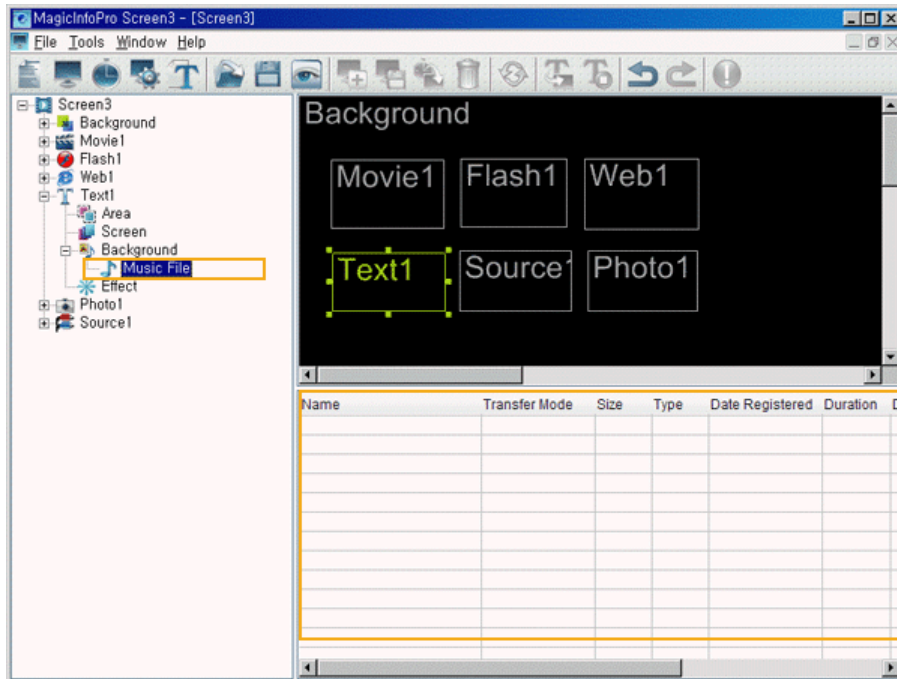

- Changes the detailed properties and the transfer mode for the selected file of each type.
 - Transfer Mode: Changes the mode in which the selected file is transferred to the monitor.
 - Download: Downloads the file to the monitor and plays it.
 - Stream: Streams the file to the monitor.
 - Context Menu: Add, Delete, Up, Down: Adds and deletes a file and changes the playing order.

● Effect

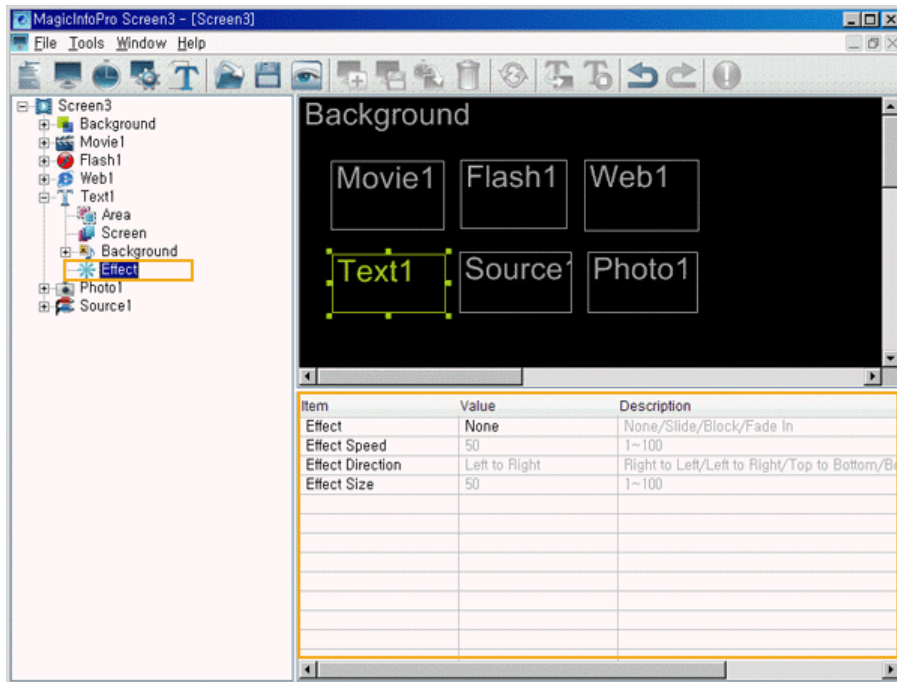

- Effect: Selects the type of effect to be applied when the Text area is created.
 - None: No effect is used.
 - Slide: The Text area is created while it is moving.
 - Block: The Text area is created with blocks.
 - Fade In: The Text area fades in when it is created.
- Effect Speed: Adjusts the speed of an effect being created.
- Effect Direction: Sets the direction when the Slide effect is selected.
- Effect Size: Sets the size of the blocks when the Block effect is selected.

● Source

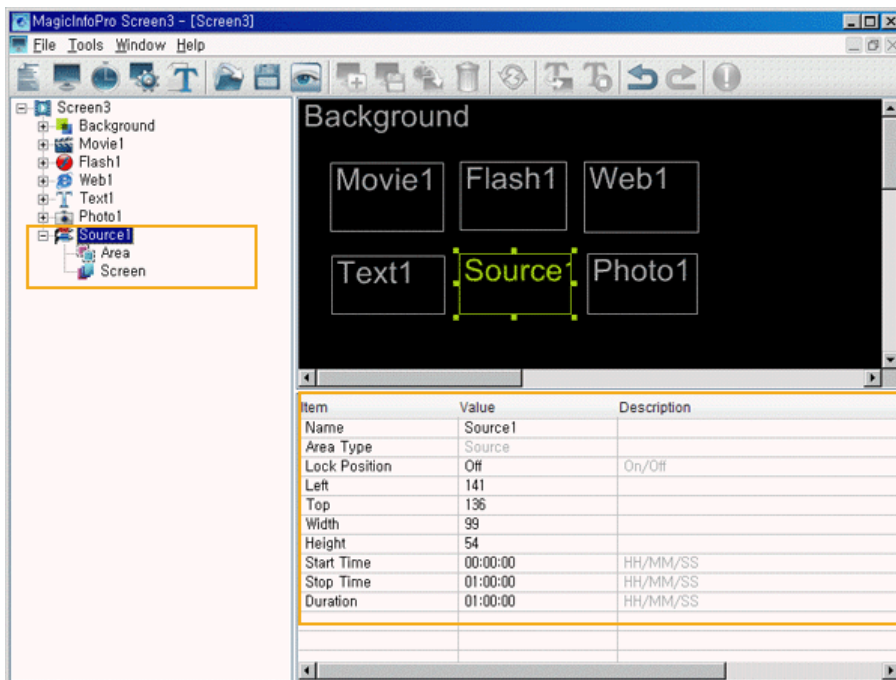

- More than one Source Area cannot be played at the same time. Therefore, if the playing time of a source area overlaps, the source area whose playing time ends later is played..

● Area

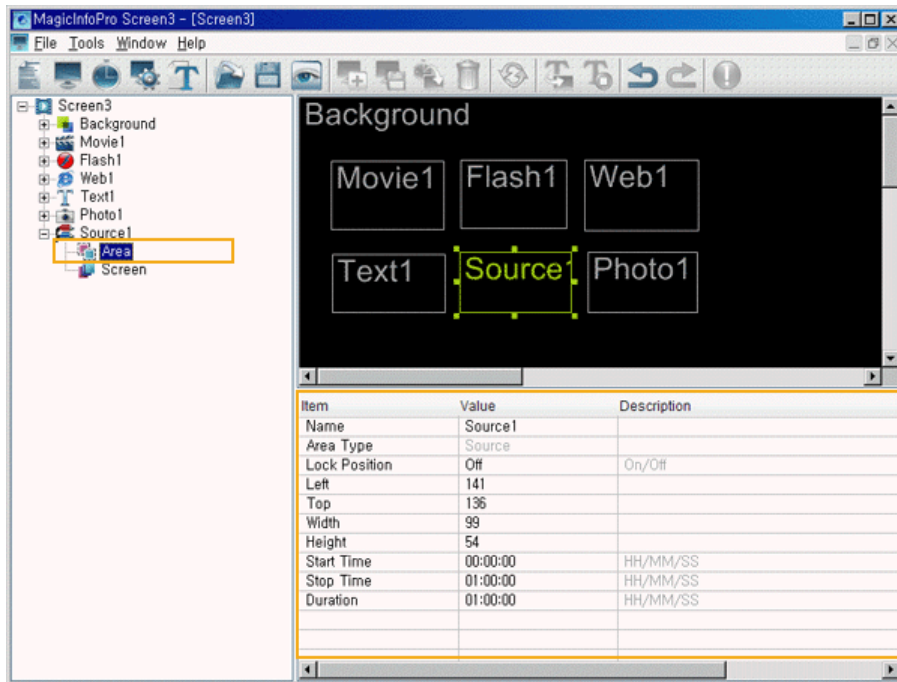

- Name: Changes the area name.
 - You cannot use a name already used for another area name.
- Lock Position: Locks the position of the area.
- Left, Top, Width, Height: Changes the position and size of the area.
 - The area positions must be within the background and the area size cannot be larger than the background size.
- Start Time, Stop Time, Duration: Sets the playing time in seconds.
 - It cannot be longer than the background playing time.

Screen

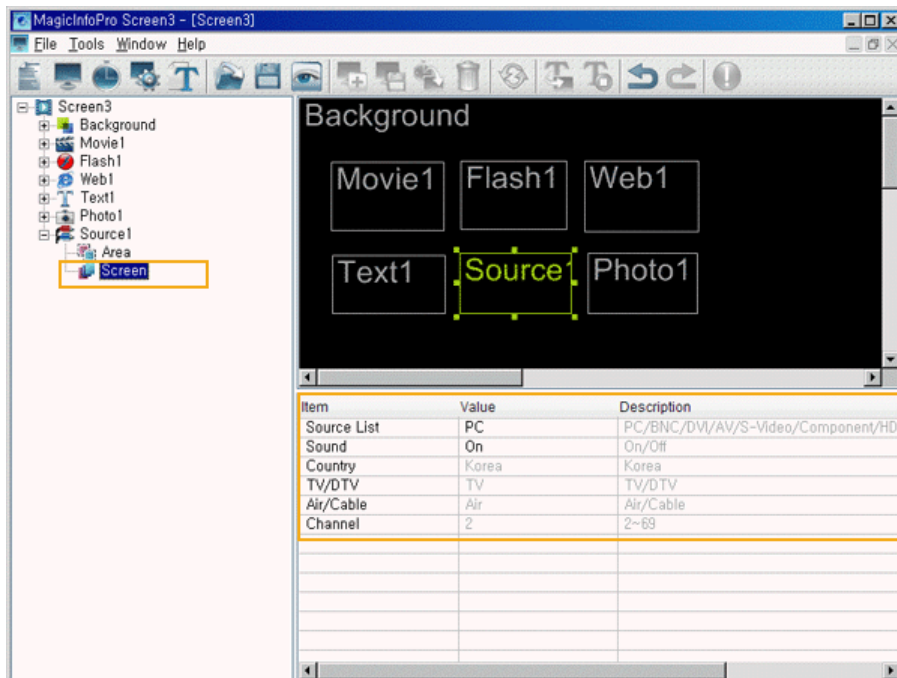

- Source List: Selects the source to be played in the Source area.
- Sound: Turns the sound for the source you want to play in the Source area on or off.
- TV/DTV : When selecting TV from the TV/External Input list, you can select either Analog TV or Digital TV. When selecting Digital TV, you can enter both the main and sub channels using the channel option. (460TXn Only)
- General Broadcasting/Cable Broadcasting: You can select general or cable broadcasting.(460TXn Only)
- Channel: You can select the channel for the selected TV (460TXn Only)
 (TV: General broadcasting channel range - 2~69, Cable broadcasting channel range 1, 14~135)
 (DTV : Main channel range - 0 to 999, Sub channel range - 0 to 999)

● Edit View

This view is used for screen design and allows you to create, move and change the size of an area using your mouse. You can preview the current state by selecting Preview Area from the context menu or double-clicking on an area.

▢ Context Menu

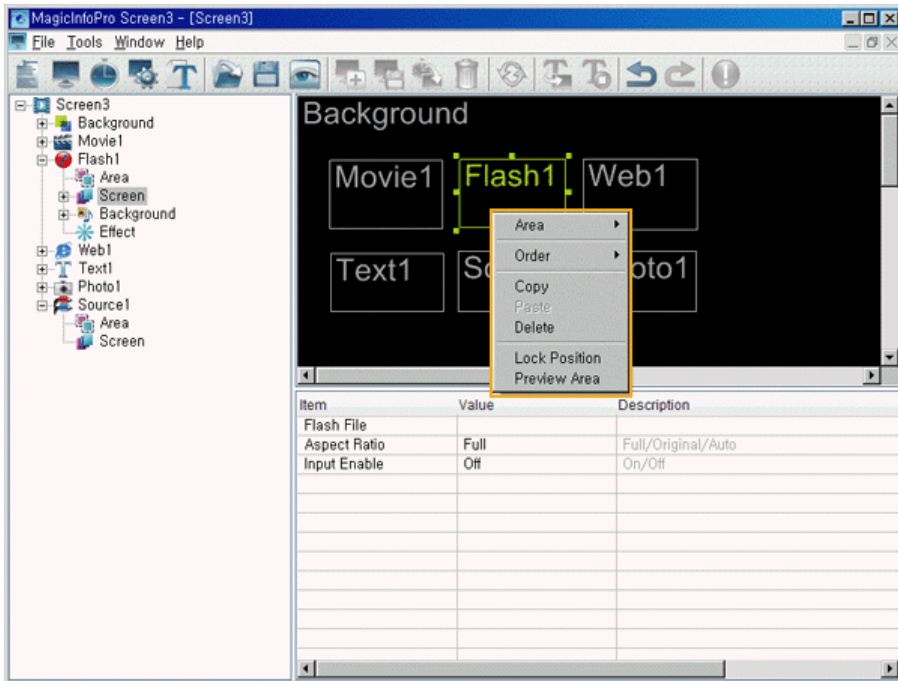

- Area: Selects the type of area you wish to create. You can create an area by dragging and dropping it into the Screen Edit window.
 - ➕ More than one Source Area cannot be played at the same time. Therefore, if the playing time of a source area overlaps, the source area whose playing time ends later is played.
(You can add areas for photo, movie, Flash, web, text, and source.)
- Order: Changes the order of the currently selected area.
 - ➕ The source area is always at the topmost position.
((Bring to Front, Send to Back, Bring Forward, Send Backward))
- Copy / Paste / Delete: Copies, pastes, and deletes the currently selected area.
- Lock Position: Locks the position for the currently selected area. Once an area is locked, you cannot change its position and size using your mouse.
- Preview Area: Previews the current state of the selected area.
 - ➕ You cannot preview the office files for the source and background.

● List View

Displays the detailed functions of each property for the areas you selected in Edit View and Tree View. You can change the settings for the detailed functions by double-clicking on the cell that is displayed in the List View or clicking the created button. The changes are immediately applied to and displayed in the area being previewed.

 Schedule

 File Menu

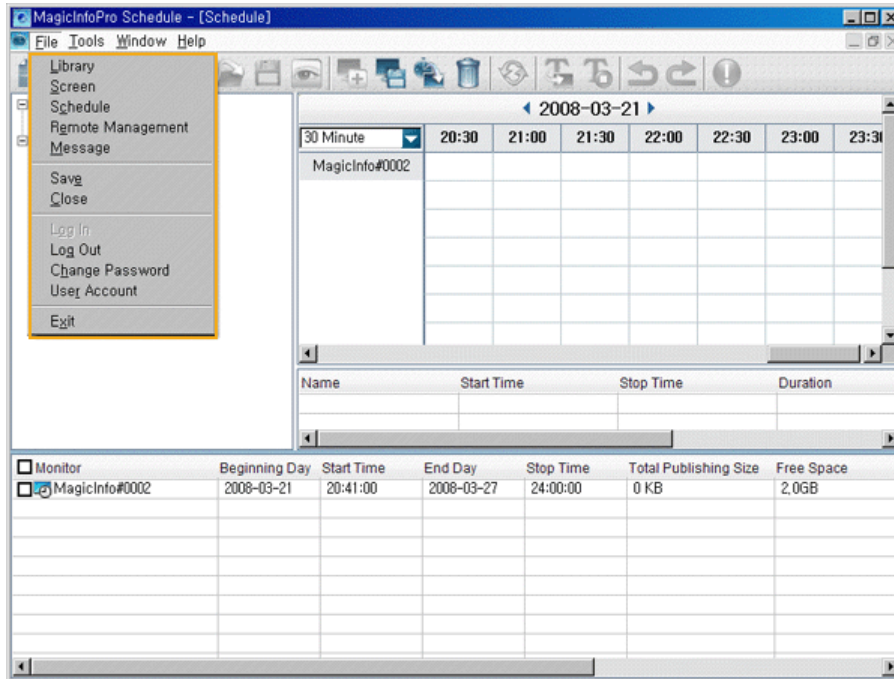

- Library / Screen / Schedule / Remote Management / Message
 - Creates a view or selects a created view for each menu item so that you can perform a screen schedule and performs basic control for the monitors from the server.
- Save
 - Saves all the schedule information currently configured in the EPG view in the database. The saved information is applied when the server restarts.
- Close
 - Closes the schedule view you are working with. If there are any unsaved changes, a new window is displayed so that you can save them.
- Log In
 - You must log in to the server before you can use any one of its functions. You can log in to the server to perform a server program. The password you enter when installing MagicInfo Pro becomes the password of the Administrator account by default.
- Log Out
 - Once you are logged into the server, you can log out. If you log out from the server, all created views are closed and if there are any unsaved changes, a new window is displayed so that you can save them.
- Change Password
 - Changes the password of the currently logged-in account.
- User Account
 - Creates, deletes and changes the user accounts able to log into the server. There are two types of accounts that can be created: Administrator and User Accounts
 - Administrator: Has privileges for all server functions.
 - User: Has privileges for all server functions except for changing server options and user account features.
- Exit
 - Exits the program. If there are any unsaved changes, a new window is displayed so that you can save them.

●●●●●●●●●● Tool Menu

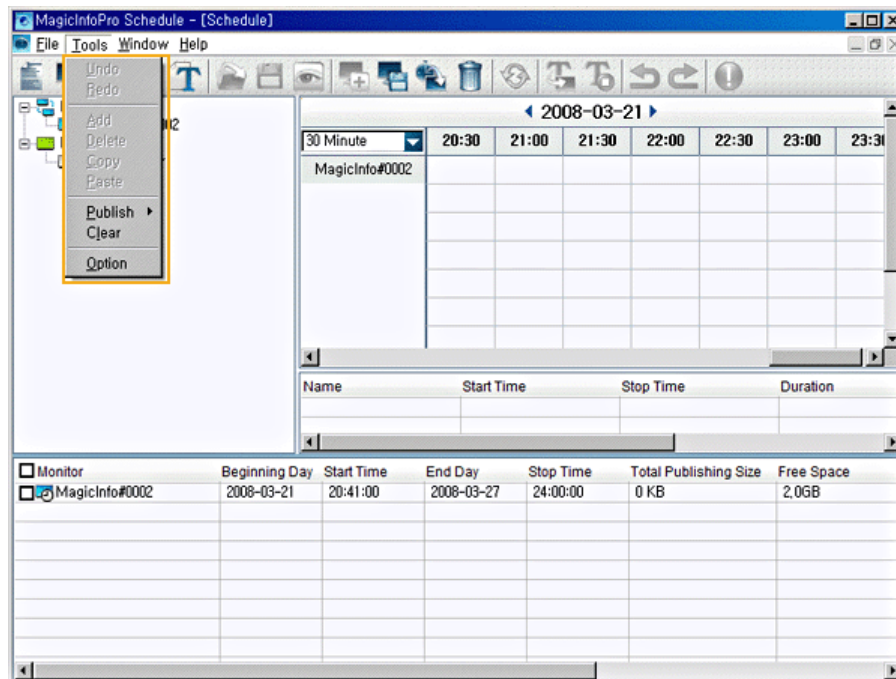

- Undo / Redo
 - Cancels the previously performed command or performs the canceled command again. You can change the maximum number of commands that you can undo using the Option menu.
- Add
 - Adds the screen you wish to schedule after selecting a monitor and time by clicking in the EPG window.
- Delete
 - Deletes the screen currently selected in the EPG window.
- Copy / Paste
 - Copies the currently selected screen and pastes it after selecting a monitor and time by clicking in the EPG window.
- Publish (Network)
 - Publishes the currently configured schedules to the network monitors checked in the Publish View via the network.
- Publish (Local)
 - Publishes the currently configured schedules to the local monitors checked in the Publish View. They are created in the folder named after the monitor name, which is used as the local publishing directory. If you copy all the files and subfolders under the folder created in the name of the monitor to the root of a USB memory device and connect it to the USB port of your computer, the schedules are performed automatically without connecting to the network.
 - You can set and change how to run schedules by changing the Local Schedule Option for the monitor. For more information, refer to the help on the monitor setup.
 - You can view and change the local publishing directory in the Schedule tab of the Option. The default is the folder where the server executable exists.
- Clear
 - Stops the publishing which is in progress for a monitor checked in the Publish View and stops the schedule the networked monitor is running.
- Option
 - Changes the server settings. For more information, refer to the Option tab.

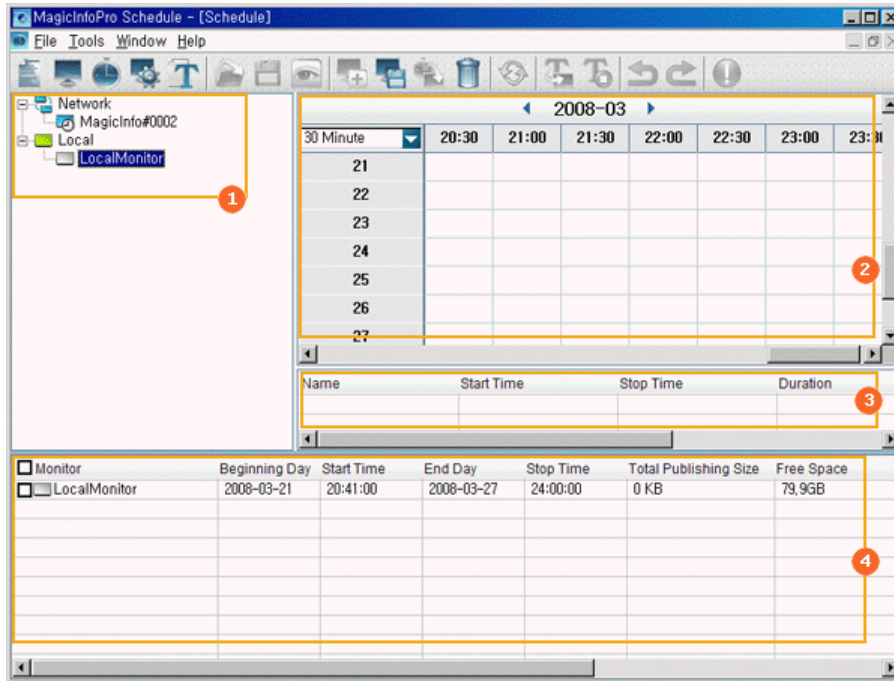

Schedule



- 1 Tree View
- 2 EPG View
- 3 List View
- 4 Publish View

Tree View

Displays the connection state of the monitors currently connected to the server depending on the monitor icon. You can also efficiently manage the monitors by creating network groups. You can move a networked monitor by dragging and dropping it into a group.

- : The server is connected to the monitor in Player mode.
- : The server is connected to the monitor in Scheduler mode.
- : The server is connected to the monitor in an unknown mode.
- : The server is not connected to the monitor or the monitor is a local monitor.

Network

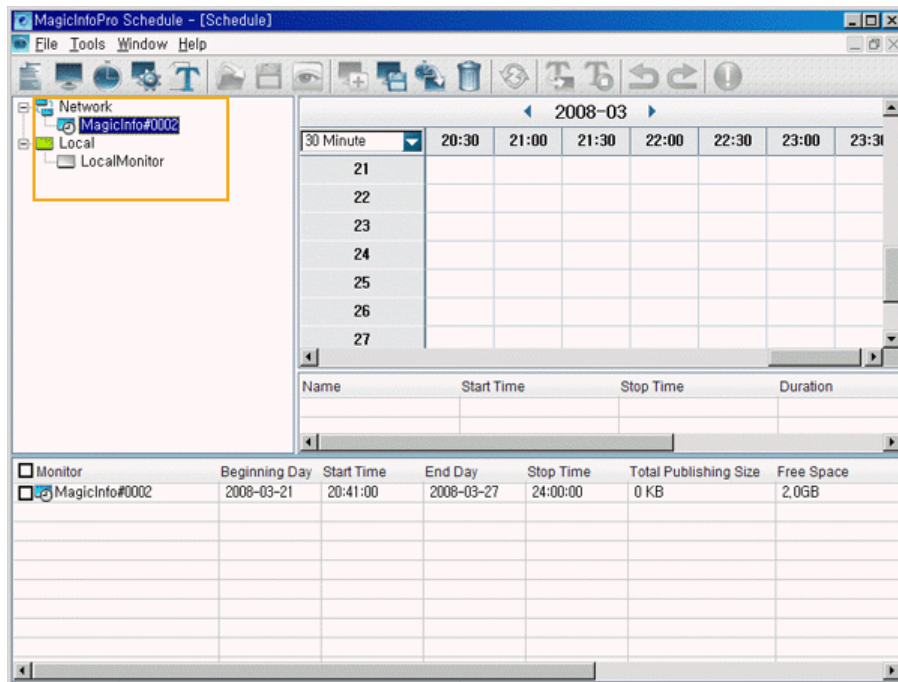

- Network: A monitor which is connected to the server over a network.

- ▤ New Group: Creates a new group that can include some networked monitors. You can drag and drop a networked monitor to a group.
- ▤ Copy/Paste: Copies all the schedules configured on the selected monitor to the clipboard and pastes them to another monitor.
- ▤ Rename: Changes the name of a monitor connected to the server.
 - ⊕ You cannot use a name already used for another monitor.
- ▤ Delete: Deletes a monitor which is not connected to the server.
- ▤ Power On: Turns the selected monitor on or off.
 - ⊕ If the server and the monitor are on a private network, the Power On function cannot be operated on that monitor. However, if there is content server operating on the same subnet, the Power On function can be used.
- ▤ Remote Access: Allows you to remotely control a monitor connected to the server via VNC.
 - ⊕ The Remote Access function can degrade the performance of the server and the monitor.
 - ⊕ The Remote Access function does not support monitors on a private network. In addition, you cannot watch movies on the monitor which are played in overlay mode.
- ▤ Operating Mode: Changes the mode of a monitor connected to the server (Player / Scheduler).

● Local

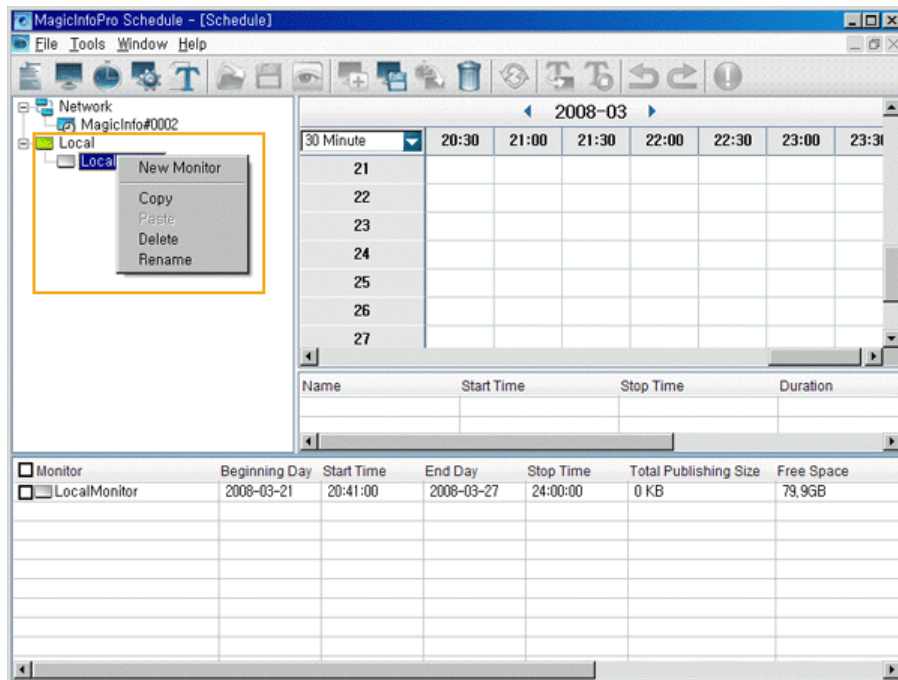

- This is a virtual monitor used to create schedules for a monitor used without being connected to the network. Local publishing can be performed for a local monitor to create schedules for it.

- ▤ New Monitor: Creates a new virtual local monitor.
- ▤ Copy / Paste: Copies the schedules set on the selected monitor and pastes them to another monitor.
- ▤ Rename: Renames the selected monitor.
- You cannot use a name already used for another monitor.
- ▤ Delete: Deletes the selected monitor.

● EPG View

You can edit the schedule by selecting the monitor and time to schedule and register screens. You can move a registered screen by dragging & dropping it and changing the registered time by double-clicking it.

- You can change the screen times using your mouse and by the minimum unit on the time axis. You can change the detailed times in the list view. If you select a monitor group in the tree view, the screen configured for all the monitors is displayed. The screen can be displayed by the day. If you select a monitor in the tree view, the screen for it is displayed. The date can be changed by the months.

● EPG

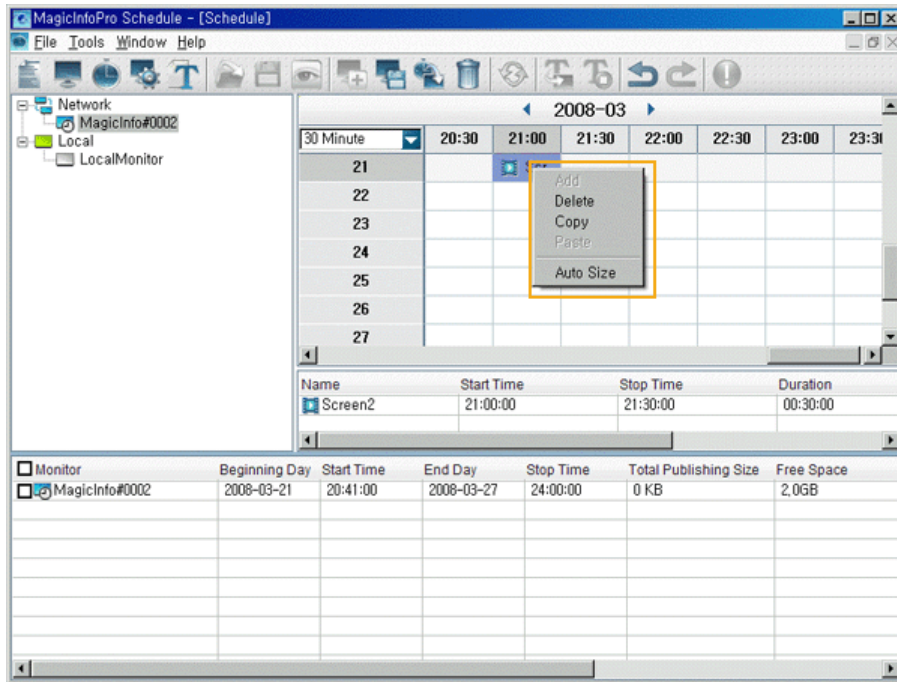

- ▤ Add: Adds the screen you wish to schedule after selecting a monitor and time by clicking in the EPG window.
- ▤ Delete: Deletes the screen currently selected in the EPG window.
- ▤ Copy / Paste: Copies the currently selected screen and pastes it after selecting a monitor and time by clicking in the EPG window.
- ▤ Auto Size: Changes the currently selected screen in accordance with the time of the background set when editing automatically.
- ▤ Time Combo Box: Changes the unit of the time axis to be currently displayed. (1/5/10/30/60/120 Min)

● List View

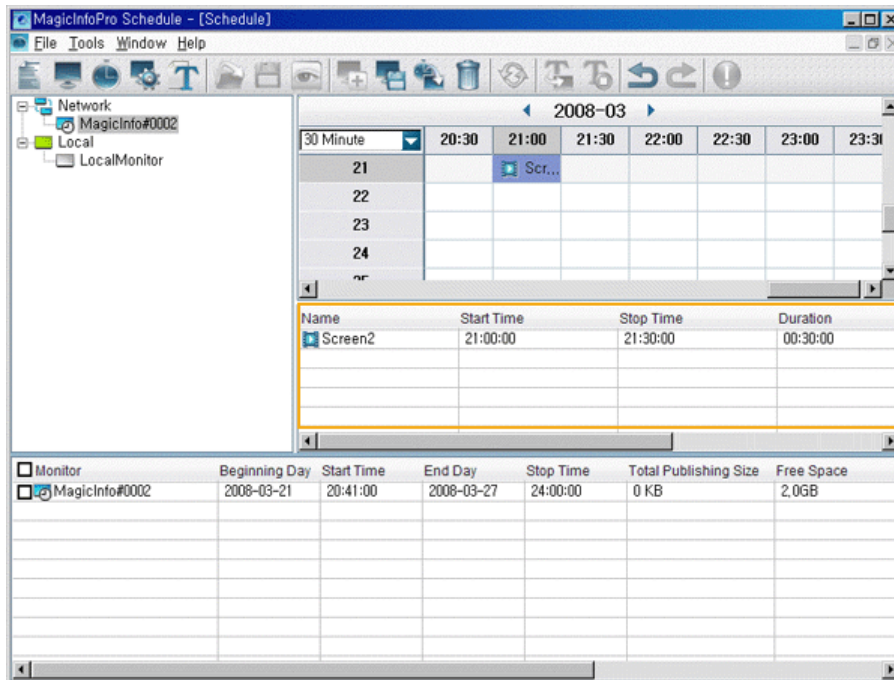

- Sets the detailed items for the selected screen by double-clicking on the screen or by clicking the created buttons.

- Name: Changes the name of the selected screen. Only the screen name changes and the time information is retained.
- Start Time / Stop Time / Duration: Sets the time information for the selected screen in minutes.
- Periodic: Sets how frequently the selected screen recurs. (None / Daily / Weekly / Monthly)
- End on: Sets an end date for the selected schedule to recur.

● Publish View

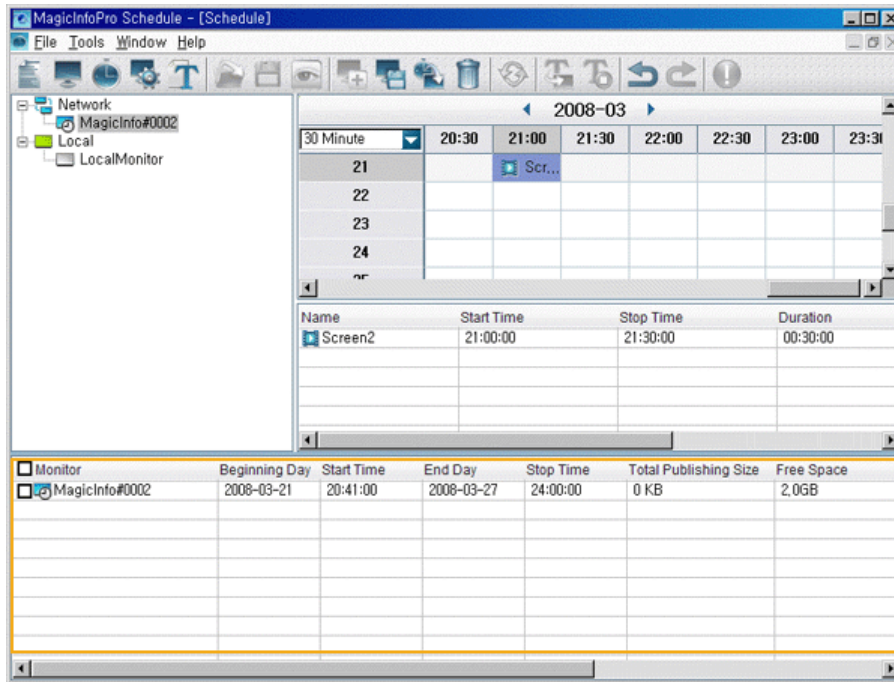

- Publishes the schedules which are configured by the EPG view and the List view to the checked monitors.
 - Beginning Day/ Start Time / End Day / Stop Time: Sets the time information for the schedules to be published to the monitors. Only the screens within the specified period can be published.
 - Total Publishing Size: Indicates the total size of all the screens within the specified publishing period. This is the total size of the files whose play mode is set to Download in all screens. However, for a local monitor, the size of the files whose play mode is set to Stream is included too.
 - Free Space: Indicates the size of the files the monitor can download while publishing. If the total publishing size is larger than the free size, publishing cannot be performed. However, if you change the Maximum Publishing Size option in the Schedule tab in the Server Option, schedules can be published regardless of the available free size.
 - Status: Displays the publishing progress as a percentage on the slide bar. This is the percentage of the size of the files downloaded to the monitor compared to the total screen (file) size.
 - Result: Displays the publishing results. Double-click the schedule or click this button to view the detailed publishing information.

 Remote Management

 File Menu

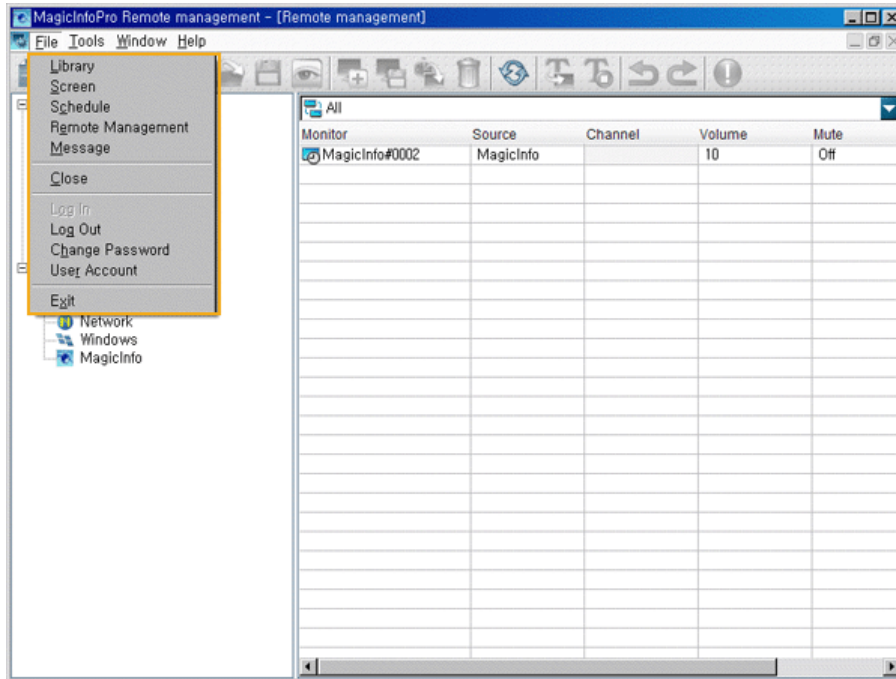

- **Library / Screen / Schedule / Remote Management / Message**
 - Creates a view or selects a created view for each menu item so that you can perform a screen schedule and have basic control over the monitors from the server.
- **Close**
 - Closes the screen view you are working in. If there are unsaved changes, a new window is displayed so that you can save them.
- **Log In**
 - You must log onto the server before you can use any one of its functions. You can log onto the server to run a server program. The password you enter when installing MagicInfo Pro becomes the password of the Administrator account by default.
- **Log Out**
 - Once you are logged onto the server, you can log out. If you log out from the server, all created views are closed and if there are any unsaved changes, a new window is displayed so that you can save them.
- **Change Password**
 - Changes the password of the currently logged-in account.
- **User Account**
 - Creates, deletes and changes the user accounts that can log onto the server. There are two types of accounts that can be created: Administrator and User Accounts.
 - Administrator : Has privileges for all server functions.
 - User : Has privileges for all functions except for changing the server options and user account features.
- **Exit**
 - Exits the program. If there are any unsaved changes, a new window is displayed in which you can save the changes.

● Tree View

Displays various control items for the client in a tree view. If you select an item, the current state of the selected item is displayed and you can control it in the list view.

● MDC

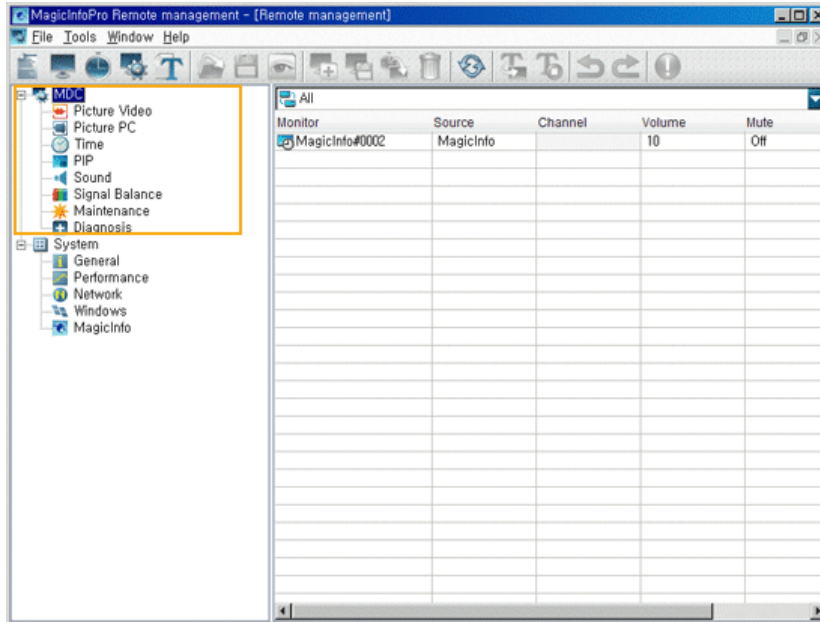

- Displays the items for which remote management is required from among the OSD menus of each client monitor in a tree view. If you select an item, the current state of the selected item is displayed and you can control it in the list view.
- Detailed Items
 - ▣ MDC: Displays the current state of the external source, channel, volume, mute and panel which are the basic items for controlling the client. You can control them in the list view.
 - Changing the Channel (460TXn Only)
 - TV Type Selection: The TV Type is determined by selecting either Digital TV or Analog TV at the MDC source. If you select Digital TV in the MDC Source screen and change the channel, a red part is displayed in the Channel Selection screen so that you can change the sub channel too. (460TXn Only)
 - Channel Type Selection: You can select general or cable broadcasting. (460TXn Only)
 - Channel Selection: You can select the channel for the selected TV. (460TXn Only)
 - (TV: General broadcasting channel range - 2~69, Cable broadcasting channel range 1, 14~135)
 - (DTV : Main channel - 0 to 999, Sub channel - 0 to 999)
 - ▣ Picture Video: Displays the current state of the Video mode (AV, S-Video, Component, DVI (HDCP), HDMI). You can control it in the list view.
 - ▣ Picture PC: Displays the current state of PC mode (PC, BNC, DVI, MagicInfo). You can control it in the list view.

Time : Sets the current time and displays the state of the on and off timers. You can control each item by clicking on it and changing the setting in the list view.

-Current Time

- 1) Hour: Enter the hour.
- 2) Minute: Enter the minutes.
- 3) AM/PM: Enter AM or PM.

-On Timer

- 1) Hour: Enter the hour.
- 2) Minute: Enter the minutes.
- 3) AM/PM: Enter AM or PM.
- 4) Status: Select whether to use the turn-on time.
- 5) Source: Select the external input
- 6) Volume: Select the volume

-Off Timer

- 1) Hour: Enter the hour.
- 2) Minute: Enter the minutes.
- 3) AM/PM: Enter AM or PM.
- 4) Status: Select whether to use the turn-on time.

- ↳ PIP: Displays the PIP information. You can control it in the list view.
- ↳ Sound: Displays the current sound state. You can control it in the list view.
- ↳ Signal Balance: Displays the current signal balance state. You can control it in the list view.
- ↳ Maintenance: Displays the Lamp Control, Safety Screen, Video Wall, VideoWall Format, and Safety Lock state. You can control them in the list view.
- ↳ Diagnosis: Displays whether each client is normal or not. You can control the max. internal temperature of each client using the list view.

System

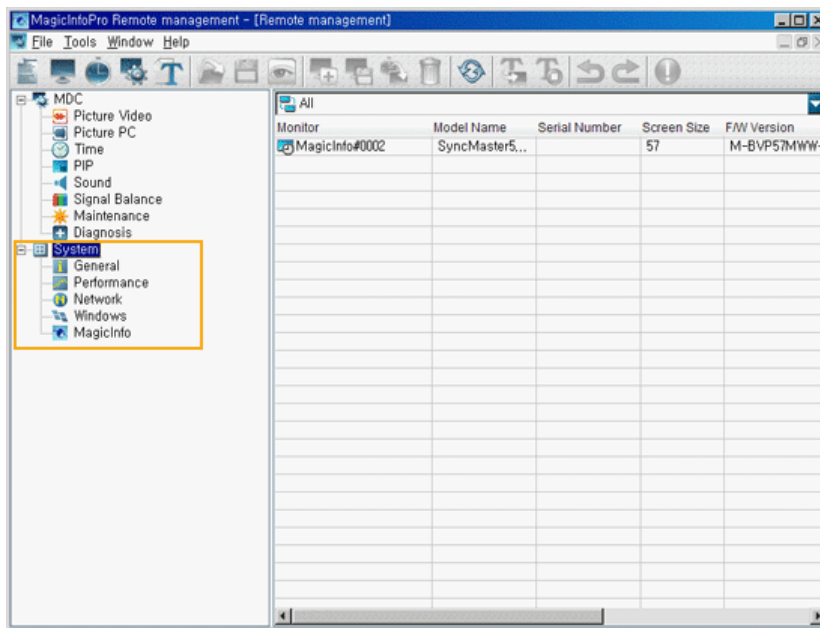

- Displays the items required to manage the client in the tree view separately from MDC. If you select an item, the current state of the selected item is displayed and you can control it in the list view.
- Detailed Items
 - └ System: Displays the product information for the client in a list view.
 - └ General: Displays general information for the client, such as the computer name and username, etc. in the list view.
 - └ Performance: Displays the current performance information for the client, such as the CPU and network usage in the list view.
 - └ Network: Displays the network information in the list view. You can set the IP address.
 - └ Windows: Displays the information related to the operating system, such as EWF and Rotation, etc. You can control them in the list view
 - └ MagicInfo Pro: Displays the status for the MagicInfo Pro client. You can control it in a list view.

List View

Displays the detailed functions for each item selected in the Tree View. You can control them by using the context menu and clicking each detailed function. In addition, you can update the current state using Refresh from the Tool menu and in the toolbar.

MDC

- Displays the items for which remote management is required from among the OSD menus of each client monitor in a tree view. If you select an item, the current state of the selected item is displayed and you can control it in the list view.
- Detailed Items
 - └ MDC: Displays the current state of the External source, channel, volume, mute and panel. You can control each item by clicking on it and changing the setting in the list view.
 - For channels, only when the input source is TV, can you display or control the setting. (Only applicable for monitors that support TV.)
 - └ Picture Video: Displays the current state of the Mode, Contrast, Brightness, Sharpness, Color, Tint, Color Tone, Color Temperature, Size, Digital NR, and Film Mode. You can control each item by clicking it and changing the setting in the list view.
 - This item is only available in video mode (AV, S-Video, Component, DVI(HDCP), HDMI).
 - The Contrast, Brightness, Sharpness, Color, and Tint items are only available in custom

mode.

- The Color Temperature item is only applicable if the Color Tone item is turned off.
 - The Auto Wide option for the Size item is only available in TV mode. (Only applicable for monitors that support TV.)
- Picture PC: Displays the current state of MagicBright, contrast, brightness, color tone, red, green, blue, color temp, and size. You can control each item including Auto Adjustment by clicking it and changing the setting in the list view.
- This item is only available in PC mode (PC, BNC, DVI, MagicInfo).
 - The Contrast and Brightness items are only applicable if MagicBright is in Custom mode.
 - The Red, Green, and Blue items are only applicable if the Color Tone item is set to Custom.
 - Color Temperature is only applicable if the Color Tone item is turned off.
 - To perform Auto Adjustment, click the displayed button.
- Time: Configures the current time and displays the state of the on and off timers. You can control each item by clicking it and changing the setting in the list view.
- PIP: Displays the external input and the size for the PIP. You can control each item including the position of the PIP, and Swap by clicking on it and changing the setting in the list view.
- The Position and Swap items are write-only. Their existing settings cannot be read. You have to set them directly when needed.
 - Each item is only enabled if the Size item is set to a setting other than Off.
 - You can turn the PIP on by setting the Size item to a setting other than Off.
- Sound: Displays the current state of the Sound Mode, Bass, Treble, Balance, SRS TSXT, and Sound Select. You can control each item by clicking on it and changing the setting in the list view.
- The Bass, Treble, and Balance items are only applicable if the Sound Mode item is set to Custom.
- Signal Balance: Displays the information for the Signal Balance On/Off, R Phase, G Phase, B Phase, Gain, and Sharpness. You can control each item by clicking on it and changing the setting in the list view.
- The R Phase, G Phase, B Phase, Gain, and Sharpness items are only applicable if the Signal Balance item is set to On.
- Maintenance: Displays the state of the Lamp Control, Screensaver, Screen Matrix Display, Screen Settings, and Safety Lock. You can control each item by clicking it and changing the setting in the list view.

● Lamp Control

Auto	Hour	Minute	AM/PM	Value
Max	1	00	AM	0
Min	1	00	AM	0

Manual [Slider: 100] [Apply]

1) Automatic

- Hour: Enter the hour to apply the lamp adjustment. (Maximum and minimum values)
- Minute: Enter the minute to apply the lamp adjustment. (Maximum and minimum values)
- AM/PM : Select AM or PM to apply the lamp adjustment. (Maximum and minimum values)
- Value : Select the value to apply the lamp adjustment. (Maximum and minimum values)

2) Manual - Select a value to apply to the lamp by moving the slider.

● Safety Screen

Interval: Off | Second: Off | Type: []

[Apply]

- 1) Interval: Enter the time interval when the screensaver is activated.
- 2) Second: Enter the duration the screensaver will run.

3) Type: Enter the type of screensaver.

• Video Wall

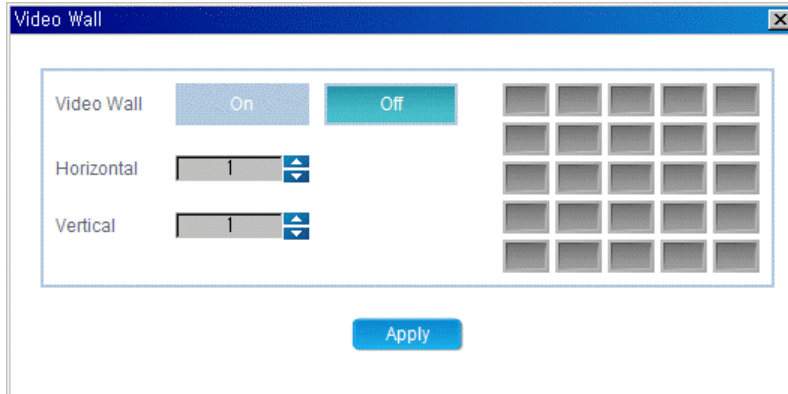

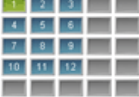
- 1) Video Wall: Select whether to activate the video wall.
- 2) Horizontal: Set how many parts the screen is divided into horizontally.
- 3) Vertical: Set how many parts the screen is divided into vertically.
- 4) : Select the area that the monitor will display.

- The Screen Settings only operate when the Screen Matrix Display function is activated.
- ▢ Diagnosis: Displays whether the lamp, internal temperature of the client, brightness sensor and fan are normal, and displays the current and maximum temperatures. You can control the maximum temperature by clicking on it and changing the setting.
 - An error is displayed if the maximum temperature is lower than the current temperature.

• Context Menu

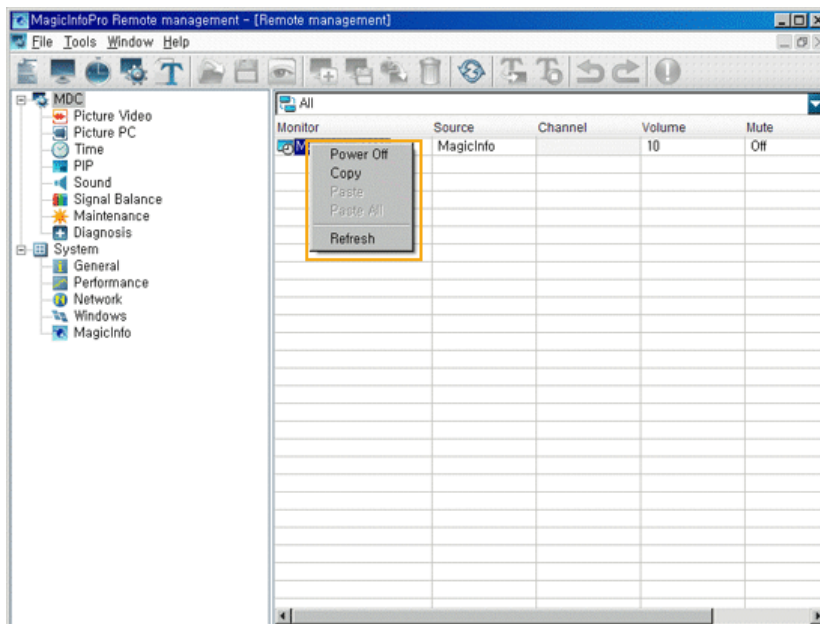

- ▢ Power On/Off: This item is only enabled when a monitor name is selected and used to turn the client (monitor) on or off.
- ▢ Copy: Copies the settings of the selected item.
 - If you select a monitor name and click Copy, all the items displayed in the list are copied.
 - If you select an item and click Copy, only the item is copied.
 - If the setting is not yet displayed or the item has no setting, the item cannot be copied.
 - You cannot copy write-only items.
- ▢ Paste: Pastes the copied setting to the monitor.
 - Only available if the copied item is the same as the currently selected item.
 - Only available if the client is turned on.
- ▢ Paste All: Pastes the copied settings to all the monitors displayed in the current list.
 - Can only operate when the copied item is the same as the currently selected item.
 - Can only operate when the client turns the power on.
- ▢ Refresh: Refreshes the items for the selected monitor.

System

- Displays the items required to manage the system properties of the client in a tree view. You have to set the settings for each item by double-clicking the client or using the Edit item from the context menu, instead of selecting each item and setting a value as in MDC.
- Detailed Items
 - ▢ System: Displays the information for the model name, serial number, screen size, firmware version, MagicInfo Pro version, and OS image version.
 - ▢ General: Displays the specifications and name of the computer and the information for the work group, user, and product key.
 - ▢ Performance: Displays the CPU, network, memory, and disk usage.
 - ▢ Network: Displays the information for the Network Adapter, MAC Address, IP Address Type, IP Address, Subnet Mask, Default Gateway, Preferred DNS Server, Alternate DNS Server. You can change the settings by double-clicking the monitor name or using the Edit item from the context menu.

Network Setup

Network Adapter Generic Marvell Yukon Chipset based Et

Mac address 00-12-fb-02-13-41

Obtain an IP address automatically

Use the following IP address

Use the following IP address

IP address 0 . 0 . 0 . 0

Subnet mask 0 . 0 . 0 . 0

Default gateway 0 . 0 . 0 . 0

Preferred DNS server 0 . 0 . 0 . 0

Alternate DNS server 0 . 0 . 0 . 0

OK Cancel

- Network Adapter: Displays the network adapter for the selected client.
- Mac Address: Displays the MAC address of the selected client.
- Obtain an IP address automatic : Select an IP address type.
- Use the following IP address
 - IP Address: Enter the IP address.
 - Subnet mask: Enter the subnet mask.
 - Default gateway: Enter the address of the default gateway.
 - Preferred DNS server: Enter the address of the preferred DNS server.
 - Alternate DNS server: Enter the address of the alternate DNS server.
- The Network Adapter and Mac Address items cannot be changed.



Window: Displays the information for the EWF, screen rotation, screen resolution, and system messages. You can change the settings by double-clicking the monitor name or using the Edit item from the context menu.

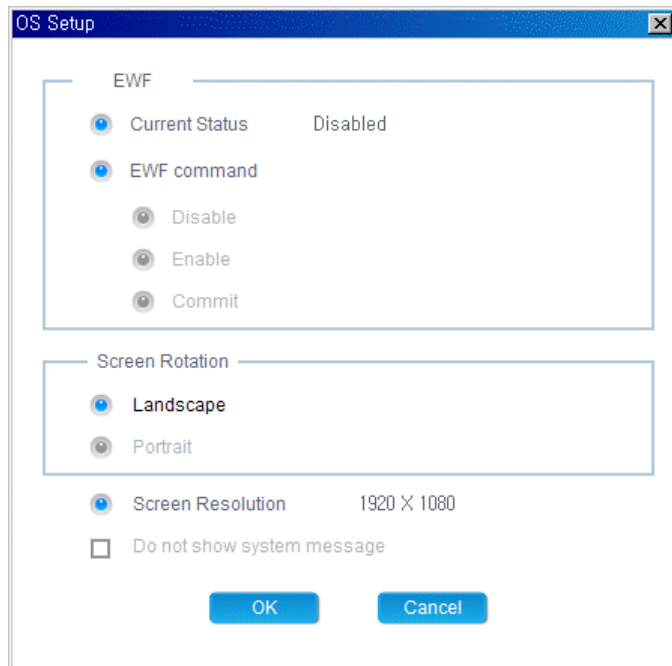

- 1) Current Status: Displays the current EWF status of the selected client.
- 2) EWF command: Changes the EWF status of the selected client.
- 3) Screen Rotation: Selects the screen direction of the selected client.
- 4) Screen Resolution: Displays the resolution of the selected client.
- 5) System message: Selects whether to display a system message for the selected client.
- 6) The Current Status and Screen Resolution items cannot be changed.

- MagicInfo Pro: Displays information for the Startup, Automatic update, Use password lock, and Content server. You can change the settings by double-clicking the monitor name or using the Edit item from the context menu.

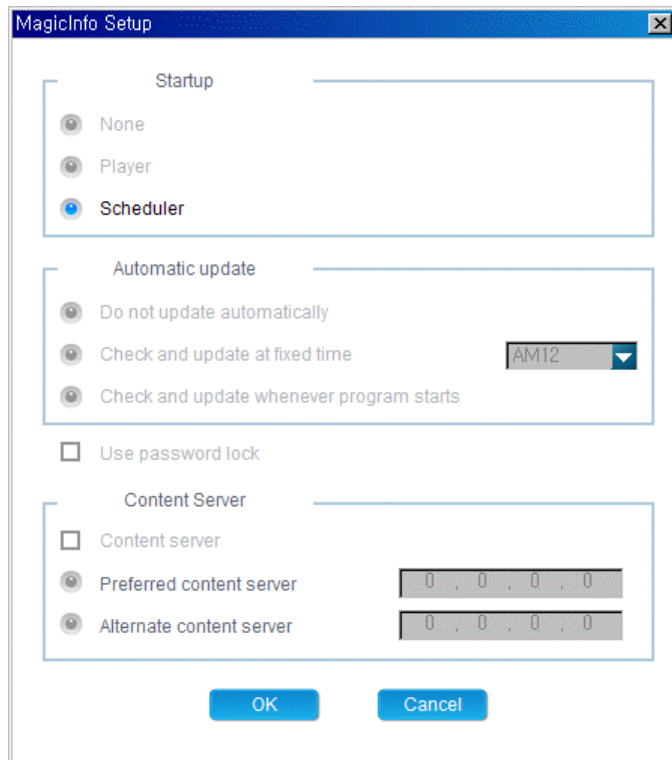

- 1) Startup: Select the program to be performed when the client starts.
- 2) Automatic update: Select how to perform automatic updates.
- 3) Use password lock: Select whether to use the password lock.
- 4) Content Server: Select whether to use the content server.
- 5) Preferred content server: Enter the IP address of the preferred content server to use a content server.
- 6) Alternate content server: Enter the IP address of the alternate content server which will be used when the preferred content server does not operate.

Context Menu

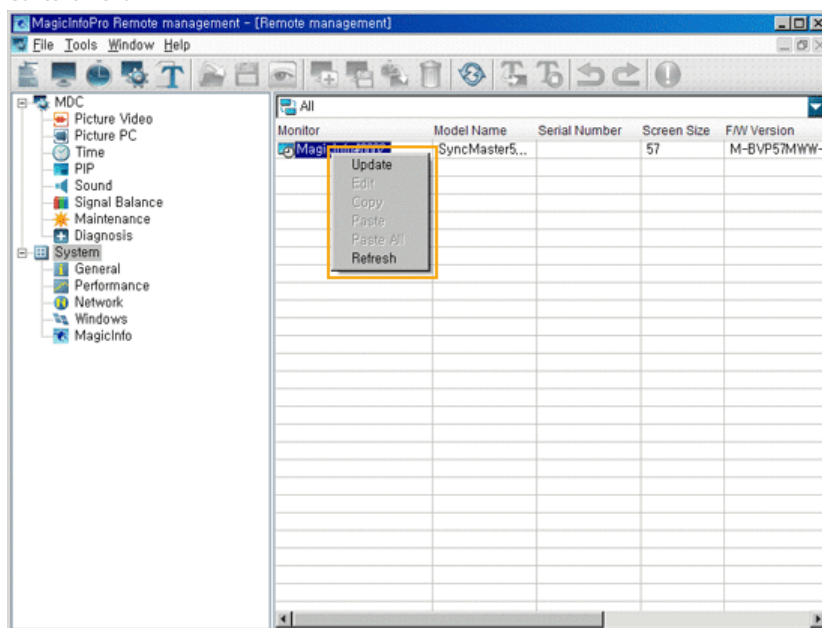

Update: This item is only enabled if a monitor name is selected. This item compares the client version to the update version on the server and updates the client if required.

Edit: Displays a window so that you can change the monitor settings.

- For the System, General, and Performance items, the settings are read-only so they are disabled.

Copy: Copies the settings of the selected item.

- If you select a monitor name and click Copy, all the items displayed in the list are copied.
- If you select an item and click Copy, only the item is copied..
- If the setting is not yet displayed or the item has no setting, the item cannot be copied.
- The System, General, Performance, and Network items cannot be copied.
- The screen resolution item of Windows cannot be copied.

Paste: Pastes the copied setting to the monitor.





- Only available if the copied item is the same as the currently selected item.
- Only available if the client is turned on.

Paste All: Pastes the copied settings to all monitors displayed in the list.

- Only available if the copied item is the same as the currently selected item.
- Only applied to clients which are turned on.

Refresh: Refreshes items for the selected monitor.

Monitor Status

- : The server is connected to the monitor in Player mode.
- : The server is connected to the monitor in Scheduler mode.
- : The server is connected to the monitor in an unknown mode.
- : The server is not connected to the monitor or the monitor is a local monitor.

Combo View

- Displays all monitor groups except for local monitor groups so you can select a group.
- If you select a group, a list of clients in the group is displayed in the list view.

 Message

 File Menu

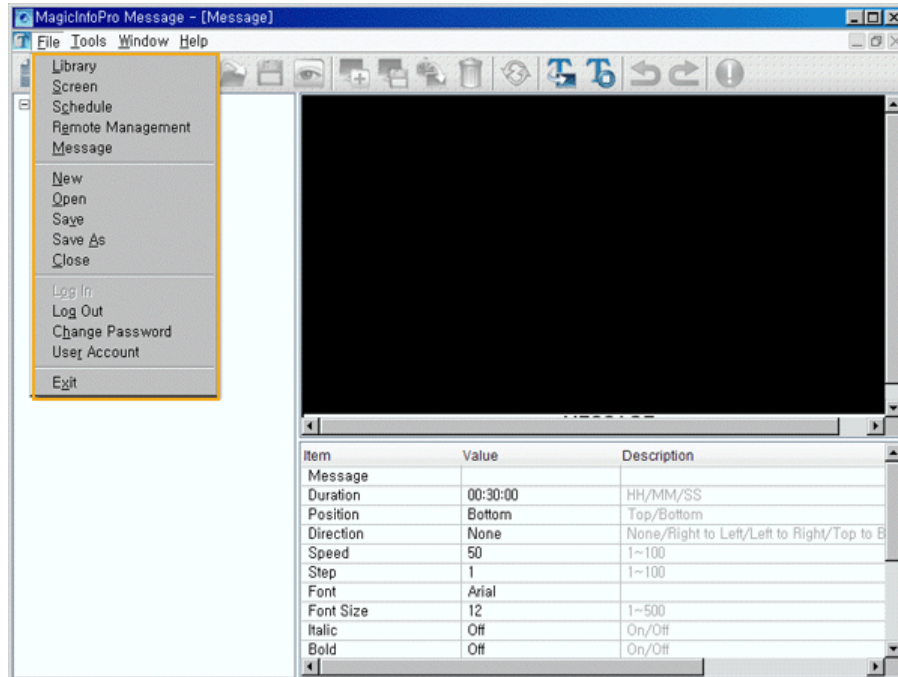

- Library / Screen / Schedule / Remote Management / Message
 - Creates a view or selects a created view for each menu item so that you can run a screen schedule and perform basic control for the monitors from the server.
- New
 - Initializes the message view you are currently working with. If there are any unsaved changes, a new window is displayed so that you can save them.
- Open
 - Opens a message file. If there are any unsaved changes, a new window is displayed so that you can save them.
- Save / Save As
 - Saves the changes in the current message file or as a new message file.
- Close
 - Closes the message view you are currently working with. If there are any unsaved changes, a new window is displayed so that you can save them.
- Log In
 - You must log in to the server before you can use any one of its functions. You can log in to the server to perform a server program. The password you enter when installing MagicInfo Pro becomes the password of the Administrator account by default.
- Log Out
 - Once you are logged into the server, you can log out. If you log out from the server, all created views are closed and if there are any unsaved changes a new window is displayed so that you can save them.
- Change Password
 - Changes the password of the currently logged-in account.
- User Account
 - Creates, deletes and changes the user accounts that are able to log into the server. There are two types of accounts that can be created: Administrator and User accounts.
 - Administrator: Has privileges for all server functions.
 - User: Has privileges for all server functions except for changing server options and

user account features.

- Exit
 - Exits the program. If there are any unsaved changes, a new window is displayed so that you can save them.

●●●●●●●●●● Tool Menu

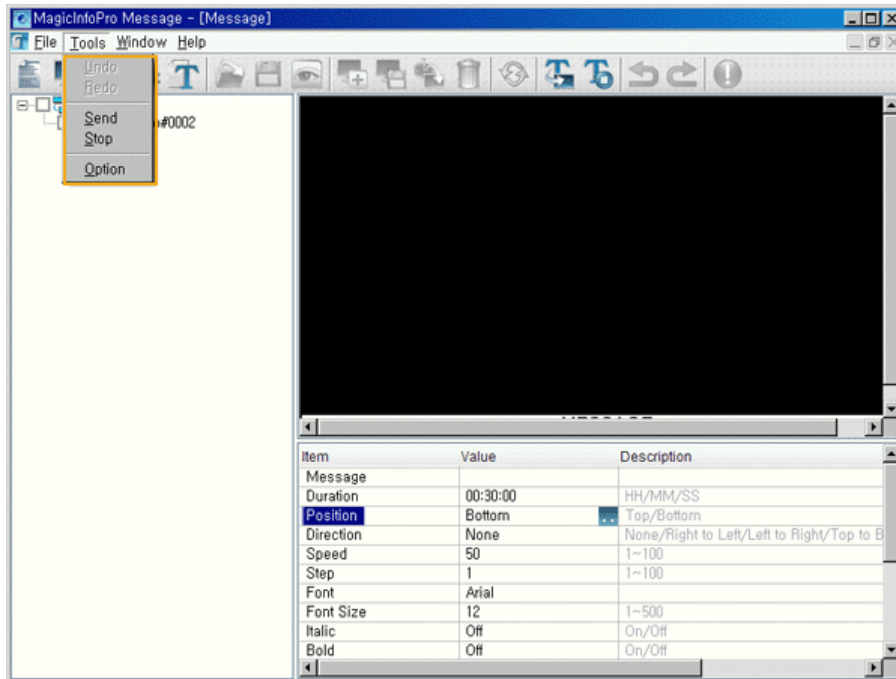

- Undo / Redo
 - Cancels the previously performed command or performs the canceled command again. You can change the maximum number of commands that you can undo using the Option menu.
- Send / Stop
 - Checks the edited message data in a tree view and sends (or stops) them to the selected monitor.
- Option
 - Changes the server settings. Refer to the Option tab for more information.

●●●●●●●●●● Message

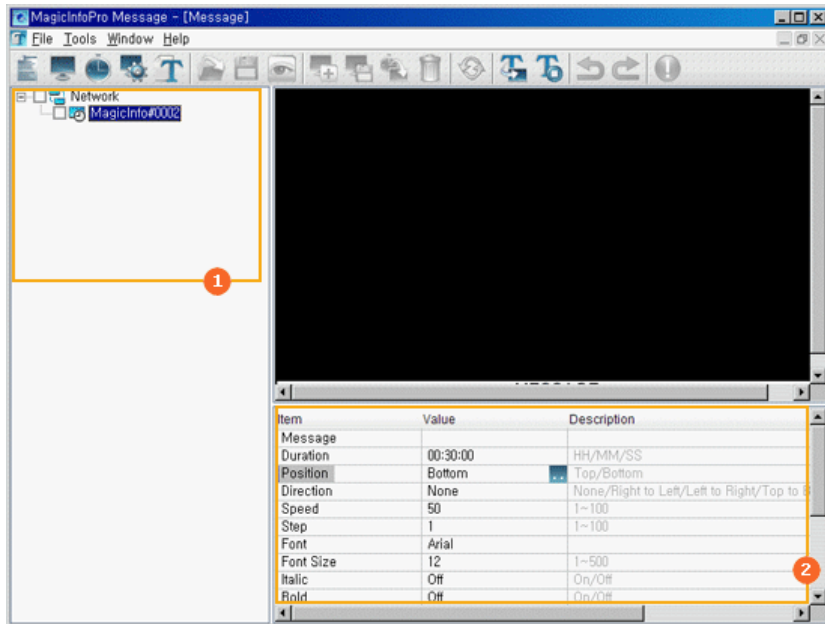

- 1 Tree View
- 2 List View

● Tree View

You can select the monitors to which the message is sent by checking the checkbox next to each monitor and group.

● List View

Changes the detailed functions for the message to be sent to the monitors by double-clicking it or by clicking the created button.

- Message: Sets a message to be displayed on the monitor.
 - ⊕ The set message is not applied to the preview window.
- Duration: Selects the time of the message to be displayed on the monitor in minutes.
- Position: Selects the location of the message to be displayed on the monitor. (Top / Bottom)
- Direction: Sets the direction of the message flow on the monitor. (None / Right to Left / Left to Right / Top to Bottom / Bottom to Top Text)
- Speed: Sets the speed of the message flow on the monitor.
- Step: Sets the interval at which the message flows on the monitor.
- Font, Font Size, Italic, Bold, Underline, Strikeout, Font Color: Sets the font formatting for the message to be displayed on the monitor.
 - ⊕ The font type shows the font of the computer where the server is operating. The same font must be installed on the monitor so that it can display the font.
- Align Horizontal: Aligns the text in the message to be displayed on the monitor.
- Background Color: Selects the background color for the message to be displayed on the monitor.
- Transparency: Selects the degree of transparency to be used for the message to be displayed on the monitor. (On / Off)

 Option

 Option

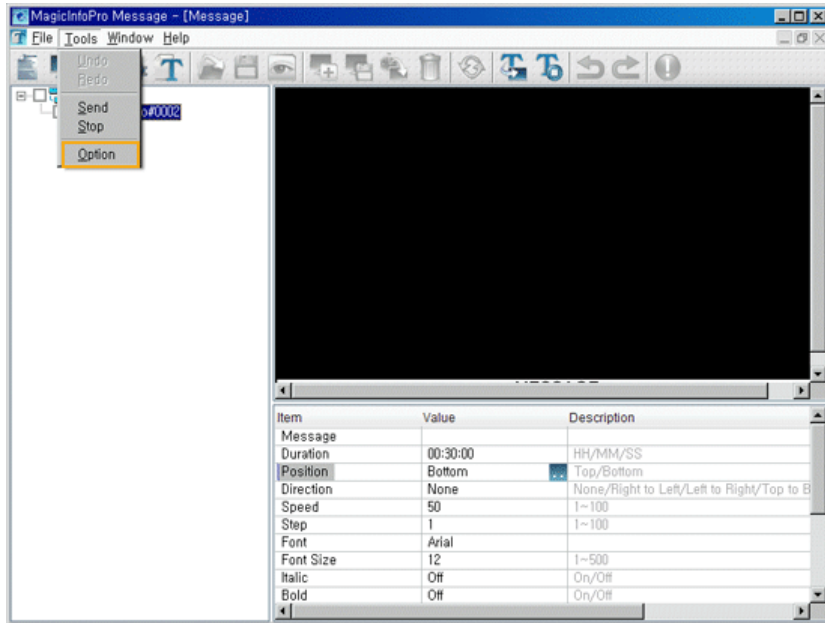

 General

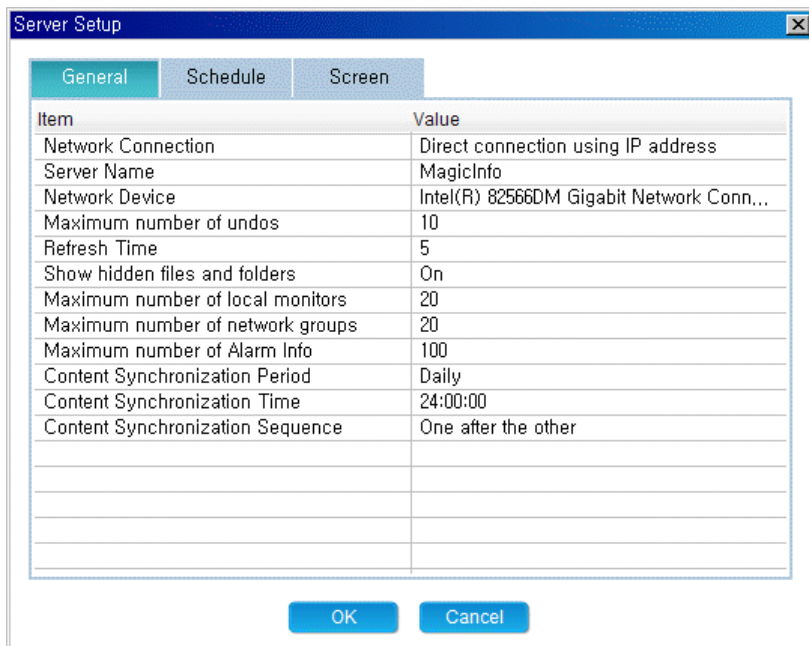

 Network Connection: Selects the connection method between the server and the monitor. The server and monitor can be connected to each other only if the same connection method is used.

- Automatic connection: The monitor automatically connects a server on the same network.

- Direct connection: The monitor directly connects to the server with the specified IP address.
- If the server and monitor are on a different private network, they cannot connect to each other. However, if the server has a public IP address, a monitor with a private IP address can be connected to it using the direct connection method.
- ▮ Server Name: Changes the server name.
 - The server and monitor can connect to each other only if their server names are the same.
- ▮ Network Device: Selects the LAN card used in the server.
 - If there are more than one available LAN cards on the PC, a window that allows you to select a LAN card to use when the server starts for the first time.
- ▮ Maximum number of undos: Selects the maximum number of previous operations you can cancel.
- ▮ Refresh Time: Sets the frequency of the server receiving monitor data for updating in Remote Management. When set to 0, the server does not update the monitor data automatically and you have to click Refresh in the tool bar or from the menu to update the monitor data.
- ▮ Show hidden files and folders: Shows files with the hidden attribute on the server computer in the library.
- ▮ Maximum number of local monitors: Sets the maximum number of virtual local monitors that can be created for publishing the schedule locally.
- ▮ Maximum number of networking groups: Sets the maximum number of network groups that can be created to manage the networked monitors.
- ▮ Maximum number of Alarm Infos: Specify the number of warning messages that can be stored which notify the user of client errors. If more than the specified number of errors occurs, older messages are deleted.
- ▮ Content Synchronization Period: Sets the time interval for synchronization of the content server.
- ▮ Content Synchronization Time: Sets a time to synchronize the content server. However, synchronization is performed at the time set on the client.
- ▮ Content Synchronization Sequence: Sets the order in which the content is synchronized.

● Schedule

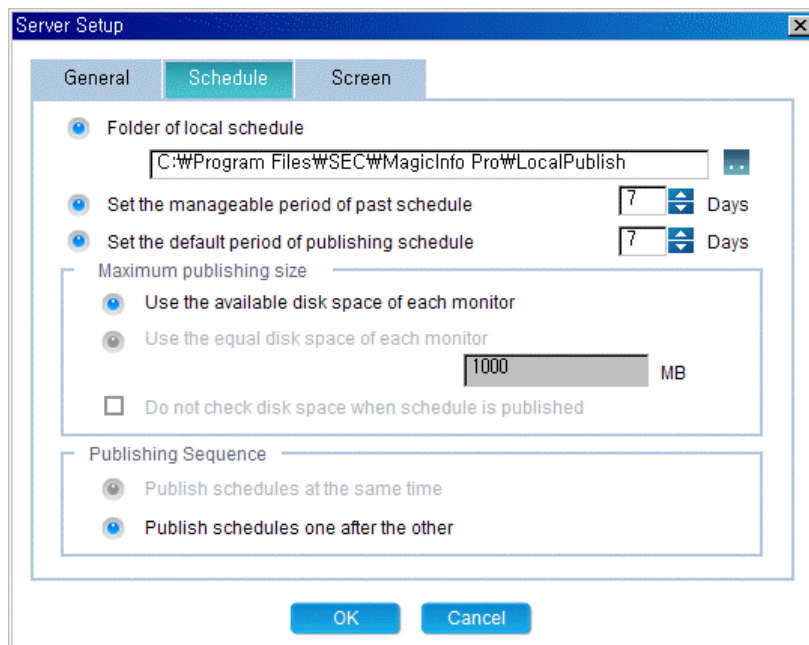

- ▮ Folder of local schedule: Sets the directory in which local schedules are created using a virtual local monitor. The default value is the folder where the server is installed.
- ▮ Set the manageable period of past schedules: Sets the period for schedules for which you can register, save and import screens. When set to 0, you cannot register, save or import the screens before the present time.
- ▮ Set the default period of the publishing schedule: Sets the default publishing period for a schedule.
- ▮ Maximum publishing size: Sets the option regarding the free space on the monitor for publishing a schedule.

- Use the available disk space of each monitor: Sets the size to the maximum free disk space of the monitor.
- Use the equal disk space of each monitor: Sets the size to the value entered in the edit box.
- Do not check disk space when schedule is published: Publishing continues even though the total size of the schedules to be published is larger than that of the free disk space of the monitor.

Publishing sequence: Specifies the order when publishing is performed for multiple monitors.

- Publish schedules at the same time: Publishes the schedules to multiple monitors at the same time.
- Publish schedules one after the other: Publishes the schedules to multiple monitors one by one.

Screen

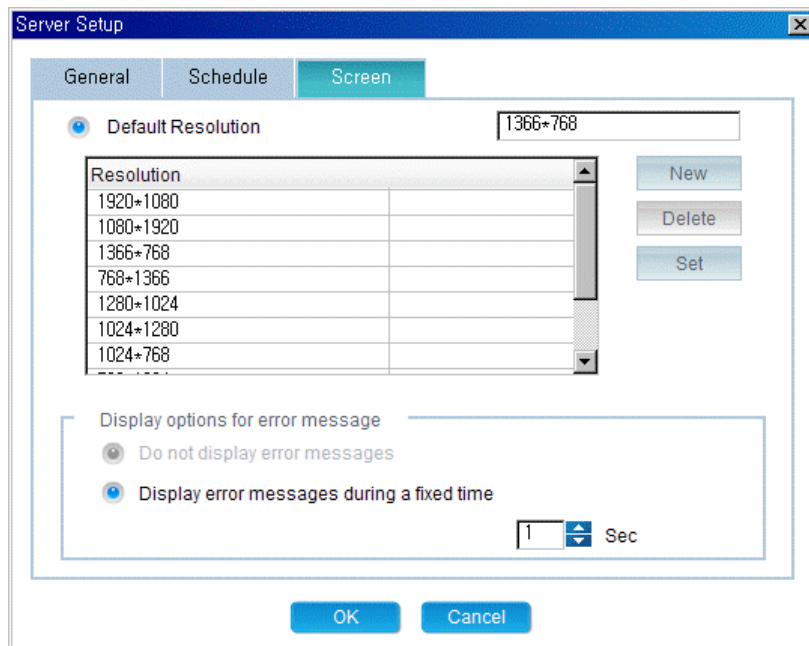

Default Resolution: Adds, deletes and sets the default resolution for a newly created screen.

- New: Adds a new resolution that can be used in a screen. It is added to the list of background resolutions for the screen.
- Delete: Deletes a created resolution. It is removed from the list of background resolutions for the screen.
- Set: Sets the selected resolution as the default resolution.

Display options for error messages: Sets the options for errors that may occur when a screen is previewed.

- Do not display error messages: When an error occurs, the next preview operation continues without an error message being displayed.
- Display error messages during a fixed time: When an error occurs, an error message is displayed for a specified period of time and then is automatically hidden after that period.

 Contents Server

● A program run on the additional PC where the content server is operating.

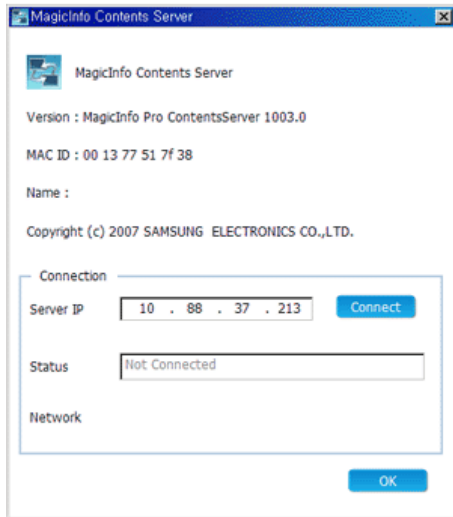

- ▢ Version: The version of the content Server.
- ▢ MAC ID: The MAC address of the network device on the PC where the content server is installed. Used when the MagicInfo Pro Server checks whether it is registered as the content server.
- ▢ Name: The name of the content server configured by the MagicInfo Pro Server.

Connection

- ▢ Server IP: Enter the IP address of the MagicInfo Pro Server you want to connect to. Click the Connect button. The client tries to connect to the MagicInfo Pro Server at the specified Server IP address. If the MagicInfo Pro Server accepts the connection, the client is successfully connected to the server.
- ▢ Status: Displays the connection status for the MagicInfo Pro Server.
- ▢ Network: Displays the network usage.

 Client Functions

● ● ● ● ● ● ● ● ● ● **MagicInfo Pro Client Configurations**



1 About Displays the version.

- 2 **EFW** Displays or changes the drive settings.
- 3 **Password** Manages the password.
- 4 **Setup**
- 5 **Rotation** Rotates the screen with the selected option.
- 6 **Program** Runs or exits the program.
- 7 **Exit** Exits mnMain. If you exit mnMain, MagicInfo Pro and the Schedule program are also exited together.



● **EFW: Displays and changes the Drive settings**

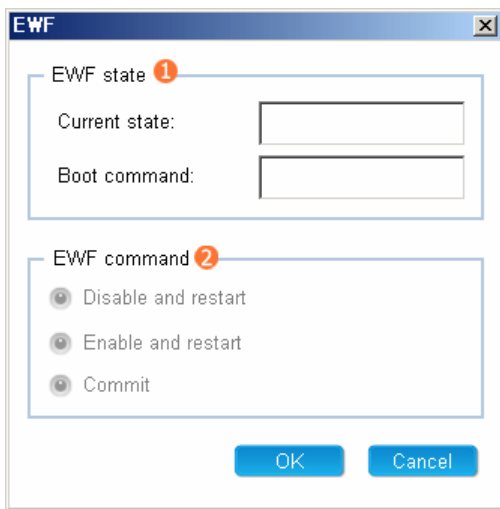

- 1 **EFW State**
 - Current state: Displays the current EWF state.
 - Boot command: Displays the EWF state which will be applied at the next boot-up.
- 2 **EFW command**
 - Disable and restart : Disables and restarts the EWF. The EWF state is actually disabled at the next boot-up.
 - Enable and restart : Enables and restarts the EWF. The EWF state is actually enabled at the next boot-up.
 - Commit : Saves the changes in the Enable state.



● **Password : Manages passwords for existing MagicInfo Pro.**

Verifies the password before you enter the Setup screen. If the Use Password lock checkbox is checked, you need to verify your password again when entering the MagicInfo Pro setup menu.

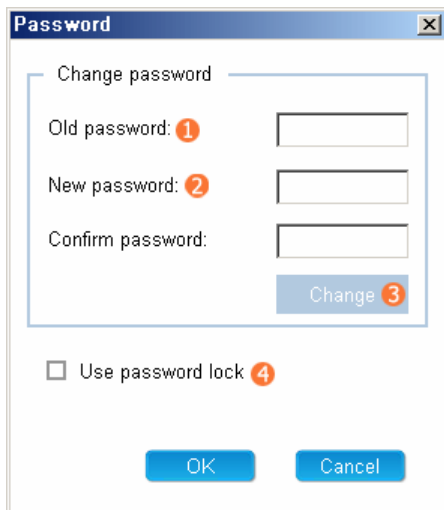

- 1 Old password
 - Enter the existing password.
- 2 New password
 - Enter the new password.
- 3 Change
 - Change the password.
- 4 Use password lock
 - Verifies your password before you enter the Setup screen.

Setup

Connection Tab



- 1 Schedule server
 - Server Connection Settings
 - The client automatically connects to the server.
 - When a connection is disconnected, the client connects to another server automatically.
 - The client connects to the server manually. (Enter the IP address of the server).
- 2 Content server
 - Up to two (2) content servers can be configured.
 - Enter the IP address of the server.
- 3 Name
 - Setting Name

- The ID of the server to connect to
- Client ID



1 Schedule server

- Automatic connection using server name
: If the schedule server and client are on the same sub network, the client connects to the servers using their name.
- Reconnecting another server when disconnected
: If a connection is disconnected, the client connects to another server on the same sub network automatically.
- Direct connection using IP address
: The client connects to the schedule server with the entered IP address.
: The client can connect to the schedule server even though they are not on the same network. However, if the server has a private IP address on a private network, the client cannot connect to it. Therefore, the schedule server must be installed with a public IP address on a network.

2 Content server

- Connect content servers
: Select this option when you want to use separate schedule and content servers.
: If you select this option, all the content files are downloaded or streamed from the specified content server and the schedule server performs only the schedules and the remote control function.
- Preferred IP
: Enter the IP address of the computer that operates as the primary content server.
- Alternate IP
: Enter the IP address of the computer that operates when the primary content server cannot be connected to.

3 Name

- Server
: Enter the name of the schedule server that the client connects to.
- Client
: Set the name of the monitor to connect to the schedule server.

Program Tab

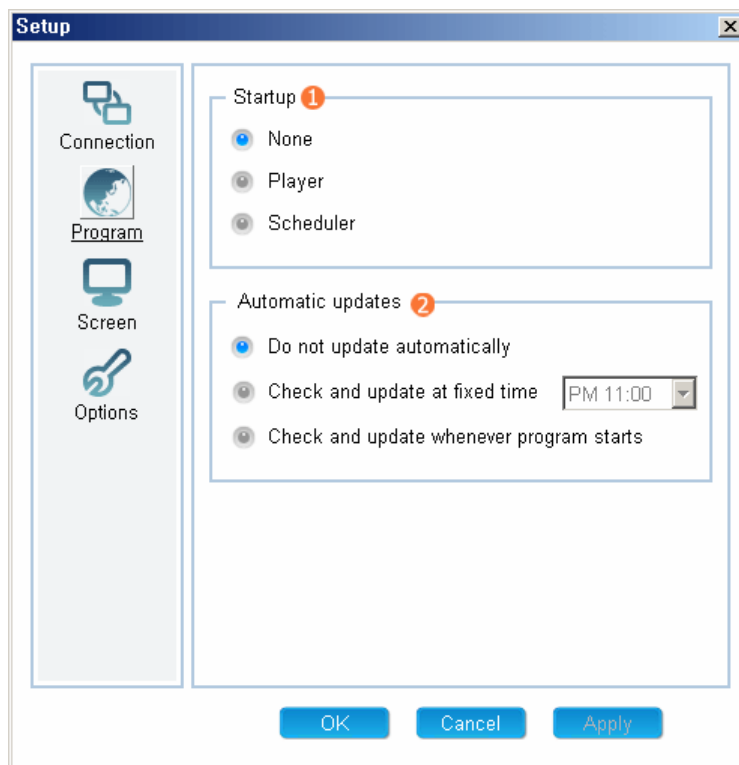

1 Startup

- Select the program performed when the client starts.
- 2 Automatic updates
- Select how to perform automatic updates.



1 Startup

- Sets the program to be performed when the client starts.
- You can select one of two programs, or select neither of them.
- Player: Runs a media player program that can be run using the remote control and can receive and play the content that exists on the server. (MagicInfo Pro)
- Runs the program that displays the information. This program displays a screen that is created on the server at the specified time and can be controlled remotely.

2 Automatic update

- Sets the option for updating the client program automatically.
- Do not update automatically: Updating is not performed automatically.
- Check and update at fixed time: Checks the update version at the specified time every day and updates the client if necessary.
- Check and update whenever the program starts: Checks the update version whenever the program starts and updates the client if necessary.

Screen Tab

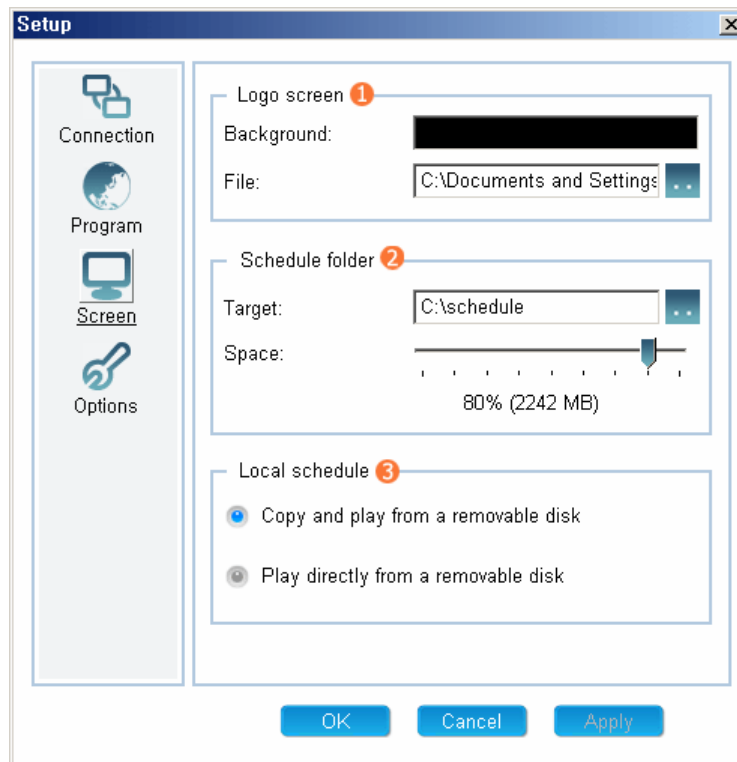

- 1 Logo screen : the main screen of the Signage Scheduler program.
- Background: Sets the background color.
 - File: Sets the logo screen. (A flash, photo, and movie file can be set.)
- 2 Schedule folder : Sets the location of the schedule file.
- Target: Sets the location of the screen design file and content file.
 - Space: Sets the size limit for the files to be downloaded.
- 3 Local Schedule : Sets the local schedule options.
- Copy and play from a removable disk: Copies the schedule file from a USB device to the FDM and then runs it.
 - Play directly from a removable disk: Runs the schedule file directly from the USB device.



1 Logo screen

- Sets the initial screen of the scheduler or the screen to be displayed between schedules.

- Background: Sets the background for the entire screen.
- File: Sets the logo screen to be displayed on the background. (A flash, photo, or movie file can be set.)

2 Schedule folder

- Sets the directory which the content to be scheduled is downloaded to and managed in and manages the size of the disk.
 - Target: Sets the target directory.
(You should set a directory on the D: drive or a removable disk, as the C: drive is used for the system.)
 - Space: Sets the disk size limit used for the schedule. Between 10% to 90% of the available free space can be set.

3 Local schedule

- Sets the options required when you perform a schedule using a USB device instead of the network.
 - Copy and Play from a removable disk
: Copies the schedule that exists on a USB device to the schedule folder and then plays the copied schedule. You can remove the USB device after copying it.
 - Play directly from a removable disk
: Plays the schedule that exists on a USB device directly. If you remove the USB device, the schedule exits.

Options Tab

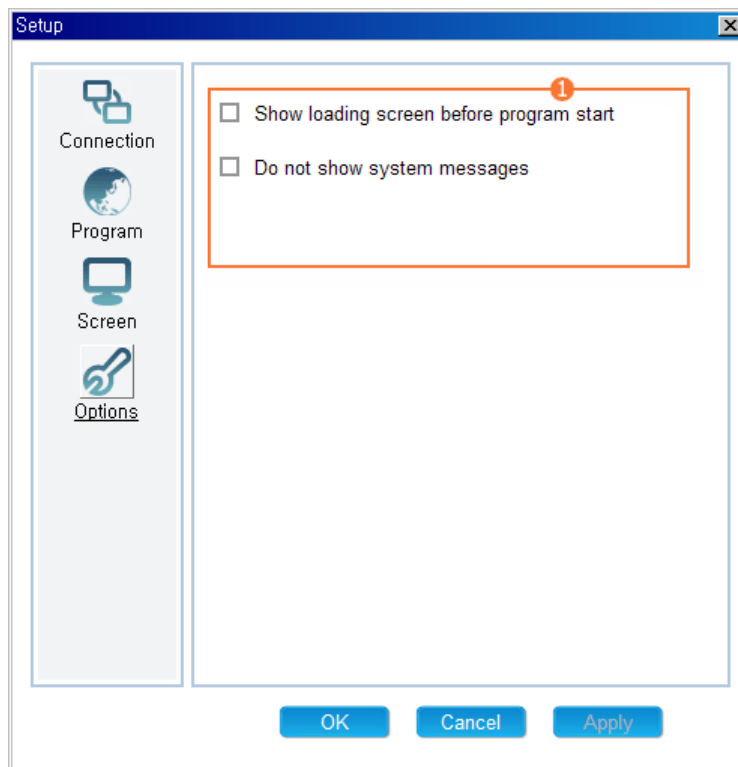

1 Other Options

- Show loading screen before program start: Displays a loading screen from the time after your computer is booted to the time before the main program starts.
- Do not show system message: Do not show the system messages generated by Windows.



Troubleshooting

? When a monitor is not connected to the server



- Check whether the network environment for the server and monitor is normal.. (Check the network cable connections and IP address settings, etc)
- Check whether a correct network card has been selected when there is more than one network card in the PC where the server is operating. (Use the Network Device item in the Server Option window.)
- Check whether the server names used by the server and monitor are the same.
- Check whether the connection methods used by the server and monitor are the same. (Automatic connection using a server name / Direct connection using an IP address)
- If the connection method is set to Automatic connection using a server name, check whether the server and monitor are on the same subnet.
- If the connection method is set to Direct connection using an IP address, check whether the IP address of the server set in the monitor is correct. If the server and monitor are on different networks, the IP address of the server must be a public IP address.
- Check whether the PC prevents the server from accessing the monitor because of the Windows Firewall.

? When the icon next to the monitor name is amber, and not blue which means 'connected normally'



This occurs when the network connection is normal but the connection between the server and the monitor is abnormal. This may also occur when the monitor is connected to a different server or the network state is abnormal. Check the monitor connections and the network state.

? When publishing is not performed successfully



- Check whether the checkbox next to the monitor to which you want to publish to is selected..
- Check whether the monitor to which you want to publish to is connected to the server.
- Check whether the Operating Mode of the monitor to which you want to publish to is set to Scheduler.
- Check whether the monitor has sufficient free disk space.
- Check whether the screen exists within the publishing time.

? When publishing is completed even though 100% is not displayed in the Publishing Status.



- The percentage displayed in the Publishing Status is the ratio of the size of the content the monitor has actually downloaded to the total size of all the content which is set to be downloaded on the screen. If 100% is not displayed, it means that the monitor has failed to download the content files. To view the results, double-click the Result cell of the monitor or use the buttons displayed when clicking it. Check whether the file the monitor failed to download actually exists on the server or content server and is correct.
- Check whether StreamServer.exe, which is performed at the same time when the server starts up, is running normally. (Check whether StreamServer.exe is running by viewing its tray icon or looking for its image name in the Processes tab of the Task Manager.) If it is not running, run the server again, or run StreamServer.exe again in the folder with the server's executable files.

? When a schedule is not performed normally



- Check whether the schedule has been published successfully.
- Check whether the system times of the server and monitor are the same.

? Password / Log In



The password you enter when installing MagicInfo Pro becomes the password of the Administrator account by default.



If you forgot your password, remove and reinstall the program.

? When the monitor update function does not work



Check the monitor version. If it is the latest version, no updating is performed.

? When a movie file is not registered to the library



Check whether the proper codec is installed for the movie file the server wants to register to the monitor. If more than one codec of the same type has been installed or an incomplete codec is installed on the PC, it may cause a problem.

? When an area edited on a screen cannot be previewed or the preview function does not work



- Check whether the file you want to preview is corrupt and whether it actually exists.
 - You cannot preview an office file or a source.
-

 **Removing the Program**

You can remove **MagicInfo Pro** using Add/Remove Programs in Windows or using the menu created when installing the program.

Follow these steps to remove **MagicInfo Pro**.

1. Click **[Start]**, and then point to **[Settings]** and click **[Control Panel]**.
2. For Windows XP, click **[Start]** and click **[Control Panel]**.
3. Double-click the **[Add/Remove Programs]** icon in the Control Panel.
4. Click **MagicInfo Pro**. Scroll down the **[Add/Remove Programs]** window until you locate it, if necessary.
5. Click **[Change/Remove]**.
6. Click "Yes" to remove **MagicInfo Pro**.
7. Wait until the message that the program has been removed successfully is displayed.

프로그램 제거

MagicInfo Pro는 Windows 프로그램 추가/제거 옵션을 사용하거나 프로그램 설치시 추가되는 메뉴를 통해 제거할 수 있습니다.

MagicInfo Pro를 제거하려면 다음 단계를 수행하십시오.

1. 시스템 트레이에서 **[시작]** 메뉴로 이동하고 **[설정]**을 선택한 다음 메뉴에서 **[제어판]**을 선택합니다.
2. Windows XP의 경우 **[시작]** 메뉴에서 **[제어판]**을 선택합니다.
3. 제어판에서 **[프로그램 추가/제거]** 아이콘을 엽니다.
4. **[추가/제거]** 창에서 아래로 스크롤한 다음 **MagicInfo Pro**를 클릭하여 강조 표시합니다.
5. **[변경/제거]**를 클릭하여 제거합니다.
6. "예"를 클릭하여 **MagicInfo Pro**의 제거를 시작합니다.
7. 설치 제거가 완료되었다는 대화 상자가 나타날 때까지 기다립니다.

RDP 를 이용한 프로그램 **Update**를 하려면 다음 단계를 수행하십시오.

1. 'ALT + F12'로 바탕화면으로 진입 합니다.
2. 원격 연결(RDP)하기 위해서는 아래의 ID와 PW를 사용하세요.
윈도우 로그인 시 ID: Administrator
윈도우 로그인 시 PW: 000000

Adjusting the LCD Display

Input

Available Modes

- **P** PC / DVI
- **A** AV
- **H** HDMI
- **M** MagicInfo
- **T** TV

Note

- The **TV** menu is available when a TV tuner box is installed.
- The **MagicInfo** menu is available when a network box is installed.

Source List **PAHMT**

MENU → ENTER → **[Input]** → ENTER → **[Source List]**

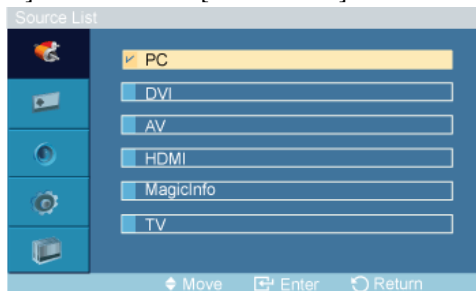

→ ▲, ▼ → ENTER

Use to select **PC**, **DVI** or other external input sources connected to the LCD Display. Use to select the screen of your choice.

1. **PC**
2. **DVI**
3. **AV**
4. **HDMI**
5. **MagicInfo**
6. **TV**

Note

- The direct button on the remote control is the 'SOURCE' button.
- For **PC** and **DVI**, this is deactivated if the cable is disconnected.

Edit Name **PAHMT**

MENU → ENTER → **[Input]** → ▼ → **[Edit Name]**

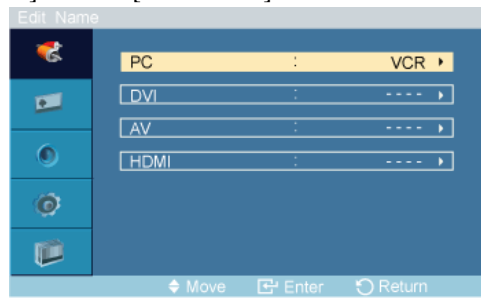

→ ▲, ▼ → ENTER

Name the input device connected to the input jacks to make your input source selection easier.

1. **PC**
2. **DVI**
3. **AV**
4. **HDMI**

Picture **[PC / DVI / MagicInfo Mode]**

Available Modes

- **P** PC / DVI
- **A** AV
- **H** HDMI
- **M** MagicInfo
- **T** TV

Note

- The **TV** menu is available when a TV tuner box is installed.
- The **MagicInfo** menu is available when a network box is installed.

MagicBright **PM**

MENU → ▼ → ENTER → **[Picture]** → ENTER → **[MagicBright]**

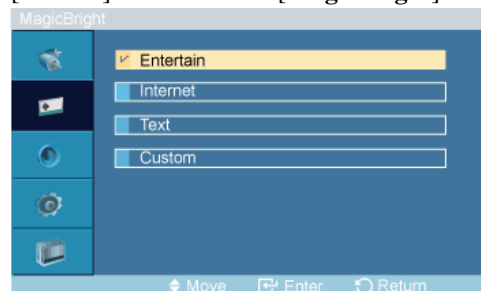

→ ▲, ▼ → ENTER

MagicBright is a feature providing the optimum viewing environment depending on the contents of the image you are watching. Currently four different modes are available: **Entertain**, **Internet**, **Text** and **Custom**. Each mode has its own pre-configured brightness value. You can easily select one of the four settings by simply pressing the **MagicBright** control button.

(Not available in **Dynamic Contrast** mode of **On**.)

1. **Entertain**

High brightness

For watching motion pictures such as a DVD or VCD.

2. **Internet**

Medium brightness

For working with a mixture of images such as texts and graphics.

3. **Text**

Normal brightness

For documents or works involving heavy text.

4. **Custom**

Although the values are carefully chosen by our engineers, the pre-configured values may not be comfortable to your eyes depending on your taste.

If this is the case, adjust the brightness and contrast by using the OSD menu.

Custom

By using the on-screen menus, the contrast and brightness can be changed to your personal preference.

MENU → ▼ → ENTER → [Picture] → ▼ → ENTER → [Custom]

(Not available in **Dynamic Contrast** mode of **On**.)



By adjusting the picture using the **Custom** function, **MagicBright** will change to **Custom** mode.

Contrast

MENU → ▼ → ENTER → [Picture] → ▼ → ENTER → [Custom] → ENTER → [Contrast]



→ ◀ ▶ → ENTER

Adjusts the Contrast.

Brightness

MENU → ▼ → ENTER → [Picture] → ▼ → ENTER → [Custom] → ▼ → ENTER → [Brightness]



→ ◀ ▶ → ENTER

Adjusts the Brightness.

Sharpness

MENU → ▼ → ENTER → [Picture] → ▼ → ENTER → [Custom] → ▼ → ▼ → ENTER → [Sharpness]



→ ◀ ▶ → ENTER

Adjusts the Sharpness.

Color Tone **PM**

MENU → ▼ → ENTER → [Picture] → ▼ → ▼ → ENTER → [Color Tone]

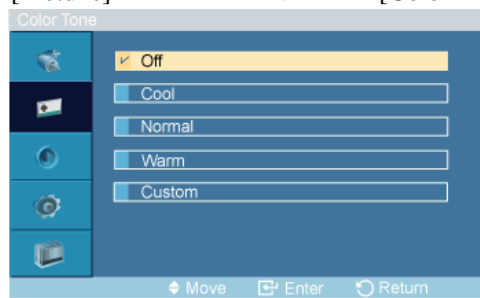

→ ▲, ▼ → ENTER

The color tones can be changed.

(Not available in **Dynamic Contrast** mode of **On**.)

1. **Off**
2. **Cool**
3. **Normal**
4. **Warm**
5. **Custom**

Note

If you set the **Color Tone** to **Cool**, **Normal**, **Warm**, or **Custom**, the **Color Temp** function is disabled.

If you set the **Color Tone** to **Off**, the **Color Control** function is disabled

Color Control **PM**

Adjusts individual Red, Green, Blue color balance.

MENU → ▼ → ENTER → [Picture] → ▼ → ▼ → ▼ → ENTER → [Color Control]

(Not available in **Dynamic Contrast** mode of **On**.)

Note

If you adjust the picture by using the **Color Control** function, **Color Tone** will turn to the **Custom** mode.

Red

MENU → ▼ → ENTER → [Picture] → ▼ → ▼ → ▼ → ENTER → [Color Control] → ENTER → [Red]

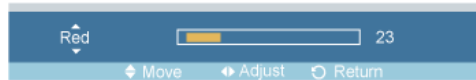

→ ◀ ▶ → ENTER

Green

MENU → ▼ → ENTER → [Picture] → ▼ → ▼ → ▼ → ENTER → [Color Control] → ▼ → ENTER → [Green]



→ ◀ ▶ → ENTER

Blue

MENU → ▼ → ENTER → [Picture] → ▼ → ▼ → ▼ → ENTER → [Color Control] → ▼ → ▼ → ENTER → [Blue]



→ ◀ ▶ → ENTER

Color Temp **PM**

MENU → ▼ → ENTER → [Picture] → ▼ → ▼ → ▼ → ENTER → [Color Temp]



→ ◀ ▶ → ENTER

Color Temp is a measure of the 'warmth' of the image colors.

(Not available in **Dynamic Contrast** mode of **On**.)



Note

This function is only enabled if the **Color Tone** is set to **Off**.

Image Lock **P**

Image Lock is used to fine-tune and get the best image by removing noise that creates unstable images with jitters and shakiness. If satisfactory results are not obtained using the Fine adjustment, use the Coarse adjustment and then use Fine again.

(Available in **PC** mode only)

MENU → ▼ → ENTER → [Picture] → ▼ → ▼ → ▼ → ▼ → ENTER → [Image Lock]

Coarse

MENU → ▼ → ENTER → [Picture] → ▼ → ▼ → ▼ → ▼ → ENTER → [Image Lock] → ENTER → [Coarse]



→ ◀ ▶ → ENTER

Removes noise such as vertical stripes. Coarse adjustment may move the screen image area. You may relocate it to the center using the horizontal control menu.

Fine

MENU → ▼ → ENTER → [Picture] → ▼ → ▼ → ▼ → ▼ → ENTER → [Image Lock] → ▼ → ENTER → [Fine]



→ ◀ ▶ → ENTER

Removes noise such as horizontal stripes. If the noise persists even after Fine tuning, repeat it after adjusting the frequency (clock speed).

H-Position

MENU → ▼ → ENTER → [Picture] → ▼ → ▼ → ▼ → ▼ → ENTER → [Image Lock] → ▼ → ▼ → ENTER → [H-Position]



→ ◀ ▶ → ENTER

Adjusts the screen location horizontally.

V-Position

MENU → ▼ → ENTER → [Picture] → ▼ → ▼ → ▼ → ▼ → ENTER → [Image Lock] → ▼ → ▼ → ▼ → ENTER → [V-Position]



→ ◀ ▶ → ENTER

Adjusts the screen location vertically.

Auto Adjustment P

MENU → ▼ → ENTER → [Picture] → ▼ → ▼ → ▼ → ▼ → ENTER → [Auto Adjustment]

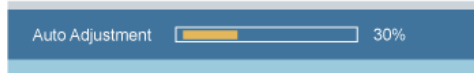

The values of **Fine**, **Coarse**, **Position** are adjusted automatically. By changing the resolution in the control panel, the auto function is performed.

(Available in **PC** mode only)

 **Note**

The direct button on the remote control is the 'AUTO' button.

Signal Balance P

This is used to make up for the weak RGB signal transmitted by a long signal cable.

MENU → ▼ → ENTER → [Picture] → ▼ → ▼ → ▼ → ▼ → ▼ → ▼ → ENTER → [Signal Balance]

(Available in PC mode only)

Signal Balance

MENU → ▼ → ENTER → [Picture] → ▼ → ▼ → ▼ → ▼ → ▼ → ▼ → ENTER → [Signal Balance] → ENTER → [Signal Balance]

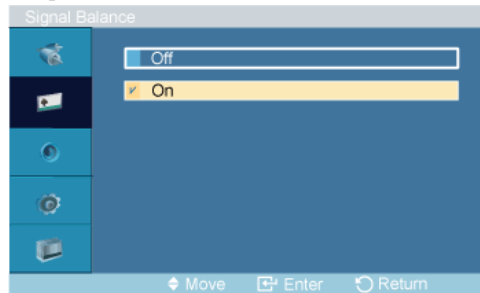

→ ▲, ▼ → ENTER

Selects either **On** or **Off** with the signal control.

Signal Control

MENU → ▼ → ENTER → [Picture] → ▼ → ▼ → ▼ → ▼ → ▼ → ▼ → ENTER → [Signal Balance] → ▼ → ENTER → [Signal Control]

1. R-Gain

MENU → ▼ → ENTER → [Picture] → ▼ → ▼ → ▼ → ▼ → ▼ → ▼ → ENTER → [Signal Balance] → ▼ → ENTER → [Signal Control] → ENTER → [R-Gain] → ENTER



→ ◀, ▶ → ENTER

2. G-Gain

MENU → ▼ → ENTER → [Picture] → ▼ → ▼ → ▼ → ▼ → ▼ → ▼ → ENTER → [Signal Balance] → ▼ → ENTER → [Signal Control] → ▼ → ENTER → [G-Gain] → ENTER



→ ◀, ▶ → ENTER

3. B-Gain

MENU → ▼ → ENTER → [Picture] → ▼ → ▼ → ▼ → ▼ → ▼ → ▼ → ENTER → [Signal Balance] → ▼ → ENTER → [Signal Control] → ▼ → ▼ → ENTER → [B-Gain] → ENTER



→ ◀, ▶ → ENTER

4. **R-Offset**

MENU → ▼ → ENTER → [Picture] → ▼ → ▼ → ▼ → ▼ → ▼ → ▼ → ENTER → [Signal Balance] → ▼ → ENTER → [Signal Control] → ▼ → ▼ → ▼ → ENTER → [R-Offset] → ENTER



→ ◀, ▶ → ENTER

5. **G-Offset**

MENU → ▼ → ENTER → [Picture] → ▼ → ▼ → ▼ → ▼ → ▼ → ▼ → ENTER → [Signal Balance] → ▼ → ENTER → [Signal Control] → ▼ → ▼ → ▼ → ▼ → ENTER → [G-Offset] → ENTER



→ ◀, ▶ → ENTER

6. **B-Offset**

MENU → ▼ → ENTER → [Picture] → ▼ → ▼ → ▼ → ▼ → ▼ → ▼ → ENTER → [Signal Balance] → ▼ → ENTER → [Signal Control] → ▼ → ▼ → ▼ → ▼ → ▼ → ▼ → ENTER → [B-Offset] → ENTER



→ ◀, ▶ → ENTER

Size P

MENU → ▼ → ENTER → [Picture] → ▼ → ▼ → ▼ → ▼ → ▼ → ▼ → ▼ → ENTER → [Size]

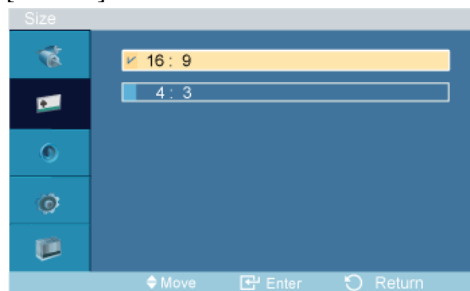

→ ▲, ▼ → ENTER

The **Size** can be switched.

1. **16:9**
2. **4:3**

Dynamic Contrast PM

MENU → ▼ → ENTER → [Picture] → ▼ → ▼ → ▼ → ▼ → ▼ → ▼ → ▼ → ENTER → [Dynamic Contrast]

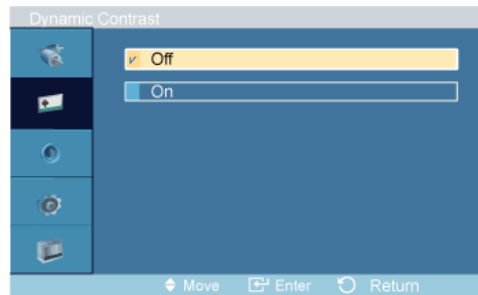

→ ▲, ▼ → ENTER

Dynamic Contrast automatically detects the distribution of the visual signal and adjusts to create an optimum contrast.

1. **Off**
2. **On**

Picture [AV / HDMI / TV Mode]

Available Modes

- **P** PC / DVI
- **A** AV
- **H** HDMI
- **M** MagicInfo
- **T** TV

Note

- The **TV** menu is available when a TV tuner box is installed.
- The **MagicInfo** menu is available when a network box is installed.

Mode **AHT**

MENU → ▼ → ENTER → **[Picture]** → ENTER → **[Mode]**

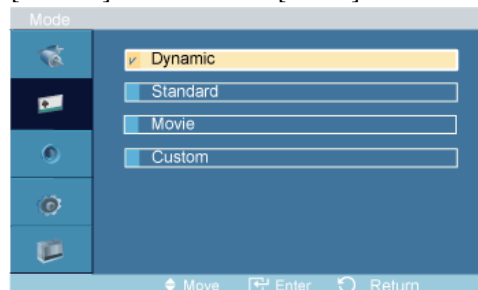

→ ▲, ▼ → ENTER

The LCD Display has four automatic picture settings ("**Dynamic**", "**Standard**", "**Movie**" and "**Custom**") that are preset at the factory.

Dynamic, **Standard**, **Movie**, or **Custom** can be activated.

(Not available in **Dynamic Contrast** mode of **On**.)

1. **Dynamic**
2. **Standard**
3. **Movie**
4. **Custom**



The direct button on the remote control is the 'P.MODE' button.

Custom **AHT**

By using the on-screen menus, the contrast and brightness can be changed to your personal preference.

MENU → ▼ → ENTER → **[Picture]** → ▼ → ENTER → **[Custom]**

(Not available in **Dynamic Contrast** mode of **On**.)

Contrast

MENU → ▼ → ENTER → **[Picture]** → ▼ → ENTER → **[Custom]** → ENTER → **[Contrast]**



→ ◀ ▶ → ENTER

Adjusts the Contrast.

Brightness

MENU → ▼ → ENTER → **[Picture]** → ▼ → ENTER → **[Custom]** → ▼ → ENTER → **[Brightness]**



→ ◀ ▶ → ENTER

Adjusts the Brightness.

Sharpness

MENU → ▼ → ENTER → **[Picture]** → ▼ → ENTER → **[Custom]** → ▼ → ▼ → ENTER → **[Sharpness]**



→ ◀ ▶ → ENTER

Adjusts the picture Sharpness.

Color

MENU → ▼ → ENTER → **[Picture]** → ▼ → ENTER → **[Custom]** → ▼ → ▼ → ▼ → ENTER → **[Color]**



→ ◀ ▶ → ENTER

Adjusts the picture Color.

Tint

MENU → ▼ → ENTER → [Picture] → ▼ → ENTER → [Custom] → ▼ → ▼ → ▼ → ▼ → ENTER → [Tint]



→ ◀ ▶ → ENTER

Adds a natural tone to the display.

Color Tone **AHT**

MENU → ▼ → ENTER → [Picture] → ▼ → ▼ → ENTER → [Color Tone]

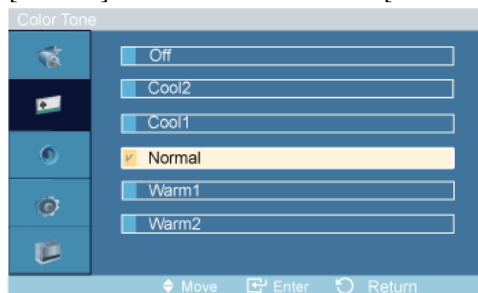

→ ▲, ▼ → ENTER

The color tones can be changed. The individual Color components are also user adjustable.

(Not available in **Dynamic Contrast** mode of **On**.)

1. **Off**
2. **Cool2**
3. **Cool1**
4. **Normal**
5. **Warm1**
6. **Warm2**



Note

If you set the **Color Tone** to **Cool2**, **Cool1**, **Normal**, **Warm1**, or **Warm2**, the **Color Temp** function is disabled.

Color Temp **AHT**

MENU → ▼ → ENTER → [Picture] → ▼ → ▼ → ▼ → ENTER → [Color Temp]



→ ◀ ▶ → ENTER

Color temp is a measure of the 'warmth' of the image colors.

(Not available in **Dynamic Contrast** mode of **On**.)

 **Note**

This function is only enabled if the **Color Tone** is set to **Off**.

Size **AH**

MENU → ▼ → ENTER → **[Picture]** → ▼ → ▼ → ▼ → ▼ → ENTER → **[Size]**

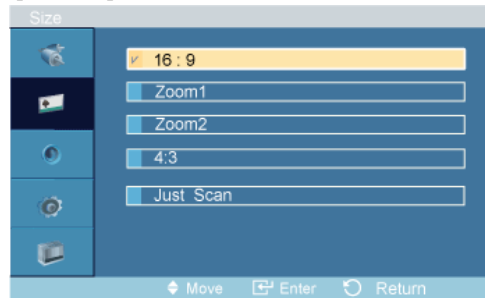

→ ▲, ▼ → ENTER

The **Size** can be switched.

1. **16:9**
2. **Zoom 1**
3. **Zoom 2**
4. **4:3**
5. **Just Scan**

(Not available in **Dynamic Contrast** mode of **On**.)

 **Note**

The **Zoom1**, **Zoom2** are not available **HDMI**.

The **Just Scan** are available in **HDMI**.

Digital NR (Digital Noise Reduction) **AHT**

MENU → ▼ → ENTER → **[Picture]** → ▼ → ▼ → ▼ → ▼ → ENTER → **[Digital NR]**

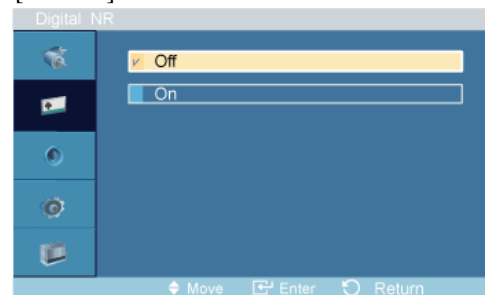

→ ▲, ▼ → ENTER

Turns the Digital Noise Reduction feature **Off/On**. The Digital Noise Reduction feature allows you to enjoy clearer and crisper images.

1. **Off**
2. **On**

Film Mode **A T**

MENU → ▼ → ENTER → [Picture] → ▼ → ▼ → ▼ → ▼ → ▼ → ▼ → ENTER → [Film Mode]

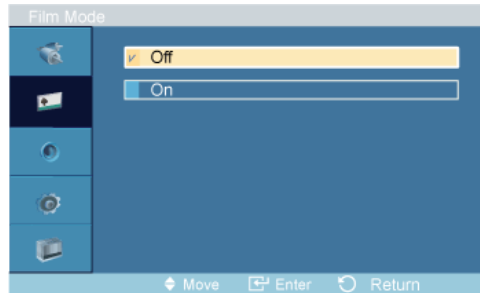

→ ▲, ▼ → ENTER

Turns **Film Mode Off/On**.

The **Film Mode** feature offers you a theater-quality viewing experience.

(Not available in **HDMI Mode**)

1. **Off**
2. **On**

Dynamic Contrast **A H T**

MENU → ▼ → ENTER → [Picture] → ▼ → ▼ → ▼ → ▼ → ▼ → ▼ → ▼ → ENTER → [Dynamic Contrast]

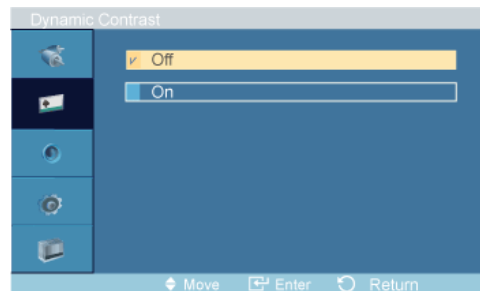

→ ▲, ▼ → ENTER

Dynamic Contrast automatically detects the distribution of the visual signal and adjusts to create an optimum contrast.

1. **Off**
2. **On**

Brightness Sensor **A H T**

MENU → ▼ → ENTER → [Picture] → ▼ → ▼ → ▼ → ▼ → ▼ → ▼ → ▼ → ENTER → [Brightness Sensor]



→ ◀, ▶ → ENTER

Brightness Sensor is to automatically detect distribution of inputted visual signal and adjust to create optimum brightness.

1. **Off**
2. **On**

Sound

Available Modes

- **P** PC / DVI
- **A** AV
- **H** HDMI
- **M** MagicInfo
- **T** TV

Note

- The **TV** menu is available when a TV tuner box is installed.
- The **MagicInfo** menu is available when a network box is installed.

Mode **PAHMT**

MENU → ▼ → ▼ → ENTER → [Sound] → ENTER → [Mode]

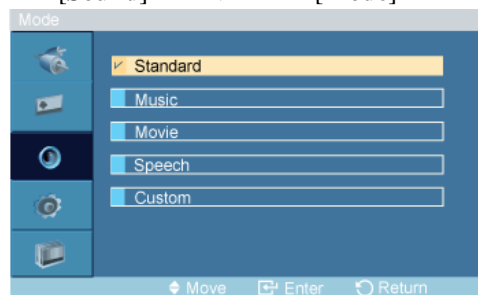

→ ▲, ▼ → ENTER

The LCD Display has a built-in high fidelity stereo amplifier.

1. **Standard**
Selects **Standard** for the standard factory settings.
2. **Music**
Selects **Music** when watching music videos or concerts.

3. **Movie**

Selects **Movie** when viewing movies.

4. **Speech**

Selects **Speech** when watching a show that is mostly dialogue (i.e., news).

5. **Custom**

Selects **Custom** if you want to adjust the settings according to your personal preferences.

Custom **PAHMT**

The sound settings can be adjusted to suit your personal preferences.

MENU → ▼ → ▼ → ENTER → [Sound] → ▼ → ENTER → [Custom]



- You can hear the sound even when sound value is set to 0.
- If you adjust sound using **Custom** function, **Mode** will turn to **Custom** mode.

Bass

MENU → ▼ → ▼ → ENTER → [Sound] → ▼ → ENTER → [Custom] → ENTER → [Bass]



→ ◀ ▶ → ENTER

Emphasizes low frequency audio.

Treble

MENU → ▼ → ▼ → ENTER → [Sound] → ▼ → ENTER → [Custom] → ▼ → ENTER → [Treble]



→ ◀ ▶ → ENTER

Emphasizes high frequency audio.

Balance

MENU → ▼ → ▼ → ENTER → [Sound] → ▼ → ENTER → [Custom] → ▼ → ▼ → ENTER → [Balance]



→ ◀ ▶ → ENTER

Allows you to Adjusts the sound balance between the left and right speakers.

Auto Volume **PAHMT**

MENU → ▼ → ▼ → ENTER → [Sound] → ▼ → ▼ → ENTER → [Auto Volume]

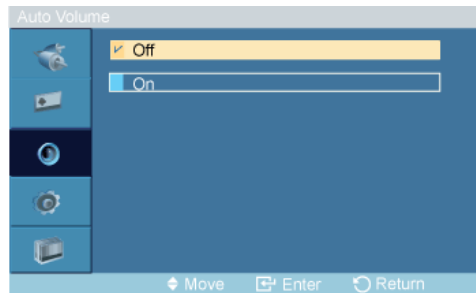

→ ▲, ▼ → ENTER

Reduces the difference in volume control between broadcasters.

1. **Off**
2. **On**

SRS TS XT **PAHMT**

MENU → ▼ → ▼ → ENTER → [Sound] → ▼ → ▼ → ▼ → ENTER → [SRS TS XT]

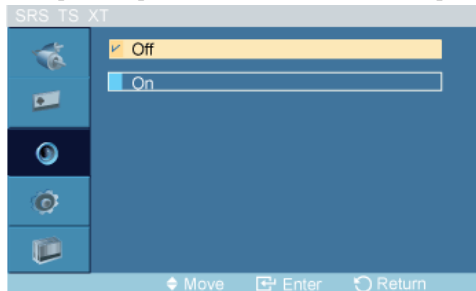

→ ▲, ▼ → ENTER

SRS TS XT is a patented SRS technology that solves the problem of playing 5.1 multichannel content over two speakers. TruSurround delivers a compelling, virtual surround sound experience through any two-speaker playback system, including internal television speakers. It is fully compatible with all multichannel formats.

1. **Off**
2. **On**

 **Note**

The direct button on the remote control is the 'SRS' button.

Setup

Available Modes

- **P** PC / DVI
- **A** AV
- **H** HDMI
- **M** MagicInfo

- **T TV**



- The **TV** menu is available when a TV tuner box is installed.
- The **MagicInfo** menu is available when a network box is installed.

Language PAHMT

MENU → ▼ → ▼ → ▼ → ENTER → [Setup] → ENTER → [Language]



→ ▲, ▼ → ENTER

You can choose one of 11 languages.

English, Deutsch, Español, Français, Italiano, Svenska, Русский
Português, 中国語, 日本語, 한국어



The language chosen affects only the language of the OSD. It has no effect on any software running on the computer.

Time PAHMT

Selects from one of 4 time settings, **Clock Set**, **Sleep Timer**, **On Timer**, and **Off Timer**.

MENU → ▼ → ▼ → ▼ → ENTER → [Setup] → ▼ → ENTER → [Time]

Clock Set

MENU → ▼ → ▼ → ▼ → ENTER → [Setup] → ▼ → ENTER → [Time] → ENTER → [Clock Set]

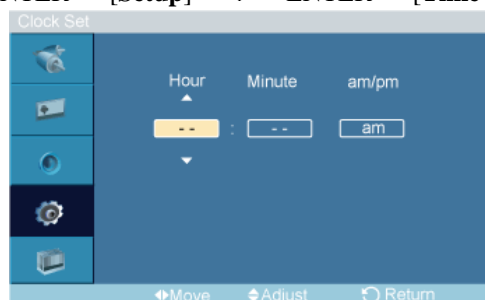

→ ▲, ▼ → ◀, ▶ → ENTER

Current Time Setting.

Sleep Timer

MENU → ▼ → ▼ → ▼ → ENTER → [Setup] → ▼ → ENTER → [Time] → ▼ → ENTER → [Sleep Timer]



→ ▲, ▼ → ENTER

Turns the LCD Display off automatically at certain times.

1. **Off**
2. **30**
3. **60**
4. **90**
5. **120**
6. **150**
7. **180**

On Timer

MENU → ▼ → ▼ → ▼ → ENTER → [Setup] → ▼ → ENTER → [Time] → ▼ → ▼ → ENTER → [On Timer]

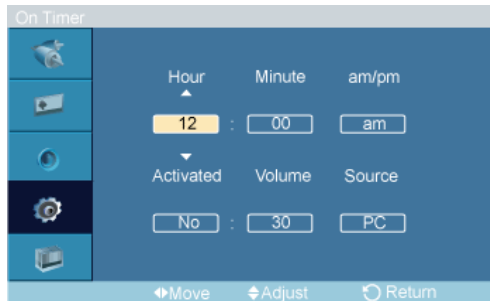

→ ▲, ▼ / ◀, ▶ → ENTER

Turns the LCD Display on automatically at a preset time. Controls the mode and the volume level at the time the LCD Display turns on automatically.

Off Timer

MENU → ▼ → ▼ → ▼ → ENTER → [Setup] → ▼ → ENTER → [Time] → ▼ → ▼ → ▼ → ENTER → [Off Timer]

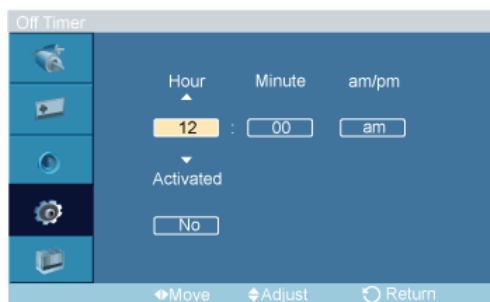

→ ▲, ▼ / ◀, ▶ → ENTER

Turns the LCD Display off automatically at a preset time.

Menu Transparency **PAHMT**

MENU → ▼ → ▼ → ▼ → ENTER → [Setup] → ▼ → ▼ → ENTER → [Menu Transparency]

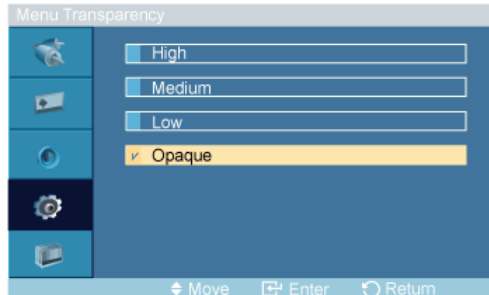

→ ▲, ▼ → ENTER

Change the transparency of the background of the OSD.

1. **High**
2. **Medium**
3. **Low**
4. **Opaque**

Safety Lock PIN **PAHMT**

MENU → ▼ → ▼ → ▼ → ENTER → [Setup] → ▼ → ▼ → ▼ → ENTER → [Safety Lock PIN]

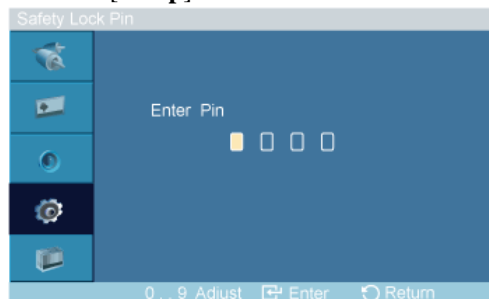

→ [0□9] → [0□9] → [0□9]

The password can be changed.

Energy Saving **PAHMT**

MENU → ▼ → ▼ → ▼ → ENTER → [Setup] → ▼ → ▼ → ▼ → ▼ → ENTER → [Energy Saving]

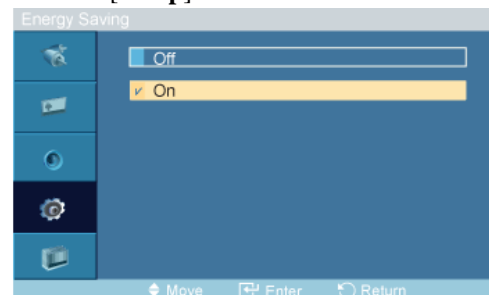

→ ▲, ▼ → ENTER

This feature adjusts the power consumption of the unit in order to save energy.

1. **Off**
2. **On**



Note

If you want to reduce the standby power consumption, set **Energy Saving** to **On**. However, when **Energy Saving** is **On**, you cannot use the remote Power On function of the MDC and the WOL (Wake On LAN) function of MagicInfo.

HDMI Black Level H

MENU → ▼ → ▼ → ▼ → ENTER → [Setup] → ▼ → ▼ → ▼ → ▼ → ▼ → ENTER → [HDMI Black Level]

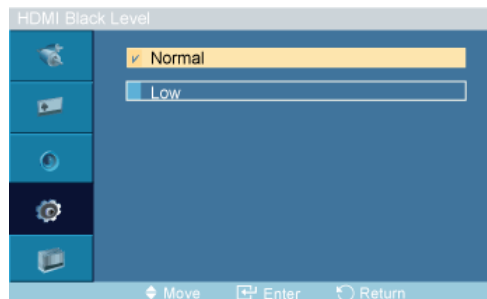

→ ▲, ▼ → ENTER

When a DVD or set-top box is connected to your TV via HDMI, it may cause a degradation in the screen quality, such as an increase in the black level, a low contrast, or discoloration, etc., depending on the external device connected. In this case, adjust the screen quality of your TV by configuring the **HDMI black level**.

1. **Normal**
2. **Low**

Video Wall P H T

A **Video Wall** is a set of video screens connected together, so that each screen shows a part of the whole picture or where the same picture is repeated on each screen.

When the **Video Wall** is on, you can adjust the **Video Wall** screen setting.

MENU → ▼ → ▼ → ▼ → ENTER → [Setup] → ▼ → ▼ → ▼ → ▼ → ▼ → ENTER → [Video Wall]



Note

When **Video Wall** is running, the **Auto Adjustment**, **Image Lock**, and **Size** functions are not available. **Video Wall** does not operate in **MagicInfo** mode.

Video Wall

MENU → ▼ → ▼ → ▼ → ENTER → [Setup] → ▼ → ▼ → ▼ → ▼ → ▼ → ENTER → [Video Wall] → ENTER → [Video Wall]

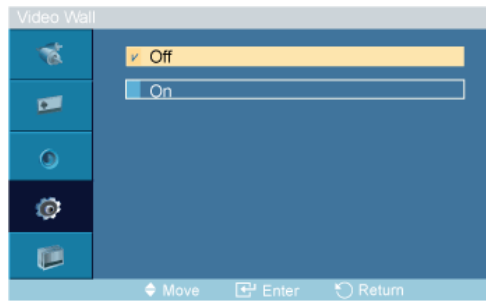

→ ▲, ▼ → ENTER

Turns Off/On the **Video Wall** function of the selected display Off/On.

1. **Off**
2. **On**

Format

MENU → ▼ → ▼ → ▼ → ENTER → [Setup] → ▼ → ▼ → ▼ → ▼ → ▼ → ▼ → ENTER → [Video Wall] → ▼ → ENTER → [Format]

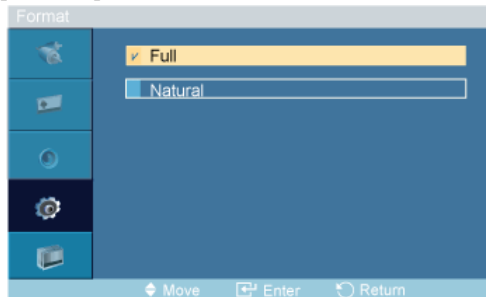

→ ▲, ▼ → ENTER

The **Format** can be selected to see a divided screen.

1. **Full**
Provides a full screen without any margins.
2. **Natural**
Displays a natural image with the original aspect ratio intact.

Horizontal

MENU → ▼ → ▼ → ▼ → ENTER → [Setup] → ▼ → ▼ → ▼ → ▼ → ▼ → ▼ → ENTER → [Video Wall] → ▼ → ▼ → ENTER → [Horizontal]

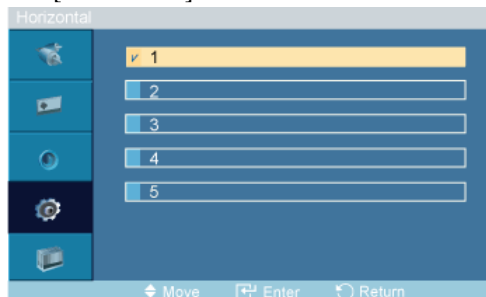

→ ▲, ▼ → ENTER

Sets how many parts the screen should be divided horizontally.

Five adjustment levels: 1, 2, 3, 4, and 5.

Vertical

MENU → ▼ → ▼ → ▼ → ENTER → [Setup] → ▼ → ▼ → ▼ → ▼ → ▼ → ▼ → ENTER → [Video Wall] → ▼ → ▼ → ▼ → ENTER → [Vertical]

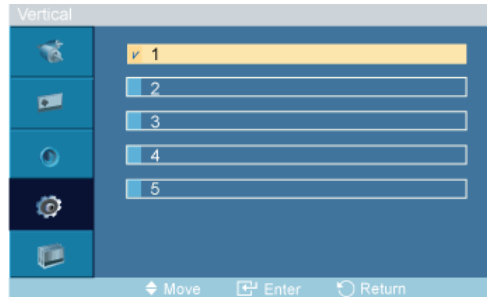

→ ▲, ▼ → ENTER

Sets how many parts the screen should be divided vertically.

Five adjustment levels: 1, 2, 3, 4, and 5.

Screen Divider

MENU → ▼ → ▼ → ▼ → ENTER → [Setup] → ▼ → ▼ → ▼ → ▼ → ▼ → ▼ → ENTER → [Video Wall] → ▼ → ▼ → ▼ → ▼ → ENTER → [Screen Divider]

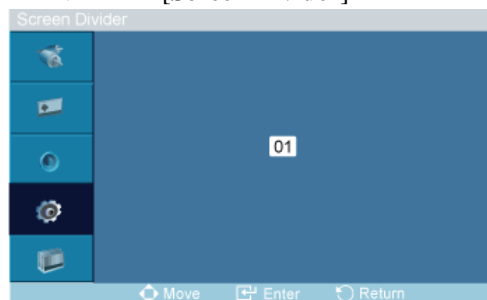

The screen can be divided into several images. A number of screens can be selected with a different layout when dividing.

- Select a mode in Screen Divider.
- Select a display in Display Selection.
- The selection will be set up by pressing a number in the selected mode.

Safety Screen **PASCHM**

The **Safety Screen** function is used to prevent afterimages that may appear when a still picture is displayed on the screen over a long time.

- The **Screen Scroll** function scrolls the screen for the specified period of time.
- This function is not available when the power is turned off.

MENU → ▼ → ▼ → ▼ → ENTER → [Setup] → ▼ → ▼ → ▼ → ▼ → ▼ → ▼ → ENTER → [Safety Screen]

Pixel Shift

Pixel Shift

MENU → ▼ → ▼ → ▼ → ENTER → [Setup] → ▼ → ▼ → ▼ → ▼ → ▼ → ▼ → ▼ → ENTER → [Safety Screen] → ENTER → [Pixel Shift] → ENTER → [Pixel Shift] → ▲, ▼ → ENTER

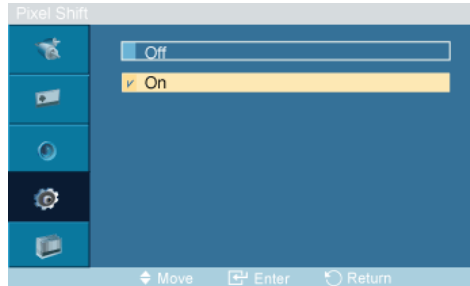

To prevent after-images on the screen you can use this function, so that every minute pixels on the PDP are moved in horizontal or vertical direction.

1. **Off**
2. **On**

Horizontal Dot

MENU → ▼ → ▼ → ▼ → ENTER → [Setup] → ▼ → ▼ → ▼ → ▼ → ▼ → ▼ → ▼ → ENTER → [Safety Screen] → ENTER → [Pixel Shift] → ▼ → ENTER → [Horizontal Dot] → ▲, ▼ → ENTER

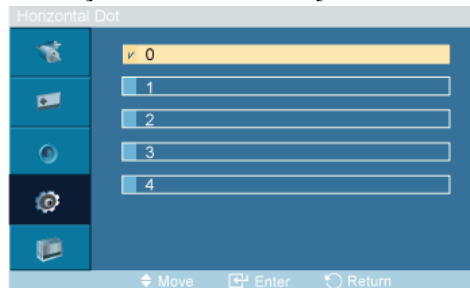

Sets how many pixels the screen moves horizontally.

Five adjustment levels: 0, 1, 2, 3, and 4.

Vertical Line

MENU → ▼ → ▼ → ▼ → ENTER → [Setup] → ▼ → ▼ → ▼ → ▼ → ▼ → ▼ → ▼ → ENTER → [Safety Screen] → ENTER → [Pixel Shift] → ▼ → ▼ → ENTER → [Vertical Line] → ▲, ▼ → ENTER



Sets how many pixels the screen moves vertically.

Five adjustment levels: 0, 1, 2, 3, and 4.

Time

MENU → ▼ → ▼ → ▼ → ENTER → [Setup] → ▼ → ▼ → ▼ → ▼ → ▼ → ▼ → ▼ → ENTER → [Safety Screen] → ENTER → [Pixel Shift] → ▼ → ▼ → ▼ → ENTER → [Time] → ▲, ▼ → ENTER



Set the time interval for performing the horizontal or vertical movement, respectively.

Timer

Timer

MENU → ▼ → ▼ → ▼ → ENTER → [Setup] → ▼ → ▼ → ▼ → ▼ → ▼ → ▼ → ▼ → ENTER → [Safety Screen] → ▼ → ENTER → [Timer] → ENTER → [Timer] → ▲, ▼ → ENTER

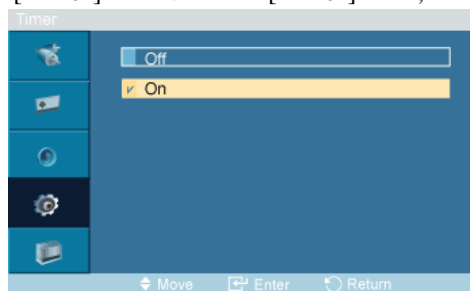

You can set the timer for Screen Burn Protection.

If you start the operation to erase any residual image, the operation will be performed for the set period of time and then automatically finish.

1. **Off**
2. **On**

Mode

MENU → ▼ → ▼ → ▼ → ENTER → [Setup] → ▼ → ▼ → ▼ → ▼ → ▼ → ▼ → ▼ → ENTER → [Safety Screen] → ▼ → ENTER → [Timer] → ▼ → ENTER → [Mode] → ▲, ▼ → ENTER



You can change the **Safety Screen** Type.

1. **Scroll**

2. **Bar**
3. **Eraser**

Period

MENU → ▼ → ▼ → ▼ → ENTER → [Setup] → ▼ → ▼ → ▼ → ▼ → ▼ → ▼ → ▼ → ENTER → [Safety Screen] → ▼ → ENTER → [Timer] → ▼ → ▼ → ENTER → [Period] → ▲, ▼ → ENTER

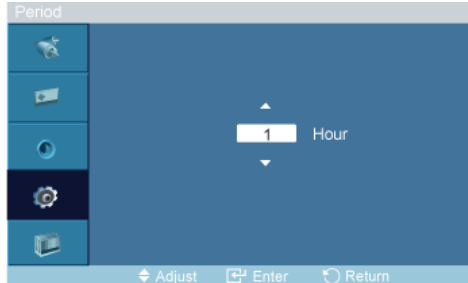

Use this function to set the execution period for each mode set in the timer.

Time

MENU → ▼ → ▼ → ▼ → ENTER → [Setup] → ▼ → ▼ → ▼ → ▼ → ▼ → ▼ → ▼ → ENTER → [Safety Screen] → ▼ → ENTER → [Timer] → ▼ → ▼ → ▼ → ENTER → [Time] → ▲, ▼ → ENTER

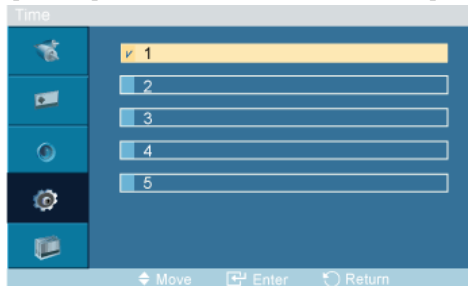

Within the set period of time specify a time for execution.

- **Mode-Scroll** : 1~5 sec
- **Mode-Bar, Eraser** : 10~50 sec

Scroll

MENU → ▼ → ▼ → ▼ → ENTER → [Setup] → ▼ → ▼ → ▼ → ▼ → ▼ → ▼ → ▼ → ENTER → [Safety Screen] → ▼ → ▼ → ENTER → [Scroll]

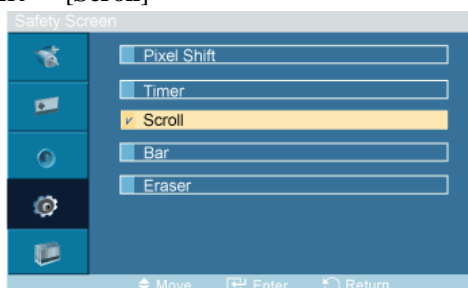

This function prevents after-images on the screen by moving all the pixels on the PDP according to a pattern.

Use this function when there are remaining after-images or symbols on the screen, especially when you displayed a still image on the screen for a long time.

Bar

MENU → ▼ → ▼ → ▼ → ENTER → [Setup] → ▼ → ▼ → ▼ → ▼ → ▼ → ▼ → ▼ → ENTER → [Safety Screen] → ▼ → ▼ → ▼ → ENTER → [Bar]

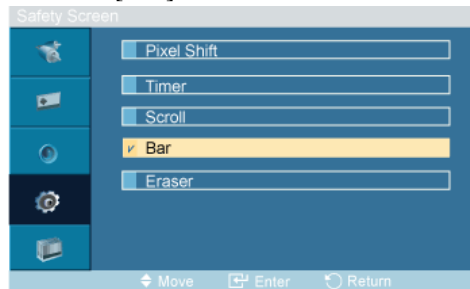

This function prevents after-images on the screen by moving long black and white vertical lines.

Eraser

MENU → ▼ → ▼ → ▼ → ENTER → [Setup] → ▼ → ▼ → ▼ → ▼ → ▼ → ▼ → ▼ → ENTER → [Safety Screen] → ▼ → ▼ → ▼ → ENTER → [Eraser]

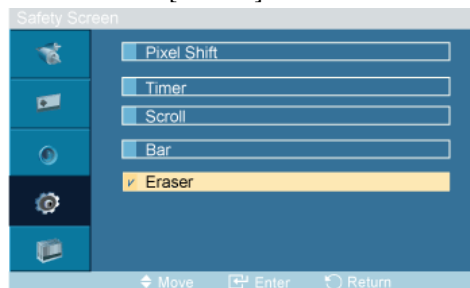

This function prevents after-images on the screen by moving a rectangular pattern.

Resolution Select **P**

MENU → ▼ → ▼ → ▼ → ENTER → [Setup] → ▼ → ▼ → ▼ → ▼ → ▼ → ▼ → ▼ → ▼ → ENTER → [Resolution Select]

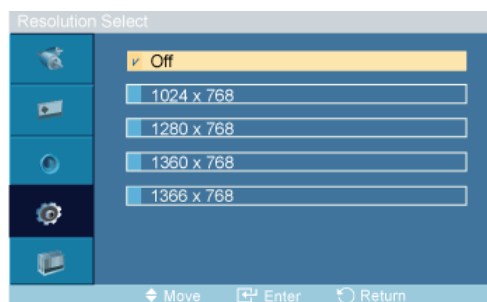

→ ▲ , ▼ → ENTER

When the picture is not displayed properly on the screen when setting the graphics card resolution of the computer to 1024 x 768 @ 60Hz, 1280 x 768 @ 60Hz, 1360 x 768 @ 60Hz or 1366 x 768 @ 60Hz, by using this function(Resolution Select), you can have the picture displayed on the screen in the specified resolution.

Note

Available in **PC** mode only

1. **Off**

2. **1024 X 768**
3. **1280 X 768**
4. **1360 x 768**
5. **1366 X 768**



Note

Selecting the menu is only allowed when the graphics resolution is set to 1024 x 768 @ 60Hz, 1280 x 768 @ 60Hz, 1360 x 768 @ 60Hz or 1366 x 768 @ 60Hz.

Power On Adjustment **PAHMT**

MENU → ▼ → ▼ → ▼ → ENTER → [Setup] → ▼ → ▼ → ▼ → ▼ → ▼ → ▼ → ▼ → ▼ → ▼ → ▼ → ENTER → [Power On Adjustment]

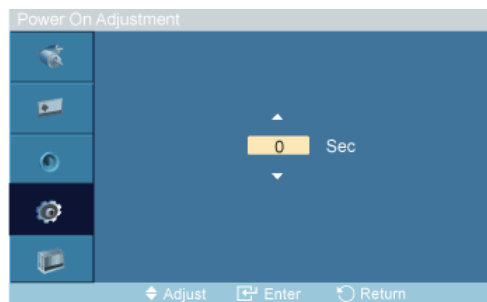

→ ▲, ▼ → ENTER

Adjusts the Power On time for the screen.



Caution: Set the Power On time to be longer to avoid overvoltage.

Side Gray **PAHMT**

MENU → ▼ → ▼ → ▼ → ENTER → [Setup] → ▼ → ▼ → ▼ → ▼ → ▼ → ▼ → ▼ → ▼ → ▼ → ▼ → ENTER → [Side Gray]

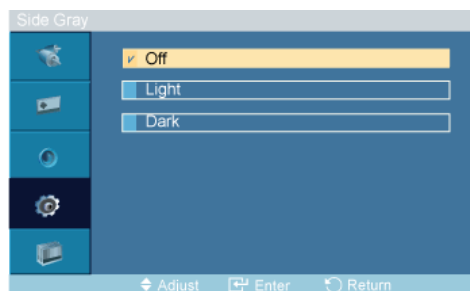

→ ▲, ▼ → ENTER

Select the brightness of the grey for the screen background.

1. **Off**
2. **Light**
3. **Dark**

Reset

Reverts the product settings to factory defaults. The Reset function is only available when **PC / DVI** is being used.

MENU → ▼ → ▼ → ▼ → ENTER → [Setup] → ▼ → ▼ → ▼ → ▼ → ▼ → ▼ → ▼ → ▼ → ▼ → ▼ → ▼ → ▼ → ENTER → [Reset]

Image Reset **P**

MENU → ▼ → ▼ → ▼ → ENTER → [Setup] → ▼ → ▼ → ▼ → ▼ → ▼ → ▼ → ▼ → ▼ → ▼ → ▼ → ▼ → ▼ → ENTER → [Reset] → ENTER → [Image Reset]

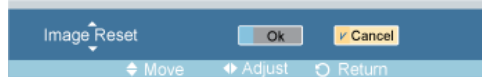

→ ◀ ▶ → ENTER

Note

Available in **PC** mode only

Note

The Reset function is not available when **Video Wall** is **On**.

Color Reset **PAHMT**

MENU → ▼ → ▼ → ▼ → ENTER → [Setup] → ▼ → ▼ → ▼ → ▼ → ▼ → ▼ → ▼ → ▼ → ▼ → ▼ → ▼ → ENTER → [Reset] → ▼ → ENTER → [Color Reset]



→ ◀ ▶ → ENTER

Lamp Control **PAHMT**

MENU → ▼ → ▼ → ▼ → ENTER → [Setup] → ▼ → ▼ → ▼ → ▼ → ▼ → ▼ → ▼ → ▼ → ▼ → ▼ → ▼ → ▼ → ENTER → [Lamp Control]



→ ◀ ▶ → ENTER

Adjusts the inverter lamp in order to reduce energy consumption.

Note

This function does not operate when **Dynamic Contrast** is set to **On** in **PC, DVI, AV, HDMI, TV** modes.

Multi Control

Available Modes

- **P** PC / DVI
- **A** AV

- **H** HDMI
- **M** MagicInfo
- **T** TV

 **Note**

- The **TV** menu is available when a TV tuner box is installed.
- The **MagicInfo** menu is available when a network box is installed.

Multi Control **PAHMT**

Assigns an individual ID to the SET.

MENU → ▼ → ▼ → ▼ → ▼ → ENTER → [Multi Control] → ENTER

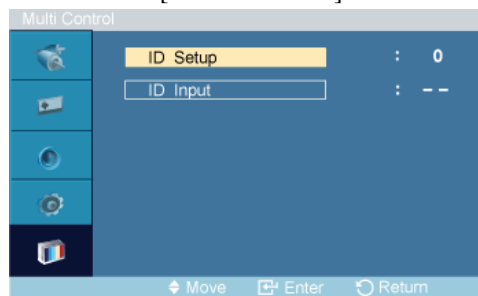

→ ▲, ▼ → [0~9]

- **ID Setup**

Assigns distinctive IDs to the SET.

- **ID Input**

Use to select the transmitter functions of the individual SET. Only a SET where the ID corresponds to the transmitter setting becomes activated.

MagicInfo

Available Modes

- **P** PC / DVI
- **A** AV
- **H** HDMI
- **M** MagicInfo
- **T** TV

 **Note**

- The **TV** menu is available when a TV tuner box is installed.
- The **MagicInfo** menu is available when a network box is installed.



Note

- The operating system for this set only supports English so the other languages might be corrupted on the screen.
- For **MagicInfo**, a remote control is available for **MagicInfo**. However, it is recommended using a separate USB keyboard.
- For **MagicInfo** in Device mode, moving external devices while booting may cause errors. Set up external devices only if the LCD Display turns on.
- Do not unplug the LAN cable used for the network (ex: video display). Otherwise, the program (MagicInfo) may stop. If you do unplug the cable, restart the system.
- Do not unplug the LAN cable used by an USB device (ex: video display). Otherwise, the program (MagicInfo) may stop.
- To access other sources, press the SOURCE button in **MagicInfo**.
- The preset password for the LCD Display is "000000".
- The server program's Power-On option works only if the LCD Display's power is completely shut off.

Please make sure not to use the Power-On option when the LCD Display is in the process of shutting down since this may cause system errors on the LCD Display.

- In the OSD image of **MagicInfo**, Network mode is the same as Device.
- When using **MagicInfo** with the MagicInfo Pro Server Program: perform Network mode.
- When using **MagicInfo** with the device directly connected to LCD Display : execute Device mode.
- Press ALT + F12 to directly go to the **MagicInfo** Window screen.
- To setup **MagicInfo** on a Windows screen, a keyboard and mouse are required.
- To setup **MagicInfo** on a Windows screen, refer to the MagicInfo Server Help.

It is highly recommended not to turn off the AC power during an operation.

- For pivoted LCD Displays, ticker transparency is not supported.
- For pivoted LCD Displays, a screen resolution of up to 720*480(SD) is supported for movies.
- For drive D:, **EFW** is not applied.
- When the contents of Setup have been changed when **EFW** is in the **Enable** state, to save the changes in the disk, you must **Commit** them.
- By selecting **Disable**, **Enable** or **Commit**, the system is restarted.

Photo A small icon of a photo, indicating a photo or image.

The JPEG, BMP file format are supported.

Auto



Automatically fits the image to the window.

Original

Shows the properties of the original file.

Slide Show



Displays the properties of the original file as they are.

Interval



Controls the time intervals between image files for a slide show. (5 Sec, 10 Sec, 20 Sec, 30 Sec, 60 Sec)

Rotation



Displays an image file by turning it clockwise by 90 degrees.

Zoom



Displays a reduced picture.

Close



Closes the image control Menu.

Music **M**



The MP3 file format is supported.

Movie **M**

The MPEG1, WMV file format are supported.

Play



Plays a movie file.

Full Size



Plays a movie file in full screen.

OFFICE / HTML



PPT(Power Point), DOC(MS Word), XLS(MS Excel), PDF, HTML, HTM files are displayed.

Note

- Install the proper viewer(freeware) program to see the MS Office(Word, Excel, Power Point) or PDF documents.

Internet



Connects to the Internet

Setup

Sets various functions in **MagicInfo** mode. A password must be entered to access **Setup** mode.

Schedule View



Displays a schedule.

TCP/IP



Changes the TCP/IP settings.

Connection



Modifies the network settings.

Password



The password can be changed.

- The password should be between 6 and 12 characters in numeric format.
(You should enter a password between 6 and 12 characters in numeric format)
- If you enter the wrong password three times, the setup configuration is reset and a warning message appears from the server.
- If you forget the password, enter Info, 8, 2 and 4 on the remote control to initialize the password. This will reset the previous settings of Setup mode.

File



Local : You can delete or copy files on both local and removable disks.

Play Option



You can set the repeat play and screen settings.

Repeat : Determines the repeat option for playing movies and music.

- **None** - Select No Repeat to play a movie or tune in the list only once.
- **File Repeat** - Select Repeat File to play a movie or tune in the list repeatedly.
- **List Repeat** - Select Repeat List to play movies or tunes in the list in sequence repeatedly.

Rotation - Sets the picture orientation.

- **Landscape** - Sets the screen resolution to 1366x768 pixels.
- **Portrait** - Sets the screen resolution to 768x1366 pixels.

EFW(Enhanced Write Filter) : Prevents change to and loss of the data saved on the disk.

- **Disable** - Disables **EFW** to allow saved data to be changed data on the protected disk (drive C:). When switching from the **Enable** to the **Disable** state, you can select **Commit**.
- **Enable** - Enables **EFW** to prevent saved data to be changed on the protected disk (drive C:).
- **Commit** - **Commit** the changed data to the protected disk (drive C:) when **EFW** is in the **Enable** state. **Commit** is not available when **EFW** is in the **Disable** state.

Troubleshooting

Self-Test Feature Check



Check the following items yourself before calling for assistance. Contact a Service Center for problems that you cannot solve by yourself.

Self-Test Feature Check

1. Turn off both your computer and the LCD Display.
2. Unplug the video cable from the back of the computer.
3. Turn on the LCD Display.

The figure shown below ("**Check Signal Cable**") appears on a black background when the LCD Display is working normally even though no video signal is detected: While in the Self-Test mode, the LED power indicator remains green and the figure moves around on the screen.



4. Turn off your LCD Display and reconnect the video cable; then turn on both your computer and the LCD Display

If your LCD Display screen remains blank after using the previous procedure, check your video controller and computer system; your LCD Display is functioning properly.

Warning Messages

You can even view the screen at a resolution of 1360(1920) x 768(1080). However, you will receive the following message for a minute; You can choose to change the screen resolution or stay in the current mode during that time. And if the resolution is more than 85Hz, you will see the black screen because the LCD Display does not support over 85Hz.



Refer to Specifications > Preset Timing Modes for the resolutions or frequencies supported by the LCD Display.

Maintenance and Cleaning

- 1) Maintaining the LCD Display Case.

Clean with a soft cloth after disconnecting the power cord.



- Do not use benzene, thinner or other flammable substances, or a wet cloth.
- We recommend that a SAMSUNG cleansing agent is used to prevent damage to the screen.

2) Maintaining the Flat Panel Display Screen.

Clean with a soft cloth (cotton flannel) smoothly.



- Never use acetone, benzene or thinner.
(They may cause flaws or deformation of the screen surface.)
- The user will be required to pay costs and related expenses for repairing damages caused.

Symptoms and Recommended Actions



Note

A LCD Display recreates visual signals received from the computer. Therefore, if there is a problem with the computer or the video card, this can cause the LCD Display to become blank, have poor coloring, become noisy, and video mode not supported, etc. In this case, first check the source of the problem, and then contact a Service Center or your dealer.

1. Check if the power cord and the video cables are properly connected to the computer.
2. Check if the computer beeps more than 3 times when booting.
(If it does, request an a service for the main board of the computer.)
3. If you installed a new video card or if you assembled the PC, check if you installed the Adaptor (video).
4. Check if the scanning ratio of the video screen is set to between 50 Hz ~ 85 Hz.
(Do not exceed 60Hz when using the maximum resolution.)
5. If you have problems in installing the Adaptor (video) driver, boot the computer in Safe Mode, remove the Display Adaptor in the "Control Panel → System → Device Administrator" and then reboot the computer to reinstall the Adaptor (video) driver.

Check List



Note

- The following table lists possible problems and their solutions. Before calling for assistance, check the information in this section to see if you can remedy any problems for yourself. If you do need assistance, please call the phone number on the Information section or contact your dealer.
- For more network-related information, refer to the MagicInfo Troubleshooting section.

Problems related to the Installation (PC Mode)



Note

Problems related to the LCD Display installation and their solutions are listed.

Q: The LCD Display screen flickers.

A: Check if the signal cable between the computer and the LCD Display is securely connected.

(Refer to Connecting a Computer)

Problems related to the Screen



Note

Problems related to the LCD Display screen and their solutions are listed.

Q: The screen is blank and the power indicator is off.

A: Ensure that the power cord is firmly connected and the LCD Display is on.

(Refer to the Connecting a Computer)

Q: "**Check Signal Cable**" message.

A: Ensure that the signal cable is firmly connected to the PC or video sources.

(Refer to the Connecting a Computer)

A: Ensure that the PC or video sources are turned on.

Q: "**Not Optimum Mode**" message.

A: Check the maximum resolution and the frequency of the video Adaptor.

A: Compare these values with the data in the Preset Timing Modes Chart.

Q: The picture rolls vertically.

A: Check if the signal cable is securely connected. Re-connect it, if necessary.

(Refer to Connecting a Computer)

Q: The image is not clear; picture is blurred.

A: Run Frequency **Coarse** and **Fine** tuning.

A: Turn on again after removing all accessories (video extension cable, etc.)

A: Set the resolution and frequency to the recommended ranges.

Q: The picture image is unstable and shakes.

A: Check if the resolution and frequency set for the computer video card falls in the range supported by the LCD Display. If not, reset them referring to the current Information under the LCD Display menu and Preset Timing Modes.

Q: Ghost images are shown in the picture.

A: Check if the resolution and frequency set for the computer video card falls in the range supported by the LCD Display. If not, reset them referring to the current Information under the LCD Display menu and Preset Timing Modes.

Q: The image is too light or too dark.

A: Adjusts the **brightness** and **contrast**.

(Refer to the **Brightness, Contrast**)

Q: The screen color is inconsistent.

- A: Adjust color using **Custom** under OSD Color Adjustment menu.
- Q: The color image is distorted by dark shadows.
- A: Adjust color using **Custom** under OSD Color Adjustment menu.
- Q: The color white is poor.
- A: Adjust color using **Custom** under OSD Color Adjustment menu.
- Q: The Power Indicator blinks.
- A: The LCD Display is currently saving the changes made in the settings to the OSD memory.
- Q: The screen is blank and the power indicator light blinks every 0.5 or 1 seconds.
- A: The LCD Display is using its power management system.
- A: Press any key on the keyboard.
- Q: The screen is blank and it is blinking.
- A: If you see the "**TEST GOOD**" message on the screen when you pressing the MENU button, check the cable connection between the LCD Display and the computer to ensure that the connector is properly connected.

Problems related to Audio



Problems related to audio signals and their solutions are listed below.

- Q: No sound.
- A: Ensure that the audio cable is firmly connected to both the audio-in port on your LCD Display and the audio-out port on your sound card.
- (Refer to the Connecting a Computer)
- A: Check the volume level.
- Q: The sound level is too low.
- A: Check the volume level.
- A: If the volume is still too low after turning the control to its maximum, check the volume control on the computer sound card or software program.
- Q: The sound is too high or too low.
- A: Adjusts the **Treble** and **Bass** to the appropriate levels.

Problems related to the Remote Control



Problems related to the remote control and their solutions are listed.

- Q: The remote control buttons do not respond.
- A: Check the polarities (+/-) of the batteries.
- A: Check if the batteries are empty.

- A: Check if the power is on.
- A: Check if the power cord is securely connected.
- A: Check if a special fluorescent or neon lamp is on in the vicinity.

Problems related to MagicInfo



Making a Bootable USB Flash Disk.

- Q: Making a Bootable USB Flash Disk
- A: 1) You can turn a common 512-MB or bigger USB storage media into a bootable disk using a USB bootable disk creation tool. (For example, the HP USB Disk Storage Format Tool)
- A: 2) Copies the OS ghost image and executables to your USB disk.
- A: 3) Enter the BIOS menu of your set by pressing the F2 key in the BIOS logo screen. Then, enable the USB Boot First option by selecting that option and pressing the Enter key in the Boot menu.
- A: 4) Switch your set on while your USB disk is connected and boot up in DOS mode.
- A: 5) Run C:\ghost.exe and choose Local → Partition → From Image from the menu. Choose the ghost image to update your USB disk with and choose the target disk.
- A: 6) When the ghost image update finishes, the set will be rebooted automatically.

Q & A

- Q: How can I change the frequency?
- A: The frequency can be changed by reconfiguring the video card.



that video card support can vary, depending on the version of the driver used. (Refer to the computer or the video card manual for details.)

- Q: How can I Adjusts the resolution?
- A: Windows XP:
Set the resolution in the Control Panel → Appearance and Themes → Display → Settings.
- A: Windows ME/2000:
Set the resolution in the Control Panel → Display → Settings.
* Contact the video card manufacturer for details.
- Q: How can I set the Power Saving function?
- A: Windows XP:
Set the resolution in the Control Panel → Appearance and Themes → Display → Screen Saver.
Set the function in the BIOS-SETUP of the computer. (Refer to the Windows / Computer Manual).
- A: Windows ME/2000:

Set the resolution at the Control Panel → Display → Screen Saver.

Set the function in the BIOS-SETUP of the computer. (Refer to the Windows / Computer Manual).

Q: How can I clean the outer case/LCD Panel?

A: Disconnect the power cord and then clean the LCD Display with a soft cloth, using either a cleaning solution or plain water.

Do not leave any detergent or scratches on the case. Do not let any water enter the LCD Display.

Q: How can I play the video?

A: The video supports the MPEG1 and WMV codecs only. Install the corresponding codec to play the video. Note that some of the codecs can be incompatible.



Note

Before calling for assistance, check the information in this section to see if you can remedy any problems yourself. If you do need assistance, please call the phone number on the Information section or contact your dealer.

Specifications

General

General

Model Name	SyncMaster 400MX(n)
	SyncMaster 460MX(n)

LCD Panel

Size	SyncMaster 400MX(n)	40 " Diagonal (101 cm)
	SyncMaster 460MX(n)	46 " Diagonal (116 cm)
Display area	SyncMaster 400MX(n)	885.17 mm (H) X 497.7 mm (V)
	SyncMaster 460MX(n)	1018.08 mm (H) X 572.7 mm (V)
Pixel Pitch	SyncMaster 400MX(n)	0.648 mm (H) X 0.648 mm (V)
	SyncMaster 460MX(n)	0.53025 mm (H) x 0.53025 mm (V)

Synchronization

Horizontal	30 ~ 81 kHz
Vertical	56 ~ 85 Hz

Display Color

16.7 M

Resolution

Optimum resolution	SyncMaster 400MX(n)	1360 x 768 @ 60 Hz/1366 x 768 @ 60 Hz depends on graphics card used
	SyncMaster 460MX(n)	1920 x 1080 @ 60 Hz
Maximum resolution	SyncMaster 400MX(n)	1920 x 1080 @ 60 Hz (RB)
	SyncMaster 460MX(n)	1920 x 1080 @ 60 Hz

Input Signal, Terminated

RGB Analog, DVI(Digital Visual Interface) Compliant Digital RGB

0.7 Vp-p \pm 5 %

Separate H/V sync, Composite, SOG

TTL level (V high \geq 2.0 V, V low \leq 0.8 V)

Maximum Pixel Clock

165MHz (Analog,Digital)

Power Supply

AC 100 - 240 V~ (+/- 10 %), 50/60 Hz ± 3 Hz

Signal Cable

15pin-to-15pin D-sub cable, Detachable

DVI-D to DVI-D connector, Detachable

Dimensions (W x H x D) / Weight

SyncMaster 400MX(n) 971.0 x 582.0 x 119.0 mm / 38.2 x 22.9 x 4.7 inch (Without Stand)

971.0 x 643 x 311.0 mm / 38.2 x 25.3 x 12.2 inch (With Stand) /
19.0 kg / 41.9 lbs

(With protection glass-option) 22.5 kg / 49.6 lbs

SyncMaster 460MX(n) 1102.0 x 658.0 x 125.5 mm / 43.4 x 25.9 x 4.9 inch (Without Stand)

1102.0 x 719.0 x 311.0 mm / 43.4 x 28.3 x 12.2 inch (With Stand) /
27.0 kg / 59.5 lbs

(With protection glass-option) 32.0 kg / 70.5 lbs

VESA Mounting Interface

600 x 400 mm

Environmental considerations

Operating Temperature : 50°F ~ 104°F (10°C ~ 40°C)

Humidity : 10 % ~ 80 %, non-condensing

Storage Temperature : -4°F ~ 113°F (-20°C ~ 45°C)

Humidity : 5 % ~ 95 %, non-condensing

Plug and Play Capability

This LCD Display can be installed on any Plug & Play compatible system. The interaction of the LCD Display and the computer systems will provide the best operating conditions and LCD Display settings. In most cases, the LCD Display installation will proceed automatically, unless the user wishes to select alternate settings.

Dot Acceptable

TFT-LCD panels manufactured by using advanced semiconductor technology with precision of 1ppm (one millionth) above are used for this product. But the pixels of RED, GREEN, BLUE and WHITE color appear to be bright sometimes or some black pixels may be seen. This is not from bad quality and you can use it without any problems.

For example, the number of TFT-LCD sub pixels contained in this product are 3,133,440 (6,220,800).



Design and specifications are subject to change without prior notice.

 **Class B Equipment (Information Communication equipment for residential use)**

This product complies with the Electromagnetic Compatibility Directives for residential use and can be used in all areas including common residential areas. (Class B equipment emits less electromagnetic waves than Class A equipment.)

MagicInfo - Client

 **Note**

This is activated when a network box is installed in the MXn or MX model.

Item		Specification	Remarks
LAN		1 Gbps	
USB		Keyboard/Mouse, Mass Storage Device Compatible	USB removable storage can be supported.
Contents	Photo	Supported File Format : BMP/JPEG	2274x1704 or less
	Music	Supported File Format : MP3	Sound bandwidth : 50 Hz to 15 kHz
	Movie	- MPEG1, WMV - Max 1280 x 720 30 fps	
	File	MS Office(Word, Excel, Power Point), HTML, PDF	- Some files may not be supported depending on the format or the version. - Install the proper viewing (freeware) program to see MS Office (Word, Excel, Power Point) or PDF documents.
Internet Browser		MS Internet Explorer	Not Support Flash, Java Applet, Security Site
Language		English	
OS		Windows XP Embedded	

MagicInfo Pro - Server Requirement

 **Note**

This is activated when a network box is installed in the MXn or MX model.

	CPU	RAM	Ethernet	OS	Application
Minimum	P1.8 GHz	256 M	100 M / 1 G	Windows XP	WMP 9 or later
Recommended	P3.0 GHz	512 M	100 M / 1 G	Windows XP	WMP 9 or later

PowerSaver

This LCD Display has a built-in power management system called PowerSaver. This system saves energy by switching your LCD Display to low-power mode when it has not been used for a certain amount of time. The LCD Display automatically returns to normal operation when you press a key on the keyboard. For energy conservation, turn your LCD Display OFF when it is not needed, or when leaving it unattended for long periods. The PowerSaver system operates with a VESA DPM compliant

video card installed in your computer. Use the software utility installed on your computer to set up this feature.

PowerSaver (When used as a Network monitor)

State	Normal Operation	Power saving mode	Power off (Power-button)	Power off (Power-switch)
Power Indicator	On	Blinking	On	Off
Power Consumption	400MXn	228 W	Less than 5 W	Less than 5 W
	460MXn	310 W	Less than 5 W	Less than 5 W

PowerSaver (When used as a normal monitor)

State	Normal Operation	Power saving mode	Power off (Power-button)	Power off (Power-switch)
Power Indicator	On	Blinking	On	Off
Power Consumption	400MX	180 W	Less than 2 W	Less than 2 W
	460MX	240 W	Less than 2 W	Less than 2 W

Preset Timing Modes

If the signal transferred from the computer is the same as the following Preset Timing Modes, the screen will be adjusted automatically. However, if the signal differs, the screen may go blank while the power LED is on. Refer to the video card manual and adjusts the screen as follows.

Display Mode	Horizontal Frequency (kHz)	Vertical Frequency (Hz)	Pixel Clock (MHz)	Sync Polarity (H/V)
IBM, 640 x 350	31.469	70.086	25.175	+/-
IBM, 640 x 480	31.469	59.940	25.175	-/-
IBM, 720 x 400	31.469	70.087	28.322	-/+
MAC, 640 x 480	35.000	66.667	30.240	-/-
MAC, 832 x 624	49.726	74.551	57.284	-/-
MAC, 1152 x 870	68.681	75.062	100.000	-/-
VESA, 640 x 480	37.861	72.809	31.500	-/-
VESA, 640 x 480	37.500	75.000	31.500	-/-
VESA, 800 x 600	35.156	56.250	36.000	+/+
VESA, 800 x 600	37.879	60.317	40.000	+/+
VESA, 800 x 600	48.077	72.188	50.000	+/+
VESA, 800 x 600	46.875	75.000	49.500	+/+
VESA, 848 x 480	31.020	60.000	33.750	+/+
VESA, 1024 x 768	48.363	60.004	65.000	-/-
VESA, 1024 x 768	56.476	70.069	75.000	-/-
VESA, 1024 x 768	60.023	75.029	78.750	+/+
VESA, 1152 x 864	67.500	75.000	108.000	+/+
VESA, 1280 x 768	47.776	59.870	79.500	-/+

Display Mode	Horizontal Frequency (kHz)	Vertical Frequency (Hz)	Pixel Clock (MHz)	Sync Polarity (H/V)
VESA, 1280 X 960	60.000	60.000	108.000	+/+
VESA, 1280 X 1024	63.981	60.020	108.000	+/+
VESA, 1280 X 1024	79.976	75.025	135.000	+/+
VESA, 1360 x 768	47.712	60.015	85.500	+/+
VESA, 1600 x 1200	75.000	60.000	162.000	+/+
VESA, 1920 x 1080	66.587	59.934	138.500	+/-

Horizontal Frequency

The time to scan one line connecting the right edge to the left edge of the screen horizontally is called the Horizontal Cycle and the inverse number of the Horizontal Cycle is called the Horizontal Frequency. Unit: kHz



Vertical Frequency

Like a fluorescent lamp, the screen has to repeat the same image many times per second to display an image to the user. The frequency of this repetition is called the Vertical Frequency or Refresh Rate. Unit: Hz

Information

For Better Display

➤ Adjust the computer resolution and screen injection rate (refresh rate) on the computer as described below to enjoy the best picture quality. You can have an uneven picture quality on screen if the best picture quality is not provided for TFT-LCD.

- Resolution: 1360(1920) x 768(1080)
- Vertical frequency (refresh rate): 60 Hz

➤ TFT-LCD panels manufactured by using advanced semiconductor technology with a precision of 1ppm (one millionth) and above is used for this product. But the pixels of RED, GREEN, BLUE and WHITE color seem to be bright sometimes or some of black pixels could be seen. This is not from bad quality and you can use it without any problems.

- For example, the number of TFT-LCD sub pixels contained in this product are 3,133,440 (6,220,800).

➤ When cleaning the monitor and the panel outside, please apply the recommended small amount of cleaner by using a soft cloth to polish. Do not force the LCD area but rub softly. If excessive force is applied, you may stain it.

➤ If you are not satisfied with the picture quality, you can get better quality of picture by performing the "**Auto Adjustment** function" in display screen that is appeared as window termination button is pressed. If there's still noise after the automatic adjustment, use the **Fine/Coarse** adjustment function.

➤ When viewing a fixed screen for an extended period of time, a residual image or blurriness may appear. Change the mode to energy save or set a screensaver to move the picture when you need to be away from the monitor for an extended period of time.

PRODUCT INFORMATION (Image Retention Free)

➤ *What is Image Retention ?*

Image retention may not occur when a LCD panel is operated under normal conditions.

Normal conditions are defined as continuously changing video patterns. When the LCD panel is operated for a long time with a fixed pattern (over 12 hours), there may be slight difference in voltage between electrodes that work the liquid crystal (LC) in a pixel. The voltage difference between electrodes increases with time, forcing the liquid crystal to lean. When this occurs, the previous image may be seen when the pattern is changed. To prevent this, the accumulated voltage difference must be decreased.

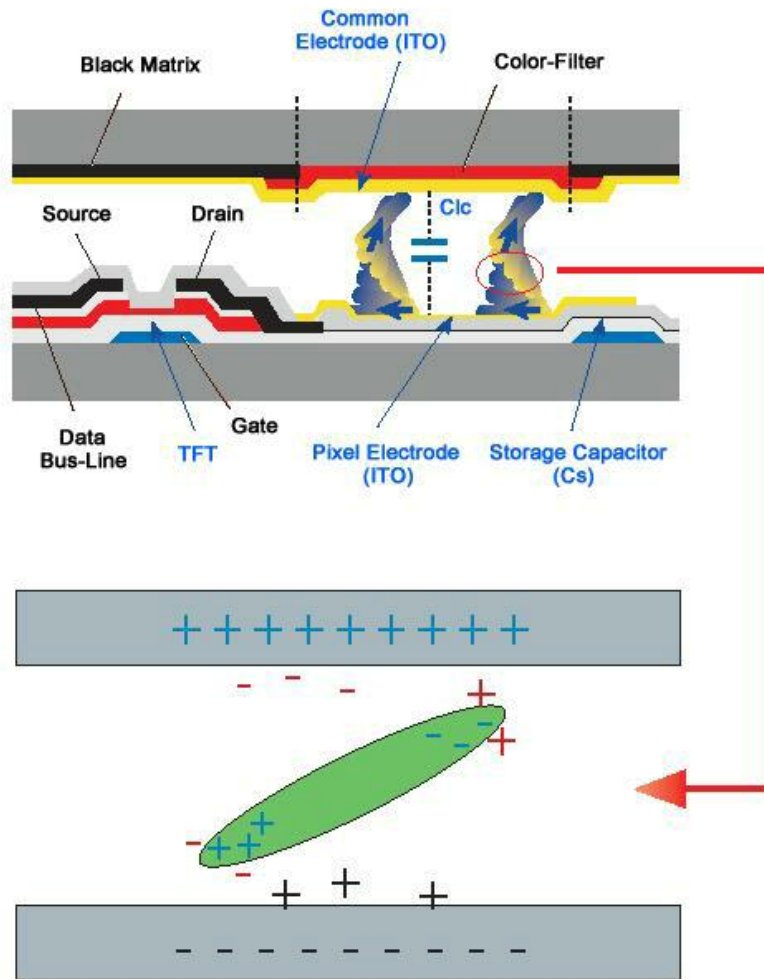

+ *Power Off, Screen Saver, or Power Save Mode*

- Turn the power off for 4 hours after 20 hours in use
- Turn the power off for 2 hours after 12 hours in use
- Set the Monitor to power off with the PC Display Properties Power Scheme.
- Use a Screen saver if possible - Screen saver in one color or a moving image is recommended.

+ *Change the Color Information periodically*

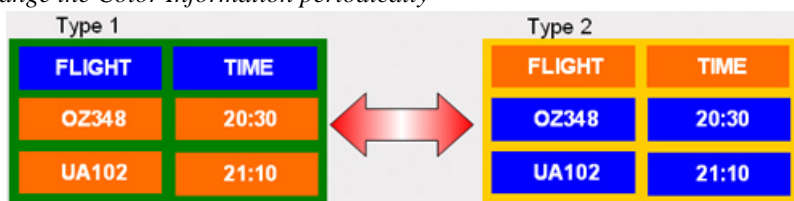

Note

Use Two different colors

Rotate the Color Information with 2 different colors every 30 minutes.

- Avoid using a combination of characters and background color with large difference in luminance.

Avoid using Grey colors, which can cause Image retention easily.

Avoid: Colors with big difference in luminance (Black & White, Grey)



⊕ *Change the characters color periodically*

- Use Bright colors with little difference in luminance.
 - Cycle : Change the characters color and background color every 30 minutes

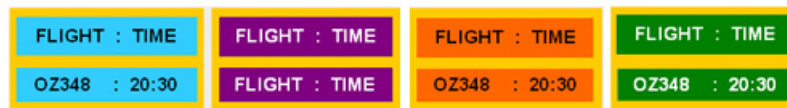

- Every 30 minutes, change the characters with movement.



- All area display Moving image together with Logo periodically.
 - Cycle: Display moving image together with Logo for 60 seconds after 4 hours in use.
- The best way to protect your monitor from Image retention is to turn Power off, or set your PC, or System to operate a Screen Saver program when you are not using it. Also Warranty service will be limited based on instruction guide.

⊕ *Apply the Screen Scroll function on Product*

- Apply the Screen Scroll function
 - Symptom: Horizontal Bar with Black Color move up and down.



- Select method

- Instruction Guide : OSD Menu -> Set Up -> Safety Screen -> Screen Scroll
- Time Interval : 1 ~ 10 hours (Recommend : 1)
- Time Period : 1 ~ 5 second (Recommend : 5)

 **Note**

(Please check CD's User Guide at "OSD Function", some model's will not available)

 *Apply the Screen Pixel function on Product*

- Apply the Screen Pixel function
 - Symptom: Dot with Black Color move up and down.



- Select method

- Instruction Guide : OSD Menu -> Set Up -> Safety Screen -> Pixel
- Time Interval : 1 ~ 10 hours (Recommend : 1)
- Time Period : 10 ~ 50 second (Recommend : 50)
- Apply the Screen Bar function
 - Symptom: Horizontal / Vertical Bar with Black Color move up and down.



- Select method

- Instruction Guide : OSD Menu -> Set Up -> Safety Screen -> Bar
- Time Interval : 1 ~ 10 hours (Recommend : 1)
- Time Period : 10 ~ 50 second (Recommend : 50)

 **Note**

(Please check CD's User Guide at "OSD Function", some model's will not available.)

 *Apply the Screen Erasing function on Product*

- Apply the Screen Erasing function
 - Symptom: 2 Vertical blocks move with erasing the display

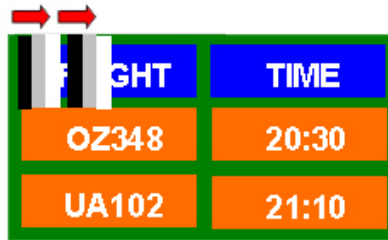

FLIGHT	TIME
OZ348	20:30
UA102	21:10

- Select method

- Instruction Guide : OSD Menu -> Set Up -> Safety Screen -> Eraser
- Time Interval : 1 ~ 10 hours (Recommend : 1)
- Time Period : 10 ~ 50 second (Recommend : 50)

 **Note**

(Please check CD's User Guide at "OSD Function", some model's will not available)

Appendix

Contact SAMSUNG WORLDWIDE



If you have any questions or comments relating to Samsung products, please contact the SAMSUNG customer care center.

North America

U.S.A	1-800-SAMSUNG(726-7864)	http://www.samsung.com/us
CANADA	1-800-SAMSUNG(726-7864)	http://www.samsung.com/ca
MEXICO	01-800-SAMSUNG(726-7864)	http://www.samsung.com/mx

Latin America

ARGENTINE	0800-333-3733	http://www.samsung.com/ar
BRAZIL	0800-124-421	http://www.samsung.com/br
	4004-0000	
CHILE	800-SAMSUNG(726-7864)	http://www.samsung.com/cl
COLOMBIA	01-8000112112	http://www.samsung.com/co
COSTA RICA	0-800-507-7267	http://www.samsung.com/latin
ECUADOR	1-800-10-7267	http://www.samsung.com/latin
EL SALVADOR	800-6225	http://www.samsung.com/latin
GUATEMALA	1-800-299-0013	http://www.samsung.com/latin
HONDURAS	800-7919267	http://www.samsung.com/latin
JAMAICA	1-800-234-7267	http://www.samsung.com/latin
NICARAGUA	00-1800-5077267	http://www.samsung.com/latin
PANAMA	800-7267	http://www.samsung.com/latin
PUERTO RICO	1-800-682-3180	http://www.samsung.com/latin
REP. DOMINICA	1-800-751-2676	http://www.samsung.com/latin
TRINIDAD & TOBAGO	1-800-SAMSUNG(726-7864)	http://www.samsung.com/latin
VENEZUELA	0-800-100-5303	http://www.samsung.com/latin

Europe

AUSTRIA	0800-SAMSUNG (726-7864)	http://www.samsung.com/at
BELGIUM	02 201 2418	http://www.samsung.com/be
CZECH REPUBLIC	800-726-786 (800 - SAMSUNG)	http://www.samsung.com/cz

Distributor pro Českou republiku:
Samsung Zrt., česká organizační složka Vyskočilova 4, 14000 Praha 4

DENMARK	70 70 19 70	http://www.samsung.com/dk
EIRE	0818 717 100	http://www.samsung.com/ie
FINLAND	030-6227 515	http://www.samsung.com/fi
FRANCE	3260 SAMSUNG (€0,15/Min)	http://www.samsung.com/fr
	08 25 08 65 65 (€0,15/Min)	

Appendix

Europe

GERMANY	01805 - SAMSUNG (726-7864)	http://www.samsung.de (€0,14/Min)
HUNGARY	06-80-SAMSUNG (726-7864)	http://www.samsung.com/hu
ITALIA	800-SAMSUNG (726-7864)	http://www.samsung.com/it
LUXEMBURG	02 261 03 710	http://www.samsung.com/lu
NETHERLANDS	0900 SAMSUNG (726-7864)	€ http://www.samsung.com/nl 0,10/Min)
NORWAY	815-56 480	http://www.samsung.com/no
POLAND	0 801 801 881	http://www.samsung.com/pl
	022-607-93-33	
PORTUGAL	80820-SAMSUNG (726-7864)	http://www.samsung.com/pt
SLOVAKIA	0800-SAMSUNG (726-7864)	http://www.samsung.com/sk
SPAIN	902-1-SAMSU(72678)	http://www.samsung.com/es
SWEDEN	0771-400 200	http://www.samsung.com/se
SWITZERLAND	0800-SAMSUNG (726-7864)	http://www.samsung.com/ch
U.K	0845 SAMSUNG (7267864)	http://www.samsung.com/uk

CIS

ESTONIA	800-7267	http://www.samsung.ee
LATVIA	8000-7267	http://www.samsung.com/lv
LITHUANIA	8-800-77777	http://www.samsung.lt
KAZAKHSTAN	8-10-800-500-55-500	http://www.samsung.com/kz_ru
KYRGYZSTAN	00-800-500-55-500	
RUSSIA	8-800-555-55-55	http://www.samsung.ru
TADJIKISTAN	8-10-800-500-55-500	
UKRAINE	8-800-502-0000	http://www.samsung.ua
UZBEKISTAN	8-10-800-500-55-500	http://www.samsung.com/kz_ru

Asia Pacific

AUSTRALIA	1300 362 603	http://www.samsung.com/au
CHINA	800-810-5858	http://www.samsung.com/cn
	400-810-5858	
	010-6475 1880	
	HONG KONG:3698 - 4698	http://www.samsung.com/hk
INDIA	3030 8282	http://www.samsung.com/in
	1-800-3000-8282	
	1800 110011	
INDONESIA	0800-112-8888	http://www.samsung.com/id
JAPAN	0120-327-527	http://www.samsung.com/jp
MALAYSIA	1800-88-9999	http://www.samsung.com/my
NEW ZEALAND	0800 SAMSUNG (0800 726 786)	http://www.samsung.com/nz

Asia Pacific

PHILIPPINES	1800-10-SAMSUNG(726-7864)	http://www.samsung.com/ph
SINGAPORE	1800-SAMSUNG(726-7864)	http://www.samsung.com/sg
THAILAND	1800-29-3232, 02-689-3232	http://www.samsung.com/th
TAIWAN	0800-329-999	http://www.samsung.com/tw
VIETNAM	1 800 588 889	http://www.samsung.com/vn

Middle East & Africa

SOUTH AFRICA	0860-SAMSUNG(726-7864)	http://www.samsung.com/za
TURKEY	444 77 11	http://www.samsung.com/tr
U.A.E	800-SAMSUNG(726-7864)	http://www.samsung.com/ae
	8000-4726	

Terms

Dot Pitch	The image on a monitor is composed of red, green and blue dots. The closer the dots, the higher the resolution. The distance between two dots of the same color is called the 'Dot Pitch'. Unit: mm
Vertical Frequency	The screen must be redrawn several times per second in order to create and display an image for the user. The frequency of this repetition per second is called the Vertical Frequency or Refresh Rate. Unit: Hz Example: If the same light repeats itself 60 times per second, this is regarded as 60 Hz.
Horizontal Frequency	The time to scan one line connecting the right edge to the left edge of the screen horizontally is called the Horizontal Cycle. The inverse number of the Horizontal Cycle is called Horizontal Frequency. Unit: kHz
Interlace and Non-Interlace Methods	Showing the horizontal lines of the screen from the top to the bottom sequentially is called the Non-Interlace method while showing odd lines and then even lines in turn is called the Interlace method. The Non-Interlace method is used for the majority of monitors to ensure a clear image. The Interlace method is the same as that used in TVs.
Plug & Play	This is a function that provides the best quality screen for the user by allowing the computer and the monitor to exchange information automatically. This monitor follows the international standard VESA DDC for the Plug & Play function.
Resolution	The number of horizontal and vertical dots used to compose the screen image is called the 'resolution'. This number shows the accuracy of the display. A high resolution is good for performing multiple tasks as more image information can be shown on the screen. Example: If the resolution is 1360(1920) x 768(1080), this means the screen is composed of 1360(1920) horizontal dots (horizontal resolution) and 768(1080) vertical lines (vertical resolution).

SRS TS XT

This feature outputs sonorous and vivid 3D sound as for 5.1 channel speaker sound but through a 2-channel speaker. It has a good effect when stereo signals are input.

Correct Disposal

Correct Disposal of This Product (Waste Electrical & Electronic Equipment) - Europe only



(Applicable in the European Union and other European countries with separate collection systems)

This marking shown on the product or its literature, indicates that it should not be disposed with other household wastes at the end of its working life. To prevent possible harm to the environment or human health from uncontrolled waste disposal, please separate this from other types of wastes and recycle it responsibly to promote the sustainable reuse of material resources.

Household users should contact either the retailer where they purchased this product, or their local government office, for details of where and how they can take this item for environmentally safe recycling.

Business users should contact their supplier and check the terms and conditions of the purchase contract. This product should not be mixed with other commercial wastes for disposal.

Authority

Information in this document is subject to change without notice.

© 2008 Samsung Electronics Co., Ltd. All rights reserved.

Reproduction in any manner whatsoever without the written permission of Samsung Electronics Co., Ltd. is strictly forbidden.

Samsung Electronics Co., Ltd. shall not be liable for errors contained herein or for incidental or consequential damages in connection with the furnishing, performance, or use of this material.

Samsung is the registered trademark of Samsung Electronics Co., Ltd.; Microsoft, Windows and Windows NT are registered trademarks of Microsoft Corporation; VESA, DPM and DDC are registered trademarks of Video Electronics Standard Association; the ENERGY STAR® name and logo are registered trademarks of the U.S. Environmental Protection Agency (EPA). All other product names mentioned herein may be the trademarks or registered trademarks of their respective owners.



TruSurround XT, SRS and (●) Symbol are trademarks of SRS Labs, Inc. TruSurround XT technology is incorporated under license from SRS Labs, Inc.

CALIFORNIA USA ONLY (Applicable for networking models only.)

This Perchlorate warning applies only to primary CR(Manganese Dioxide) Lithium coin cells in the product sold or distributed ONLY in California USA

*Perchlorate Material - special handling may apply,
See www.dtsc.ca.gov/hazardouswaste/perchlorate.*

Free Manuals Download Website

<http://myh66.com>

<http://usermanuals.us>

<http://www.somanuals.com>

<http://www.4manuals.cc>

<http://www.manual-lib.com>

<http://www.404manual.com>

<http://www.luxmanual.com>

<http://aubethermostatmanual.com>

Golf course search by state

<http://golfingnear.com>

Email search by domain

<http://emailbydomain.com>

Auto manuals search

<http://auto.somanuals.com>

TV manuals search

<http://tv.somanuals.com>