



Distributed by

Design and Specifications are subject to change without notice.
Trademarks of other companies mentioned in these publications are hereby recognized and acknowledged.

LCD Display 200609

VMBL0609CA02HQ-WW

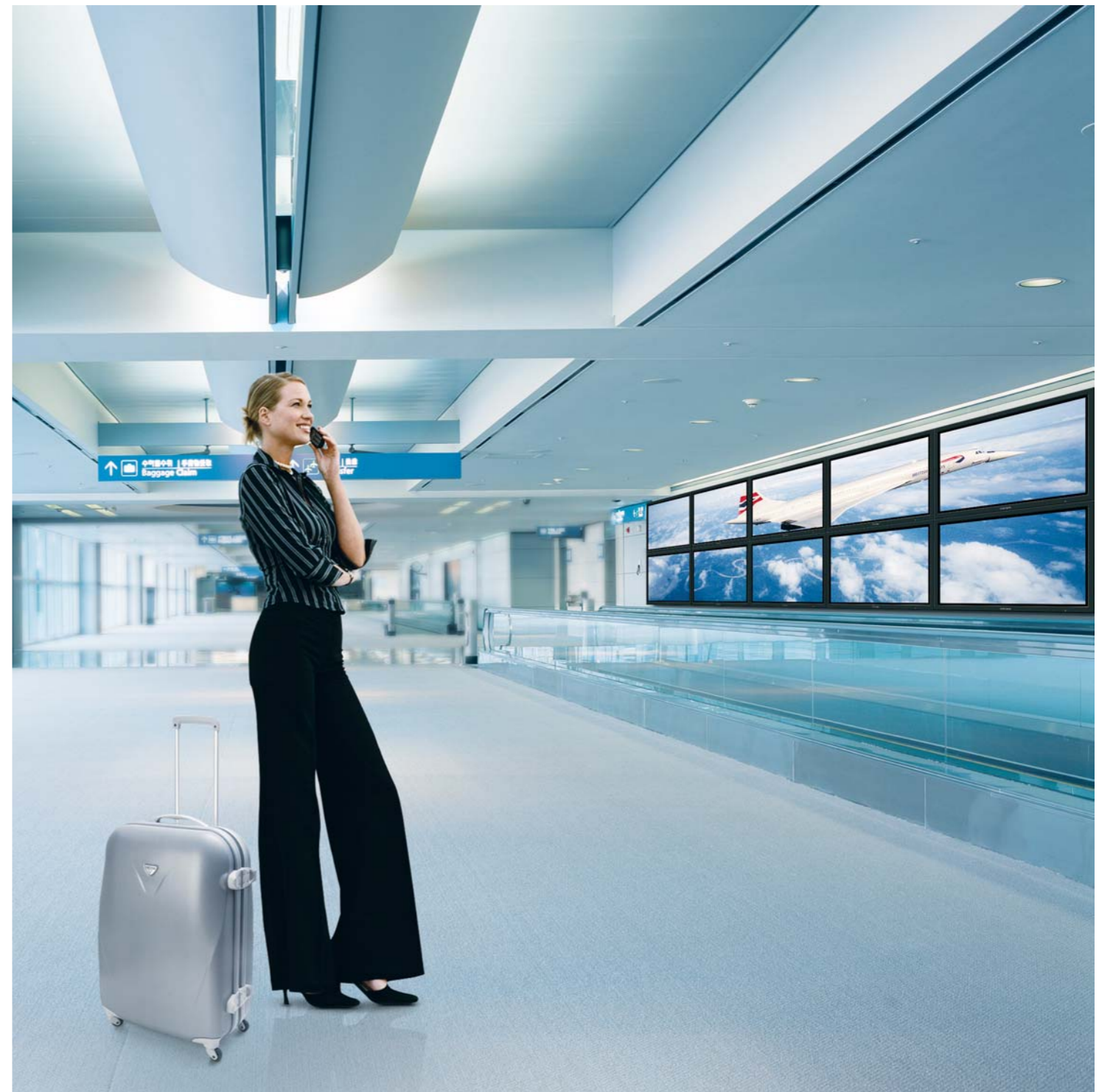

imagine collective impact

Enter the pathway to success guided by **Samsung LCD Monitor**



Business Display

Public Display

Prestigious Display



All the visions are focused on the display and the world come together before you

Large displays have become a necessity in public places like airports, train stations and shopping malls for quick and correct information delivery. Samsung has taken notice of such demands, and is planning to take the lead in the global large display market with its new multi-functional LCD display featuring the world's best picture quality of 1200:1 contrast ratio, 500 cd/m² brightness and fast response time of 8 ms (400PXn). By providing an internal network solution without additional options, Samsung's new display (400PXn, 460PXn, 400TXn) with MagicNet X gives you convenience and cost reduction.



Samsung LCD Display

Picture Quality

The Ultimate Visual Journey through Samsung Technologies

Ever since the invention of the display device, people have wanted to see a bigger and better picture. Digital displays allowed for larger screens, but demand for higher picture quality remained unfulfilled. Samsung, not only provides bigger size display, but also provides best picture quality at the same time.



Matrix Display for Video Wall



5x5

Digital Natural Image engine, DNie™



Samsung's dream is to fulfill the demand for lifelike picture quality by creating natural images with vivid color, and optimal detail and contrast. Our proprietary DNie™ technology, developed through aggressive research & development and 30 years of experience, achieves this dream by taking any signal from a conventional broadcast source and turning it into a stunning picture on any screen.



Conventional



DNie™

Motion Optimizer eliminates noise

Motion Optimizer takes visual data and automatically breaks them into signal and noise, eliminating noise and blur without the slightest damage to the original signal. This guarantees a picture of astounding sharpness, whether the scene is still or moving.

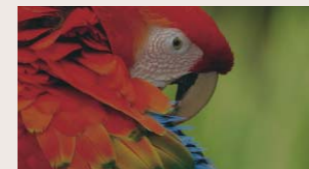

Conventional



DNie™

Color Optimizer shows natural hues

For each scene, Color Optimizer calculates the saturation of red, green, and blue in the input signal and adjusts it to shades that the human eye accepts as natural. Even white tone enhancement produces more striking results when used with DNie™ Color Optimizer.



Conventional



DNie™

Contrast Enhancer boosts light and shade

Conventional contrast enhancers produce noise boosts and flickers. DNie™ has solved these problems by developing an epoch-making algorithm called Contrast Enhancer that recognizes over 1 million criteria for applying contrast, and automatically analyzes up to 70,000 local images within a frame - producing a picture rich in contrast, even in the tiniest details.



Conventional



DNie™

Detail Enhancer sharpens the edges

Detail Enhancer eliminates unnatural effects by automatically analyzing the portion of the signal to be amplified and detecting disturbances to bring the viewer a startlingly sharp and lifelike image.



Conventional



SyncMaster 1200:1

Highest Contrast Ratio

1200:1 SyncMaster 320PX / 400PX / 400PXn / 460PX / 460PXn each boast contrast ratio of 1000/1200:1 surpassing the contrast ratio of regular TVs. They're capable of delivering a clear image even in brightly-lit settings, ensuring that your customers will be able to get the information they want at a glance.

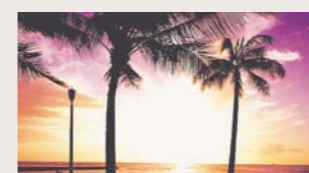

Conventional

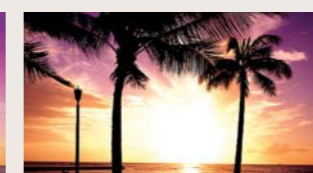

SyncMaster 500cd/m²

Highest Brightness

500cd/m² Samsung LCD Monitors produce remarkably bright pictures - the industry's highest brightness level at 500 cd/m². You will not believe your eyes.



Advanced Panel

The Highest Brightness and Contrast Ratio

A higher brightness ratio brings brilliance to your screen and a higher contrast ratio guarantees an abundance of colors. Typically, brightness and contrast are inversely related. In other words, if brightness goes up, contrast goes down, and vice versa. However, Samsung's LCD Monitor has achieved a flawless balance that no longer has to sacrifice brightness or contrast to achieve the perfect picture. Every scene is always clear and vivid, delivering the details even in bright light. See the Samsung difference.

Matrix Display for Video Wall



3x3



Conventional



8 ms

Fast Response Time



The fast response time of 8 ms ensures stable viewing of DVDs and streaming video.

Ideal for multimedia-driven applications, gaming, animation or for viewing video over the world wide web.

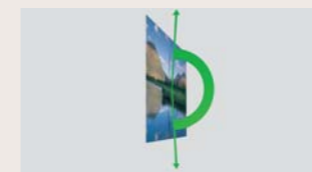

Conventional

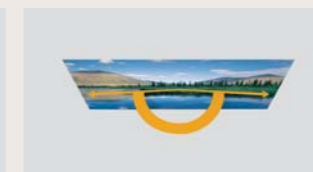

S-PVA

Advanced Wide Viewing Angle



Left side, right side or upside-down, whatever your monitor's location, Samsung's solution allows you to see any display clearly due to the wide viewing angle. Your Monitor will always be well placed to enjoy the entertainment no matter what your angle of view is.



Conventional LCD Display



Samsung LCD Display

Anti-Glare Coating



Special anti-glare coating technology is applied to the screen surface, so the reflection is maximally diffused to ease eyestrain.



Conventional



HD

HD Ready



The first thing you'll notice about Samsung HD Ready feature is the exceptional clarity on a wide screen. With Samsung's cutting-edge technologies HD Ready feature realizes razor-sharp images as vivid as reality itself.

Support HDCP



Samsung Monitors are equipped with DVI-D, which allows for the 100% transmission of visual digital signals when connecting to a PC, STB, DVD, or DTV with visual digital signals. The ability to reproduce sources without any signal loss means perfect image recreation that captures every subtle nuance and exquisite detail that digital technology permits. DVI-D guarantees interface with the digital devices of the future.

Low Power



SyncMaster 320PX/400PX/400PXn/400TXn/460PX/460PXn operate with a low power supply, and a Digital Power Management System DPMS is applied to utilize minimal power (under 1W/5W depending on model) when the unit is in standby mode.

Lamp Control



Used to adjust Backlight in order to reduce energy consumption.

- Auto Lamp Control (by MDC Program)
- 320PX/400PX/400PXn/400TXn/460PX/460PXn : 450 cd/m²-500 cd/m²

Signal Balance



Used to make up for the weak RGB signal which has been transmitted by a long signal cable.

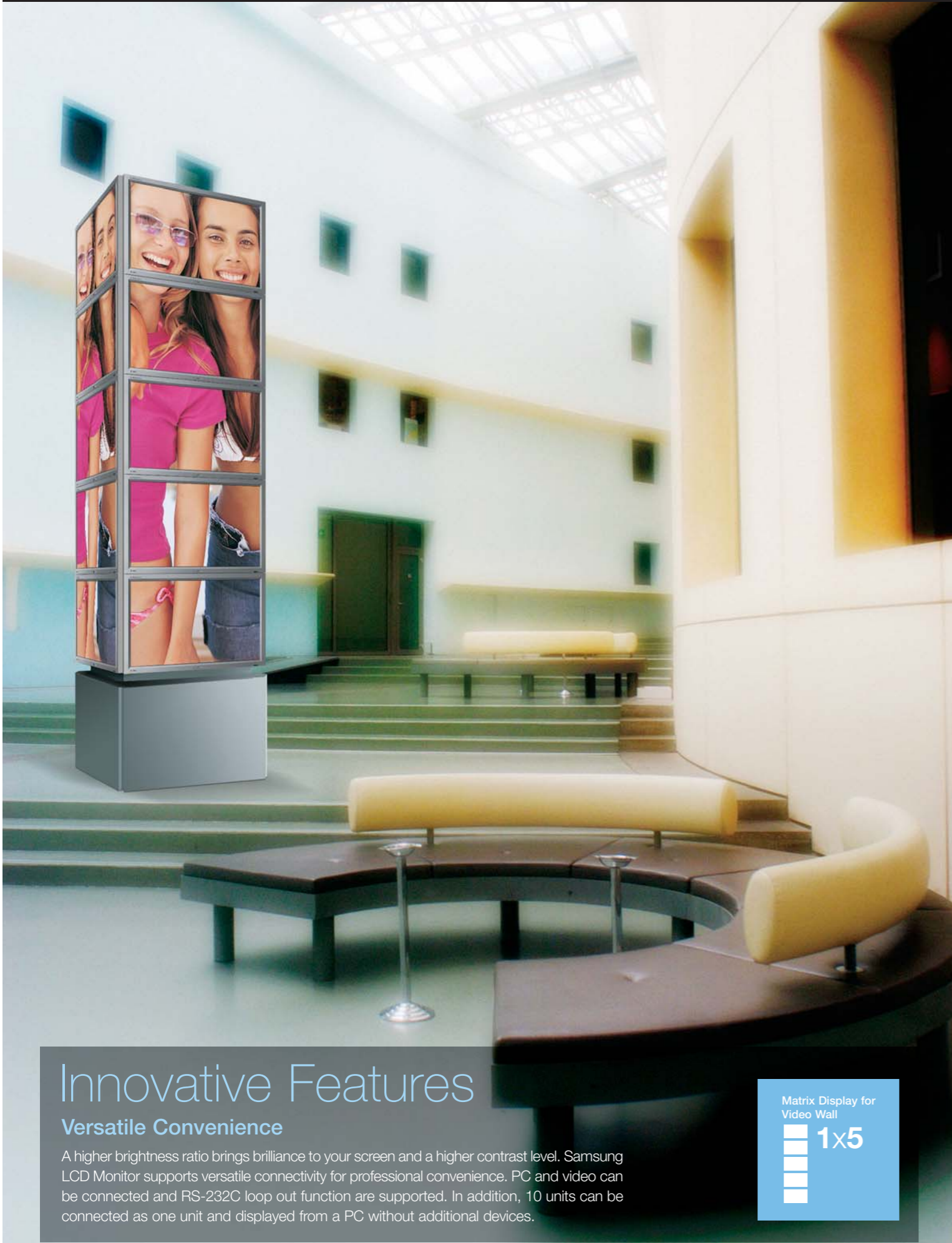

Innovative Features

Versatile Convenience

A higher brightness ratio brings brilliance to your screen and a higher contrast level. Samsung LCD Monitor supports versatile connectivity for professional convenience. PC and video can be connected and RS-232C loop out function are supported. In addition, 10 units can be connected as one unit and displayed from a PC without additional devices.

Matrix Display for Video Wall

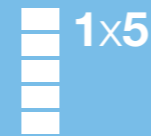

Multi Display Control (MDC)



More control is always good. Especially when it's easy. The built-in RS232C interface lets you control up to 10 units as a single display from your PC. Just open the supplied MDC software, list the units to be controlled, and click on the functions to display. It's that simple.

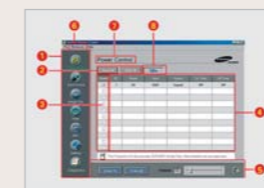

MDC Software Screen Shot

1. Main Icons : Use the main icons to switch to each screen.
2. Select Button : Click Select all or Clear to select or clear all displays.
3. Display Selection : Select a display from Display Selection.
4. Info Grid : Use Grid to view brief information on selected display.
5. Control Tools : Use Control Tools to control displays.
6. Remocon : Allows you to enable or disable the remote control signal receiving function of the display unit.
7. Title : The current title to be controlled is displayed.
8. Comm. Status : Indicates the communication status between the MDC and the display.

Matrix Display for Video Wall

Built-In Image Enlarging Processor supports various video wall formats - 2x2, 3x3, 4x4, 5x5, 1x2, 2x1, 1x5, 5x1. To install Video Wall with these formats, you don't need any other Video Controller Device. Also to use video & PC Interface, additional Input Signal Distributor is not necessary.



Business Display / Department Store

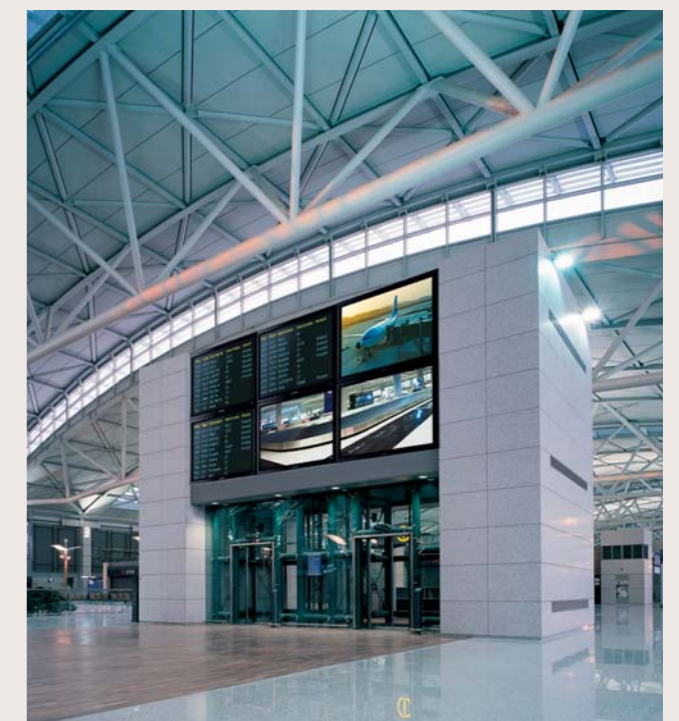

Public Display / Airport

Digital Performance

VESA Standard Supported

 For video wall convenience, Samsung's New LCD Monitor supports VESA wall mounting standards. 320PX/400PX/400PXn/400TXn/460PX/460PXn have mounting holes at 200 mm x 200 mm. This offers customers various installation solutions including wall mount, vertical mount and ceiling mount.





Matrix Display for Video Wall

5x1

Professional Connectivity

 Samsung LCD Monitor supports extended connectivity - PC, Video, RS-232C Loop Out function are supported. If you want to install multi display video wall connected by Video & PC signal, you don't need an additional device like Input Signal Distributor.



2 Way Multi Display Format

  In the case of Multi Display video wall, a major issue is how to display naturally without picture distortion. So Samsung's New LCD Monitor supports two types of video wall formats. The first is Full mode which displays the picture regardless of cabinet bezel. The second, Natural Mode, considers bezel's depth when displaying picture.



Full Mode

Natural Mode

Vertical Image Capability

 SyncMaster 320PX / 400PX / 400PXn / 460PX / 460PXn / 400TXn have a pivot function that freely rotates around 90° degrees, allowing you to easily view a vertical image or text.



Horizontal View

Vertical View

4 Way PIP Function

 For your convenience, SyncMaster 320P/400P/400Pn/460P/460Pn/400Txn have added a Picture in Picture display function. This way you can watch a movie, play a game and still carry out business in a third on-screen window. Work & play at the same time!



Small PIP

Large PIP

Double Window 1

Double Window 2

No Noise & Heat

SyncMaster 320P/400P/400Pn/460P/460Pn stand out from other regular monitors, not just for how they look but also for how quiet they are. Because SyncMaster 320P/400P/400Pn/460P/460Pn generate significantly lower heat than comparable units.

Vertical Input

Landscape idea or portrait idea? You're not limited with Samsung. Our LCD Monitor can be Mounted either horizontally or vertically.

Certified Crestron



We established relationships with the key players needed to deliver display solutions. Crestron Electronics, Inc. has been the leader in the systems integration market. We provide seamless display with Crestron's various integrated solutions.

Digital Performance

MagicNet X

There are two transmission methods. The first is where the server sends files to the clients after registering to the schedule. In the other, the client searches for the files registered in the library of the server, selects the files to be received, and plays them after receiving them via the network. Each client, by itself, has the capability to access the Internet.

Server System Requirements OS : Windows 2000, Windows XP

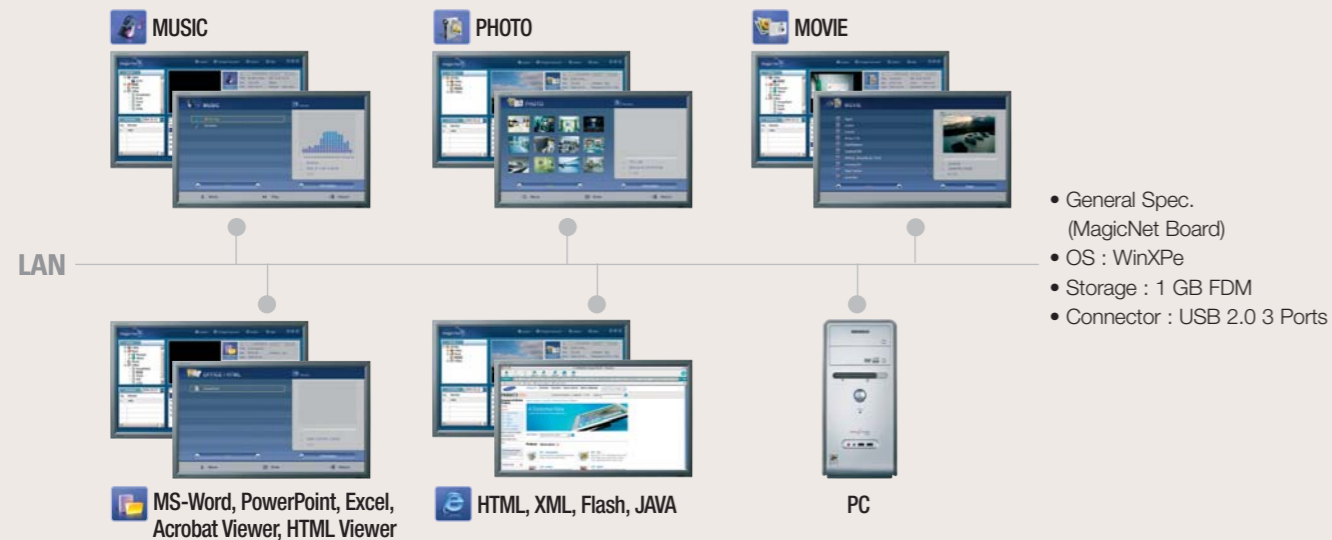

Push Mode

MagicNet transmits media files (photo, audio and movie files) and office files (PowerPoint, Excel, Word, HTML and PDF files: viewer only) existing on a server to clients on an Ethernet network using the server/client architecture.



Pull Mode

Several clients can be connected to a server and any file can be transmitted to any client over the network.



Professional Connectivity

Samsung LCD Monitor supports extended connectivity - PC, Video, RS-232C Loop Out function are supported. If you want to install multi display video wall connected by Video & PC signal, you don't need an additional device like Input Signal Distributor.

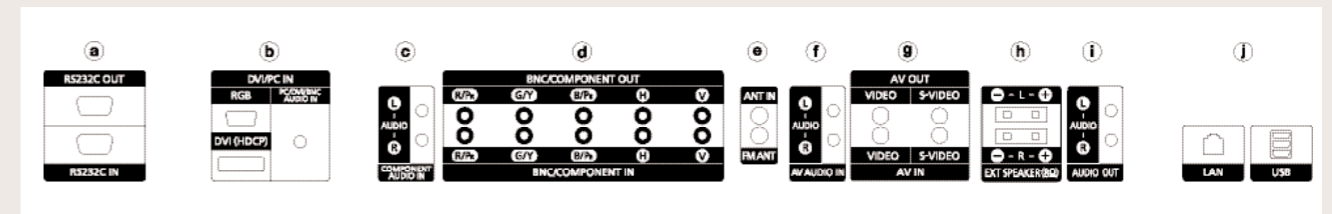

- a RS232C** Connect the supplied power cord.
- b DVI/PC IN**
 - DVI : Connect to the video output jack for device with DVI output.
 - AUDIO : Connect to the audio output jack for devices with DVI output.
 - IN : Connect to the video output jack on your PC.
 - AUDIO : Connect to the audio output jack on your PC.
- c COMPONENT AUDIO In** Video (Y/Pb/Pr) and audio (L/R) inputs for component.
- d BNC/COMPONENT In**
 - Connect for RGB (Y/Pb/Pr) HV video signal input from the PC.
 - > "PC Mode" from this page onward means PC1/PC2 mode using RGB1 (PC1) and RGB2 (PC2)
 - Video (Y/Pb/Pr) and audio (L/R) inputs for component.
- e ANT in/FM Ant**
- f AV AUDIO In**
 - IN : Video and audio inputs for external devices, such as a camcorder or VCR.
 - OUT : Outputs for external devices.
- g AV Out/In (Video)**
 - IN : Video and audio inputs for external devices, such as a camcorder or VCR.
 - OUT : Outputs for external devices.
- h EXT SPEAKER(8Ω)** Connect external speakers.
- i AUDIO Out**
- j LAN/USB**

- a RS232C OUT/IN (RS232C Serial PORT)** MDC (Multiple Display Control) Program Port
- b DVI / PC IN [DVI(HDCP)] (PC Video Connection Terminal)** Using a DVI Cable (DVI-D to DVI-D) - DVI mode (Digital PC)
- c DVI / PC IN [RGB] (PC Video Connection Terminal)** Using a D-Sub Cable (15 pin D-Sub) - PC mode (Analog PC)
- d DVI / PC IN [PC/DVI/BNC AUDIO IN] (PC/DVI/BNC Audio Connection Terminal (Input))**
- e COMPONENT AUDIO IN [L-AUDIO-R] (Component Audio Connection Terminal (Input))**
- f BNC/COMPONENT OUT [R/PR, G/Y, B/PB, H, V] (BNC/Component Connection Terminal (Output))** BNC (Analog PC) Connection: connecting the R, G, B, H, V ports. Component Connection: connecting the PR, Y, PB ports.
- g BNC/COMPONENT IN [R/PR, G/Y, B/PB, H, V] (BNC/Component Connection Terminal (Input))**
- h Kensington Lock** The Kensington lock is a device used to physically fix the system to something when using it in a public place. (The locking device has to be purchased separately.) To use a locking device, contact the place of purchase.
- i AV AUDIO IN [L-AUDIO-R] (LCD Display Audio Connection Terminal (Input))**
- j AV OUT [VIDEO] (VIDEO Connection Terminal): AV mode (Output)**
- k AV IN [VIDEO] (VIDEO Connection Terminal (Input))**
- l AV OUT [S-VIDEO] (S-VIDEO Connection Terminal): S-VIDEO mode (Output)**
- m AV IN [S-VIDEO] (S-VIDEO Connection Terminal (Input))**
- n EXT SPEAKER(8Ω)[- L - +, - - R - +] (EXT Speaker Connection Terminal)**
- o AUDIO OUT [L-AUDIO-R] (LCD Display Audio Connection Terminal (Output))** AUDIO OUT is the terminal for the PC sound output.
- p LAN (LAN Connection Terminal)** MS Internet Explorer
- q USB (USB Connection Terminal)** Keyboard / Mouse, Mass Storage Device Compatible.

Accessories

Stand

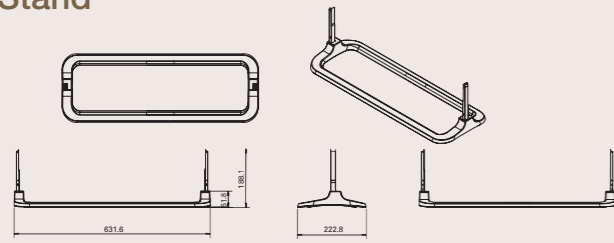

STN-L320PB (320PX)

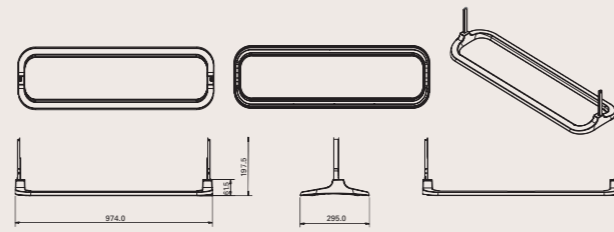

STN-323TB (400PX/400PXn/400TXn)

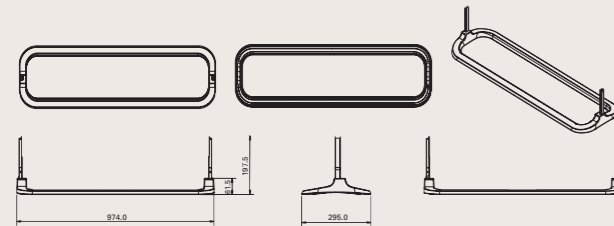

STN-L403TB (460PX/460PXn)

Speaker

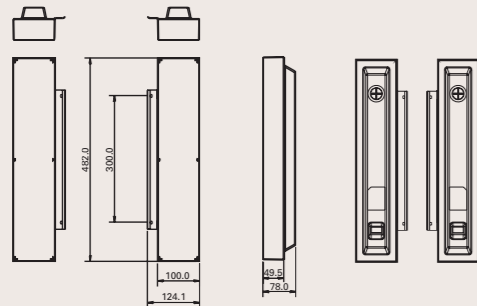

SP-L320PB/S (320PX)

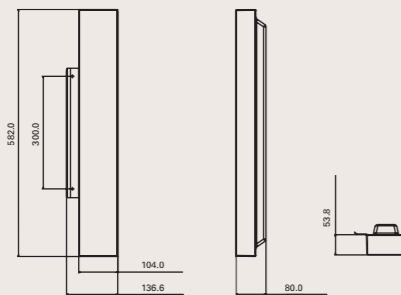

SP-L400PB/S (400PX/400PXn)

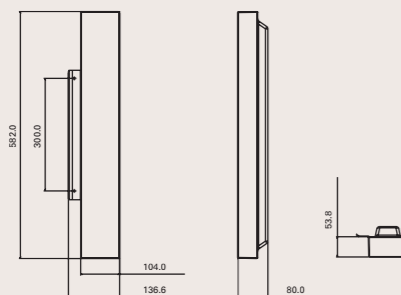

SP-L460PB/S (460PX/460PXn)

Ceiling Mount



CML 500D
(400PX/400PXn/400TXn/460PX/460PXn)

Wall Mount

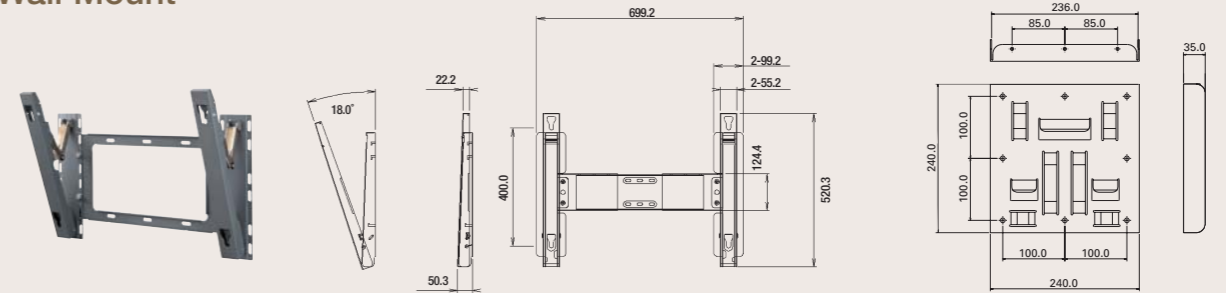

WMB-4050PS (400PX/400PXn/460PX/460PXn)

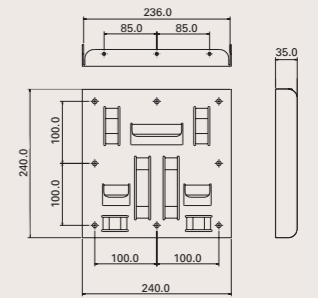

WML4001D (320PX)

Vertical Mount

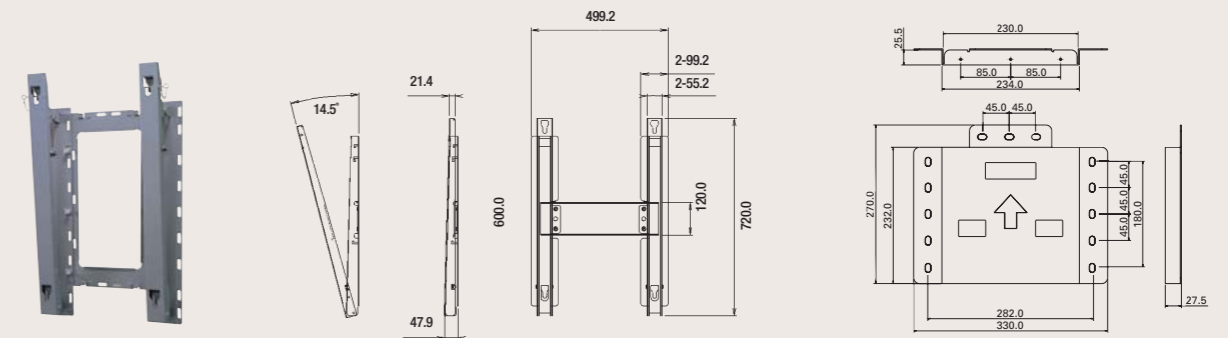

VMN4240D (400PX/400PXn/460PX/460PXn)

WML4001D (320PX)

Components (WMB-4050PS)



WALL BRKT-PLATE: 1 EA



ASSY -HINGE (LEFT): 1 EA



ASSY -HINGE (RIGHT): 1 EA



PLASTIC: 4 EA



SCREW: 11 EA



SCREW: 4 EA



SCREW: 11 EA

Only use the components and accessories shipped with the product.

Wall Bracket Assembly & Wall Bracket & Wall Bracket Angle Adjustment (WMB-4050PS)

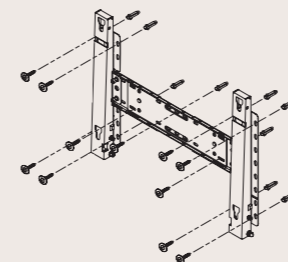

Check the installation diagram and mark the drill points on the wall. Use the 5.0 mm bit to drill holes deeper than 35 mm. Fix each anchor in the corresponding hole. Match each of the brackets and hinge holes to the corresponding anchor holes and insert and tighten the 11 A screws.

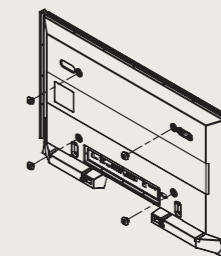

Remove the 4 screws on the back of the product. Insert screw B into the plastic hanger.

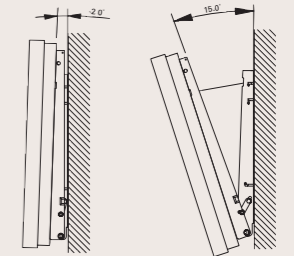

1. Fix the product to the wall bracket.
2. Hold the product at the top in the center and pull it forward (direction of the arrow) to adjust the angle. (See the figure to the right)
3. You can adjust the bracket angle between -2° and 15°.

- Contact a technician for installing the wall bracket.
- Samsung Electronics is not responsible for any damages to the product or harm to customers when the installation is done by the customer.
- This product is intended for installation on cement walls. The product may not be secure when installed on plaster or wood walls.

Professional LCD Models

320PX 400PX(n)



- 1000:1 Contrast Ratio (320PX)
1200:1 Contrast Ratio (400PX(n))
- 450 cd/m² Brightness (320PX)
500 cd/m² Brightness (400PX(n))
- DNIe™ (Digital Natural Image engine)
- Wide Viewing Angle 178° / 178°
- High Native Resolution
- Multimedia Speakers 10 W x 2 ch (option)
- Matrix Video Wall
- PIP / PBP / POP
- MDC (Multi Display Control) through RS232C
- Powerful Anti Image Retention
- Safety Lock
- Support Portrait Display
- Low Power Consumption
- Innovative Power Saving System (DPMS)
- Magicnetwork (Network Model Only)



(Black)



460PX(n)



- 1000:1 Contrast Ratio
- 500 cd/m² Brightness
- Wide Viewing Angle 178° / 178°
- High Native Resolution
- Multimedia Speakers 10 W x 2 ch (option)
- Matrix Video Wall
- PIP / PBP / POP
- MDC (Multi Display Control) through RS232C
- Powerful Anti Image Retention
- Safety Lock
- Support Portrait Display
- Low Power Consumption
- Innovative Power Saving System (DPMS)
- Magicnetwork (Network Model Only)



(Dark Silver)



320PX

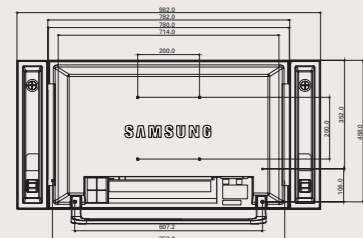
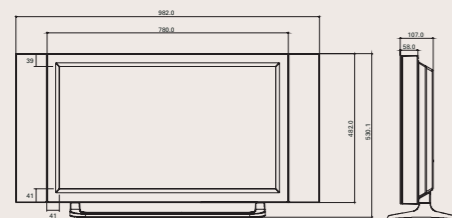

400PX / 400PXn / 400TXn

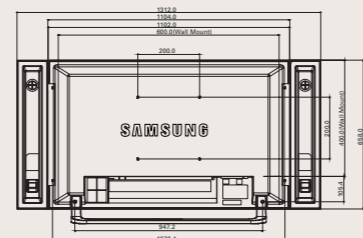
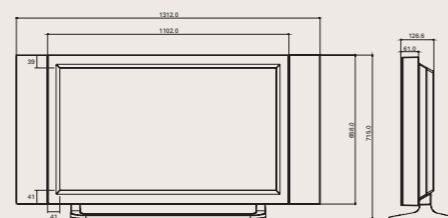

unit (mm)

460PX / 460PXn

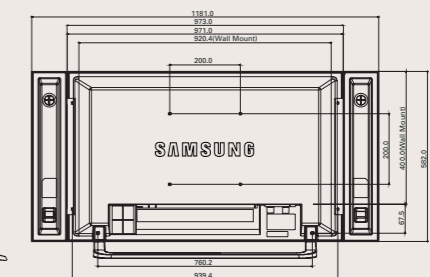
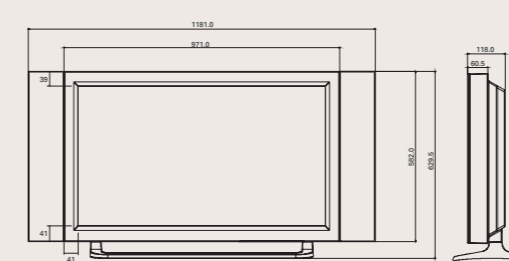

unit (mm)

Specifications

Model Name		320PX	400PX(n)	460PX(n)	400Txn
Display	Diagonal Size	32"	40"	46"	40"
	Pixel Pitch (mm)	0.511 x 0.511	0.648 x 0.648	0.7455 x 0.7455	0.648 x 0.648
	Brightness (typ.)	450 cd/m ²	500 cd/m ²	500 cd/m ²	500 cd/m ²
	Contrast Ratio (typ.)	1000 : 1	1200 : 1	1000 : 1	1200 : 1
	Viewing Angle (H/V)	178° / 178°	178° / 178°	178° / 178°	178° / 178°
	Response Time (ms) (typ.)	8	8	8	8
Frequency	Horizontal Frequency (kHz)	30-70	30-70	30-70	30-70
	Vertical Frequency (Hz)	50-85	50-85	50-85	50-85
Maximum Resolution		1366 x 768	1366 x 768	1366 x 768	1366 x 768
Color Supported		16.7 Mil.	16.7 Mil.	16.7 Mil.	16.7 Mil.
Signal Input	Input Video Signal	Analog RGB,	Analog RGB,	Analog RGB,	Analog RGB,
		BNC, DVI-D,	BNC, DVI-D,	BNC, DVI-D,	BNC, DVI-D,
		CVBS Video	CVBS video	CVBS Video	DVI-D,
		S-Video	S-Video	S-Video	S-Video
		Component Video	Component Video	Component Video	Component Video
	Sync. Type	Separate H/V, Composite, SOG	Separate H/V, Composite, SOG	Separate H/V, Composite, SOG	Separate H/V, Composite, SOG
Input Connectors	D-Sub, DVI-D, S-Video	D-Sub, DVI-D, S-Video	D-Sub, DVI-D, S-Video	D-Sub, DVI-D, S-Video	
	Video (CVBS)	Video (CVBS)	Video (CVBS)	Video (CVBS)	
	BNC (Component/PC)	BNC (Component/PC)	BNC (Component/PC)	BNC (Component/PC)	
Plug & Play-DDC		DDC 2B	DDC 2B	DDC 2B	DDC 2B
Power	On Mode	160 W	230 W	280 W	230 W
	DPMS Mode	<1 W	<1 W	<1 W	<1 W
Cabinet Color	Front Cabinet	Black / Dark Silver	Black / Dark Silver	Black / Dark Silver	Dark Silver
	Back	Black	Black	Black	Black
OSD-Digital Display Director™		Kor / Jap / Chi / Fren / Ita / Swe / Ger / Eng / Spa / Por / Rus			
Supplied Accessories		MDC Program, User Manual,	MDC Program, User Manual,	MDC Program, User Manual,	MDC Program, User Manual,
		Tablefoot 2 pcs,	Tablefoot 2 pcs,	Tablefoot 2 pcs,	Tablefoot 2 pcs,
		RCA Adapter 4 pcs,	RCA Adapter 4 pcs,	RCA Adapter 4 pcs,	RCA Adapter 4 pcs,
		Power Cable,	Power Cable,	Power Cable,	Power Cable,
		Audio Cable, D-sub Cable	Audio Cable, D-sub Cable	Audio Cable, D-sub Cable	Audio Cable, D-sub Cable
Dimension	Set (W x H x D) mm (with stand)	780 x 529 x 223 (option stand)	971 x 629.5 x 223 (option stand)	1102 x 715 x 293 (option stand)	971 x 629.5 x 223 (option stand)
	Set (W x H x D) mm (w/o stand)	780 x 482 x 107	971 x 582 x 118	1102 x 658 x 126.5	971 x 582 x 118
	Packing (W x H x D) mm	898 x 600 x 262	1108 x 700 x 280	1248 x 824 x 304	1108 x 700 x 280
Weight	Net (kg)	17	23.5	33	23.5
	Gross (kg)	20	29.5	38	29.5
Optional Accessories	Speaker	SP-L320PB/S	SP-L400PB/S	SP-L460PB/S	SP-L400PS
	Wall Mount	WMTL4001	WMB-4050PS	WMB-4050PS	WMB-4050PS
	Vertical Mount		VMN4240D	VMN4240D	VMN4240D
	Stand	STN-L320PB	STN-L323TB	STN-L403TB	STN-L323TB
	Network Model		400PXn	460PXn	400TXn

• Specifications mentioned above are subject to change without notice.

Memo

Free Manuals Download Website

<http://myh66.com>

<http://usermanuals.us>

<http://www.somanuals.com>

<http://www.4manuals.cc>

<http://www.manual-lib.com>

<http://www.404manual.com>

<http://www.luxmanual.com>

<http://aubethermostatmanual.com>

Golf course search by state

<http://golfingnear.com>

Email search by domain

<http://emailbydomain.com>

Auto manuals search

<http://auto.somanuals.com>

TV manuals search

<http://tv.somanuals.com>