

HT-D6730W

7.1CH Blu-ray™  
Home Entertainment System  
user manual

imagine the possibilities

Thank you for purchasing this Samsung product.  
To receive more complete service,  
please register your product at  
[www.samsung.com/register](http://www.samsung.com/register)



# Safety Information

## Safety Warnings

TO REDUCE THE RISK OF ELECTRIC SHOCK, DO NOT REMOVE THE COVER(OR BACK). NO USER-SERVICEABLE PARTS ARE INSIDE. REFER SERVICING TO QUALIFIED SERVICE PERSONNEL.

	<b>CAUTION</b> RISK OF ELECTRIC SHOCK DO NOT OPEN	
The lightning flash and Arrowhead within Triangle is awarning sign alerting you of dangerous voltage Inside the product.	<b>CAUTION</b> : TO REDUCE THE RISK OF ELECTRIC SHOCK, DO NOT REMOVE COVER (OR BACK). NO USER SERVICEABLE PARTS INSIDE. REFER SERVICING TO QUALIFIED SERVICE PERSONNEL.	The explanation point within the triangle is a warning sign alerting you of important instructions accompanying the product.

### WARNING

- To reduce the risk of fire or electric shock, do not expose this appliance to rain or moisture.

**CLASS 1 LASER PRODUCT**  
**KLASSE 1 LASER PRODUKT**  
**LUOKAN 1 LASER LAITE**  
**KLASS 1 LASER APPARAT**  
**PRODUCTO LASER CLASE 1**

### **CLASS 1 LASER PRODUCT**

- This product is classified as a CLASS 1 LASER product. Use of controls, adjustments or performance of procedures other than those specified herein may result in hazardous radiation exposure.
- Complies with 21CFR 1040.10 except for deviations pursuant to Laser Notice No. 50, dated June 24, 2007.

### CAUTION

- Apparatus shall not be exposed to dripping or splashing and no objects filled with liquids, such as vases, shall be placed on the apparatus.
- The Mains plug is used as a disconnect device and shall stay readily operable at any time.

### DANGER

VISIBLE AND INVISIBLE LASER RADIATION WHEN OPEN. AVOID DIRECT EXPOSURE TO BEAM. (FDA 21 CFR)

### CAUTION

- CLASS 3B VISIBLE AND INVISIBLE LASER RADIATION WHEN OPEN. AVOID EXPOSURE TO THE BEAM (IEC 60825-1)
- THIS PRODUCT UTILIZES A LASER. USE OF CONTROLS OR ADJUSTMENTS OR PERFORMANCE OF PROCEDURES OTHER THAN THOSE SPECIFIED HEREIN MAY RESULT IN HAZARDOUS RADIATION EXPOSURE. DO NOT OPEN COVER AND DO NOT REPAIR YOURSELF. REFER SERVICING TO QUALIFIED PERSONNEL.

This product satisfies FCC regulations when shielded cables and connectors are used to connect the unit to other equipment. To prevent electromagnetic interference with electric appliances, such as radios and televisions, use shielded cables and connectors for connections.

### FCC NOTE (for U.S.A)

This equipment has been tested and found to comply with the limits for a Class B digital device, pursuant to Part 15 of the FCC Rules. These limits are designed to provide reasonable protection against harmful interference in a residential installation.

This equipment generates, uses and can radiate radio frequency energy and, if not installed and used in accordance with the instructions, may cause harmful interference to radio communications. However, there is no guarantee that interference will not occur in a particular installation.

If this equipment does cause harmful interference to radio or television reception, which can be determined by turning the equipment off and on, the user is encouraged to try to correct the interference by one or more of the following measures:

- Reorient or relocate the receiving antenna.
- Increase the separation between the equipment and receiver.
- Connect the equipment into an outlet on a circuit different from that to which the receiver is connected.
- Consult the dealer or an experienced radio/TV technician for help.

**CAUTION** : FCC regulations state that any unauthorized changes or modifications to this equipment may void the user's authority to operate it.

## 2 English

## Important Safety Instructions

Read these operating instructions carefully before using the unit. Follow all the safety instructions listed below. Keep these operating instructions handy for future reference.

- 1) Read these instructions.
- 2) Keep these Instructions.
- 3) Heed all warnings.
- 4) Follow all instructions.
- 5) Do not use this apparatus near water.
- 6) Clean only with dry cloth.
- 7) Do not block any ventilation openings. Install in accordance with the manufacturer's instructions.
- 8) Do not install near any heat sources such as radiators, heat registers, stoves, or other apparatus (including amplifiers) that produce heat.
- 9) Do not defeat the safety purpose of the polarized or grounding-type plug. A polarized plug has two blades with one wider than the other. A grounding type plug has two blades and a third grounding prong. The wide blade or the third prong are provided for your safety. If the provided plug does not fit into your outlet, consult an electrician for replacement of the obsolete outlet.
- 10) Protect the power cord from being walked on or pinched particularly at plugs, convenience receptacles, and the point where they exit from the apparatus.
- 11) Only use attachment/accessories specified by the manufacturer.
- 12) Use only with the cart, stand, tripod, bracket, or table specified by the manufacturer, or sold with the apparatus. When a cart is used, use caution when moving the cart/ apparatus combination to avoid injury from tip-over.
- 13) Unplug this apparatus during lightning storms or when unused for long periods of time.
- 14) Refer all servicing to qualified service personnel. Servicing is required when the apparatus has been damaged in any way, such as power supply cord or plug is damaged, liquid has been spilled or objects have fallen into the apparatus, the apparatus has been exposed to rain or moisture, does not operate normally, or has been dropped.



# Safety Information

## Precautions

- Ensure that the AC power supply in your house complies with specifications listed on the identification sticker located on the back of your product.
- Install your product horizontally, on a suitable base (furniture), with enough space around it for ventilation (7.5~10cm / 20~25 inches).
- Do not place the product on amplifiers or other equipment which may become hot. Make sure the ventilation slots are not covered.
- Do not stack anything on top of the product.
- Before moving the product, ensure the Disc Insert Hole is empty.
- To disconnect the product completely from the power supply, remove its plug from the wall outlet.
  - If you leave the product unused for a long period of time, disconnect the plug from the wall outlet.
- During thunderstorms, disconnect the AC plug from the wall outlet. Voltage spikes caused by lightning could damage the product.
- Do not expose the product to direct sunlight or other heat sources. This could cause the product to overheat and malfunction.
- Protect the product from moisture, excess heat, and equipment creating strong magnetic or electric fields (i.e. speakers.).
- Disconnect the power cable from the AC supply if the product malfunctions.
- Your product is not intended for industrial use. It is for personal use only.
- Condensation may occur if you store your product or a disc in cold temperatures. If transporting the product during the winter, wait approximately 2 hours until the product has reached room temperature before using.
- The batteries used with this product contain chemicals that are harmful to the environment. Do not dispose of batteries in the general household trash.

## Viewing TV using the 3D function

**IMPORTANT HEALTH AND SAFETY INFORMATION FOR 3D PICTURES. Read and understand the following safety information before using the TV's 3D function.**

### **WARNING**

- Some viewers may experience discomfort while viewing 3D TV such as dizziness, nausea and headaches. If you experience any such symptom, stop viewing 3D TV, remove the 3D Active Glasses, and rest.
- Watching 3D images for an extended period of time may cause eye strain. If you feel eye strain, stop viewing 3D TV, remove your 3D Active Glasses, and rest.
- A responsible adult should frequently check on children who are using the 3D function. If there are any reports of tired eyes, headaches, dizziness, or nausea, have the child stop viewing 3D TV and rest.
- Do not use the 3D Active Glasses for other purposes (such as general eyeglasses, sunglasses, protective goggles, etc.)
- Do not use the 3D function or 3D Active Glasses while walking or moving around. Using the 3D function or 3D Active Glasses while moving around may result in injuries caused by running into objects, tripping, and/or falling.

## Cautions on Handling and Storing Discs

Small scratches on the disc may reduce sound and picture quality or cause skipping.

Be especially careful not to scratch discs when handling them.

## Holding discs

- Do not touch the playback side of the disc.
- Hold the disc by the edges so that fingerprints will not get on the surface.
- Do not stick paper or tape on the disc.



## Disc Storage

- Do not keep in direct sunlight
- Keep in a cool ventilated area
- Keep in a clean protection jacket and store vertically.

### NOTE

- Do not allow the discs to become contaminated with dirt.
- Do not load cracked or scratched discs.

## Handling and Storing Discs

If you get fingerprints or dirt on the disc, clean it with a mild detergent diluted in water and wipe with a soft cloth.

- When cleaning, wipe gently from the inside to the outside of the disc

### NOTE

- Condensation may form if warm air comes into contact with cold parts inside the product. When condensation forms inside the product, it may not operate correctly. If this occurs, remove the disc and let the product stand for 1 or 2 hours with the power on.

## License

- Dolby and the double-D symbol are registered trademarks of Dolby Laboratories.
- "Manufactured under license under U.S. Patent #'s: 5,451,942; 5,956,674; 5,974,380; 5,978,762; 6,226,616; 6,487,535; 7,392,195; 7,272,567; 7,333,929; 7,212,872 & other U.S. and worldwide patents issued & pending. DTS and the Symbol are registered trademarks, & DTS-HD, DTS-HD Master Audio | Essential and the DTS logos are trademarks of DTS, Inc. Product includes software. © DTS, Inc. All Rights Reserved."
- "ABOUT DIVX VIDEO: DivX® is a digital video format created by DivX, Inc. This is an official DivX Certified® device that plays DivX video. Visit [www.divx.com](http://www.divx.com) for more information and software tools to convert your files into DivX video.

**DIVX**  
HD

ABOUT DIVX VIDEO-ON-DEMAND: This DivX Certified® device must be registered in order to play purchased DivX Video-on-Demand (VOD) movies. To obtain your registration code, locate the DivX VOD section in your device setup menu. Go to [vod.divx.com](http://vod.divx.com) for more information on how to complete your registration.

DivX Certified® to play DivX® video up to HD 1080p, including premium content.

DivX®, DivX Certified® and associated logos are trademarks of DivX, Inc. and are used under license."

Covered by one or more of the following U.S. patents : 7,295,673; 7,460,668; 7,515,710; 7,519,274

- HDMI, the HDMI Logo, and High-Definition Multimedia Interface are trademarks or registered trademarks of HDMI Licensing LLC in the United States and other countries.
- Oracle and Java are registered trademarks of Oracle and/or its affiliates. Other names may be trademarks of their respective owners.
- This item incorporates copy protection technology that is protected by U.S. patents and other intellectual property rights of Rovi Corporation. Reverse engineering and disassembly are prohibited.
- Blu-ray Disc™, Blu-ray™, and the logos are trademarks of Blu-ray Disc Association.
- iPod is a trademark of Apple Inc., registered in the U.S. and other countries. iPhone is a trademark of Apple Inc.
- < Open Source License Notice >  
In the case of using open source software, Open Source Licenses are available on the product menu.

**HDMI**  
HIGH-DEFINITION MULTIMEDIA INTERFACE

Made for  
 iPod  iPhone

## Copyright

© 2011 Samsung Electronics Co., Ltd. All rights reserved.

# Contents

## SAFETY INFORMATION

2

- 2 Safety Warnings
- 3 Important Safety Instructions
- 4 Precautions
- 5 Cautions on Handling and Storing Discs
- 5 License
- 5 Copyright

## GETTING STARTED

8

- 8 Key features of your new Blu-ray Home Theater
- 9 Icons that will be used in manual
- 10 Disc Types and Characteristics
- 14 Accessories
- 15 Description
  - 15 Front Panel
  - 16 Rear Panel
- 17 Remote Control

## CONNECTIONS

19

- 19 Connecting the Speakers
- 23 Connecting External Devices/your TV via HDMI
- 24 Connecting the FM Antenna
- 26 Connecting Audio from External Components
- 27 Connecting to a Network

## SETUP

29

- 29 Initial Settings
- 30 Accessing the Settings Menu
- 31 Display
  - 31 3D Settings
  - 32 TV Aspect (Picture Size and Format)
  - 32 Smart Hub Screen Size
  - 32 BD Wise (Samsung Products only)
  - 32 Resolution
  - 34 HDMI Color Format
  - 34 Movie Frame (24 Fs)
  - 34 HDMI Deep Color
  - 34 Still Mode
  - 34 Progressive Mode
- 35 Audio
  - 35 Speaker Settings
  - 36 Musical Room Calibration
  - 36 User EQ
  - 37 HDMI Audio
  - 37 Audio Return Channel
  - 37 Digital Output
  - 38 Dynamic Range Control
  - 39 Audio Sync
- 39 Network
  - 39 Network Settings
  - 42 Network Status
  - 42 BD-LIVE Internet Connection
- 43 System
  - 43 Initial Settings
  - 43 Anynet+ (HDMI-CEC)
  - 43 BD Data Management
  - 43 Time Zone
  - 43 DivX® Video On Demand
  - 43 Reset
  - 44 Language

## SETUP

# 44

- 44 Security
- 44 BD Parental Rating
- 44 DVD Parental Rating
- 44 Change Password
- 44 General
- 44 Front Display
- 44 Light Effect
- 45 Network Remote Control
- 45 Support
- 45 Software Upgrade
- 47 Contact Samsung

## BASIC FUNCTIONS

# 48

- 48 Playing a Disc
- 48 Using the Disc menu / Title menu / Popup menu
- 49 Using the Search and Skip Functions
- 50 Slow Motion Play/Step Motion Play
- 50 Repeat Playback
- 51 Using the TOOLS button
- 53 Listening to Music
- 55 Sound Mode
- 56 Playing back a Picture
- 57 Playing back a USB Storage Device
- 58 Listening to Radio
- 58 Connecting an iPod/iPhone Using the USB Cable
- 58 Connecting an iPod/iPhone Using the Dock
- 59 Use an iPod/iPhone with a Wireless Dock Cradle (sold separately) for iPod/iPhone
- 60 iPod/iPhone Models You Can Use with This Product
- 61 How to Link the Wireless Transmitter with the Main Unit

## NETWORK SERVICES

# 62

- 62 Using Smart Hub
- 71 BD-LIVE™
- 71 Using the AllShare Function

## OTHER INFORMATION

# 72

- 72 Troubleshooting
- 75 Index
- 76 Specifications

- Figures and illustrations in this User Manual are provided for reference only and may differ from actual product appearance.

# Getting Started

## Key features of your new Blu-ray Home Theater

### Product Features

---

#### 3D

This product can play 3D contents through an HDMI cable.

To implement the 3D effect, connect a 3D device (3D-compliant AV receiver, 3D-compliant TV) to the product using an HDMI cable, and play the 3D content while wearing 3D vision glasses.

#### Wireless receiver module

Samsung 's rear-channel wireless receiver module does away with cables running between the product and rear-channel speakers. Instead, the rear speakers connect to a compact wireless receiver module that communicates with the product.

#### Smart Hub

You can download various for pay or free-of charge applications through a network connection. These applications provide a range of Internet services and content including news, weather forecasts, stock market quotes, games, movies, and music.

#### AllShare

You can play videos, music and photos saved on your devices (such as your PC, mobile phones or NAS) through the home theater via a network connection.

#### Audio Sync function

If you have connected the product to a digital TV, video can sometimes lag behind the audio.

To compensate for this, you can adjust the audio delay time so that the audio syncs with the video.

#### iPod Sync function

If the video signal from an iPod player you attached to the product lags behind the audio signal during playback, you can set the audio delay time so that the video and audio match.

#### iPod & iPhone support

If you have connected an iPod player to the home theater using the iPod/iPhone specific USB cable, you can play the music files in the iPod/iPhone through the connected speakers. You can also play video files using the iPod-specific dock, and enjoy iPod music using the wireless transmitter (**sold separately**).

#### BD Wise

BD Wise automatically adjusts BD Wise-compliant Samsung products to their optimal settings.

This feature is enabled only if BD Wise-compliant Samsung products are connected to each other using an HDMI cable.

#### 3D Sound

You can enjoy more natural and vivid surround sound with enriched tones.





















#### ARC (Audio Return Channel)

You can enjoy TV sound from the Home Theater speakers by using just one HDMI cable.



### Icons that will be used in manual

Make sure you understand the following terms before reading the rest of the user manual.

Term	Logo	Icon	Definition
BD-ROM			Indicates a function available on a BD-ROM.
BD-RE/-R			Indicates a function available on a BD-RE/-R disc recorded in the BD-RE format.
DVD-VIDEO			Indicates a function available on a DVD-VIDEO.
DVD-RW(V)			Indicates a function available on recorded DVD+RW or DVD-RW(V)/DVD-R/+R discs that have been recorded and finalized.
DVD-R			
DVD+RW			
DVD+R			
			
Audio CD			Indicates a function available on an audio CD-RW/-R (CD-DA format).
MP3 WMA	-		Indicates a function available in a CD-RW/-R, DVD-RW/-R disc or a USB storage media containing MP3 or WMA contents.
JPEG	-		Indicates a function available in a CD-RW/-R, DVD-RW/-R disc or a USB storage media containing JPEG contents.
DivX MKV MP4			Indicates a function available in a CD-RW/-R, DVD-RW/-R disc or a USB storage media containing DivX contents.
USB storage device	-		Indicates a function available on a USB storage device.
CAUTION	-		Indicates a situation where a function does not operate or settings may be cancelled.
NOTE	-		Indicates tips or instructions that can help you operate a function better.
Shortcut Key	-		Indicates that you can access this function quickly and easily by pressing a button on the remote control.

- This product is compatible with the NTSC color system only.
- PAL discs will not play.

# Getting Started

## Disc Types and Characteristics

### Blu-ray Disc Compatibility

Blu-ray is a new and evolving format. Accordingly, disc compatibility issues are possible. Not all discs are compatible and not every disc will play back. For additional information, refer to the Disc Types and Characteristics section of this Manual.

#### NOTE

- Playback may not work for some types of discs or when you use specific functions such as angle change and aspect ratio adjustment. Information about the discs is written in detail on the box. Please refer to this if necessary.
- Do not allow discs to become dirty or scratched. Fingerprints, dirt, dust, scratches, or deposits of cigarette smoke on the recording surface may make it impossible to playback a disc.
- When you play a BD-Java title, loading may take longer than a normal title or some functions may perform slowly.









### Discs that cannot be played

- HD DVD Disc
- DVD-RAM
- 3.9 GB DVD-R Disc for Authoring.
- DVD-RW(VR mode)
- Super Audio CD(except CD layer)
- DVD-ROM/PD/MV-Disc, etc CVD/CD-ROM/CDV/CD-G/CD-I/LD
- CDGs play audio only, not graphics.

#### NOTE

- Some commercial discs and DVD discs purchased outside your region may not play on this product.
- If a DVD-R/-RW disc has not been recorded properly in DVD video format, it will not play on this product.

## Logos of Discs that can be played

	
Blu-ray Disc	3D Blu-ray Disc
	
Dolby Digital Plus	NTSC broadcast system in U.S.A, Canada, Korea, Japan
	
Dolby TrueHD	DTS-HD High Resolution Audio
	
Java	DTS-HD Master Audio   Essential
	
BD-LIVE	

## Region Code

Both the product and the discs are coded by region. These regional codes must match for the product to play the disc. If the codes do not match, the disc will not play.

Disc Type	Region Code	Area
Blu-ray		North America, Central America, South America, Korea, Japan, Taiwan, Hong Kong and South East Asia.
		Europe, Greenland, French territories, Middle East, Africa, Australia and New Zealand.
		India, China, Russia, Central and South Asia.
DVD-VIDEO		The U.S., U.S. territories and Canada
		Europe, Japan, the Middle East, Egypt, South Africa, Greenland
		Taiwan, Korea, the Philippines, Indonesia, Hong Kong
		Mexico, South America, Central America, Australia, New Zealand, Pacific Islands, Caribbean
		Russia, Eastern Europe, India, most of Africa, North Korea, Mongolia
		China

## Disc Types

### BD-ROM

Blu-ray discs can only be played back. This product can play back pre-recorded commercial BD-ROM discs.

### BD-RE/-R

Blu-ray RE/-R discs can be recorded and played back. This product can play back a BD-RE/-R disc recorded by other compatible Blu-ray disc recorders.

### DVD-VIDEO

- This product can play back pre-recorded commercial DVD discs (DVD-VIDEO discs) with movies.
- When switching from the first layer to the second layer of a dual-layered DVD-VIDEO disc, there may be momentary distortion in the image and sound. This is not a malfunction of the product.

### DVD-RW/-R/+R

This product can play back a DVD-RW/-R/+R disc recorded and finalized with a DVD video recorder. The ability to play back may depend on recording conditions.

### DVD+RW

- This product can play back a DVD+RW disc recorded with a DVD Video recorder. The ability to play back may depend on recording conditions.

### Audio CD (CD-DA)

- This product can play back CD-DA format audio CD-RW/-R discs.
- The product may not be able to play some CD-RW/-R discs due to the condition of the recording.

### CD-RW/-R

- Use 700MB (80 minute) CD-RW/-R discs. Do not use 800MB (90 minute) or larger discs, as these discs may not play back.
- If the CD-RW/-R disc was not recorded as a closed session, you may experience delays when playing back the beginning of the disc or all recorded files may not play.
- Some CD-RW/-R discs may not play on this product, depending on the device which was used to burn them. For contents recorded on CD-RW/-R media from CDs for your personal use, playability may vary depending on the contents and discs.

# Getting Started

## Disc Format

### Using JPEG discs

- The home theater can play back D-R/-RW, DVD-RW/-R discs recorded in the UDF or JOLIET format.
- Only JPEG files with the ".jpg", ".JPG", ".jpeg" or "JPEG" extension can be displayed.
- Progressive JPEG is supported.

### DVD-RW/-R (V)

- This format is used for recording data on DVD-RW or DVD-R discs. This product can play DVD-RW or DVD-R discs if they have been finalized.
- If a disc that has been recorded in Video Mode by a different maker's recorder but has not been finalized, it cannot be played by this product.

## Supported File Formats

### Video File Support

File Extension	Container	Video Codec	Audio Codec	Resolution
*.avi	AVI	DivX 3.11/4.x/5.1/6.0	MP3 AC3 LPCM ADPCM DTS Core	1920x1080
		XviD		1920x1080
		H.264 BP/MP/HP		1920x1080
		MPEG4 SP/ASP		1920x1080
		Motion JPEG		1920x1080
*.mkv	MKV	DivX 3.11/4.x/5.1/6.0	MP3 AC3 LPCM ADPCM DTS Core	1920x1080
		XviD		1920x1080
		H.264 BP/MP/HP		1920x1080
		MPEG4 SP/ASP		1920x1080
		Motion JPEG		1920x1080
*.asf	ASF	DivX 3.11/4.x/5.1/6.0	MP3 AC3 LPCM ADPCM WMA	1920x1080
		XviD		1920x1080
		H.264 BP/MP/HP		1920x1080
		MPEG4 SP/ASP		1920x1080
		Motion JPEG		1920x1080
*.wmv	ASF	Window Media Video v9	WMA	1920x1080
*.mp4	MP4	H.264 BP/MP/HP	MP3	1920x1080
		MPEG4 SP/ASP	ADPCM	1920x1080
		XVID	AAC	1920x1080
*.3gp	3GPP	H.264 BP/MP/HP	ADPCM AAC	1920x1080
		MPEG4 SP/ASP	HE-AAC	1920x1080

File Extension	Container	Video Codec	Audio Codec	Resolution
*.vro	VRO	MPEG2	AC3	1920x1080
	VOB	MPEG1	MPEG LPCM	352x288
*.mpg *.mpeg	PS	MPEG1	AC3	352x288
		MPEG2	MPEG	1920x1080
		H.264	LPCM AAC	1920x1080
*.ts *.tp *.trp	TS	MPEG2	AC3	1920x1080
		H.264	AAC	1920x1080
		VC1	MP3	1920x1080
			DD+ HE-AAC	

### Restrictions

- Some of the Codecs listed above will not play if there is a problem with the contents.
- Corrupt video sources or sources with incorrect container information will not play properly.
- AV sources that exceed the standard bit rate or frame rate may not play properly.
- If the index table is corrupt, the Seek (Jump) function will not be supported.
- If you play a video via the network, it may not play properly depending on the network status.

### Video decoder

- Up to H.264 Level 4.1 supported.
- H.264 FMO/ASO/RS, VC1 SP/MP/AP L4, AVCHD not supported.
- XVID, MPEG4 SP, ASP :
  - Below 1280 x 720: 60 frame max
  - Above 1280 x 720: 30 frame max
- GMC 2 or higher not supported.

### Audio decoder

- Up to WMA 7,8,9 supported.
- WMA 9 PRO with more than two channels (multi-channel) not supported.
- WMA 9 Lossless, Voice not supported.
- WMA sampling rate at 22050Hz mono not supported.

### Music File Support

File Extension	Container	Audio Codec	Support Range
*.mp3	MP3	MP3	-
*.wma	WMA	WMA	Compliant with WMA version 10 * Sampling rates (in kHz) - 8, 11, 16, 22, 32, 44.1, 48 * Bit rates - All bit-rates in the range 5kbps to 384kbps

# Getting Started

## Notes on the USB connection

### Supported devices:







USB storage media, MP3 player, digital camera, USB card reader

- 1) The product does not support folder or file names longer than 125 characters.
- 2) A subtitle file bigger than 300 KB may not be properly displayed.
- 3) Some USB/digital camera devices may not be compatible with the product.
- 4) The product supports the FAT16 and FAT32 file systems.
- 5) Photo (JPEG), music (MP3,) and video files must have Korean or English file names. Otherwise, the files will not play.

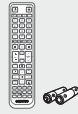

- 6) Connect USB devices directly to the product's USB port. Connecting through a USB cable may cause compatibility problems.
- 7) Inserting more than one memory device into a multi-card reader may cause the reader to operate improperly.
- 8) The product does not support the PTP protocol for digital cameras
- 9) Do not disconnect a USB device during a "loading" process.
- 10) The bigger the image resolution, the longer the image takes to display.
- 11) This player cannot play MP3 files with DRM (Digital Rights Management) downloaded from commercial sites.

## Accessories

Check the box for the supplied accessories listed below.

			
Video Cable (AH39-40001V)	FM Antenna (AH42-00017A)	Soft Cloth (AH81-02286C)	User's Manual (AH68-02336R)
			
Remote Control (AH59-02331A)/ Batteries (AAA size) (4301-000116)	ASC Microphone (AH30-00099A)	iPod Dock (AH96-00051B)	

### Wireless Dock Cradle for iPod/iPhone : HT-WDC10 (sold separately)

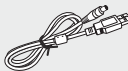
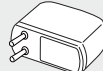
			
Wireless Transmitter (AH96-00641A)	Charging Cradle (AH96-00641B)	DC Power Cord (AH96-00647A)	DC Power Adapter (BN44-00388D)

## Description

## Front Panel

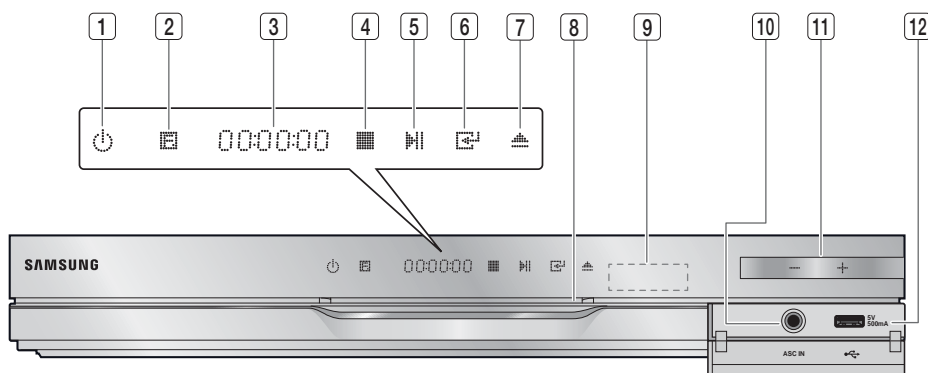

<b>1</b>	<b>POWER BUTTON</b> (⏻)	Turns the product on and off.
<b>2</b>	<b>FUNCTION BUTTON</b>	The mode switches as follows : <b>BD/DVD → D. IN → AUX → R. IPOD → W. IPOD → H. IN1 → H. IN2 → FM</b>
<b>3</b>	<b>DISPLAY</b>	Displays the playing status, time, etc.
<b>4</b>	<b>STOP BUTTON</b>	Stops disc playback.
<b>5</b>	<b>PLAY/PAUSE BUTTON</b>	Plays a disc or pauses playback.
<b>6</b>	<b>ENTER BUTTON</b>	Selects menu items or starts a Blu-ray disc. (It will not start a DVD disc.)
<b>7</b>	<b>EJECT BUTTON</b>	Ejects a Disc.
<b>8</b>	<b>DISC SLOT</b>	Insert disc here.
<b>9</b>	<b>REMOTE CONTROL SENSOR</b>	Detects signals from the remote control.
<b>10</b>	<b>ASC IN JACK</b>	Used to connect the ASC Microphone for setting up MRC (Musical Room Calibration).
<b>11</b>	<b>VOLUME CONTROL</b>	Volume adjustment.
<b>12</b>	<b>USB PORT</b>	You can connect a USB memory flash stick here and use it as storage when the product is connected to BD-LIVE. You can also use the USB Host for software upgrades and MP3/JPEG/DivX/MKV/MP4 playback. And also it is possible to use <b>R. IPOD</b> when iPod is connected.

**NOTE**

- You must use a USB memory flash stick to perform a software upgrade using the USB Host jack.
- When the product displays the Blu-ray disc menu, you cannot start the movie by pressing the **PLAY** button on the product or the remote. To play the movie, you must select Play Movie or Start in the disc menu, and then press the **ENTER** button.

# Getting Started

## Rear Panel

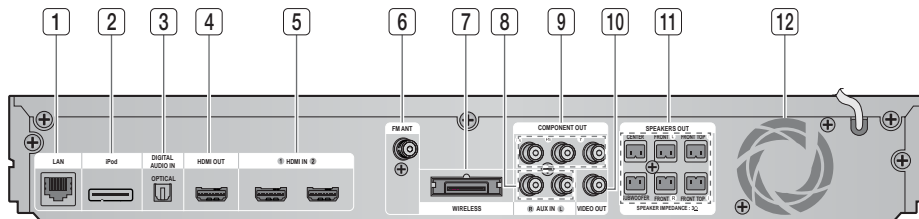

<b>1</b>	<b>LAN TERMINAL</b>	Can be used for network based services (see pages 62~69), BD-LIVE and software upgrade under the network connection.
<b>2</b>	<b>iPod JACK</b>	Connect the iPod dock connector here.
<b>3</b>	<b>EXTERNAL DIGITAL AUDIO IN JACK (OPTICAL)</b>	Connect to the Digital Optical out jack of an external device using a Digital Optical cable.
<b>4</b>	<b>HDMI OUT JACK</b>	Use an HDMI cable, connect this HDMI output terminal to the HDMI input terminal on your TV for the best quality picture.
<b>5</b>	<b>HDMI IN JACKS</b>	Receives digital video and audio signals simultaneously using an HDMI cable.
<b>6</b>	<b>FM ANTENNA JACK</b>	Connect the FM antenna.
<b>7</b>	<b>TX CARD CONNECTION (WIRELESS)</b>	The TX card enables communication between the product and the wireless receiver module.
<b>8</b>	<b>AUX IN JACKS</b>	Connect to the 2CH analog output of an external device (such as a VCR)
<b>9</b>	<b>COMPONENT VIDEO OUT JACKS</b>	Connect a TV with Component video inputs to these jacks.
<b>10</b>	<b>VIDEO OUT JACK</b>	Connect your TV's Video Input jack (VIDEO IN) to the VIDEO OUT Jack on this product.
<b>11</b>	<b>SPEAKER OUTPUT CONNECTORS</b>	Connect the front, front top, center, subwoofer speakers.
<b>12</b>	<b>COOLING FAN</b>	The cooling fan supplies cool air to the product to prevent overheating and always revolves when the power is on.

### ! CAUTION

- Ensure a minimum of 4 inches of clear space on all sides of the home theater to ensure adequate ventilation.
- Do not obstruct the cooling fan or ventilation holes.



## Remote Control

### Tour of the Remote Control

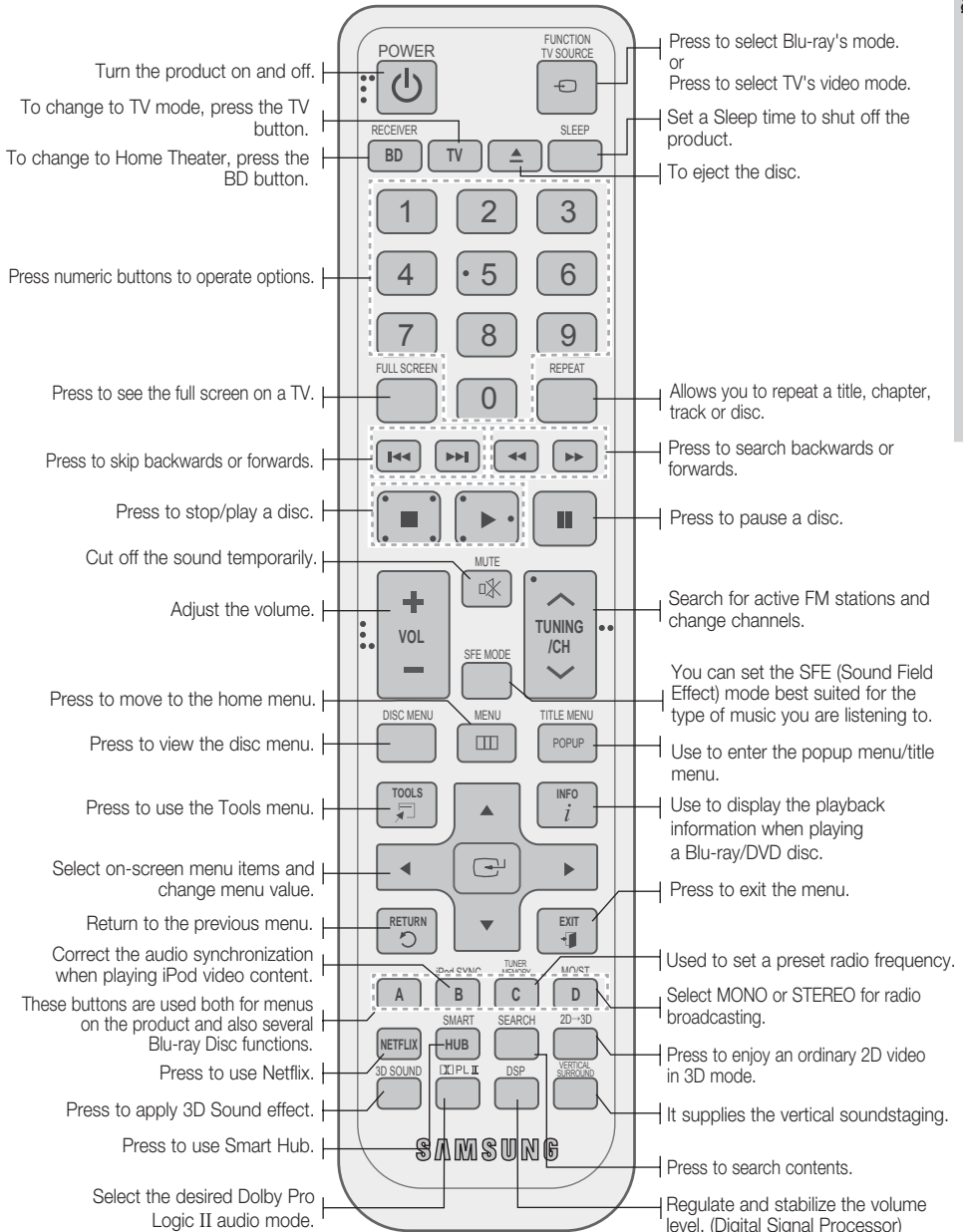

# Getting Started

## Installing batteries in the Remote Control

\* Battery size: AAA

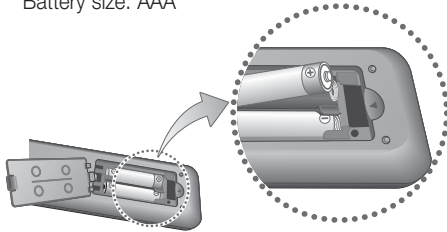

### NOTE

- Make sure to match the “+” and “-” ends of the batteries with the diagram inside the compartment.
- Assuming typical TV usage, the batteries last for about one year.
- The remote control can be used up to approximately 23 feet (7 meters) in a straight line.

## Setting the Remote Control

You can control certain functions of your TV with this remote control.

### When operating a TV with the remote control

- Press the **TV** button to set the remote control to TV mode.
- Turn on your TV.
- While holding down the **POWER** button, enter the code corresponding to your brand of TV.
  - If there is more than one code listed for your TV in the table, enter one at a time to determine which code works.
  - Example : For a Samsung TV**  
While holding down the **POWER** button, use the number buttons to enter 00. If that does not work, try 15, then 16, etc.
- If the TV turns off, the setting is complete.
  - You can use the TV **POWER**, **VOLUME**, **CHANNEL**, and **Numeric** buttons (0-9).

### NOTE

- The remote control may not work on some brands of TV's. Also, some operations may not be possible, depending on your brand of TV.
- The remote control will work with Samsung TVs by default.

## TV Brand Code List

Brand	Code	Brand	Code
Admiral (M.Wards)	56, 57, 58	Mitsubishi/MGA	18, 40, 59, 60, 75
A Mark	01, 15	MTC	18
Anam	01, 02, 03, 04, 05, 06, 07, 08, 09, 10, 11, 12, 13, 14	NEC	18, 19, 20, 40, 59, 60
AOC	01, 18, 40, 48	Nikei	03
Bell & Howell (M.Wards)	57, 58, 81	Onking	03
Brocsonic	59, 60	Onwa	03
Candle	18	Panasonic	06, 07, 08, 09, 54, 66, 67, 73, 74
Cetronic	03	Penney	18
Citizen	03, 18, 25	Philco	03, 15, 17, 18, 48, 54, 59, 62, 69, 90
Cinema	97	Philips	15, 17, 18, 40, 48, 54, 62, 72
Classic	03	Pioneer	63, 66, 80, 91
Concerto	18	Portland	15, 18, 59
Contec	46	Proton	40
Coronado	15	Quasar	06, 66, 67
Craig	03, 05, 61, 82, 83, 84	Radio Shack	17, 48, 56, 60, 61, 75
Croslex	62	RCA/Proscan	18, 59, 67, 76, 77, 78, 92, 93, 94
Crown	03	Realistic	03, 19
Curtis Mates	59, 61, 63	Sampo	40
CXC	03	Samsung	00, 15, 16, 17, 40, 43, 46, 47, 48, 49, 59, 60, 98
Daewoo	02, 03, 04, 15, 16, 17, 18, 19, 20, 21, 22, 23, 24, 25, 26, 27, 28, 29, 30, 32, 34, 35, 36, 48, 59, 90	Sanyo	19, 61, 65
Daytron	40	Scott	03, 40, 60, 61
Dynasty	03	Sears	15, 18, 19
Emerson	03, 15, 40, 46, 59, 61, 64, 82, 83, 84, 85	Sharp	15, 57, 64
Fisher	19, 65	Signature 2000 (M.Wards)	57, 58
Funai	03	Sony	50, 51, 52, 53, 55
Futuretech	03	Soundesign	03, 40
General Electric (GE)	06, 40, 56, 59, 66, 67, 68	Spectricon	01
Hall Mark	40	SSS	18
Hitachi	15, 18, 50, 59, 69	Sylvania	18, 40, 48, 54, 59, 60, 62
Inkel	45	Symphonic	61, 95, 96
JC Penny	56, 59, 67, 86	Tatung	06
JVC	70	Techwood	18
KTV	59, 61, 87, 88	Teknika	03, 15, 18, 25
KEC	03, 15, 40	TMB	18, 40
KMC	15	Toshiba	19, 57, 63, 71
LG (Goldstar)	01, 15, 16, 17, 37, 38, 39, 40, 41, 42, 43, 44	Vidtech	18
Luxman	18	Videch	59, 60, 69
LXI (Sears)	19, 54, 56, 59, 60, 62, 63, 65, 71	Wards	15, 17, 18, 40, 48, 54, 60, 64
Magnavox	15, 17, 18, 48, 54, 59, 60, 62, 72, 89	Yamaha	18
Marantz	40, 54	York	40
Matsui	54	Yupiteru	03
MGA	18, 40	Zenith	58, 79
		Zonda	01
		Dongyang	03, 54

# Connections

This section describes various methods of connecting the product to other external components. Before moving or installing the product, be sure to turn off the power and disconnect the power cord.

## Connecting the Speakers

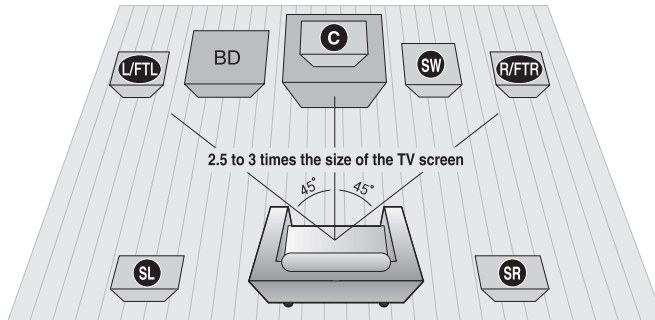

### Position of the product

Place it on a stand or cabinet shelf, or under the TV stand.

### Selecting the Listening Position

The listening position should be located about 2.5 to 3 times the distance of the TV's screen size away from the TV.

Example : For 32" TV's 6.56 ~ 7.87 feet(2~2.4m)

For 55" TV's 11.5 ~ 13.1 feet(3.5~4m)

<b>Front/Front Top Speakers</b> <b>L/FTL R/FTR</b>	Place these speakers in front of your listening position, facing inwards (about 45°) toward you. Place the front speakers so that their tweeters will be at the same height as your ear. Align the front face of the front/front top speakers with the front face of the center speaker or place them slightly in front of the center speakers.
<b>Center Speaker</b> <b>C</b>	It is best to install the Center Speaker at the same height as the front/front top speakers. You can also install it directly over or under the TV.
<b>Surround Speakers</b> <b>SL SR</b>	Place these speakers to the side of your listening position. If there isn't enough room, place these speakers so they face each other. Position them about 2 to 3 feet (60 to 90cm) above your ear, facing slightly downward.  * Unlike the front/front top and center speakers, the surround speakers are used mainly for sound effects. Sound will not come from them all the time.
<b>Subwoofer</b> <b>SW</b>	The position of the subwoofer is not so critical. Place it anywhere you like.

# Connections

## Speaker Components

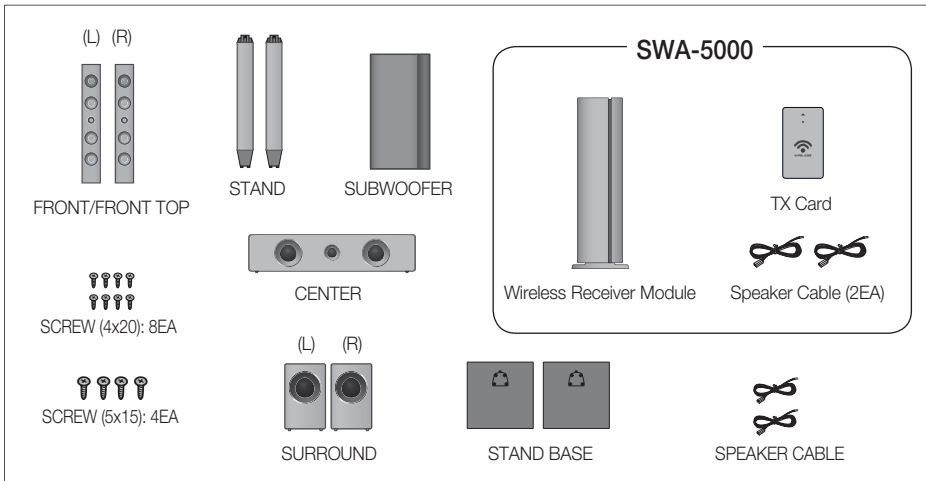

## Installing the Speakers on the Tallboy Stand

1. Turn the Stand Base upside-down and connect it to the Stand.
2. Insert small screws (4x20, For connecting Stand & Stand Base) clockwise into the four holes marked using a screwdriver as shown in the illustration.

### ! CAUTION

- When you use a torque screwdriver, be careful not to put excessive force. Otherwise, it runs idle or can be damaged. (torque screwdriver- below 15 kg.f.cm)
3. Insert the large screw (5x15, For connecting Stand & Stand Base) clockwise into the hole on the rear of the stand using a screwdriver.
  4. Connect the upper Speaker to the assembled Stand.
  5. Insert another large screw (5x15, For connecting Speaker & Stand) clockwise into the hole on the rear of the speaker using a screwdriver.
  6. This is the appearance after the speaker is installed. Follow this steps to install other speaker.

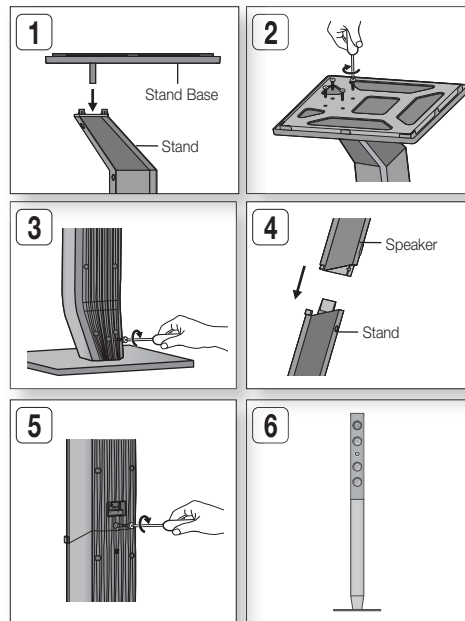

## Connecting The Speakers

1. Press down the terminal tab on the back of the speaker.
2. Insert the black wire into the black terminal (-) and the red wire into the red (+) terminal, and then release the tab.
3. Connect the speaker wire plugs to the back of the product by matching the colors of the speaker plugs to the speaker jacks.
4. With the product turned off, insert the TX card into the TX Card Connection (WIRELESS) on the back of the product.
  - Hold the TX card so that the label "WIRELESS" faces upward and insert the card into the port.
  - The TX card enables communication between the product and the wireless receiver module.
5. Connect the left and right surround speakers to the wireless receiver module.
6. Plug the power cord of the wireless receiver module into the wall outlet.
7. Turn on the product. The product and wireless receiver module will now communicate with each other and you will hear sound from the Surround speakers.

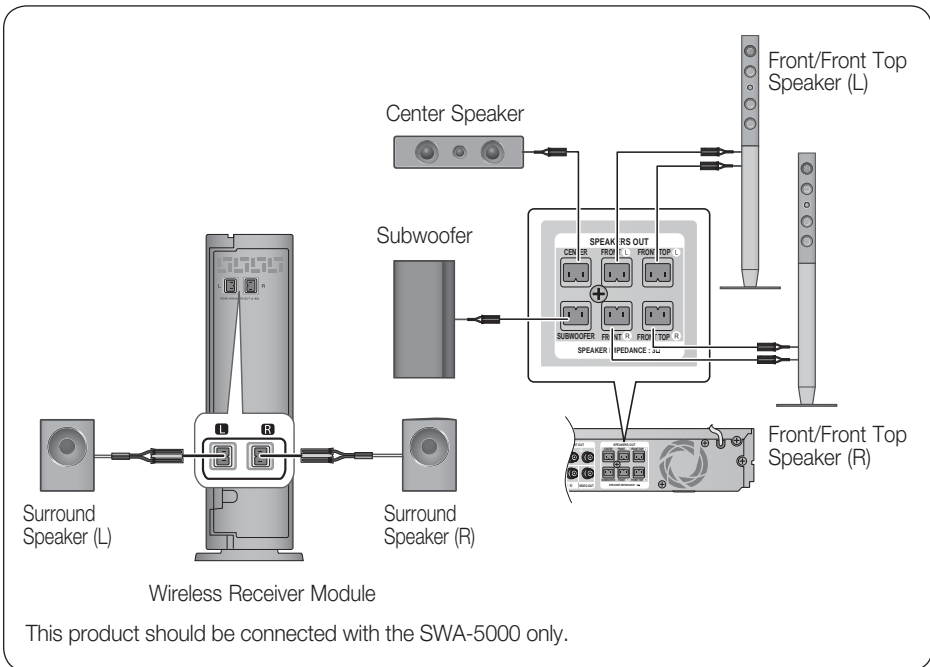
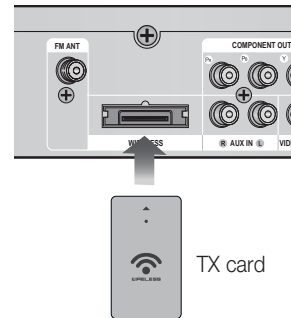
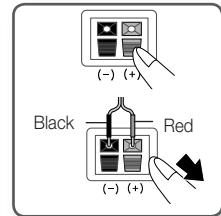

# Connections

## ! CAUTION

- Do not let children play with or near the speakers. They could get hurt if a speaker falls.
- When connecting the speaker wires to the speakers, make sure that the polarity (+/-) is correct.
- Keep the subwoofer speaker out of reach of children to prevent children from inserting their hands or alien substances into the duct (hole) of the subwoofer speaker.
- Do not hang the subwoofer on the wall through the duct (hole).
- Do not insert any other card except the TX card dedicated to the product.  
If you insert a different TX card, you can damage the product and may not be able to remove the card easily.
- Do not insert the TX card upside down or in the reverse direction.
- Insert the TX card when the product is turned off. Inserting the card when it is turned on may cause a problem.
- The wireless receiving antenna is built into the wireless receiver module. Keep it away from water and moisture.
- For optimal listening performance, make sure that the area around the wireless receiver module location is clear of any obstructions.
- **If no sound is heard from the wireless surround speakers, switch the mode to Dolby Pro Logic II.**
- In 2-CH mode, you will hear no sound from the wireless surround speakers.



## NOTE

- If you place a speaker near your TV set, the screen color may be distorted because of the magnetic field.
- Place the wireless receiver module at the rear of the listening position. If the wireless receiver module is too close to the product, sound from the speakers may be disrupted because of interference.
- If you use a device such as a microwave oven, wireless LAN Card, or any other device that uses the 2.4/5.8GHz frequencies near the product, sound from the speakers may be disrupted because of interference.
- The maximum transmission distance from the product to the wireless receiver module is about 33 feet (10m), but may vary depending on your operating environment. If a steel-concrete wall or metallic wall is between the product and the wireless receiver module, the system may not operate at all, because the radio wave cannot penetrate metal.
- If the product doesn't make a wireless connection, you need to run an ID Set between the product and wireless receiver module. With the product turned off, press "0"→"1"→"3"→"5" on the remote control. Turn on the wireless receiver module. Then, press and hold the "ID SET" button on the back of the wireless receiver module for 5 seconds, and then turn the product on.

## Connecting External Devices/your TV via HDMI

HDMI is the standard digital interface for connecting to devices such as a TV, projector, DVD player, Blu-ray player, set top box, and more.

Because HDMI is all digital, you'll enjoy digital quality video and sound as it was originally created, without the distortions that can be caused when digital content is converted to analog.

DVD or Blu-ray Player    SAT (Satellite/Set top box)

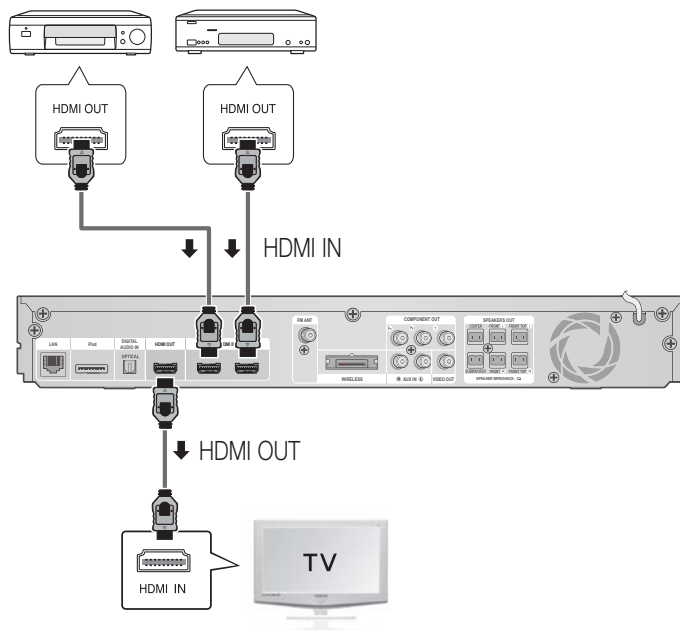

### HDMI OUT : Connecting to a TV with an HDMI Cable (BEST QUALITY)

Connect an HDMI cable (not supplied) from the HDMI OUT jack on the back of the product to the HDMI IN jack on your TV.

#### NOTE

- Certain HDMI output resolutions may not work, depending on your TV.
- After making the video connection, set the Video input source on your TV to match the corresponding Video output (HDMI, Component or Composite) on your product.  
See your TV owner's manual for more information on how to select the TV's Video Input source.
- If you have set the product's remote control to operate your TV, press the **TV SOURCE** button on the remote control and select HDMI as the external source of the TV.
- You must have an HDMI connection to enjoy videos with 3D technology.
- A long HDMI cable may cause screen noise. If this occurs, set Deep Color to Off in the menu.

# Connections

## HDMI IN : Connecting to an External Component with an HDMI Cable

1. Connect an HDMI cable (not supplied) from the HDMI IN jack on the back of the product to the HDMI OUT jack on your digital device.
2. Press the **FUNCTION** button to select **H. IN1** or **H. IN2** input.  
The mode switches as follows : **BD/DVD → D. IN → AUX → R. IPOD → W. IPOD → H. IN1 → H. IN2 → FM**

## HDMI Auto Detection Function

If you have connected your home theater by HDMI cable, the home theater's video output automatically switches to the HDMI mode when you turn it on. For available HDMI video resolutions, see page 33.

- This function is not available if the HDMI cable does not support CEC.
- HDMI connection description
  - HDMI outputs only a pure digital signal to the TV.
  - If your TV does not support HDCP, random noise appears on the screen.
- What is the HDCP?

HDCP (High-band width Digital Content Protection) is a system for preventing BD/DVD content outputted via HDMI from being copied. It provides a secure digital link between a video source (PC, DVD, etc) and a display device (TV, projector, etc). Content is encrypted at the source device to prevent unauthorized copies from being made.

### ! CAUTION

- The Anynet+ function is supported only when an HDMI Cable is connected to the HDMI OUT of the product.

## Connecting the FM Antenna

FM Antenna (supplied)

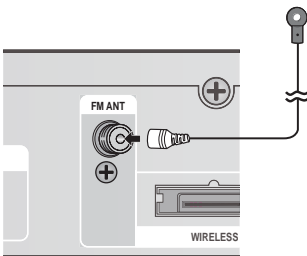

1. Connect the FM antenna supplied to the FM ANTENNA Jack.
2. Slowly move the antenna wire around until you find a location where reception is good, then fasten it to a wall or other rigid surface.

**NOTE**

- This product does not receive AM broadcasts.



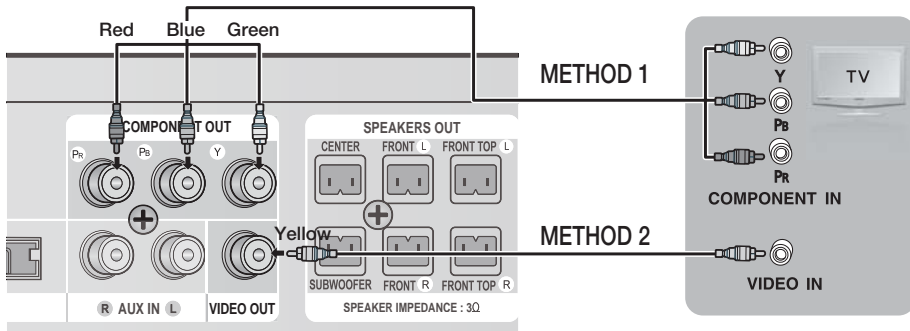

## METHOD 1 : Component Video (BETTER QUALITY)

If your television is equipped with Component Video inputs, connect a Component video cable (not supplied) from the Component Video Output (Pr, Pb and Y) Jacks on the back of the product to the Component Video Input Jacks on your TV.

### NOTE

- You can select from a variety of resolution settings such as 1080i, 720p, 480p and 480i, depending on the disc type. (See page 33)
- The actual resolution may differ from the setting in the Setup menu if both Component and HDMI cables are connected. The resolution may also be different depending on the disc. (See page 33)
- After making the video connection, set the Video input source on your TV to match the corresponding Video output (HDMI, Component or Composite) on your product.  
See your TV owner's manual for more information on how to select the TV's Video Input source.
- If you have set the product's remote control to operate your TV, press the **TV SOURCE** button on the remote control and select COMPONENT as the external source of the TV.
- In DVD playback, if both HDMI and Component jacks are connected and you select the Component 1080p, 1080i, 720p or 480p mode, the Display Setup menu will show the output resolution as 1080p, 1080i, 720p or 480p in the menu. The resolution is actually 480i.

## METHOD 2 : Composite Video (GOOD QUALITY)

Connect the supplied Video cable from the VIDEO OUT jack on the back of the product to the VIDEO IN jack on your TV.

### NOTE

- The VIDEO source always outputs in 480i resolution regardless of the resolution set in the Setup menu. (See page 33)
- After making the video connection, set the Video input source on your TV to match the corresponding Video output (HDMI, Component or Composite) on your product.  
See your TV owner's manual for more information on how to select the TV's Video Input source.
- If you have set the product's remote control to operate your TV, press the **TV SOURCE** button on the remote control and select VIDEO as the external source of the TV.

### **!** CAUTION

- Do not connect the unit through a VCR. Video signals fed through VCRs may be affected by copyright protection systems and the picture will be distorted on the television.

# Connections

## Connecting Audio from External Components

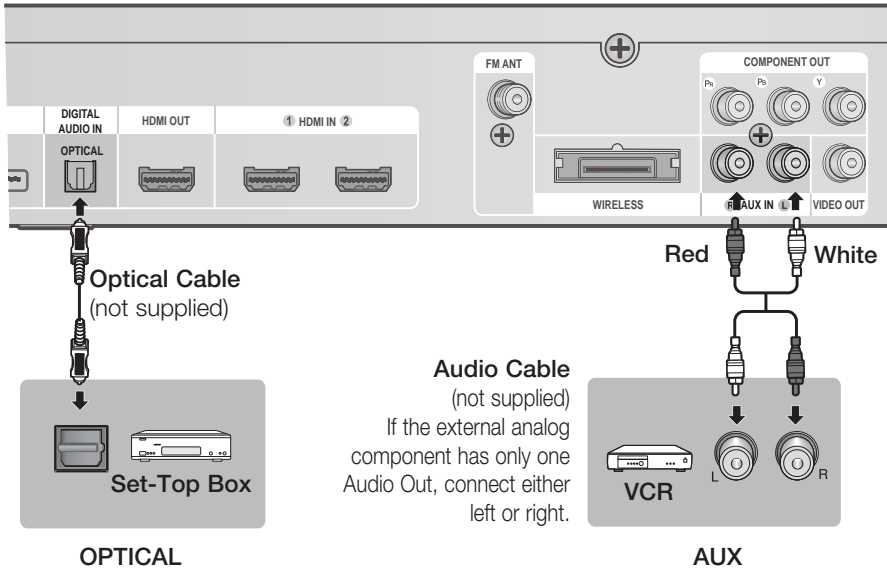

### OPTICAL : Connecting an External Digital Component

Digital signal components such as a Cable Box/Satellite receiver (Set-Top Box).

1. Connect the Digital Input (OPTICAL) on the product to the Digital Output of the external digital component.
2. Press the **FUNCTION** button to select **D.IN** input.
  - The mode switches as follows : **BD/DVD** → **D. IN** → **AUX** → **R. IPOD** → **W. IPOD** → **H. IN1** → **H. IN2** → **FM**

#### NOTE

- To see video from your Cable Box/Satellite receiver, you must connect it's video output to a TV.
- This system supports Digital sampling frequencies of 32 kHz or higher from external digital components.
- This system supports only DTS and Dolby Digital audio, MPEG audio which is bitstream cannot be supported.

### AUX : Connecting an External Analog Component

Analog signal components such as a VCR.

1. Connect AUX IN (Audio) on the product to the Audio Out of the external analog component.
  - Be sure to match connector colors.
2. Press the **FUNCTION** button to select **AUX** input.
  - The mode switches as follows : **BD/DVD** → **D. IN** → **AUX** → **R. IPOD** → **W. IPOD** → **H. IN1** → **H. IN2** → **FM**

#### NOTE

- You can connect the Video Output jack of your VCR to the TV, and connect the Audio Output jacks of the VCR to this product.

## Connecting to a Network

You can connect this product to a network and use network based services such as Smart Hub and BD-LIVE (See pages 62~69), as well as receive software upgrades through the network connection. We recommend using a wireless router or IP router for the connection.

For more information on router connection, refer to the user manual of the router or contact the router manufacturer for technical assistance.

### Cable Network

1. Using the Direct LAN Cable (UTP cable), connect the LAN terminal of the product to the LAN terminal of your modem.
2. Set the network options. (See page 39)

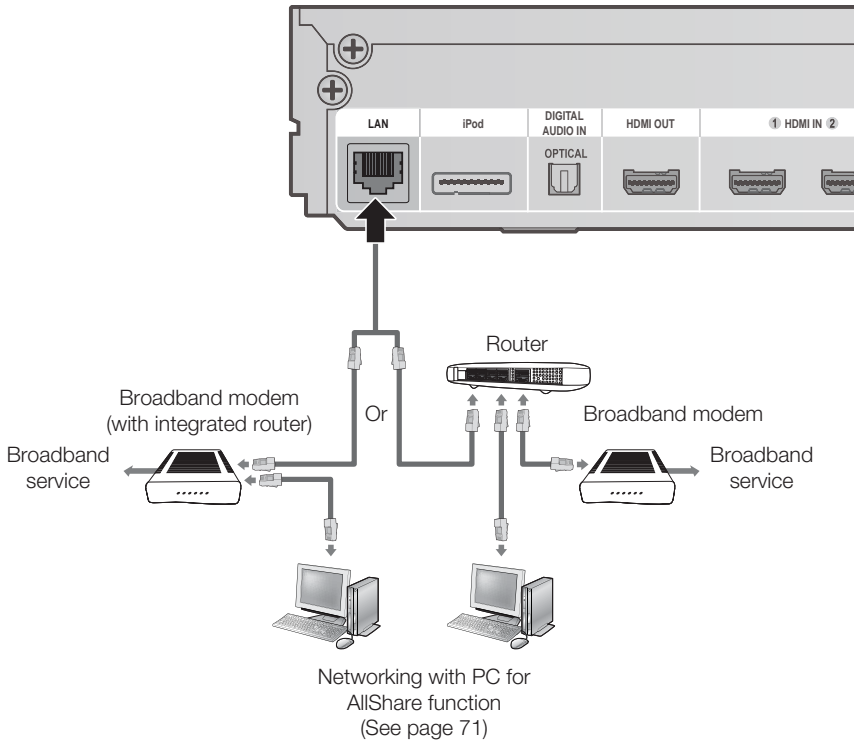

#### NOTE

- Internet access to Samsung's software update server may not be allowed, depending on the router you use or the ISP's policy. For more information, contact your ISP (Internet Service Provider).
- DSL users, please use a router to make a network connection.
- To use the AllShare function, you must connect your PC to the network as shown in the figure.

# Connections

## Wireless Network

You can connect the home theater to your network through a wireless IP sharer (router). To set the network configuration options, see page 39.

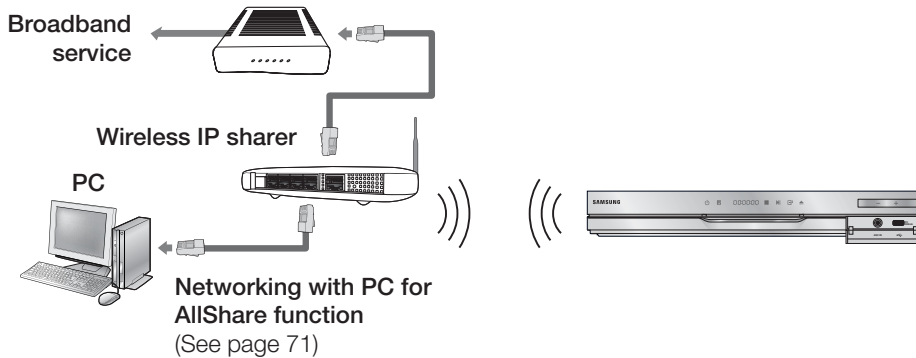

### NOTE

- To use a wireless network, your product must be connected to a wireless IP sharer (router). If the wireless IP sharer supports DHCP, your product can use a DHCP (dynamic) or static IP address to connect to the wireless network.
- This product supports IEEE 802.11b,g and n. We recommend using IEEE 802.11n. When you play video over a IEEE 802.11b or g connection, the video may not play smoothly.
- Select a channel for the wireless IP sharer that is not currently being used. If the channel set for the wireless IP sharer is currently being used by another device nearby, this will result in interference and communication failure.
- If you select the Pure High-throughput (Greenfield) 802.11n mode and set your routers's Security Encryption type to WEP, TKIP or TKIPAES (WPS2Mixed), your Samsung home theater will not support the connection in compliance with new Wi-Fi certification specifications.
- If your router supports WPS (Wi-Fi Protected Setup), you can connect to the network via PBC (Push Button Configuration) or PIN (Personal Identification Number). WPS will automatically configure the SSID and WPA key in either mode.
- You can set up the wireless network connection in three ways:
  - Using Auto Setup (the Auto Network Search function) through Wireless (General)
  - Using PBC(WPS)
  - Using One Foot Connection
- Wireless LAN, by its nature, may cause interference, depending on the operating conditions. (router performance, distance, obstacles, interference by other radio devices, etc).
- Set the wireless IP sharer to Infrastructure mode. Ad-hoc mode is not supported.
- The home theater supports the following security protocols only:
  - 1) Authentication Mode : WEP, WPAPSK, WPA2PSK
  - 2) Encryption Type : WEP, AES
- To use the AllShare function, you must connect your PC to your network as shown in the figure. The connection can be wired or wireless.

## Initial Settings

1. Turn on your TV after connecting the product. When you connect and turn on the product to a TV for the first time, the Initial Settings screen appears.

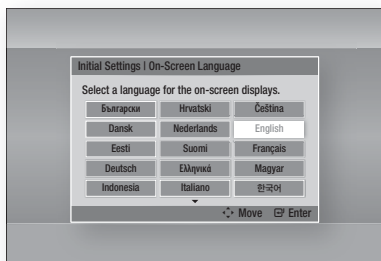

2. Press the **▲▼◀▶** buttons to select the desired language, and then press the **ENTER** button.
3. Press the **ENTER** button to select **Start**.
4. Press the **▲▼** buttons to select the desired TV Aspect Ratio, and then press the **ENTER** button. (See page 32)  
If you press the **BLUE (D)** button to skip **Musical Room Calibration** or **Network Setup**, you can access the Home menu even if the Calibration or the Network Setup is not completed.
5. Plug the ASC microphone into the **ASC IN** jack on the product. (See page 36)
6. Press the **ENTER** button to select the **Start** button.  
Setting the Musical Room Calibration function takes about 3 minutes.
7. Press the **▲▼** buttons to select the desired Network Settings : **Wired, Wireless (General), WPS(PBC)** or **One Foot Connection**, and then press the **ENTER** button. If you do not know the details of your Network Settings, press the **BLUE (D)** button on your remote instead to skip Network Settings here, finish the Initial Settings, and go to the Home menu.  
If you selected a Network Settings, go to pages 39~42 for more information about the Network settings. When done, go to Step 8.
8. The Home menu appears. (For more information about the Home menu, please see page 30.)

## • Home Menu

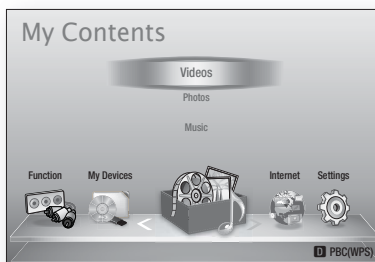

## NOTE

- The Home menu will not appear if you do not configure the initial settings except as noted below.
- If you press the **BLUE (D)** button during the Musical Room Calibration/network setup, you can access the Home menu even if the network setup is not completed yet.
- If you want to display the Initial Setting screen again to make changes, select the Reset option. (See page 43)
- If you use an HDMI cable to connect the product to an **Anynet+(HDMI-CEC)**-compliant Samsung TV and 1.) You have set the **Anynet+(HDMI-CEC)** feature to **On** in both the TV and the product and 2.) You have set the TV to a language supported by the product, the product will select that language as the preferred language automatically.
- If you leave the product in the stop mode for more than 5 minutes without using it, a screen saver will appear on your TV. If the product is left in the screen saver mode for more than 20 minutes, the power will automatically turn off.

# Setup

## Accessing the Settings Menu

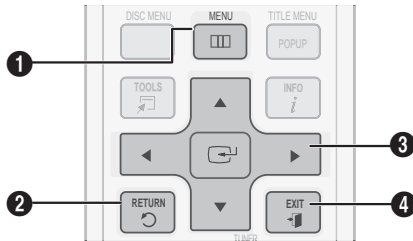

1	<b>MENU</b> Button : Press to move to the Home menu.
2	<b>RETURN</b> Button : Return to the previous menu.
3	<b>ENTER / DIRECTION</b> Button : Move the cursor or select an item. Activate the currently selected item. Confirm a setting.
4	<b>EXIT</b> Button : Press to exit the current menu.

- Press the ◀▶ buttons to select **Settings**, and then press the **ENTER** button.
- Press the ▲▼ buttons to select the desired submenu, and then press the **ENTER** button.
- Press the ▲▼ buttons to select the desired item, and then press the **ENTER** button.
- Press the **EXIT** button to exit the menu.

### NOTE

- When the product is connected to a network, select **Internet** from the Home menu. Download the desired content from **Samsung Apps**. (See pages 69-71)
- The access steps may differ depending on the menu you selected.
- The OSD (On Screen Display) may change in this product after you upgrade the software version.

To access the Settings menu and sub-menus, follow these steps:

- Press the **POWER** button.  
The Home Menu appears.

### • Home Menu

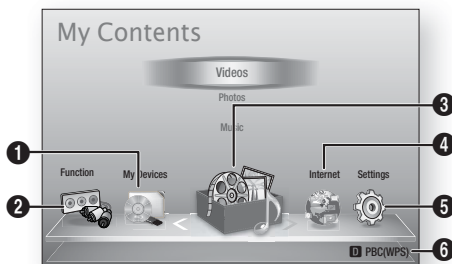

1	Selects My Devices.
2	Selects Function.
3	Selects My Contents.
4	Selects Internet.
5	Selects Settings.
6	Displays the buttons available.

## Display

You can configure various display options such as the TV Aspect Ratio, Resolution, etc.

### 3D Settings

Select whether to play a Blu-ray Disc with 3D contents in 3D Mode.

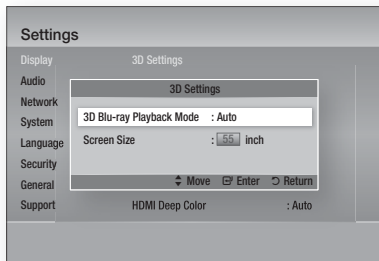

### 3D Blu-ray Playback Mode

You can choose whether to watch a 3D Blu-ray disc in 3D or 2D mode before playing the 3D disc. It is automatically played in 2D mode if your TV cannot support 3D contents.

- **Auto** : Automatically detect the 3D capability of the connected TV and play a 3D Blu-ray disc in 3D or 2D accordingly.
- **3D → 3D** : 3D Blu-ray Discs are played in 3D mode at all times. If a TV cannot support 3D Blu-ray discs, the playing screen can be blank.
- **3D → 2D** : 3D Blu-ray Discs are played in 2D mode at all times. Choose this to view a picture without the 3D effect or when a TV cannot support 3D Blu-ray discs.

#### NOTE

- To stop a movie during 3D playback, press the **STOP** (■) button once. The movie stops and the 3D mode option is de-activated. To change a 3D option selection when you are playing a 3D movie, press the **STOP** (■) button once. The Blu-ray menu appears. Press the **STOP** (■) button again, then select 3D Settings in the Blu-ray menu.

- Depending on the content and the position of the picture on your TV screen, you may see vertical black bars on the left side, right side, or both sides.

### Screen Size

Lets you enter the actual screen size of your TV so that the product can adjust the image according to the screen size and display an optimal 3D image. (The maximum allowed screen size is 116 inches for this product.)

#### ! CAUTION

- If you want to enjoy 3D content, connect a 3D device (3D compliant AV receiver or TV) to the product's HDMI OUT port using a high-speed HDMI cable. Put on 3D glasses before playing the 3D content.
- The product outputs 3D signals only through HDMI cable connected to the HDMI OUT port.
- As the video resolution in 3D play mode is fixed according to the resolution of the original 3D video, you can not change the resolution to your preference.
- Some functions such as BD Wise, screen size adjustment, and resolution adjustment may not operate properly in 3D play mode.
- Stay at least three times the width of the screen from the TV when watching 3D images. For example, if you have a 46 inch screen, stay 138 inches (11.5 feet) from the screen.
  - Place the 3D video screen at eye level for the best 3D picture.
- When the product is connected to some 3D devices, the 3D effect may not function properly.

# Setup

## TV Aspect (Picture Size and Format)

Depending on the type of television you have, you may want to adjust the screen size setting.

- **16:9 Original** : Select when you connect the product to a 16:9 TV screen. The product will display all content in its original aspect ratio. Content formatted in 4:3 will be displayed with black bars on the left and right.
- **16:9 Full** : Select when you connect the product to a 16:9 TV screen. All content will fill the full screen. Content formatted in 4:3 will be stretched.
- **4:3 Letter Box** : Select when you connect the product to a 4:3 TV screen. The product will display all content in its original aspect ratio. Content formatted in 16:9 will be displayed with black bars on the top and bottom.
- **4:3 Pan-Scan** : Select when you connect the product to a 4:3 TV screen. 16:9 content will have the extreme left and right portions cut off.

### NOTE

- Depending on the disc type, some aspect ratios may not be available.
- If you select an aspect ratio and option which is different than the aspect ratio of your TV screen, then the picture might appear to be distorted.
- If you select the 16:9 Original, your TV may display 4:3 Pillarbox (black bars on sides of picture).

## Smart Hub Screen Size

Set the Smart Hub Screen to the optimal size.

- **Size 1** : The Smart Hub screen size will be smaller than the default. You may see some black on sides of screen.
- **Size 2** : This is the default setting for Smart Hub. The product displays the normal Smart Hub screen size.
- **Size 3** : This will display a larger Smart Hub screen size. The image may be too large for your TV screen.

## BD Wise (Samsung Products only)

BD Wise is Samsung's latest inter-connectivity feature.

When you connect a Samsung product and a Samsung TV with BD Wise to each other via HDMI, and BD Wise is on in both the product and TV, the product outputs video at the video resolution and frame rate of the BD/DVD disc.

- **Off** : The output resolution stays fixed at the resolution you set previously in the Resolution menu, regardless of the resolution of the disc. See Resolution below.
- **On** : The product outputs video at the original resolution and frame rate of the BD/DVD disc.

### NOTE

- When BD Wise is on, the Resolution setting automatically defaults to BD Wise and BD Wise appears in the Resolution menu.
- If the product is connected to a device that does not support BD Wise, you can not use the BD Wise function.
- For proper operation of BD Wise, set the BD Wise menu of both the product and the TV to **On**.

## Resolution

Lets you set the output resolution of the Component and HDMI video signal to Auto, 1080p, 1080i, 720p, 480p, or 480i. The number indicates the number of lines of video per frame. The i and p indicate interlaced and progressive scan, respectively. The more lines, the higher the quality.

- **Auto** : Automatically sets the output resolution to the connected TV's maximum resolution.
- **BD Wise** : Automatically sets the resolution to the resolution of the BD/DVD disc if you have connected the product via HDMI to a TV with the BD Wise feature. (The BD Wise menu item appears only if BD Wise is set to **On**. See BD Wise above.)
- **1080p** : Outputs 1080 lines of progressive video. (HDMI only)
- **1080i** : Outputs 1080 lines of interlaced video.
- **720p** : Outputs 720 lines of progressive video.
- **480p** : Outputs 480 lines of progressive video.
- **480i** : Outputs 480 lines of interlaced video. (VIDEO only)



## Resolution according to the output mode

### • Blu-ray Disc/E-contents/Digital Contents playback

Setup \ Output	HDMI / connected			HDMI / not connected		
	HDMI Mode		Component/ VIDEO Mode	Component Mode		VIDEO Mode
	Blu-ray Disc	E-contents/ Digital contents		Blu-ray Disc	E-contents/ Digital contents	
BD Wise	Resolution of Blu-ray Disc	1080p@60F	480i	-	-	-
Auto	Max. Resolution of TV input	Max. Resolution of TV input	480i	-	-	-
1080p@60F	1080p@60F	1080p@60F	480i	-	-	-
Movie Frame : Auto (24Fs)	1080p@24F	1080p@24F	480i	-	-	-
1080i	1080i	1080i	480i	480i	1080i	480i
720p	720p	720p	480i	480i	720p	480i
480p	480p	480p	480i	480i	480p	480i
480i	-	-	-	480i	480i	480i

### • DVD playback

Setup \ Output	HDMI / connected		HDMI / not connected	
	HDMI Mode	Component/VIDEO Mode	Component Mode	VIDEO Mode
BD Wise	480i	480i	-	-
Auto	Max. Resolution of TV input	480i	-	-
1080p@60F	1080p@60F	480i	-	-
1080i	1080i	480i	480p	480i
720p	720p	480i	480p	480i
480p	480p	480i	480p	480i
480i	-	-	480i	480i

# Setup



## NOTE

- If the TV you connected to the product does not support Movie Frame or the resolution you selected, the message "If no pictures are shown after the selection, please wait for 15 seconds. And then, the resolution will be reverted to the previous value automatically. Would you like to make a selection?" appears. If you select **Yes**, the TV's screen will go blank for 15 seconds, and then the resolution will revert to the previous resolution automatically.
- If the screen stays blank after you have changed the resolution, remove all discs, and then press and hold the **STOP (■)** button on the front of the product for more than 5 seconds. All settings are restored to the factory default. Follow the steps on the previous page to access each mode and select the Display Setup that your TV will support.
- When the factory default settings are restored, all stored user BD data is deleted.
- The Blu-ray Disc must have the 24 frame feature for the product to use the Movie Frame (24Fs) mode.
- If both HDMI and Component jacks are connected and you are currently viewing Component output, the resolution is fixed to 480i.

## HDMI Color Format

Lets you set the color space format for HDMI output to match the capabilities of the connected device (TV, monitor, etc).

- **Auto** : Automatically sets the product to the optimum format supported by your device.
- **YCbCr (4:4:4)** : If your TV supports the YCbCr color space via HDMI, select this to output the normal YCbCr color gamut.
- **RGB (Standard)** : Select RGB (Standard) to output the normal RGB color gamut.
- **RGB (Enhanced)** : If you have connected the product to a DVI display device such as a monitor, select RGB (Enhanced) to output the enhanced RGB color gamut.

## Movie Frame (24 Fs)

Setting the Movie Frame (24Fs) feature to **Auto** allows you to adjust the product's HDMI output to 24 frames per second for improved picture quality. You can enjoy the Movie Frame (24Fs) feature only on a TV supporting this frame rate. You can select Movie Frame only when the product is in the HDMI 1080i or 1080p output resolution modes.

- **Auto** : Movie Frame (24Fs) functions work.
- **Off** : Movie Frame (24Fs) functions are off.

## HDMI Deep Color

Lets you output video from the HDMI OUT jack with Deep Color. Deep Color provides more accurate color reproduction with greater color depth.

- **Auto**: The product outputs video with Deep Color to a connected TV which supports HDMI Deep Color.
- **Off** : The picture is output without Deep Color.

## Still Mode

Lets you set the type of picture the product displays when you pause DVD playback.

- **Auto**: Automatically shows the best still picture depending on the content.
- **Frame** : Select when pausing a scene with a little action.
- **Field** : Select when pausing a scene with a lot of action.

## Progressive Mode

Lets you improve picture quality when viewing DVDs.

- **Auto** : Select to have the product automatically select the best picture quality for the DVD you're watching.
- **Video** : Select for the best picture quality from concert or TV show DVDs.

## Audio

### Speaker Settings

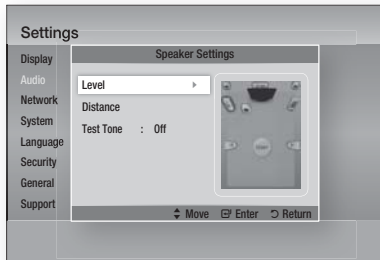

#### Level

You can adjust the balance and level for each speaker.

#### Adjusting Front/Center/Surround/Front Top/ Subwoofer Speaker Level

- You can adjust the volume level in steps from +6dB to -6dB.
- The sound gets louder as you move closer to +6dB and quieter as you get closer to -6dB.

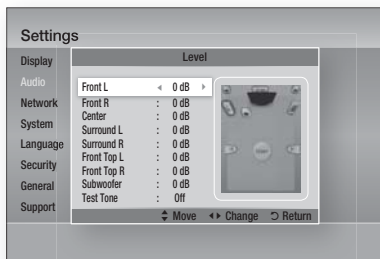

#### Distance

If you cannot place the speakers at equal distances from the listening position, you can adjust the delay time of the audio signals from the front, front top, center, surround and subwoofer speakers.

- You can set the Speaker Distance between 1ft (0.3m) and 30ft (9.2m).

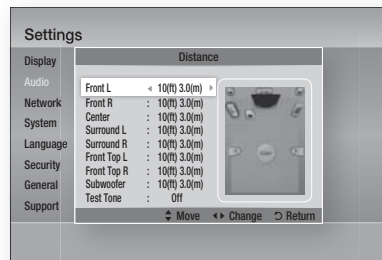

#### Test Tone

Use the Test Tone feature to check the speaker connections.

Press the ◀, ▶ buttons to select **ON**.

- A test tone will be sent to **Front L → Center → Front R → Surround R → Front Top R → Front Top L → Surround L → Subwoofer** in order so you can make sure the speakers are set up correctly.

To stop the test tone, press the ◀, ▶ buttons to select **Off**.

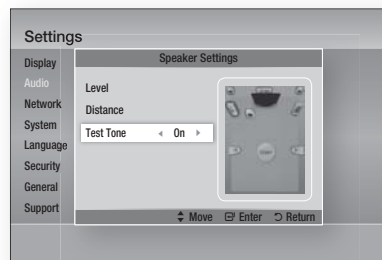

#### NOTE

- When HDMI Audio is ON (audio is produced through TV speakers), the Test Tone function is not available.

# Setup

## Musical Room Calibration

By setting the Musical Room Calibration (MRC) function just once when you relocate or install the product, you can have the product automatically recognize the distance between speakers, levels between channels, and frequency characteristics to create a 7.1-channel sound field optimized for your environment.

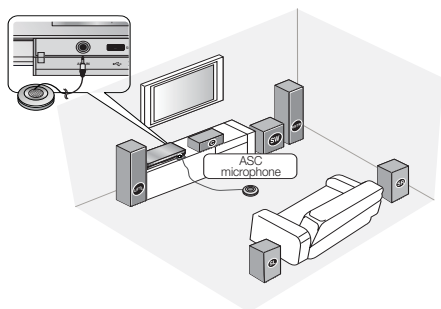

### Musical Room Calibration Mode

You will hear either the Musical Room Calibration mode or the User Speaker Settings.

- **Off:** You will hear sound in the Speaker Setting value.
- **On:** You will hear sound in the Musical Room Calibration mode.

### Measurement

1. Plug the ASC microphone into the **ASC IN** jack.
2. Place the ASC microphone at the listening position.
  - Musical Room Calibration will be automatically set up in the following sequence:  
**Front L → Center → Front R → Surround R → Front Top R → Front Top L → Surround L → Subwoofer**
  - Press the **RETURN** button to cancel the Musical Room Calibration Setting.

### NOTE

- Running the Musical Room Calibration function takes about 3 minutes.
- Make sure there is no disc in the product when you run the Musical Room Calibration function.
- If the ASC microphone is disconnected during the Musical Room Calibration setup, the setup will be canceled.
- When the Musical Room Calibration function is activated, the DSP, Dolby Pro Logic II and SFE Mode will not work.
- If the product is connected to external devices or other components (such as an iPod, AUX, D.IN), the Musical Room Calibration Setup may not work properly.
- Noise may result in incorrect measurements. Ensure the room is quiet when you run the Musical Room Calibration.
- Place the microphone in the main listening position.
- Make sure there are no objects between the speakers and microphone.
- Note that the test tones of the speakers may be loud.
- Do not place the microphone behind furniture or too close to the wall. Otherwise, it can produce an incorrect test result.

## User EQ

You can configure the equalizer settings manually to your preference.

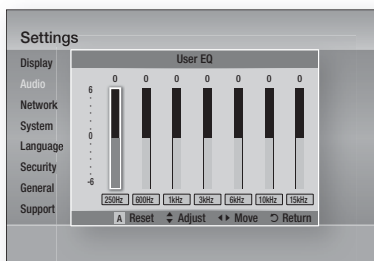

## HDMI Audio

The audio signals transmitted over the HDMI Cable can be toggled On/Off.

- **Off** : Video is transmitted over the HDMI connection cable only, and audio is output through your product speakers only.
- **On** : Both video and audio signals are transmitted over the HDMI connection cable, and audio is output through your TV speakers only.

### NOTE

- HDMI Audio is automatically down-mixed to 2ch for TV speakers.

## Audio Return Channel

You can enjoy TV sound from the Home Theater speakers by using just one HDMI cable.

- **Auto** : Listen to TV sound from the Home Theater speakers if your TV is compatible with the Audio Return Channel function.
- **Off** : Turn the Audio Return Channel function off.

### NOTE

- When Anynet+ (HDMI-CEC) is Off, the Audio Return Channel function is not available.
- Using an ARC (Audio Return Channel) uncertified HDMI cable may cause a problem in compatibility.
- ARC function is only available if an ARC-compliant TV is connected.

## Digital Output

You set the Digital Output to match the capabilities of the AV receiver you've connected to the product :

- **PCM** : Choose if you have connected an HDMI supported AV receiver.
- **Bitstream (Unprocessed)** : Select if you have connected an HDMI supported AV receiver with Dolby TrueHD and DTS-HD Master Audio decoding capabilities.
- **Bitstream (Re-encoded DTS)** : Choose if you have connected an AV receiver using a Digital Optical input that can decode DTS.

- **Bitstream (Re-encoded Dolby D)** : Select if you don't have an HDMI supported AV receiver, but have an AV receiver with Dolby Digital decoding capabilities.

For more details, please refer to the digital output selection table. (See page 38)

Blu-ray Discs may include three audio streams :

- **Main Feature Audio** : The audio soundtrack of the main feature.
- **BONUSVIEW audio** : An additional soundtrack such as the director or actor's commentary.
- **Navigation Sound Effects** : When you choose some menu navigation, Navigation Sound Effects may sound. Navigation Sound Effects are different on each Blu-ray Disc.

### NOTE

- Digital Output can be activated when HDMI Audio is ON.
- Be sure to select the correct Digital Output or you will hear no sound or just loud noise.
- If the HDMI device (AV receiver, TV) is not compatible with compressed formats (Dolby digital, DTS), the audio signal outputs as PCM.
- Regular DVDs do not have BONUSVIEW audio and Navigation Sound Effects.
- Some Blu-ray Discs do not have BONUSVIEW audio and Navigation Sound Effects.
- This Digital Output setup does not effect the analog (L/R) audio or HDMI audio output to your TV.  
It effects the optical and HDMI audio output when your product is connected to an AV receiver.
- If you play MPEG audio soundtracks, the audio signal outputs as PCM regardless of your Digital Output selections (PCM or Bitstream).

# Setup

## Digital Output Selection

Setup		PCM	Bitstream (Unprocessed)	Bitstream (Re-encoded DTS)	Bitstream (Re-encoded Dolby D)
Connection		HDMI supported AV receiver	HDMI supported AV receiver	HDMI supported AV receiver	HDMI supported AV receiver
Audio Stream on Blu-ray Disc	PCM	Up to 7.1ch	PCM	DTS re-encoded	Re-encoded Dolby Digital *
	Dolby Digital	Up to 7.1ch	Dolby Digital	DTS re-encoded	Re-encoded Dolby Digital *
	Dolby Digital Plus	Up to 7.1ch	Dolby Digital Plus	DTS re-encoded	Re-encoded Dolby Digital *
	Dolby TrueHD	Up to 7.1ch	Dolby TrueHD	DTS re-encoded	Re-encoded Dolby Digital *
	DTS	Up to 6.1ch	DTS	DTS re-encoded	Re-encoded Dolby Digital *
	DTS-HD HRA	Up to 7.1ch	DTS-HD HRA	DTS re-encoded	Re-encoded Dolby Digital *
	DTS-HD MA	Up to 7.1ch	DTS-HD MA	DTS re-encoded	Re-encoded Dolby Digital *
Audio Stream on DVD	PCM	PCM 2ch	PCM 2ch	PCM 2ch	PCM 2ch
	Dolby Digital	Up to 5.1ch	Dolby Digital	Dolby Digital	Dolby Digital
	DTS	Up to 6.1ch	DTS	DTS	DTS
Definition for Blu-ray Disc	Any	Decodes the main feature audio and BONUSVIEW audio stream together into PCM audio and adds Navigation Sound Effects.	Outputs only the main feature audio stream so that your AV receiver can decode the audio bitstream. You will not hear BONUSVIEW audio or Navigation Sound Effects.	Decodes the main feature audio and BONUSVIEW audio stream together into PCM audio and adds Navigation Sound Effects, then re-encodes the PCM audio into DTS bitstream.	Decodes the main feature audio and BONUSVIEW audio stream together into PCM audio and adds Navigation Sound Effects, then re-encodes the PCM audio into Dolby digital bitstream or PCM.

\* If the Source Stream is 2ch, "Re-encoded Dolby D" Setting are not applied. Output will be LPCM 2ch.

### Dynamic Range Control

You can listen at low volumes, but still hear dialog clearly. This is only active if your product detects a Dolby Digital signal.

- **Auto** : The Dynamic Range Control will be set automatically based on the information provided by the Dolby TrueHD Soundtrack.

- **Off** : Movie soundtracks are played using the standard Dynamic Range.
- **On** : When Movie soundtracks are played at low volume or through smaller speakers, the system can apply appropriate compression to make low-level content more intelligible and prevent dramatic passages from getting too loud.

## Audio Sync

Video may fall out of sync with the audio when the product is connected to a digital TV. If this occurs, adjust the audio delay time to match the audio to the video.

- You can set the audio delay time between 0 msec and 300 msec. Set it to the optimal status.

## Network

Before you begin, contact your ISP to find out if your IP address is static or dynamic. If it is dynamic, and you are using a wired or wireless connection, we recommend using the Auto procedures. If you are using a wireless connection and your router has the capability, you can use WPS(PBC) or One Foot Connection.

If your IP address is static, you must use the manual set up procedure for both wired and wireless connections.

## Network Settings

To begin setting up the network connection for your product, follow these steps:

- In the Home menu, press the ◀▶ buttons to select **Settings**, and then press the **ENTER** button.
- Press the ▲▼ buttons to select **Network**, and then press the **ENTER** button.
- Press the ▲▼ buttons to select **Network Settings**, and then press the **ENTER** button.
- Press the ▲▼ buttons to select **Wired**, **Wireless (General)**, **WPS(PBC)** or **One Foot Connection**, and then press the **ENTER** button.
- If you have a wired network, go to **Wired Network** below. If you have a wireless network, go to **Wireless Network** on pages 40~42.

## Wired Network

### Setting Up a Wired Connection - Auto

- Press the ▲▼ buttons to select **Wired**.

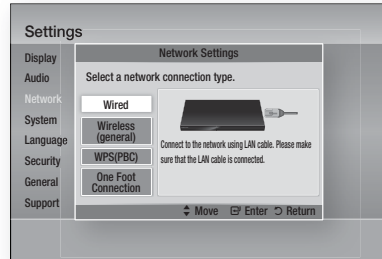

- Press the **ENTER** button.  
The Network Status screen appears. The product connects to the network after the network connection is verified.

### Setting Up a Wired Connection - Manual

If you have a static IP address or the Auto Setting does not work, you'll need to set the Network Settings values manually.

To view your Network Settings values on most Windows computers, follow these steps:

- Right click the Network icon on the bottom right of the Windows desktop.
- In the pop-up menu, click Status.
- On the dialog that appears, click the Support tab.
- On the Support tab, click the Details button. The Network settings are displayed.

# Setup

To enter the Network settings into your product, follow these steps:

1. Press the ▲▼ buttons to select **Wired**, and then press the **ENTER** button.
2. Press the ◀▶ buttons to select **IP Settings**, and then press the **ENTER** button.

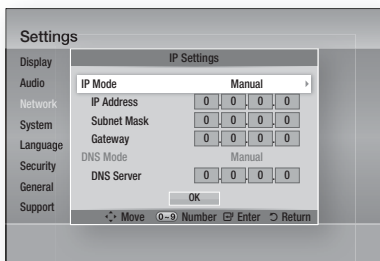

3. Press the **ENTER** button to select **IP Mode**.
4. Press the ▲▼ buttons to select **Manual**, and then press the **ENTER** button.
5. Press the ▼ button to go to the first entry field (IP Address).
6. Use the number buttons on your remote to enter numbers.
7. When done with each field, press the ▶ button to move successively to the next field. You can also use the other arrow buttons to move up, down, and back.
8. Enter the **IP Address**, **Subnet Mask**, and **Gateway** values.
9. Press the ▼ button to go to **DNS Mode**.
10. Press the ▼ button to go to the first DNS entry field. Enter the numbers as above.
11. Press the **ENTER** button to select **OK**. The Network Status screen appears. The product connects to the network after the network connection is verified.

## Wireless Network

You can setup a wireless network three ways:

- Wireless (General)
- Using WPS(PBC).
- One Foot Connection

Wireless (General) includes both Automatic and Manual setup procedures.

### Setting Up the Wireless Network Connection - Auto

Most wireless networks have an optional security system that requires devices that access the network to transmit an encrypted security code called an Access or Security Key. The Security Key is based on a Pass Phrase, typically a word or a series of letters and numbers of a specified length you were asked to enter when you set up security for your wireless network. If you use this method of setting up the network connection, and have a Security Key for your wireless network, you will have to enter the Pass Phrase during the Auto setup process.

1. Press the ▲▼ buttons to select **Wireless (General)**.

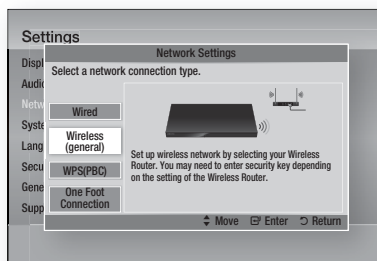

2. Press the **ENTER** button. When done, it displays a list of the available networks.
3. Press the ▲▼ buttons to select the desired network, and then press the **ENTER** button. The Security screen appears.



- On the Security screen, enter your network's Pass Phrase. Enter numbers directly using your remote control.  
To select a letter, press the ▲▼◀▶ buttons to move the cursor, then press the **ENTER** button.

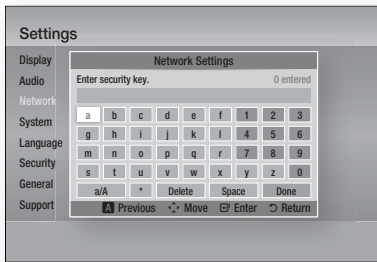

#### NOTE

- You should be able to find the Pass Phrase on one of the set up screens you used to set up your router or modem.
- When done, press the ▲▼◀▶ buttons to move the cursor to **Done**, and then press the **ENTER** button.  
The Network Status screen appears. The product connects to the network after the network connection is verified.

### Setting Up the Wireless Network Connection - Manual

If the Auto Setting does not work, you need to enter the Network settings values manually.

To view the Network Settings values on most Windows computers, follow these steps:

- Right click the Network icon on the bottom right of the screen.
  - In the pop-up menu, click Status.
  - On the dialog that appears, click the Support tab.
  - On the Support tab, click the Details button. The Network settings are displayed.
- To enter the Network settings into your product, follow these steps:
- Follow Steps 1 through 5 in the 'Setting Up the Wireless Network Connection - Auto' procedure.
  - When done, press the ▲▼◀▶ buttons to move the cursor to **Done**, and then press the **ENTER** button. The Network Status screen appears.

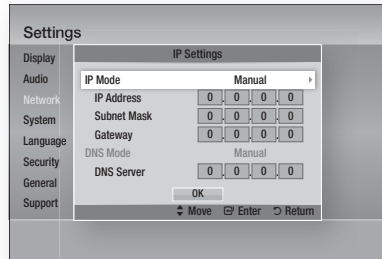

- On the Network Status screen, select Cancel, and then press Enter.
- Press the ◀▶ buttons to select **IP Settings**, and then press the **ENTER** button.
- Press the **ENTER** button to select **IP Mode**.
- Press the ▲▼ buttons to select **Manual**, and then press the **ENTER** button.
- Press the ▼ button to go to the first entry field (IP Address).
- Use the number buttons to enter numbers.
- When done with each field, press the ▶ button to move successively to the next field. You can also use the other arrow buttons to move up, down, and back.
- Enter the **IP Address**, **Subnet Mask**, and **Gateway** values.
- Press the ▼ to go to **DNS Mode**.
- Press the ▼ button to go to the first DNS entry field. Enter the numbers as above.
- The Network Status screen appears. The product connects to the network after the network connection is verified.

# Setup

## WPS(PBC)

The easiest way to set up the wireless network connection is using the WPS(PBC) function or the One Foot Connection function.

If your wireless router has a **WPS(PBC)** button, follow these steps:

1. Press the ▲▼ buttons to select **WPS(PBC)**.

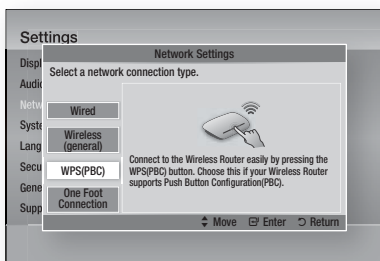

2. Press the **ENTER** button.
3. Press the **WPS(PBC)** button on your router within two minutes. Your product displays the Network Selection Screen, and automatically acquires all the network settings values it needs and connects to your network. When it is done, it displays an **OK** button. Press the **ENTER** button on your remote.

## One Foot Connection

You can set up the wireless connection automatically if you have a Samsung Wireless Router which supports One Foot Connection. To connect using the One Foot Connection function, follow these steps:

1. Press the ▲▼ buttons to select **One Foot Connection**.

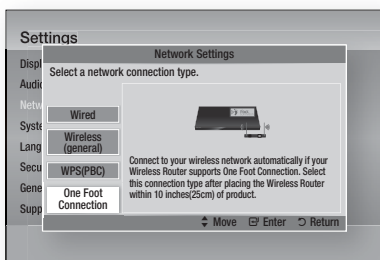

2. Press the **ENTER** button.
3. Place the Samsung Wireless Router within 25 cm (10 inches) of your product to connect.
4. Wait until the connection is automatically established.

## Network Status

Check whether a connection to the network and the Internet have been established.

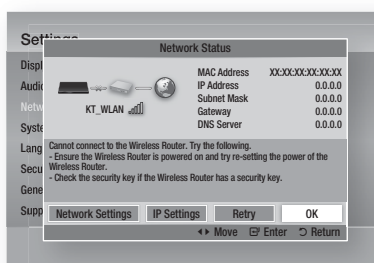

## BD-LIVE Internet Connection

Set to allow or prohibit an Internet connection when you use the BD-LIVE service.

- **Allow (All)** : The Internet connection is allowed for all BD-LIVE contents.
- **Allow (Valid Only)** : The Internet connection is allowed only for BD-LIVE contents containing a valid certificate.
- **Prohibit** : No Internet connection is allowed for any BD-LIVE content.

### NOTE

- **What is a valid certificate?**  
When the product uses BD-LIVE to send the disc data and a request to the server to certify the disc, the server uses the transmitted data to check if the disc is valid and sends the certificate back to the product.
- The Internet connection may be restricted while you are using BD-LIVE contents.

## System

### Initial Settings

By using the Initial Settings function, you can set the language, Musical Room Calibration, Network Settings, etc.

For more information about the Initial Settings function, refer to the Initial Settings section of this user manual. (See pages 29~47)

### Anynet+ (HDMI-CEC)

Anynet+ is a convenient function that offers linked operations with other Samsung products that have the Anynet+ feature.

To operate this function, connect this product to a Samsung TV with an HDMI cable.

With Anynet+ on, you can operate this product using a Samsung TV remote control and start disc playback simply by pressing the **PLAY** (▶) button on the TV's remote control.

For more information, please see the TV user manual.

- **Off** : Anynet+ functions will not work.
- **On** : Anynet+ functions will work.

#### NOTE

- This function is not available if the HDMI cable does not support CEC.
- If your Samsung TV has an Anynet+ logo, then it supports the Anynet+ function.
- Depending on your TV, certain HDMI output resolutions may not work. Please refer to the user manual of your TV.

### BD Data Management

Lets you manage the downloaded contents you accessed through a Blu-ray Disc that supports the BD-LIVE service and stored on an attached Flash memory device.

You can check the device's information including the storage size, delete the BD data, or change the Flash memory device.

#### BD Data Management Screen Information :

- **Total Size** : Total memory size of the device.
- **Available Size** : Available memory in the device.
- **Delete BD Data** : Delete all BD data in the storage.
- **Select Device** : Change location of desired memory to store BD data.

#### NOTE

- In the external memory mode, disc playback may be stopped if you disconnect the USB device in the middle of playback.
- Only those USB devices formatted in the FAT file system (DOS 8.3 volume label) are supported. We recommend you use USB devices that support USB 2.0 protocol with 4 MB/sec or faster read/write speed.
- The Resume Play function may not work after you format the storage device.
- The total memory available to BD Data Management may differ, depending on the conditions.

### Time Zone

You can specify the time zone that is applicable to your area.

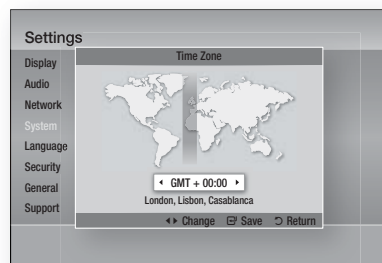

### DivX® Video On Demand

View DivX® VOD Registration Codes to purchase and play DivX® VOD contents or view the deregistration code to deregister this product.

### Reset

All settings will revert to the default except for the network and Smart Hub settings.

# Setup

## Language

You can select the language you prefer for the Home menu, disc menu, etc.

- **On-Screen Menu** : Select the language for the on-screen displays.
- **Disc Menu** : Select the language for the disc menu displays.
- **Audio** : Select the language for disc audio.
- **Subtitle** : Select the language for disc subtitles.

### NOTE

- The selected language will only appear if it is supported on the disc.

## Security

This function works in conjunction with Blu-ray and DVD discs that have been assigned an age rating or numeric rating that indicates the maturity level of the content. These numbers help you control the types of Blu-ray and/DVD discs that your family can watch.

When you access this function for the first time, the password setup screen appears. Enter a desired 4-digit password using the number buttons. (The default password is 0000.)

After you have set your password, select an age rating you want to set for the BD Parental Rating and a rating level you want to set for the DVD Parental Rating. The product will only play Blu-ray discs rated at or below the age rating and DVD discs rated below the numeric rating unless the password is entered.

Larger numbers indicate more mature content.

## BD Parental Rating

This will prohibit playback of Blu-ray disc rated above Parental Rating.

## DVD Parental Rating

Prevent playback of DVD discs with specific numerical ratings unless a password is entered.

## Change Password

Change the 4-digit password used to access security functions.

### If you forgot your password

1. Remove the disc.
2. Press and hold the **STOP** (■) button on the front panel for 5 seconds or more. All settings will revert to the factory settings.

### NOTE

- When the factory default settings are restored, all the user stored BD data will be deleted.

## General

### Front Display

Change the brightness of the front panel.

- **Auto** : Dim during playback.
- **Dim** : Dim the display window.
- **Bright** : Brighten the display window.

### NOTE

- You cannot change the brightness of the Power button and the Function button.

### Light Effect

You can activate or deactivate the light effect on the top of the product.

- **Always On** : Activate Light Effect at all times. Select this for retail display.
- **Auto** : Activates Light Effect when you turn the product on and off or when you insert or eject a disc. Select when installing the product in your home.
- **Off** : Turn Light Effect off at all times.

## Network Remote Control

The Network Remote Control function lets you control your Blu-ray Home Theater from a remote device such as a smart phone through a wireless connection to your local area network.

To use the Network Remote Control function, follow these steps:

1. Select **On** in the Network Remote Control menu.
2. Install the Samsung network remote control application to control your product on your compatible portable device.
3. Make sure your portable device and your product are connected to the same wireless router.
4. Start the application on your portable device. The application should find your product and display it on a list.
5. Select the product.
6. If this is the first time you are using the function, it will ask you to allow or deny remote control of the product. Select **Allow**.
7. Follow the instructions that came with the application to control the product.

## Support

### Software Upgrade

The Software Upgrade menu allows you to upgrade the product's software for performance improvements or additional services. You can upgrade in four ways:

- By Internet
- By USB
- By Disc
- By Downloaded (File)

The four methods are explained below.

#### By Internet

To upgrade by Internet, follow these steps:

1. Select **By Internet**, and then press the **ENTER** button. The Connecting to Server message appears.
2. If there is a download available, the Download pop-up appears with a progress bar and the download starts.
3. When the download is complete, the Upgrade Query window appears with three choices: Upgrade Now, Upgrade Later, or Don't Upgrade.
4. If you select Upgrade Now, the product upgrades the software, turns off, and then turns on automatically.
5. If you do not make a selection in one minute or select Upgrade Later, the product stores the new upgrade software. You can upgrade the software later using the By Downloaded function.
6. If you select Don't Upgrade, the product cancels the upgrade.

#### NOTE

- Your product must be connected to the Internet to use the By Internet function.
- The upgrade is complete when the product turns off, and then turns on again by itself.
- Never turn the product off or back on manually during the update process.
- Samsung Electronics shall take no legal responsibility for product malfunction caused by an unstable Internet connection or consumer negligence during a software upgrade.
- If you want to cancel the upgrade while the upgrade software is downloading, press the **ENTER** button.

# Setup

## By USB

To upgrade by USB, follow these steps:

1. Visit [www.samsung.com/bluraysupport](http://www.samsung.com/bluraysupport)
2. Download the latest USB software upgrade zip archive to your computer.
3. Unzip the zip archive to your computer. You should have a single folder with the same name as the zip file.
4. Copy the folder to a USB flash drive.
5. Make sure the disc tray is empty, and then insert the USB flash drive into the USB port of the product.
6. In the product's menu, go to Settings > Support > Software Upgrade.
7. Select **By USB**.

### NOTE

- The disc tray must be empty when you upgrade the software using the USB Host jack.
- When the software upgrade is done, check the software details in the software Upgrade menu.
- Do not turn off the product during the software upgrade. It may cause the product to malfunction.
- Software upgrades using the USB Host jack must be performed with a USB memory flash stick only.

## By Disc

To upgrade by Disc, follow these steps:

1. Visit [www.samsung.com/bluraysupport](http://www.samsung.com/bluraysupport).
2. Download the latest disc software upgrade zip archive to your computer.
3. Unzip the zip archive to your computer. You should have a single folder with the same name as the zip file.
4. Write the folder onto a disc. We recommend a CD-R or DVD-R.
5. Finalize the disc before you remove it from your computer.
6. Insert the disc into product.

7. In the product's menu, go to Settings > Support > Software upgrade.
8. Select **By Disc**.

### NOTE

- When the system upgrade is done, check the software details in the software Upgrade menu.
- Do not turn off the product during the Software Upgrade. It may cause the product malfunction.

## By Downloaded

The By Downloaded option lets you upgrade using a file the product downloaded earlier but you decided not to install immediately or a file downloaded by the product in Standby Mode (See Download in Standby Mode below).

To upgrade By Downloaded, follow these steps:

1. If upgrade software has been downloaded, you will see the software version number to the right of By Downloaded.
2. Select By Downloaded, and then press the **ENTER** button.
3. The product displays a message asking if you want to upgrade. Select **Yes**. The product begins the upgrade.
4. When the update is complete, the product turns off automatically, and then turns on.

### NOTE

- When the system upgrade is done, check the software details in the software Upgrade menu.
- Do not turn off the product during the software Upgrade. It may cause the product to malfunction.
- To use the By Downloaded function, your product must be connected to the Internet.

## Download in Standby Mode

You can set the Download in Standby Mode function so that the product downloads new upgrade software when it is in Standby mode. In Standby mode, the product is off, but its Internet connection is active. This allows the product to download upgrade software automatically, when you are not using it.

To set Download in Standby Mode, follow these steps:

1. Press the ▲▼ buttons to select **Download in Standby Mode**, and then press the **ENTER** button.
2. Select **On** or **Off**.
  - **Off** : If you select **Off**, the product will notify you with a pop up message when new upgrade software is available.
  - **On** : If you select **On**, the product will automatically download new upgrade software when it is in Standby mode with the power off. If it downloads new upgrade software, the product will ask you if you want to install it when you turn the product on.



### NOTE

- To use the Download in Standby Mode function, your product must be connected to the Internet.

## Contact Samsung

---

Provides contact information for assistance with your product.

# Basic Functions

## Playing a Disc

### Playback

1. Insert a disc into the disc slot with the disc's label facing up.
2. Press the **PLAY** (▶) button.

### Playback related buttons

<b>PLAY</b> (▶)	Starts playback.
<b>STOP</b> (■)	Stops playback. <ul style="list-style-type: none"> <li>• If you press the button once : The stop position is memorized.</li> <li>• If you press the button twice : The stop position is not memorized.</li> </ul>
<b>PAUSE</b> (  )	Pauses playback.

#### NOTE

- For some discs, the product may not memorize the stop position when you press the **STOP** (■) button.
- Video files with high bit rates of 20Mbps or more strain the product's capabilities and may stop playing during play back.

### Disc Structure

The content of discs are usually divided as shown below.

#### • Blu-ray Disc, DVD-VIDEO

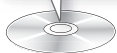
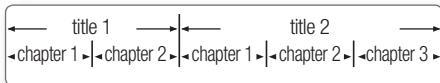

#### • Audio CD (CD-DA)



#### • MP3, WMA, DivX, MKV and MP4

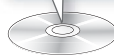

### Playing a 2D video in 3D mode



You can enjoy an ordinary 2D video in 3D mode.



#### NOTE

- If you move to the Home or Smart Hub Home menu in 3D mode, it will switch to 2D automatically.

## Using the Disc menu/Title menu/ Popup menu

### Using the Disc Menu



1. During playback, press the **DISC MENU** button on the remote control.



2. Press the ▲▼◀▶ buttons to make a selection, and then press the **ENTER** button.

#### NOTE

- Depending on the disc, the menu items may differ and this menu may not be available.



## Using the Title Menu

1. During playback, press the **TITLE MENU** button on the remote control.
2. Press the **▲▼◀▶** buttons to make the desired selection, then press the **ENTER** button.



### NOTE

- Depending on the disc, the menu items may differ and this menu may not be available.
- The Title Menu will only be displayed if there are at least two titles on the disc.

## Playing the Title List

1. During playback, press the **DISC MENU** or **TITLE MENU** button.
2. Press the **▲▼** buttons to select an entry you want to play from Title List, then press the **ENTER** button.



## Using the Popup Menu

1. During playback, press the **POPUP** button on the remote control.
2. Press the **▲▼◀▶** buttons or **ENTER** button to select the desired menu.



### NOTE

- Depending on the disc, the menu items may differ and this menu may not be available.

## Using the Search and Skip Functions

During playback, you can search quickly through a chapter or track, and use the skip function to jump to the next selection.

### Searching for a Desired Scene



- During playback, press the **SEARCH (◀◀▶▶)** button.  
Each time you press the **SEARCH (◀◀▶▶)** button, the playback speed will change as follows.

BD-ROM, BD-RE/-R, DVD-RW/+R, DVD-VIDEO	▶▶ 1 → ▶▶ 2 → ▶▶ 3 → ▶▶ 4 → ▶▶ 5 → ▶▶ 6 → ▶▶ 7 ◀◀ 1 → ◀◀ 2 → ◀◀ 3 → ◀◀ 4 → ◀◀ 5 → ◀◀ 6 → ◀◀ 7
DivX, MKV, MP4	▶▶ 1 → ▶▶ 2 → ▶▶ 3 ◀◀ 1 → ◀◀ 2 → ◀◀ 3

- To return to normal speed playback, press the **PLAY (▶)** button.

### NOTE

- The home theater does not play sound in search mode.
- If you press the **◀◀** or **▶▶** button too quickly this product might think you are just holding the button down. This will lead to improper operation. Be sure to not press these buttons too rapidly.

## Skipping Chapters



- During playback, press the **SKIP (I◀▶▶I)** button.  
If you press the **SKIP (▶▶I)** button, the disc moves to the next chapter.  
If you press the **SKIP (I◀▶▶I)** button, the disc moves to the beginning of the chapter. One more press makes the disc move to the beginning of the previous chapter.

# Basic Functions

## Slow Motion Play/Step Motion Play

### Slow Motion Play



- In **pause** (||) mode, press the **SEARCH** (▶▶) button.  
If you press the **SEARCH** (▶▶) button, the playback speed is reduced to  
▶▶ 1/8 ▶▶ 1/4 ▶▶ 1/2
- To return to normal speed playback, press the **PLAY** (▶) button.

#### NOTE

- The product does not play sound in slow mode.
- Slow motion operates only in the forward direction.

### Step Motion Play



- In pause mode, press the **PAUSE** (||) button. Each time the **PAUSE** (||) button is pressed, a new frame will be appear.
- To return to normal speed playback, press the **PLAY** (▶) button.

#### NOTE

- The product does not play sound in step mode.
- Step motion operates only in the forward direction.

## Repeat Playback

### Repeat the Title or Chapter



Repeat the disc title or chapter.

1. During playback, press the **REPEAT** button on the remote control.
2. Press the ▲▼ buttons to select **Chapter** or **Title**, then press the **ENTER** button.



50 English



3. To return to normal play, press the **REPEAT** button again.
4. Press the ▲▼ buttons to select **Off**, then press the **ENTER** button.

#### NOTE

- Depending on the disc, the Repeat function may not be available.

### Repeat the Section



1. During playback, press the **REPEAT** button on the remote control.
2. Press the ▲▼ buttons to select **REPEAT A-B**.



3. Press the **ENTER** button at the point where you want repeat play to start (A).
4. Press the **ENTER** button at the point where you want repeat play to stop (B).
5. To return to normal play, press the **REPEAT** button again.
6. Press the **ENTER** button.

#### NOTE

- If you set point (B) before 5 seconds has elapsed, a prohibition message will appear.

## Using the TOOLS button

During playback, you can operate the disc menu by pressing the **TOOLS** button.



### • TOOLS Menu Screen

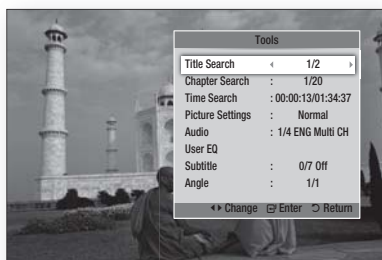

### NOTE

- Depending on the disc, the TOOLS menu may differ.

## Moving to a Desired Scene Directly



- During playback, press the **TOOLS** button.
- Press the **▲▼** buttons to select **Title**, **Chapter** or **Playing Time**.
- Enter the desired **Title**, **Chapter** or **Playing Time** using the number buttons, then press the **ENTER** button.

## Selecting the Audio Language



- During playback, press the **TOOLS** button.
- Press the **▲▼** buttons to select **Audio**.
- Press the **ENTER** button.
- Press the **▲▼** buttons to select the audio language you want.

### NOTE

- The **◀▶** indicator will not be displayed on the screen if the BONUSVIEW section does not contain any BONUSVIEW audio settings.

- Information about the primary / secondary audio modes will be also displayed if the Blu-ray Disc has a BONUSVIEW section. Use the **◀▶** button to switch between primary and secondary audio modes.
- The languages available depend on the languages that are encoded on the disc. This function or certain languages may not be available.
- Some Blu-ray Discs may allow you to select either the multi-channel LPCM or Dolby digital audio soundtrack in English.

## Selecting the Subtitle Language



- During playback, press the **TOOLS** button.
- Press the **▲▼** buttons to select **Subtitle**.
- Press the **◀▶** buttons to select the desired subtitle language.

### NOTE

- Depending on the Blu-ray Disc / DVD, you may be able to change the subtitle language in the Disc Menu. Press the **DISC MENU** button.
- The subtitle languages available depend on the subtitle languages encoded on the disc. This function or certain languages may not be available on all Blu-ray Discs/DVDs.
- Information about the primary / secondary subtitle modes will also be displayed if the Blu-ray Disc has a BONUSVIEW section.
- This function changes both the primary and secondary subtitles at the same time.
- The total number of subtitles is the sum of the primary and secondary subtitles.

# Basic Functions

## Caption Function



- You must have some experience with video extraction and editing in order to use this feature properly.
- To use the caption function, save the caption file (\*.smi) with the same file name as that of the DivX media file (\*.avi) within the same folder. Example. Root Samsung\_007CD1.avi  
Samsung\_007CD1.smi
- You can use up to 60 alphanumeric characters or 30 East Asian characters (2 byte characters such as Korean and Chinese) for the file name.

## Changing the Camera Angle



When a Blu-ray Disc/DVD contains multiple angles of a particular scene, you can use the ANGLE function.

1. During playback, press the **TOOLS** button.
2. Press the **▲▼** buttons to select **Angle**.
3. Press the **◀▶** buttons to select the desired Angle.

## Selecting the Picture Settings



This function enables you to adjust video quality.

1. During playback, press the **TOOLS** button.
2. Press the **▲▼** buttons to select **Picture Settings**, then press the **ENTER** button.
3. Press the **◀▶** buttons to select the desired **Mode**.
  - **Dynamic** : Choose this setting to increase Sharpness.
  - **Normal** : Choose this setting for most viewing applications.
  - **Movie** : This is the best setting for watching movies.

- **User** : The user can adjust the sharpness, noise reduction, Contrast, Brightness, Color, Tint(G/R) function.

### NOTE

- If the system is connected to a BD Wise-compliant TV that has set BD Wise to On, the picture setting menu will not appear.

## Setting the BONUSVIEW



The BONUSVIEW feature allows you to view additional content (such as commentaries) in a small screen window while the movie is playing. This function is only available if the disc has the Bonusview feature.



Primary a audio/video

Secondary a audio/video

1. During playback, press the **TOOLS** button.
2. Press the **▲▼** buttons to select **BONUSVIEW Video** or **BONUSVIEW Audio**.
3. Press the **◀▶** buttons to select the desired bonusview.

### NOTE

- If you switch from BONUSVIEW Video, BONUSVIEW Audio will change automatically in accordance with BONUSVIEW Video.

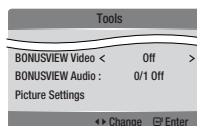

## Listening to Music



## Buttons on the Remote Control used for Music Playback

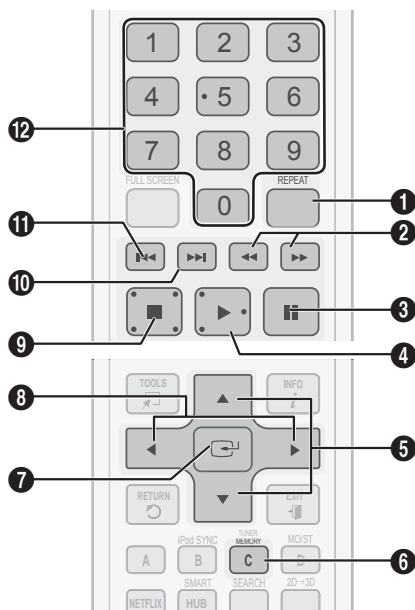

**7** **ENTER** button : Plays the selected track.

► button : During playback, moves to the next page in the Music List or moves to the next track in the Playlist.

**8** ◀ button : During playback, moves to the previous page in the Music List or moves to the previous track in the Playlist.

**9** **STOP** button : Stops a track.

**10** ►► button : Plays the next track.

◀◀ button : Plays the previous track.  
If you press this button after three seconds of playback in the Playlist, the current track will be replayed from the beginning. But, if you press this button within three seconds after playback starts in the Playlist, the previous track will be played.

**11** **NUMBER** button : During the Playlist playback, press the desired track number. The selected track will be played. (only Audio CD(CD-DA))

**1** **REPEAT** button : Selects the play mode in the Playlist.

**2** **SEARCH** buttons :  
Audio CD (CD-DA) - Fast Play.  
MP3 - Jump Play. (10 seconds)

**3** **PAUSE** button : Pauses playback.

**4** **PLAY** button : Plays the currently selected track.

**5** ▲▼ buttons : Selects a track in the Music List or Playlist.

**6** **YELLOW (C)** button : Select Edit Mode or Play Mode.

# Basic Functions

## Playing an Audio CD (CD-DA)/MP3

1. Insert an Audio CD (CD-DA) or an MP3 Disc into the disc slot.
  - For an Audio CD (CD-DA), the first track will be played automatically.
  - For an MP3 disc, press the ◀▶ buttons to select **Music**, then press the **ENTER** button.

### Audio CD (CD-DA)/MP3 Screen Elements

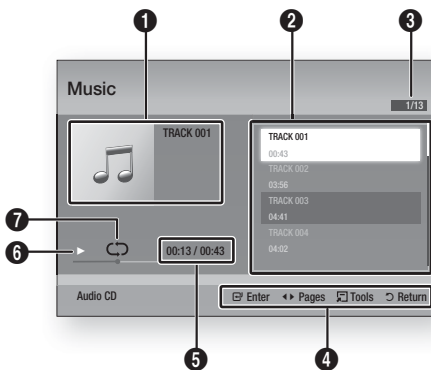

1	Displays the music information.
2	Displays the playlist.
3	Shows the current track/total tracks.
4	Displays buttons available.
5	Shows the current play time/total play time.
6	Displays the current playback status.
7	Displays the repeated playback status.

2. Press the ▲▼ buttons to select the track you want to play, and then press the **ENTER** button.

## Repeat an Audio CD (CD-DA)/MP3

1. During the Playlist playback, press the **REPEAT** button.
2. Select the desired play mode by pressing the **REPEAT** button repeatedly.



Off	Audio CD (CD-DA)/MP3	Tracks on a disc are played in the order in which they were recorded on the disc.
(C) One Song	Audio CD (CD-DA)/MP3	Current track is repeated.
(C) All	Audio CD (CD-DA)/MP3	All tracks are repeated.

### NOTE

- During playback, press the **TOOLS** button and set Shuffle Mode to On. You can play the tracks in a random order.

## Playlist

1. Insert an Audio CD (CD-DA) or an MP3 Disc into the disc slot.
  - For an Audio CD (CD-DA), the first track will be played automatically.
  - For an MP3 disc, press the ◀▶ buttons to select **Music**, then press the **ENTER** button.
2. To move to the Music List, press the **STOP** (■) or **RETURN** button. The Music List screen is displayed.
3. Press the **YELLOW (C)** button to switch to **Edit Mode**.
4. Press ▲▼◀▶ to select a desired track, and then press **ENTER**. Repeat this procedure to select additional tracks.
  - The selected file will be checked.
  - To cancel your selection, press **ENTER** again to uncheck the track.

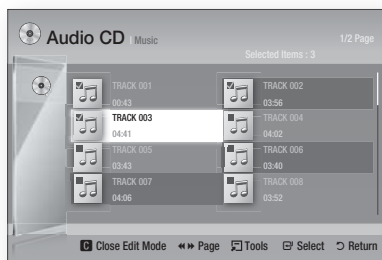

5. When done, press the **TOOLS** button.
6. To play the selected track(s), select Play Selected in the **Tools** menu, and then press **ENTER**.

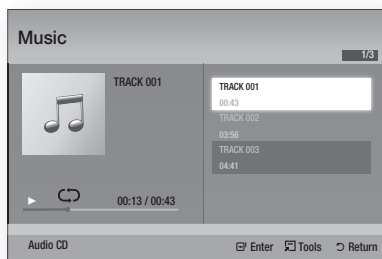

7. To return to the **Edit Mode**, press **STOP** or **RETURN**.
8. To exit **Edit Mode**, press the **YELLOW (C)** button.

#### NOTE

- You can create a playlist with up to 99 tracks on Audio CD (CD-DA).

## Sound Mode

### DSP (Digital Signal Processor) Function

You can select mode to optimize the sound for sound based on your tastes.

Press the **DSP** button.

**SMART SOUND** → **MP3 ENHANCER** →  
**POWER BASS** → **USER EQ** → **DSPOFF**

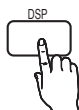

- **SMART SOUND** : Regulates and stabilizes the volume level and prevents a drastic volume change when you change channels or during a scene transition.
- **MP3 ENHANCER** : This also helps enhance your sound experience (ex. mp3 music). You can upscale your MP3 level sound (24 kHz, 8bit) to CD level sound (44.1 kHz, 16bit).
- **POWER BASS** : This function stresses low tones and provides thudding sound effects.
- **USER EQ** : You can configure the equalizer settings manually to your preference.

### SFE (Sound Field Effect) MODE

You can set the SFE mode best suited for the type of music you are listening to.



Press the **SFE MODE** button.

<b>Symphony Hall in Boston (Hall 1)</b>	Provides a clear vocal as if you are listening in a concert hall.
<b>Phillharmonic Hall in Bratislava (Hall 2)</b>	Also provides a clear vocal as if you are listening in a concert hall but, less powerful than HALL1.
<b>Jazz Club in Seoul B</b>	Recommended setting for Jazz.
<b>Church in Seoul</b>	Gives the feel of being in a grand church.
<b>Amphitheater (Rock)</b>	Recommended setting for Rock.
<b>Off</b>	Select this for normal listening.

# Basic Functions

## Dolby Pro Logic II Mode

You can select the desired Dolby Pro Logic II audio mode.

Press the  **PL II** button.



<b>Music</b>	When listening to music, you can experience sound effects as if you are listening to the actual performance.
<b>Movie</b>	Adds realism to the movie soundtrack.
<b>Prologic</b>	You can listen to a 2CH sound source in 5.1CH surround sound with all speakers active. - A specific speaker(s) may not output depending on the input signal.
<b>Matrix</b>	You will hear multi channel surround sound.
<b>Stereo</b>	Select this to listen to sound from the front left and right speakers and the subwoofer only.

### **NOTE**

- Before selecting Dolby Pro Logic II mode, connect your external device to the AUDIO INPUT jacks (L and R) on the product. If you connect to only one of the inputs (L or R), you cannot listen to surround sound.

## iPod SYNC

If you insert your iPod player into the iPod Dock that has already been connected to the system, you can play the video files in your iPod player through the connected TV.

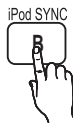

If the video signal does not synchronize properly with the audio signal, press **iPod SYNC** on the remote control to correct the synchronization.

### **NOTE**

- Before you can play the video files in the iPod player, you must connect the Audio/Video terminals of the TV to the home theater using the Composite (AV) cable.

- The models below support audio sync settings. Press **iPod SYNC** on the remote control to change audio delay.
- Supported Models : classic/3G nano/4G nano/120GB classic/160GB Classic/5G nano

## 3D Sound

You can enjoy more natural and vivid surround sound with enriched tones by adjusting the depth of sound using the level options.



**Off** → **High** → **Medium** → **Low**.

### **NOTE**

- It is not available in **FM** or **W. IPOD** mode.

## Vertical Surround

Implementing the vertical sound field effect, it reinforces the sense of space for music and movie in addition to vivid sound tones.



**Off** → **High** → **Low** → **Off**.

## Playing back a Picture



## Viewing Photo Files

1. Connect a USB memory that contains JPEG files or insert a disc that contains JPEG files.
2. Press the **◀▶** buttons to select the **My Contents**, and then press the **ENTER** button after press the **▲▼** buttons to select the **Photos**.
3. Press the **▲▼◀▶** buttons to select the folder you want to play, and then press the **ENTER** button.
4. Press the **▲▼◀▶** buttons to select the photo you want to play, and then press the **ENTER** button.

### **NOTE**

- You can't enlarge the subtitle and PG graphic in the full screen mode.



## Using the TOOLS button

During the slide show playback, you can use various function by pressing the **TOOLS** button.

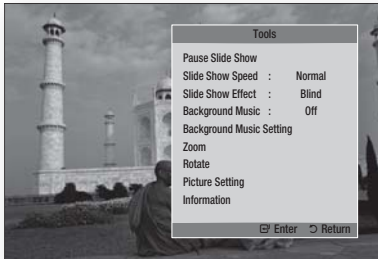

- **Pause Slide Show** : Select to pause the slide show.
- **Slide Show Speed** : Select to adjust the slide show speed.
- **Slide Show Effect** : Select to set the slide show effects.
- **Background Music** : Select to listen to music while viewing a slide show.
- **Background Music Setting** : Select to set the background music.
- **Zoom** : Select to enlarge the current picture. (Enlarge up to 4 times)
- **Rotate** : Select to rotate the picture. (Rotate the picture either clockwise or counter clockwise.)
- **Picture Setting** : Select to adjust the picture quality.
- **Information** : Shows the picture information including the name and size, etc.

### NOTE

- Before you can enable the background music function, the photo file should exist in the same storage media with the music file. However, the sound quality can be affected by the bit rate of the MP3 file, the size of the photo and the encoding method.

## Playing back a USB Storage Device



You can use the USB connection to play multimedia files (MP3, JPEG, DivX, etc) downloaded from the USB storage device.

1. Move to the home menu.

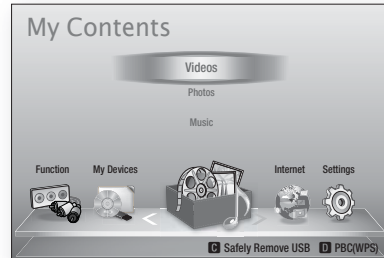

2. In Stop mode, connect the USB storage device to the USB port on the front panel of the product.



3. Press the **ENTER** button.
4. Press the **▲▼◀▶** buttons to select Videos, Music or Photos, and then press the **ENTER** button.
5. For playing back Video, Music or Photo files, refer to pages 48~57.

### NOTE

- You must remove the USB storage device safely (by performing the "Safely Remove USB" function) to prevent possible damage to the USB memory. Press the **MENU** button to move to the home menu, select the **YELLOW (C)** button, and then press the **ENTER** button.
- If you insert the disc when playing USB storage device, the device mode is changed to "BD/DVD" automatically.

# Basic Functions

## Listening to Radio

### Using buttons on the Remote Control

1. Press the **FUNCTION** button to select **FM**.
2. Tune in to the desired station.
  - **Preset Tuning 1** : You must first add a desired frequency as a preset. Press the **STOP** (■) button to select **PRESET** and then press the **TUNING/CH** (^v) button to select the preset station.
  - **Manual Tuning** : Press the **STOP** (■) button to select **MANUAL** and then press the **TUNING/CH** (^v) button to tune in to a lower or higher frequency.
  - **Automatic Tuning** : Press the **STOP** (■) button to select **MANUAL** and then press and hold the **TUNING/CH** (^v) button to automatically search the band.

### Setting Mono/Stereo

Press the **MO/ST** button.

- Each time the button is pressed, the sound switches between **STEREO** and **MONO**.
- In a poor reception area, select **MONO** for a clear, interference-free broadcast.



### Presetting Stations

Example : Presetting FM 89.10 into memory

1. Press the **FUNCTION** button to select **FM**.
2. Press the **TUNING/CH** (^v) button to select <89.10>.
3. Press the **TUNER MEMORY** button.
  - **NUMBER** flashes on the display.
4. Press the **TUNER MEMORY** button again.
  - Press the **TUNER MEMORY** button before **NUMBER** disappears from the display.
  - **NUMBER** disappears from the display and the station is stored in memory.
5. To preset another station, repeat steps 2 to 4.
  - To tune in to a preset station, press the **TUNING/CH** (^v) button to select a channel.



## Connecting an iPod/iPhone Using the USB Cable

If the home theater is connected to an iPod/iPhone using the provided USB cable, you can play music in iPod/iPhone through the home theater.

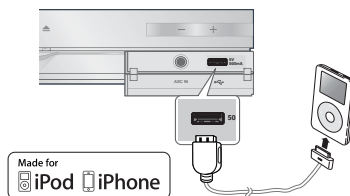

1. Connect an iPod/iPhone using the USB cable to the front USB port.
  - Your iPod is automatically turned on.
  - The "iPod" message appears on the TV screen.
2. Press the **ENTER** button.
3. Select the music file to play.
  - You can use the remote control or the product to control simple playback functions such as the **PLAY**, **PAUSE**, **STOP**, **⏪** / **⏩** and **⏴** / **⏵** buttons. (See page 17.)

### NOTE

- You can play a video only when you use the iPod Dock.
- If you want to return to the iPod menus while the iPod player is connected using the USB cable, press **FUNCTION** on the remote control or press **⏪** on the front panel of the system and select **R. IPOD**. The **FUNCTION** mode switches as follows: **BD/DVD** → **D. IN** → **AUX** → **R. IPOD** → **W. IPOD** → **H. IN1** → **H. IN2** → **FM**

## Connecting an iPod/iPhone Using the Dock

If the home theater is connected to the iPod/iPhone specific dock, you can play videos or music in an iPod/iPhone through the home theater.

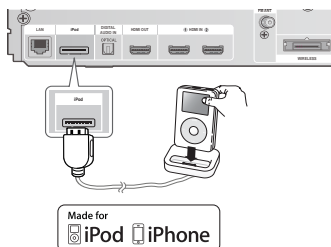

## Playing Music



1. Connect the iPod dock connector to the iPod Jack on the rear panel of the product.
2. Place the iPod in the supplied iPod Dock.
  - Your iPod automatically turns on.
  - The "iPod" message appears on the TV screen.
3. Press the **ENTER** button.
4. Press the **◀▲▼** buttons to select **Music**, and then press the **ENTER** button.
5. Select the music file to play.
  - You can use the remote control or product to control simple playback functions such as the **PLAY, PAUSE, STOP, ◀◀/▶▶, ◀◀/▶▶** and **REPEAT** buttons. See page 17.

### NOTE

- Adjust the volume to a moderate level before you connect your iPod to the product.
- When the product is on and you connect an iPod, the product will charge the iPod's battery.
- Make sure to connect the dock connector so that the label "▲" faces upward.

## Watching a Movie

You can play video files stored in the iPod player by connecting it to the product.

1. Connect the iPod dock connector to the iPod Jack on the rear panel of the product.
2. In the iPod screen, move to **Videos** > **Settings**, then set the TV Out option and the TV signal.
3. Place the iPod in the supplied iPod Dock.
  - The "iPod" message appears on the TV screen.
4. Press the **ENTER** button.
5. Press the **◀▲▼** buttons to select **Video**, and then press the **ENTER** button.

6. Select the video file to play.
  - You can use the remote control or the product to control simple playback functions such as the **PLAY, PAUSE, STOP, ◀◀/▶▶, ◀◀/▶▶** and **◀◀/▶▶** buttons. (See page 17.)

### NOTE

- You must have the VIDEO output (Composite) connected to your TV to view iPod video (See page 25).
- If you want to play iPod video via VIDEO output, set Anynet+ (HDMI-CEC) to off.
- No screen but the playback screen will appear on the TV. View other iPod screens on the iPod player.
- If the connected iPod does not support video playback, the "Playing video files is not supported on this iPod model." message appears when you select the Video menu.
- If you want to return to the iPod menus while the iPod player is connected using the dock, press **FUNCTION** on the remote control or press  on the front panel of the system and select **R. IPOD**. The **FUNCTION** mode switches as follows : **BD/DVD → D. IN → AUX → R. IPOD → W. IPOD → H. IN1 → H. IN2 → FM**

### Use an iPod/iPhone with a Wireless Dock Cradle (sold separately) for iPod/iPhone

You can enjoy finer quality music through the speakers by transmitting an iPod/iPhone's audio signal using a Wireless Transmitter.

To connect the Cradle to the main unit when you use the Cradle the first time, you have to set the Linking ID manually. (see page 61)  
After you set the Linking ID, the Cradle will connect to the Wireless Transmitter automatically when you turn it on.

### To use the Wireless Dock Cradle:

Turn on the main unit and connect the iPod/iPhone to the Wireless transmitter.

Then, press the  button on the product to select "**W. IPOD**" mode.

The **FUNCTION** mode of the main unit switches as follows : **BD/DVD → D. IN → AUX → R. IPOD → W. IPOD → H. IN1 → H. IN2 → FM** ( See page 15)

# Basic Functions

## How to charge the Wireless Transmitter

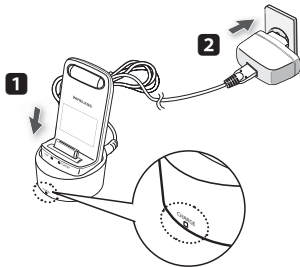

1. Connect the Wireless Transmitter to the Charging Cradle.
2. Connect the DC power adapter to a wall socket.
  - The charging indicator lights and charging starts. After the battery is fully charged, the charging indicator turns Green.

## Operation status of the charging cradle's LED

Display	Function
GREEN LED ON	Power on /Charging completed
RED LED ON	Charging.

### NOTE

- The LED indicates the charging state of the built-in battery in the wireless iPod transmitter. Check the charging state of iPod/iPhone by checking the charging indication of its battery.
- **Wireless Dock Cradle can be linked with Home Theater when SWA-5000 is used.**
- **The charger can only recharge Samsung wireless transmitters whose specifications are compliant with the charger.**

### iPod/iPhone Models You Can Use with This Product

- iPod touch (3rd generation)
- iPod touch (2nd generation)
- iPod touch (1st generation)
- iPod classic
- iPod with video

- iPod with dock connector
- iPod with Click Wheel
- iPod nano (5th generation)
- iPod nano (4th generation)
- iPod nano (3rd generation)
- iPod nano (2nd generation)
- iPod nano (1st generation)
- iPhone 4
- iPhone 3GS
- iPhone 3G
- iPhone

### NOTE

- “Made for iPod” means that an electronic accessory has been designed to connect specifically to iPods and has been certified by the developer to meet Apple performance standards.
- “Made for iPhone” means that an electronic accessory has been designed to connect specifically to iPhones and has been certified by the developer to meet Apple performance standards.
- Apple is not responsible for the operation of this device or its compliance with safety and regulatory standards.
- The volume control may not operate normally with iPod and iPhone models not listed above. If you have a problem with any of the models listed above, please update the software of the iPod/iPhone to the latest version.
- Depending on the software version of the iPod, control problems may occur. This is not a malfunction of the Home Theater.
- Depending on the software version or the type of the iPod, some operations may differ. Install the latest iPod software. (recommended)
- Some actions like iPod SYNC may depend on video sources or the iPod model you have.
- You can enjoy music or videos through the BD/DVD function and enjoy music, videos or photos through the Remote iPod function. You need to use iPod Dock to enjoy videos or photos.



- Playback of applications' contents through the product is not guaranteed. We recommend playing contents downloaded to the iPod.
- If you have a problem using your iPod, please visit [www.apple.com/support/ipod](http://www.apple.com/support/ipod)

### How to Link the Wireless Transmitter with the Main Unit

1. Turn off your Home Theater.
2. Press the **4, 7, 6, 3** buttons on the remote control in order.
  - The Power LED blinks once.
3. Connect the iPod/iPhone to the Wireless transmitter.

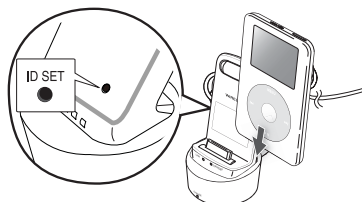

4. Turn on the iPod/iPhone. Press the **"ID SET"** button on the back of the Wireless transmitter for 5 seconds. The link light on the wireless transmitter blinks rapidly.
5. Turn on your product.
  - To listen to music from your iPod/iPhone over the product, press the  button to select **"W. IPOD"** mode.
  - After you select **"W. IPOD"** mode, turn the volume of the product down to avoid hearing damage.
  - You can control the speaker volume of the iPod/iPhone with a volume wheel or a volume bar.
  - When the iPod/iPhone is stopped or in a power saving mode, the Wireless transmitter enters Sleep Mode. When iPod/iPhone is set to Deep Sleep Mode, the Wireless transmitter turns off.

### Operation status of the wireless transmitter's LED

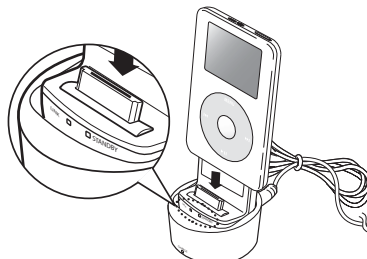

Display	Function	
	LINK (Blue LED)	STANDBY (Red LED)
LED ON	Pairing successfully completed	STANDBY
LED BLINK (Long blink)	Processing iPod/iPhone	LOW BATTERY
LED BLINK (Short blink)	Processing pairing	Pairing failed

### ! CAUTION

- If you use a wireless device such as a laptop computer, an AP, or Wifi, near the main home theater unit, an unstable operation error can occur.
- Do not pair the SWA-5000 and iPod/iPhone at the same time. If you pair them at the same time, the iPod/iPhone and SWA-5000 may not connect to the product.
- The maximum transmission distance from the product to the wireless transmitter is about 16.4 feet, but may vary depending on your operation environment.
- The audio signal may be weakened or even lost where there is an obstacle such as a wall or partition between the product and wireless transmitter. You can also weaken or lose signal if you move the wireless transmitter around.

# Network Services

You can enjoy various network services such as Smart Hub or BD-LIVE by connecting the product to your network.

Read the following instructions before using any network service.

1. Connect the product to the network.  
(see pages 27~28)
2. Configure the network settings.  
(see pages 39~42)

## Using Smart Hub

Using Smart Hub, you can stream movies, videos, and music from the Internet, access various for pay or free-of-charge applications and view them on your TV. Application content includes news, sports, weather forecasts, stock market quotes, maps, photos, and games.

You can also start this function by pressing the **SMART HUB** button on the remote control.



## Starting Smart Hub the First Time

To start Smart Hub for the first time, follow these steps :

1. Go to the Home menu.

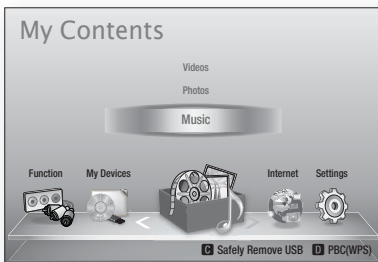

2. Press the ◀▶ buttons to select **Internet**, and press the **ENTER** button.

3. The Smart Hub screen appears.

### NOTE

- Certain applications are available only in certain countries.

4. The Terms of Service Agreement screen appears.

If you want to agree, press the ◀▶ buttons to select **Agree**, then press the **ENTER** button.

### NOTE

- Screens can take a few seconds to appear.

5. The Service Update screen appears and installs a number of services and applications. When done, it closes. The applications and services downloaded are displayed on the Smart Hub screen. This may take some time.

### NOTE

- Smart Hub may close momentarily during the installation process.
- A number of screens may appear after installation. You can press the **ENTER** button to close them or let them close on their own.

6. To start an application, press the ▲▼◀▶ buttons to highlight a widget, then press the **ENTER** button.

## Smart Hub at a Glance

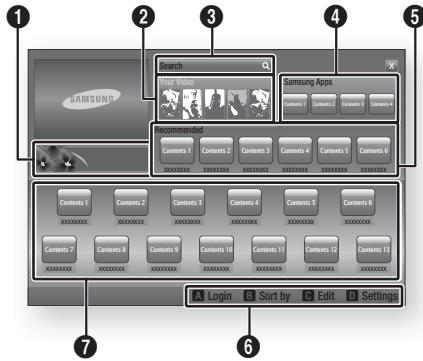

**1 Commercial** : Displays the Smart Hub Guide, an introduction to the product, and new application introductions.

**2 Your Video** : Provides recommendations for videos based on your tastes.

- Lets you see movie recommendations based on your previous preferences.
- Lets you select a movie, displays a list of VOD (Video on Demand) providers that have the movie, and then lets you choose a provider for streaming. (Streaming is unavailable in some areas.)
- For instructions to use Your Video, please visit [www.samsung.com](http://www.samsung.com).
- This feature is limited to certain regions.

**3 Search** : Provides an integrated search of your video providers and connected AllShare devices.

- Usable while using Smart Hub (except when you are watching a Blu-ray Disc).
- For easy access, use the **SEARCH** button on the remote control.
- For instructions to use search function, please visit [www.samsung.com](http://www.samsung.com).

**4 Samsung Apps** : You can download various for pay or free-of-charge application services.

**5 Recommended** : Displays recommended contents managed by Samsung.

**Navigation Help** : Displays the remote control buttons you can use to navigate in Smart Hub.

- **RED (A)** : To log in to Smart Hub.
- 6** • **GREEN (B)** : To sort the applications.
- **YELLOW (C)** : To edit the applications.
- **BLUE (D)** : To change the settings of Smart Hub.

**7 My Applications** : Displays your personal gallery of applications which you can add to, modify, and delete.

### NOTE

- Samsung Electronics takes no legal responsibility for any interruption of the Smart Hub service caused by the service provider for any reason.
- The Smart Hub service downloads and processes data via the Internet so that you can enjoy the Internet contents on your TV screen. If the Internet connection is unstable, the service may be delayed or interrupted. Furthermore, the product may turn off automatically in response to conditions on the Internet. If this occurs, check the Internet connection and try again.
- Application services may be provided in English only and the contents available may vary, depending on your area.
- For more information about a Smart Hub service, visit the web site of the applicable service provider.
- The services provided are subject to change by the Smart Hub service provider without notice.
- The Smart Hub service contents may differ depending on the product's firmware version.
- For pay DivX contents with copy protection can only be played through a composite, a component or an HDMI cable.

# Network Services

## Using the Keypad

Through your remote, you can use the On-Screen Keypad to enter letters, numbers, and symbols.

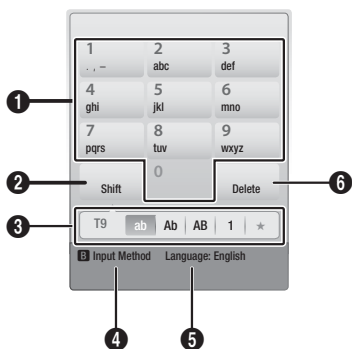

1	The current keypad. Use to enter letters, numbers, and symbols.
2	Press the <b>FULL SCREEN</b> button on the remote control to shift the input mode. : ab, Ab, AB, numbers or icons.
3	Displays the current input mode.
4	Press the <b>GREEN (B)</b> button on the remote control to change the input method. (T9 or ABC)
5	Press the <b>TOOLS</b> button on the remote control to change the language.
6	Press the <b>REPEAT</b> button on the remote control to delete a character.

## Entering Text, Numbers and Symbols

To enter text, press the number button on the remote that corresponds to the letter you want to enter. Press the button rapidly to enter a letter that is not the first letter listed on the On-Screen keypad button. For example, if you want to enter the letter b, press the 2 button on your remote rapidly twice. To enter the first letter listed on a button, press, release, and then wait.

To move within the text, use the Arrow buttons. To delete text, move the cursor to the right of the character you want to delete, and then press the **REPEAT** button. To change case or enter numbers or punctuation, press the **FULL SCREEN** button.

**64** English

## Creating an Account

To establish your own, exclusive, configuration of Smart Hub, create your own Smart TV Account.

To create an account, follow these steps:

1. Press the **RED (A)** button on your remote control. The Login screen appears.

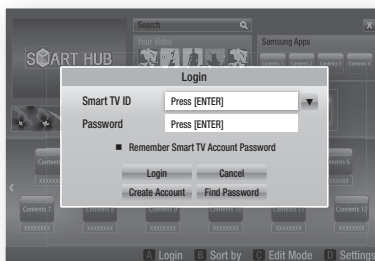

2. Press the **▲▼◀▶** buttons to select **Create Account**, and then press the **ENTER** button.
3. On the next screen, select **Smart TV ID**, and then press the **ENTER** button. An entry screen and keypad appear.
4. Use the keypad to enter your e-mail address. This will serve as your ID.

### NOTE

- The keypad works like the keypad on a cell phone.

5. When done, press the **ENTER** button to select **OK**, and then press the **ENTER** button again. The Create Account screen reappears.

6. Select **Password**, and then press the **ENTER** button. The Password screen and a keypad appear.

7. Use the keypad to enter a password. The password can be any combination of letters, numbers, and symbols.

### NOTE

- Press the **RED (A)** button on your remote to show or hide the password as you enter it.



8. When done, press the **ENTER** button to select **OK**, and then press the **ENTER** button again. The Create Account screen re-appears.
9. Select **Confirm password**, and then press the **ENTER** button.
10. Repeat Steps 7 and 8.
11. When the Create Account screen re-appears, select **Create Account**, and then press the **ENTER** button. The Confirmation window appears.
12. Select **OK**, and then press the **ENTER** button. The Continue to Register Service window appears.
13. Select **Connect Service**, and then press the **ENTER** button.
14. The Register Service Account Window appears.
  - If you have existing accounts with any of the listed providers, you can associate the provider account and the provider account password with your Smart TV Account. Registration makes it easier to access the providers web site. For registration instructions, go to Step 2 in Account Management under the Settings Menu.
  - If you don't have existing provider accounts or do not want to register existing accounts at this time, select **OK**, and then press the **ENTER** button. You can also let the window close on its own in about a minute.

#### **NOTE**

- You must use an e-mail address as an ID.
- You can register up to 10 User Accounts.
- You do not need an account to use Smart Hub.

### Account Log In

To log in to your Smart TV Account, follow these steps:

1. With the Smart Hub main screen displayed on your TV, press the **RED (A)** button on your remote. The Login screen appears.

2. Select the **Down Arrow** next to the **Smart TV ID** field, and then press the **ENTER** button.
3. Select your ID from the list that appears, and then press the **ENTER** button. The Login screen re-appears.
4. Select **Password**, and then press the **ENTER** button. The Password window and a keypad appears.
5. Using the keypad and your remote, enter your password. When done, press the **ENTER** button, select **OK**, and then press the **ENTER** button again.

#### **NOTE**

- If you want Smart Hub to enter your password automatically, select Remember my Smart TV ID and password after you have entered your password, and then press the **ENTER** button. A check appears. Smart Hub will now enter your password automatically when you select or enter your ID.

### The Settings Menu - BLUE (D)

The Settings Menu Screen gives you access to account management, account reset, and account properties functions.

To access the Settings Menu, and then select a menu item, follow these steps:

1. Press the **BLUE (D)** button on your remote.
2. Press the **▲ ▼** to select a menu item, and then press the **ENTER** button.

The functions on the Settings Menu screen are described below.

#### **NOTE**

- The Service Manager item listed in the Settings Menu is not available for Blu-ray Home Theaters.

### Account Management

The Account Management Menu contains functions that let you register your service provider accounts, change your Smart Hub password, and delete or deactivate your Smart TV Account.

# Network Services

## Register Service Account

If you have existing accounts with any of the providers listed by the Register Service Account function, you can associate the provider account and the provider account password with your Smart TV Account. If you associate the account, you will be able to log onto the account through Smart Hub easily, without entering your account name or password.

To use the Account Management function, follow these steps:

1. In the Account Management menu, select Register Service Account, and then press the **ENTER** button. The Register Service Account Window appears.
2. Press the **▲▼** arrow buttons to select a Service Provider you want to associate with your Smart TV Account, and then press the **ENTER** button.



### NOTE

- If you have a Samsung account and you want to use the Samsung Apps function in Smart Hub, you must register your Samsung Apps account here. See page 69 for more information.
3. Using your remote and the on-screen Keypad, enter your site ID and password. When done, press the **ENTER** button.



### NOTE

- This is the ID and password you normally use to access your account on this site.
4. If you have entered the ID and password correctly, the Registered Successfully message appears.
  5. If you pressed **OK**, repeat Steps 2 through 4 to associate another Service Provider.
  6. When you are done, press the **RETURN** button.

## Change Password

The Change Password function lets you change your Smart Hub password. To change the password, follow these steps:

1. Select **Change Password**, and then press the **ENTER** button.
2. Enter your current password. The next screen appears.
3. On the next screen, enter a new password on the first line. Enter it again on the second line to confirm.
4. The Changing Password Complete message screen appears. Press the **ENTER** button or wait for the screen to close - about 5 seconds.

## Remove Service Accounts

The Remove Service Accounts function cancels all your current registered Service Accounts that you registered on the Register Service Account screen.

## Deactivate Account

The Deactivate Account function deactivates your Smart TV Account and deletes it and all your account settings entirely from Smart Hub.

## Reset

The Reset function initializes all downloaded widgets, erases all user accounts and settings from the product, and resets all Smart Hub settings to the factory default settings. It then restarts Smart Hub as if it were starting for the first time. Your account, however, remains on the Smart Hub server. To log into your account, enter your ID and password on the Create Account screen.

To use the Reset function, follow these steps:

1. In the Account Management menu, select Reset, and then press the **ENTER** button. The Reset screen appears.
2. Enter the your Security password. This is the password you entered if you set up a BD or DVD Parental rating (See page 44). If you did not, enter 0000.

3. After a few moments, Smart Hub automatically resets. The screen may go black, then Smart Hub re-appears. In a few moments, it starts the re-initialization procedure.
4. To complete the re-initialization, go to Step 4 in Starting Smart Hub for the First Time. (See page 62)

#### NOTE

- If you forgot your password, press the **STOP** (■) button on the front panel of the product for more than 5 seconds with no disc inserted.

### Properties

The Properties menu item lists three functions that display information about Smart Hub :

#### More

Lists information about Smart Hub including version number, the number of services installed, memory usage, and the unique product ID.

#### Check the speed of your internet connection

Runs a test which shows how fast your connection to the Samsung's server is in Mbps (Megabits per second). Speeds lower than 1.5 Mbps can limit your enjoyment of Smart Hub.

#### Terms of Service Agreement

Displays the Terms of Service Agreement.

### The Edit Mode Menu - YELLOW (C)

The functions in the Edit Mode menu let you manipulate the widgets in the My Applications section of the Smart Hub screen. Using these functions, you can lock and unlock access to some widgets, New Folder and move widgets to them, rename folders, delete widgets, and change the position of widgets on the screen.

To access the Edit Mode Menu, and then select a menu item, follow these steps:

1. Press the **YELLOW (C)** button on your remote. The Edit Mode menu bar appears on the bottom of the screen.

2. Press the **▲▼◀▶** to select a menu item, and then press the **ENTER** button.

The functions in the Edit Mode Menu bar are described below.

#### NOTE

- Some menu items may not appear on the screen. To see these items, press the **◀▶** to move to the screen edge, and then press one more time to reveal the items.
- You can close the bar by highlighting the X on the bottom right side, and then pressing the **ENTER** button.

### Move

The Move function lets you change the screen position of a widget. To use the Move function, follow these steps:

1. Press the **YELLOW (C)** button on your remote.
2. Select a widget, and then press the **ENTER** button. A check appears above the widget.
3. Press the **▲▼◀▶** to select **Move**, and then press the **ENTER** button. The Move window opens.
4. Press the **▲▼◀▶** to move the icon. Press the **ENTER** button when the icon is in the position of your choice. The widget moves to its new location.

### New Folder

The New Folder function lets you create and name new folders. Once you have created a folder, you can move widgets into it. To use the New Folder function, follow these steps:

1. Press the **YELLOW (C)** button on your remote.
2. Press the **▲▼◀▶** to move the cursor to New Folder, and then press the **ENTER** button. The New Folder window and a keypad appear.
3. Use the keypad to enter the name of the folder, and then press the **ENTER** button. The New Folder screen closes and the New Folder appears on the Smart Hub screen.

# Network Services

## Move to Folder

The Move to Folder function lets you move a widget to a folder. To use the Move to Folder function, follow these steps:

1. Press the **YELLOW (C)** button on your remote.
2. Select a widget, and then press the **ENTER** button.
3. Press the **▲▼◀▶** to select Move to Folder, and then press the **ENTER** button. The Move to Folder window opens.
4. Press the **▲▼◀▶** to select a folder, and then press the **ENTER** button. The Moved to Folder message appears, and then closes. The widget has been moved to the folder.

### To Access Widgets in a Folder

1. Close the Edit Mode menu.
2. In My Applications, press the **▲▼◀▶** to select a folder, and then press the **ENTER** button. The folder opens.
3. Select a widget, and then press the **ENTER** button. The widget's application or service starts.

### To Edit Items in a Folder

Select a folder, and then press the **ENTER** button. The folder opens.

Press the **YELLOW (C)** button on your remote. The Edit buttons appear at the bottom of the screen.

These buttons work the same as the Edit Mode menu buttons on the main screen. For example, to move a widget back to the My Applications main screen:

1. Select the widget.
2. Select Move to Folder, and then press the **ENTER** button. The Move to Folder window appears.
3. Select My Applications, and then press the **ENTER** button. The Move to Folder window closes and the widget returns to the main My Applications screen.

## Rename Folder

The Rename Folder function lets you rename folders. To use the Rename Folder function, follow these steps:

1. Press the **YELLOW (C)** button on your remote.
2. Press the **▲▼◀▶** to select a folder, and then press the **ENTER** button.
3. Press the **▲▼◀▶** to select Rename a Folder, and then press the **ENTER** button. The Folder Rename window and a keyboard appears.
4. Use the key board to enter a new name, and then press the **ENTER** button. The Rename window closes and the new name appears below the folder.

## Lock

The Lock function lets you lock some widgets in My Applications so they can not be opened without entering the Parental Security Code.

To use the Lock function, follow these steps:

1. Press the **YELLOW (C)** button on your remote.
2. Press the **▲▼◀▶** to select a widget, and then press the **ENTER** button. If the widget can be locked, the Lock menu item is enabled.
3. Press the **▲▼◀▶** to select Lock, and then press the **ENTER** button. The Security window appears.
4. Enter your Parental Security Code (See page 44). If you have not created a Parental Security Code, enter 0000.
5. Press the **ENTER** button. The Lock Service window appears confirming the lock, and then closes. A lock symbol appears next to the widget.

## Unlock

1. Press the **YELLOW (C)** button on your remote.
2. Press the **▲▼◀▶** to select a locked widget, and then press the **ENTER** button.
3. Press the **▲▼◀▶** to select Unlock, and then press the **ENTER** button. The Security window appears.
4. Enter the Parental Security Code (See page 44). If you have not created a Parental Security Code, enter 0000.
5. Press the **ENTER** button. The Lock Service Released window appears confirming the lock has been release, and then closes.

## Delete

The Delete function lets you delete widgets from My Applications. To use the Delete function, follow these steps:

1. Press the **YELLOW (C)** button on your remote.
2. Press the **▲▼◀▶** to select a widget, and then press the **ENTER** button.
3. Press the **▲▼◀▶** to select Delete, and then press the **ENTER** button. The message, "Do you want to delete the selected item(s)?" appears.
4. Select **Yes**, and then press the **ENTER** button. The widget is deleted.

## The Sort Menu - GREEN (B)

The functions in the Sort Menu let you sort the widgets in My Applications by Name, Date, Frequency (of use), and Category. If you manually change the position of a widget, the Sort Menu automatically highlights User Defined when you start it.

To sort the widgets in My Applications, follow these steps:

1. Press the **GREEN (B)** button on your remote.
2. Press the **◀▶** to select a sorting method, and then press the **ENTER** button. Smart Hub sorts the widgets by the method you have chosen.

## Samsung Apps

Samsung Apps lets you download for pay or free-of-charge applications and services to your Blu-ray Home Theater and view or use them on your TV.

These applications and services include videos, music, photos, games, news, sports, etc. Widgets for the new apps appear in My Applications.

Additional applications and services are added regularly.

## For Pay Apps

To download for pay apps, you need to create a Samsung Account and add a credit card to the account.

To create a Samsung account, please visit [www.samsung.com](http://www.samsung.com)

### NOTE

- This service may not provided in some countries.

## Accessing the Samsung Apps Screen

To access Samsung Apps, press the **▲▼◀▶** buttons to navigate to the Samsung Apps area on the Smart Hub main screen, and then press the **ENTER** button. The Samsung Apps screen appears.

### NOTE

- If this is the first time you are accessing this screen, the terms of service window appears. Select Agree, and then press the **ENTER** button.

# Network Services

## Using the Samsung Apps Screen

To use the Samsung Apps screen, follow these steps:

1. Press the ◀▶ buttons to move to the category list on the left.
2. Press the ▲▼ to highlight a category. In a few seconds, the Samsung Apps screen displays the applications in that category. The Sort tabs appear across the top.
3. Press the ▶ button to move to the displayed applications or services.
4. Press the ▲▼◀▶ buttons to select an application or service, and then press the **ENTER** button. The Application Details screen appears describing the service or application.
5. Select Download Now, and then press the **ENTER** button. If the application or service is free, it downloads and runs. If not, and there is a fee, follow the directions on the screen to complete the download.



### **NOTE**

- Some apps are free to download, but require registration with the provider or a paid account with the provider to use.
- Widgets for applications and services you have downloaded from Samsung Apps appear in My Applications.

## **Sort By Tabs**

You can access the Sort By tabs on the top of the screen using the ▲▼◀▶ buttons. Each tab displays the services or applications in the category you chose, sorted by the criteria on the tab (Recommended, Most Downloaded, Most Recent, Name).

You can also use the **BLUE (D)** button on your remote to access the Sort By tabs. Each time you press the **BLUE (D)** button, you change the display from one sort tab to the next.

## Samsung Apps by category

The following categories are available:

- **What's New?** : Displays newly registered applications.
- **Video** : Displays various video media such as movies, TV shows, and short length videos.
- **Game** : Displays various games such as sudoku and chess.
- **Sports** : Displays various sports media services such as match information, images, and short length videos.
- **Lifestyle** : Includes various lifestyle media services such as music, personal photo management tools, and social networking such as Facebook and Twitter.
- **Information** : Includes various information services such as news, stocks, and weather.
- **Other** : Includes other miscellaneous services.

## My Account

My Account gives you access to your Samsung Apps order and download history, and to the My Apps Cash screen. You must have a Samsung account to access this information.

## Help

If you have questions about Samsung Apps, check Help first. If none of the tips apply, please visit [www.samsung.com](http://www.samsung.com).

To use the Help function, follow these steps:

1. Press the ▲▼◀▶ buttons to select Help, and then press the **ENTER** button.
2. Press the ◀▶ to enter Help after it appears.
3. Press the ▲▼ to scroll the Help text.
4. Press the ◀ to exit Help.

### Using the colored buttons on your remote with Samsung Apps

- **RED (A) (Login)** : To log into your Smart TV Account.
- **GREEN (B) (Thumbnail/List View)** : To toggle applications between Thumbnail and List view.
- **BLUE (D) (Sort By)** : To sort the applications in a category by Recommended, Most Downloaded, Most Recent, or Name.
- **Return** : To return to the previous menu.

#### NOTE

- The Internet contents services may be added or deleted by providers without notice.

For instructions to use Your Video or Search Function, please visit [www.samsung.com](http://www.samsung.com)

### BD-LIVE™

Once the product is connected to the network, you can enjoy various movie-related service contents using a BD-LIVE compliant disc.

1. Attach a USB memory stick to the USB jack on the front of the product, and then check its remaining memory. The memory device must have at least 1GB of free space to accommodate the BD-LIVE services.
2. Insert a Blu-ray disc that supports BD-LIVE.
3. Select an item from various BD-LIVE service contents provided by the disc manufacturer.

#### NOTE

- The way you use BD-LIVE and the provided contents may differ, depending on the disc manufacturer.

### Using the AllShare Function

AllShare lets you play music, video, and photo files located in your PC or your DLNA compatible mobile phone or NAS on the product.

To use AllShare with your product, you must connect the product to your network (See pages 27~28).

To use AllShare with your PC, you must install AllShare software on your PC.

If you have a DLNA compatible mobile phone or NAS, you can use AllShare without any additional software.

You can download the PC software and get detailed instructions for using AllShare from the Samsung.com web site.

## Other information

### Troubleshooting

Refer to the chart below when this product does not function properly. If the problem you are experiencing is not listed below or if the instructions below do not help, turn off the product, disconnect the power cord, and contact Samsung Electronics at 1-800-SAMSUNG (1-800-726-7864).

Symptom	Check/Remedy
I cannot eject the disc.	<ul style="list-style-type: none"> <li>Is the power cord plugged securely into the outlet?</li> <li>Turn off the power and then turn it back on.</li> </ul>
The iPod fails to connect.	<ul style="list-style-type: none"> <li>Check the condition of the iPod connector and Dock.</li> <li>Keep the iPod software version up to date.</li> </ul>
Playback does not start.	<ul style="list-style-type: none"> <li>Check the region number of the BD/DVD. BD/DVD discs purchased from abroad may not be playable.</li> <li>CD-ROMs and DVD-ROMs cannot be played on this Product.</li> <li>Make sure that the rating level is correct.</li> </ul>
Playback does not start immediately when the Play/Pause button is pressed.	<ul style="list-style-type: none"> <li>Are you using a deformed disc or a disc with scratches on the surface?</li> <li>Wipe the disc clean.</li> </ul>
Sound is not produced.	<ul style="list-style-type: none"> <li>The home theater does not play sound during fast playback, slow playback, and step motion playback.</li> <li>Are the speakers connected properly? Is the speaker setup correctly customized?</li> <li>Is the disc severely damaged?</li> </ul>
Sound can be heard only from a few speakers and not all 8.	<ul style="list-style-type: none"> <li>On certain BD/DVD discs, sound is output from the front speakers only.</li> <li>Check if the speakers are connected properly.</li> <li>Adjust the volume.</li> <li>When listening to a CD, radio or TV, sound is output to the front speakers only. Select "PRO LOGIC II" by pressing  PL II (Dolby Pro Logic II) on the remote control to use all six speakers.</li> </ul>
Dolby Digital 7.1 CH Surround Sound is not produced.	<ul style="list-style-type: none"> <li>Is there "Dolby Digital 7.1 CH" mark on the disc? Dolby Digital 7.1 CH Surround Sound is produced only if the disc is recorded with 7.1 channel sound.</li> <li>Is the audio language correctly set to Dolby Digital 7.1-CH in the information display?</li> </ul>
The remote control does not work.	<ul style="list-style-type: none"> <li>Are you operating the remote within its operational range and within the proper angle relative to the sensor?</li> <li>Are the batteries drained?</li> <li>Have you selected the mode (TV/BD) functions of the remote control (TV or BD) correctly?</li> </ul>
<ul style="list-style-type: none"> <li>Disc is rotating but no picture is produced.</li> <li>Picture quality is poor and picture is shaking.</li> </ul>	<ul style="list-style-type: none"> <li>Is the TV power on?</li> <li>Are the video cables connected properly?</li> <li>Is the disc dirty or damaged?</li> <li>A poorly manufactured disc may not be playable.</li> </ul>
Audio language and subtitles do not work.	<ul style="list-style-type: none"> <li>Audio language and subtitles will not work if the disc does not contain them.</li> </ul>
Menu screen does not appear even when the menu function is selected.	<ul style="list-style-type: none"> <li>Are you using a disc that does not contain menus?</li> </ul>



Symptom	Check/Remedy
Aspect ratio cannot be changed.	<ul style="list-style-type: none"> <li>You can play 16:9 BD/DVDs in 16:9 Wide mode, 4:3 Letter Box mode, or 4:3 Pan - Scan mode, but 4:3 BD/DVDs can be seen in 4:3 ratio only. Refer to the Blu-ray Disc jacket and then select the appropriate function.</li> </ul>
<ul style="list-style-type: none"> <li>The product is not working. (Example: The power goes out or a strange noise is heard.)</li> <li>The Product is not working normally.</li> </ul>	<ul style="list-style-type: none"> <li>Press and hold the remote control's <b>STOP</b> (■) button for 5 seconds in STANDBY mode. <ul style="list-style-type: none"> <li>Using the RESET function will erase all stored settings. Do not use this unless necessary.</li> </ul> </li> </ul>
You have forgotten the rating level password.	<ul style="list-style-type: none"> <li>With no disc in the product, press and hold the product's <b>STOP</b> (■) button for longer than 5 seconds. <b>INIT</b> appears on the display and all settings will return to the default values. And then press the <b>POWER</b> button. <ul style="list-style-type: none"> <li>Using the RESET function will erase all stored settings. Do not use this unless necessary.</li> </ul> </li> </ul>
Can't receive radio broadcasts.	<ul style="list-style-type: none"> <li>Is the antenna connected properly?</li> <li>If the antenna's input signal is weak, install an external FM antenna in an area with good reception.</li> </ul>
While listening to TV audio through the Product, no sound is heard.	<ul style="list-style-type: none"> <li>If the <b>EJECT</b> (▲) button is pressed while listening to TV audio using the D.IN or AUX functions, the BD/DVD functions are turned on and the TV audio is muted.</li> </ul>
"Not Available" appears on screen.	<ul style="list-style-type: none"> <li>The features or action cannot be completed at this time because: <ol style="list-style-type: none"> <li>The BD/DVD's software restricts it.</li> <li>The BD/DVD's software doesn't support the feature (e.g., angles)</li> <li>The feature is not available at the moment.</li> <li>You've requested a title or chapter number or search time that is out of range.</li> </ol> </li> </ul>
If the HDMI output is set to a resolution your TV cannot support (for example, 1080p), you may not see a picture on your TV.	<ul style="list-style-type: none"> <li>Press and hold the <b>STOP</b> (■) button on front panel for more than 5 seconds with no disc inserted. All settings will revert to the factory settings.</li> </ul>
No HDMI output.	<ul style="list-style-type: none"> <li>Check the connection between the TV and the HDMI jack of the Product.</li> <li>Check if your TV supports 480p/720p/1080i/1080p HDMI input resolution.</li> </ul>
Abnormal HDMI output screen.	<ul style="list-style-type: none"> <li>If random noise appears on the screen, it means that TV does not support HDCP (High-bandwidth Digital Content Protection).</li> </ul>

## Other information

Symptom	Check/Remedy
<b>PC Share Manager function</b>	
I can see folders shared through the PC Share Manager, but I cannot see the files.	<ul style="list-style-type: none"> <li>• Since it shows only files corresponding to the Image, Music, and Movie categories, files that do not correspond to these categories may not be displayed.</li> </ul>
<b>AllShare function</b>	
Video is played intermittently.	<ul style="list-style-type: none"> <li>• Check if the network is stable.</li> <li>• Check if the network cable is properly connected and if the network is not overloaded.</li> <li>• Wireless connection between the server and the product is unstable. Check the connection.</li> </ul>
AllShare connection between TV and PC is unstable.	<ul style="list-style-type: none"> <li>• IP address under the same subnetwork should be unique, otherwise IP collision can result in such a phenomenon.</li> <li>• Check if you have a firewall enabled. If so, disable the firewall function.</li> </ul>
<b>BD-LIVE</b>	
I cannot connect to the BD-LIVE server.	<ul style="list-style-type: none"> <li>• Check whether the network connection is successful or not by using Network Test menu.</li> <li>• Check whether the USB memory device is connected with product or not.</li> <li>• The memory device must have at least 1GB of free space to accommodate the BD-LIVE service. You can check the available size in BD Data Management. (See page 43)</li> <li>• Please check whether the BD-LIVE Internet Connection menu is set to Allow(All).</li> <li>• If all above fails, contact the contents provider or update the latest firmware.</li> </ul>
When using the BD-LIVE service, an error occurs.	<ul style="list-style-type: none"> <li>• The memory device must have at least 1GB of free space to accommodate the BD-LIVE service. You can check the available size in BD Data Management. (See page 43)</li> </ul>

### NOTE

- When the factory default settings are restored, all the user data stored in the BD data will be deleted.

## Repairs

If you contact us to repair your player, an administration fee may be charged if either:

1. An engineer is called out to your home at your request and there is no defect in the product.
2. You bring the unit to a repair center and there is no defect in the product.

We will provide you with the amount of the administration fee before we make a home visit or begin any work on your product.

We recommend you read this manually thoroughly, search for a solution on line at [www.samsung.com](http://www.samsung.com), or contact Samsung Customer Care at 1-800-SAMSUNG (726-7864) before seeking to repair your product.

## Index

**0~9**

2D→3D	48
3D Settings	31
3D Sound	56

**A**

Accessories	14
Ad-hoc	28
AllShare	71
Anynet+(HDMI-CEC)	43
Audio	35
Audio Language	51
Audio Return Channel	37
Audio Sync	39

**B**

Background Music	57
BD-LIVE	71
BD Data Management	43
BD Parental Rating	44
BD Wise	32
BONUSVIEW	52

**C**

Camera Angle	52
Change Password	44
Connections	19
Speaker	19
Wireless receiver module	21
TV	23
HDMI	23
FM Antenna	24
Component	25
Composite	25
Set-Top Box	26
OPTICAL	26
AUX	26
Network	27
LAN Cable	27
Wireless Network	28
Contact Samsung	47

**D**

Digital Output	37
Disc menu	48
Disc Structure	48
Display	31
DivX® Video On Demand	43
Dolby Pro Logic II Mode	56
DSP	55
DVD Parental Rating	44
Dynamic Range Control	38

**F**

Front Display	44
---------------	----

**G**

General	44
---------	----

**H**

HDMI Audio	37
HDMI Color Format	34
HDMI Deep Color	34

**I**

Initial Settings	29, 43
iPod	58
iPod Sync	56

**L**

Language	44
Light Effect	44

**M**

Mono/Stereo	58
Movie Frame (24 Fs)	34
Musical Room Calibration	36

**N**

Network Remote Control	45
Network Setup	39
Network Status	42

**P**

Picture Setting	52
Playlist	54
Popup menu	48
Progressive Mode	34

**R**

Region Code	11
Remote Control	17
Remote Control Sensor	15
Repeat	50, 54
Reset	43
Resolution	32

**S**

Search and Skip	49
Security	44
Setting the Menu	30
Setup	29
SFE	55
Slow and Step	50
Smart Hub	62
Smart Hub Screen Size	32
Software Upgrade	45
Speaker Setting	35
Still Mode	34
Subtitle Language	51
Support	45
System	43

**T**

Time Zone	43
Title Menu	49
Title List	49
TV Aspect	32
TV Screen Saver	29

**U**

USB Storage Device	57
User EQ	36

**V**

Vertical Surround	56
-------------------	----

**Z**

Zoom	57
------	----

# Other information

## Specifications

General	Power Requirements	AC 120V, 60Hz	
	Power Consumption	70 W	
	Weight	7.7 lbs	
	Dimensions	16.9 (W) x 2.3 (H) x 12.8 (D) inches	
	Operating Temperature Range	+41°F to +95°F	
	Operating Humidity Range	10 % to 75 %	
FM Tuner	Signal/noise ratio	55 dB	
	Usable sensitivity	12 dB	
	Total harmonic distortion	0.5 %	
Disc	BD (Blu-ray Disc)	Reading Speed : 9.834 m/sec	
	DVD (Digital Versatile Disc)	Reading Speed : 6.98 ~ 7.68 m/sec. Approx. Play Time (Single Sided, Single Layer Disc) : 135 min.	
	CD : 5 inches (COMPACT DISC)	Reading Speed : 4.8 ~ 5.6 m/sec. Maximum Play Time : 74 min.	
	CD : 3 1/2 inches (COMPACT DISC)	Reading Speed : 4.8 ~ 5.6 m/sec. Maximum Play Time : 20 min.	
Video Output	Composite Video	1 channel : 1.0 Vp-p (75 Ω load) Blu-ray Disc : 480i DVD : 480i	
	Component Video	Y : 1.0 Vp-p (75 Ω load) Pr : 0.70 Vp-p (75 Ω load) Pb : 0.70 Vp-p (75 Ω load) BD : 480i DVD : 480p, 480i	
Video/Audio	HDMI	1080p, 1080i, 720p, 480p PCM multichannel audio, Bitstream audio, PCM audio	
Amplifier	Front speaker output	165W x 2(3Ω)	
	Front Top speaker output	165W x 2(3Ω)	
	Center speaker output	170W(3Ω)	
	Surround speaker output	165W x 2(3Ω)	
	Subwoofer speaker output	170W(3Ω)	
	Frequency response	Analog input	20Hz~20kHz (±3dB)
		Digital input	20Hz~40kHz (±4dB)
	S/N Ratio	70dB	
	Channel separation	60dB	
Input sensitivity	(AUX)500mV		

Speaker	Speaker system	7.1ch speaker system				
		Front	Front Top	Surround	Center	Subwoofer
	Impedance	3 Ω	3 Ω	3 Ω	3 Ω	3 Ω
	Frequency range	140Hz~20kHz	140Hz~20kHz	140Hz~20kHz	140Hz~20kHz	40Hz ~ 160Hz
	Output sound pressure level	87dB/W/M	87dB/W/M	87dB/W/M	87dB/W/M	88dB/W/M
	Rated input	165W	165W	165W	170W	170W
	Maximum input	330W	330W	330W	340W	340W
	Dimensions (W x H x D)	Front/Front Top : 3.7 x 5.2 x 2.6 inches (Stand base : 11 x 9.4 inches) Surround : 3.54 x 5.57 x 2.7 inches Center : 14.17 x 2.93 x 2.7 inches Subwoofer : 7.9 x 12.35 x 13.8 inches				
	Weights	Front/Front Top : 10.4 lbs, Surround : 1.28 lbs Center : 1.26 lbs, Subwoofer : 12.6 lbs				

\*: Nominal specification

- Samsung Electronics Co., Ltd reserves the right to change the specifications without notice.
- Weight and dimensions are approximate.
- Design and specifications are subject to change without prior notice.

- Dispose unwanted electronics through an approved recycler.

To find the nearest recycling location, go to our website:

[www.samsung.com/recyclingdirect](http://www.samsung.com/recyclingdirect) Or call, (877) 278 - 0799

### SWA-5000

Power Requirements	AC 120V ~60Hz
Power Consumption	50 W
Weight	2.52 lbs
Dimensions (W x H x D)	3 x 9 x 6 inches
Operating Temperature Range	+41°F to +95°F
Operating Humidity Range	10% ~ 75%
Output	165W x 2 CH
Frequency range	20Hz~20KHz
S/N Ratio	65dB

## LIMITED WARRANTY TO ORIGINAL PURCHASER

This SAMSUNG brand product, as supplied and distributed by SAMSUNG and delivered new, in the original carton to the original consumer purchaser, is warranted by SAMSUNG against manufacturing defects in materials and workmanship for a limited warranty period of:

### **One (1) Year Parts and Labor\***

#### **(\*90 Days Parts and Labor for Commercial Use)**

This limited warranty begins on the original date of purchase, and is valid only on products purchased and used in the United States. To receive warranty service, the purchaser must contact SAMSUNG for problem determination and service procedures. Warranty service can only be performed by a SAMSUNG authorized service center. The original dated bill of sale must be presented upon request as proof of purchase to SAMSUNG or SAMSUNG's authorized service center. Transportation of the product to and from the service center is the responsibility of the purchaser.

SAMSUNG will repair or replace this product, at our option and at no charge as stipulated herein, with new or reconditioned parts or products if found to be defective during the limited warranty period specified above. All replaced parts and products become the property of SAMSUNG and must be returned to SAMSUNG. Replacement parts and products assume the remaining original warranty, or ninety (90) days, whichever is longer.

SAMSUNG's obligations with respect to software products distributed by SAMSUNG under the SAMSUNG brand name are set forth in the applicable end user license agreement. Non-SAMSUNG hardware and software products, if provided, are on an "AS IS" basis. Non-SAMSUNG manufacturers, suppliers, publishers, and service providers may provide their own warranties.

This limited warranty covers manufacturing defects in materials and workmanship encountered in normal, and except to the extent otherwise expressly provided for in this statement, noncommercial use of this product, and shall not apply to the following, including, but not limited to: damage which occurs in shipment; delivery and installation; applications and uses for which this product was not intended; altered product or serial numbers; cosmetic damage or exterior finish; accidents, abuse, neglect, fire, water, lightning or other acts of nature; use of products, equipment, systems, utilities, services, parts, supplies, accessories, applications, installations, repairs, external wiring or connectors not supplied and authorized by SAMSUNG, or which damage this product or result in service problems; incorrect electrical line voltage, fluctuations and surges; customer adjustments and failure to follow operating instructions, cleaning, maintenance and environmental instructions that are covered and prescribed in the instruction book; product removal or reinstallation; reception problems and distortion related to noise, echo, interference or other signal transmission and delivery problems. SAMSUNG does not warrant uninterrupted or error-free operation of the product.

THERE ARE NO EXPRESS WARRANTIES OTHER THAN THOSE LISTED AND DESCRIBED ABOVE, AND NO WARRANTIES WHETHER EXPRESS OR IMPLIED, INCLUDING, BUT NOT LIMITED TO, ANY IMPLIED WARRANTIES OF MERCHANTABILITY OR FITNESS FOR A PARTICULAR PURPOSE, SHALL APPLY AFTER THE EXPRESS WARRANTY PERIODS STATED ABOVE, AND NO OTHER EXPRESS WARRANTY OR GUARANTY GIVEN BY ANY PERSON, FIRM OR CORPORATION WITH RESPECT TO THIS PRODUCT SHALL BE BINDING ON SAMSUNG. SAMSUNG SHALL NOT BE LIABLE FOR LOSS OF REVENUE OR PROFITS, FAILURE TO REALIZE SAVINGS OR OTHER BENEFITS, OR ANY OTHER SPECIAL, INCIDENTAL OR CONSEQUENTIAL DAMAGES CAUSED BY THE USE, MISUSE OR INABILITY TO USE THIS PRODUCT, REGARDLESS OF THE LEGAL THEORY ON WHICH THE CLAIM IS BASED, AND EVEN IF SAMSUNG HAS BEEN ADVISED OF THE POSSIBILITY OF SUCH DAMAGES. NOR SHALL RECOVERY OF ANY KIND AGAINST SAMSUNG BE GREATER IN AMOUNT THAN THE PURCHASE PRICE OF THE PRODUCT SOLD BY SAMSUNG AND CAUSING THE ALLEGED DAMAGE. WITHOUT LIMITING THE FOREGOING, PURCHASER ASSUMES ALL RISK AND LIABILITY FOR LOSS, DAMAGE OR INJURY TO PURCHASER AND PURCHASER'S PROPERTY AND TO OTHERS AND THEIR PROPERTY ARISING OUT OF THE USE, MISUSE OR INABILITY TO USE THIS PRODUCT SOLD BY SAMSUNG NOT CAUSED DIRECTLY BY THE NEGLIGENCE OF SAMSUNG. THIS LIMITED WARRANTY SHALL NOT EXTEND TO ANYONE OTHER THAN THE ORIGINAL PURCHASER OF THIS PRODUCT, IS NONTRANSFERABLE AND STATES YOUR EXCLUSIVE REMEDY.

Some states do not allow limitations on how long an implied warranty lasts, or the exclusion or limitation of incidental or consequential damages, so the above limitations or exclusions may not apply to you. This warranty gives you specific legal rights, and you may also have other rights which vary from state to state.

To obtain warranty service, please contact SAMSUNG customer care center.

## Contact SAMSUNG WORLD WIDE

If you have any questions or comments relating to Samsung products, please contact the SAMSUNG customer care center.

Area	Contact Center ☎	Web Site
<b>■ North America</b>		
Canada	1-800-SAMSUNG (726-7864)	www.samsung.com
Mexico	01-800-SAMSUNG (726-7864)	www.samsung.com
U.S.A	1-800-SAMSUNG (726-7864)	www.samsung.com
<b>■ Latin America</b>		
Argentina	0800-333-3733	www.samsung.com
Brazil	0800-124-421 / 4004-0000	www.samsung.com
Chile	800-SAMSUNG (726-7864)	www.samsung.com
Colombia	01-8000112112	www.samsung.com
Costa Rica	0-800-507-7267	www.samsung.com
Dominica	1-800-751-2676	www.samsung.com
Ecuador	1-800-10-7267	www.samsung.com
El Salvador	800-6225	www.samsung.com
Guatemala	1-800-299-0013	www.samsung.com
Honduras	800-7919267	www.samsung.com
Jamaica	1-800-234-7267	www.samsung.com
Nicaragua	00-1800-5077267	www.samsung.com
Panama	800-7267	www.samsung.com
Peru	0-800-777-08	www.samsung.com
Puerto Rico	1-800-682-3180	www.samsung.com
Trinidad & Tobago	1-800-SAMSUNG (726-7864)	www.samsung.com
Venezuela	0-800-100-5303	www.samsung.com
<b>■ Europe</b>		
Albania	42 27 5755	-
Austria	0810 - SAMSUNG (7267864, € 0.07/min)	www.samsung.com
Belgium	02-201-24-18	www.samsung.com/ be (Dutch) www.samsung.com/ be_fr (French)
Bosnia	05 133 1999	-
Bulgaria	07001 33 11	www.samsung.com
Croatia	062 SAMSUNG (062 726 7864)	www.samsung.com
Czech	800-SAMSUNG (800-726786)	www.samsung.com
	Samsung Zrt., česká organizační složka, Oasis Florenc, Sokolovská394/17, 180 00, Praha 8	
Denmark	70 70 19 70	www.samsung.com
Finland	030 - 6227 515	www.samsung.com
France	01 48 63 00 00	www.samsung.com
Germany	01805 - SAMSUNG (726-7864 € 0,14/Min)	www.samsung.com
Hungary	06-90-SAMSUNG (726-7864)	www.samsung.com
Italia	800-SAMSUNG (726-7864)	www.samsung.com
Kosovo	+381 0113216899	-
Luxemburg	261 03 710	www.samsung.com
Macedonia	023 207 777	-
Montenegro	020 405 888	-
Netherlands	0900-SAMSUNG (0900-7267864) (€ 0,10/Min)	www.samsung.com
Norway	815-56 480	www.samsung.com
Poland	0 801 1SAMSUNG (172678) / 022-607-93-33	www.samsung.com
Portugal	80820-SAMSUNG (726-7864)	www.samsung.com
Rumania	1. 08010 SAMSUNG (72678) - doar din rețeaua Romtelecom, tarif local 2. 021.206.01.10 - din orice rețea, tarif normal	www.samsung.com

Area	Contact Center ☎	Web Site
Serbia	0700 Samsung (0700 726 7864)	www.samsung.com
Slovakia	0800-SAMSUNG (726-7864)	www.samsung.com
Spain	902-1-SAMSUNG (902 172 678)	www.samsung.com
Sweden	0771 726 7864 (SAMSUNG)	www.samsung.com
Switzerland	0848-SAMSUNG (7267864, CHF 0.08/min)	www.samsung.com/ch www.samsung.com/ ch_fr(French)
U.K	0330 SAMSUNG (7267864)	www.samsung.com
Eire	0818 717100	www.samsung.com
Lithuania	8-800-77777	www.samsung.com
Latvia	8000-7267	www.samsung.com
Estonia	800-7267	www.samsung.com
<b>■ CIS</b>		
Russia	8-800-555-55-55	www.samsung.com
Georgia	8-800-555-555	-
Armenia	0-800-05-555	-
Azerbaijan	088-55-55-555	-
Kazakhstan	8-10-800-500-55-500 (GSM: 7799)	www.samsung.com
Uzbekistan	8-10-800-500-55-500	www.samsung.com
Kyrgyzstan	00-800-500-55-500	www.samsung.com
Tadjikistan	8-10-800-500-55-500	www.samsung.com
Ukraine	0-800-502-000	www.samsung.ua www.samsung.com/ ua_ru
Belarus	810-800-500-55-500	-
Moldova	00-800-500-55-500	-
<b>■ Asia Pacific</b>		
Australia	1300 362 603	www.samsung.com
New Zealand	0800 SAMSUNG (0800 726 786)	www.samsung.com
China	400-810-5858 / 010-6475 1880	www.samsung.com
Hong Kong	(852) 3698 4698	www.samsung.com/hk www.samsung.com/ hk_en/
India	3030 8282 / 1800 110011 / 1800 3000 8282 / 1800 266 8282	www.samsung.com
Indonesia	0800-112-8888 / 021-5699-7777	www.samsung.com
Japan	0120-327-527	www.samsung.com
Malaysia	1800-88-9999	www.samsung.com
Philippines	1-800-10-SAMSUNG(726-7864) / 1-800-3-SAMSUNG(726-7864) / 1-800-8-SAMSUNG(726-7864) / 02-5805777	www.samsung.com
Singapore	1800-SAMSUNG (726-7864)	www.samsung.com
Thailand	1800-29-3232 / 02-689-3232	www.samsung.com
Taiwan	0800-329-999	www.samsung.com
Vietnam	1 800 588 889	www.samsung.com
<b>■ Middle East</b>		
Bahrain	8000-4726	www.samsung.com
Egypt	08000-726786	www.samsung.com
Jordan	800-22273	www.samsung.com
Morocco	080 100 2255	www.samsung.com
Oman	800-SAMSUNG (726-7864)	www.samsung.com
Saudi Arabia	9200-21230	www.samsung.com
Turkey	444 77 11	www.samsung.com
U.A.E	800-SAMSUNG (726-7864)	www.samsung.com
<b>■ Africa</b>		
Nigeria	0800-SAMSUNG (726-7864)	www.samsung.com
South Africa	0860-SAMSUNG (726-7864)	www.samsung.com



QUESTIONS OR COMMENTS?

COUNTRY	CALL	OR VISIT US ONLINE AT	WRITE
IN THE US	1-800-SAMSUNG (7267864)	<a href="http://www.samsung.com/us">www.samsung.com/us</a>	Samsung Electronics America, Inc. 85 Challenger Road Ridgefield Park, NJ 07660-2112

Code No. AH68-02336R



## Free Manuals Download Website

<http://myh66.com>

<http://usermanuals.us>

<http://www.somanuals.com>

<http://www.4manuals.cc>

<http://www.manual-lib.com>

<http://www.404manual.com>

<http://www.luxmanual.com>

<http://aubethermostatmanual.com>

Golf course search by state

<http://golfingnear.com>

Email search by domain

<http://emailbydomain.com>

Auto manuals search

<http://auto.somanuals.com>

TV manuals search

<http://tv.somanuals.com>