



DIGITAL HOME THEATER SYSTEM

HT-DL200

THIS APPLIANCE IS MANUFACTURED BY:



Instruction Manual

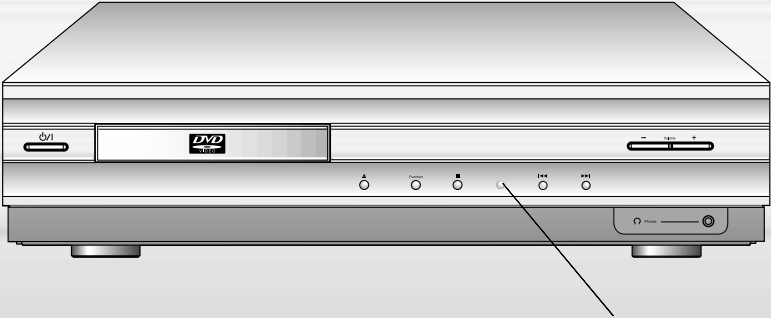

AH68-01006B



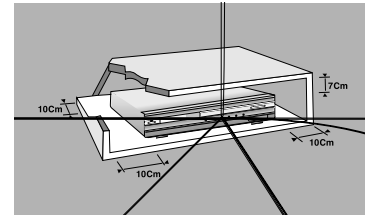

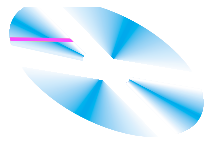

Description

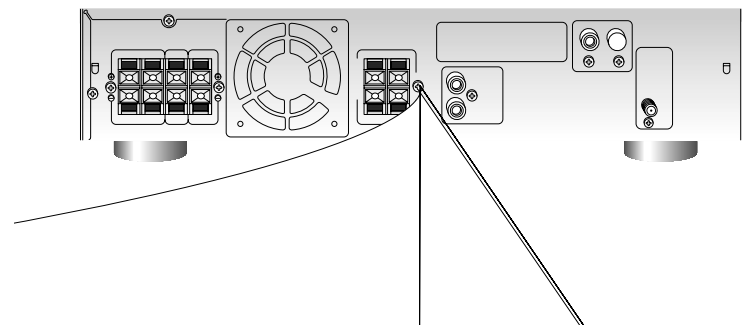
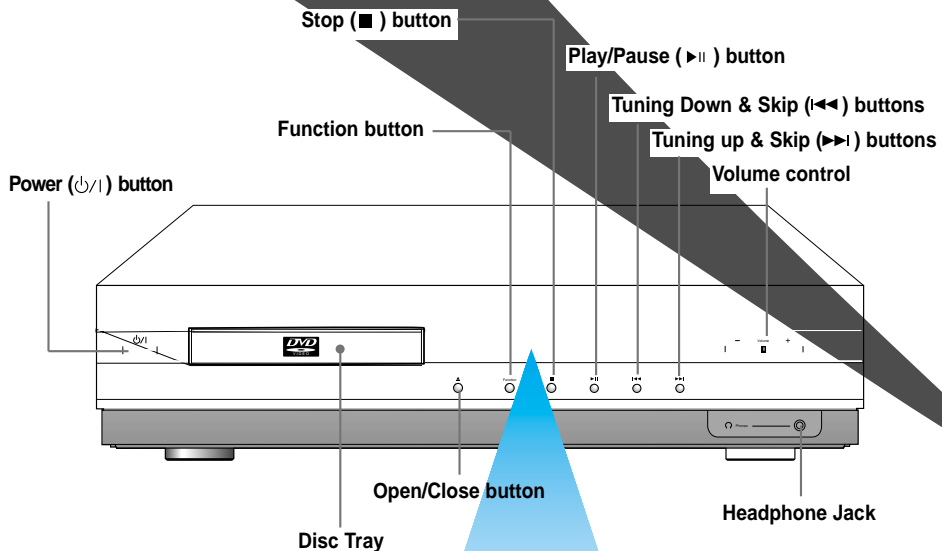

Display

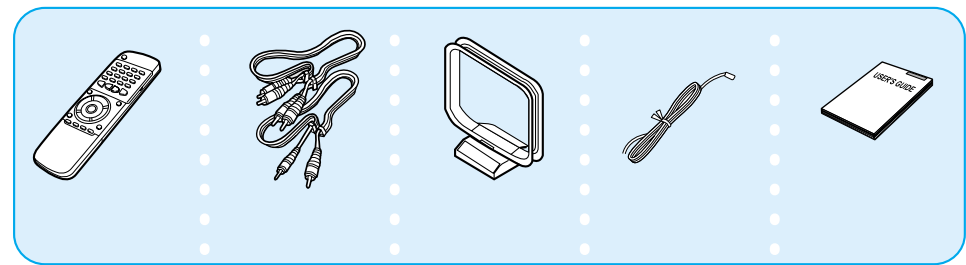
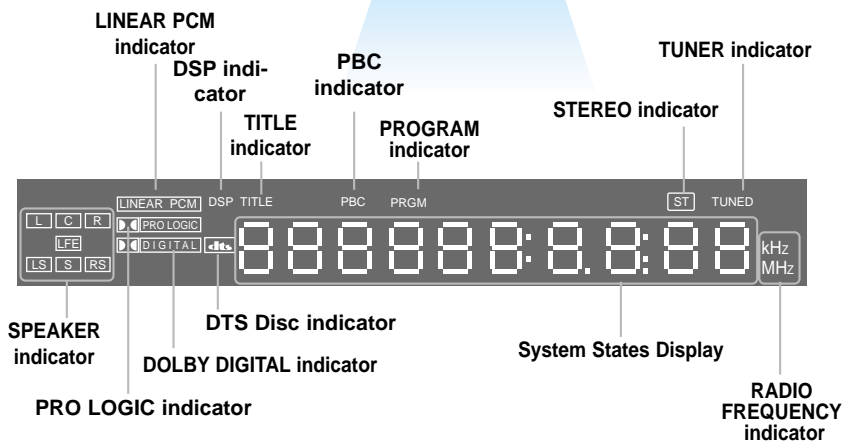

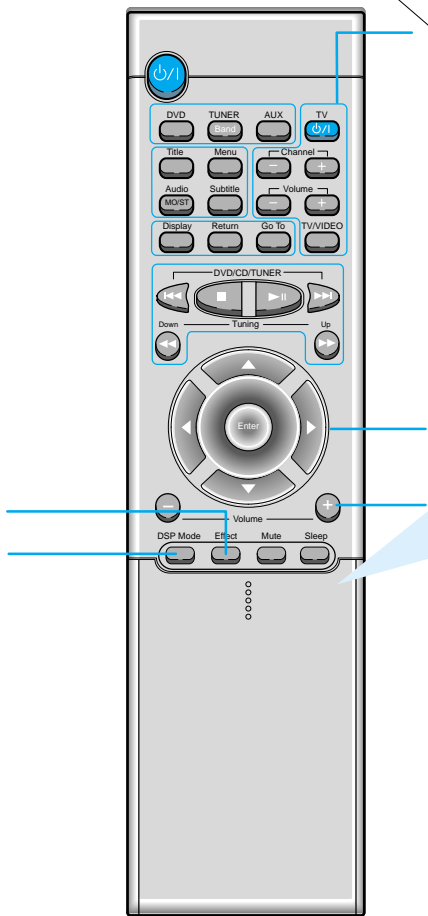

Connecting the Speakers



- Connect the satellite speakers, center speaker, and subwoofer to the terminals on the rear panel using speaker cords supplied.
- Connect the white cord to the red (+) terminal, and the black cord to the black (-) terminal respectively.

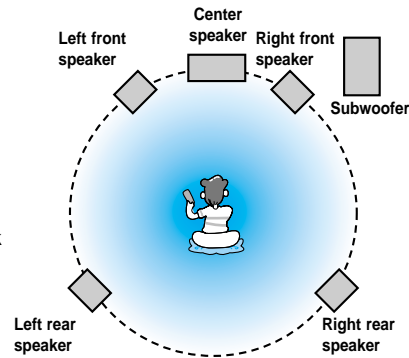

- 1** Press and hold the terminal tab.
- 2** Insert the speaker cord.
- 3** Release the finger.

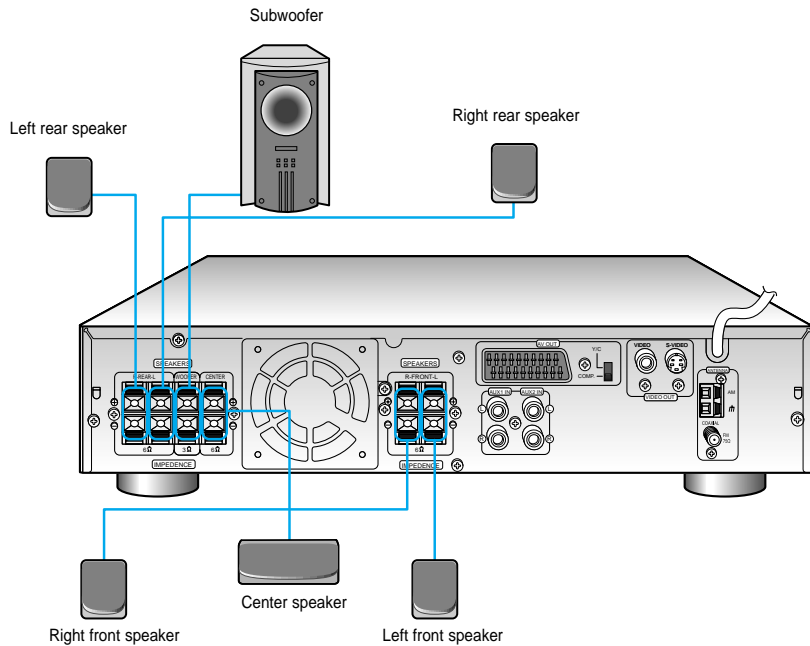
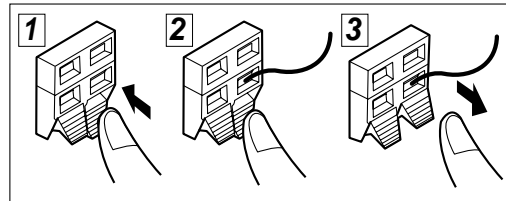

Connect Video to TV

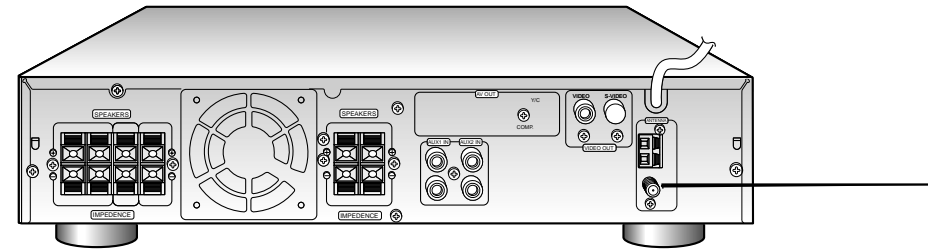

Composite Video (Good Quality)

Connect the supplied video cable from the VIDEO OUT jack on the back panel of the system to the VIDEO IN jack on your television.

S-Video (Better Quality)

If your television is equipped with an S-Video input, connect an S-Video cable (not supplied) from the S-VIDEO OUT jack on the back panel of the system to the S-VIDEO IN jack on your television.

Scart (Best Quality)

If your television is equipped with an SCART input, connect an Scart Jack (not supplied) from the AV OUT jack on the back panel of the system to the SCART IN jack on your television.



• for in-depth information about adjusting the delay time, see "Speaker Settings" on pages 30.



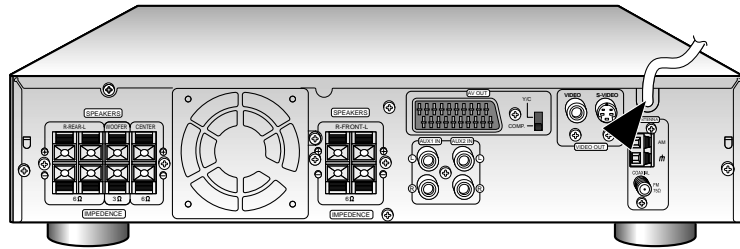

- The **"WAIT"** message that appears on the display for about seven to eight seconds when turning on the power or selecting a DVD function indicates a stabilization period for optimizing the condition of your DVD player. While the message is being displayed, other buttons remain inactive.
- When the power is not turned on, press down the Stop () button on the main unit for over 5 seconds.
The inside of the product will be initialized to its optimum state.
- If your TV model is not SAMSUNG, refer to "Remote Control Unit Setup" on page 28.

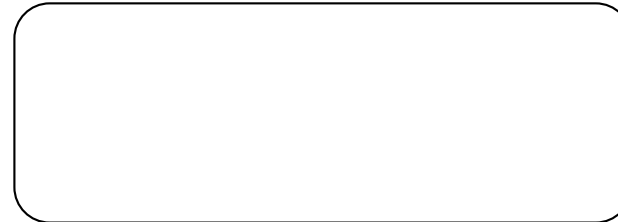

DVD Playback



Pausing Playback



Press the Play/Pause () button during playback.

- To resume, press the Play/Pause () button again.
- Depending on the disc, the initial disc information screen may look disc to disc.
- When playing a DVD containing MPEG format, video may not be reproduced correctly and you may get picture

Stopping Playback



Press the Stop () button during playback.

- During playback, when the Stop () button is pressed, the position is stored in the memory, and STOP is shown on the display. When the Play/Pause () button or Return button is pressed subsequently, playback resumes from the position at which it was stopped.
- If the Stop () button is pressed a second time, the resume play' memory function is canceled, and STOP is shown on the display. When the Play/Pause () button is pressed, playback starts from the beginning.

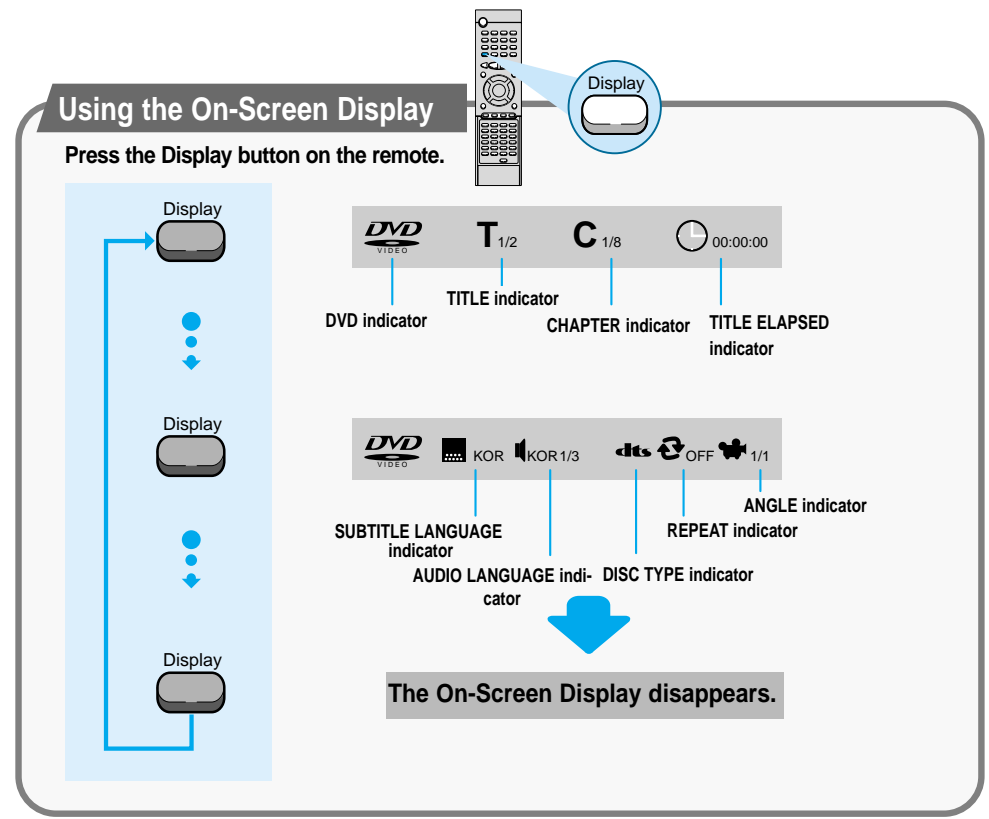

What is a Title?

What is a Chapter?

Turning the sound off temporarily?

If the player is left for more than 3 minutes in pause mode, it will stop.

Forward/Reverse Searching

High-Speed Playback

Each time the button is pressed

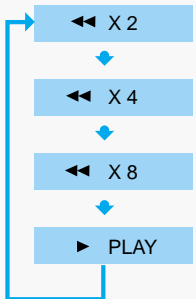

Each time the button is pressed



- playback (reverse playback) is possible on DVDs.

Skipping through a Chapter

- Each time the button is pressed during playback, it moves to the next or previous chapter and plays it.
- However, you cannot skip forward or backward through consecutive the chapters.

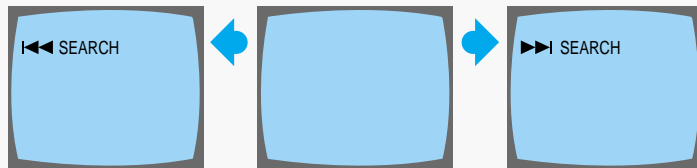

Playing Frame by Frame

Step

- The picture moves forward one frame each time the button is pressed.

Slow Playback/Checking the Remaining Time

Playing Slowly

Each time the Slow button is pressed



The slow playback speed changes and the selections (1/2X, 1/4X, 1/8X, 1/16X and normal play) are repeated.

Checking the Remaining Time

- For checking check the total time and the remaining time of a title or chapter being played.

Each time the Remain button is pressed

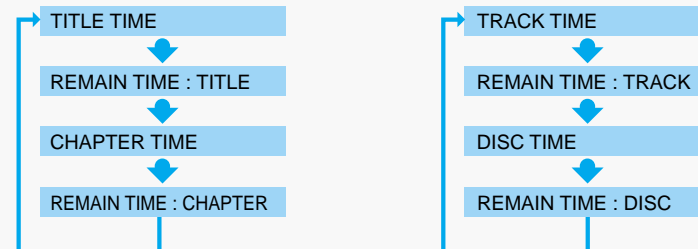



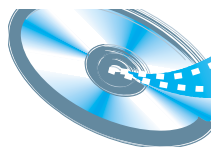

Program Playback

Use this function with video and music CDs to play the tracks in a particular order.

To Program Tracks in a particular order



DVD

1

Press the **Program** button.

2

Press the **Enter** button then use the **Number** buttons to select the desired title.

3

Press the **Enter** button, then use the **Number** buttons to select the desired chapter.

- You can use also just the **Left/Right** (◀/▶ / ▲/▼) button.
- You can use also just the **Left/Right** (◀/▶ / ▲/▼) button.

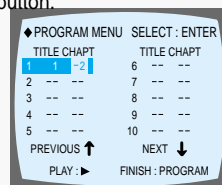
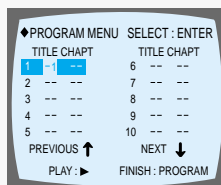
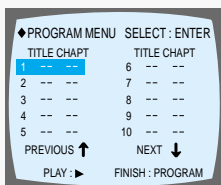

4

Press the **Enter** button.

5

At this time, you can continue programming if you want to.

- The selected track number is programming and the cursor moves to the next number.
- When programming more than 10 tracks, select **NEXT**↓ and then press the **Enter** button. The program selection screen where you can program up to 10 additional tracks appears.

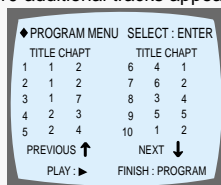
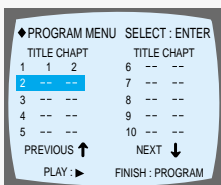

To Playback the Tracks in the Programmed Order



Press the **Play/Pause** (▶||) button.

To Change the Program

DVD

1

Press the **Up/Down** (▲/▼) button to select the track number to be changed.

2

Press the **Enter** button to select the title or chapter to be changed.

3

Press the **Clear** button and then press the **Number** buttons.

- The cursor moves to the next number when the **Enter** button is pressed again.
- You can use also just the **Left/Right** (◀/▶) button.

4

Press the **Enter** button.

5

Repeat steps 1-4 above to change the program.

- The cursor moves to the number below.

To delete the entire Program

- Press the **Stop** (■) button twice during playback.
- Press the **Stop** (■) button once when in the Stop mode.
- Press the **Open/Close** (▲) button on the main unit. The disc tray will open and then close. The program will then be deleted.

When you have entered a wrong number

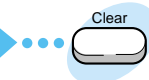

You can program or change particular tracks for VCD or CD discs in the same manner.

Press the **Clear** button.

- When you want to delete a selection during programming, select the track (or chapter, or title) to be deleted and then press the **Clear** button.

To Cancel the Programming

Press either the **Program** button or **Stop** (■) button.

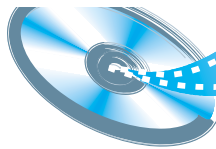

Various DVD Functions



To enlarge an image

DVD VCD

- Images can be enlarged 2x and 4x.
- During DVD playback, press the ZOOM button to zoom in 2X/4X/normal, in that order.
- Press / / ▲ / ▼ to move the enlarged portion you want to watch.

Note • Depending on the disc, DTS or DIGITAL PRO LOGIC can be selected.

Selecting the desired Screen Angle

DVD

- This function only works with discs on which multiple angles have been recorded.
- During playback, press the **Angle** button to select the desired angle in 1/3, 2/3, 3/3, normal, in that order.

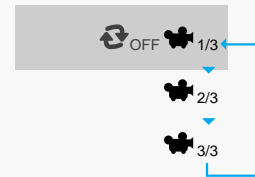

TV SCREEN(TV SCREEN RATIO)

Select when you want to watch a 16:9 screen ratio DVD movie on a TV with a 4:3 ratio screen.

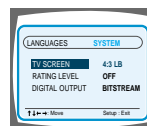

4:3LB You can see the full 16:9 picture, but black bars will appear at the top and bottom of the screen.

4:3PS You can only view the central portion of the 16:9 screen.

16:9 You can view in wide screen but the top and bottom of the picture will be cut off.

- However if the movie is recorded in 4:3 ratio, you cannot view the full 16:9 picture with the above functions.

The Rating Level function works in conjunction with DVDs which have been assigned a rating, to help control the type of DVD that your family watches.

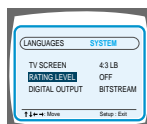

1. Select RATING LEVEL, then press the Enter button.

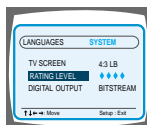

2. Use the number(0-9) buttons to input a 4-digit password.

- The player's password is set to "7890" by default.

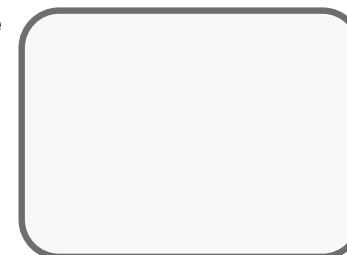
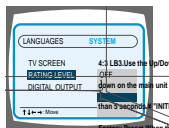

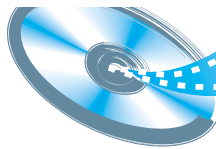

Controlling a TV with the Remote

The remote can also be set up to control most TVs. To program the remote, use the code that corresponds to your brand.

- 1** Turn on the TV.
- 2** Point the DVD's remote at the TV.



Code	Brand	Code	Brand
01	SAMSUNG 1	16	SHARP 3
02	SHARP 2	17	ZENITH
03	SONY	18	LG 3
04	MAGNAVOX	19	DAEWOO 8
05	SANYO 1	20	SANYO 2
06	LG 2	21	EMERSON
07	RCA	22	SHARP 3
08	LG 1	23	SAMSUNG 4
09	TOSHIBA	24	MATSUSHITA
10	HITACHI	25	NOBLEX
11	JVC	26	TELEFUNKEN
12	PANASONIC 1	27	NEWSAN
13	MITSUBISHI 2	28	LOEWE
14	SAMSUNG 2	29	RCA2
15	SAMSUNG 3		

Speaker Setup

Setting up Speaker Mode and Delay Time

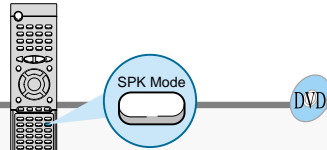

1

Press the SPK Mode button.

2

Press the Left/Right (◀ / ▶) button to select the desired item.

- Each time the button is pressed, a different mode selection is displayed on the front panel display as shown below.

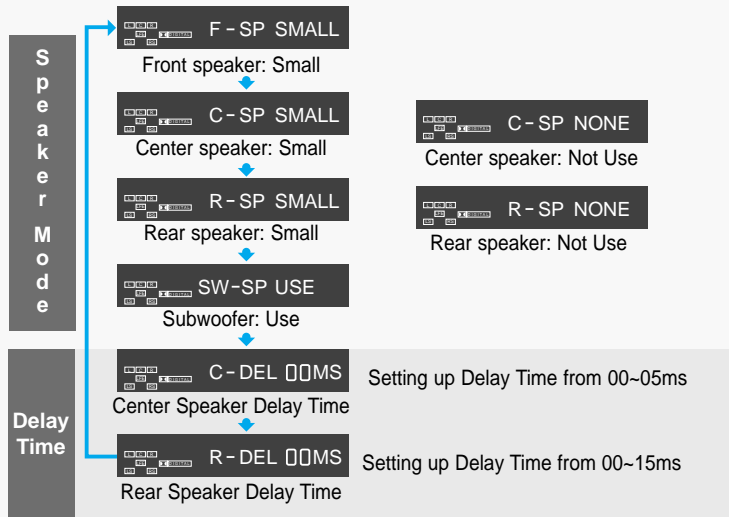

- SMALL: When this setting is selected, low frequencies of below 200 Hz are assigned to the subwoofer only.
- USE: Select when using speakers.
- NONE: Select this when no speakers are installed.

To set the delay time

- When 5.1 Channel Surround Sound is played, you can enjoy the best sound if the distance between you and each speaker is the same. You can set Delay Time in the Center/Rear Speaker to customize the sound to the acoustics of your room.
- Setting Center Speaker**
If the distance of Dc is equal to or longer than the distance of Df in the figure, set the mode as 0ms. Otherwise, change the setting according to the table on the table.
- Setting Rear Speakers**
If the distance of Df is equal to the distance of Ds in the figure, set the mode as 0ms. Otherwise, change the setting according to the table.

(A)=Df-Dc

Distance of (A)	Value(ms)
50	1.3
100	2.6
400	3.9
200	5.3

(B)=Df-Ds

Distance of (B)	Value(ms)
200	5.3
400	10.6
600	15.9

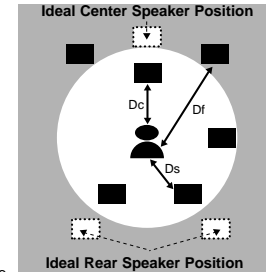

Dc: Distance from center speaker to listening position
Df: Distance from front speakers to listening position
Ds: Distance from rear speakers to listening position

Arrange all speakers within a circle as shown in the figure.

Speaker Setting Methods

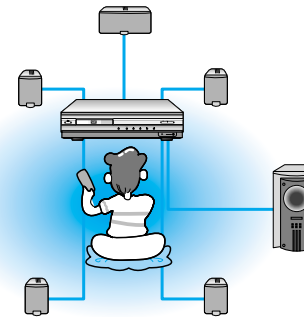

Front Speakers

Set the front speakers so that their tweeters (high-range) are aligned at about ear level and at a horizontal angle of 45° to the prime listening position.

Center Speaker

Ideally the center speaker should be positioned with its top surface flush with the front speakers. However, you may place the speaker either on top or near the bottom of your TV set.

Rear Speakers

Set the rear speakers further back parallel to the walls, at 60 to 90 centimeters (2 to 3 feet) above prime listening position ear level.

If the space behind the listening position is insufficient (i.e., too close to the wall), place the rear speakers facing each other on either side.

Subwoofer Speaker

Place the subwoofer at any convenient location within the vicinity of the listening position.

Note

The display changes depending on the current audio output mode (DSP, PRO LOGIC, 3-STEREO, STEREO, etc.).



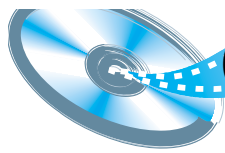

Creating Realistic Sound Fields



You can use the following surround to reproduce a realistic sound field.

- Digital Multichannel Surround —Dolby Digital and DTS Digital Surround
- Dolby Surround



Dolby Digital and DTS Digital Surround

To enjoy surround effectively,all the speakers need to be connected and activated.

Dolby Digital

Used to reproduce multichannel sound tracks of the software encoded with Dolby Digital ().

Dolby Digital encoding method (so-called discrete 5.1 channel digital audio format)records and digitally compresses the left front channel,right front channel,center channel,left rear channel,right rear channel,and LFE channel signals (total 6 channels,but LFE channel is counted as 0.1 channel.Therefore,called 5.1 channel).

Since each channel is completely independent from the other channel signals much better sound quality with much stereo and surround effects.

In addition,Dolby Digital enables stereo rear sounds,and sets the cutoff frequency to 7 kHz for Dolby Pro Logic.These facts enhance the sound movement and bring you a realistic stereo effect.

When the system detects Dolby Digital signals,the DOLBY DIGITAL indicator lights up on the front panel.

DTS Digital Surround

Used to reproduce multichannel sound tracks of the software encoded with DTS Digital Surround.

DTS Digital Surround is another discrete 5.1 channel digital audio format available. Compared to Dolby Digital, audio compression rate is relatively low. This fact allows DTS Digital Surround format to add breadth and depth to the sound. DTS Digital Surround features natural,solid and clear sound.

When the system detects DTS Digital Surround signals,the DTS indicator lights up on the front panel.

Dolby Surround

Used to reproduce sound tracks of the VCR tapes encoded with Dolby Surround. This is only used for the sound sources coming through the AUX IN jacks.

Dolby Pro Logic and Dolby 3 Stereo

Dolby Surround encoding format records the left front channel, right front channel and center channel signals (total 4 channels)into 2 channels.

The **Dolby Pro Logic** decoder built in this system decodes these 2 channel signals into a matrix-based multichannel reproduction,and allows you to enjoy a realistic stereo effect.

When one of Dolby Surround is selected,the PRO LOGIC indicator lights up on the front panel.

Manufactured under license from Dolby Laboratories. "Dolby," "Pro Logic," and the double-D symbol are trademarks of Dolby Laboratories. Confidential Unpublished Works. ©1992-1997 Dolby Laboratories, Inc. All rights reserved.

Manufactured under license from Dolby Laboratories. US Pat. No. 5,411,000 and pending. "Dolby" and "Dolby Digital" are trademarks of Dolby Laboratories. "Dolby Digital Theater System" is a trademark of Dolby Laboratories.

What is a Effect?
This sets the strength of the DSP mode.

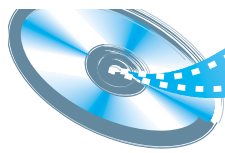

Listening to the Radio



When the _____ button is pressed, a preset broadcast station is selected.

Hold in the _____ button. Automatic searching begins, and then stops when a station is tuned in.

Press the _____ button to tune to the chosen station. The frequency changes incrementally in either direction each time the corresponding button is pressed.

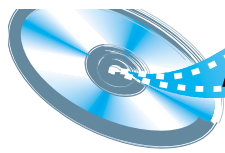

About RDS broadcasting

Using the RDS (Radio Data System) to receive FM stations

RDS allows FM stations to send an additional signal along with their regular program signals. For example, the stations send their station names, as well as information about what type of program they broadcast, such as sports or music, etc.

When tuned to an FM station which provides the RDS service, the RDS indicator lights up on the display.

- Description on RDS function
 1. **PTY (Program Type)** : Displays the type of programme currently being broadcast
 2. **PS NAME (Program Service Name)** : Indicates the name of broadcasting station and is composed of 8 characters.
 3. **RT (Radio Text)** : Decodes the text broadcast by a station (if any) and is composed of maximum 64 characters.
 4. **CT (Clock Time)** : Decodes the real time clock from the FM frequency.
 - Some stations may not transmit PTY, RT or CT information therefore this may not be displayed in all cases.
 5. **TA (Traffic Announcement)** : When this symbol flashes it shows that the traffic announcement is in progress.

- Note**
- RDS is not available for MW/LW broadcasts.
 - RDS may not operate correctly if the station tuned is not transmitting RDS signal properly or if the signal strength is weak.

What information can RDS signals provide?

You can see the RDS signals the station sends on the display.

TO show the RDS signals

Press RDS DISPLAY while listening to an FM station.

Each time you press the button, the display change to show you the following information:

→ PS NAME → PTY → RT → CT → Frequency

PS (Program Service) : While searching, "PS" appears and then the station names will be displayed. "NO PS" appears if no signal is sent.

PTY (Program Type) : while searching, "PTY" appears and then the type of the broadcast program will be displayed. "NO PTY" appears if no signal is sent.

RT (Radio Text) : while searching, "RT" appears and then text messages the station sends will be displayed. "NO RT" appears if no signal is sent.

Frequency : station frequency (non-RDS service)

About characters shown in the display

When the display shows PS, PTY, or RT signals, the following characters are used.

- The display window cannot differentiate upper case and lower case letters and always uses upper case letters.
- The display window cannot show accented letters, "A," for instance, may stand for accented "A's" like "Å, Ä, Å, Ä, and Å."

Note If searching finishes at once, "PS", "PTY", and "RT" will not appear on the display.

PTY (Program Type) indication and PTY-SEARCH function

One of the advantages of the RDS service is that you can locate a particular kind of program from the preset channels by specifying the PTY codes.

To search for a program using the PTY codes

Before you start, remember...

- The PTY Search is only applicable to preset stations.
- To stop searching any time during the process, press PTY SEARCH while searching.
- There is a time limit in doing the following steps. If the setting is cancelled before you finish, start from step 1 again.
- When pressing the buttons on the primary remote control, make sure that you have selected the FM station using the primary remote control.

1 Press PTY SEARCH while listening to an FM station.

2 Press and hold PTY- or PTY+ until the PTY code you want appears on the display window, while "PTY SELECT" is flashing.

- The display gives you the PTY codes described to the right.

3 Press PTY SEARCH again, while the PTY code selected in the previous step is still on the display.

- The center unit searches 15 preset FM stations, stops when it finds the one you have selected, and tunes in that station.

Display	Program Type
NEWS	• News including an announced opinion and report
AFFAIRS	• Several matters including a current incident, documentary, discussion and analysis.
INFO	• Information including weights and measures, returns and forecast, matters interesting the customer, medical information, etc.
SPORT	• Sports
EDUCATE	• Education
DRAMA	• Drama-Radio serial, etc.
CULTURE	• Culture-National or local culture including the religious problem, social science, language, theater, etc.
SCIENCE	• Natural science and technology
VARIED	• Others-Speech, amusing program (quiz, game), interview, comedy and satirical play, etc.
POP M	• Pop music
ROCK M	• Rock music
LIGHT M	• Light classical music- Classical music and instrumental and chorus music
CLASSIC	• Heavy classical music-Orchestra music, symphony, chamber music and opera
OTHER M	• Other music - Jazz, R&B country music
WEATHER	• Weather
FINANCE	• Finance
CHILDREN	• Children's programmes
SOCIAL A	• Social affairs
RELIGION	• Religion
PHONE IN	• Phone in
TRAVEL	• Travel
LEISURE	• Leisure
JAZZ	• Jazz Music
COUNTRY	• Country Music
NATIONAL M	• National Music
OLDIES	• Oldies Music
FOLK M	• Folk Music
DOCUMENT	• Documentary

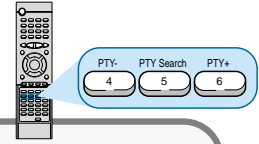

Sleep Function



To set up Sleep

Press the Sleep button.

- Each time the button is pressed the selection toggles as follows: SLEEP 10 → SLEEP 20 → SLEEP 30 → SLEEP 60 → SLEEP 90 → SLEEP 120 → SLEEP 150 → OFF.

To Review Sleep Setting

- The remaining time for the selected Sleep time is displayed.
- Pressing the button once again changes the Sleep time from the last setting.

What is the Sleep function?
You can set the delay time so that the unit powers off automatically after a preset period of time.

Troubleshooting

Problem	Check
The disc tray does not open.	<ul style="list-style-type: none"> • Is the disc installed with the label side facing up? • Is the power cord plugged securely into the power outlet? • Turn off the power to the unit by pressing the Power (⏻) button and turn it back on.
Disc does not play.	<ul style="list-style-type: none"> • Check the region number of the DVD. • DVD discs purchased abroad may not be playable. • This player cannot play CD-ROMs, DVD-ROMs, etc. • Check the rating level of the DVD.
Playback does not start immediately when the Play/Pause button is pressed.	<ul style="list-style-type: none"> • Check whether the disc has any scratch marks or is deformed?
No sound is produced.	<ul style="list-style-type: none"> • No sound is heard during high-speed playback, slow playback, and step motion playback modes. • Are the speakers properly connected? Is the speaker Setup correctly customized? • Is the disc severely damaged? The disc may be dirty. Wipe off fingerprints or dirt.
Sound can be heard only from a few speakers and not all six.	<ul style="list-style-type: none"> • When listening to a CD or radio, sound is output to the front speakers only (L/R). Select the "PRO LOGIC" option by pressing the Pro Logic button on the remote control unit to use all six speakers. • Check whether your DVD disc is 5.1 CH compatible.
Picture does not appear; sound is not produced; the disc tray opens 2-5 seconds later.	<ul style="list-style-type: none"> • Was the player moved suddenly from a cold place to a warm one? When condensation forms inside the player, remove the disc and let the player stand for 1 or 2 hours with the power on. (You can use the player after the condensation disappears.)
Sound quality is irregular.	<ul style="list-style-type: none"> • Are the speaker cables loose? • Is there any dirt or debris at the end of the speaker connector?
Dolby Digital 5.1 Channel Surround Sound is not being reproduced.	<ul style="list-style-type: none"> • Does the disc being played show the "Dolby Digital 5.1CH" mark? 5.1-channel sound is reproduced only if the disc is recorded with 5.1 channel sound. • Is the DVD player connected to the proper speakers?

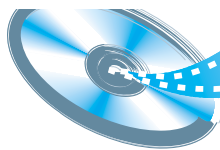

Cautions on Handling and Storing Discs

Small scratches on the disc may reduce sound and picture quality or cause breaks in playback. Be especially careful not to scratch discs when handling them.



Handling and Storing Discs



When you get fingerprints or dirt on the disc, clean it with a mild detergent diluted in water and wipe with a soft cloth.

- When cleaning, wipe gently from the inside to the outside of the disc.

Disc Storage

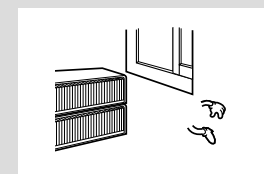
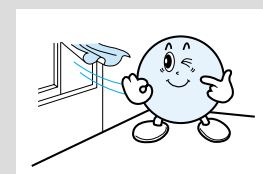
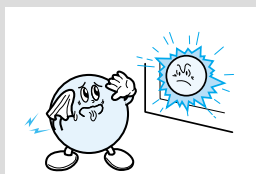







Specification





Note on Terminology

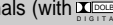

ANGLE	Recorded onto some DVD discs are scenes which have been simultaneously shot from a number of different angles (the same scene is shot from the front, from the left, from the right, etc.). With such discs, the Angle button can be used to change the angle of view for specific scenes.
CHAPTER NUMBER	These numbers are recorded on DVD discs. A Title is subdivided into many sections, each of which is numbered, and specific parts of the video can be searched quickly using these numbers.
DVD	A high-density optical disc on which high-quality pictures and sound have been recorded by means of digital signals. Incorporating a new video compression technology (MPEG-2) and high-density recording technology, a DVD disc comprises two 0.6 mm thick discs bonded together.
PCM	An acronym for Pulse Code Modulation - another name for digital audio.
PBC (PLAYBACK CONTROL)	This is recorded on a video CD (version 2.0). Selected scenes or information can be chosen from the menu displayed on the TV monitor.
REGION NUMBER	Both the DVD player and DVD discs are encoded with a region number. If the region number on the DVD disc does not correspond to the region number of the DVD player, the player cannot play the disc.
SUBTITLES	Translated appearing at the bottom of the screen. A DVD disc can contain up to 32 subtitle languages.
TITLE NUMBER	These numbers are recorded on DVD discs. When a disc contains two or more movies, these movies are numbered as Title 1, Title 2, etc.
TRACK NUMBER	These numbers are assigned to the tracks which are recorded on video and audio CDs. They enable specific tracks to be located quickly.
VIDEO CD	Contains recordings of pictures and sound whose quality is roughly comparable to that of video tape. This player also supports video CDs with playback control (version 2.0).
	You can enjoy 5.1 (or 6) channels of high fidelity digital sound from various digital input sources such as laser discs, DVD, CD etc. DTS provides a realistic, clear surround sound that has not previously been available from conventional surround sound.
	5.1 (or 6) Channel Digital Surround sound reproduced from DVDs and LDs recorded as a digital signals (with  disc marking). With better sound quality, dynamic range, and directionality than the traditional Dolby surround technology, you can enjoy the dynamic realistic sound.
	A 4 channel analog sound reproduced from a program source such as a video-tape or LD with the  mark. You can enjoy a more realistic, robust sound unavailable from regular stereo sources.

Free Manuals Download Website

<http://myh66.com>

<http://usermanuals.us>

<http://www.somanuals.com>

<http://www.4manuals.cc>

<http://www.manual-lib.com>

<http://www.404manual.com>

<http://www.luxmanual.com>

<http://aubethermostatmanual.com>

Golf course search by state

<http://golfingnear.com>

Email search by domain

<http://emailbydomain.com>

Auto manuals search

<http://auto.somanuals.com>

TV manuals search

<http://tv.somanuals.com>