

7.1CH Blu-ray™
Home Entertainment System
user manual

imagine the possibilities



Thank you for purchasing this Samsung product.
To receive more complete service,
please register your product at
www.samsung.com/register



Safety Information

Warning

TO REDUCE THE RISK OF ELECTRIC SHOCK, DO NOT REMOVE THE COVER (OR BACK). NO USER-SERVICEABLE PARTS ARE INSIDE. REFER SERVICING TO QUALIFIED SERVICE PERSONNEL.

	<div style="border: 1px solid black; padding: 5px; text-align: center;"> CAUTION <small>RISK OF ELECTRIC SHOCK DO NOT OPEN</small> </div>	
<p>The lightning flash and arrowhead within the triangle are warning signs alerting you to dangerous voltage inside the product.</p>	<p>CAUTION: TO REDUCE THE RISK OF ELECTRIC SHOCK, DO NOT REMOVE THE COVER (OR BACK). NO USER SERVICEABLE PARTS INSIDE. REFER SERVICING TO QUALIFIED SERVICE PERSONNEL.</p>	<p>The exclamation point within the triangle is a warning sign alerting you to important instructions accompanying the product.</p>

WARNING

- To reduce the risk of fire or electric shock, do not expose this appliance to rain or moisture.
- To turn this apparatus off completely, you must pull the power plug out of the wall socket. Consequently, the power plug must be easily and readily accessible at all times.
- Do not expose this apparatus to dripping or splashing. Do not put objects filled with liquids, such as vases on the apparatus.

FCC NOTES (for U.S.A)

This equipment has been tested and found to comply with the limits for a Class B digital device, pursuant to Part 15 of the FCC rules. These limits are designed to provide reasonable protection against harmful interference in a residential installation. This equipment generates, uses and can radiate radio frequency energy and, if not installed and used in accordance with the instructions, may cause harmful interference to radio or television reception, which can be determined by turning the equipment off and on.

If interference is present, the user is encouraged to try to correct the interference by one or more of the following measures:

- Reorient or relocate the receiving antenna.
- Increase the separation between the equipment and receiver.
- Connect this equipment to an outlet on a circuit that the receiver is not connected to.
- Consult the dealer or an experienced radio/TV technician for help.

This class B digital product meets all requirements of the Canadian Interference - Causing Equipment Regulations.

CLASS 1 LASER PRODUCT

This Compact Disc player is classified as a CLASS 1 LASER product. Use of controls, adjustments or performance of procedures other than those specified herein may result in hazardous radiation exposure.

Complies with 21CFR 1040.10 except for deviations pursuant to Laser Notice No. 50, dated June 24, 2007.

DANGER :

- VISIBLE AND INVISIBLE LASER RADIATION WHEN OPEN. AVOID DIRECT EXPOSURE TO BEAM. (FDA 21 CFR)

CAUTION :

- CLASS 3B VISIBLE AND INVISIBLE LASER RADIATION WHEN OPEN. AVOID EXPOSURE TO THE BEAM (IEC 60825-1)
- THIS PRODUCT UTILIZES A LASER. USE OF CONTROLS OR ADJUSTMENTS OR PERFORMANCE OF PROCEDURES OTHER THAN THOSE SPECIFIED HEREIN MAY RESULT IN HAZARDOUS RADIATION EXPOSURE. DO NOT OPEN COVER AND DO NOT REPAIR YOURSELF. REFER SERVICING TO QUALIFIED PERSONNEL.

CLASS 1	LASER PRODUCT
KLASSE 1	LASER PRODUKT
LUOKAN 1	LASER LAITE
KLASS 1	LASER APPARAT
PRODUCTO	LÄSER CLASE 1

Precautions

Important Safety Instructions

Read these operating instructions carefully before using the unit. Follow all the safety instructions listed below. Keep these operating instructions handy for future reference.

1. Read these instructions.
2. Keep these instructions.
3. Heed all warnings.
4. Follow all instructions.
5. Do not use this apparatus near water.
6. Clean only with a dry cloth.
7. Do not block any ventilation openings. Install in accordance with the manufacturer's instructions.
8. Do not install near any heat sources such as radiators, heat registers, stoves, or other apparatus (including AV receivers) that produce heat.
9. Do not defeat the safety purpose of the polarized or grounding-type plug. A polarized plug has two blades with one wider than the other. A grounding type plug has two blades and a third grounding prong. The wide blade or the third prong are provided for your safety. If the provided plug does not fit into your outlet, consult an electrician for replacement of the obsolete outlet.
10. Protect the power cord from being walked on or pinched particularly at plugs, convenience receptacles, and the point where it exits the apparatus.
11. Only use attachments/accessories specified by the manufacturer.
12. Use only with the cart, stand, tripod, bracket, or table specified by the manufacturer, or sold with the apparatus. When a cart is used, use caution when moving the cart/apparatus combination to avoid injury from tip-over.
13. Unplug this apparatus during lightning storms or when unused for long periods of time.
14. Refer all servicing to qualified service personnel. Servicing is required when the apparatus has been damaged in any way, such as when the power-supply cord or plug is damaged, liquid has been spilled or objects have fallen into the apparatus, the apparatus has been exposed to rain or moisture, does not operate normally, or has been dropped.



Disc Storage & Management

- Holding Discs
 - Fingerprints or scratches on a disc may reduce sound and picture quality or cause skipping.
 - Avoid touching the surface of a disc where data has been recorded.
 - Hold the disc by the edges so that fingerprints will not get on the surface.
 - Do not stick paper or tape on the disc.
- Cleaning Discs
 - If you get fingerprints or dirt on a disc, clean it with a mild detergent diluted in water and wipe with a soft cloth.
 - When cleaning, wipe gently from the inside to the outside of the disc.
- Disc Storage
 - Do not keep in direct sunlight.
 - Keep in a cool ventilated area.
 - Keep in a clean protective jacket and store vertically.



Handling Cautions

- Do not expose this apparatus to dripping or splashing. Do not put objects filled with liquids, such as vases, on the apparatus.
- To turn this apparatus off completely, you must pull the power plug out of the wall socket. Consequently, the power plug must be easily and readily accessible at all times.
- Do not touch the power plug with a wet hand. It can cause an electric shock.
- Do not plug multiple electric devices into the same wall socket. Overloading a socket can cause it to overheat, resulting in a fire.
- Before connecting other components to this product, be sure to turn them off.
- If you move your product suddenly from a cold place to a warm place, condensation may occur on the operating parts and lens and cause abnormal disc playback. If this occurs, unplug the product, wait for two hours, and then connect the plug to the power outlet. Then, insert the disc, and try to play back again.

Safety Information

- If the product makes an abnormal noise or produces a burning smell or smoke, turn off the power switch immediately and disconnect the power plug from the wall outlet. Then, contact the nearest customer service center for technical assistance. Do not use the product. Using the product as it is may cause a fire or an electric shock.

License



Manufactured under license from Dolby Laboratories. Dolby, Pro Logic, and the double-D symbol are trademarks of Dolby Laboratories.



Manufactured under a license from U.S. Patent No's: 5,956,674, 5,974,380, 5,978,762, 6,487,535, 6,226,616, 7,212,872, 7,003,467, 7,272,567, 7,668,723, 7,392,195, 7,930,184, 7,333,929 and 7,548,853. DTS, DTS-HD, the Symbol, and DTS or DTS-HD and the Symbol together are registered trademarks & DTS Neo:Fusion is a trademark of DTS, Inc. ©2012 DTS, Inc. All Rights Reserved.



The terms HDMI and HDMI High-Definition Multimedia Interface, and the HDMI

Logo are trademarks or registered trademarks of HDMI Licensing LLC in the United States and other countries.



Oracle and Java are registered trademarks of Oracle and/or its affiliates. Other names may be trademarks of their respective owners.

This item incorporates copy protection technology that is protected by U.S. patents and other intellectual property rights of Rovi Corporation. Reverse engineering and disassembly are prohibited.

Blu-ray Disc™, Blu-ray™, and the logos are trademarks of Blu-ray Disc Association.

This product uses Cinavia technology to limit the use of unauthorized copies of some commercially-produced film and videos and their soundtracks. When a prohibited use of an unauthorized copy is detected, a message will be displayed and playback or copying will be interrupted.

More information about Cinavia technology is provided at the Cinavia Online Consumer Information Center at <http://www.cinavia.com>. To request additional information about Cinavia by mail, send a postcard with your mailing address to: Cinavia Consumer Information Center, P.O. Box 86851, San Diego, CA, 92138, USA.* This product incorporates proprietary technology under license from Verance Corporation and is protected by U.S. Patent 7,369,677 and other U.S. and worldwide patents issued and pending as well as copyright and trade secret protection for certain aspects of such technology. Cinavia is a trademark of Verance Corporation. Copyright 2004-2010 Verance Corporation. All rights reserved by Verance. Reverse engineering or disassembly is prohibited.

- Open Source License Notice

In the case of using open source software, Open Source Licenses are available on the product menu.

Using the 3D Function

IMPORTANT HEALTH AND SAFETY INFORMATION FOR 3D PICTURES.

Read and understand the following safety information before using the 3D function.

- Some viewers may experience discomfort while viewing 3D TV such as dizziness, nausea, and headaches. If you experience any such symptom, stop viewing 3D TV, remove the 3D Active Glasses, and rest.
- Watching 3D images for an extended period of time may cause eye strain. If you feel eye strain, stop viewing 3D TV, remove your 3D Active Glasses, and rest.
- A responsible adult should frequently check on children who are using the 3D function. If there are any reports of tired eyes, headaches, dizziness, or nausea, have the child stop viewing 3D TV and rest.
- Do not use the 3D Active Glasses for other purposes (such as general eyeglasses, sunglasses, protective goggles, etc.)
- Do not use the 3D function or 3D Active Glasses while walking or moving around. Using the 3D function or 3D Active Glasses while moving around may cause you to bump into objects, trip, and/or fall, and cause serious injury.

- If you want to enjoy 3D content, connect a 3D device (3D compliant AV receiver or TV) to the product's HDMI OUT port using a high-speed HDMI cable. Put on 3D glasses before playing the 3D content.
- The product outputs 3D signals only through an HDMI cable connected to the HDMI OUT port.
- The video resolution in 3D play mode is fixed to the resolution of the original 3D video. You can not change the resolution.
- Some functions such as BD Wise, screen size adjustment, and resolution adjustment may not operate properly in 3D play mode.
- You must use a high-speed HDMI cable for proper output of the 3D signal.
- Stay at least three times the width of the screen from the TV when watching 3D images. For example, if you have a 46 inch screen, stay 138 inches (11.5 feet) from the screen.
- Place the 3D video screen at eye level for the best 3D picture.
- When the product is connected to some 3D devices, the 3D effect may not function properly.
- This product does not convert 2D content into 3D.
- "Blu-ray 3D" and "Blu-ray 3D" logo are trademarks of the Blu-ray Disc Association.

Copyright

© 2013 Samsung Electronics Co.,Ltd.
All rights reserved; No part or whole of this user's manual may be reproduced or copied without the prior written permission of Samsung Electronics Co.,Ltd.

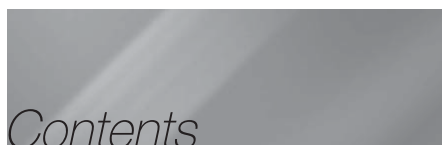

SAFETY INFORMATION

- 2 Warning
- 3 Precautions
- 3 Disc Storage & Management
- 3 Handling Cautions
- 4 License
- 4 Using the 3D Function
- 5 Copyright

GETTING STARTED

- 6 Disk and Format Compatibility
- 7 Logos of Discs the product can play
- 10 Accessories
- 11 Front Panel
- 11 Rear Panel
- 12 Toroidal Ferrite Core
- 13 Remote Control

CONNECTIONS

- 15 Connecting the Speakers
- 18 Connecting to a TV and External Devices
- 19 Connecting to a Network Router

SETTINGS

- 20 The Initial Settings Procedure
- 20 The Home Screen
- 20 Accessing the Settings Screen
- 21 Settings Menu Functions
- 25 Auto Sound Calibration
- 25 Networks and the Internet
- 28 Upgrading Software

MEDIA PLAY

- 30 The All Content Screen
- 30 Playing Commercial Discs
- 30 Playing Files on a USB Device
- 31 Playing a Disc with User Recorded Content
- 31 Using the AllShare Network Function
- 32 Controlling Video Playback
- 35 Controlling Music Playback
- 40 Playing Photo Contents
- 41 Listening to Radio
- 41 Using the Special Effects Remote Control Buttons

NETWORK SERVICES

- 43 Logging In to Your Samsung Account
- 43 Before Using Movies & TV Shows or Apps
- 44 Using Movies & TV Shows
- 44 Using Apps
- 48 Screen Mirroring
- 48 Using the Web Browser
- 51 Linking your Internet Service Accounts to the Product
- 51 BD-LIVE™

APPENDIX

- 52 Additional Information
- 56 Troubleshooting
- 59 Specifications

Getting Started

Disk and Format Compatibility

Disk types and content your Product can Play

Media	Disc Type	Details
VIDEO	Blu-ray Disc 3D Blu-ray Disc	BD-ROM or BD-RE/-R disc recorded in the BD-RE format.
	DVD-VIDEO, DVD-RW, DVD-R, DVD+RW, DVD+R	DVD-VIDEO, recorded DVD+RW/DVD-RW(V)/DVD-R/+R discs that have been recorded and finalized, or a USB storage media containing MKV, MP4 contents.
MUSIC	CD-RW/-R, DVD-RW/-R, BD-RE/-R	Music recorded on CD-RW/-R, DVD-RW/-R, BD-RE/-R discs or a USB storage media containing MP3 or WMA contents.
PHOTO	CD-RW/-R, DVD-RW/-R, BD-RE/-R	Photos recorded on CD-RW/-R, DVD-RW/-R, BD-RE/-R discs or a USB storage media containing JPEG contents.

| NOTES |

- ▶ The product may not play certain CD-RW/-R and DVD-R because of the disc type or recording conditions.
- ▶ If a DVD-RW/-R disc has not been recorded properly in DVD video format, it will not be playable.
- ▶ Your product will not play content that has been recorded on a DVD-R at a bitrate that exceeds 10 Mbps.
- ▶ Your product will not play content that has been recorded on a BD-R or USB device at a bitrate that exceeds 30 Mbps.
- ▶ Playback may not work for some types of discs, or when you use specific operations, such as angle change and aspect ratio adjustment. Information about the discs is written in detail on the disc box. Please refer to this if necessary.
- ▶ When you play a BD-J title, loading may take longer than a normal title or some functions may perform slowly.

Disk Types your Product cannot Play

- HD DVD
- DVD-ROM/PD/MV-Disc, etc
- DVD-RAM
- Super Audio CD (except CD layer)
- DVD-RW(VR mode)
- CVD/CD-ROM/CDV/CD-G/CD-I/LD (CD-Gs play audio only, not graphics.)
- 3.9 GB DVD-R Disc for Authoring.

| NOTES |

- ▶ This product may not respond to all operating commands because some Blu-ray Disc, DVD, and CD discs allow specific or limited operation and provide only certain features during playback. Please note that this is not a defect in the product.
- ▶ Samsung cannot guarantee that this product will play every disc bearing the Blu-ray Disc, DVD or CD logo because disc formats evolve, and problems and errors may occur during the creation of Blu-ray Disc, DVD, and CD software and/or the manufacture of discs.
- ▶ Please contact the SAMSUNG Customer Care Center at 1-800-726-7864 if you have questions or encounter difficulty when playing Blu-ray Disc, DVD, or CD discs in this product. Also, refer to rest of this user manual for additional information on playback restrictions.
- ▶ Some commercial discs and DVD discs purchased outside your region may not play on this product.

Region Code

Both products and discs are coded by region. These regional codes must match for a disc to play. If the codes do not match, the disc will not play.









The Region Number for this product is displayed on the rear panel of the product.

Disc Type	Region Code	Area
Blu-ray Disc		North America, Central America, South America, Korea, Japan, Taiwan, Hong Kong and South East Asia.
		Europe, Greenland, French territories, Middle East, Africa, Australia and New Zealand.
		India, China, Russia, Central and South Asia.
DVD-VIDEO		The U.S., U.S. territories and Canada
		Europe, Japan, the Middle East, Egypt, Africa, Greenland
		Taiwan, Korea, the Philippines, Indonesia, Hong Kong
		Mexico, South America, Central America, Australia, New Zealand, Pacific Islands, Caribbean
		Russia, Eastern Europe, India, North Korea, Mongolia
		China

| NOTES |

- ▶ If the Region number of a Blu-ray Disc/DVD does not correspond to the Region number of this product, the product cannot play the disc.

Logos of Discs the Product can Play

	
Blu-ray Disc	3D Blu-ray Disc
	
BD-LIVE	Dolby
	
DTS	
	
Java	NTSC broadcast system in U.S.A, Canada, Korea, Japan

Getting Started

Supported Formats

Video File Support

File Extension	Container	Video Codec	Resolution	Frame rate (fps)	Bitrate (Mbps)	Audio Codec
*.avi	AVI MKV ASF MP4 3GP MOV FLV VRO VOB PS TS SVAF	MPEG4 SP/ASP	1920x1080 (WMV v7,v8, MSMPEG4 v3 : 1280x720)	6-30	30	Dolby Digital LPCM ADPCM (IMA, MS) AAC HE-AAC WMA Dolby Digital Plus MPEG(MP3) DTS
*.mkv		H.264 BP/MP/HP				
*.asf		Motion JPEG				
*.wmv		Microsoft				
*.mp4		MPEG-4 v3				
*.3gp		Window Media				
*.vro		Video v7, v8, v9				
*.mpg		MPEG2				
*.mpeg		MPEG1				
*.ts		VP6				
*.tp	MVC	-	24/25/30	60		
*.trp						
*.mov						
*.flv						
*.vob						
*.svi						
*.m2ts						
*.webm	WebM	VP8	1920x1080	6-30	20	Vorbis

Limitations

- Even when a file is encoded by a supported codec listed above, the file might not be played if its content is defective or corrupted.
- Normal playback is not guaranteed if the file's container information is wrong or the file itself is corrupted.
- Files having higher bit or frame rates than standard may stutter when played back.
- The seek (skip) function is not available if the file's index table is damaged.
- When you playback a file remotely through a network connection, video playback may stutter depending on the network speed.
- Some USB/Digital camera devices may not be compatible with the product.

Video decoder

- Supports up to H.264 Level 4.1 (except for FMO/ASO/RS)
- Does not support VC1 AP L4
- Except for WMV v7, v8, MSMPEG4 v3, MVC, VP6
Below 1280 X 720: 60 frame max
Above 1280 X 720: 30 frame max
- Does not support GMC 2 or higher

- Supports SVAF Top/Bottom, Side by Side Only
- Supports BD MVC Spec Only

Audio decoder

- Supports WMA 10 Pro (Up to 5.1)
- Does not support WMA lossless audio.
- Supported ADPCM IMA, MS.
- Does not support ADPCM (A-Law, μ -Law)
- Does not support QCELP, AMR NB/WB
- Supports vorbis (Up to 2ch),
- Supports Dolby Digital Plus (Up to 7.1ch)

Comments

- MPEG4 : Supports up to GMC 1-Warping Point.
- H.264 : Supports up to BP/MP/HP Level 4.1.
- WMV : Supports V9, VC1 SP/MP/AP L3.
- MPEG1 : Does not support D-picture.
- MPEG2 : Supports up to Hight Profile High Level.

NOTES |

- ▶ Some MKV and MP4 format discs may not play, depending on their video resolution and frame rate.

Music File Support

File Extension	Container	Audio Codec	Support Range
*.mp3	MP3	MPEG1 Audio Layer 3	-
*.m4a *.mpa *.aac	MPEG4	AAC	-
*.flac	FLAC	FLAC	Supports up to 2ch
*.ogg	OGG	Vorbis	Supports up to 2ch
*.wma	WMA	WMA	Supports WMA 10 Pro (Up to 5.1) Does not support WMA lossless audio Supports up to M2 profile Does not support LBR mode
*.wav	wav	wav	-
*.mid *.midi	midi	midi	type 0 and type 1
*.ape	ape	ape	Does not support X13, NVT

Picture File Support

File Extension	Type	Resolution
*.jpg *.jpeg	JPEG	15360x8640
*.png	PNG	4096x4096
*.bmp	BMP	4096x4096
*.mpo	MPO	15360x8640

Notes on the USB connection

- Your product supports USB storage media, MP3 players, digital cameras, and USB card readers.
- The product does not support folder or file names longer than 128 characters.
- Some USB/digital camera devices may not be compatible with the product.
- Your product supports the FAT 16, FAT 32, and NTFS file systems.
- Connect USB devices directly to the product's USB port. Connecting through a USB cable may cause compatibility problems.
- Inserting more than one memory device into a multi-card reader may cause the reader to operate improperly.
- The product does not support the PTP protocol.
- Do not disconnect a USB device during a "loading" process.
- The bigger the image resolution, the longer the image takes to display.
- This product cannot play MP3 files with DRM (Digital Rights Management) downloaded from commercial sites.
- Your product only supports video that is under 30fps (frame rate).
- Your product only supports USB Mass Storage Class (MSC) devices such as thumb drives and USB HDD. (HUB is not supported.)
- Certain USB HDD Devices, multi-card readers and thumb drives may not be compatible with this product.
- If some USB devices require excessive power, they may be limited by the circuit safety device.
- If playback from a USB HDD is unstable, provide additional power by plugging the HDD into a wall socket. If the problem continues, contact the USB HDD manufacturer.
- SAMSUNG is not responsible for any data file damage or data loss.

Getting Started

AVCHD (Advanced Video Codec High Definition)







- This product can play back AVCHD format discs. These discs are normally recorded and used in camcorders.
- The AVCHD format is a high definition digital video camera format.
- The MPEG-4 AVC/H.264 format compresses images with greater efficiency than the conventional image compressing format.
- Some AVCHD discs use the “x.v.Color” format. This product can play back AVCHD discs that use the “x.v.Color” format.
- “x.v.Color” is a trademark of Sony Corporation.
- “AVCHD” and the AVCHD logo are trademarks of Matsushita Electronic Industrial Co., Ltd. and Sony Corporation.

| NOTES |

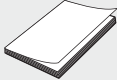
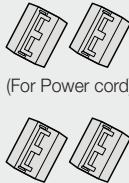
- ▶ Some AVCHD format discs may not play, depending on the recording conditions.
- ▶ AVCHD format discs need to be finalized.
- ▶ “x.v.Color” offers a wider color range than normal DVD camcorder discs.
- ▶ Some MKV and MP4 format discs may not play, depending on their video resolution and frame rate.

Accessories

Check for the supplied accessories below.

	 (For Power cord)  (For Speaker cable)		
User Manual (AH68-02630A)	Toroidal Ferrite Core (3301-000144)	ASC microphone (AH30-00099A)	
			Remote Control (AH59-02538B)/ Batteries (AAA size) (4301-000116)
FM Antenna (AH42-00021A)	Power Cable (3903-000598)	Soft Cloth (BN63-02368B)	

■ Figures and illustrations in this User Manual are provided for reference only and may differ from actual product appearance.

Front Panel

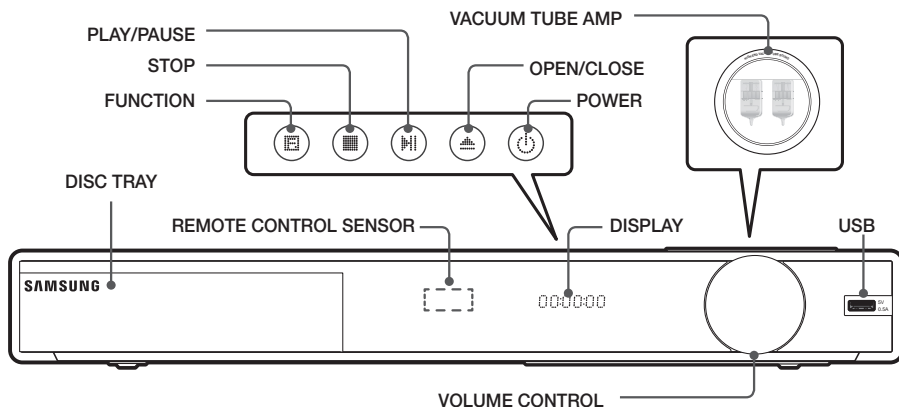

| NOTES |

- ▶ Cellular phones or mobile devices placed near the vacuum tube amp or electronic products placed on the top of the product can cause audio noise or distortion.
- ▶ When the product is on, do not let children touch the product's surface. It will be hot.
- ▶ To upgrade the product's software through the USB jack, you must use a USB flash drive.
- ▶ When the product displays the Blu-ray Disc menu, you cannot start the movie by pressing the button on the product or the remote. To play the movie, you must select Play Movie or Start in the disc menu, and then press the button.
- ▶ If you use the Internet service or play the USB device contents on the TV, you cannot select the **BD/DVD** mode with the **FUNCTION** button. Stop the playing contents on the TV first to select the **BD/DVD** mode.

Rear Panel

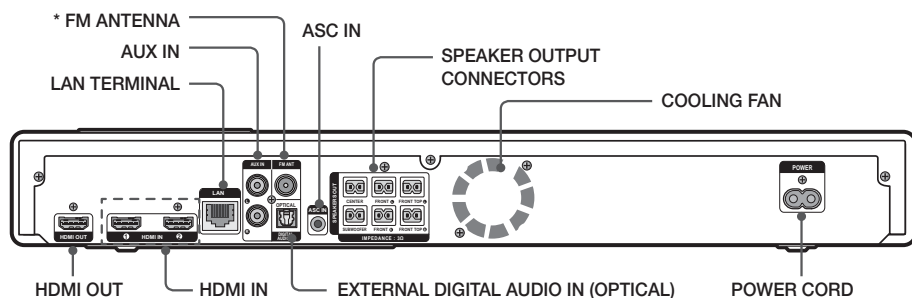

* Connecting the FM Antenna

1. Connect the FM antenna supplied to the FM ANT Jack.
2. Slowly move the antenna wire around until you find a location where reception is good, then fasten it to a wall or other rigid surface.

| NOTES |

- ▶ Maintain a minimum of 4 inches of clear space on all sides of the home theater to ensure adequate ventilation. Do not obstruct the cooling fan or ventilation holes.
- ▶ This product does not receive AM broadcasts.

Getting Started

Toroidal Ferrite Core

For the Power Cord

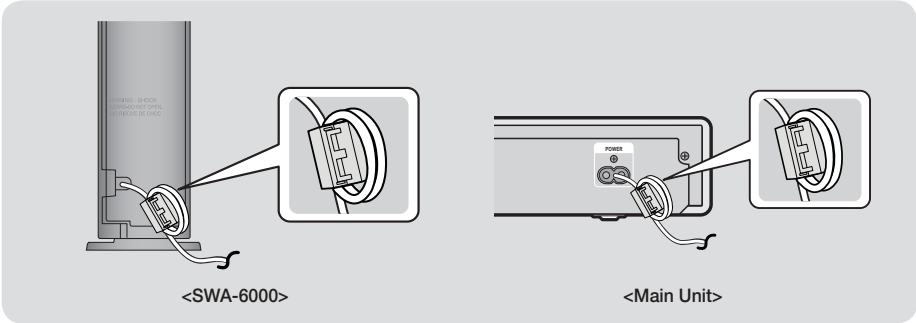

If you attach a Toroidal ferrite core to the power cord, it will help to prevent RF interference from radio signals.

1. Pull the fixing tab of the Toroidal ferrite core to open it.
2. Make two loops in the power cord.
3. Attach the Toroidal ferrite core to the power cord as the figure shows and press it until it clicks.

For the Speaker Cable

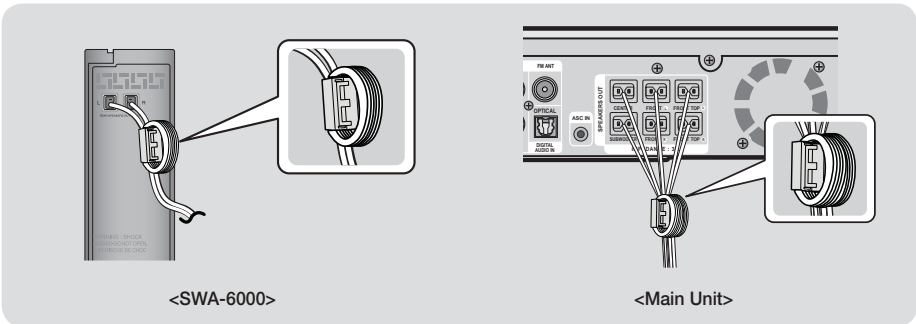

SWA-6000

Make 3 loops in each of the speaker cables connected to the REAR L and REAR R terminals of the wireless receiver (SWA-6000) and attach the ferrite core in the same way as step 3 above.

Main Unit

1. Open the ferrite core by pulling up the tab.
2. Make two loops in each speaker cable.
3. Attach the ferrite core to the arranged cables and press to close it until you hear a click.
 - Attach the ferrite core as close to the main unit as possible.

Remote Control

To pair NFC (Near Field Communication) devices with your Home Theater, you must first pair the remote control with the Home Theater. See page 39. Pairing occurs automatically when you press any button on the remote after turning on the Home Theater for the first time.

Tour of the Remote Control

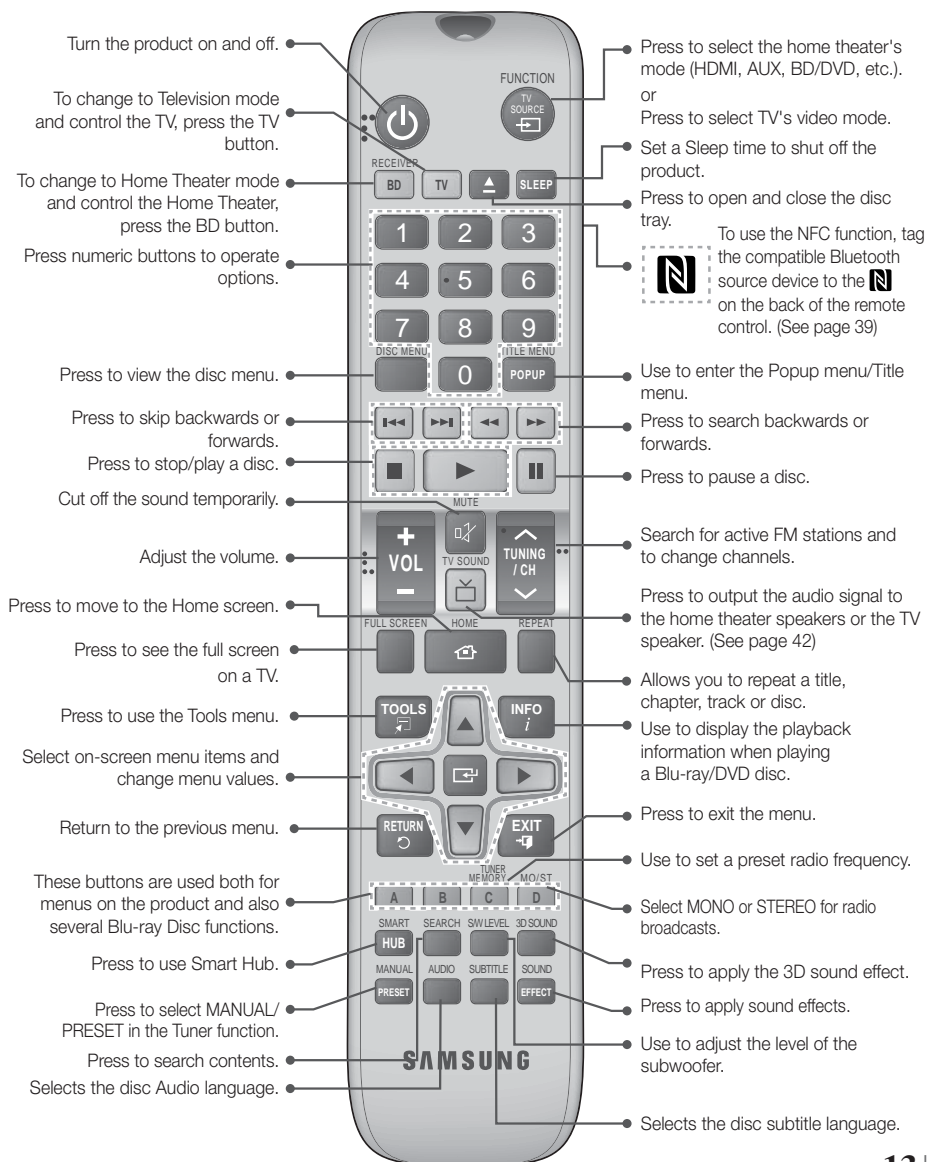

Getting Started

Installing batteries in the Remote Control

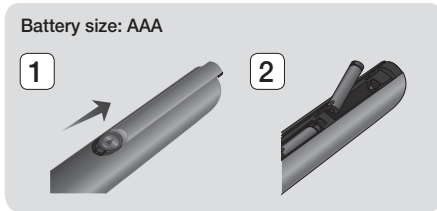

[NOTES]

- ▶ Make sure to match the “+” and “-” ends of the batteries with the diagram inside the compartment.
- ▶ Assuming typical TV usage, the batteries last for about one year.
- ▶ The remote control can be used up to approximately 23 feet (7 meters) from the product in a straight line.

Setting up the Remote Control

You can control certain functions of your TV with this remote control.

To operate a TV with the Remote Control

1. Press the **TV** button to set the remote control to TV mode.
2. Turn on your TV.
3. While holding down the **POWER** button, enter the code corresponding to your brand of TV.
 - If there is more than one code listed for your TV in the table, enter one at a time to determine which code works.
 - **Example : For a Samsung TV**
While holding down the **POWER** button, use the number buttons to enter 00. If that does not work, try 15, then 16, etc.
4. If the TV turns off, the setting is complete.
 - You can use the TV **POWER**, **VOLUME**, **CHANNEL**, and **Numeric** buttons (0-9).

[NOTES]

- ▶ The remote may not be able to control some functions, depending on your brand of TV. Also, the remote control may not work on some brands of TVs.
- ▶ The remote control will work with Samsung TVs by default.

TV Control Codes

Brand	Code	Brand	Code
Admiral (M.Wards)	56, 57, 58	Mitsubishi/MGA	18, 40, 59, 60, 75
A Mark	01, 15	MTC	18
Anam	01, 02, 03, 04, 05, 06, 07, 08, 09, 10, 11, 12, 13, 14	NEC	18, 19, 20, 40, 59, 60
AOC	01, 18, 40, 48	Nikei	03
Bell & Howell (M.Wards)	57, 58, 61	Onking	03
Brocosonic	59, 60	Onwa	03
Candle	18	Panasonic	06, 07, 08, 09, 54, 66, 67, 73, 74
Cetronic	03	Penney	18
Citizen	03, 18, 25	Philco	03, 15, 17, 18, 48, 54, 59, 62, 69, 90
Cinema	97	Philips	15, 17, 18, 40, 48, 54, 62, 72
Classic	03	Pioneer	63, 66, 80, 91
Concerto	18	Portland	15, 18, 59
Contec	46	Proton	40
Coronado	15	Quasar	06, 66, 67
Craig	03, 05, 61, 82, 83, 84	Radio Shack	17, 48, 56, 60, 61, 75
Croslex	62	RCA/Proscan	18, 59, 67, 76, 77, 78, 92, 93, 94
Crown	03	Realistic	03, 19
Curtis Mates	59, 61, 63	Sampo	40
CXC	03	Samsung	00, 15, 16, 17, 40, 43, 46, 47, 48, 49, 59, 60, 98
Daewoo	02, 03, 04, 15, 16, 17, 18, 19, 20, 21, 22, 23, 24, 25, 26, 27, 28, 29, 30, 32, 34, 35, 36, 48, 58, 90	Sanyo	19, 61, 65
Daytron	40	Scott	03, 40, 60, 61
Dynasty	03	Sears	15, 18, 19
Emerson	03, 15, 40, 46, 59, 61, 64, 82, 83, 84, 85	Sharp	15, 57, 64
Fisher	19, 65	Signature 2000 (M.Wards)	57, 58
Funai	03	Sony	50, 51, 52, 53, 55
Futuretech	03	Soundesign	03, 40
General Electric (GE)	06, 40, 56, 59, 66, 67, 68	Spectricon	01
Hall Mark	40	SSS	18
Hitachi	15, 18, 50, 59, 69	Sylvania	18, 40, 48, 54, 59, 60, 62
Inkel	45	Symphonic	61, 95, 96
JC Penny	56, 59, 67, 86	Tatung	06
JVC	70	Techwood	18
KTV	59, 61, 87, 88	Teknika	03, 15, 18, 25
KEC	03, 15, 40	TMK	18, 40
KMC	15	Toshiba	19, 57, 63, 71
LG (Goldstar)	01, 15, 16, 17, 37, 38, 39, 40, 41, 42, 43, 44	Vidtech	18
Luxman	18	Videch	59, 60, 69
LXI (Sears)	19, 54, 56, 59, 60, 62, 63, 65, 71	Wards	15, 17, 18, 40, 48, 54, 60, 64
Magnavox	15, 17, 18, 48, 54, 59, 60, 62, 72, 89	Yamaha	18
Marantz	40, 54	York	40
Matsui	54	Yupiteru	03
MGA	18, 40	Zenith	58, 79
		Zonda	01
		Dongyang	03, 54

Connections

This section describes various methods of connecting the product to other external components. Before moving or installing the product, be sure to turn off the power and disconnect the power cord.

Connecting the Speakers

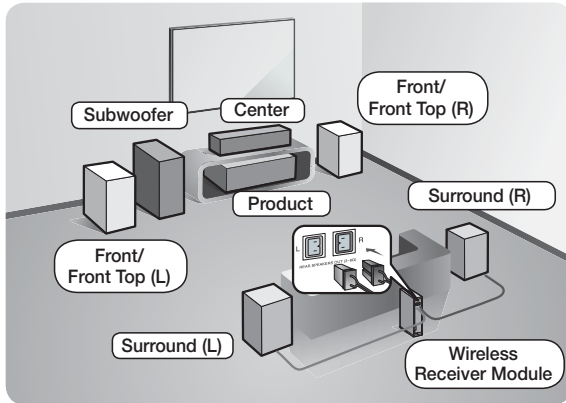

Position of the product

Place it on a stand or cabinet shelf, or under the TV stand.

Selecting the Listening Position

The listening position should be located about 2.5 to 3 times the TV's screen size away from the TV. For example, if you have a 46 inch screen, locate the listening position 115 to 138 inches (9.6 to 11.5 feet) from the screen.

Front/Front Top Speakers	Place these speakers in front of your listening position, facing inwards (about 45°) toward you. Place the front speakers so that their tweeters will be at the same height as your ear. Align the front face of the front/front top speakers with the front face of the center speaker or place them slightly in front of the center speakers.
Center Speaker	It is best to install the Center Speaker at the same height as the front/front top speakers. You can also install it directly over or under the TV.
Surround Speakers	Place these speakers to the side of your listening position. If there isn't enough room, place these speakers so they face each other. Position them about 2 to 3 feet (60 to 90cm) above your ear, facing slightly downward. * Unlike the front and center speakers, the surround speakers are used mainly for sound effects. Sound will not come from them all the time.
Subwoofer	The position of the subwoofer is not so critical. Place it anywhere you like.

* Surround speakers must be connected to the wireless receiver module.

Speaker Components

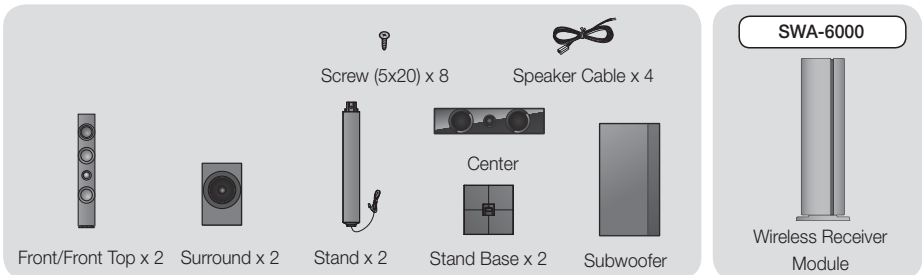

Connections

Installing the Speakers on the Tallboy Stand

1. Find the speaker cable that is attached to the Stand. Turn the Stand and Stand Base upside-down, unravel the speaker cable, and then draw it through the hole in the Stand Base.

| NOTES |

- ▶ Handle the Stand carefully. It is heavy.

2. Connect the Stand Base to the bottom of the Stand.
3. Insert three 5x20 screws into the holes in the Stand Base, and then tighten them with a screwdriver as shown in the illustration.
4. Connect the speaker to the stand.
5. Insert a 5x15 screw into the screw hole in the rear of the speaker, and then tighten it with a screwdriver.
6. Illustration 6 shows the appearance of the speaker after it has been assembled. Repeat Steps 1 through 5 with the other speaker, and then go to Step 7.
7. Match the colored plug on the end of the speaker wire connected to each speaker to the colored jacks on the back of the home theater, and then insert each plug.

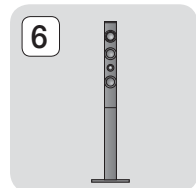
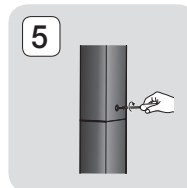
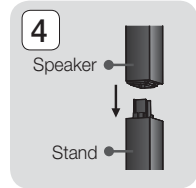
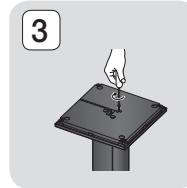
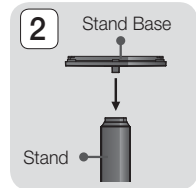

Connecting the Other Speakers

1. Match each speaker cable bundle to the correct speaker by matching the color coded plug on each bundle to the colored sticker on the bottom of each speaker.
2. To attach speaker wire to each speaker:
 - a. Press down the red tab on the back of the speaker, insert the red wire, and then release the tab.
 - b. Press down the black tab on the back of the speaker, insert the black wire, and then release the tab.
3. Connect the speaker wire plugs from each speaker to the back of the product by matching the colors of the speaker plugs to the colors of the speaker jacks.
4. Connect the left and right surround speakers to the wireless receiver module. Again, match the color of the plugs to the jacks on the wireless receiver module.
5. Plug the power cord of the wireless receiver module into a wall outlet.
6. Turn on the product. The product and wireless receiver module will now communicate with each other and you will hear sound from the Surround speakers.

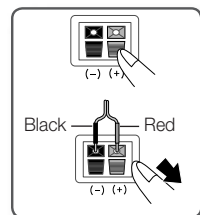

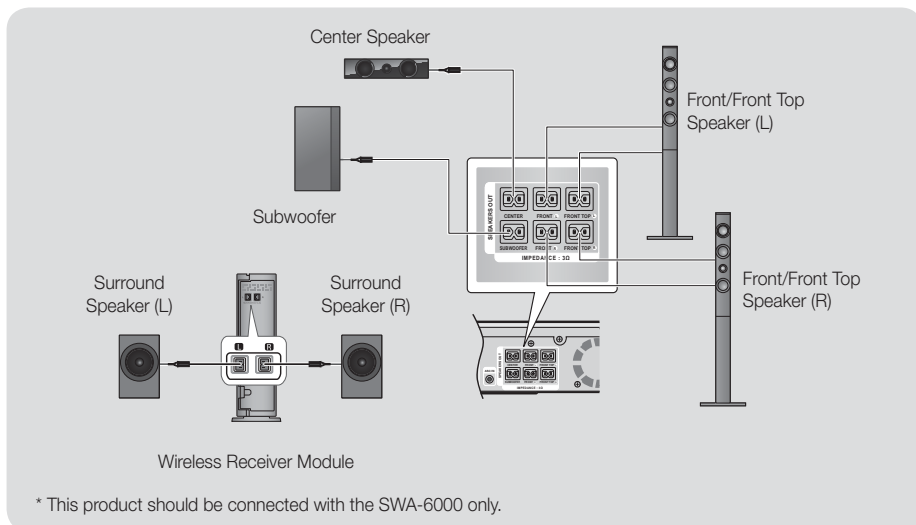

[CAUTION]

- ▶ If you want to install the speakers on the wall, fasten screws or nails (not provided) firmly to the wall wherever you want to hang a speaker, and then, using the hole in the rear of each speaker, carefully hang each speaker on a screw or nail.
- ▶ Do not let children play with or near the speakers. They could get hurt if a speaker falls.
- ▶ When connecting the speaker wires to the speakers, make sure that the polarity (+/-) is correct.
- ▶ Keep the subwoofer speaker out of reach of children to prevent children from inserting their hands or alien substances into the duct (hole) of the subwoofer speaker.
- ▶ Do not hang the subwoofer on the wall using the duct (hole).
- ▶ The wireless receiving antenna is built into the wireless receiver module. Keep it away from water and moisture.
- ▶ For optimal listening performance, make sure that the area around the wireless receiver module location is clear of any obstructions.
- ▶ If you hear no sound from the wireless surround speakers, switch the mode to Dolby Pro Logic II.
- ▶ In 2-CH mode, you will hear no sound from the wireless surround speakers.

[NOTES]

- ▶ If you place a speaker near your TV set, the screen color may be distorted because of the magnetic field.
- ▶ Place the wireless receiver module at the rear of the listening position. If the wireless receiver module is too close to the product, sound from the speakers may be disrupted because of interference.
- ▶ If you use a device such as a microwave oven, wireless LAN Card, Bluetooth equipment or any other device that uses the 2.4/5.8GHz frequencies near the product, sound from the speakers may be disrupted because of interference.
- ▶ The maximum transmission distance from the product to the wireless receiver module is about 33 feet (10m), but may vary depending on your operating environment. If a steel-concrete wall or metallic wall is between the product and the wireless receiver module, the system may not operate at all, because the radio wave cannot penetrate metal.
- ▶ If the product doesn't make a wireless connection you need to run an ID Set between the product and wireless module. Turn off the main unit and be sure both the main unit and wireless module are plugged in. Press and hold the "ID SET" button on the wireless module with a PIN until you see the blue light on top blink fast. Then with the remote control press "0"-"1"-">"3"-">"5", wait 2 seconds and press POWER to turn the unit on. The blue blinking light will turn to a solid blue, if not repeat.

Connecting to a TV and External Devices

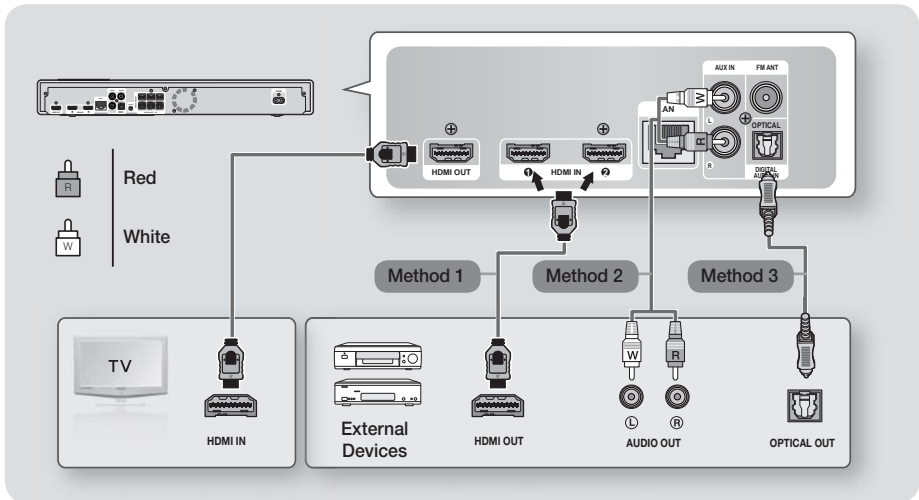

Connecting to a TV

Connect an HDMI cable (not supplied) from the HDMI OUT jack on the back of the product to the HDMI IN jack on your TV. If you have set the product's remote control to operate your TV, press the **TV SOURCE** button on the remote control and select HDMI as the external source of the TV.

Connecting to External Devices

To select the correct mode for an external device, press the **FUNCTION** button. Each time you press the button, the mode changes in this order : **BD/DVD → D. IN → AUX → HDMI1 → HDMI2 → FM → BT**

Method 1 HDMI IN : Connecting to an External Component with an HDMI Cable

Connect an HDMI cable (not supplied) from the HDMI IN jack on the back of the product to the HDMI OUT jack on your digital device. ⇨ Select the **HDMI1** or **HDMI2** mode.

Method 2 AUX IN : Connecting an External Analog Component

Using a RCA audio cable (not supplied), connect the AUDIO In jack on the product to the AUDIO Out jack on the external analog component. ⇨ Select the **AUX** mode.

- Be sure to match the colors on the cable plugs to the colors on the input and output jacks.

Method 3 OPTICAL : Connecting an External Digital Audio Component

Use to connect the digital audio output of digital signal components such as Cable Boxes and Satellite Receivers (Set-Top-Boxes): Using a digital optical cable (not supplied), connect the Optical Digital Audio In jack on the product to the Digital Optical Out jack of the external digital device.

⇨ Select the **D. IN** mode.

| NOTES |

- ▶ To see video from your Cable Box/Satellite receiver, you must connect its video output directly to your TV.
- ▶ This system supports Digital sampling frequencies of 32 kHz or higher from external digital components.
- ▶ This system supports only DTS and Dolby Digital audio. MPEG audio, a bitstream format, is not supported

Connecting to a Network Router

You can connect your product to your network router using one of the methods illustrated below.

Wired Network

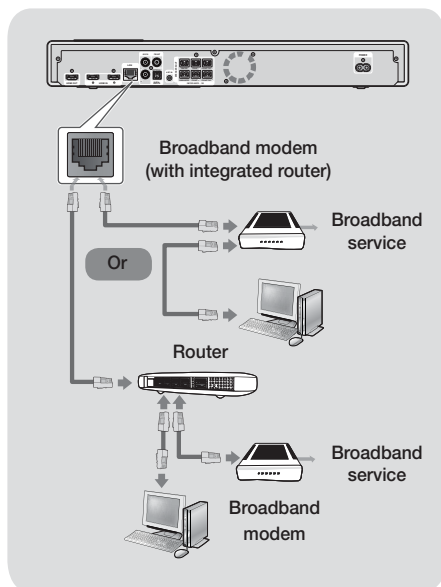

| NOTES |

- ▶ Your router or your Internet Service Provider's policies may prevent the product from accessing Samsung's software update server. If this occurs, contact your Internet Service Provider (ISP) for more information.
- ▶ DSL users, please use a router to make a network connection.
- ▶ To use the AllShare function, you must connect your PC to your network as shown in the illustrations above.
The connection can be wired or wireless.

Wireless Network

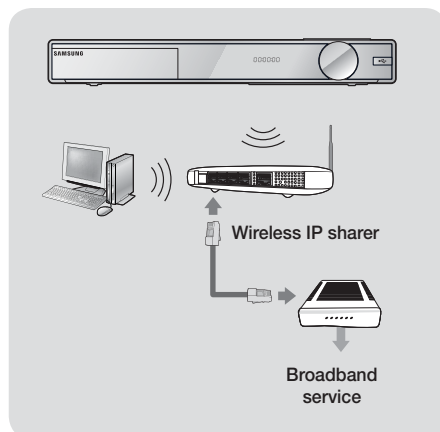

| NOTES |

- ▶ If your wireless IP router supports DHCP, this product can use a DHCP or static IP address to connect to the wireless network.
- ▶ Set your wireless IP router to Infrastructure mode. Ad-hoc mode is not supported.
- ▶ The product supports only the following wireless security key protocols:
 - WEP (OPEN/SHARED), WPA-PSK (TKIP/AES), WPA2-PSK (TKIP/AES)
- ▶ Select a channel on the wireless IP router that is not currently being used. If the channel set for the wireless IP router is currently being used by another device nearby, it will result in interference and communication failure.
- ▶ In compliance with the newest Wi-Fi certification specifications, Samsung home theaters do not support WEP, TKIP, or TKIP-AES (WPS2 Mixed) security encryption in networks running in the 802.11n mode.
- ▶ Wireless LAN, by its nature, may cause interference, depending on the operating conditions (AP performance, distance, obstacles, interference by other radio devices, etc).

Settings

The Initial Settings Procedure

- The Home menu will not appear if you do not configure the initial settings.
- The OSD (On Screen Display) may change in this product after you upgrade the software version.
- The access steps may differ depending on the menu you selected.

The Initial Settings Procedure lets you set the OSD and menu languages, configure the connection to your home network, choose the aspect ratio output (screen size and format) that is correct for your TV, and apply an upgrade to your product's software, if one is available. For complete Initial Settings instructions, see the Quick Start Guide.

| NOTES |

- ▶ If you want to display the Initial Settings screen again and make changes, select **Settings > System > Setup** in the Home screen or select the Reset option. (See page 23)

The Home Screen

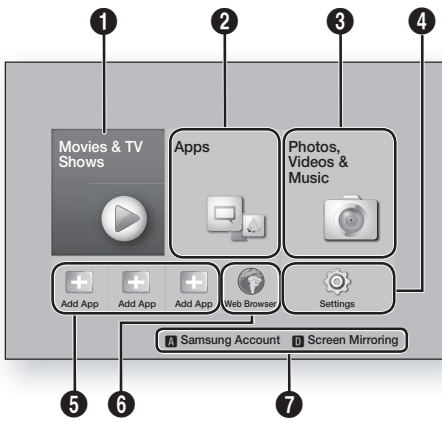

1	<p>Movies & TV Shows : Download movies and TV Shows from the Internet.</p> <p> NOTES </p> <ul style="list-style-type: none"> ▶ Depending on your country, this menu function may not be supported.
2	<p>Apps : Download/Access various for pay or free-of-charge applications.</p>

3	<p>Photos, Videos & Music : Play photos, videos or music content from Disc, USB, PC or mobile devices.</p>
4	<p>Settings : Set various functions to suit your personal preferences.</p>
5	<p>Recommended Apps : A list of useful and popular apps we recommend you download.</p>
6	<p>Web Browser : You can access the Internet using the Web Browser application.</p>
7	<p>RED (A) : Press the RED (A) button on your remote to create and/or log in to your personal Samsung account.</p> <p>BLUE (D) : Set up the wireless mirroring function between the home theater and a smart phone or tablet.</p>

- Selecting an Option on the Home Screen
1. To select an option on the Home screen, move the cursor using the **▲▼◀▶** buttons until it highlights the option of your choice, and then press the **⏏** button.

| NOTES |

- ▶ If you leave the product in the stop mode for more than 5 minutes without using it, a screen saver will appear on your TV. If the product is left in the screen saver mode for more than 20 minutes, the power will automatically turn off.

Accessing the Settings Screen

1. Select **Settings** on the Home screen, and then press **⏏**. The Settings screen appears.

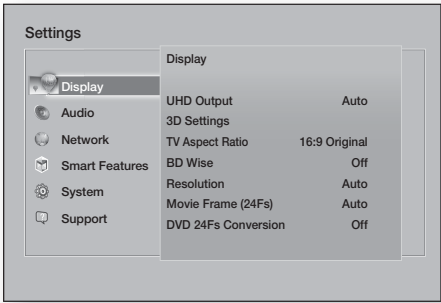

2. To access the menus, sub-menus, and options on the Settings screen, please refer to the remote control illustration on the next page.

Buttons on the Remote Control Used for the Settings Menu

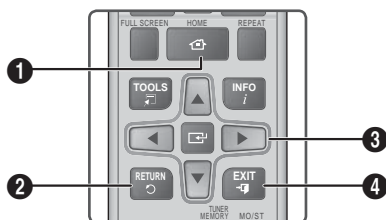

1	HOME Button : Press to move to the Home screen.
2	RETURN Button : Return to the previous menu.
3	(Enter) / DIRECTION Button : <ul style="list-style-type: none"> Press ▲▼◀▶ to move the cursor or select an item. Press the (Enter) button to activate the currently selected item or confirm a setting.
4	EXIT Button : Press to exit the current menu.

Detailed Function Information

Each Settings function, menu item, and individual option is explained in detail on-screen. To view an explanation, use the ▲▼◀▶ buttons to select the function, menu item, or option. The explanation will usually appear on the right of the screen.

A short description of each Settings function starts on this page. Additional information on some of the functions is also in the Appendix of this manual.

Settings Menu Functions

Display	
UHD Output	<p>This option outputs HDMI video at UHD resolution. This is only available when Movie Frame is set to Auto.</p> <p> NOTES </p> <ul style="list-style-type: none"> To use this feature, you must connect the product to a device that supports UHD resolution and you must have content that plays at 24Fs (film speed).

3D Settings	<p>Set up the 3D related functions.</p> <ul style="list-style-type: none"> ✓ 3D Blu-ray Playback Mode: Select whether to play a Blu-ray Disc with 3D contents in 3D Mode. If you move to the Home or Smart Hub Home menu while in 3D mode, the product will switch to 2D automatically. ✓ Screen Size: Enter the size of the TV attached to the product. The product will automatically adjust the 3D output to the screen size of the TV.
TV Aspect Ratio	<p>Lets you adjust the output of the product to the screen size of your TV. See page 52.</p>
BD Wise	<p>BD Wise is Samsung's latest inter-connectivity feature. When you connect a Samsung product and a Samsung TV with BD Wise to each other via HDMI, and BD Wise is on in both the product and TV, the product outputs video at the video resolution and frame rate of the Blu-ray/DVD Disc.</p>
Resolution	<p>Lets you set the output resolution of the HDMI video signal to BD Wise, Auto, 1080p, 1080i, 720p, 480p. The number indicates the number of lines of video per frame. The i and p indicate interlaced and progressive scan, respectively. The more lines, the higher quality.</p>
Movie Frame (24Fs)	<p>Setting the Movie Frame (24Fs) feature to Auto lets the product adjust its HDMI output to 24 frames per second automatically for improved picture quality if attached to a 24Fs compatible TV.</p> <ul style="list-style-type: none"> You can enjoy the Movie Frame (24Fs) feature only on a TV supporting this frame rate. Movie Frame is only available when the product is in the HDMI 1080p output resolution modes.
DVD 24Fs Conversion	<p>Converts DVD playback to 24 frames per second and outputs it via HDMI. This option is only available when Movie Frame (24Fs) is set to on.</p>

Settings

Smart Hub Screen Size	Lets you select the optimal size for the Smart Hub Screen.
HDMI Color Format	Lets you set the color space format for the HDMI output to match the capabilities of the connected device (TV, monitor, etc).
HDMI Deep Color	Lets you set the product to output video from the HDMI OUT jack with Deep Color. Deep Color provides more accurate color reproduction with greater color depth.
Progressive Mode	Lets you improve picture quality when viewing DVDs.

Audio

Speaker Settings	<p>Lets you adjust the following speaker settings and turn the test tone on and off so you can test the speakers.</p> <ul style="list-style-type: none"> ✓ Level: Lets you adjust the relative loudness of each speaker from 6db to -6db. For example, if you like deep bass, you can increase the loudness of the subwoofer by 6db. ✓ Distance: Lets you adjust the relative distance of each speaker from the listening position up to 9 meters. The farther the distance, the louder the speaker will be. ✓ Test Tone: Lets you run the Test Tone function so you can test your adjustments. Setting Test Tone to On turns the Test Tone on. Setting it to Off turns it off.
Auto Sound Calibration	When you run Auto Sound Calibration, the product automatically creates a 7.1 channel sound field optimized for your environment. See page 25.
Equalizer	Lets you configure the Equalizer settings manually.
Smart Volume	Lets you set the product so that the volume remains stable when a scene change occurs or when you change the channel.
Speaker Selection	Lets you select which speakers you want active, either the TV's speakers or the home theater's speakers.

Audio Return Channel	<p>Lets you direct the sound from the TV to the Home Theater speakers. Requires an HDMI connection and an Audio Return Channel (ARC) compatible TV.</p> <ul style="list-style-type: none"> • If Audio Return Channel is set to on and you are using an HDMI cable to connect the product to the TV, digital optical input will not work. • If Audio Return Channel is set to auto and you are using an HDMI cable to connect the product to the TV, ARC or digital optical input is selected automatically.
Digital Output	Lets you set the Digital Output to match the capabilities of the AV receiver you've connected to the product. For more details, please refer to the digital output selection table. (See page 54)
Dynamic Range Control	<p>Lets you apply dynamic range control to Dolby Digital, Dolby Digital Plus, and Dolby TrueHD audio.</p> <ul style="list-style-type: none"> ✓ Auto: Automatically controls the dynamic range of Dolby TrueHD audio, based on information in the Dolby TrueHD soundtrack. Also turns dynamic range control off for Dolby Digital and Dolby Digital Plus. ✓ Off: Leaves the dynamic range uncompressed, letting you hear the original sound. ✓ On: Turns dynamic range control on for all three Dolby formats. Quieter sounds are made louder and the volume of loud sounds is reduced.
Downmixing Mode	Lets you select the multi-channel downmix method that is compatible with your stereo system. You can choose to have the product downmix to normal stereo or in surround compatible stereo.
Audio Sync	When the product is attached to a digital TV, lets you adjust the audio delay so that the audio syncs with the video. You can set the delay between 0 and 300 milliseconds.

Network	
Network Status	Lets you check the current network and Internet status.
Network Settings	Lets you configure the network connection so you can enjoy various features such as Internet services or AllShare Wi-Fi functionality, and perform software upgrades.
Wi-Fi Direct	Lets you connect a Wi-Fi Direct device to the product using a peer-to-peer network, without the need for a wireless router. Note that if the product is connected to a wireless network, it may be disconnected when you use Wi-Fi Direct. NOTES ▶ Text files, such as files with a .TXT or .DOC extension, will not display when you are using the Wi-Fi Direct function.
AllShare Settings	Lets you control which devices on your network, such as smart phones and tablets, can share content with your TV.
Device Name	Lets you assign an identifying name to the product. You use this name to identify the product when you are connecting external Wi-Fi devices (smart phones, tablets, etc.) to it.
BD-Live Settings	Lets you set various BD-Live functions. BD-Live allows you to access extra features available on some Blu-ray Discs if you are connected to the Internet. ✓ BD-Live Internet Connection : Lets you fully allow, partly allow, or prohibit a BD-Live Internet connection. ✓ BD Data Management : Manage BD data downloaded from a BD-Live service or Blu-ray Disc.
Smart Features	
Apps Settings	Lets you configure App notification settings and view basic info about your Apps. ✓ Push Notification Settings : Receive notifications from selected services. ✓ Properties : See basic info about Apps.

VOD Rating Lock	Lets you lock access to Video on Demand (VOD) content based on its rating. NOTES ▶ The default security PIN is 0000. ▶ Depending on your country, this menu function may not be supported.
Terms & Conditions, Privacy Policy	Lets you view the Smart Hub Terms and Conditions and Privacy Policy.
Reset Smart Hub	Resets all Smart Hub settings to their default settings. NOTES ▶ The default security PIN is 0000.

System	
Setup	Lets you re-run the Initial Settings procedure. See the Quick Start Guide for details.
Language	Lets you select the language you prefer for the On-Screen menu, disc menu, subtitles, etc. • The language you select for the disc menu, disc audio, or subtitles will only appear if it is supported on the disc.

Device Manager	Lets you connect a wireless USB keyboard or mouse to the USB port on the front of the product. ✓ Keyboard Settings : Lets you configure a wireless USB keyboard connected to the product. NOTES ▶ You can use the keyboard only when a QWERTY keyboard screen or window appears in the Web Browser. ✓ Mouse Settings : Lets you configure a wireless USB mouse connected to the product. You can use the mouse in the product's menu in the same way you use a mouse on your PC. ▪ To use a mouse with the product's menu:
-----------------------	--

Settings

	<ol style="list-style-type: none"> 1. Connect the USB mouse to the product. 2. Click the primary button you selected in Mouse Settings. The Simple Menu appears. 3. Click the menu options you want. <p>[NOTES]</p> <ul style="list-style-type: none"> ▶ Some USB HID keyboards and mice may not be compatible with your product. ▶ Some HID keyboard keys may not work. ▶ Wired USB keyboards are not supported. ▶ Some applications may not be supported. ▶ If a wireless HID Keyboard does not operate because of interference, move the keyboard closer to the product.
<p>Security</p>	<p>The default security PIN is 0000. Enter the default PIN to access the security function if you haven't created your own PIN.</p> <ul style="list-style-type: none"> ✓ BD Parental Rating: Restricts playback of Blu-ray discs with specific ratings unless the PIN entered. ✓ DVD Parental Rating: Prevents playback of DVDs with a rating above a specific numerical rating you have set unless the PIN is entered. ✓ Change PIN: Changes the 4-digit PIN used to access security functions. <ul style="list-style-type: none"> ▪ If you forget your PIN <ol style="list-style-type: none"> 1. Remove any disc or USB storage device. 2. Press and hold the  button on the front panel for 5 seconds or more. All settings will revert to the factory default settings. <p>[NOTES]</p> <ul style="list-style-type: none"> ▶ When the factory default settings are restored, all the user stored BD data is deleted.

<p>General</p>	<p>Lets you specify the display brightness and time zone.</p> <ul style="list-style-type: none"> ✓ Front Display: Lets you change the brightness of the front panel. ✓ Time Zone: You can specify the time zone that is applicable to your area. ✓ Menu Transparency: Adjust the transparency of the menu box.
<p>Anynet+ (HDMI-CEC)</p>	<p>Anynet+ is a convenient function that offers linked operations with other Samsung products that have the Anynet+ feature and lets you control those products with one Samsung TV remote. To operate this function, you must connect this product to an Anynet+ Samsung TV using an HDMI cable.</p> <p>If you want to use an Anynet+ (HDMI-CEC) function, please follow the instructions below.</p> <ol style="list-style-type: none"> 1) Connect the product to an Anynet+ (HDMI-CEC)-compliant Samsung TV using HDMI Cable. 2) Set the Anynet+ (HDMI-CEC) feature to On in both the TV and the product. 3) Search for and then select the product in the TV's Anynet+ (HDMI-CEC) list. For more exact instructions, see the Anynet+ section of the TV's user's manual.
<p>Support</p>	
<p>Remote Management</p>	<p>When activated, lets Samsung Call Center agents diagnose and fix problems with the product remotely. Requires an active Internet connection. Remote Management service might not be available in some countries.</p>
<p>Software Update</p>	<p>For more information about the Software Update function, see "Upgrading Software" on page 28.</p>
<p>Use Mode</p>	<p>Lets you set the Use mode. If you are using the home theater at home, always select Home. Store is for retail display settings only.</p>
<p>Contact Samsung</p>	<p>Provides contact information for assistance with your product.</p>

Reset

Reverts all settings to their defaults except for the network and Smart Hub settings, and then starts the Setup function. Requires that you enter your security PIN. The default security PIN is 0000

Auto Sound Calibration

By setting the Auto Sound Calibration (ASC) function just once when you relocate or install the product, you can have the product automatically recognize the distance between speakers, levels between channels, and frequency characteristics to create a 7.1-channel sound field optimized for your environment.

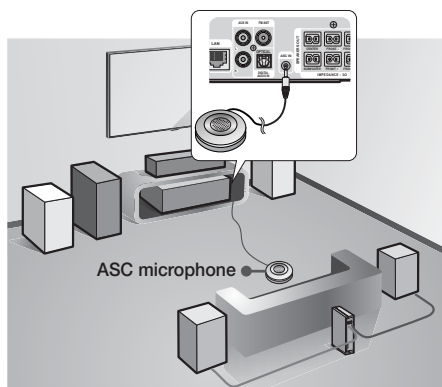
**Auto Sound Calibration**

Select whether to run and apply automatic sound calibration.

- **Off:** The unit produces sound according to the speaker configuration specified in Speaker Settings.
- **On:** The unit runs Auto Sound Calibration, and then produces sound optimized for your environment, according to the calibrated speaker settings.

Running Auto Sound Calibration

Before running the calibration, make sure there is no disc in the disc tray.

1. Plug the ASC microphone into the **ASC IN** jack.
2. Place the ASC microphone at the listening position.
 - Auto Sound Calibration automatically runs and calibrates speakers in the following sequence : **Front L → Centre → Front R → Surround R → Front Top R → Front Top L → Surround L → Subwoofer**
 - Press the **RETURN** button to cancel the Auto Sound Calibration Setting.

Networks and the Internet

When you connect this product to a network, you can use network based applications and functions such as Smart Hub and BD-LIVE, and upgrade the product's software through the network connection. For more information about accessing and using Internet services, see the Network Services chapter of this manual on pages 43-51. Instructions for configuring the network connection start below.

Configuring Your Network Connection

If you didn't configure your network connection during the initial settings procedure or you need to reset the network connection, follow the directions below.

Before you begin, contact your Internet Service Provider to find out if your IP address is static or dynamic. If it is dynamic, and you have a wired or wireless network, we recommend using the Automatic configuration procedures described below.

If you are connecting to a wired network, connect the product to your router using a LAN cable before you start the configuration procedure.

To begin configuring your network connection, follow these steps:

1. In the Home screen, select **Settings**, and then press the **OK** button.
2. Select **Network**, and then press the **OK** button.
3. Select **Network Settings**, and then press the **OK** button.
4. Go to the instructions for Wired networks starting below or the instructions for Wireless networks starting on page 26.

Wired Network**Wired – Automatic**

After following Steps 1 to 3 above:

1. In the Network Settings screen, change **Network type** to **Wired**. Then, select **Connect** and press the **OK** button. The product detects the wired connection, verifies the network connection and then connects to the network.
2. When it is done, highlight **OK**, and then press **OK** button.

Wired - Manual

If you have a static IP address or the automatic procedure does not work, you'll need to set the Network Settings values manually.

Settings



After following Steps 1 to 3 above:

1. In the Network Settings screen, change **Network type** to **Wired**. Then, select **Connect** and press the  button.
The product searches for a network, and then displays the connection failed message.

| NOTES |

- ▶ If it is possible to connect the home theater to your network wirelessly, select **Change Network** at this point, change the **Network type** to **Wireless**, and then go to the instructions for wireless networks on page 26.



2. Use the ◀▶ buttons to select **IP Settings**, and then press the  button. The IP Settings screen appears.
3. Select the **IP Setting** field, and then set it to **Enter manually**.
4. Select a value to enter (IP Address, for example), and then press . Use the number keypad on your remote control to enter the numbers for the value. You can also enter numbers using the ▲▼ buttons. Use the ◀▶ buttons on the remote control to move from entry field to entry field within a value. When done with one value, press the  button.
5. Press the ▲ or ▼ button to move to another value, and then enter the numbers for that value following the instructions in Step 4.
6. Repeat Steps 4 and 5 until you have filled in all values.

| NOTES |

- ▶ You can get the Network values from your Internet provider.
7. When finished entering all the values, select **OK**, and then press the  button. The home theater verifies the network connection and then connects to the network.

Wireless Network

You can setup a wireless network connection in three ways:

- Wireless Automatic
- Wireless Manual
- WPS(PBC)



Before you configure the wireless network connection, disconnect any wireless network device currently connected to the product or, if applicable, the product's current wired connection.

□ Wireless - Automatic

After following Steps 1 to 3 in "Configuring Your Network Connection" on page 25:

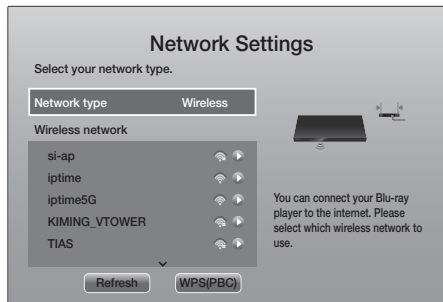
1. In the Network Settings screen, change **Network type** to **Wireless**. The product searches for and then displays a list of the available networks.



2. Select the desired network, and then press the  button.
3. On the Security screen, enter your network's security code or pass phrase.
Enter numbers directly using the number buttons on your remote control. Enter letters by selecting a letter with ▲▼◀▶ buttons, and then pressing  button.
4. When finished, select **Done**, and then press the  button. The product verifies the network connection and then connects to the network.











| NOTES |

- ▶ You should be able to find the security code or pass phrase on one of the set up screens you used to set up your router or modem.









□ Wireless - Manual

If you have a static IP address or the Automatic procedure does not work, you'll need to set the Network Settings values manually.









After following Steps 1 to 3 in "Configuring Your Network Connection" on page 25:



1. In the Network Settings screen, change **Network type** to **Wireless**. The product searches for and then displays a list of the available networks.
2. Scroll through the list, select the desired network or **Add Network**, and then press the  button.
3. If you selected a network in Step 2, go to Step 6. If you selected **Add Network**, go to Step 4.
4. Enter your wireless network or wireless router's name.
 - Enter numbers directly using the number buttons on your remote control.
 - Enter letters by selecting a letter with the     buttons, and then pressing the  button.
 - To display capital letters (or redisplay small letters if capital letters are displayed), select , and then press the  button.
 - To display symbols and punctuation, select **123#&**, and then press the  button. To redisplay letters, select **123#&**, and then press the  button.

When finished, select **Done**, and then press the  button.









5. On the Security type screen that appears, use the   buttons to select the network's Security type, and then press the  button. On the next screen, enter your network's security code or pass phrase.
 - Enter numbers directly using the number buttons on your remote control.
 - Enter letters by selecting a letter with the     buttons, and then pressing the  button.

When finished, select **Done**, and then press the  button. The product searches for the network.

6. The Network connection fail screen appears. Use   buttons to select **IP Settings**, and then press the  button.
7. Select the **IP Setting** field, and then set it to **Enter manually**.
8. Select a network value to enter (IP Address, for example), and then press  button. Use the number keypad on your remote control to enter the numbers for the value. You can also enter numbers using the   buttons. Use the   buttons on the remote control to move from entry field to entry field within a value. When done with one value, press the  button.

9. Press the  or  button to move to another value, and then enter the numbers for that value following the instructions in Step 8.
10. Repeat Steps 8 and 9 until you have filled in all values.

| NOTES |

- ▶ You can get the Network values from your Internet provider.
11. When finished, select **OK**, and then press the  button. The Security Screen appears.
 12. On the Security screen, enter your network's Security Code or Pass Phrase. Enter numbers directly using the number buttons on your remote control. Enter letters by selecting a letter with the     buttons, and then pressing the  button.
 13. When finished, select **Done** at the right of the screen, and then press the  button. The product verifies the network connection and then connects to the network.
 14. After the home theater verifies the network, select **OK**, and then press the  button.



| NOTES |

- ▶ You can also begin the Manual Network setting by going to **Settings >Network > Network Status**.

□ WPS(PBC)

One of the easiest ways to set up the wireless network connection is using the WPS(PBC) function. If your wireless router has a WPS(PBC) button, follow these steps:

After following Steps 1 to 3 in "Configuring Your Network Connection" on page 25:

1. In the Network Settings screen, change **Network type** to **Wireless**. The product searches for and then displays a list of the available networks.
2. Scroll the list down, select **WPS(PBC)**, and then press the  button.
3. Press the **WPS(PBC)** button on your router within two minutes. Your product automatically acquires all the network settings values it needs and connects to your network. The product connects to the network after the network connection is verified.
4. When it is done, highlight **OK**, and then press  button.

| NOTES |

- ▶ For a WPS connection, set your wireless router's security encryption to AES. WEP security encryption does not support a WPS connection.

Wi-Fi Direct

The Wi-Fi Direct function allows you to connect Wi-Fi Direct devices to the product and each other using a peer-to-peer network, without a wireless router.

| NOTES |

- ▶ Some Wi-Fi Direct devices may not support the AllShare function if connected via Wi-Fi Direct. If this is the case, change the network connection method you used to connect the device to the home theater.
 - ▶ Wi-Fi Direct transmissions can interfere with Bluetooth signals. Before you use the Bluetooth function, we strongly recommend that you turn off the Wi-Fi Direct function on any device in which it is currently on.
1. Turn on the Wi-Fi direct device and activate its Wi-Fi Direct function.
 2. In the Home screen, select **Settings**, and then press the  button.
 3. Select **Network**, and then press the  button.
 4. Select **Wi-Fi Direct**, and then press the  button. The Wi-Fi Direct devices that you can connect appear.



5. You have three ways to complete the Wi-Fi connection:
 - Through the Wi-Fi device.
 - Through the product using PBC.
 - Through the product using a PIN.

Each is covered below.

Through the Wi-Fi Device

1. On the Wi-Fi device, follow the device's procedure for connecting to another Wi-Fi Direct device. See the device's user manual for instructions.
2. When you have completed the procedure, you should see a pop-up on your TV screen saying that a device that supports Wi-Fi Direct has requested to connect. Select **OK**, and then press the  button to accept.

3. The Connecting pop-up appears, followed by the Connected pop-up. When it closes, you should see the device listed on the Wi-Fi Direct screen as connected.

- The PBC and PIN procedures connect devices automatically.

Through the Product Using PBC

1. Select the Wi-Fi Direct device you want to connect to this product, and then press the  button.
2. The Connecting pop-up appears, followed by the Connected pop-up. When it closes, you should see the device listed on the Wi-Fi Direct screen as connected.

Through the Product Using a PIN

1. Select the Wi-Fi Direct device you want to connect to this product, and then press the  button.
2. The PIN pop-up appears.
3. Note the PIN code in the pop-up, and then enter it into the appropriate field in the Wi-Fi Direct device you want to connect.
4. The Connecting pop-up appears, followed by the Connected pop-up. When it closes, you should see the device listed on the Wi-Fi Direct screen as connected.





| NOTES |

- ▶ The current wired or wireless network connection will be disconnected when you use the Wi-Fi Direct function.
- ▶ Text files, such as files with a .TXT or .DOC extension, will not display when you are using the Wi-Fi Direct function.

Upgrading Software

The Software Update menu allows you to upgrade the product's software for performance improvements or additional services.

- Never turn the product off or back on manually during the update process.

1. In the Home menu, select **Settings**, and then press the  button.
2. Select **Support**, and then press the  button.
3. Select **Software Update**, and then press the  button.
4. To download update software and update now, select **Update now**, and then press the  button. See "Update now" on next page for details.



- To let the product download update software automatically when available, select **Auto Update**, and then press the  button. See "Auto Update" on this page for details.

| NOTES |

- ▶ The upgrade is complete when the product turns off, and then turns on again by itself.
- ▶ Samsung Electronics takes no legal responsibility for product malfunction caused by an unstable Internet connection or consumer negligence during a software upgrade.
- ▶ If you want to cancel the upgrade while the upgrade software is downloading, press the  button.
- ▶ When a system upgrade is in progress, "UPDATE" is displayed on the front panel.

Update now

You can use Update now to update the software through your network connection or by using a USB flash drive. The network instructions are below. The USB flash drive instructions are on this page.

- Select **Update now**, and then press the  button. The Update now pop-up appears.
- The product searches on line for the latest software version.
- If it does not find an update, the "There are no new updates for you at the moment." pop-up appears. Press the  button to exit.
- If it finds a new version, the Update Request pop-up appears.
- Select **OK**. The product upgrades the software, turns off, and then turns on automatically.
- If you do not select **OK** or **Cancel** in one minute, the product stores the new upgrade software. You can upgrade the software later using Auto Update.
- If you select **Cancel**, the product cancels the upgrade.

| NOTES |

- ▶ When the system upgrade is done, check the software details in the Product Information section of the Contact Samsung screen.
- ▶ Do not turn off the product during the Software Upgrade. It may cause the product to malfunction.

Auto Update

You can set the Auto Update function so that the product downloads new upgrade software when it is in Auto Update mode.

In Auto Update mode, the product is off, but its Internet connection is active. This allows the product to download upgrade software automatically, when you are not using it.

- Press the **▲▼** buttons to select **Auto Update Mode**, and then press the  button.

- Select **On** or **Off**.

If you select **On**, the product will automatically download new upgrade software when it is in Auto Update mode with the power off. If it downloads new upgrade software, the product will ask you if you want to install it when you turn the product on.

| NOTES |

- ▶ To use the Auto Update function, your product must be connected to the Internet.

Update by USB

- Visit www.samsung.com.
- Click **SUPPORT** on the top right of the page.
- Enter the product's model number into the search field. As you enter the model number, a drop down will display products that match the model number.
- Left click your product's model number in the drop down list.
- On the page that appears, scroll down to and then click **Firmware Manuals & Downloads**.
- Click **Firmware** in the center of the page.
- Click the **ZIP** button in the File column on the right side of the page.
- Click **Send** in the first pop-up that appears. Click **OK** in the second pop-up to download and save the firmware file to your PC.
- Unzip the zip archive to your computer. You should have a single folder with the same name as the zip file.
- Copy the folder to a USB flash drive.
- Make sure no disc is inserted in the product, and then insert the USB flash drive into the USB port of the product.
- In the product's menu, go to **Settings > Support > Software Update**.
- Select **Update now**.
- The product searches for the software on the USB drive. When it finds the software, the Update Request pop-up appears.
- Select **OK**. The product upgrades the software, turns off, and then turns on automatically.

| NOTES |

- ▶ There should be no disc in the product when you upgrade the software using the USB jack.
- ▶ When the system upgrade is done, check the software details in the Product Information section of the Contact Samsung screen.
- ▶ Do not turn off the product during the software upgrade. It may cause the product to malfunction.
- ▶ Software upgrades using the USB jack must be performed with a USB flash drive only.

Media Play

Your home theater can play content located on Blu-ray/DVD/CD discs, USB devices, PCs, smart phones, tablets, and on the Web.

To play content located on your PC or a mobile device, you must connect the PC or mobile device and the product to your network. To play content on your PC, you must also download and install AllShare network software or already have DLNA network software on your PC.

| NOTES |

- ▶ PCs running Windows 7 and Windows 8 have DLNA software (Play To) built in.

The All Content Screen

For all media, the **All Content** screen or one of its sub screens is your primary means of accessing and playing contents saved on a variety of devices, either connected directly or using your network.



Using the All Content Screen

To access the **All Content** screen, select Photos, Videos & Music on the Home screen, and then press the  button.

Playing Commercial Discs

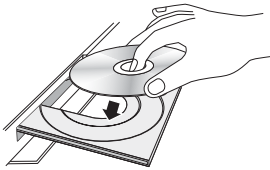
1. Press the  button to open the disc tray.
2. Place a disc gently into the disc tray with the disc's label facing up.



3. Press the  button to close the disc tray. Playback starts automatically.
4. If playback does not start automatically, press the  button on the remote. If the disc still does not play, see "Controlling Video Playback" on page 32 or "Controlling Music Playback" on page 35.

Playing Files on a USB Device



There are two methods you can use to play or view multimedia files located on a USB device through your product.

Method 1

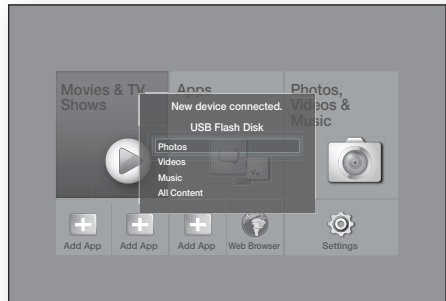





1. Turn the product on.
2. Connect the USB device to the USB port on the front panel of the product. The New Device Connected pop-up appears.





| NOTES |

- ▶ If the pop-up does not appear, go to Method 2.
3. Use the   buttons to select **Photos**, **Videos**, **Music** or **All Content**, and then press the  button. Depending on how the contents are arranged, you will see either folders, individual files, or both.







| NOTES |

- ▶ Even though the product will display folders for all content types, it will only display files of the Content Type you selected in Step 3. For example, if you selected **Music**, you will only be able to see music files. You can change this selection by returning to the **Photos, Videos & Music** screen, and then going to Step 4 in Method 2 below.
4. If necessary, use the     buttons to select a folder, and then press the  button.
 5. Select a file to view or play, and then press the  button.
 6. Press the **RETURN** button to exit a folder or the **Exit** button to return to the Home screen.
 7. Go to pages 32–40 for instructions that explain how to control playback of videos, music, and pictures on a USB device.

Method 2

1. Turn the product on.
2. Connect the USB device to the USB port on the front panel of the product.
3. Select **Photos, Videos & Music** on the Home screen, and then press the  button.
4. Select **Photos, Videos, Music** or **All Content**, and then press the  button.
Depending on how the contents are arranged, you will see either folders, individual files, or both.

| NOTES |

- ▶ Even though the product will display folders for all content types, it will only display files of the Content Type you selected in Step 4. For example, if you selected **Music**, you will only be able to see music files. You can change this selection by returning to the **Photos, Videos & Music** screen and repeating Step 4.
5. Use the  buttons to select the desired device and then press the  button.
 6. If necessary, use the    buttons to select a folder, and then press the  button.
 7. Press the **RETURN** button to exit a folder or the **Exit** button to return to the Home screen.
 8. Go to pages 32~40 for instructions that explain how to control playback of videos, music, and pictures on a USB device.

| NOTES |









- ▶ If you insert a disc when playing a USB device or phone, the device mode changes to "Disc" automatically.
- ▶ If your cellular phone is DLNA compatible, you can play contents without connecting a USB cable. See "Using the AllShare Network Function" on this page.

Playing a Disc with User Recorded Content

You can play multimedia files you have recorded on Blu-ray, DVD, or CD discs.

1. Place a user recorded disc into the disc tray with the disc's label facing up, and then close the tray. The Device Connected pop-up appears.
2. Use the  buttons to select the type of content you want to view or play - **Photos, Videos**, or **Music** - and then press the  button.

| NOTES |

- ▶ Even though the product will display folders for all content types, it will only display files of the Content Type you selected in Step 2. For example, if you selected **Music**, you will only be able to see music files. You can change this selection by returning to the **Photos, Videos & Music** screen and repeating Step 2.
3. A screen appears listing the contents of the disc. Depending on how the contents are arranged, you will see either folders, individual files, or both.
 4. If necessary, use the    buttons to select a folder, and then press the  button.
 5. Use the    buttons to select a file to view or play, and then press the  button.
 6. Press the **RETURN** button one or more times to exit a current screen, exit a folder, or to return to the Home screen.
Press the **Exit** button to return directly to the Home Screen.
 7. Go to pages 32~40 for instructions that explain how to control playback of videos, music, and pictures on a disc.

Using the AllShare Network Function

AllShare lets you play **Photos, Videos**, or **Music** located on your PC or your DLNA compatible device through the product using a wireless network connection.

To Download the AllShare Software

AllShare makes it easy to retrieve and enjoy media files from computers and DLNA-enabled devices. However, computers need to be installed with AllShare PC and mobile devices need to support AllShare. For more information, visit the Samsung Content & Service portal (<http://link.samsung.com>).

| NOTES |

- ▶ You may experience compatibility issues when attempting to play media files via a third-party DLNA server.

Media Play

Playing Content Located on Your PC or DLNA Device through the Product

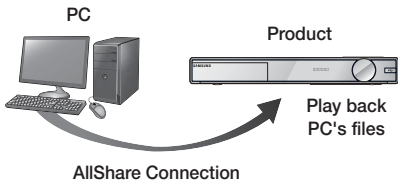

1. Connect the product, your PC, and/or your DLNA compatible device to the same wireless network.
2. Follow the directions in the AllShare software Installation/Instruction manual to set up devices and files for playing or viewing.
3. Select **Photos, Videos & Music** on the product's Home screen, and then press the **OK** button. The **Photos, Videos & Music** screen appears.
4. Select the type of content you want to play - **Photos, Videos, Music, or All Content** - and then press the **OK** button.
5. On the next screen, select **AllShare**, and then press the **OK** button.
6. In the list of AllShare connected devices that appears, select your PC or other AllShare compatible device, and then press the **OK** button. A screen listing the available files appears.
7. Select the file you want to play or view, and then press the **OK** button.

Controlling the Playback of Content Located on Your PC with Your Smart Phone

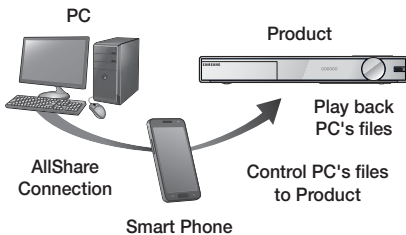

(Only available with Samsung phones supporting AllShare functionality.)

1. Connect the product, your PC, and your DLNA compatible cellular phone to the same wireless network.
2. Follow the directions in the AllShare software Installation/Instruction manual to set up devices and files for playing or viewing.
3. On your computer, using the AllShare software, confirm your phone is connected.
4. On the phone, select the file you want to view or play, and then select the home theater system as the playback device.
5. On the phone, start playback.

Controlling Video Playback

You can control the playback of video content located on a Blu-ray/DVD disc, USB device, mobile device or PC. Depending on the disc or contents, some of the functions described in this manual may not be available.

Buttons on the Remote Control used for Video Playback

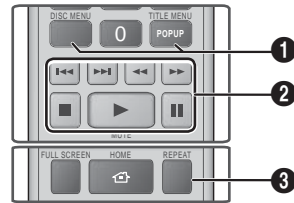

















- 1 Using the disc menu, title menu, popup menu and title list

DISC MENU	During playback, press this button to display the Disc menu.
TITLE MENU	During playback, press this button to display the Title menu. <ul style="list-style-type: none"> • If your disc has a playlist, press the View button to go to the playlist.
POPUP MENU	During playback, press this button to display the Popup menu.



2 Playback related buttons

The product does not play sound in Search, Slow, or Step mode.



- To return to normal speed playback, press the  button.

	Starts playback.
	Stops playback.
	Pauses playback.
Fast Motion Play	During playback, press the  or  button. Each time you press the  or  button, the playback speed will change.
Slow Motion Play	In pause mode, press the  button. Each time you press the  button, the playback speed will change.
Step Motion Play	In pause mode, press the  button. Each time you press the  button, a new frame appears.
Skip Motion Play	During playback, press the  or  button. Each time you press the  or  button, the disc moves to the previous or next chapter or file.







3 Repeat Playback

1. During playback, press the **REPEAT** button on the remote control.
2. Press the   buttons to select **Off**, **Title**, **Chapter**, **All** or **Repeat A-B** then press the  button.

□ Repeat A-B

1. Press the  button at the point where you want repeat play to start (A).
2. Press the  button at the point where you want repeat play to stop (B).
3. To return to normal play, press the **REPEAT** button again.
4. Press the  button.

| NOTES |









- ▶ Depending on the disc, the screen may not display all repeat options.
- ▶ The screen may not display Chapter or Title immediately. Continue to press the   buttons until your choice is inside the applicable field.
- ▶ To return to normal play, press the **REPEAT** button again, press the   buttons to select **Off**, and then press the  button.
- ▶ The screen may not display Repeat A-B immediately. Continue to press the   buttons until Repeat A-B is inside the applicable field.
- ▶ You must set point (B) at least 5 seconds of playing time after point (A).

Using the TOOLS Menu

During playback, press the **TOOLS** button.

Play from the Beginning	Select to return to the beginning of the movie, and then press the  button.
3D	Use 3D menu to select Side by Side or Top Bottom option if the 3D content currently playing does not properly appear in 3D mode. NOTES ▶ Use 3D menu for 3D content only. If you apply the Side by Side or Top Bottom format to 2D content, it will not be displayed properly.
Search Scene	You can use the Search Scene function during playback to view or start a movie from the scene of your choice. NOTES ▶ If the index information in the file is damaged or the file does not support indexing, you will not be able to use the Search Scene function. ▶ If you are using the DLNA function after connecting to a computer through your network, Search Scene may not be supported.

Media Play

Search Titles	<p>If there is more than one movie on the disc or device, select to start a different title.</p> <ol style="list-style-type: none"> 1. Select Search Titles, and then press the  button. 2. Use the ▲▼ buttons to select a title, and then press the  button.
Search Chapters	<p>Select to play the chapter of your choice.</p> <ol style="list-style-type: none"> 1. Select Search Chapters, and then press the  button. 2. Use the ▲▼ buttons to select a chapter, and then press the  button.
Search Time bar	<p>Select to play the movie from a selected time point.</p> <ol style="list-style-type: none"> 1. Select Search Time bar, and then press the  button. 2. Using the number buttons, enter the time point you want to go to, and then press the  button. <p> NOTES </p> <ul style="list-style-type: none"> ▶ You can also use the ◀▶ buttons to advance or rewind the movie. The movie advances or rewinds one minute each time you press the ◀▶ buttons.
Repeat Mode	<p>Select to repeat a title, chapter, or specific section.</p> <ul style="list-style-type: none"> - Off : Select to return to normal playback. - Title : Choose to repeat a selected title. - Chapter : Choose to repeat a specific chapter. - Repeat A-B : Choose to repeat a specific section. <ol style="list-style-type: none"> 1. Press the ▲▼ buttons to select repeat A-B, and then press the  button. 2. Press the  button at the point where you want repeat play to start (A). Let the movie play. 3. Press the  button at the point where you want repeat play to stop (B).

	<p> NOTES </p> <ul style="list-style-type: none"> ▶ You must set point (B) at least 5 seconds of playing time after point (A).
Picture Mode	<p>Select to set the picture mode.</p> <ul style="list-style-type: none"> - Dynamic : Increases sharpness and brightness. - Standard : Choose this setting for most viewing applications. - Movie : The best setting for watching movies. - User : Lets you adjust the sharpness and noise reduction function respectively. <p> NOTES </p> <ul style="list-style-type: none"> ▶ When you use the BD Wise function, this menu will not appear.
Equalizer Mode	Select to use the Equalizer.
Equalizer Settings	<p>Select to set the Equalizer.</p> <p> NOTES </p> <ul style="list-style-type: none"> ▶ It only appears when equalizer mode is on.
Audio	Select to set the desired audio language.
Audio Sync	In some cases when the product is connected to a digital TV, the audio signal may not synchronize with the video signal. If this occurs, adjust the audio delay time to match the video signal.
Subtitle	Select to set the desired subtitle language.
Subtitle Settings	Select to set the desired subtitle options.
Angle	To view a scene from another angle. The Angle option displays the number of angles available to view (1/1, 1/2, 1/3, etc.).
BONUSVIEW Video	Select to set the desired Bonusview option.
BONUSVIEW Audio	

Full Screen	Select to set the size of the video image. Choose Original , Mode1 (larger), or Mode2 (largest).
Information	Select to view video file information.

| NOTES |

- ▶ Depending on the disc or storage device, the Tools menu may differ.
- ▶ Video files with high bitrates of 20Mbps or more strain the product's capabilities and may stop playing during playback.

Using the View & Options Menus

On the screen that lists the video files, use the ▲▼◀▶ buttons to select **View** or **Options** in the upper right, and then press the  button.

Videos		
View	Date	Displays all the folders with videos by date. If you select a folder, and then press  button, displays all the videos in the folder by date.
	Title	Displays all the video files on the media or storage device by title.
	Folder	Displays all the folders on the media or storage device.
Options	Play Selected	Play Selected lets you create a playlist by selecting specific files to play. It works essentially the same way for all media. See Creating a Playlist from a CD on page 37.
	Send	Select Send to upload selected files to apps (Picasa, Facebook etc) or devices. To use Send , you need to establish an account with the on-line site, and then log in using the Log In function.

| NOTES |





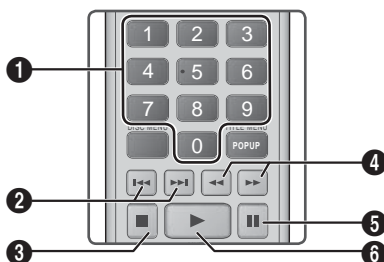

- ▶ Depending on the disc or storage device, the Options View menus may differ. All options may not be displayed.
- ▶ The View and Options menus are usually available when you are viewing video files on a USB flash drive, a PC, a disc you recorded yourself, or a mobile device. They are usually not available if you are viewing a commercial Blu-ray, DVD, or CD disc.

Controlling Music Playback

You can control the playback of music content located on a DVD, CD, USB, mobile device or PC. Depending on the disc or contents, some of the functions described in this manual may not be available.









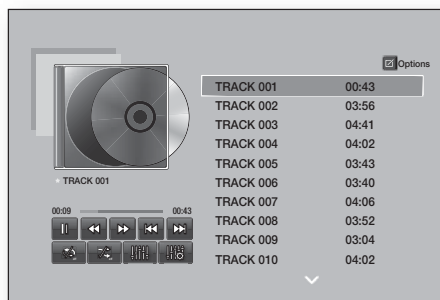

Buttons on the Remote Control used for Music Playback



1	NUMBER buttons : If numbered tracks are displayed, press the number of a track. The selected track is played.
2	 buttons : Move to the previous/next track.
3	 button : Stops a track.
4	Fast Play (Audio CD (CD-DA) only) During playback, press the  button. Each time you press the  or  button, the playback speed will change.
5	 button : Pauses a track.
6	 button : Plays the currently selected track.

Music Screen Controls



	Pause a track.
	Play a track.
	Move to the previous track.
	Move to the next track.
	Rewind the track.
	Advance the track.
	Repeat one track or all tracks.
	Play tracks in random order.
	Display the Equalizer.
	Adjust the equalizer manually. (Only when equalizer mode is on)

To access the controls, play a track, and then use the ▲▼◀▶ buttons to move to the control of your choice.

| NOTES |

- ▶ The Music Screen controls are only accessible when a track is playing.
- ▶ All controls do not appear at the same time.

Using the View & Options Menus

On the screen that lists the music files, use the ▲▼◀▶ buttons to select **View** or **Options** in the upper right, and then press the  button.

Music		
View	Track	Displays all the music tracks on the media or storage device.
	Album	Displays all the music on the media or storage by album.
	Artist	Displays all the music files on the media or storage device by artist
	Genre	Displays all music on the media or storage by genre.
	Folder	Displays all the folders on the media or storage device.



Options	Play Selected	Play Selected lets you create a playlist by selecting specific files to play. It works essentially the same way for all media. See Creating a Playlist on an Audio CD on the next page.
	Send	Select Send to upload selected files to apps (Picasa, Facebook, etc.) or devices. To use Send , you need to establish an account with the on-line site, and then log in using the Log In function.
	Ripping	The Ripping function converts CD audio to the mp3 format and saves the converted files on a USB device or the mobile device connected to the product. See Ripping on page 37.
	Information	Select to see content information.
	Encoding	Select to manage the text encoding options.

| NOTES |

- ▶ Depending on the disc or storage device, the Options menu may differ. All options may not be displayed.

Repeating Tracks on an Audio CD

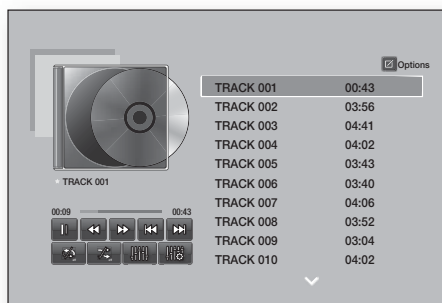

You can set the product to repeat tracks on an audio CD (CD-DA/MP3).

1. During playback, use the ▲▼◀▶ buttons to select  in the lower left corner of the screen, and then press the  button.
2. Use the ▲▼ to select the Repeat mode you want - **Off**, **One Song**, or **All** - and then press the  button.







Shuffling Tracks on an Audio CD

You can set the product to play tracks on an audio CD (CD-DA/MP3) at random.

1. During playback, use the ▲▼◀▶ buttons to select  in the lower left corner of the screen, and then press the  button.
2. Use the ▲▼ to set the Shuffle mode **Off** or **On**, and then press the  button.

Creating a Playlist from a CD







1. With the Playback screen displayed, select the **Options** button and then press the  button. The Options menu appears.
2. Use the ▲▼ buttons to select **Play Selected**, and then press the  button. The Play Selected screen appears.
3. Use the ▲▼ buttons to select a track, and then press the  button. A check appears to the left of the track.
4. Repeat Step 3 to select and check additional tracks.
5. To remove a track from the list, move to the track, and then press the  button again. The check on the track is removed.
6. When done, press the ▲▼ buttons to select **Play**, and then press the  button. The Music Playback screen reappears listing only the tracks you checked. The selected tracks play automatically.

| NOTES |



- ▶ You can create a playlist with up to 99 tracks from Audio CDs (CD-DA).
- ▶ If you have created a playlist, **Play Selected** is replaced by **Edit Playlist** on the Options menu.
- ▶ On the Play Selected screen, you can also choose **Select All**, **Deselect All**, and **Cancel**.
 - Use **Select All** to select all tracks. This cancels your individual track selections. When you press the **RETURN** button on your remote or select **Play** and then press the  button, all tracks will appear on the Music Playback screen, and the product will begin to play all tracks from Track 001.

- Use **Deselect All** to deselect all selected tracks at once. Then, select individual tracks or use **Select All** to select all the tracks, and then press the **RETURN** button on your remote or select **Play** and then press the  button. If you do not use **Select All** or select individual tracks, the Playlist will not change.
- **Cancel** cancels any changes you made on the Play Select screen. When you return to the Playback screen, the Playlist will be unchanged.

Ripping

1. Insert a USB device into the USB jack on the front of the product.
2. With the Playback screen displayed, select the **Options** button and then press the  button. The Options menu appears.
3. Use the ▲▼ buttons to select **Ripping**, and then press the  button. The Ripping screen appears.
4. Use the ▲▼ buttons to select a track, and then press the  button. A check appears to the left of the track.
5. Repeat Step 4 to select and check additional tracks.
6. To remove a track from the list, move to the track, and then press the  button again. The check on the track is removed.
7. When done, select the **Rip** button using the ▲▼ buttons, and then press the  button. The Rip pop-up appears.
8. Use the ▲▼ buttons to select the device to store the ripped files on, and then press the  button.

| NOTES |

- ▶ Do not disconnect the device while ripping is in progress.
- 9. If you want to cancel ripping, press the  button and then select **Yes**. Select **No** to continue ripping.
- 10. When ripping is complete, the "Successfully Ripped." message appears. Press the  button.
- 11. Press the **RETURN** button to go back to the Playback screen.

| NOTES |

- ▶ This function is not available with DTS Audio CDs.
- ▶ This function may not be supported by some discs.
- ▶ Ripping encodes music to the .mp3 format at 192kbps.
- ▶ On the Ripping screen, you can also choose **Select All** or **Clear All**.
 - Use **Select All** to select all tracks and press the  button. This cancels your individual track selections.
 - Use **Clear All** to deselect all selected tracks at once.

Using Bluetooth

You can use a Bluetooth device to enjoy music with high quality stereo sound, all without wires!

What is Bluetooth?

Bluetooth is a technology that enables Bluetooth-compliant devices to interconnect with each other easily using a short wireless connection.

- A Bluetooth device may hum or malfunction:
 - When a part of your body is in contact with the receiving/transmitting system of the Bluetooth device or the Home Theater.
 - When it is subject to electrical variation from obstructions caused by a wall, corner or office partitioning.
 - When it is exposed to electrical interference from same frequency-band devices including medical equipment, microwave ovens, and wireless LANs.
- Pair the Home Theater with the Bluetooth device while the two are close together.
- The further the distance is between the Home Theater and the Bluetooth device, the worse the quality is. If the distance exceeds the Bluetooth operational range, the connection is lost.
- In poor reception-sensitivity areas, the Bluetooth connection may not work properly.
- The Home Theater has an effective reception range of up to 32.8 feet in all directions if there are no obstacles. The connection will be automatically cut off if the device is out of this range. Even within this range, the sound quality may be degraded by obstacles such as walls or doors.
- This wireless device may cause electrical interference during its operation.

To connect the Home Theater to a Bluetooth device

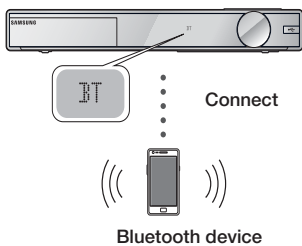

Check if the Bluetooth device supports the Bluetooth compliant stereo headset function.

1. Press the **FUNCTION** button on the remote control of the product to display the **BT** message.
2. Select the Bluetooth menu on the Bluetooth device you want to connect. For instructions, refer to the Bluetooth device's manual.
3. Select the Stereo headset menu on the Bluetooth device.
 - You will see a list of devices.
4. Select "[HTS]Fxxxx" from the searched list.
 - When the Home Theater is connected to the Bluetooth device, the device name of the connected Bluetooth device, followed by the name of home theater will appear on the front display of home theater.
5. Play music on the connected device.
 - You can listen to the music playing on the connected Bluetooth device over the Home Theater system.

| NOTES |

- ▶ The Home Theater only supports Middle Quality SBC data (up to 237kbps@48kHz), and does not support High Quality SBC data (328kbps@44.1kHz).
- ▶ The AVRCP feature is supported. It's functionality will differ, depending on the specifications of the connected device.
- ▶ Connect only to a Bluetooth device that supports the A2DP Profile.
- ▶ Only one Bluetooth device can be paired at a time.
- ▶ The search or connection functions may not work properly in the following cases:
 - If there a strong electric field near or around the home theater.
 - If several Bluetooth devices are simultaneously paired with product.
 - If the Bluetooth device is turned off, not in place, or malfunctions.
 - Note that such devices as microwave ovens, wireless LAN adapters, fluorescent lights, and gas stoves use the same frequency range as the Bluetooth device, and can cause electric interference.

To disconnect the Bluetooth device from the Home Theater

You can disconnect the Bluetooth device from the Home Theater. For instructions, refer to the Bluetooth device's manual.

- When the Home Theater is disconnected from the Bluetooth device, the Home Theater will display **DISCONNECTED** on the front display.

To disconnect the Home Theater from the Bluetooth device

Press the () button on the front panel of the Home Theater to switch from **BT** to another mode or turn off the Home Theater.

- Except when you disconnect the home theater by changing functions, the connected Bluetooth device will wait a certain time for a response from the Home Theater before terminating the connection. (Disconnection time may differ, depending on the Bluetooth device.)

| NOTES |

- ▶ In Bluetooth connection mode, the Bluetooth connection will be lost if the distance between the Home Theater System and the Bluetooth device exceeds 32.8 feet. When the Bluetooth device comes back into effective range or you restart the Bluetooth device, you have to pair the device and home theater again to reconnect.
- ▶ In Bluetooth mode, the screen saver will start if the Bluetooth device stays in the Ready state for 5 minutes. To reconnect the Bluetooth device, turn off the screen saver, and then connect the device. To turn off the screen saver, press any button on the remote control (the Volume button, a number button, etc.)

Using NFC (Near Field Communication)

Using NFC pairing, you can easily connect your home theater to an NFC compatible Bluetooth source device for music listening.

Initial Pairing

To pair NFC devices with your Home Theater, you first must pair the remote control and the Home Theater. Pairing occurs automatically when you press any button on the remote after turning on the Home Theater for the first time. When the pairing is completed, **REMOTE PAIRED** is displayed on the front display within max 20 seconds.

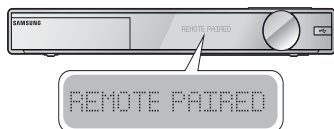

If the pairing is failed, you must re-pair it manually.

To pair NFC devices with your Home Theater again, press and hold the both **PRESET** and **EFFECT** buttons simultaneously for more than 2 second after 35 seconds from power on.



When the re-pairing is completed, **REMOTE PAIRED** is displayed on the front display.



Pairing an NFC Device with the Home Theater

1. Turn on your NFC compatible Bluetooth device and make sure its screen is unlocked.
 - NFC pairing becomes unavailable if the device's screen lock is enabled.
2. Gently touch the  on the home theater remote's rear side with the NFC compatible Bluetooth device.

| NOTES |

- ▶ This pairing feature works only if the home theater is turned on.
- 3. On the NFC compatible Bluetooth device's screen, a message to confirm pairing appears. Select "Yes".
 - Once pairing is complete the "Paired." Message appears.
- 4. To cancel NFC pairing, gently touch the  on the home theater remote's rear side with the device again.
 - To pair another NFC device with the home theater if it is already paired to a device: Gently touch the  on the home theater remote's rear side with the new NFC compatible device. The home theater cancels the existing connection and pairs with the new device.

| NOTES |

- ▶ The NFC feature is available in the Android 4.1x 'Jelly Bean' version or later.
 - This feature is supported by NFC module installed devices with Android v4.1 'Jelly Bean' only.
- ▶ Jelly Bean 4.1.X: Switches to BT mode upon Tagging.
- ▶ Jelly Bean 4.2.X: Switches to BT mode and begins Music playback upon Tagging.
- ▶ The actual location of the NFC antenna varies from device to device. Before connecting, confirm the location of your device's antenna.
- ▶ If the pairing device is covered by or inside a thick case/housing, pairing may not be easy.
- ▶ The  is a trademark or registered trademark of NFC Forum, Inc. in the United States and in other countries.

Playing Photo Contents

You can play photo contents located on a DVD, USB, mobile device, or PC.

Using the Tools Menu

During playback, press the **TOOLS** button.

Previous	Select to move to the previous picture.
Next	Select to move to the next picture.
Start / Stop Slide Show	Select to play/pause the slide show.
Slideshow Settings	<ul style="list-style-type: none"> ▪ Speed : Select to set a slide show's speed. ▪ Effects : Select to set a slide show's special effects.
Zoom	Select to enlarge the current picture. (Enlarge up to 4 times)
Rotate	Select to rotate the picture. (This will rotate the picture either clockwise or counter clockwise.)
Background Music	Select to listen to music while viewing a slide show.
Settings	<ul style="list-style-type: none"> ▪ Picture Mode <ul style="list-style-type: none"> - Dynamic : Choose to increase sharpness. - Standard : Choose for most viewing applications. - Movie : This is the best setting for watching movies. - User : Lets you adjust the sharpness and noise reduction function respectively. ▪ Information : Shows the picture information.
Equalizer Mode	Customize your own personal sound preferences using the equalizer settings.
Equalizer Settings	This function is only available when Equalizer Mode is On .

| NOTES |

- ▶ Depending on the disc or storage device, the Options menu may differ. All options may not be displayed.

- ▶ To enable the background music function, the photo file must be in the same storage media as the music file. However, the sound quality can be affected by the bitrate of the MP3 file, the size of the photo, and the encoding method.
- ▶ You can't enlarge the subtitle and PG graphic in the full screen mode.

Using the View and Options Menus When the Photo File List is Displayed

Photos		
View	Date	Groups all the photo files on the media or storage device by Date. Click a group to see the photos in that group.
	Title	Displays all the photo files on the media or storage device by title.
	Folder	Displays all the folders on the media or storage device.
Options	Slide Show	Starts the slide show. Shows all the files in the current folder, one after another. If you want to create a slide show with a selected group of photos, see Play Selected below.
	Play Selected	Play Selected lets you create a playlist by selecting specific files to play. It works essentially the same way for all media. See Creating a Playlist on an Audio CD on page 37.
	Send	Select Send to upload selected files to on line sites (Picasa, Facebook, etc.) or devices. To use Send, you need to establish an account with the on-line site, and then log in using the Log In function.

| NOTES |

- ▶ Depending on the disc or storage device, the Options menu may differ. All options may not be displayed.

Listening to Radio

Using Buttons on the Remote Control

1. Press the **FUNCTION** button to select **FM**.
2. Tune to the desired station.
 - Preset Tuning 1 : Press the  button to select **Preset** and then press the **TUNING/CH** ($\wedge \vee$) button to select the preset station.
 - Before you can tune to preset stations, you must add preset stations to the product's memory. See Presetting Stations below.
 - Manual Tuning : Press the  button to select **Manual** and then press the **TUNING/CH** ($\wedge \vee$) button to tune to a lower or higher frequency.
 - Automatic Tuning : Press the  button to select **Manual** and then press and hold the **TUNING/CH** ($\wedge \vee$) button to automatically search the band.

Setting Mono/Stereo

Press the **MO/ST** button.

- Each time you press the button, the sound switches between **STEREO** and **MONO**.
- In a poor reception area, select **MONO** for a clear, interference-free broadcast.

Presetting Stations

Example : Presetting FM 89.10 into memory.

1. Press the **FUNCTION** button to select **FM**.
2. Press the **TUNING/CH** ($\wedge \vee$) button to select <89.10>.
3. Press the **TUNER MEMORY** button.
 - **NUMBER** flashes on the display.
4. Press the **TUNER MEMORY** button again.
 - Press the **TUNER MEMORY** button before **NUMBER** disappears from the display on its own.
 - After you press the **TUNER MEMORY** button, **NUMBER** disappears from the display and the station is stored in memory.
5. To preset another station, repeat steps 2 to 4.
 - To tune to a preset station, press the  button to select **Preset** and then press the **TUNING/CH** ($\wedge \vee$) button to select the preset station.

Using the Special Effects Remote Control Buttons

SOUND EFFECT Function	
-----------------------	---

Lets you select a mode that optimizes the sound.

1. Press the **SOUND EFFECT** button.
2. Press the $\blacktriangle \blacktriangledown$ buttons to select the desired mode: **DSP**, **Dolby Pro Logic II**, or **SFE Mode**.
3. Press the $\blacktriangleleft \blacktriangleright$ buttons to select the desired sound effect.

DSP

MP3 Enhancer → **Power Bass** → **Football** → **Off**

- **MP3 Enhancer** : Helps enhance your sound experience (ex. mp3 music). You can upscale your MP3 level sound (24 kHz, 8bit) to CD level sound (44.1 kHz, 16bit).
- **Power Bass** : Increases the volume level of bass tones and provides thudding sound effects.
- **Football** : Creates a more dynamic, realistic, stadium like sound. For listening to football, soccer, and other sporting events.
- **Off** : Select for normal listening.

Dolby Pro Logic II

Movie → **Music** → **Game** → **Matrix** → **Pro Logic** → **Off**

- **Movie** : Adds realism to a movie soundtrack.
- **Music** : When listening to music, you can experience each song or piece as if you are listening to an actual performance.
- **Game** : Enhances the excitement of a game's sound.
- **Matrix** : Select to hear multi channel surround sound.
- **Pro Logic** : Select to listen to a 2CH sound source in 5.1CH surround sound with all speakers active.
 - A specific speaker(s) may not output depending on the input signal.
- **Off** : Select for normal listening.

□ **SFE Mode**

Symphony Hall in Boston (Hall 1) → Philharmonic Hall in Bratislava (Hall 2) → Jazz Club in Seoul B → Church in Seoul → Amphitheater (Rock) → Off

- **Symphony Hall in Boston (Hall 1)** : Provides a clear vocal as if listening in a concert hall.
- **Philharmonic Hall in Bratislava (Hall 2)** : Also provides a clear vocal as if listening in a concert hall, but less powerful than HALL1.
- **Jazz Club in Seoul B** : Recommended setting for Jazz.
- **Church in Seoul** : Gives the feel of being in a grand church.
- **Amphitheater (Rock)** : Recommended setting for Rock.
- **Off** : Select for normal listening.



You can enjoy more natural and vivid surround sound with enriched tones by adjusting the depth of sound using the level options.

Off → High → Low

| NOTES |

- ▶ 3D Sound is not available in **FM** mode.



If you have a TV that supports Anynet+ (HDMI-CEC), the **TV SOUND** button lets you direct the TV's audio to the Home Theater Speakers or the TV Speakers. To use, follow these steps:

1. Connect an HDMI cable to the TV and home theater. (See page 18.)
2. Set **Anynet+ (HDMI-CEC) On** in the home theater and TV.
3. Press the **TV SOUND** button on the remote control. **TV SOUND ON** flashes on the display on the front panel, and then changes to **D. IN.**
 - When TV SOUND is on, TV audio outputs through the Home Theater speakers.
4. Press the **TV SOUND** button again to turn TV SOUND off.
 - When TV SOUND is off, TV audio outputs through the speakers of the connected Anynet+ TV.

□ **Use TV SOUND:**

- 1) When you want to listen to the TV's audio through the home theater speakers.
- 2) When you want to listen to the audio from a USB device plugged into the TV through the home theater speakers.

□ **TV SOUND ON/OFF support specifications:**

Connected TV	Anynet+ (HDMI-CEC) Setting	TV Sound ON	TV Sound OFF
Anynet+ (HDMI-CEC) supported TV	ON	O	O
	OFF	O	X
Anynet+ (HDMI-CEC) not supported TV	No operation	O	X

Network Services

You can enjoy various network services such as streaming video or on-line apps by connecting the product to your network.







To use network services, you must first:

1. Connect the product to the network.
(See page 19)
2. Configure the network settings.
(See pages 25-27)



Logging In to Your Samsung Account

Before you access Movies & TV Shows or Apps, we suggest you log in to your Samsung account.

To log in to your Samsung account, follow these steps:

1. With the Home screen displayed, press the **RED (A)** button. The Log In screen appears.
2. Select the **Email** field, and then press the  button. The keyboard pop-up appears.
3. Using the keyboard, enter your e-mail address. When finished, select the **Done** button, and then press the  button. The Log In screen re-appears.
4. Select the **Password** field, and then press the  button. The keyboard pop-up appears.
5. Using the keyboard, enter your password. When finished, select the **Done** button, and then press the  button. The Log In screen re-appears.
6. To make the log in process easier next time, select **Sign me in automatically**, and then press the  button.
7. Select **Log In**, and then press the  button. The product logs you in to your account. Your account e-mail is displayed on the bottom left of the screen.





| NOTES |

- ▶ If you selected **Sign me in automatically**, the next time you log in, the product will automatically enter your e-mail and password. All you need to do is select Log In.
- ▶ If your e-mail address and password are not displayed when the Log In screen appears, select the button with the down pointing arrow head next to the Email field, and then press the  button. A drop down list of all your registered accounts will appear. Select your account, and then press the  button. The product will fill in the e-mail and password fields.

- ▶ If you press the **RED (A)** button after you have logged in, the My Account pop-up appears. On the pop-up, you can select Logout, Change Account Information, Link Service Accounts, Remove Accounts from the Device, and Deactivate Account.
- ▶ To rent movies and purchase for pay apps, you must have a credit card registered in your account. If you haven't registered a card, select Change Account Information. On the Change Account information page, select **Register Card**, press the  button, and then follow the directions on the screen.

Before Using Movies & TV Shows or Apps

If you haven't set up Smart Hub, when you use Movies & TV Show or Apps for the first time, the product will ask you to perform the Smart Hub set up procedure.

1. On the Home screen, select either **Movies & TV Shows** or **Apps**, and then press the  button. If you have selected **Apps**, go to Step 4.
2. If you selected **Movies & TV Shows**, the Smart Hub pop-up appears asking if you want to set up Smart Hub. Select **Yes**, and then press the  button. The Welcome screen appears.
3. Select **Start**, and then press the  button. The Smart Hub Terms & Conditions, Privacy Policy screen appears.
4. On the Smart Hub Terms & Conditions, Privacy Policy screen, you must review and agree to both the Smart Hub Terms and Conditions and the Privacy Policy to use Smart Hub.
5. Scroll down, and then click the View Details buttons to review the full documents.
6. When done reading, scroll up to the first entry field, and press the  button to agree to the Terms and Conditions and consent to the Privacy Policy.
7. Press the **▶** button twice to go to the Supplemental Privacy Notices screen.
8. Click the View Details button to view the entire notice.
9. When done reading, scroll up to the top entry field, and then press the  button.

| NOTES |



- ▶ You do not need to consent to the Supplemental Privacy Notice, but one or more Smart TV features or functionalities may not be available if you do not.
- 10. Press the **▶** button twice. The Setup Complete screen appears. Press the  button.

Network Services

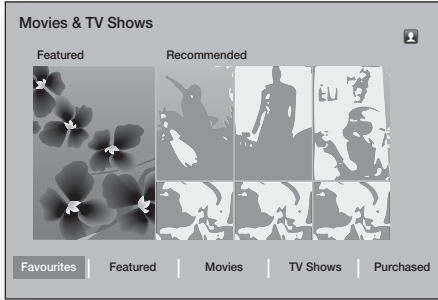

Using Movies & TV Shows





You can download or stream for pay and free-of-charge movies and TV shows and view them on your TV.











1. On the Home screen, select **Movies & TV Shows**, and then press the  button.
2. Select one of the **Featured** or **Recommended** movies, and then press the  button. The page for that movie appears.



OR

Use the  button to go to the bottom of the screen. Select **Favorites**, **Featured**, **Movies**, **TV Shows**, or **Purchased**, and then press the  button.

On the page that appears, use the     buttons to select a show or movie, and then press the  button.

On the TV Shows or Movies screen, you can also select **What's New**, **Most Popular**, or **Genres** to see more available shows or movies. On the Genre screen, use the     buttons to select a **Genre**, and then press the  button.

To make a selection on a page displaying TV shows or movies, use the     buttons to make a selection, and then press the  button.

3. To watch a selection, select **Watch now**, and then press the  button. A selection screen appears listing various locations from which you can rent the film along with prices.
4. Select a location, and then press the  button. Follow the directions on the screen to start the movie.

| NOTES |

- ▶ If you haven't logged into your Samsung account, the Log in screen will appear after Step 3 and you will need to log in.





- ▶ If you don't have a credit card associated with your Samsung account, after you log in, the Register Card screen will appear. Follow the directions on the screen. You must have a credit card registered to your account to rent movies and to purchase for-pay apps.

Using Apps

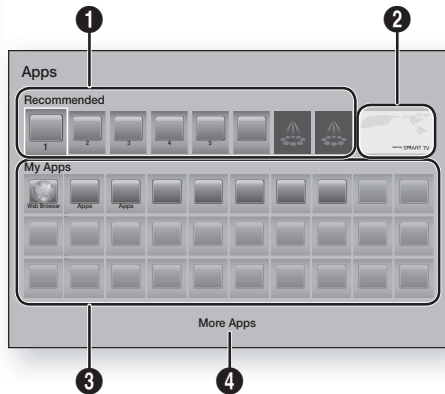
You can access and download various for-pay and free-of-charge applications from the Internet and view them on your TV. To access some applications, you need to have a Samsung account.

The Apps Screen at a Glance



1	Recommended : Displays recommended contents managed by Samsung. Gives you access to various for pay or free-of-charge applications you can download.
2	Featured Applications : Use the     buttons to highlight the displayed Feature Application, and then press the  button. Information about the featured application appears.
3	My Apps : Displays your personal gallery of applications modifiable on the More Apps screen.
4	More Apps : Select More Apps to access the More Apps screen where you can add to, modify, and delete applications and see all downloaded applications.

Downloading Applications

You can download for pay or free-of-charge applications through Samsung Apps.

1. On the Apps screen, select **Samsung Apps**, and then press the **OK** button. The Samsung Apps screen appears.
2. Across the top of the screen, under **What's New**, you'll see a series of new apps. Use the **◀▶** buttons to scroll the list right or left, and then select an app. Press the **OK** button to see more information about the app. If the app is free, select **Download**, and then press the **OK** button to download the app. If it is a for-pay app select **Buy**, press the **OK** button, and then follow the instructions on the screen.

| NOTES |

- ▶ To buy an app, you must be logged into your Samsung account and have a credit card registered to the account. Press the **RED (A)** button on your remote to log in.
 - ▶ If you haven't registered a card, after you log in, press the **RED (A)** button again, and then select Change Account Information in the pop-up that appears. On the Change Account information page, select Register Card, press the **OK** button, and then follow the directions on the screen.
 - ▶ You can also access and download apps from the categories listed on the left of the screen. For instructions, see Step 4.
3. After the app has downloaded, select **Run**, and then press the **OK** button to run the app now. To run the app later, press the **RETURN** button. In either case, the icon for the app will appear on the Apps screen.
 4. To see additional apps, use the **▲▼◀▶** buttons to move to the category list on the left side of the screen.
 5. Use the **▲▼** buttons to select a category. Each time you move the highlight to another category, a different set of applications appears on the right.
 6. Use the **▶** button to move to the applications and the **▲▼◀▶** buttons to move from app to app.
 7. To see more information about an app, select it, and then press the **OK** button.
 8. To download the app, follow the directions in Steps 2 and 3.

Starting an Application

1. Select **Apps** on the Home screen, and then press the **OK** button.
2. On the Apps screen, use the **▲▼◀▶** buttons to select an app, and then press the **OK** button. The app starts.

Using the More Apps Screen

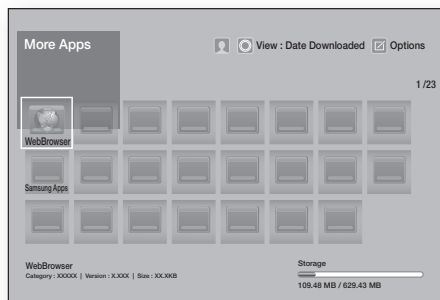

The More Apps Screen lists all the apps you have downloaded and lets you:

- Sort the apps on the More Apps screen by **Date Downloaded**, **Recently Opened**, and **Title**.
- Apply a number of Options Menu functions to the apps listed in the My Apps section of the Apps screen including updating apps, moving apps into a folder, deleting the apps from My Apps, and locking the apps.
- Start apps.

Sorting the Apps

To sort the apps on the More Apps screen, follow these steps:









1. On the Home screen, select **Apps**, and then press the **OK** button.
2. On the Apps screen, use the **▼** button to move to the More Apps hotspot at the bottom of the page, and then press the **OK** button.
3. On the More Apps screen, use the **▶▶** buttons to move to **View** at the top of the screen, and then press the **OK** button.
4. In the drop down that appears, select **Date Downloaded**, **Recently Opened**, or **Title**, and then press the **OK** button. The apps on the More Apps screen are sorted by the criteria you have chosen.

Using the Options Menu Functions

Lock / Unlock

Using the Lock / Unlock function and the Security PIN, you can lock applications so they cannot be started on either the Apps screen or the More Apps screen. The default PIN is 0000.



Network Services

1. On the More Apps screen, use the ▲► buttons to go to **Options** at the top of the screen, and then press the  button.
 2. Select **Lock / Unlock**, and then press the  button.
 3. When the Lock Service appears, enter the PIN using the number buttons on your remote control.
 4. To lock an application, select the application, and then press the  button. A lock appears on the app. Repeat to lock other, individual apps.
 5. To unlock a locked app, select the application, and then press the  button.
 6. To lock all the apps at once, use the ▲► buttons to select the **Lock All** button, and then press the  button.
 7. To unlock all the locked apps at once, use the ▲► buttons to select the **Unlock All** button and then press the  button.
 8. Press the **RETURN** button twice to return to the Apps screen. Locked apps will display a lock on the upper right side.
3. Select the app you want to delete from My Apps, press the  button, and then press the ▲▼◀▶ buttons in the direction of the **X**. The Remove from My Apps pop-up appears.
 4. Select **Yes**, and then press the  button.
 5. When you return to the Apps screen, the app will have been removed from the My Apps area.

Edit My Apps

Edit My Apps lets you add apps to and delete apps from My Apps. It also lets you change the position of an app in My Apps.



Add an App to My Apps

1. On the More Apps screen, use the ▲► buttons to go to **Options** at the top of the screen, and then press the  button.
2. Select **Edit My Apps**, and then press the  button. The Edit My Apps screen appears.
3. Select a full color app from the top row of apps, and then press the  button. The full color app icon appears in the My Apps area below and the app icon in the top row is grayed out.



| NOTES |

- Grayed out apps are already in My Apps.
4. When you return to the Apps screen, the app will appear in the My Apps area.

Delete an App from My Apps





1. On the More Apps screen, use the ▲► buttons to go to **Options** at the top of the screen, and then press the  button.
2. Select **Edit My Apps**, and then press the  button. The Edit My Apps screen appears.

Move an App in My Apps

1. On the More Apps screen, use the ▲► buttons to go to **Options** at the top of the screen, and then press the  button.
2. Select **Edit My Apps**, and then press the  button. The Edit My Apps screen appears.
3. Select the app you want to move in My Apps, press the  button, and then press the ▲▼◀▶ buttons to move the app icon in the direction of one of the arrows (<, >, ^, etc.) that appears around the app icon. The app icon moves in the direction you have chosen.
4. After you have placed the app icon where you want, press the  button.
5. When you return to the Apps screen, the app will be positioned in the location you had selected.





Create Folder

Create Folder lets you create a folder on the More Apps screen into which you can put apps.







1. On the More Apps screen, use the ▲► buttons to go to **Options** at the top of the screen, and then press the  button.
2. Select **Create Folder**, and then press the  button. The Set Folder Name pop-up appears.
3. Press the  button. The keyboard appears.
4. Select the **Clear** button on the right side, and then press the  button to remove Folder 1 from the entry field. Then, using the keyboard, enter the name you want to apply to the folder.
5. When finished, select the **Done** button on the right side, and then press the  button. The pop-up reappears.
6. Select **OK**, and then press the  button. The new folder appears in the list of apps on the left side of the screen.

Move to Folder

Move to Folder lets you move apps to the folder of your choice.





1. On the More Apps screen, use the ▲► buttons to go to **Options** at the top of the screen, and then press the  button.
2. Select **Move to Folder**, and then press the  button. The Move to Folder screen appears.
3. Use the ▲▼◀► buttons to move to an app, and then press the  button to select the app. A check appears in the upper left corner of the app.
4. To deselect an app, press the  button. The check disappears.
5. Repeat Step 3 to select additional apps.



| NOTES |

- To select all the downloaded apps, select **Select All** at the top right of the screen, and then press the  button. To deselect all the apps, select **Deselect All** at the top right of the screen, and then press the  button.
6. When done, select **Select folder** at the top of the screen, and then press the  button. The Select folder pop-up appears.
 7. In the Select folder pop-up, use the ▲▼ buttons to select the folder you want to move the apps you selected to, and then press the  button.
 8. The Apps Moved pop up appears. Press the  button.
 9. To open the folder, use the ▲▼◀► buttons to highlight the folder, and then press the  button.

Rename Folder





Rename Folder lets you rename an existing folder.

1. On the More Apps screen, use the ▲► buttons to go to **Options** at the top of the screen, and then press the  button.
2. Select **Rename Folder**, and then press the  button. The Rename Folder screen appears, and a folder is highlighted.
3. Use the ▲▼◀► buttons to highlight a folder of your choice, and then press the  button. The Rename pop-up appears.
4. Press the  button. The keyboard appears.
5. Enter the new name for the folder. When finished, select **Done** on the right side, and then press the  button. The Rename popup reappears displaying the new name.





6. Select **OK**, and then press the  button. The folder is renamed.
7. Select **Close** on the right side of the screen, and then press the  button.

Delete

Delete lets you delete apps and folders from the My Apps screen. If there are apps in a folder, both the folder and the apps are deleted together. Delete removes apps permanently. If you decide you want to use an app you deleted, you will need to download it again.

1. On the More Apps screen, use the ▲► buttons to go to **Options** at the top of the screen, and then press the  button.
2. Select **Delete**, and then press the  button. The Delete screen appears.
3. Use the ▲▼◀► buttons to move to an app, or folder and then press the  button to select. A check appears in the upper left corner of the app or folder you selected.
4. To deselect an app, press the  button. The check disappears.
5. Repeat Step 3 to select additional apps or folders.

| NOTES |

- To select all the downloaded apps, select **Select All** at the top right of the screen, and then press the  button. To deselect all the apps, select **Deselect All** at the top right of the screen, and then press the  button.
6. After you have made all your selections, select **Delete** at the top of the screen, and then press the  button. The deleting pop-up appears.
 7. Select **Yes**, and then press the  button. All the apps you selected are deleted.

| NOTES |

- You cannot immediately delete a locked app or folder. If you select a locked app or folder to delete, when you perform Step 7, the Lock Service pop-up appears. Enter the Security PIN into the pop-up, and then press the  button. The lock will be released and the app or folder will be deleted.

Update Apps

When the application require to update to the latest version, select **Apps** and then select **More Apps**. On the More Apps screen, select **Apps to update**, and then select application from the list. The application starts updating to the latest version. However, **Apps to update** appears on the screen only when the update is required.

Screen Mirroring

The Screen Mirroring function lets you view the screen of your smart phone or smart device on the TV you have connected to the home theater system.

1. With the Blu-ray's Home screen displayed, press the **BLUE (D)** button on the remote. The Screen Mirroring screen appears.
2. Launch AllShare Cast on your device.
3. On your device, find the name of the home theater system in the list of available devices and then select it.
4. The TV displays a connecting message (for example, Connecting to Android_92gb...) and then displays the connected message.
5. In a few moments, the screen of your device appears on the TV screen.

| NOTES |

- ▶ When you are using the Screen Mirroring function, video stuttering or audio dropouts may occur, depending on your environment.
- ▶ The Home Theater can connect to devices that support AllShare Cast. Note that all devices that have AllShare Cast may not be fully supported, depending on the manufacturer. For further information on mobile connection support, refer to the manufacturer's web site.
- ▶ Bluetooth transmissions can interfere with the Screen Mirroring signal. Before using the Screen Mirroring function, we strongly recommend that you turn off the Bluetooth function on your smart phone or smart device.

Using the Web Browser

You can access the Internet using the Web Browser application.

Select **Web Browser** on the Home screen, and then press the  button.

| NOTES |

- ▶ When you run the Web Browser with the product connected by HDMI to a BD Wise compatible TV - and BD Wise is on - the browser is maximized to fill the screen and the TV's resolution is set to the optimal resolution automatically.
- ▶ The Web Browser is not compatible with Java applications.
- ▶ If you attempt to download a file, and the file cannot be saved, an error message will appear.
- ▶ E-commerce (purchasing products online) is not supported.
- ▶ ActiveX is not supported.
- ▶ Access may be blocked to some websites or to web browsers operated by certain businesses.

Link Browsing and Pointer Browsing

The Web Browser provides two types of browsing, Pointer Browsing and Link Browsing. When you launch the browser for the first time, Pointer Browsing is active. If you are using a mouse to navigate in the Web Browser, we recommend leaving Pointer Browsing active. If you are using your remote to navigate in the Web Browser, we recommend that you replace Pointer Browsing with Link Browsing. Link Browsing moves a highlight from one link to the next in the Web Browser and is much faster than Pointer Browsing if you are using your remote.

To activate Link Browsing, follow these steps:

1. Use the **▲▼◀▶** buttons on your remote to move the pointer to the Link Browser icon on the top right of the screen. The Link Browser icon is the third icon from the right.
The pointer will be in the correct position if the icon turns blue and the words "Link Browsing" appear on the screen.
2. Press the  button. Link Browsing is activated and will remain active whenever you bring up the Web Browser.

The Control Panel at a Glance

The Control Panel, which runs across the top of the screen, has a series of icons which start a number of useful functions. The icons are described below, starting with the icon on the far left of the screen.

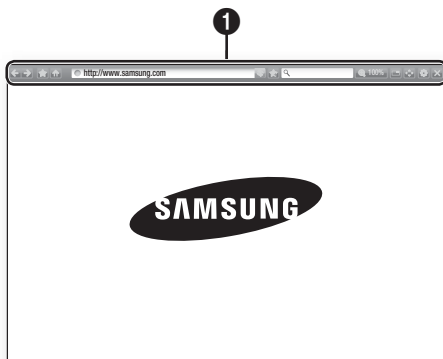

- : Moves to the previous page.
- : Moves to the next web page.
- : Displays the Bookmarks and History screen. You can bookmark the current page, select an existing bookmark, and edit and delete bookmarks. You can also view your browsing history and select a page to revisit.
- : Moves to the Home screen of the Web Browser.
- : Lets you enter a page address manually using the keyboard pop-up.
- : Reloads the current page so that it is refreshed on the screen.
- : Adds the current page to your bookmarks.
- : Lets you search for information by entering words or characters using the keyboard pop-up. See Using the Keyboard Popup on this page.
- : Lets you enlarge or shrink the screen by various percentages.
- : Turns on the PIP function.
- : Lets you switch between Pointer Browsing and Link Browsing.
- : Lets you configure the Browser's settings. See Using the Setting Menu on page 50.
- : Closes the Web Browser.

Using the Keyboard Pop-up

When you click the <http://www.samsung.com>, the or access a data or text entry field, and then press the button, the keyboard pop-up appears.

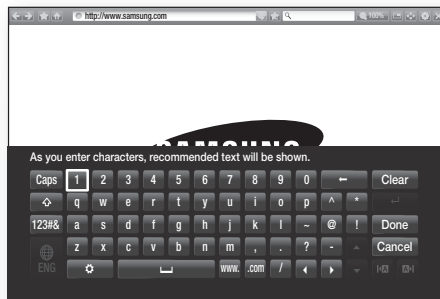

To use the keyboard pop-up with your remote, follow these steps:



1. Use the buttons on your remote to move the highlight to a letter or number of your choice.
2. Press the button to enter the letter or number into the entry field.
3. To access capital letters, move the highlight to the **Caps** key on the top left, and then press the button. Press the button again with the **Caps** key highlighted to access small letters again.
4. To access symbols and additional punctuation marks, highlight the **123#&** button on the left, and then press the button.
5. To delete a character you entered, move the highlight to the button, and then press the button.
6. To delete all the characters you entered, move the highlight to the **Clear** button, and then press the button.
7. When finished entering, move the highlight to the **Done** button, and then press the button.

| NOTES |

- ▶ If you have a wireless keyboard connected to your product, you can use the wireless keyboard to enter letters, numbers, symbols, and punctuation. Note that the wireless keyboard will work only when the keyboard popup appears and can only be used to enter letters, numbers, symbols, and punctuation.

Network Services

Options on the Keyboard Pop-Up

To access the keyboard pop-up options, highlight the  button on the bottom left of the keyboard, and then press the  button.

Language	Select the language for the keyboard. You can select English, French, Russian, etc.
Recommended Text	The keyboard will suggest recommended words as you enter text. You can turn this function On or Off.
Predict Next Letter	The keyboard will predict the next letter as you enter letters. The predictions appear in a ring around the letter you have just entered. You can select a predicted letter or move to another letter. You can turn this function On or Off.

Using the Setting Menu

The Setting menu contains functions that control how the Browser operates and Browser security functions. To open the Setting menu, highlight the  icon in the Control Panel, and then press the  button. To select an option in the setting menu, highlight the option, and then press the  button.

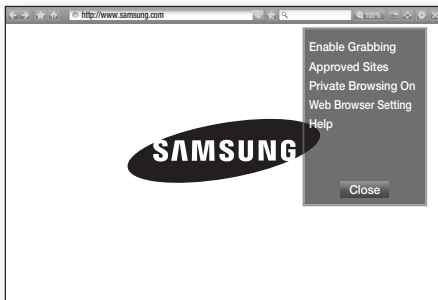

Enable/Disable Grabbing	Turns the Grabber function On and Off . When the Grabber function is on, you can move a web page up and down without dragging the scroll bar. The Grabber function is only available in Pointer Browsing.
--------------------------------	--

Approved Sites

Lets you restrict your children's access to inappropriate web pages by allowing access only to the web sites you have registered.

Every time you access **Approved Sites**, the PIN screen appears. The first time you access **Approved Sites**, enter the default PIN, 0000 using the number buttons on your remote.

You can change the PIN using the Reset password for the Approved Sites function. See below.

- **Approved Sites feature** : Turns the Approved Sites function on or off.
- **Reset password for Approved Sites** : Change the Approved Sites password.
- **Add current site** : Lets you add the currently displayed web site to the Approved Sites list.
- **Manage Approved Sites** : Lets you key in URLs to add to the Approved Sites List and delete sites from the Approved Sites list. If you turn **Approved Sites** on and have not added any sites to the Approved Sites list, you will not be able to access any Internet sites.

Private Browsing On/off

Enable or disable the Privacy mode. When the Privacy mode is enabled, the browser does not retain the URLs of sites you visit. If you want to enable Privacy mode, select **OK**. If the Privacy mode is running, the "Stop" icon appears in front of the URL at the top of the screen. To disable Privacy mode, select it again when Privacy mode is enabled.

<p style="text-align: center;">Web Browser Setting</p>	<ul style="list-style-type: none"> ▪ Set as homepage : You can set the Browser's home page. ▪ Pop-up Block : Turns the Pop-up Block on and off. ▪ Page Block : You can determine whether to block advertisements and select the URLs for which advertisements are blocked. ▪ General : You can delete personal information such as website history and browsing data (cookies, etc.), and reset all web browser settings to their factory defaults. ▪ Encoding : You can set the Encoding setting for web pages to Automatic or select the encoding format manually from a list. ▪ Pointer : You can set the speed of the cursor when the cursor is set to Pointer and turn Smart Cursor On and Off. ▪ Browser Information : Displays the version number and copyright information for the Web Browser.
<p style="text-align: center;">Help</p>	<p>Provides basic information about the operation of the Web Browser.</p>



| NOTES |





- ▶ Depending on the web site, some of the Web Browser Setting functions may not be activated. Functions that are not activated are greyed out and cannot be used.

Linking your Internet Service Accounts to the Product

The Link Service Accounts function lets you link your product to your accounts with Internet services such as Pandora so that the product can log you in to the service automatically when you start the app for that service.







To create a service account link, follow these steps:

1. On the Home screen, press the **RED (A)** button on your remote to log in to your Samsung Account.
2. After you have logged in, press the **RED (A)** button on your remote again.
3. Select **Link Service Accounts** in the My Account pop-up, and then press the  button.
4. On the Link Service Accounts screen, select the service you want to link to the product, and then press the  button.

5. Select **Register**, and then press the  button.
6. In the ID and Password screen, enter the ID you use to log in to the service you selected using the pop-up keyboard. When finished, select **Done**, and then press the  button.
7. Repeat the same process for the password. When finished select **Done**, and then press the  button.
8. Select **OK**, and then press the  button.

BD-LIVE™

Once the product is connected to your network, you can enjoy various movie-related service contents available on BD-LIVE compliant discs.

1. Attach a USB flash drive to the USB jack on the front of the product, and then check its remaining memory. The memory device must have at least 1GB of free space to accommodate the BD-LIVE services.
2. Select **Settings** on the Home screen, and then press the  button.
3. Select **Network**, and then press the  button.
4. Select **BD-Live Settings**, and then press the  button.
5. Select **BD Data Management**, and then press the  button.
6. Select **Select Device**, and then press the  button.
7. Select USB device, and then press the  button.
8. Insert a Blu-ray Disc that supports BD-LIVE.
9. Select an item from the list of BD-LIVE service contents provided by the disc manufacturer.

| NOTES |

- ▶ The way you use BD-LIVE and the provided contents may differ, depending on the disc manufacturer.

Additional Information

Notes



Connections

HDMI OUT

- Certain HDMI output resolutions may not work, depending on your TV.
- You must have a HDMI connection to enjoy videos with 3D technology.
- A long HDMI cable may cause screen noise. If this occurs, set **HDMI Deep Color** to **Off** in the menu.

Settings

3D Settings

- For some 3D discs, to stop a movie during 3D playback, press the  button once. The movie stops and the 3D mode option is de-activated. To change a 3D option selection when you are playing a 3D movie, press the  button once. The Blu-ray menu appears. Press the  button again, then select 3D Settings in the Blu-ray menu.
- Depending on the content and the position of the picture on your TV screen, you may see vertical black bars on the left side, right side, or both sides.

TV Aspect Ratio

- Depending on the disc type, some aspect ratios may not be available.
- If you select an aspect ratio and option which is different than the aspect ratio of your TV screen, the picture might appear to be distorted.
- If you select **16:9 Original**, your TV may display **4:3 Pillarbox** (black bars on sides of picture).

BD Wise (Samsung Products only)

- When BD Wise is on, the Resolution setting automatically defaults to BD Wise and BD Wise appears in the Resolution menu.
- If the product is connected to a device that does not support BD Wise, you can not use the BD Wise function.
- For proper operation of BD Wise, set the BD Wise option in both the product and the TV to On.

Digital Output

- Be sure to select the correct Digital Output or you will hear no sound or just loud noise.
- If the HDMI device (AV receiver, TV) is not compatible with compressed formats (Dolby Digital, DTS), the audio signal outputs as PCM.
- Regular DVDs do not have BONUSVIEW audio and Navigation Sound Effects.
- Some Blu-ray Discs do not have BONUSVIEW audio and Navigation Sound Effects.
- This Digital Output setup does not affect the analog (L/R) audio or HDMI audio output to your TV. It affects the optical and HDMI audio output when your product is connected to an AV receiver.
- If you play MPEG audio soundtracks, the audio signal outputs as PCM regardless of your Digital Output selections (PCM or Bitstream).
- Digital Output can be activated when **Speaker Selection** is set to **TV Speaker**.

BD-Live Internet Connection

- The Internet connection may be restricted while you are using BD-LIVE contents.

Anynet+ (HDMI-CEC)

- Depending on your TV, certain HDMI output resolutions may not work. Please refer to the user manual of your TV.
- This function is not available if the HDMI cable does not support CEC.
- If your Samsung TV has an Anynet+ logo, then it supports the Anynet+ function.

BD Data Management

- In the external memory mode, disc playback may be stopped if you disconnect the USB device in the middle of playback.
- Only those USB devices formatted in the FAT file system (DOS 8.3 volume label) are supported. We recommend you use USB devices that support the USB 2.0 protocol with 4 MB/sec or faster read/write speeds.
- The Resume Play function may not work after you format the storage device.
- The total memory available to BD Data Management may differ, depending on conditions.

Front Display

- You cannot change the brightness of the  button and the **VOL +, -** button.

Speaker Settings

- When **Speaker Selection** is set to **TV Speaker**, audio is produced through the TV speakers.
- Running the Auto Sound Calibration function takes about 3 minutes.
- Make sure there is no disc in the product when you run the Auto Sound Calibration function.
- If the ASC microphone is disconnected during the Auto Sound Calibration setup, the setup will be cancelled.
- When the Auto Sound Calibration function is activated, the DSP, Dolby Pro Logic II and SFE Mode will not work.
- If the product is connected to external devices or other components (such as an AUX, D. IN), the Auto Sound Calibration Setup may not work properly.

HDMI audio

- When HDMI audio is output to the TV speakers, it is automatically down-mixed to 2 channels.

Audio Return Channel

- When Anynet+ (HDMI-CEC) is Off, the Audio Return Channel function is not available.
- Using an HDMI cable not certified for ARC (Audio Return Channel) may cause a compatibility problem.
- The ARC function is only available if an ARC-compliant TV is connected.

Playback

Playing Video files

- Video files with high bitrates of 20Mbps or more strain the product's capabilities and may stop playing during playback.

Selecting the Audio Language

- The ◀▶ indicator will not appear on the screen if the BONUSVIEW section does not contain any BONUSVIEW audio settings.
- The languages available through the Audio Language function depend on the languages that are encoded on the disc. This function or certain languages may not be available.
- Some Blu-ray Discs may allow you to select either the PCM or Dolby Digital audio English soundtrack.

Selecting the Subtitle Language

- Depending on the Blu-ray Disc / DVD, you may be able to change the subtitle language in the Disc Menu. Press the **DISC MENU** button.
- This function depends on the selection of subtitles that are encoded on the disc and may not be available on all Blu-ray Discs/DVDs.
- Information about the main feature BONUSVIEW mode will also appear if the Blu-ray Disc has a BONUSVIEW section.
- This function changes both the primary and secondary subtitles at the same time.
- The total number of primary and secondary subtitles are displayed respectively.

Playing JPEG files

- You can't enlarge the subtitle and PG graphic in the full screen mode.

Media Play

Dolby Pro Logic II Mode

- Before selecting Dolby Pro Logic II mode, connect your external device to the AUDIO INPUT jacks (L and R) on the product. If you connect to only one of the inputs (L or R), you cannot listen to surround sound.

Using the TOOLS button while playing pictures

- If the home theater is connected to a BD Wise compliant TV that has BD Wise On, the Picture Settings menu will not appear.
- The Background Music function will not work unless the music file and the photo file are located on the same storage media. Also, sound quality can be impacted by the bitrate of the MP3 music file, the size of the photos, and the encoding method.

Digital Output Selections

Setup		PCM	Bitstream (Unprocessed)	Bitstream (Re-encoded DTS)	Bitstream (Re-encoded Dolby D)
Connection		HDMI supported AV receiver			
Audio Stream on Blu-ray Disc	PCM	Up to PCM 7.1 ch	PCM	DTS re-encoded	Re-encoded Dolby Digital *
	Dolby Digital	Up to PCM 5.1 ch	Dolby Digital	DTS re-encoded	Re-encoded Dolby Digital *
	Dolby Digital Plus	Up to PCM 7.1 ch	Dolby Digital Plus	DTS re-encoded	Re-encoded Dolby Digital *
	Dolby TrueHD	Up to PCM 7.1 ch	Dolby TrueHD	DTS re-encoded	Re-encoded Dolby Digital *
	DTS	Up to PCM 7.1 ch	DTS	DTS re-encoded	Re-encoded Dolby Digital *
	DTS-HD High Resolution Audio	Up to PCM 7.1 ch	DTS-HD High Resolution Audio	DTS re-encoded	Re-encoded Dolby Digital *
	DTS-HD Master Audio	Up to PCM 7.1 ch	DTS-HD Master Audio	DTS re-encoded	Re-encoded Dolby Digital *
Audio Stream on DVD	PCM	PCM 2ch	PCM 2ch	PCM 2ch	PCM 2ch
	Dolby Digital	Up to PCM 5.1 ch	Dolby Digital	Dolby Digital	Dolby Digital
	DTS	Up to PCM 7.1 ch	DTS	DTS	DTS
Definition for Blu-ray Disc	Any	Decodes the main feature audio and BONUSVIEW audio stream together into PCM audio and adds Navigation Sound Effects.	Outputs only the main feature audio stream so that your AV receiver can decode the audio bitstream. You will not hear BONUSVIEW audio or Navigation Sound Effects.	Decodes the main feature audio and BONUSVIEW audio stream together into PCM audio and adds Navigation Sound Effects, then re-encodes the PCM audio into DTS bitstream.	Decodes the main feature audio and BONUSVIEW audio stream together into PCM audio and adds Navigation Sound Effects, then re-encodes the PCM audio into Dolby Digital bitstream or PCM.

- If the Source Stream is 2ch or mono, "Re-encoded Dolby D" Setting are not applied. Output will be PCM 2ch.

Blu-ray Discs may include three audio streams :

- Main Feature Audio : The audio soundtrack of the main feature.
- BONUSVIEW audio : An additional soundtrack such as the director or actor's commentary.
- Navigation Sound Effects : When you choose some menu navigation options, Navigation Sound Effects may sound. Navigation Sound Effects are different on each Blu-ray Disc.

Resolution according to the content type

Setup		Content Type	Blu-ray Disc	E-contents/ Digital contents
		BD Wise	Resolution of Blu-ray Disc	1080p@60F
Auto	Movie Frame : Auto	UHD Output : Auto	2160p@24F	2160p@24F
		UHD Output : Off	1080p@24F	1080p@24F
		Movie Frame : Off	Max. Resolution of TV input	Max. Resolution of TV input
		Movie Frame : Auto (24Fs) ★ 1080p & 1080i only	1080p@24F	1080p@24F
		1080p	1080p@60F	1080p@60F
		1080i	1080i	1080i
		720p	720p	720p
		480p	480p	480p

Setup		Content Type	DVD
		BD Wise	480i
Auto	Movie Frame : Auto	DVD 24Fs Conversion : Auto	UHD Output : Auto 2160p@24F
			UHD Output : Off 1080p@24F
		DVD 24Fs Conversion : Off	Max. Resolution of TV input
		Movie Frame : Off	Max. Resolution of TV input
		Movie Frame : Auto (DVD 24Fs Conversion : Auto) ★ 1080p & 1080i only	1080p@24F
		1080p	1080p@60F
		1080i	1080i
		720p	720p
		480p	480p

| NOTES |

- ▶ If the TV you connected to the product does not support Movie Frame or the resolution you selected, the message "If no pictures are shown after selecting 'Yes', please wait for 15 seconds to return to the previous resolution. Do you want to change the resolution?" appears. If you select **Yes**, the TV's screen will go to blank for 15 seconds, and then the resolution will revert to the previous resolution automatically.
- ▶ If the screen stays blank after you have changed the resolution, remove all discs, and then press and hold the **□** button on the top of the product for more than 5 seconds. All settings are restored to the factory default. Run the Initial Settings procedure again. Then, go to **Settings > Display > Resolution** in the Menu, and select the correct resolution for your TV.
- ▶ When you run the Initial Settings procedure, re-select the language and aspect ratio (screen size and format) only. Resetting does not affect your network settings, so you should be able to skip Network Setup and Software Update.
- ▶ When the factory default settings are restored, all stored user BD data will be deleted.
- ▶ The Blu-ray Disc must have the 24 frame feature for the product to use the Movie Frame (24Fs) mode.

Troubleshooting

Refer to the table below when this product does not function properly. If the problem you are experiencing is not listed below or if the instructions below do not help, turn off the product, disconnect the power cord, and contact Samsung Electronics at 1-800-SAMSUNG (1-800-726-7864).

Symptom	Check/Remedy
I cannot eject the disc.	<ul style="list-style-type: none"> Is the power cord plugged securely into the outlet? Turn off the power and then turn it back on.
Playback does not start.	<ul style="list-style-type: none"> Check the region number of the Blu-ray/DVD disc. Blu-ray/DVD disc purchased from abroad may not be playable. CD-ROMs and DVD-ROMs cannot be played on this product. Make sure that the rating level is correct.
Playback does not start immediately when the Play/Pause button is pressed.	<ul style="list-style-type: none"> Are you using a deformed disc or a disc with scratches on the surface? Wipe the disc clean.
Sound is not produced.	<ul style="list-style-type: none"> The home theater does not play sound during fast playback, slow playback, and step motion playback. Are the speakers connected properly? Is the speaker setup correctly customized? Is the disc severely damaged?
Sound can be heard only from a few speakers and not all 8.	<ul style="list-style-type: none"> On certain Blu-ray/DVD discs, sound is output from the front speakers only. Check if the speakers are connected properly. Adjust the volume. When playing audio from a CD, the radio, or a TV, the unit outputs sound to the front speakers only.
Dolby Digital 7.1 CH Surround Sound is not produced.	<ul style="list-style-type: none"> Is there "Dolby Digital 7.1 CH" mark on the disc? Dolby Digital 7.1 CH Surround Sound is produced only if the disc is recorded with 7.1 channel sound. Is the audio language correctly set to Dolby Digital 7.1-CH in the information display?
The remote control does not work.	<ul style="list-style-type: none"> Are you operating the remote within its operational range and within the proper angle relative to the sensor? Are the batteries drained? Have you selected the mode (TV/BD) functions of the remote control (TV or BD) correctly?
<ul style="list-style-type: none"> The disc is rotating but no picture is produced. Picture quality is poor and the picture is shaking. 	<ul style="list-style-type: none"> Is the TV power on? Are the video cables connected properly? Is the disc dirty or damaged? A poorly manufactured disc may not be playable.
Audio language and subtitles do not work.	<ul style="list-style-type: none"> Audio language and subtitles will not work if the disc does not contain them.

Symptom	Check/Remedy
The menu screen does not appear even when the menu function is selected.	<ul style="list-style-type: none"> Are you using a disc that does not contain menus?
The aspect ratio cannot be changed.	<ul style="list-style-type: none"> You can play 16:9 Blu-ray/DVD discs in 16:9 Full mode, 4:3 Letter Box mode, or 4:3 Pan-Scan mode, but 4:3 Blu-ray/DVD discs are played in 4:3 ratio only. Refer to the Blu-ray Disc jacket and then select the appropriate function.
<ul style="list-style-type: none"> The product is not working. (Example: The power goes out or a strange noise is heard.) The Product is not working normally. 	<ul style="list-style-type: none"> Press and hold the remote control's ■ button for 5 seconds in STANDBY mode. This will reset the unit. <ul style="list-style-type: none"> Using the RESET function will erase all stored settings. Do not use this function unless necessary.
You have forgotten the rating level password.	<ul style="list-style-type: none"> With no disc in the product, press and hold the product's ■ button for longer than 5 seconds. INIT appears on the display and all settings will return to the default values. Then, press the POWER button. <ul style="list-style-type: none"> Using the RESET function will erase all stored settings. Do not use this function unless necessary.
Can't receive radio broadcasts.	<ul style="list-style-type: none"> Is the antenna connected properly? If the antenna's input signal is weak, install an external FM antenna in an area with good reception.
While listening to TV audio through the Product, no sound is heard.	<ul style="list-style-type: none"> If you press the OPEN/CLOSE ▲ button while listening to TV audio using the D. IN or AUX functions, the Blu-ray/DVD disc functions are turned on and the TV audio is muted.
"Not Available" appears on screen.	<ul style="list-style-type: none"> The features or action cannot be completed at this time because: <ol style="list-style-type: none"> The Blu-ray/DVD disc's software restricts it. The Blu-ray/DVD disc's software doesn't support the feature (e.g., angles) The feature is not available at the moment. You've requested a title or chapter number or search time that is out of range.
If the HDMI output is set to a resolution your TV cannot support (for example, 1080p), you may not see a picture on your TV.	<ul style="list-style-type: none"> Press and hold the ■ button on front panel for more than 5 seconds with no disc in the product. All settings will revert to the factory settings.
No HDMI output.	<ul style="list-style-type: none"> Check the connection between the TV and the HDMI jack of the product. Check if your TV supports 480p/720p/1080i/1080p HDMI input resolution.
Abnormal HDMI output screen.	<ul style="list-style-type: none"> If random noise appears on the screen, it means that TV does not support HDCP (High-bandwidth Digital Content Protection).

Appendix

Symptom	Check/Remedy
AllShare function	
I can see folders shared through AllShare, but I cannot see the files.	<ul style="list-style-type: none">AllShare only shows Video, Photo, and Music files. Other types of files are not displayed.
Video is played intermittently.	<ul style="list-style-type: none">Check if the network is stable.Check if the network cable is properly connected and if the network is overloaded.The wireless connection between the DLNA compatible device and the product is unstable. Check the connection.
The AllShare connection between the product and PC is unstable.	<ul style="list-style-type: none">IP addresses under the same subnetwork should be unique, otherwise IP collision can result in such a phenomenon.Check if you have a firewall enabled. If so, disable the firewall function.
BD-LIVE	
I cannot connect to the BD-LIVE server.	<ul style="list-style-type: none">Test whether the network connection is active by using the Network Status function.Check whether a USB memory device is connected to the product.The memory device must have at least 1GB of free space to accommodate the BD-LIVE service. You can check the available size in BD Data Management. (See page 52)See if the BD-LIVE Internet Connection option is set to Allow(All).If all above fails, contact the contents provider or update to the latest firmware.
When using the BD-LIVE service, an error occurs.	<ul style="list-style-type: none">The USB memory device must have at least 1GB of free space to accommodate the BD-LIVE service. You can check the available size in BD Data Management. (See page 52)

| NOTES |

- ▶ When the factory default settings are restored, all stored user BD data is deleted.

Repairs

If you contact us to repair your product, an administration fee may be charged if either:

1. An engineer is called out to your home at your request and there is no defect in the product.
2. You bring the unit to a repair center and there is no defect in the product.

We will provide you with the amount of the administration fee before we make a home visit or begin any work on your product.

We recommend you read this manually thoroughly, search for a solution on line at www.samsung.com, or contact Samsung Customer Care at 1-800-SAMSUNG (726-7864) before seeking to repair your product.

Specifications

General	Power Requirements	AC 110V-120V ~ 50/60Hz					
	Power Consumption	84.8 W					
	Weight	7.2 lbs					
	Dimensions	16.92 (W) x 2.16 (H) x 12.38 (D) inches					
	Operating Temperature Range	+41°F to +95°F					
	Operating Humidity Range	10 % to 75 %					
FM Tuner	Signal/noise ratio	55 dB					
	Usable sensitivity	12 dB					
	Total harmonic distortion	0.5 %					
HDMI	Video	2D : 2160p, 1080p, 1080i, 720p, 480p 3D : 1080p, 720p					
	Audio	PCM multichannel audio, Bitstream audio, PCM audio					
Amplifier	Front speaker output	165W x 2 (3Ω)					
	Front Top speaker output	165W x 2 (3Ω)					
	Center speaker output	170W (3Ω)					
	Surround speaker output	165W x 2 (3Ω)					
	Subwoofer speaker output	170W (3Ω)					
	Frequency response	Analog input : 20Hz~20kHz (±3dB)					
		Digital input : 20Hz~40kHz (±4dB)					
	S/N Ratio	70dB					
	Channel separation	60dB					
Input sensitivity	(AUX) 500mV						
Speaker (7.1ch speaker system)							
Speaker system	Impedance	Frequency range	Output sound pressure level	Rated input	Maximum input	Dimensions (W x H x D) (inches)	Weights (lbs)
Front/ Front Top	3 Ω	140Hz~ 20kHz	87dB/W/M	165W	330W	3.5 x 51.2 x 2.7 (Stand base: 9.8 x 9.8)	16.87
Surround						3.5 x 5.5 x 2.7	1.43
Center		40Hz ~ 160Hz	88dB/W/M	170W	340W	10.5 x 4.0 x 2.8	1.92
Subwoofer						8.0 x 15.3 x 13.8	13.96

- Samsung Electronics Co., Ltd reserves the right to change the specifications without notice.
- Weight and dimensions are approximate.
- Design and specifications are subject to change without prior notice.
- Dispose of unwanted electronics through an approved recycler.
To find the nearest recycling location, go to our website: www.samsung.com/recyclingdirect or call, (877) 278 - 0799

□ SWA-6000

Power Requirements	AC 120V ~60Hz
Power Consumption	50 W
Weight	2.52 lbs
Dimensions (W x H x D)	3 x 9 x 6 inches
Operating Temperature Range	+41°F to +95°F

Operating Humidity Range	10% ~ 75%
Output	165W x 2 CH
Frequency range	20Hz~20KHz
S/N Ratio	65dB

LIMITED WARRANTY TO ORIGINAL PURCHASER

This SAMSUNG brand product, as supplied and distributed by SAMSUNG and delivered new, in the original carton to the original consumer purchaser, is warranted by SAMSUNG against manufacturing defects in materials and workmanship for a limited warranty period of:

One (1) Year Parts and Labor*
(*90 Days Parts and Labor for Commercial Use)

This limited warranty begins on the original date of purchase, and is valid only on products purchased and used in the United States. To receive warranty service, the purchaser must contact SAMSUNG for problem determination and service procedures. Warranty service can only be performed by a SAMSUNG authorized service center. The original dated bill of sale must be presented upon request as proof of purchase to SAMSUNG or SAMSUNG's authorized service center. Transportation of the product to and from the service center is the responsibility of the purchaser.

SAMSUNG will repair or replace this product, at our option and at no charge as stipulated herein, with new or reconditioned parts or products if found to be defective during the limited warranty period specified above. All replaced parts and products become the property of SAMSUNG and must be returned to SAMSUNG. Replacement parts and products assume the remaining original warranty, or ninety (90) days, whichever is longer.

SAMSUNG's obligations with respect to software products distributed by SAMSUNG under the SAMSUNG brand name are set forth in the applicable end user license agreement. Non-SAMSUNG hardware and software products, if provided, are on an "AS IS" basis.

Non-SAMSUNG manufacturers, suppliers, publishers, and service providers may provide their own warranties.

This limited warranty covers manufacturing defects in materials and workmanship encountered in normal, and except to the extent otherwise expressly provided for in this statement, noncommercial use of this product, and shall not apply to the following, including, but not limited to: damage which occurs in shipment; delivery and installation; applications and uses for which this product was not intended; altered product or serial numbers; cosmetic damage or exterior finish; accidents, abuse, neglect, fire, water, lightning or other acts of nature; use of products, equipment, systems, utilities, services, parts, supplies, accessories, applications, installations, repairs, external wiring or connectors not supplied and authorized by SAMSUNG, or which damage this product or result in service problems; incorrect electrical line voltage, fluctuations and surges; customer adjustments and failure to follow operating instructions, cleaning, maintenance and environmental instructions that are covered and prescribed in the instruction book; product removal or reinstallation; reception problems and distortion related to noise, echo, interference or other signal transmission and delivery problems. SAMSUNG does not warrant uninterrupted or error-free operation of the product.

THERE ARE NO EXPRESS WARRANTIES OTHER THAN THOSE LISTED AND DESCRIBED ABOVE, AND NO WARRANTIES WHETHER EXPRESS OR IMPLIED, INCLUDING, BUT NOT LIMITED TO, ANY IMPLIED WARRANTIES OF MERCHANTABILITY OR FITNESS FOR A PARTICULAR PURPOSE, SHALL APPLY AFTER THE EXPRESS WARRANTY PERIODS STATED ABOVE, AND NO OTHER EXPRESS WARRANTY OR GUARANTY GIVEN BY ANY PERSON, FIRM OR CORPORATION WITH RESPECT TO THIS PRODUCT SHALL BE BINDING ON SAMSUNG. SAMSUNG SHALL NOT BE LIABLE FOR LOSS OF REVENUE OR PROFITS, FAILURE TO REALIZE SAVINGS OR OTHER BENEFITS, OR ANY OTHER SPECIAL, INCIDENTAL OR CONSEQUENTIAL DAMAGES CAUSED BY THE USE, MISUSE OR INABILITY TO USE THIS PRODUCT, REGARDLESS OF THE LEGAL THEORY ON WHICH THE CLAIM IS BASED, AND EVEN IF SAMSUNG HAS BEEN ADVISED OF THE POSSIBILITY OF SUCH DAMAGES. NOR SHALL RECOVERY OF ANY KIND AGAINST SAMSUNG BE GREATER IN AMOUNT THAN THE PURCHASE PRICE OF THE PRODUCT SOLD BY SAMSUNG AND CAUSING THE ALLEGED DAMAGE. WITHOUT LIMITING THE FOREGOING, PURCHASER ASSUMES ALL RISK AND LIABILITY FOR LOSS, DAMAGE OR INJURY TO PURCHASER AND PURCHASER'S PROPERTY AND TO OTHERS AND THEIR PROPERTY ARISING OUT OF THE USE, MISUSE OR INABILITY TO USE THIS PRODUCT SOLD BY SAMSUNG NOT CAUSED DIRECTLY BY THE NEGLIGENCE OF SAMSUNG. THIS LIMITED WARRANTY SHALL NOT EXTEND TO ANYONE OTHER THAN THE ORIGINAL PURCHASER OF THIS PRODUCT, IS NONTRANSFERABLE AND STATES YOUR EXCLUSIVE REMEDY.

Some states do not allow limitations on how long an implied warranty lasts, or the exclusion or limitation of incidental or consequential damages, so the above limitations or exclusions may not apply to you. This warranty gives you specific legal rights, and you may also have other rights which vary from state to state.

To obtain warranty service, please contact SAMSUNG customer care center.



QUESTIONS OR COMMENTS?

COUNTRY	CALL	OR VISIT US ONLINE AT	WRITE
IN THE US	1-800-SAMSUNG (726-7864)	www.samsung.com/us	Samsung Electronics America, Inc. 85 Challenger Road Ridgefield Park, NJ 07660



AH68-02630A-01

Free Manuals Download Website

<http://myh66.com>

<http://usermanuals.us>

<http://www.somanuals.com>

<http://www.4manuals.cc>

<http://www.manual-lib.com>

<http://www.404manual.com>

<http://www.luxmanual.com>

<http://aubethermostatmanual.com>

Golf course search by state

<http://golfingnear.com>

Email search by domain

<http://emailbydomain.com>

Auto manuals search

<http://auto.somanuals.com>

TV manuals search

<http://tv.somanuals.com>