

**SAMSUNG**

# *Instruction Manual*

## **DVD-TR520**

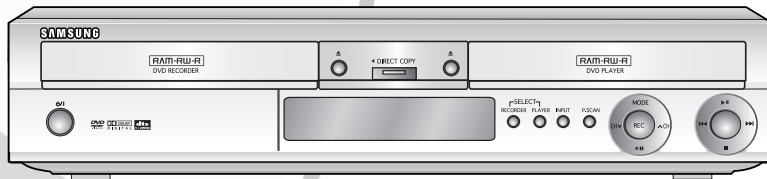

**DVD**  
VIDEO  
RAMRW

**DVD**  
VIDEO

**COMPACT**  
**disc**  
DIGITAL VIDEO

**COMPACT**  
**disc**  
DIGITAL AUDIO

[www.samsung.com](http://www.samsung.com)

AK68-00627D-01

# Warning

TO REDUCE THE RISK OF ELECTRIC SHOCK, DO NOT REMOVE THE COVER(OR BACK). NO USER-SERVICEABLE PARTS ARE INSIDE. REFER SERVICING TO QUALIFIED SERVICE PERSONNEL.

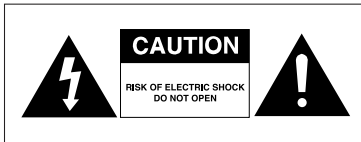

This symbol indicates "dangerous voltage" inside the product that presents a risk of electric shock or personal injury.



This symbol indicates important instructions accompanying the product.

Do not install this equipment in a confined space such as a bookcase or similar unit.

**WARNING :** To prevent damage which may result in fire or electric shock hazard, do not expose this appliance to rain or moisture.

**CAUTION :** TWIN TRAY DVD RECORDERS USE AN INVISIBLE LASER BEAM WHICH CAN CAUSE HAZARDOUS RADIATION EXPOSURE IF DIRECTED. BE SURE TO OPERATE RECORDER CORRECTLY AS INSTRUCTED.

## CAUTION

THIS PRODUCT UTILIZES A LASER. USE OF CONTROLS OR ADJUSTMENTS OR PERFORMANCE OF PROCEDURES OTHER THAN THOSE SPECIFIED HEREIN MAY RESULT IN HAZARDOUS RADIATION EXPOSURE. DO NOT OPEN COVERS AND DO NOT REPAIR YOURSELF. REFER SERVICING TO QUALIFIED PERSONNEL.

## CAUTIONS

**Caution:** To prevent electric shock, match wide blade of plug to wide slot, fully insert.

**Attention:** Pour éviter les chocs électriques, introduire la lame la plus large de la fiche dans la borne correspondante de la prise et pousser jusqu'au fond. This product satisfies FCC regulations when shielded cables and connectors are used to connect the unit to other equipment. To prevent electromagnetic interference with electric appliances, such as radios and televisions, use shielded cables and connectors for connections.

## FCC NOTE (for U.S.A):

This equipment has been tested and found to comply with the limits for a Class B digital device, pursuant to Part 15 of the FCC Rules. These limits are designed to provide reasonable protection against harmful interference in a residential installation. This equipment generates, uses and can radiate radio frequency energy and, if not installed and used in accordance with the instructions, may cause harmful interference to radio communications.

However, there is no guarantee that interference will not occur in a particular installation. If this equipment does cause harmful interference to radio or television reception, which can be determined by turning the equipment off and on, the user is encouraged to try to correct the interference by one or more of the following measures :

- Reorient or relocate the receiving antenna.
- Increase the separation between the equipment and receiver.
- Connect the equipment into an outlet on a circuit different from that to which the receiver is connected.
- Consult the dealer or an experienced radio/TV technician for help.



NOTE

- This unit can be used only where the power supply is AC 120V, 60Hz. It cannot be used elsewhere.
- This TWIN TRAY DVD RECORDER is designed and manufactured to respond to the Region Management Information. If the Region number of a TWIN TRAY DVD disc does not correspond to the Region number of this TWIN TRAY DVD RECORDER, the TWIN TRAY DVD RECORDER cannot play the disc.
- This device is protected by U.S. Patent Nos.4,631,603;4,577,216;4,819,098;4,907,093; and 6,516,132. This product incorporates copyright protection technology that is protected by U.S. patents and other intellectual property rights. Use of this copyright protection technology must be authorized by Macrovision, and is intended for home and other limited viewing uses only unless otherwise authorized by Macrovision. Reverse engineering or disassembly is prohibited.

DANGER	- VISIBLE AND INVISIBLE LASER RADIATION WHEN OPEN. AVOID DIRECT EXPOSURE TO BEAM.
CAUTION	- VISIBLE AND INVISIBLE LASER RADIATION WHEN OPEN. AVOID EXPOSURE TO BEAM.
ATTENTION	- RAYONNEMENT LASER VISIBLE ET INVISIBLE EN CAS D'OUVERTURE. EXPOSITION DANGEREUSE AU FAISCEAU.
ADVARSEL	- SYNLIG OG USYNLIG LASERSTRÅLING VED ÅBNING. UNNGÅ UDSÆTTELSE FOR STRÅLING.
VARO !	- AVATTAESSA OLET ALTTIINA NÄKYVÄÄ JA NÄKYMÄTÖN LASERSÄTEILYLLÄ. ÄLÄ KATSO SÄTEESEEN.
VARNING	- SYNLIG OCH OSYNLIG LASERSTRÅLNING NÄR DENNA DEL ÄR ÖPPNAD. BETRAKTA EJ STRÅLEN.
ADVARSEL	- SYNLIG OG USYNLIG LASERSTRÅLING NÄR DEKSEL ÅPNESES. UNNGÅ EKSPONERING FOR STRÅLEN.
VORSICHT	- SICHTBARE UND UNSICHTBARE LASERSTRAHLUNG, WENN ABDECKUNG GEÖFFNET, NICHT DEM STRAHL AUSSETZEN.
注意	- 打开时有可见及不可见激光辐射。避免激光束照射。
注意	- ここを開くと可視及び不可視のレーザー光が出ます。ビームを直接見たり、触れたりしないでください。

# Precaution



## Important Safety Instructions

Read these operating instructions carefully before using the unit. Follow all the safety instructions listed below. Keep these operating instructions handy for future reference.

- 1) Read these instructions.
- 2) Keep these instructions.
- 3) Heed all warnings.
- 4) Follow all instructions.
- 5) Do not use this apparatus near water.
- 6) Clean only with dry cloth.
- 7) Do not block any ventilation openings, Install in accordance with the manufacturer's instructions.
- 8) Do not install near any heat sources such as radiators, heat registers, stoves, or other apparatus (including amplifiers) that produce heat.
- 9) Do not defeat the safety purpose of the polarized or grounding-type plug. A polarized plug has two blades with one wider than the other. A grounding-type plug has two blades and a third grounding prong. The wide blade or the third prong are provided for your safety. If the provided plug does not fit into your outlet, consult an electrician for replacement of the obsolete outlet.
- 10) Protect the power cord from being walked on or pinched particularly at plugs, convenience receptacles, the point where they exit from the apparatus.
- 11) Only use attachments/accessories specified by the manufacturer.
- 12) Use only with the cart, stand, tripod, bracket, or table specified by the manufacturer, or sold with the apparatus. When a cart is used, use caution when moving the cart/apparatus combination to avoid injury from tip-over.
- 13) Unplug this apparatus during lightning storms or when unused for long periods of time.
- 14) Refer all servicing to qualified service personnel. Servicing is required when the apparatus has been damaged in any way, such as power-supply cord or plug is damaged, liquid has been spilled or objects have fallen into the apparatus, the apparatus has been exposed to rain or moisture, does not operate normally, or has been dropped.

## Handling Cautions

- Before connecting other components to this TWIN TRAY DVD RECORDER, be sure to turn them all off.
- Do not move the TWIN TRAY DVD RECORDER while a disc is being played, or the disc may be scratched or broken, the twin tray TWIN TRAY DVD RECORDER's internal parts may be damaged.
- Do not put a flower vase filled with water or any small metal objects on the TWIN TRAY DVD RECORDER.
- Be careful not to put your hand into the disc tray.
- Do not place anything other than the disc in the disc tray.
- Exterior interference such as lightning and static electricity can affect normal operation of this TWIN TRAY DVD RECORDER. If this occurs, turn the TWIN TRAY DVD RECORDER off and on again with the **DVD POWER** button, or disconnect and then reconnect the AC power cord to the AC power outlet. The TWIN TRAY DVD RECORDER will operate normally.
- Be sure to remove the disc and turn off the TWIN TRAY DVD RECORDER after use.
- Disconnect the AC power cord from the AC outlet when you don't intend to use the TWIN TRAY DVD RECORDER for long periods of time.
- Clean the disc by wiping in a straight line from the inside to the outside of the disc.

## Maintenance of Cabinet

For safety reasons, be sure to disconnect the AC power cord from the AC outlet.

- Do not use benzene, thinner, or other solvents for cleaning.
- Wipe the cabinet with a soft cloth.

## Disc Handling

- Use discs with regular shapes. If an irregular shape (a disc with a special shape) is used, this TWIN TRAY DVD RECORDER may be damaged.

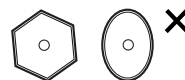

---

## Holding discs

---

- Avoid touching the surface of a disc where recording is performed.



---

## Cartridge

---

- This is used to prevent damage by dirt, scratches, etc. when using a DVD-RAM disc in the R tray.



---

## DVD-RAM, DVD-RW and DVD-R

---

- Clean with an optional DVD-RAM/PD disc cleaner. Do not use cleaners or cloths for CDs to clean DVD-RAM/-RW/-R discs.

---

## DVD-Video, Audio-CD

---

- Wipe off dirt or contamination on the disc with a soft cloth.

---

## Cautions on handling discs

---

- Do not write on the printed side with a ball-point pen or pencil.
- Do not use record cleaning sprays or antistatic. Also, do not use volatile chemicals, such as benzene or thinner.
- Do not apply labels or stickers to discs. (Do not use discs fixed with exposed tape adhesive or leftover peeled-off stickers.)
- Do not use scratch-proof protectors or covers.
- Do not use discs printed with label printers available on the market.
- Do not load warped or cracked discs.

## Disc Storage

Be careful not to harm the disc because the data on these discs is highly vulnerable to the environment.

- Do not keep under direct sunlight.
- Keep in a cool ventilated area.
- Store vertically.
- Keep in a clean protection jacket.
- If you move your TWIN TRAY DVD RECORDER suddenly from a cold place to a warm place,

condensation may generate on the operating parts and lens and cause abnormal disc playback. If this occurs, do not connect the plug to the power outlet and wait for two hours. Then insert the disc and try to playback again.

- Be careful not to harm the disc because the data on these discs is highly vulnerable to the environment.

## Disc Specifications

---

### Disc Type

---

#### DVD-Video

- A digital versatile disc (DVD) can contain up to 135-minutes of video, 8 audio languages and 32 subtitle languages. It is equipped with MPEG-2 picture compression and Dolby digital surround, allowing you to enjoy vivid and clear theater quality video in the comfort of your own home.
- When switching from the first layer to the second layer of a dual-layered DVD Video disc, there may be momentary distortion in the video and sound. This is not a malfunction of the unit.
- Once a DVD-RW/-R recorded in Video Mode is finalized, it becomes a DVD-Video disc.

#### Audio CD

- An audio disc on which 44.1kHz PCM Audio is recorded.
- Plays CD-DA format audio CD-R and CD-RW discs.
- The unit may not be able to play some CD-R or CD-RW discs due to the condition of the recording.

#### CD-RW/-R

- Use a 700MB(80 minutes) CD-R/RW disc. If possible, do not use a 800MB(90 minutes) or above disc, as the disc may not play back.
- If the CD-R/RW disc was not recorded as a closed session, you may experience a delay in the early playback time, all recorded files may not play.
- Some CD-R/RW discs may not be playable with this unit, depending on the device which was used to burn them. For contents recorded on CD-R/RW media from CDs for your personal use, playability may vary depending on contents and discs.

### DVD-R Disc Playback and Recording

- Once a DVD-R recorded in Video Mode is finalized, it becomes a DVD-Video disc.
- You can record onto the available space on the disc and perform editing functions such as giving titles to discs and programs and erasing programs before finalizing.
- When programming is erased from a DVD-R, that space does not become available. Once an area on a DVD-R is recorded on, that area is no longer available for recording, whether the recording is erased or not.
- It takes about 30 seconds for the unit to complete recording management information after recording finishes.
- Playback may be impossible in some cases due to the condition of recording.
- This unit can play back DVD-R discs recorded and finalized with a Samsung DVD video recorder. It may not be able to play some DVD-R discs depending on the disc and the condition of the recording.
- The unfinalized DVD-R discs can not play back in the P Tray.

### DVD-RW Disc Playback and Recording

- Recording and playback can be performed on DVD-RW discs in both the Video and VR Modes.
- Once a DVD-RW recorded in both the Video and VR Modes is finalized, you cannot perform additional recording. (See pages 106~107)
- Once a DVD-RW recorded in Video Mode is finalized, it becomes a DVD-Video disc.
- In both modes, playback can be performed before and after finalization, but additional recording, deleting and editing can not be performed after finalization.
- If you want to record the disc in VR Mode and then record in V Mode, be sure to execute Format. Be careful when execute Format because all the recorded data may be lost.
- A DVD-RW blank disc is initialized to VR Mode when first initialized.
- The unfinalized DVD-RW(Video mode)discs can not play back in the P Tray.

### DVD-RAM Disc Playback and Recording

- DVD-RAM discs come with or without a cartridge. For this product, we recommend DVD-RAM discs that come with cartridges.

Cartridges can only be used in the R tray of this product.

- Some cartridges are able to eject the disc inside. Even if you are able to eject the disc, always use the disc with the cartridge to ensure correct operation.
- DVD-RAM discs have a Write Protect tab in order to avoid accidental erasure of recorded data. With the Write Protect tab set to PROTECT, you can play the disc, but recording or erasing will not work. Set the Write Protect tab to UNPROTECT to format the disc or erase data.
- This unit is compatible with both non-cartridge and cartridge DVD-RAM, but the write-protect tabs on cartridge-type discs give better protection to your recordings.
- You cannot play a DVD-RAM in most DVD components due to compatibility issues.
- Only DVD-RAM standard Version 2.0. discs can be played in this unit.
- DVD-RAM recorded on this unit may not work with other DVD components. To determine compatibility with these DVD-RAM discs, refer to the user's manual for the player.

Disc	Maximum no. of recordings by disc type
DVD-RAM	100,000
DVD-RW	1,000
DVD-R	1

## Disc Copy

### Disc Copy Specifications

Recorder tray Player tray	DVD-R	DVD-RW (VR mode)	DVD-RW (V mode)	DVD-RAM
DVD-Dual Layer Disc	No	No	No	No
DVD-Single Layer, DVD-Video, without Copy Protection	Yes	No	Yes	No
Copy Protected Disc	No	No	No	No
Recorded Video Disc- DVD-RAM	No	No	No	Yes
Recorded Video Disc- DVD-RW (V Mode)	Yes	No	Yes	No
Recorded Video Disc- DVD-RW (VR Mode)	No	Yes	No	No
Recorded Video Disc- DVD-R	Yes	No	Yes	No

Yes = Disc copying is possible.

No = Disc copying is not possible.

## COPY PROTECTION

- Many DVD discs are encoded with copy protection. Because of this, you should only connect your TWIN TRAY DVD RECORDER directly to your TV, not to a VCR. Connecting to a VCR results in a distorted picture from copy-protected DVD discs.
- This product incorporates copyright protection technology that is protected by methods claims of certain U.S. patents and other intellectual property rights owned by Macrovision Corporation and other rights owners. Use of this copyright protection technology must be authorized by Macrovision Corporation, is intended for home and other limited viewing uses only unless otherwise authorized by Macrovision Corporation. Reverse engineering or disassembly is prohibited.

### Protection

This TWIN TRAY DVD RECORDER allows you to protect the contents of your discs, as described below.



- Cartridge Protection allows you to protect discs from disc formatting and program deletion due to unintended operations. The cartridge write protect tab should be set to the unprotect position to be able to record, copy, edit or erase a DVD-RAM disc.
- Program Protection: See page 83 "Locking(Protecting) a Title"
- Disc Protection : See page 104 "Disc Protection"
- \* DVD-RAM/-RW/-R discs that are incompatible with the DVD-VIDEO format cannot be played in this product.
- \* For more information on DVD recording compatibility, consult your DVD-RAM/-RW/-R manufacturer.
- \* Use of poor quality DVD-RAM/-RW/-R discs may cause following unexpected problems including, without limitation, recording failure, loss of recorded or edited materials or damage to the TWIN TRAY DVD RECORDER.

## Disc Format

### Using MP3 disc

- CD-R, DVD-R/RW/RAM, with MP3 files recorded with UDF, ISO9660 or JOLIET format can be played.
- Only MP3 files with the ".mp3" or ".MP3" extension can be played.
- For MP3 files recorded with a VBR(Variable Bit Rates), from 32 Kbps to 320 Kbps, the sound may cut in and out.
- Playable bit-rate range is from 56 Kbps to 320 Kbps.
- The unit can handle a maximum of 1,500 files and 1,000 sub folders under a folder.

## 6 - English

### Using JPEG disc

- CD-R, DVD-R/RW/RAM, with JPEG files recorded with UDF, ISO9660 or JOLIET format can be played.
- Only JPEG files with the ".jpg" or ".JPG" extension can be displayed.
- The unit can handle a maximum of 4,500 files and 1,000 sub folders under a folder.
- MOTION JPEG and progressive JPEG are not supported.

### DVD-RW (VR mode)

- This is a format that is used for recording data on a DVD-RAM or DVD-RW disc. You can record multiple titles, edit, delete, partial delete, create a playlist, etc.
- A disc that is recorded in this mode may not be playable on another manufacturer's DVD recorder or player.

### DVD-RW (V mode)

- This is a format that is used for recording data on a DVD-RW or DVD-R disc. The disc can be played by existing DVD RECORDER once it has been finalized.
- If a disc that has been recorded in Video Mode by another manufacturer's recorder, but has not been finalized, it may be played or additionally be recorded by this TWIN TRAY DVD RECORDER.

## Do not use the following discs!

- LD, CD-G, CD-I, CD-ROM, SACD CD Layer, DVD-ROM, DVD+R and DVD+RW discs should not be used in this product.

### [Note]

Disc types that can be played : CD/CD-R/CD-RW/MP3/JPEG/DVD-Video/DVD-RAM/-RW/-R.

DVD-RW/-R discs which have been recorded in Video Mode on another manufacturer's recorder, can play only when finalized.

- Some commercial discs and DVD discs purchased outside your region may not be playable with this product. When these discs are played, either "No disc." or "Please check the regional code." will be displayed.
- If a disc has been recorded in Video Mode by another manufacturer's recorder, but has not been finalized, it may not be played or additionally be recorded by this TWIN TRAY DVD RECORDER.

# Contents



## Getting Started

Warning	2
Precaution	3
Important Safety Instructions	3
Handling Cautions	3
Maintenance of Cabinet	3
Disc Handling	3
Disc Storage	4
Disc Specifications	4
Disc Copy	5
General Features	9
Before Reading the User's Manual	10
How to use the TWIN TRAY DVD RECORDER	10
Unpacking	12
Description	14
Front Panel	14
Front Panel Display	14
Rear Panel	15
Tour of the Remote Control	16

## Connecting & Setting up

Quick Overview	17
Step 1: Connecting the Antenna Cable	18
Method 1 : Antenna + TWIN TRAY DVD RECORDER + TV : No Cable box	18
Method 2 : Antenna + Cable box + TWIN TRAY DVD RECORDER + TV : Cable box with many scrambled channels	19
Method 3 : Antenna + TWIN TRAY DVD RECORDER + Cable box + TV : Cable box with a few scrambled channels	19
Step 2 : Connecting the Video cable	20
Method 1 : Connecting to a Video input jack	20
Method 2 : Connecting to an S-Video input jack	21
Method 3 : Connecting to Component video input jacks(Y,P <sub>B</sub> ,P <sub>R</sub> )	21
Step 3 : Connecting the Audio cable	22

Method 1 : Connecting to your TV	22
Method 2 : Connecting to a stereo amplifier with analog input jacks	22
Method 3: Connecting to an AV amplifier with a digital input jack	23
Step 4 : Connecting External devices	23
Method 1 : Connecting a VCR, Set-Top Box(STB) or TWIN TRAY DVD player to the AV 1 IN jacks	23
Method 2 : Connecting a Camcorder to the AV 2 IN jacks	24
Method 3 : Connecting a Camcorder to the DV IN jack	24
Step 5 : Connecting the Power Cord	24

## System Setup

On-Screen Menu Navigation	25
OSD Language Setup	26
Auto Clock Set	26
Manual Clock Set	28
Auto Channel Memory	29
Manual Channel Set	30
Auto Power Off Setting	31
CM Skip Time Setting	31
EP Mode Time Setting	32
Setting up the Front Display Options	33
Automatic Chapter Creator	34
Setting up the Language Options	35
Setting up the Audio Options	36
Setting up the Video display Options	37
Setting up the Progressive scan	38
Canceling the Progressive scan	39
Setting up the Parental Control	40
If you forgot your password	40
About the Rating Level	41
About the Change Password	41

## Playback

Before Playing	42
Playing a Disc	43
Using the Disc Menu & Title Menu	44
Using the Search & Skip Functions	45

Slow Motion Play/Step Motion Play.....	46
About ANYKEY .....	46
Playing the Title List.....	48
Navigation Menu .....	49
Using the Markers.....	52
Using the Bookmarks .....	54
Selecting the Subtitle Language .....	56
Selecting the Soundtracks & Audio Channels .....	57
Changing the Camera Angle.....	58
Repeat Play .....	58
Zooming-In .....	60
Select Tray.....	61
Playing an Audio CD/MP3.....	61
Playing a Picture .....	68

## Recording

---

Before Recording.....	71
Recording the current TV program you are watching.....	73
Recording from external equipment you are watching.....	74
Copying from a Camcorder.....	75
Making a One Touch Recording (OTR).....	76
Making a Timer Recording .....	77
Flexible Recording (for Timer Recording only).....	79
Editing the Timer Record List.....	79
Deleting a Timer Record List.....	80

## Editing

---

Basic Editing (Title List) .....	82
Renaming(Labeling) a Title.....	82
Locking (Protecting) a Title .....	83
Deleting a Title .....	83
Deleting a Section of a Title (Partial Delete).....	85
Advanced Editing (Playlist) .....	87
Creating a Playlist.....	87
Playing Entries in the Playlist.....	88
Renaming a Playlist Entry.....	89
Editing a Scene for the Playlist.....	90
Deleting a Playlist Entry from the Playlist .....	94

Title Copy .....	95
About the Copy Screen.....	95
Contents(Title) Copy Specifications .....	95
Copying a Title that has been edited once before .....	97
Changing the Record Mode .....	98
Copying Multiple Titles at One Time .....	99
Deleting an Undesired Title from the Copy List.....	100
Previewing a Selected Title from the Copy List.....	101
Selecting Record Mode of Each Title from the Copy List.....	101
Changing Record Mode of All Titles from the Copy List .....	102
Disc Copy.....	102
Disc Copy Specifications.....	102
Disc Manager .....	103
Editing the Disc Name .....	103
Disc Protection .....	104
Formatting a Disc .....	105
Delete All Title Lists .....	105
Finalizing a Disc .....	106
Unfinalizing a Disc (V/VR mode).....	107

## Reference

---

Troubleshooting .....	109
Specifications .....	113
Warranty.....	114



# General Features



The TWIN TRAY DVD RECORDER allows you to play high quality digital video on DVD-RAM/-RW/-R discs. You can also record and edit digital images on DVD-RAM/-RW/-R discs in the R Tray. This unit can not open the P tray and the R tray simultaneously.

## Copy from P Tray to R Tray

You can copy non-copy protected recordings from the disc in P Tray to recordable disc in the R Tray. Usually you can use the high speed copy feature.

You can also choose to copy material at a different recording quality from the original. For example, you might want to copy a XP mode recording on the P Tray to SP(Standard play)quality on the R Tray so that you can fit other recordings on the same disc.

## High quality digital audio and video recording and playback

Record up to 16-hours of video with a double sided 9.4 GB DVD-RAM disc, up to 8-hours of images with a 4.7 GB DVD-RAM/-RW/-R disc, depending on the recording mode.

## Selectable Recording Mode

You can set your TWIN TRAY DVD RECORDER to one of four different recording speeds, each varying in recording quality and length. EP (6Hr or 8Hr) mode yields the most recording time, LP & SP modes provide less recording time with higher quality recording, XP mode gives you the highest quality recording.

## Automated Quality Adjustment for Timer Recording

If FR mode is selected, the video quality is adjusted automatically so that all video for the scheduled time can be recorded onto the free disc space. (See page 79)

## Creating a DVD video title using DVD-RW/-R disc

With the TWIN TRAY DVD RECORDER, you can create your own DVD Video titles on 4.7 GB DVD-RW/-R discs.

## Copying data from a digital camcorder using a DV input jack

Record DV Device video onto, DVD-RAM, DVD-RW or DVD-R discs using the DV input jack (IEEE 1394-4pin/4pin) in the R Tray. (See pages 75-76)

## High quality Progressive Scan

Progressive scanning provides high resolution and flicker free video. The 10-bit 54-MHz DAC and 2D Y/C Separating Circuitry provides the highest image playback and recording quality. (See pages 38-40)













## A variety of functions with an easy-to-use user interface

The integrated menu system and the messaging function allow you to perform desired operations both easily and conveniently. With a DVD-RAM or DVD-RW disc, you can edit recorded video, create a playlist, edit video in a specific sequence according to your requirements in the R Tray.

# Before Reading the User's Manual

Make sure to check the following terms before reading the user manual.

## Icons that will be used in manual

Icon	Term	Definition
	DVD	This involves a function available in DVD or DVD-R/DVD-RW discs that have been recorded and finalized in Video Mode.
	RAM	This involves a function available in DVD-RAM.
	RW	This involves a function available in DVD-RW.
	R	This involves a function available in DVD-R.
	CD	This involves a function available in a data CD (CD-R or CD-RW).
	JPEG	This involves a function available in CD-R/-RW or DVD-R/-RW/-RAM discs.
	MP3	This involves a function available in CD-R/-RW or DVD-R/-RW/-RAM discs.
	Caution	This involves a case where a function does not operate or settings may be canceled.
	PLAYER	This involves a function available when the PLAYER tray is selected.
	RECORDER	This involves a function available when the RECORDER tray is selected.
	NOTE	This involves tips or instructions on the page that help each function operate.
	One-Touch button	A function that can be operated by using only one button.
	ANYKEY button	A function that can be operated by using <b>ANYKEY</b> button.

## About the use of this user's manual

- 1) Be sure to be familiar with Safety Instructions before using this product. (See pages 2~6)
- 2) If a problem occurs, check the Troubleshooting. (See pages 109~112)

## Copyright

©2005 Samsung Electronics Co.  
All rights reserved; No part or whole of this user's manual may be reproduced or copied without the prior written permission of Samsung Electronics Co.

# How to use the TWIN TRAY DVD RECORDER

## Step 1 Select the disc type

This device can record on the following types of discs.

If you want to repeatedly record on the same disc or you want to edit the disc after recording, select a rewritable DVD-RW or DVD-RAM type disc. If you want to save a recording without any changes, choose a non-rewritable DVD-R.



## Step 2 Format the disc to start recording

Unlike a VCR, the TWIN TRAY DVD RECORDER automatically starts formatting when an unused disc is inserted. This is required for the preparation of recording on a disc.

### Using a DVD-RAM

This type of disc can be formatted in DVD-Video Recording format (VR mode). You can edit recorded video and create a playlist and edit video in a specific sequence according to your requirements.

### Using a DVD-RW

This type of disc can be formatted in either DVD-Video format (V mode) or DVD-Video Recording format (VR mode). For an unused disc, a message that asks whether to format in VR Mode or not is displayed. You can play a Video mode disc on various DVD components. A VR mode disc allows more varied editing.

### Using a DVD-R

This type of disc can be formatted in DVD Video format. After formatting is complete, you can record on the disc. You can play this type of discs on various DVD components only when they have been finalized.



NOTE

- You can only use either the VR or Video mode on a DVD-RW, but not both at the same time.
- You can change the DVD-RW format to another format by reinitializing. It should be noted that the disc's data will be lost when changing formats.

### Step 3 Recording

There are two different recording methods, Direct Recording and Timer Recording. Timer recording is classified as a Date : Once, Daily or Weekly.

Recording mode : XP (high quality mode), SP (standard quality mode), LP (long recording mode), and EP (extended mode) according to the recording mode. When recording is set in the FR(Flexible recording mode), the best quality picture is recorded with regards to the remaining time on the disc and length of the Timer Recording.

During recording, a title is created between two points where you start and stop recording. Chapters will be created automatically when you finalize recording on DVD-RW/-R discs in Video mode.

The chapter's length (interval between chapters) varies according to the recording mode.

### Step 4 Playing

You can select the title you want to play in a displayed menu and then immediately start playback.

A DVD consists of sections, called titles, and sub sections, called chapters.

### Step 5 Editing a recorded disc

Editing on discs is easier than conventional video tapes. The TWIN TRAY DVD RECORDER supports many different edit functions, possible only with DVDs.

With a simple and easy edit menu, you can operate various edit functions, such as delete, copy, rename, lock, etc., on a recorded title.

#### Creating a playlist (DVD-RAM/-RW in VR mode.)

With this TWIN TRAY DVD RECORDER you can create a new playlist on the same disc and edit it without the change of the original recording.



NOTE

- The Edit functions of the Title List and Playlist are available only in the R Tray.

### Step 6 Finalizing & Playing on other DVD components

To play your DVD on other DVD components, finalizing may be necessary. First, finish all editing and recording operations, then finalize the disc.

#### When using a DVD-RW disc in VR Mode

Although finalizing is generally unnecessary when playing the disc on a VR Mode compatible component, a finalized disc should be used for playback on that type of component.

#### When using a DVD-RW disc in Video Mode

The disc should be finalized first to enable playback on anything other than this TWIN TRAY DVD RECORDER. No more editing or recording can be made on the disc once it has been finalized.

To enable recording on the disc again, disc should be unfinalized.

#### When using a DVD-R disc

You should finalize the disc to play it on a component other than this TWIN TRAY DVD RECORDER. You cannot edit or record on the disc once it has been finalized.



NOTE

- P tray can play finalized DVD-R or DVD-RW(V) discs. If you want to play unfinalized DVD-R or DVR-RW(V) discs, they must be inserted in the R tray.

# Unpacking

## Accessories

Check for the supplied accessories below.

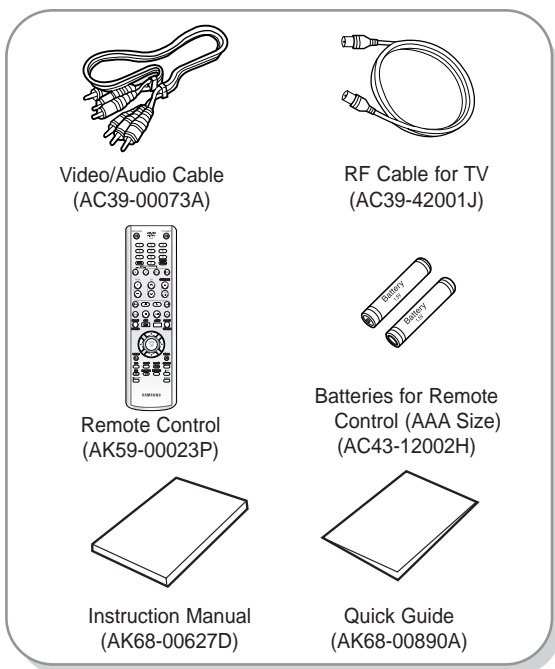

## Preparing the Remote Control

### Install Batteries in the Remote Control

- Open the battery cover on the back of the remote control.
- Insert two AAA batteries. Make sure that the polarities (+ and -) are aligned correctly.
- Replace the battery cover.

### If the remote does not operate properly:

- Check the polarity + - of the batteries (Dry-Cell)
- Check if the batteries are drained.
- Check if remote sensor is blocked by obstacles.
- Check if there is any fluorescent lighting nearby.

Dispose of batteries according to local environmental regulations. Do not put them in the household trash.

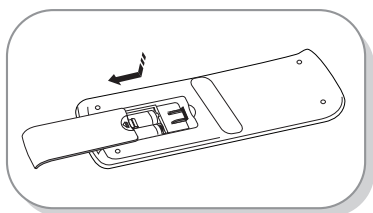

## Setting the Remote Control

You can control certain functions of another manufacturer's TV with this remote control. Control function buttons involve: **TV POWER**, **CH ^ v**, **TV VOL + -**, **number buttons**, **TV MUTE**, **INPUT** button.



### Controlling TVs with the Remote Control

1. Press and hold the **TV POWER** button.
2. Enter a 2-digit code by using the number buttons on the remote control.

#### See “Controllable TV Codes”

If the code works, your TV set will be turned on or off.

If it does not respond, try other codes.

Controllable TV Codes.

BRAND	BUTTON
AIWA	82
ANAM	10, 11, 12, 13, 14, 15, 16, 17, 18
BANG & OLUFSEN	57
BLAUPUNKT	71
BRANDT	73
BRIONVEGA	57
CGE	52
CONTINENTAL EDISON	75
DAEWOO	19, 20, 23, 24, 25, 26, 27, 28, 29, 30, 31, 32, 33, 34
EMERSON	64
FERGUSON	73
FINLUX	06, 49, 57
FORMENTI	57
FUJITSU	84
GRADIENTE	70
GRUNDIG	49, 52, 71
HITACHI	60, 72, 73, 75
IMPERIAL	52
JVC	61, 79
LG	06, 19, 20, 21, 22, 78
LOEWE	06, 69
LOEWE OPTA	06, 57
MAGNAVOX	40
METZ	57
MITSUBISHI	06, 48, 62, 65
MIVAR	52, 77
NEC	83
NEWSAN	68
NOBLEX	66
NOKIA	74
NORDMENDE	72, 73, 75
PANASONIC	53, 54, 74, 75
PHILIPS	06, 55, 56, 57
PHONOLA	06, 56, 57
PIONEER	58, 59, 73, 74
RADIOLA	06, 56
RADIOMARELLI	57
RCA	45, 46
REX	74
SABA	57, 72, 73, 74, 75
SALORA	74
SAMSUNG	01,02,03,04,05,06,07,08,09
SANYO	41, 42, 43, 44, 48
SCHNEIDER	06

BRAND	BUTTON
SELECO	74
SHARP	36, 37, 38, 39, 48
SIEMENS	71
SINGER	57
SINJUDYNE	57
SONY	35, 48
TELEAVA	73
TELEFUNKEN	67, 73, 75, 76
THOMSON	72, 73, 75
THOMSON ASIA	80, 81
TOSHIBA	47, 48, 49, 50, 51, 52
WEGA	57
YOKO	06
ZENITH	63



NOTE

- If several codes are indicated for your television brand, try each one in turn until you find one that works.
- If you replace the remote control's batteries, you must set the brand code again.

**Then you can control the television using the following buttons after the TV button.**

Button	Function
TV POWER	Used to switch the television on and off.
INPUT	Used to select an external source.
TV VOL (+ -)	Used to adjust the volume of the television.
CH ( ^ v )	Used to select the desired channel.
TV MUTE	Used to toggle the sound on and off.
Number buttons	Used to input number directly.



NOTE

- The functions listed above will not necessarily work on all televisions. If you encounter problems, operate the television directly.

# Description

## Front Panel

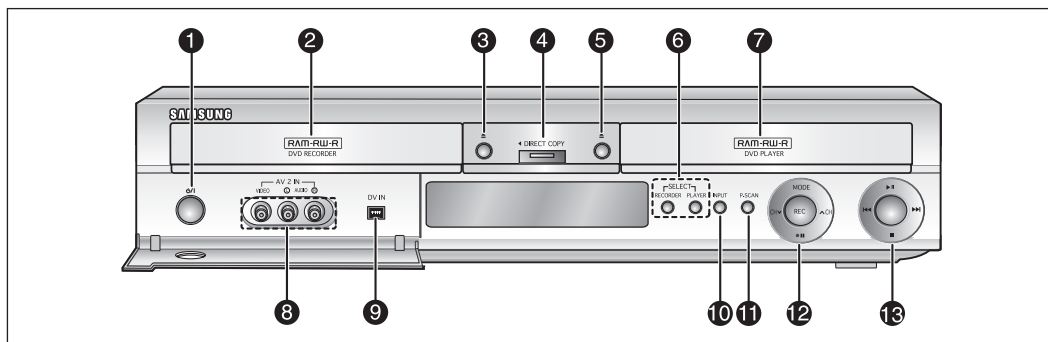

1. **POWER BUTTON**  
Turns the TWIN TRAY DVD RECORDER on and off.
2. **R (Record) TRAY**  
Opens to accept a disc.
3. **OPEN/CLOSE BUTTON**  
Opens and closes the R Tray
4. **DIRECT COPY BUTTON**  
Copy Titles and Disc from the disc in the P Tray to the disc in the R Tray.
5. **OPEN/CLOSE BUTTON**  
Opens and closes the P Tray.
6. **SELECT BUTTONS**  
Select R or P Tray.
7. **P (Play) TRAY**  
Opens to accept a disc.
8. **AV 2 INPUT**  
Connect external equipment.
9. **DV-IN**  
Connect external digital equipment with a DV jack. (such as a camcorder)
10. **INPUT BUTTON**  
Select input signal in external input mode. (Tuner, AV1, AV2 or DV)
11. **P.SCAN BUTTON**  
Selects the progressive scan mode.
12. **REC/REC MODE/PAUSE/CH BUTTONS**  
Select to start recording, to set the Recording time and picture quality, or to pause a recording.  
Select preset TV channels. Same as CH button on the remote control.
13. **PLAY/PAUSE/SEARCH/SKIP BUTTONS**  
Plays a disc, pauses playback or recording, goes to the next title/chapter/track, or goes back to the previous title/chapter/track.

## Front Panel Display

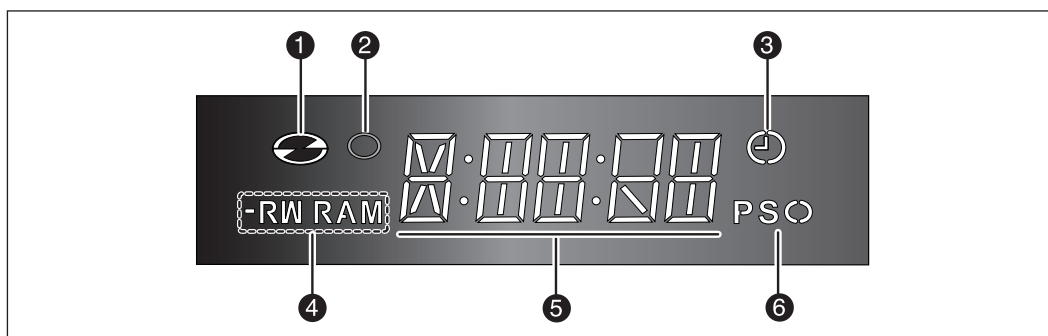

1. Lights when a disc is loaded.
2. Lights in the record mode.
3. Lights to indicate the timer record mode.
4. Lights when a -R/RW/RAM disc is loaded.
5. Playing time/clock/current status indicator.
6. Lights in the progressive scan mode.

## Rear Panel

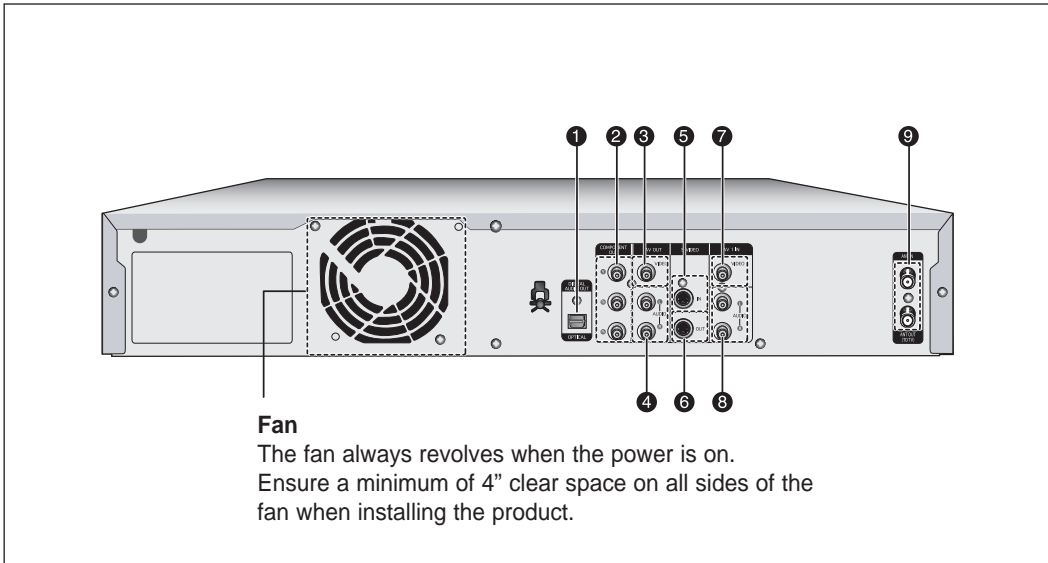

### 1. DIGITAL AUDIO OUT(OPTICAL)

Connects to an amplifier having a digital optical audio input jack.

### 2. COMPONENT VIDEO OUT(best video quality)

Connects to equipment having Component video input jacks.

### 3. AV VIDEO OUT(good video quality)

Connects to the Video input of external equipment using a Composite Video cable.

### 4. AV AUDIO OUT

Connects to the audio input of external equipment using audio cables.

### 5. S-VIDEO IN

Connects the output of external equipment using an S-Video cable.

### 6. S-VIDEO OUT(better video quality)

Connects the input of external equipment using an S-Video cable.

### 7. AV 1 VIDEO IN

Connects to the video output of external equipment using a video cable.

### 8. AV 1 AUDIO IN

Connects to the audio output of external equipment using audio cables.

### 9. ANT IN/ANT OUT (TO TV)

Connects antenna cables.



#### NOTE

- The Antenna connection does not pass the DVD's output signal. To watch a DVD on your TV, you must connect audio/video cables.

## Tour of the Remote Control

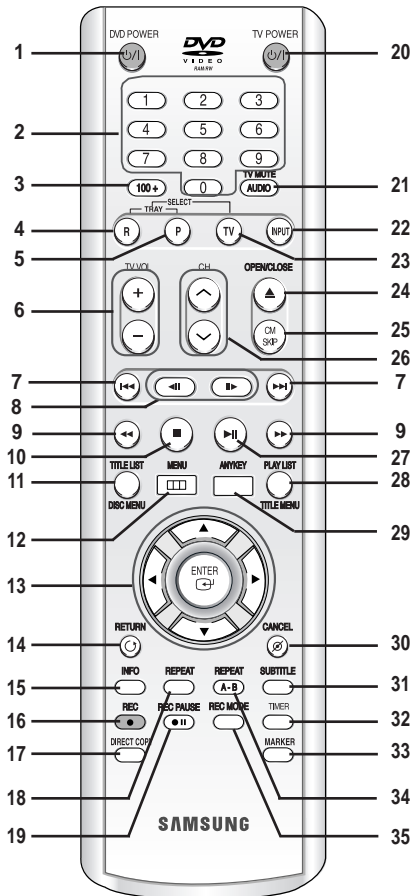

1. **DVD POWER Button**
2. **NUMBER Buttons**
3. **100+ Button**  
Press this to select channel 100 or higher.
4. **R Button**  
Press this to operate **R** tray(Recorder).
5. **P Button**  
Press this to operate **P** tray(Player).
6. **TV VOL Button**  
TV volume adjustment
7. **REVERSE/FORWARD SKIP Buttons**  
Press to skip a disc backwards or forwards.
8. **REVERSE/FORWARD STEP Buttons**  
Each press will play one-frame forward or reverse.
9. **REVERSE/FORWARD SEARCH Buttons**  
Press to search a disc backwards or forwards.
10. **STOP Button**  
Press to stop a disc or to stop the recording.
11. **TITLE LIST/DISC MENU Button**  
Use this to return to the Disc menu, or to view the recorded Title List.
12. **MENU Button**  
Brings up the TWIN TRAY DVD RECORDER's setup menu.
13. **ENTER/DIRECTION Buttons (▲▼◀▶ Buttons)**
14. **RETURN Button**
15. **INFO Button**  
This will display current setting or disc status.
16. **REC Button**  
Use to make a recording on DVD-RAM/-RW/-R discs.
17. **DIRECT COPY**  
Press this when you copy from the P tray to the R Tray. To start copying, press the COPY button on the title list screen or press the COPY button during the playback.
18. **REPEAT Button**  
Allows you to repeat a title, chapter, track or disc.
19. **REC PAUSE Button**  
Use this to pause during recording.
20. **TV POWER Button**
21. **AUDIO/TV MUTE Button**  
Use this to access various audio functions on a disc (DVD mode).  
This operates as sound mute. (TV mode)
22. **INPUT Button**  
Select line input signal in external input mode. (Tuner, AV1, AV2 or DV)
23. **TV Button**  
Press this to operate TV.
24. **OPEN/CLOSE Button**  
To open and close the disc tray.
25. **CM SKIP Button**  
The unit can be set to automatically skip a portion of the program during playback of a DVD disc.
26. **CH Button**  
Use this to select a TV channel.
27. **PLAY/PAUSE Button**  
Press to play/pause a disc.
28. **PLAY LIST/TITLE MENU Button**  
Use this to return to the Title menu, or to view the recorded Playlist.
29. **ANYKEY Button**  
View and select the applicable features under current status.
30. **CANCEL Button**
31. **SUBTITLE Button**  
Press this to switch the DVD's subtitle language.
32. **TIMER Button**  
Press to directly enter the Timer Recording Mode menu.
33. **MARKER Button**  
Use this to bookmark or mark a position while playing a disc.
34. **REPEAT A-B Button**  
Allows you to repeat a title, chapter, track or disc.
35. **REC MODE Button**  
Use this to set the desired Recording time and picture quality. (XP/SP/LP/EP)

## 16 - English



# Connecting & Setting up

This section involves various methods of connecting the TWIN TRAY DVD RECORDER to other external components and required initial setting modes.

Quick Overview .....	17
Step 1: Connecting the Antenna Cable .....	18
Step 2 : Connecting the Video cable .....	20
Step 3 : Connecting the Audio cable .....	22
Step 4 : Connecting External devices .....	23
Step 5 : Connecting the Power Cord .....	24

## Quick Overview

A Quick Overview presented in this guide will give you enough information to start using the TWIN TRAY DVD RECORDER.

### Step 1 : Connecting the Antenna cable



### Step 2 : Connecting the Video cable



### Step 3 : Connecting the Audio cable



### Step 4 : Connecting External devices



### Step 5 : Connecting the Power cord

- **Note to CATV system installer:** This reminder is provided to call CATV system installer's attention to Article 820-40 of the National Electrical Code (Section 54 of Canadian Electrical Code, Part I), that provides guidelines for proper grounding and, in particular, specifies that the cable ground shall be connected to the grounding system of the building as close to the point of cable entry as practical.

## Step 1: Connecting the Antenna Cable

There are several ways to connect your TWIN TRAY DVD RECORDER. Select the antenna that best suits you below.

- Method 1 : Antenna + TWIN TRAY DVD RECORDER + TV : No Cable box
- Method 2 : Antenna +Cable box + TWIN TRAY DVD RECORDER + TV : Cable box with many scrambled channels
- Method 3 : Antenna + TWIN TRAY DVD RECORDER + Cable box +TV : Cable box with a few scrambled channels



NOTE

- If you are using an off-air antenna that has 300-ohm twin flat leads, use an external antenna connector (300-75 ohm adaptor : not supplied) to connect the antenna to the TWIN TRAY DVD RECORDER.

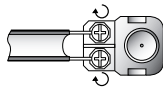

- If you have two separate antennas (one VHF and the other UHF), use a UHF/VHF combiner-adaptor (available at most electronics shops) to connect the antenna to the TWIN TRAY DVD RECORDER.

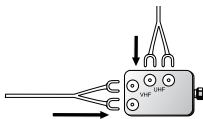

- The ANT OUT RF OUT jack of this product sends only signals received through the antenna. It does not output Audio/Video signals. You must connect Audio/Video cables to view Video from the unit. (i.e. DVD playback)

### Method 1 : Antenna + TWIN TRAY DVD RECORDER + TV : No Cable box

You can record non-scrambled channels by selecting the channel on the TWIN TRAY DVD RECORDER. Also use this Method if you watch channels without a cable box.

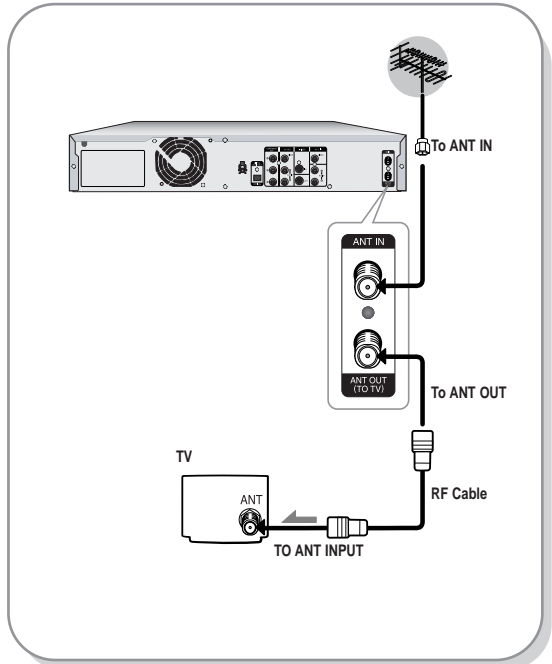

## Method 2 : Antenna + Cable box + TWIN TRAY DVD RECORDER + TV : Cable box with many scrambled channels

You can record channels by selecting the channel on the cable box. You cannot record one channel while watching another channel. Be sure that the cable box is turned on.

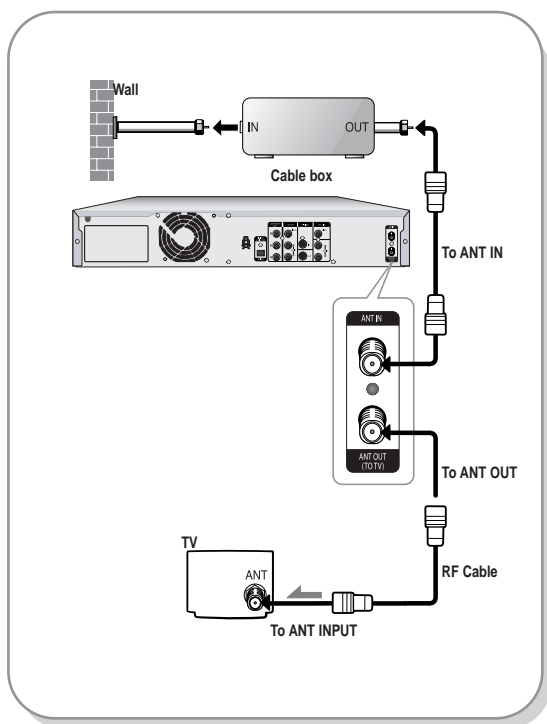

## Method 3 : Antenna + TWIN TRAY DVD RECORDER + Cable box + TV : Cable box with a few scrambled channels

You can record non-scrambled channels by selecting the channel on the cable box. You cannot record scrambled channels that require a cable box.

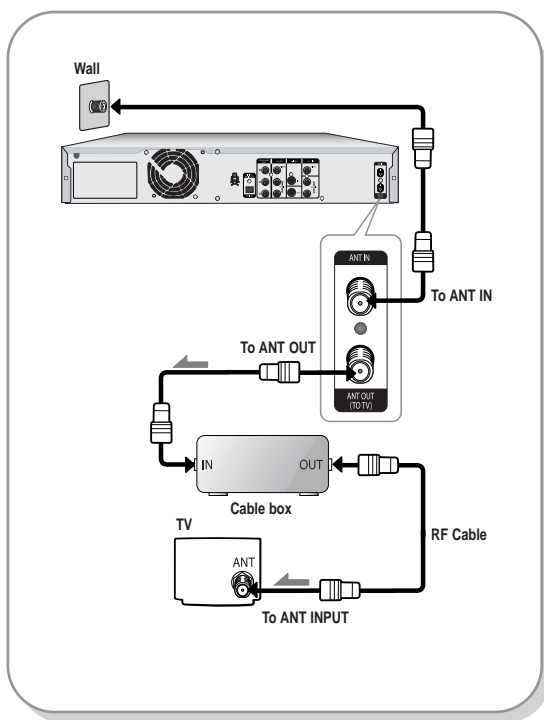

## Step 2 : Connecting the Video cable

There are several ways to connect your TWIN TRAY DVD RECORDER. Select one of the following video connecting that best suits you below.

- Method 1 : Connecting to a Video input jack
- Method 2 : Connecting to an S-video input jack
- Method 3 : Connecting to Component video input jacks

S-Video, Component video and Progressive Output Modes

- S-Video and Component video output are available only if your TV supports S-Video input or Component video input, respectively. If S-Video or Component video output does not work, check the TV connections and the TV input selection settings. (For information on how to connect to a TV, see page 18.)
- Compared to standard interlaced video, progressive scan doubles the amount of video lines fed to your TV, resulting in a more stable, flicker-free, and clear image than interlaced video. The progressive scan video output jack is used in progressive output mode. This is only available with TVs that support progressive scan.
- Progressive Scan Output (480p)  
 “Consumers should note that not all high definition television sets are fully compatible with this product and may cause artifacts to be displayed in the picture. If you experience 480p progressive scan picture problems, it is recommended that the user switch the connection to the ‘standard definition’ output. If there are questions regarding our TV set compatibility with this model, please contact our customer service center at 1-800-SAMSUNG.
- The VHF/UHF RF OUT jack of this product sends only signals received through the antenna. It does not output audio/video signals. You must use one of the following audio/video connections on this unit.

### Method 1 : Connecting to a Video input jack

Connect a video(yellow) cable between the VIDEO(yellow) OUT jack on TWIN TRAY DVD RECORDER and VIDEO(yellow) IN jack on the TV (or AV amplifier).

- You will enjoy regular quality images.
- Connect audio cables(white and red) between the AUDIO OUT jacks on the TWIN TRAY DVD RECORDER and AUDIO IN jacks on TV(or AV amplifier).  
(See pages 22~23)

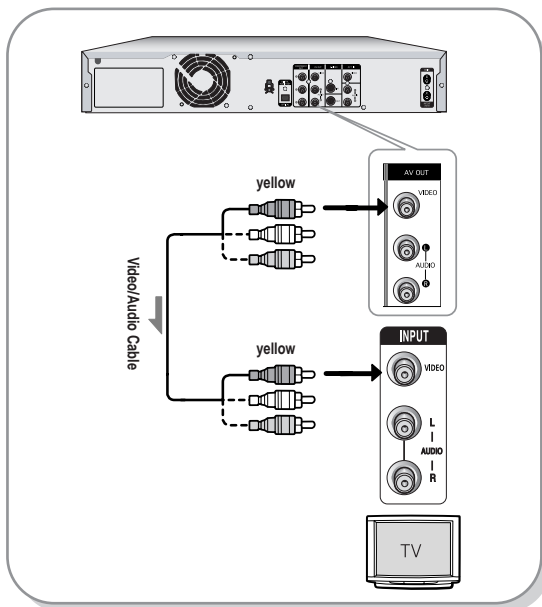

## Method 2 : Connecting to an S-Video input jack

Connect an S-Video cable(not supplied) between the S-VIDEO OUT jack on TWIN TRAY DVD RECORDER and S-VIDEO IN jack on your TV (or AV amplifier).

- You will enjoy high quality images. S-Video separates the picture element into black and white (Y) and color (C) signals to present clearer images than regular video input mode.
- Connect audio cables(white and red) between the AUDIO OUT jacks on the TWIN TRAY DVD RECORDER and AUDIO IN jacks on TV(or AV amplifier). (See pages 22~23)

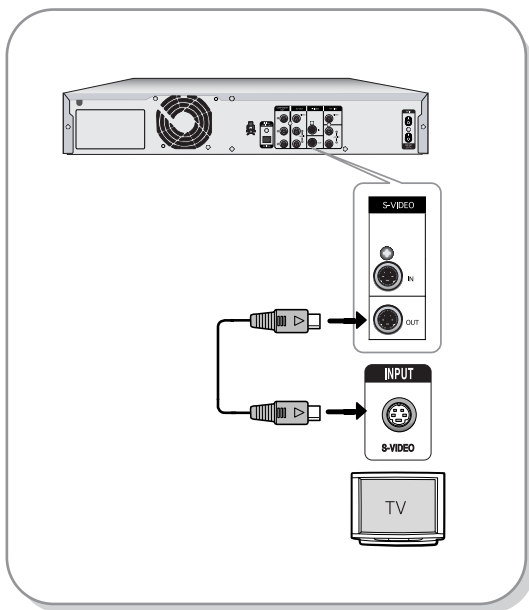

## Method 3 : Connecting to Component video input jacks(Y,P<sub>B</sub>,P<sub>R</sub>)

- Connect Component video cables(not supplied) between the COMPONENT OUT(Y,P<sub>B</sub>,P<sub>R</sub>) jacks on TWIN TRAY DVD RECORDER and COMPONENT IN(Y,P<sub>B</sub>,P<sub>R</sub>) jacks on your TV.
- Connect audio cables (white and red) between the AUDIO OUT jacks on the TWIN TRAY DVD RECORDER and AUDIO IN jacks on TV (or AV amplifier). (See pages 22~23).
- After connecting, refer to the pages 37 to 38.
  - You will enjoy high quality and accurate color reproduction images.

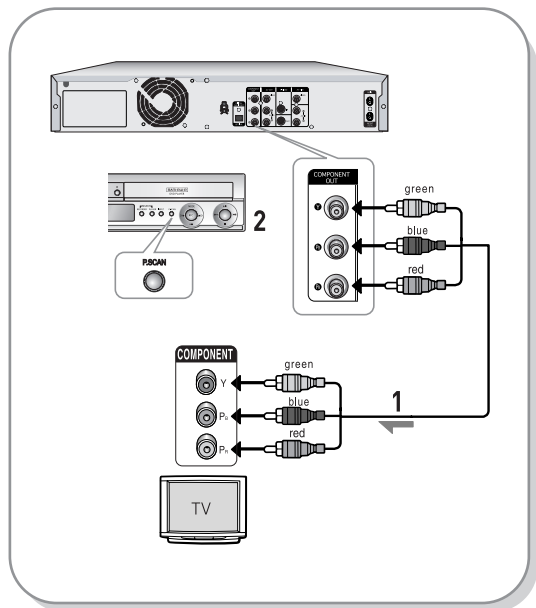

NOTE

- Make sure that the color coded connections match. The Y, P<sub>B</sub>, P<sub>R</sub> component output jacks of your TWIN TRAY DVD RECORDER must be connected to the exact corresponding component input jacks on your TV.

## Step 3 : Connecting the Audio cable

There are several ways to connect your TWIN TRAY DVD RECORDER. Select the audio connection that best suits you below.

- Method 1 : Connecting to your TV
- Method 2 : Connecting to a stereo amplifier (analog audio out)
- Method 3 : Connecting to an AV amplifier with a digital input jack

Manufactured under license from Dolby Laboratories. "Dolby" and the double-D symbol are trademarks of Dolby Laboratories.

"DTS" and "DTS Digital Out" are trademarks of Digital Theater Systems, Inc.

### Method 1 : Connecting to your TV

This connection will use your TV's speakers.

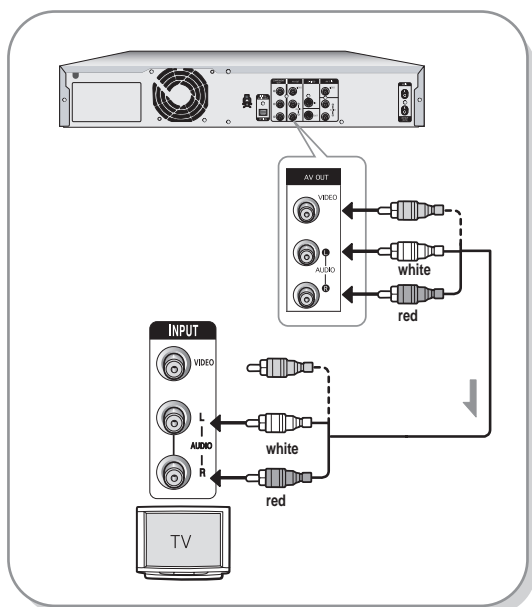

### Method 2 : Connecting to a stereo amplifier with analog input jacks

If your stereo amplifier only has AUDIO INPUT jacks (L and R), use the AUDIO OUT jacks.

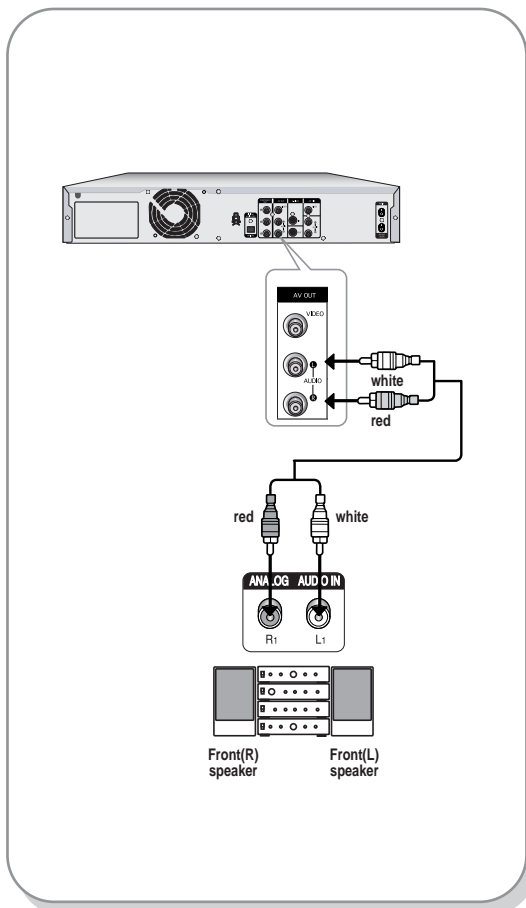

### Method 3: Connecting to an AV amplifier with a digital input jack

If your AV amplifier has a Dolby Digital or DTS decoder and a digital input jack, use this connection. To enjoy Dolby Digital or DTS sound, you will need to set up the audio settings. (See page 36)

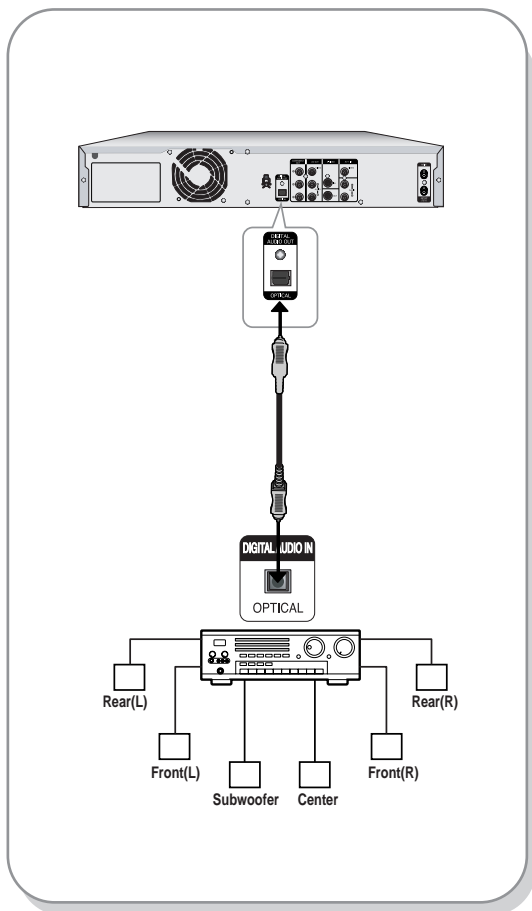

## Step 4 : Connecting External devices

This allows you to connect your TWIN TRAY DVD RECORDER to other external devices and view or record their outputs.

- Method 1 : Connecting a VCR, Set-Top Box(STB) or DVD player to the AV 1 IN jacks
- Method 2 : Connecting a Camcorder to the AV 2 IN jacks
- Method 3 : Connecting a Camcorder to the DV IN jack

### Method 1 : Connecting a VCR, Set-Top Box(STB) or DVD player to the AV 1 IN jacks

Connecting a VCR or external device to AUDIO/VIDEO AV 1 IN jacks of the TWIN TRAY DVD RECORDER. You can record from connected equipment (VCR, STB or DVD).

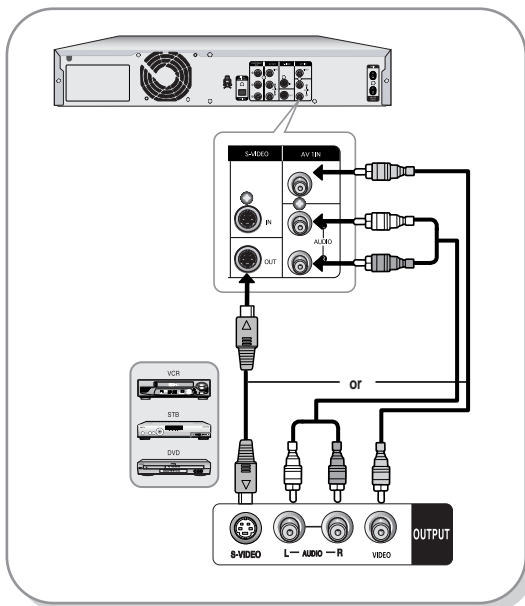

NOTE

- You can also use the AV 2 IN jacks on the front panel of the TWIN TRAY DVD RECORDER.
- You must choose S-Video or Composite in setup menu (See page 38).
- Copy protected content cannot be recorded.

## Method 2 : Connecting a Camcorder to the AV 2 IN jacks

You can also use the AV 2 IN jacks on the front panel of the TWIN TRAY DVD RECORDER. You can record from connected equipment, such as a camcorder.

When an input source (such as a camcorder) is inserted into AV 2 IN while viewing TV, the input will be switched to AV 2 IN automatically. If the input is not selected automatically, press the **INPUT** button to select proper input.

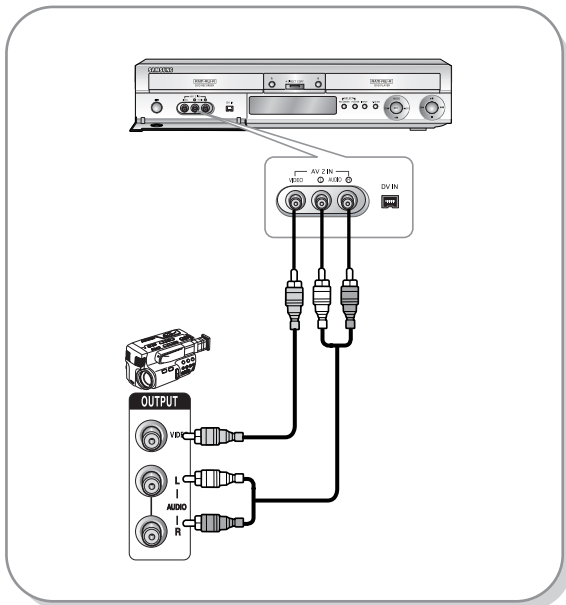

## Method 3 : Connecting a Camcorder to the DV IN jack

If your camcorder has a DV output jack, connect it to the DV input jack of your TWIN TRAY DVD RECORDER.

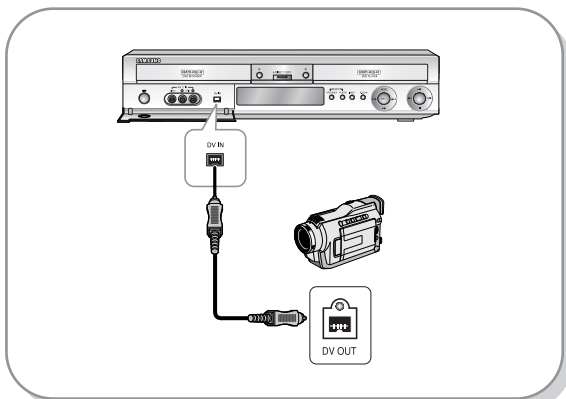

NOTE

- The input setting will automatically change to DV when the camcorder is connected and powered on.

## Step 5 : Connecting the Power Cord

After all connections are complete, plug the power cord in the wall outlet.

**“Auto” appears in the panel display. This means that the current time is being set automatically (Auto Program) through the antenna under connection and also the channel is being set. The setup may take a few minutes.**

When the TWIN TRAY DVD RECORDER operates normally, the current time is automatically set and displayed in the front panel display.

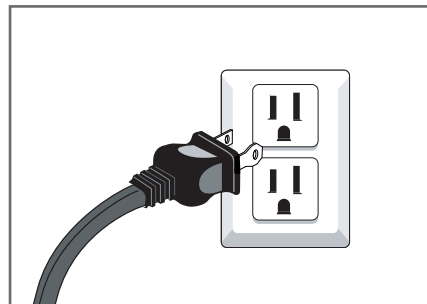

NOTE

- After the current time is set automatically, the TWIN TRAY DVD RECORDER will perform Auto Channel Memory for about 3 minutes. If power is on, while Auto Channel Memory is in process, Auto Channel Memory will stop. In this case, do Auto Channel Memory from MENU (See page 29).



# System Setup

## On-Screen Menu Navigation

The on-screen menus allow you to enable or disable various functions on your TWIN TRAY DVD RECORDER.

Use the following buttons to open and navigate through the on-screen menus.

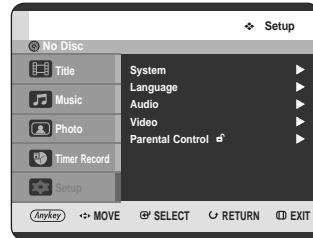

On-Screen Menu Navigation . . . . .	25
OSD Language Setup . . . . .	26
Auto Clock Set . . . . .	26
Manual Clock Set . . . . .	28
Auto Channel Memory . . . . .	29
Manual Channel Set . . . . .	30
Auto Power Off Setting . . . . .	31
CM Skip Time Setting . . . . .	31
EP Mode Time Setting . . . . .	32
Setting up the Front Display Options . . . . .	33
Automatic Chapter Creator . . . . .	34
Setting up the Language Options . . . . .	35
Setting up the Audio Options . . . . .	36
Setting up the Video display Options . . . . .	37
Setting up the Progressive scan . . . . .	38
Canceling the Progressive scan . . . . .	39
Setting up the Parental Control . . . . .	40

### 1 MENU Button

Press this button on the remote control to open the on-screen menu.  
Press again to exit the on-screen menu.

### 2 ▲▼, ◀▶ Buttons

Press these buttons on remote control to move the selection bar ▲▼, ◀▶ to cycle through the menu options.

### 3 ENTER Button

Press this button on the remote control to confirm any new settings.

### 4 RETURN Button

Press this button on the remote control to return to the Previous menu screen displayed or to exit the on-screen menu.

## OSD Language Setup

After plugging in the TWIN TRAY DVD RECORDER, the first time you press the POWER button, this screen comes up.

(This screen will only appear when you plug in the TWIN TRAY DVD RECORDER for the first time.)

**1** Press the **DVD POWER** button.

**2** Press a number button to select the desired language.



NOTE

- If the language for the startup screen is not set, the settings may change whenever you turn the power on or off. Therefore, make sure that you select the language you want to use.

## Auto Clock Set

This menu is used to set the current time. You need to set the time to use timer recording.

**1** With the unit in Stop mode / No Disc mode, press the **MENU** button.

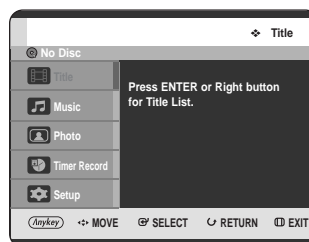

**2** Press the **▲▼** buttons to select **Setup**, then press the **ENTER** or **▶** button.

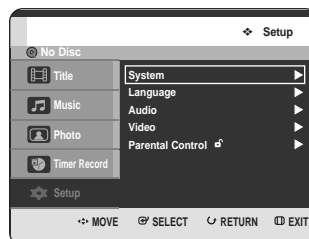

**3** Press the **▲▼** buttons to select **System**, then press the **ENTER** or **▶** button.

- System menu will be displayed.

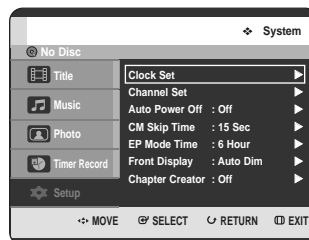

- 4 Press the ▲▼ buttons to select **Clock Set**, then press the **ENTER** or ► button.

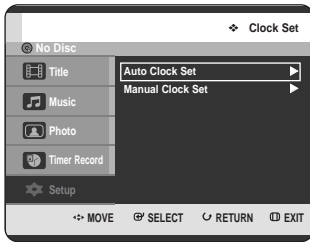

- 5 Press the ▲▼ buttons to select **Auto Clock Set**, then press the **ENTER** or ► button.

- 6 Press the ▲▼ buttons to select **On**, then press the **ENTER** or ► button.

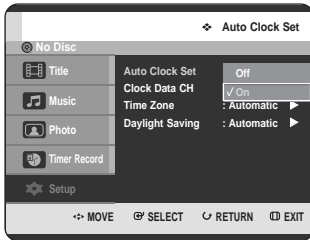

NOTE

- If your clock is set to the wrong time zone or daylight saving, you can adjust these settings without turning off the Auto Clock Set function.

- 7 Select the sub menu (**Clock Data CH**, **Time Zone** or **Daylight Saving**) using the ▲▼ buttons, then press the **ENTER** or ► button.

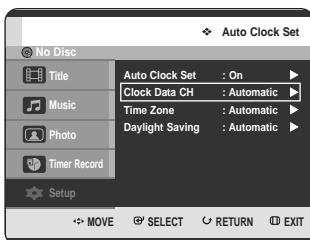

## Clock Data CH

Select a channel that carries a time signal using the ▲▼ buttons, then press the **ENTER** button.

- Select **Auto** to set the clock data channel automatically.

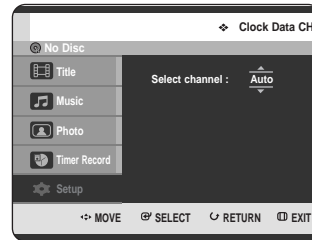

## Time Zone

Select the time zone of your area using the ▲▼ buttons then press the **ENTER** or ► button.

- Select **Automatic** to set the time zone automatically.

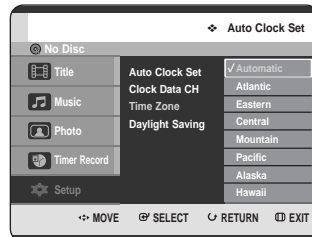

## Daylight Saving

Select **Automatic**, **No** or **Yes** using the ▲▼ buttons then press the **ENTER** or ► button.

- Select **Automatic** to set the daylight saving automatically.

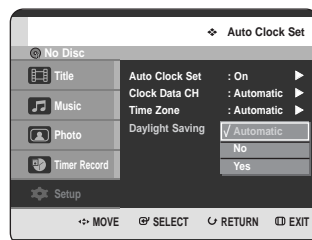

# Manual Clock Set

If your clock cannot be set automatically, set the clock manually.

**1** With the unit in Stop mode / No Disc mode, press the **MENU** button.

**2** Press the **▲▼** buttons to select **Setup**, then press the **ENTER** or **▶** button.

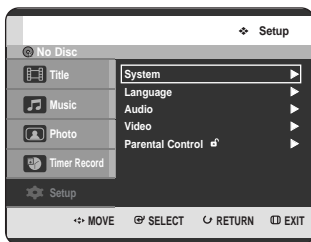

**3** Press the **▲▼** buttons to select **System**, then press the **ENTER** or **▶** button.

- System menu will be displayed.

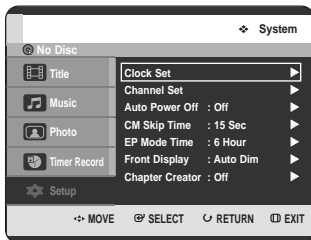

**4** Press the **▲▼** buttons to select **Clock Set**, then press the **ENTER** or **▶** button.

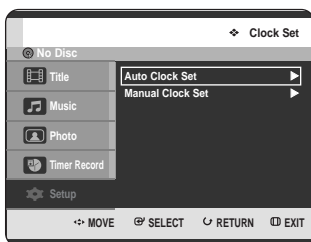

**5** Press the **▲▼** buttons to select **Manual Clock Set**, then press the **ENTER** or **▶** button.

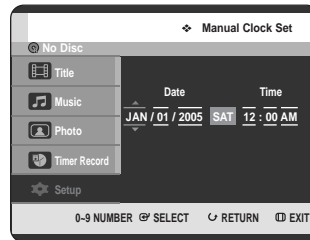

**6** Use the **▲▼◀▶** buttons to select the Current Date and Current Time, and then press the **ENTER** button.

When the current time is stored in memory and then the set is powered off, the current time will appear in the front panel display.

**▲▼** : Sets the value  
You can set the value using the number buttons.

**◀▶** : Moves to items

# Auto Channel Memory

You can set the Antenna/Cable TV settings automatically.

**1** With the unit in Stop mode / No Disc mode, press the **MENU** button.

**2** Press the **▲▼** buttons to select **Setup**, then press the **ENTER** or **▶** button.

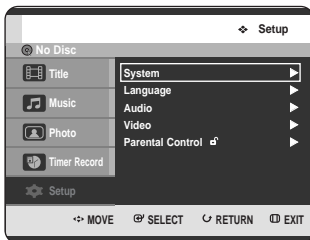

**3** Press the **▲▼** buttons to select **System**, then press the **ENTER** or **▶** button.  
 • System menu will be displayed.

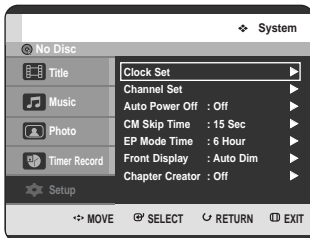

**4** Press the **▲▼** buttons to select **Channel Set**, then press the **ENTER** or **▶** button.

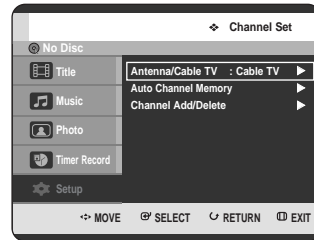

**5** Press the **▲▼** buttons to select **Antenna/Cable TV**, then press the **ENTER** or **▶** button.

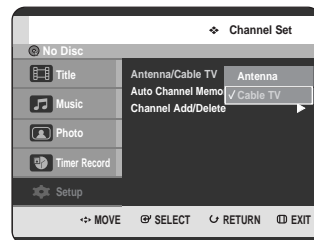

Select the item that matches the antenna connection you selected on pages 18~19(Method 1, 2 and 3).

**6** Select **Antenna** or **Cable TV**(depending on the hookup you chose) using the **▲▼** buttons, then press the **ENTER** or **▶** button.

**7** Select **Auto Channel Memory** using the **▲▼** buttons, then press the **ENTER** or **▶** button. Auto Channel Memory will be performed.

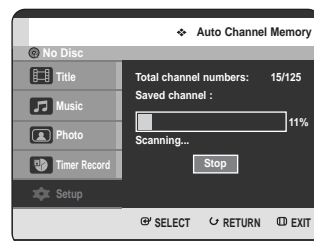

- Press the **RETURN** or **ENTER** button to stop Auto Channel Memory.

NOTE

# Manual Channel Set

Manual Channel Set can be used after you have first performed Auto Channel Memory. Use the Manual Channel Setting to delete unnecessary channels after using the Auto Channel Memory.

**1** With the unit in Stop mode / No Disc mode, press the **MENU** button.

**2** Press the **▲▼** buttons to select **Setup**, then press the **ENTER** or **▶** button.

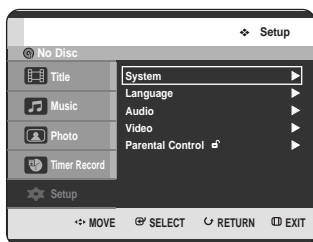

**3** Press the **▲▼** buttons to select **System**, then press the **ENTER** or **▶** button.

- System menu will be displayed.

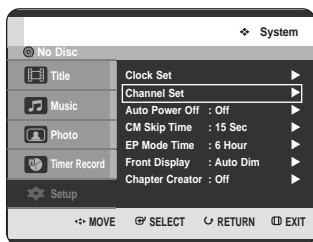

**4** Press the **▲▼** buttons to select **Channel Set**, then press the **ENTER** or **▶** button.

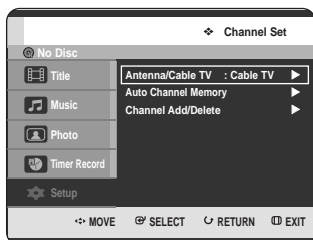

**5** Press the **▲▼** buttons to select **Channel Add/Delete**, then press the **ENTER** or **▶** button.

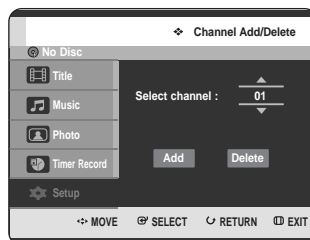

**6** Press the **▲▼** or number buttons to select the channels you want to add or delete on the **Select channel** screen. Then, press the **ENTER** button.

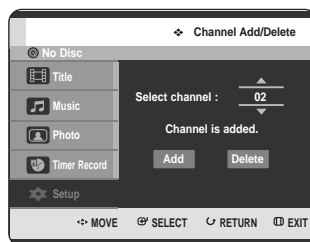

- Using **▲▼** buttons for channel selection allows the user to add/delete one channel at a time.
- Using **CH** (◀ ▶) buttons for channel selection jumps to the next channel memorized in Auto Channel Memory.

**7** Press the **◀▶** buttons to select **Add** or **Delete**, then press the **ENTER** button.

- The message "Channel is added." or "Channel is deleted." will be displayed in the center of the screen.
- Continue to add or delete as many channels as you want to memorize or delete. This can be used to add channels not stored automatically due to weak signal strength.
- Press the **RETURN** button to return to the previous menu. Press the **MENU** button to exit the menu.

## Auto Power Off Setting

This feature automatically turns off your TWIN TRAY DVD RECORDER, if you do not press any button for the selected time.

**1** With the unit in Stop mode / No Disc mode, press the **MENU** button.

**2** Press the **▲▼** buttons to select **Setup**, then press the **ENTER** or **▶** button.

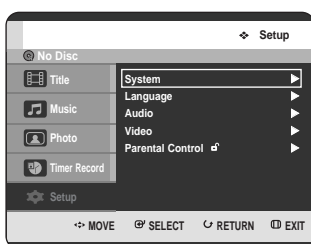

**3** Press the **▲▼** buttons to select **System**, then press the **ENTER** or **▶** button. System menu will be displayed.

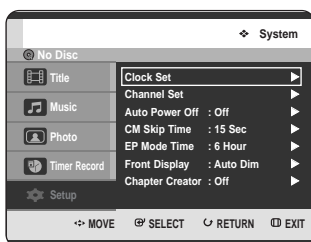

**4** Press the **▲▼** buttons to select **Auto Power Off**, then press the **ENTER** or **▶** button.

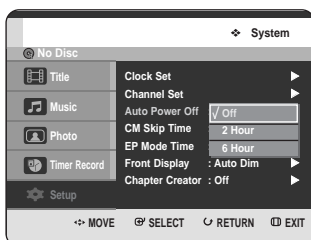

**5** Press the **▲▼** buttons to select the desired item, then press the **ENTER** or **▶** button.

- **Off** : Auto power off is disabled.
- **2 Hour** : TWIN TRAY DVD RECORDER will automatically turn off 2 hours after the last button is pressed.
- **6 Hour** : TWIN TRAY DVD RECORDER will automatically turn off 6 hours after the last button is pressed.

If turn off time set by automatic Power off function is reached during playback or recording, the device will operate until the playback or recording is over.

## CM Skip Time Setting

When a program recorded on a DVD-RAM, a DVD-RW, or a DVD-R is played, the unit can be set to automatically skip a portion of the program corresponding to a CM (commercial) skip time set by the user.

**1** With the unit in Stop mode / No Disc mode, press the **MENU** button.

**2** Press the **▲▼** buttons to select **Setup**, then press the **ENTER** or **▶** button.

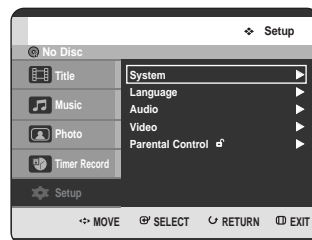

- 3** Press the ▲▼ buttons to select **System**, then press the **ENTER** or ► button. System menu will be displayed.

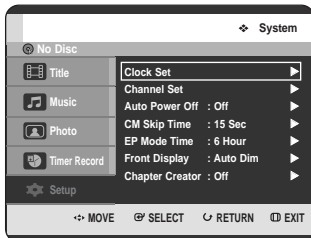

- 4** Press the ▲▼ buttons to select **CM Skip Time**, then press the **ENTER** or ► button.

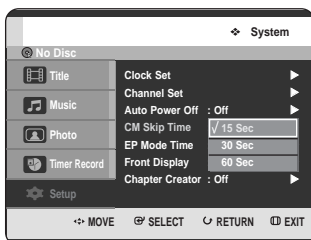

- 5** Press the ▲▼ buttons to select the desired time interval, then press the **ENTER** or ► button.

- 6** If you press the **CM SKIP** button during playback, the section corresponding to the set time is skipped, and then the next section is played.



NOTE

- CM Skip can be performed only during normal playback.
- When the time set is more than the remaining time of a current title: The next title is played from the beginning.
- When the time set is more than a remaining time of a play list, the next scene is played.
- CM Skip does not work in a still picture mode.
- When a set time is less than the remaining time of a scene, the last title, or the last track that is displayed currently, a prohibition mark appears.
- CM Skip releases Repeat (including Repeat A-B, Chapter, and Title).
- CM Skip may not operate with some DVD-Video discs.

## EP Mode Time Setting

You can select one of four recording modes by pressing the **REC MODE** button repeatedly.

EP mode is one of four REC modes (XP, SP, LP, EP) In EP(Extended Play) mode, you can set recording time to 6 or 8 hours.

- 1** With the unit in Stop mode / No Disc mode, press the **MENU** button.
- 2** Press the ▲▼ buttons to select **Setup**, then press the **ENTER** or ► button.

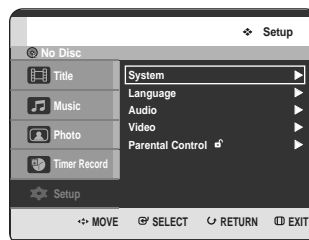



- 3** Press the ▲▼ buttons to select **System**, then press the **ENTER** or ► button. System menu will be displayed.

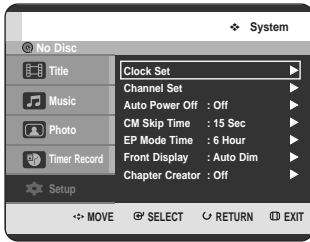

- 4** Press the ▲▼ buttons to select **EP Mode Time**, then press the **ENTER** or ► button.

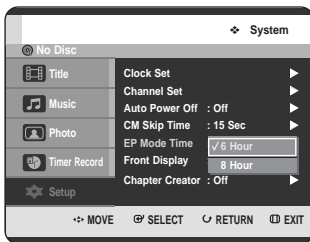

- 5** Press the ▲▼ buttons to select the desired time, then press the **ENTER** or ► button.

## Setting up the Front Display Options

You can adjust the brightness of the unit's front panel display.

- 1** With the unit in Stop mode / No Disc mode, press the **MENU** button.

- 2** Press the ▲▼ buttons to select **Setup**, then press the **ENTER** or ► button.

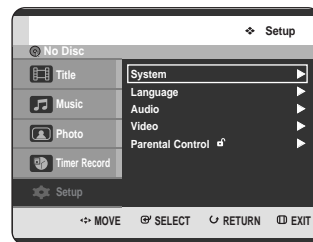

- 3** Press the ▲▼ buttons to select **System**, then press the **ENTER** or ► button. System menu will be displayed.

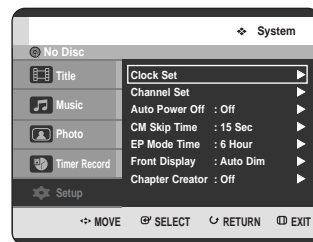

- 4 Press the ▲▼ buttons to select **Front Display**, then press the **ENTER** or ► button.

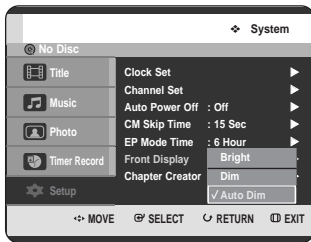

- 5 Press the ▲▼ buttons to select the desired item, then press the **ENTER** or ► button.
- **Bright** : Makes the Front Panel Display bright.
  - **Dim** : Makes the Front Panel Display dim.
  - **Auto Dim** : Makes the Front Panel Display dim automatically when the set is powered off.

- 3 Press the ▲▼ buttons to select **System**, then press the **ENTER** or ► button. System menu will be displayed.

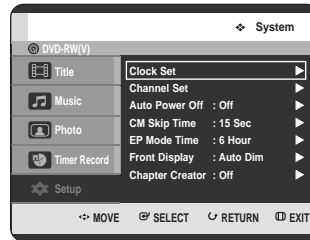

- V mode allows you to make a disc that will play in all DVD players. VR mode only allows playback on DVD recorders.

- 4 Press the ▲▼ buttons to select **Chapter Creator**, then press the **ENTER** or ► button.

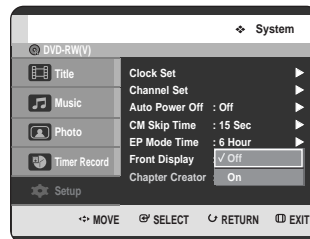

- 5 Press the ▲▼ buttons to select **Off** or **On**, then press the **ENTER** or ► button.

- **Off**: Select this option when you do not want Automatic Chapter Creator.
- **On**: Select this option when you want Automatic Chapter Creator.

Press the **MENU** button to exit the menu.

- 1 With the unit in Stop mode / No Disc mode, press the **MENU** button.

- 2 Press the ▲▼ buttons to select **Setup**, then press the **ENTER** or ► button.

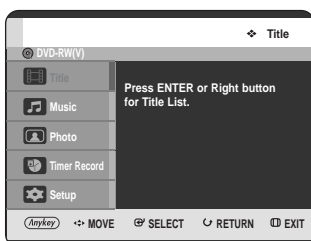

- 6 Press the **REC** button to start recording. (See pages 73~74 to set the recording speed) The message "Do you want to create the chapter menu after this recording?" is displayed.

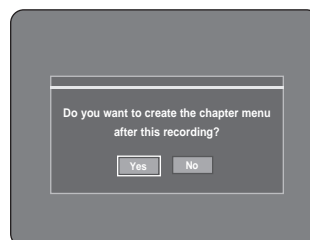

- 7** Press the ◀▶ buttons to select **Yes** and press the **ENTER** button.
- A new chapter is created according to the selected recording mode. A chapter will be about 5 minutes long in XP and SP, and about 15 minutes long in LP and EP mode.

- 8** Press the **STOP** button to stop recording.

- 9** To display the created titles, finalize the disc (See pages 106~107) and then press the **TITLE MENU** button. Title menu will be displayed.

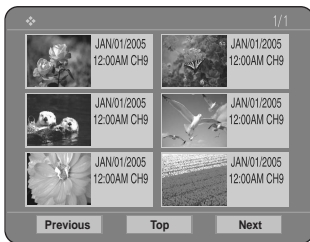

- 10** To display the created chapters, select the desired Title and then press the **DISC MENU** button. The chapter menu for the selected Title will be displayed.

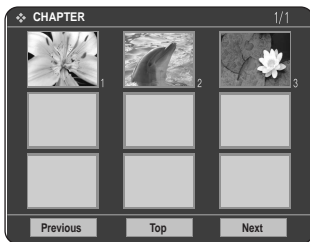

- !**  
Caution
- The Automatic Chapter Creator function does not work during Timer Recording or when you turn the power off.
  - The Automatic chapter creator function may not operate depending on the status of recording.

## Setting up the Language Options

If you set the On-Screen menu, disc menu, audio and subtitle language in advance, they will come up automatically every time you watch a movie. If the selected language is not recorded on the disc, the original pre-recorded language is selected.

- 1 With the unit in Stop mode / No Disc mode, press the **MENU** button.
- 2 Press the ▲▼ buttons to select **Setup**, then press the **ENTER** or ▶ button.

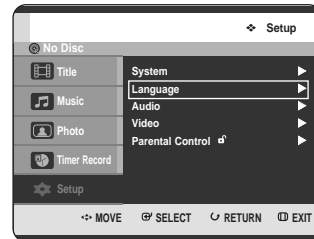

- 3 Press the ▲▼ buttons to select **Language**, then press the **ENTER** or ▶ button. Language setup menu will be displayed.

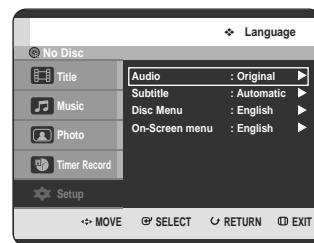

- 4 Press the ▲▼ buttons to select the desired language option, press the **ENTER** or ► button.

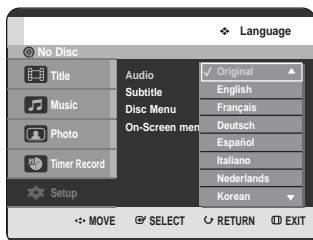

- **Audio** : For the disc audio language.
- **Subtitle** : For the disc subtitles.
- **Disc Menu**: For the disc menu contained on the disc.
- **On-Screen Menu**: For the on-screen menu of your TWIN TRAY DVD RECORDER.

- 5 Press the ▲▼ buttons to select the desired language, then press the **ENTER** or ► button.



NOTE

- Press the **RETURN** or ◀ button to return to the previous menu. Press the **MENU** button to exit the menu.
- The selected language will only appear if it is supported on the disc.

## Setting up the Audio Options

You can connect the TWIN TRAY DVD RECORDER to an external amp or Home theater.

The following allows you to setup the Audio device and sound status depending on the audio system in use.

- 1 With the unit in Stop mode / No Disc mode, press the **MENU** button.

- 2 Press the ▲▼ buttons to select **Setup**, then press the **ENTER** or ► button.

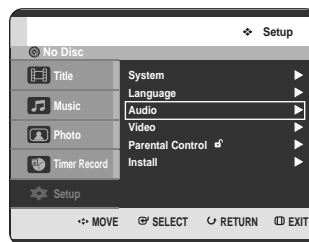

- 3 Press the ▲▼ buttons to select **Audio**, then press the **ENTER** or ► button. Audio setup menu will be displayed.

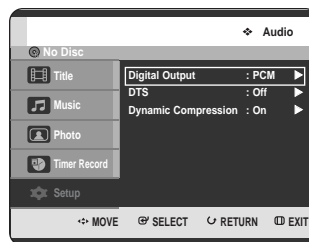

- 4 Press the ▲▼ buttons to select the desired audio option, then press the **ENTER** or ► button.

- 5 Press the ▲▼ buttons to select the desired item, then press the **ENTER** or ► button.



NOTE

- Press the **RETURN** or ◀ button to return to the previous menu. Press the **MENU** button to exit the menu.

## Digital Output

1. PCM : Select this when your equipment is not Dolby digital compatible.
2. Bitstream : Outputs Dolby Digital (or MPEG-2) audio as bitstream. Select this when your AV receiver or AV amplifier has a Dolby Digital (or MPEG-2) Decoder.



NOTE

- Digital output setting is equally applied to both Dolby Digital and MPEG-2 audio. LPCM sound track is always output as PCM. It cannot be changed with the Digital Output setting.
- Be sure to select the correct Digital Output or you will hear no sound or a loud noise.

## DTS

1. Off : Doesn't output DTS signal. Select this when your AV receiver or AV amplifier does not have a DTS decoder.
2. On : Outputs DTS Bitstream via the digital output when you play DTS track. Select this only when your AV receiver (or AV amplifier) has a DTS decoder.



NOTE

- When DTS soundtrack is played, sound is not output from the AV Audio Output. It only outputs from the Digital Audio Out.

## Dynamic Compression

This is only active when a Dolby Digital signal is detected.

1. On : When Movie soundtracks are played at low volume or from smaller speakers, the system can apply appropriate compression to make low-level content more intelligible and prevent dramatic passages from getting too loud.
2. Off : You can enjoy the movie with the standard Dynamic Range.

# Setting up the Video display Options

This function allows you to set up the TV screen settings. This function depends on disc type. It may not work for some disc types.

**1** With the unit in Stop mode / No Disc mode, press the **MENU** button.

**2** Press the **▲▼** buttons to select **Setup**, then press the **ENTER** or **▶** button.

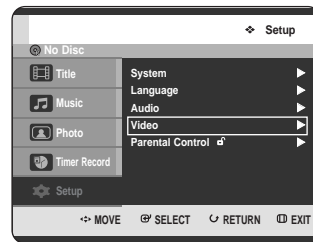

**3** Press the **▲▼** buttons to select **Video**, then press the **ENTER** or **▶** button. Video setup menu will be displayed.

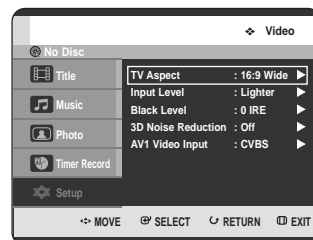

**4** Press the **▲▼** buttons to select the desired video option, then press the **ENTER** or **▶** button.

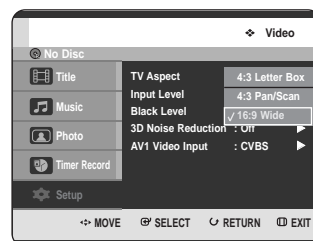

- 5** Press the ▲▼ buttons to select the desired item, then press the **ENTER** or ► button.



NOTE

- Press the **RETURN** or ◀ button to return to the previous menu.  
Press the **MENU** button to exit the menu.

## TV Aspect

Depending on the type of television you have, you may want to adjust the screen setting. (aspect ratio)

- 4:3 Letter Box** : Select when you want to see the total 16:9 ratio screen the DVD supplies, even though you have a TV with a 4:3 ratio screen. Black bars will appear at the top and bottom of the screen.

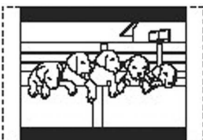

- 4:3 Pan/Scan** : Select this for conventional size TV when you want to see the central portion of the 16:9 screen. (Extreme left and right side of movie picture will be cut off.)

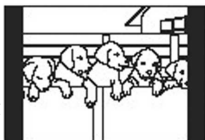

- 16:9 Wide** : You can view the full 16:9 picture on your widescreen TV.

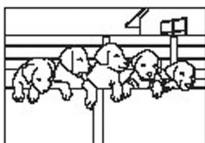

## Input Level

Adjusts the level of the input signal.

- Darker** : If you feel the screen is too light and you want to make the screen darker.
- Lighter** : If you feel the screen is too dark and you want to make the screen lighter.

## Black Level

Adjusts the black level of the screen.

- 0 IRE** : This is the standard NTSC reference black level for consistent brightness/contrast across all sources. Select this when you want darker screen.
- 7.5 IRE** : This will enhance the black level for increased brightness/contrast when viewing DVDs. Select this when you want lighter screen.

## 3D Noise Reduction (motion adaptive noise reduction)

- Off : Normal
- On : Provides a cleaner picture through noise reduction (for recording).

## AV1 VIDEO Input

- Composite:AV1 Video Input is Composite.
- S-Video:AV1 Video Input is S-Video.



NOTE

- Set the AV1 Video input setting to correspond to the input source.

## Setting up the Progressive scan

If the TV supports Progressive Scan, press the **P.SCAN** button on the front of the TWIN TRAY DVD RECORDER to enjoy. If you select 'progressive scan mode', the component cable has to be connected at first. (See page 21)

Be sure the Component cables are connected properly.

- With the unit in Stop mode / No Disc mode, press the **P.SCAN** button on the front of the TWIN TRAY DVD RECORDER.

The message "Press [Yes] to confirm Progressive scan mode. Otherwise, press [No]." will appear. Press the ◀► buttons to select **Yes**, and then press the **ENTER** button.

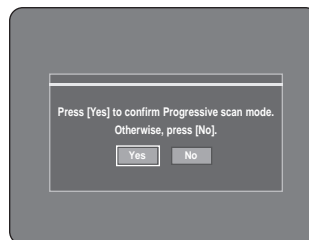

- 2** The message “Please, set your TV to Progressive input. To deactivate, press [STOP] key.” will appear. Press the **ENTER** button.



- 3** The message “Video Output Mode Progressive Scan” will appear.

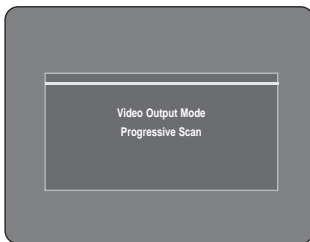

NOTE

- If the **P.SCAN** button on the TWIN TRAY DVD RECORDER's front panel is pressed during playback, the message “This function is possible only on stop mode” appears on the screen.
- Progressive setting is only available when the TWIN TRAY DVD RECORDER is in stop mode.

## Canceling the Progressive scan

- 1** With the unit in Stop mode / No Disc mode, press the **P.SCAN** button on the front of the TWIN TRAY DVD RECORDER.

The message “Press [Yes] to confirm Interlace scan mode. Otherwise, press [No].” will appear. Press the ◀ ▶ buttons to select **Yes**, and then press the **ENTER** button.

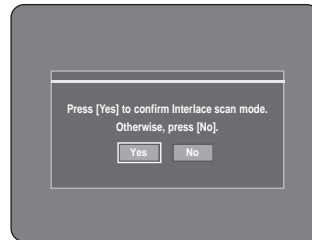

- 2** The message “Please, set your TV to Interlace input. To deactivate, press [STOP] key.” will appear. Press the **ENTER** button.



- 3** The message “Video Output Mode Interlace Scan” will appear and the Progressive Scan mode will be canceled.

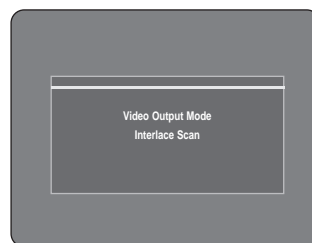



## NOTE

- Do not press the **P.SCAN** button if you are using a TV that does not support Progressive mode. Nothing will be displayed on the screen if pressed.
- If you press the **P.SCAN** button by mistake when your TV does not support Progressive mode, you need to release the Progressive mode. To release the Progressive mode, press the **P.SCAN** button on the front panel 3 times. The screen will recover after the PS  indicator on the front panel display turns off.

## Setting up the Parental Control

The Parental Control function works in conjunction with DVDs that have been assigned a rating which helps you control the types of DVDs that your family watches. There are up to 8 rating levels on a disc.



- With the unit in Stop mode / No Disc mode, press the **MENU** button.
- Press the **▲▼** buttons to select **Setup**, then press the **ENTER** or **▶** button.

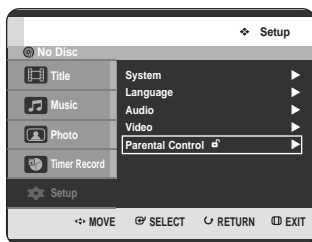

- Press the **▲▼** buttons to select **Parental Control**, then press the **ENTER** or **▶** button.

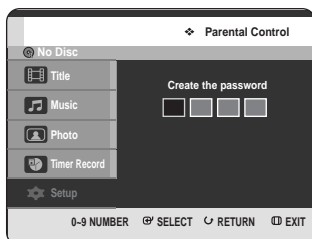

40 - English

- Enter the 4-digit password using the number buttons on the remote control. The "Confirm the password" message will be displayed. Enter your password again.

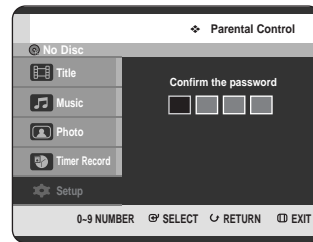

- Press the **ENTER** or **▶** button to select Password.

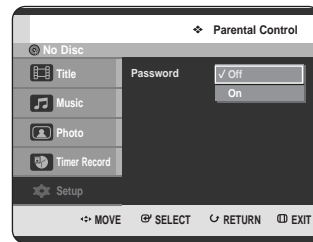

- Press the **▲▼** buttons to select **On** or **Off**, then press the **ENTER** or **▶** button.



## NOTE

- Press the **RETURN** or **◀** button to return to the previous menu. Press the **MENU** button to exit the menu.

### If you forgot your password

- Remove all discs and set the unit to **P(Play)** mode.
- Press and hold the **Forward Skip (▶▶)** button on the front panel for 5 seconds or more.



## About the Rating Level

- 1 Press the ▲▼ buttons to select **Rating Level**, then press the **ENTER** or ► button.

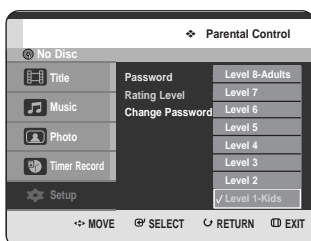
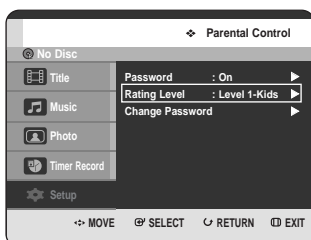

- 2 Press the ▲▼ buttons to select the rating level you want, then press the **ENTER** or ► button.

- 3 When you operate your TWIN TRAY DVD RECORDER for the first time, the "Create the Password" message will be displayed. For example, if you select up to Level 6, discs that contain Level 7, 8 will not play. A larger number indicates that the program is intended for adult use only.

## About the Change Password

- 1 Press the ▲▼ buttons to select **Change Password**, then press the **ENTER** or ► button.

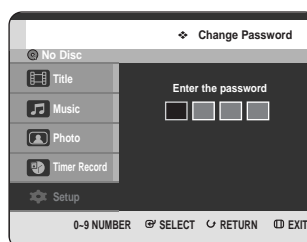
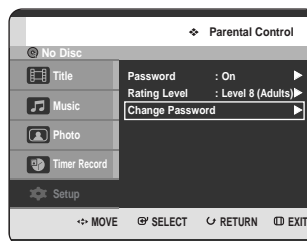

- 2 Enter the 4-digit password using the number buttons on the remote control. The "Confirm the password" message will be displayed.

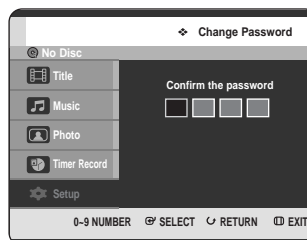

- 3 Enter your password again using the number buttons on the remote control.



- See page 40 if you forgot your password.

NOTE

# Playback

This section introduces basic functions of playback and playback by disc type.



Dolby Digital



DTS



Digital Audio



Stereo



NTSC broadcast system in U.S.A, Canada, Korea, Japan, etc.



MP3

Before Playing .....	42
Playing a Disc.....	43
Using the Disc Menu & Title Menu .....	44
Using the Search & Skip Functions .....	45
Slow Motion Play/Step Motion Play .....	46
About ANYKEY .....	46
Playing the Title List .....	48
Navigation Menu .....	49
Using the Markers.....	52
Using the Bookmarks.....	54
Selecting the Subtitle Language .....	56
Selecting the Soundtracks & Audio Channels .....	57
Changing the Camera Angle .....	58
Repeat Play .....	58
Zooming-In.....	60
Select Tray.....	61
Playing an Audio CD/MP3.....	61
Playing a Picture .....	68

## Before Playing

Read the following information before playing a disc.

### Region code (DVD-Video only)



Both the DVD RECORDER and the discs are coded by region. These regional codes must match in order for the disc to play. If the codes do not match, the disc will not play. The Region Number for this DVD RECORDER is described on the rear panel of the DVD RECORDER.



The Region Number for this DVD RECORDER is described on the rear panel of the DVD RECORDER.

### Disc types that can be played

Disc Types	Disc Logo	Recorded content	Disc Shape	Max. Playing Time
DVD-VIDEO		AUDIO + VIDEO	Single sided(5")	240
			Double sided(5")	480
			Single sided(3.5")	80
			Double sided(3.5")	160
AUDIO-CD		AUDIO	Single sided(5")	74
			Single sided(3.5")	20
DVD-RAM		AUDIO + VIDEO	Single-sided 5" (4.7GB)	1 (XP: Excellent Quality) 2 (SP: Standard Quality) 4 (LP: Long Playback) 6 or 8 (EP: Extended)
			Double-sided 5" (9.4GB)	2 (XP: Excellent Quality) 4 (SP: Standard Quality) 8 (LP: Long Playback) 12 or 16 (EP: Extended)
DVD-RW		AUDIO + VIDEO	5" (4.7GB)	1 (XP: Excellent Quality) 2 (SP: Standard Quality) 4 (LP: Long Playback) 6 or 8 (EP: Extended)
DVD-R		AUDIO + VIDEO	5" (4.7GB)	1 (XP: Excellent Quality) 2 (SP: Standard Quality) 4 (LP: Long Playback) 6 or 8 (EP: Extended)
CD-RW/R DVD-RAM/ -RW/R		JPEG MP3	-	-

### Discs that cannot be played

- DVD-Video with a region number other than "1" or "ALL"
- 12cm 2.6 GB and 5.2 GB DVD-RAM
- 3.9 GB DVD-R Disc for Authoring.
- DVD-RAM/-RW(VR mode) not recorded following the Video Recording Standard
- Unfinalized DVD-R, unfinalized DVD-RW(V mode) recorded on other equipment.
- PAL Disc
- DVD-ROM/DVD+RW/DVD+R/PD/MV-Disc/DiVX Video Disc, etc.
- CVD/SVCD/CD-ROM/CDV/CD-G/CD-I/SACD CD Layer



NOTE

- This TWIN TRAY DVD RECORDER can only operate with discs that are compatible with DVD-RAM Standard Version 2.0.
- Playback and/or recording may not work for some types of discs, or when specific operations, such as angle change and aspect ratio adjustment, are being performed. Please refer to information about the discs written in detail on the box.
- Do not allow the disc to become dirty or scratched, finger prints, dirt, dust, scratches or deposits of cigarette smoke on the recording surface may make it impossible to use the disc for recording.
- To protect a DVD-RAM disc from damage, use a cartridge.
- DVD-RAM/-RW/-R discs may not be able to play on some DVD players, depending on the player, disc and the condition of the recording.
- Discs with PAL programs recorded on them cannot be recorded using this product.
- P tray can play finalized DVD-R or DVD-RW(V) disc. If you want to play unfinalized DVD-R or DVR-RW(V) disc, you must only insert disc on R tray.

## Playing a Disc



Playback

- 1 Press the **OPEN/CLOSE** button.
- 2 Place a disc gently into the tray with the disc's label facing up.

- 3** Press **OPEN/CLOSE** button to close the disc tray.
- Your TWIN TRAY DVD RECORDER closes the disc tray and plays the disc automatically.
  - The TWIN TRAY DVD RECORDER does not play discs automatically after the initial power on.
  - When the TWIN TRAY DVD RECORDER is powered on and a disc is in the tray, the unit will be activated and wait in stop status.
  - Press the **PLAY**(▶) button to start playback.
  - If you insert an MP3 Disc, your TWIN TRAY DVD RECORDER will display the file list on the screen and start playing.
  - If you insert a JPEG Disc, folders and files are displayed in the thumbnail picture.
  - If you want the unit to play automatically when it is powered on with a disc in the unit, power on with the **PLAY**(▶) button.

- 4** Press the **STOP**(⏏) button to stop playback.



NOTE

- When you stop playing back a disc, the TWIN TRAY DVD RECORDER remembers where you stopped, so when you press **PLAY**(▶) button again, it will pick up where you left off. (Unless the disc is removed or the TWIN TRAY DVD RECORDER is unplugged, or if you press the **STOP**(⏏) button twice.).



Caution

- Do not move your TWIN TRAY DVD RECORDER while playing, as this may cause damage to the disc.
- Make sure to press the **OPEN/CLOSE** button to open or close the disc tray.
- Do not push the disc tray while it is being opened or closed, as this may cause a product malfunction.
- Do not place foreign materials on or in the disc tray.
- Some functions may perform differently or be disabled depending on the disc type. If this occurs, refer to the instructions written on the disc case.
- Be especially careful that children's fingers are not caught between the disc tray and the tray chassis when it closes.
- You must only insert one DVD disc at a time. Inserting two or more discs will not allow playback and may cause damage to the TWIN TRAY DVD RECORDER.

## Using the Disc Menu & Title Menu



Some type of discs contain a dedicated menu system that allows you to select special functions for title, chapter, audio track, subtitle, film preview, information on characters, etc.

### For DVD-VIDEO discs



- 1** Press the **DISC MENU** button to enter the disc's menu.
- Move to the setup menu related to the playback operation.
  - You can select the audio language and the subtitles provided by the disc.

- 2** Press the **TITLE MENU** button to move to the disc's title menu.
- Use this button if the disc contains more than one title.  
Some type of discs may not support the title menu function.

### For DVD-RAM/-RW/-R Disc



- 1** Press the **TITLE LIST** button to display title list.



NOTE

- **Title List** : Title List is a list of previously recorded programs. If a title is deleted, that title cannot be played again.
- **Play List** : This refers to a list of user-selected titles. When one playlist is played, only the scene selected by the user will play and then stop. Since only the information necessary for playing a desired scene is included in a playlist, even if that playlist is deleted, the original recording will not be deleted. (only VR mode)

# Using the Search & Skip Functions

## Searching through a Chapter or Track



- 1 During play, press the **SEARCH** (⏮ ⏭) buttons on the remote control.

DVD-VIDEO/ DVD-RAM/-RW/-R	▶▶ Fast X 2 → ▶▶ Fast X 4 → ▶▶ Fast X 8 → ▶▶ Fast X 16 → ▶▶ Fast X 32 → ▶▶ Fast X 128
AUDIO CD (CD-DA)	▶▶ X 2 → ▶▶ X 4 → ▶▶ X 8

- You can scan the program in reverse. To return to normal speed playback, press the **PLAY** (⏪) button.
- When you press and hold the **SEARCH** (⏮ ⏭) buttons, playback is done at the default speed of X4. If you release the **SEARCH** (⏮ ⏭) buttons, playback is performed at a normal speed.
- The speed marked in this function may be different from the actual playback speed.



- No sound is heard during Scan(Search) mode, except when using CDs (CD-DA).

## Skipping Chapters, a Tracks or Markers

During play, you can search quickly through a chapter or track.

- 1 During play, press the **SKIP** (⏮ ⏭) buttons on the remote control.

- If you press the **SKIP** (⏮) button, it moves to the beginning of the chapter or track or marker(DVD-RAM/-RW(VR mode)). Pressing the button once again within 3 seconds returns to the beginning of the previous chapter or track or marker(DVD-RAM/-RW(VR mode)).
- If you press the **SKIP** (⏭) button, it moves to the next chapter, track or marker (DVD-RAM/-RW(VR mode)).



- This function will not operate if a selected title does not have Chapters, Tracks or Markers.

## Slow Motion Play/ Step Motion Play

### Slow Motion Play



In pause or step mode, press the **SEARCH** (◀▶) buttons on the remote control.

- If you press the **SEARCH** (▶) button,  
▶ Slow 1/8 → ▶ Slow 1/4 → ▶ Slow 1/2
- If you press the **SEARCH** (◀) button,  
◀ Slow 1/8 → ◀ Slow 1/4 → ◀ Slow 1/2
- To return to normal speed playback, press the **PLAY** (▶) button.

Press and hold the **SEARCH** (◀▶) buttons during pause, the disc will play slowly at a 1/4 speed. If the button is released, the pause operation will resume.

### Step Motion Play



Press the **STEP** (◀▶) buttons on the remote control in the pause mode.

- Each time the button is pressed, a new frame will appear.  
When the **STEP** (◀) button is pressed, the previous frame will be activated.  
When the **STEP** (▶) button is pressed, the next frame will be activated.
- To return to normal speed playback, press the **PLAY** (▶) button.

## About ANYKEY

The ANYKEY function allows you to easily search for a desired scene by accessing title, chapter, track, time. You can also change the subtitle and audio settings and set some features including Marker, Angle, Zoom, Repeat, Select Tray, Disc Manager, Navigation, Rec. mode.

### Moving to a scene directly using the ANYKEY

- If you want to move to a title, a chapter or a track to find a desired scene.



#### - Using Title, Chapter or Track -

- 1 Press the **ANYKEY** button during playback.

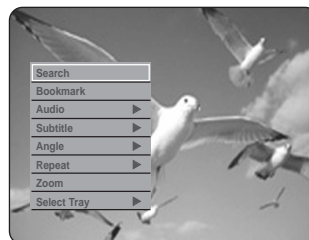

- 2 Press the ▲▼ buttons to select **Search**, then press the **ENTER** or ▶ button.



---

**3** Press the ▲▼ buttons to select **Title**, **Chapter** or **Track**.

---

**4** Press the ◀▶ buttons or number buttons to select the desired scene, then press the **ENTER** button.

- If you want to move to a desired time following will help you find a scene.



NOTE

- This may not work for some discs. When an audio CD(CD-DA) or an MP3 disc is inserted, according to a disc type, the information display may not appear.
  - The Time Search function does not operate in some discs.
  - To make the screen disappear, press the **ANYKEY** button again
- 

### - Using Time -

---

**1** Press the **ANYKEY** button during playback.

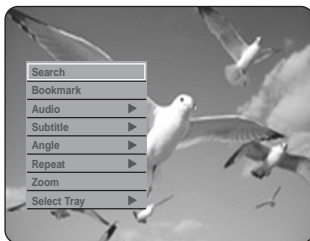

**2** Press the ▲▼ buttons to select **Search**, then press the **ENTER** or ▶ button.



**3** Press the ▲▼ buttons to select **Time**.

---

**4** Enter the time in the sequence of hours, minutes, and seconds using the number buttons, then press the **ENTER** button.

---

# Playing the Title List

Follow these instructions to play back a scene from the Title List.



## Using the TITLE LIST button

- 1 With the unit in Stop mode/Playback mode, press the **TITLE LIST** button.  
The Title List screen is displayed.

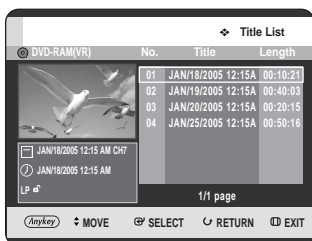

## Using the MENU button.

- With the unit in Stop mode/Playback mode, press the **MENU** button.

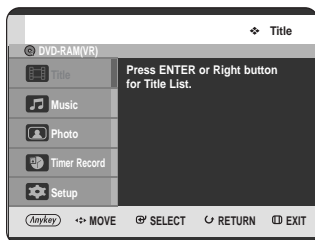

- Press the **▲▼** buttons to select **Title**, then press the **ENTER** or **▶** button.

- 2 Press the **▲▼** buttons to select an entry you want to play from Title List, then press the **ENTER** or **PLAY (⊕)** button.  
The selected entry (title) will be played back.

## - About INFO button -

If you press the **INFO** button once during playback, Disc information screen appears.: Displays Total numbers of Titles and Playlists, Recordable Time(Title), Available Space(Music/Photo).

DVD-RAM(VR) Disc Info	
Disc Name	01/01 CH7
Total Title	13
Total Playlist	None
Recordable Time	01:48 SP
Protection	Not Protected
JAN/01/2005 (SAT)	AM 12:00

Pressing the **INFO** button twice, Current playback information screen appears.: Displays information of Playback Name, Title, Created Time, Length, Playing Time, Audio, and if the disc protection is activated.

DVD-RAM(VR) Playing Info	
Name	01/01 CH7
Title	1/13
Created Time	JAN/01/2005 12:39 AM
Length	00:02:27 LP
Playing Time	00:02:07
Audio	Dolby Digital 2CH
Title Protection	Not Protected
JAN/01/2005 (SAT)	AM 12:00

- 3 To stop title play, press the **STOP(⊖)** button.  
To return the title list screen, press the **TITLE LIST** button.



# Navigation Menu

## Scene Navigation

If there is a title composed of markers (see page 52), you can search the desired scene using the Scene Navigation.



### Using the TITLE LIST button

- 1 With the unit in Stop mode/Playback mode, press the **TITLE LIST** button. The Title List screen is displayed.

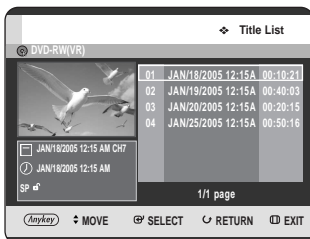

### Using the MENU button.

- With the unit in Stop mode/Playback mode, press the **MENU** button.

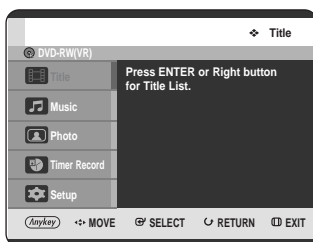

- Press the **▲▼** buttons to select **Title**, then press the **ENTER** or **▶** button.

- 2 Press the **▲▼** buttons to select an entry you want to play from Title List, then press the **ANYKEY** button.

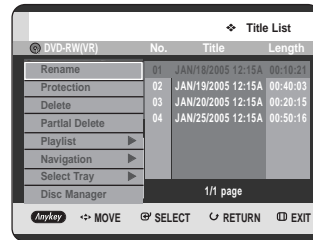

- 3 Press the **▲▼** buttons to select **Navigation**, then press the **ENTER** or **▶** button.

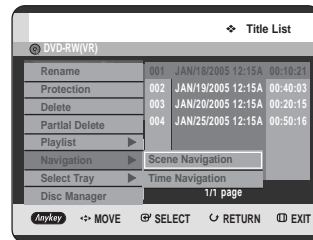

- 4 Press the **▲▼** buttons to select **Scene Navigation**, then press the **ENTER** or **▶** button.

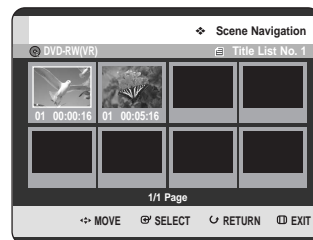

- 5 Press the **▲▼◀▶** buttons to select desired scene, then press the **ENTER** or **PLAY (▶)** button.

ANYKEY

## Using the ANYKEY button

- 1 Press the **ANYKEY** button during playback.

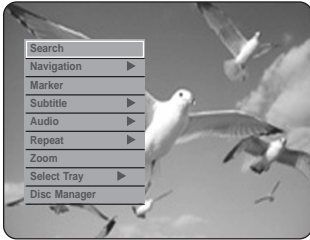

- 2 Press the **▲▼** buttons to select **Navigation**, then press the **ENTER** or **▶** button.



- 3 Press the **▲▼** buttons to select **Scene Navigation**, then press the **ENTER** or **▶** button.

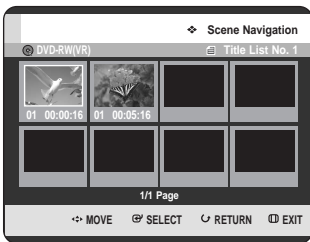

- 4 Press the **▲▼◀▶** buttons to select desired scene, then press the **ENTER** or **PLAY (⏪)** button.



NOTE

- Scene Navigation will not operate if a selected title does not have Markers.

## Time Navigation

Using this function, you can search scene minute-by-minute from the recorded title list.



(VR mode)



## Using the TITLE LIST button

- 1 With the unit in Stop mode/Playback mode, press the **TITLE LIST** button. The Title List screen is displayed.

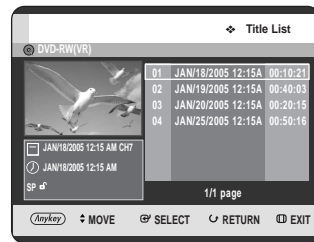

### Using the MENU button.

- With the unit in Stop mode/Playback mode, press the **MENU** button.

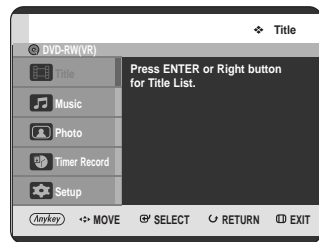

- Press the **▲▼** buttons to select **Title**, then press the **ENTER** or **▶** button.

- 2 Press the ▲▼ buttons to select an entry you want to play from Title List, then press the ANYKEY button.

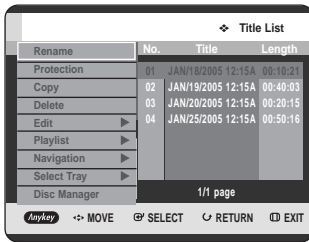

- 3 Press the ▲▼ buttons to select **Navigation**, then press the ENTER or ► button.

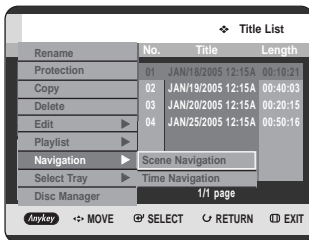

- 4 Press the ▲▼ buttons to select **Time Navigation**, then press the ENTER or ► button.

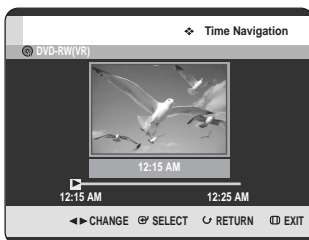

- 5 Press the ◀▶ buttons to skip one minute at a time and search the desired scene, then press the ENTER or PLAY (⏪) button.

ANYKEY

## Using the ANYKEY button

- 1 Press the ANYKEY button during playback.

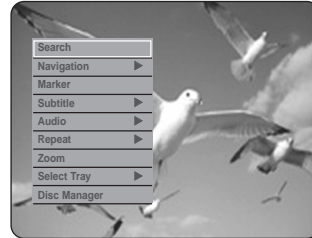

- 2 Press the ▲▼ buttons to select **Navigation**, then press the ENTER or ► button.

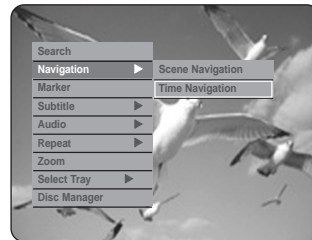

- 3 Press the ▲▼ buttons to select **Time Navigation**, then press the ENTER or ► button.

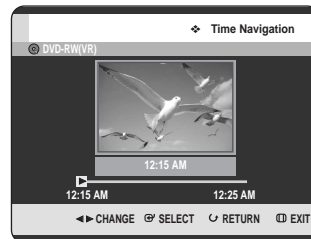

- 4 Press the ◀▶ buttons to skip one minute at a time and search the desired scene, then press the ENTER or PLAY (⏪) button.



- Cursor does not move if selected recorded title is shorter than 1 minute.
- The Navigation function may not work with discs recorded on another manufacturer's unit.
- An edited title may not display exact search time.

# Using the Markers



You can set marks on a disc so that you can start playback from the marked position. This function is available on the R tray in the VR mode.



## Using the MARKER button

- 1 Press the **MARKER** button during playback.

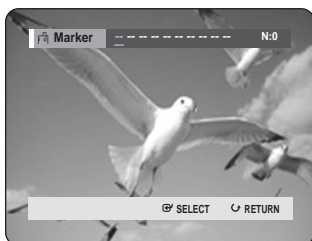

### Using the ANYKEY button.

- Press the **ANYKEY** button during playback.

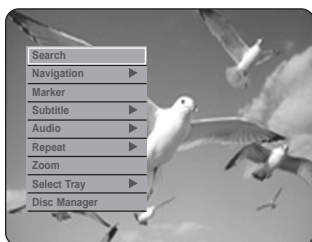

- Press the **▲▼** buttons to select **Marker**, then press the **ENTER** or **▶** button.

- 2 Press the **ENTER** button when the desired scene appears.
  - The number **01** is displayed and the scene is memorized.



- 3 Press the **◀▶** buttons to move to the next position.

- 4 Press the **ENTER** button again when the desired scene appears.
  - The number **02** is displayed and the scene is memorized.

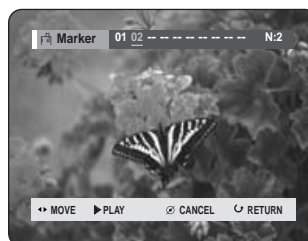

- DVD-RAM or DVD-RW (VR Mode) discs have the Marker function instead of the Bookmark function. The Marker function allows you to mark up to 99 scenes. Since the scenes may be displayed as many different pages, numbering is necessary. If a disc in use is encoded with Cartridge Protection or Disc Protection, Markers cannot be set or deleted. Only playback is available.



NOTE

- When the disc tray is opened and then closed, marks will disappear.

## Playing back a marker



### Using the MARKER button

- 1 Press the **MARKER** button during playback.



### Using the ANYKEY button.

- Press the **ANYKEY** button during playback.

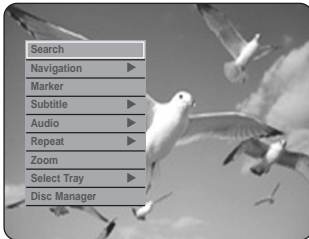

- Press the **▲▼** buttons to select **Marker**, then press the **ENTER** or **▶** button.

- 2 Press the **◀▶** buttons to select a marked scene.



- 3 Press the **ENTER** or **PLAY (▶)** button to start playing from the selected scene.

- If you press the **SKIP (⏮)** button, it moves to the beginning of the marker. Pressing the button once again within 3 seconds returns to the beginning of the previous marker.
- If you press the **SKIP (⏭)** button, it moves to the next marker.

## Clearing a marker



### Using the MARKER button

- 1 Press the **MARKER** button during playback.

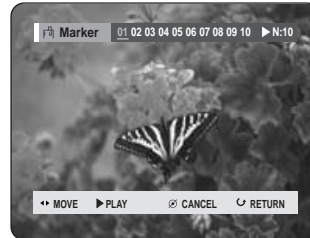

### Using the ANYKEY button.

- Press the **ANYKEY** button during playback.

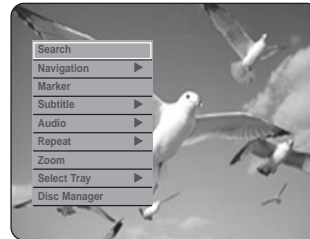

- Press the **▲▼** buttons to select **Marker**, then press the **ENTER** or **▶** button.

- 2 Press the **◀▶** buttons to select a marked scene. Press the **CANCEL** button to delete the selected mark.

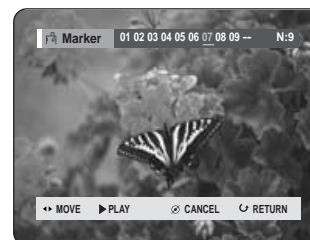
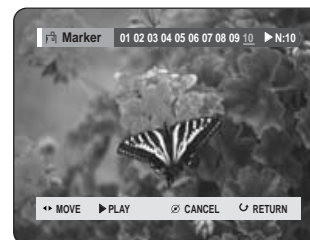

- When a marker is cleared while DVD-RAM/-RW (VR mode) is playing, marker numbers will change. For example, if the 7th marker is cleared after ten markers are registered, the marker numbers after the eighth will automatically move ahead by one and the 8th marker becomes the 7th.

## Using the Bookmarks



### Using the MARKER button

- 1 Press the **MARKER** button during playback.

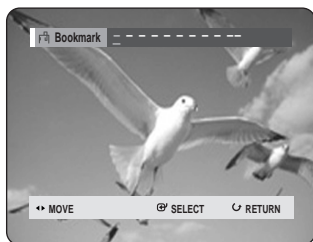

### Using the ANYKEY button.

- Press the **ANYKEY** button during playback.

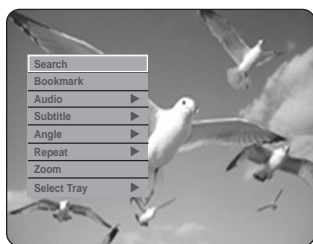

- Press the **▲▼** buttons to select **Bookmark**, then press the **ENTER** or **▶** button.

- 2 Press the **ENTER** button when the desired scene appears.

- The number 1 is displayed and the scene is memorized.

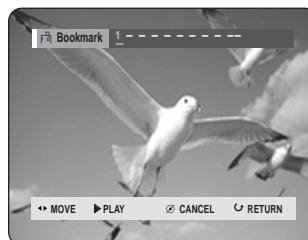

- 3 Press the **◀▶** buttons to move to the next position.

- 4 Press the **ENTER** button again when the desired scene appears. The number 2 is displayed and the scene is memorized.

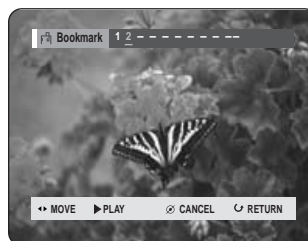

- Repeat above to bookmark other positions.
- You can bookmark up to 10 scenes.



### NOTE

- When the disc tray is opened and then closed, bookmarks will disappear.

## Playing back a bookmark



### Using the MARKER button

- 1 Press the **MARKER** button during playback.

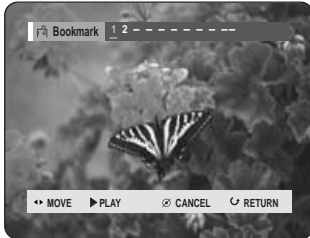

### Using the ANYKEY button.

- Press the **ANYKEY** button during playback.



- Press the ▲▼ buttons to select **Bookmark**, then press the **ENTER** or ► button.

- 2 Press the ◀▶ buttons to select a bookmarked scene.

- 3 Press the **ENTER** or **PLAY** (▶) button to start playing from the selected scene.

## Clearing a bookmark



### Using the MARKER button

- 1 Press the **MARKER** button during playback.



### Using the ANYKEY button.

- Press the **ANYKEY** button during playback.



- Press the ▲▼ buttons to select **Bookmark**, then press the **ENTER** or ► button.

- 2 Press the ◀▶ buttons to select a bookmarked scene.

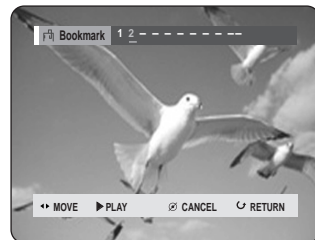

- 3 Press the **CANCEL** button to delete the selected bookmark.

# Selecting the Subtitle Language

Selects one of the subtitle languages recorded on the disc.



## Using the SUBTITLE button

- 1 Press the **SUBTITLE** button during playback.

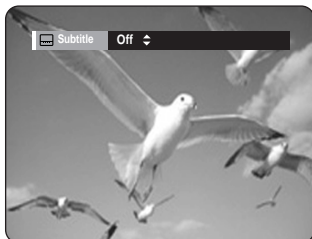

- 2 Press the ▲▼ buttons to select the desired subtitle language. Also, press the **SUBTITLE** button repeatedly to select the desired subtitle language.

- To make the screen disappear, press the **CANCEL** or **RETURN** button.

ANYKEY

## Using the ANYKEY button

- 1 Press the **ANYKEY** button during playback.

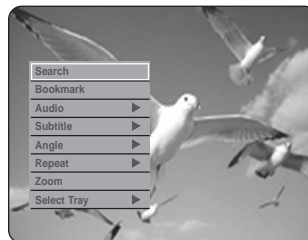

- 2 Press the ▲▼ buttons to select **Subtitle**, then press the **ENTER** or ► button.

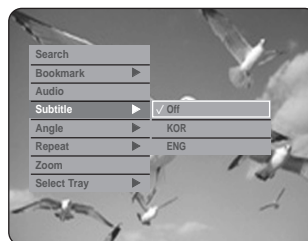

- 3 Press the ▲▼ buttons to select the desired subtitle language, then press the **ENTER** or ► button.



NOTE

- The subtitle display may be different depending on the disc type.
- Some discs allow you to select the language for the disc menu only.
- If the subtitles overlap, disable the caption function on your TV.



# Selecting the Soundtracks & Audio Channels

## Selecting the Audio

Selects one of the soundtracks recorded on the disc. Also selects the audio channels.



## Using the AUDIO button

- 1 Press the **AUDIO** button during playback.

DVD-VIDEO

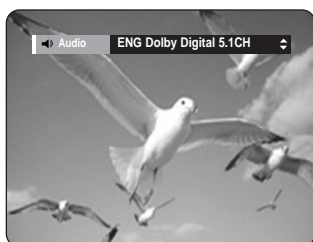

DVD-RAM/-RW

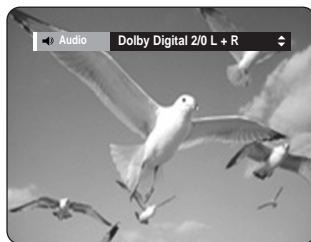

- 2 To select the desired soundtrack or audio channel, press the **▲▼** buttons or press the **AUDIO** button repeatedly.
  - To make the screen disappear, then press the **CANCEL** or **RETURN** button.

ANYKEY

## Using the ANYKEY button

- 1 Press the **ANYKEY** button during playback.

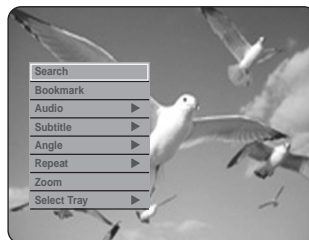

- 2 Press the **▲▼** buttons to select **Audio**, then press the **ENTER** or **▶** button.

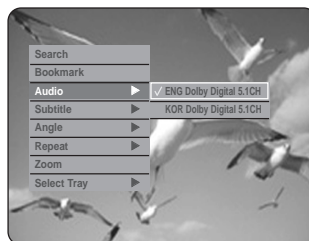

- 3 Press the **▲▼** buttons to select the desired soundtracks or audio channel, then press the **ENTER** or **▶** button.



NOTE

- Soundtracks or Audio channel may be different because they are disc-specific.
- Some discs allow you to select the audio language for the disc menu only.

## Changing the Camera Angle

When a DVD-VIDEO contains multiple angles of a particular scene, you can select the Angle function.



ANYKEY

### Using the ANYKEY button

- 1 Press the **ANYKEY** button during playback.



- 2 Press the **▲▼** buttons to select **Angle**, then press the **ENTER** or **▶** button.

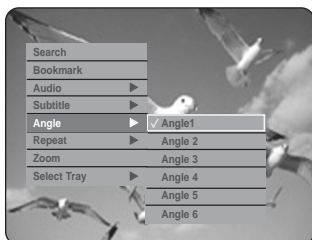

- 3 Press the **▲▼** buttons to select the desired angle, then press the **ENTER** or **▶** button.



NOTE

- This function is disc-dependent, and may not work on all DVDs.
- This function does not work when a DVD has not been recorded with a multi-camera angle system.

## Repeat Play

### Playing Repeatedly(Repeat Playback)



### Using the REPEAT button

- 1 Press the **REPEAT** button during playback.

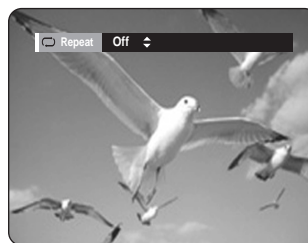

- 2 Press the **▲▼** buttons to select the **Off**, **Title** or **Chapter** you want to play repeatedly, then press the **ENTER** button.

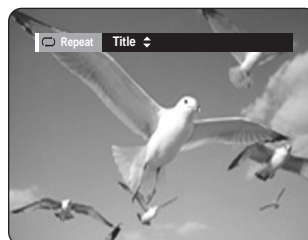

## Using the ANYKEY button

- 1 Press the **ANYKEY** button during playback.

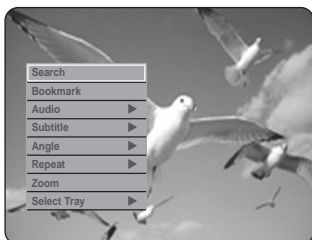

- 2 Press the **▲▼** buttons to select **Repeat**, then press the **ENTER** or **▶** button.

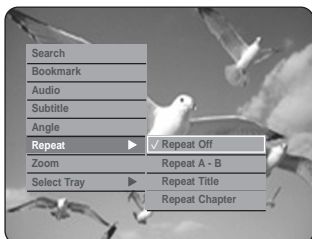

- 3 Press the **▲▼** buttons to select **Repeat Off**, **Repeat A-B**, **Repeat Title** or **Repeat Chapter** you want to play repeatedly, then press the **ENTER** or **▶** button.



NOTE

- DVD-RAM/-RW(VR mode), unfinalized DVD-R and unfinalized DVD-RW (V mode) do not repeat a chapter.

## Repeat A-B



### Using the REPEAT A-B button

- 1 Press the **REPEAT A-B** button during playback.

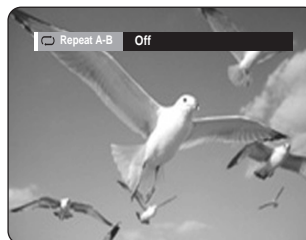

- 2 Press the **ENTER** button at the point where you want the repeat play to start (A) and press it again at the point where you want the repeat play to stop (B). Repeat playback of the A-B section starts.

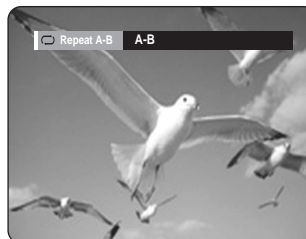



## Using the ANYKEY button

**1** Press the **ANYKEY** button during playback.

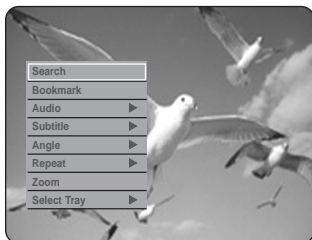

**2** Press the **▲▼** buttons to select **Repeat**, then press the **ENTER** or **▶** button.

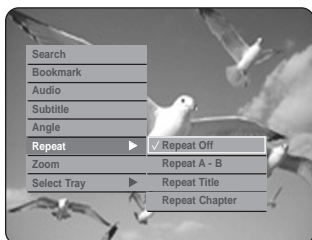

**3** Press the **▲▼** buttons to select **Repeat A-B**, then press the **ENTER** or **▶** button.

**4** Press the **ENTER** button at the point where you want the repeat play to start (A) and press it again at the point where you want the repeat play to stop (B). Repeat playback of the A-B section starts.



- If you set point (B) before five seconds of playback time has elapsed, the prohibition mark (⊘) will appear.
- You can also return to Normal Playback by pressing the **CANCEL** button.
- Audio CDs (CD-DA) and MP3 discs do not support the Repeat A-B function.

## Zooming-In



**1** Press the **ANYKEY** button during playback.

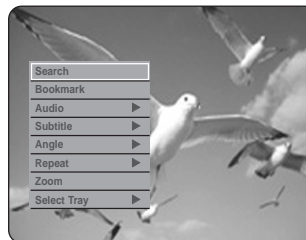

**2** Press the **▲▼** buttons to select **Zoom**, then press the **ENTER** or **▶** button. (⊕) will be displayed.



**3** Press **▲▼◀▶** buttons to move to the area you want to enlarge.

**4** Press the **ENTER** button. The screen will be enlarged to twice the normal size. The screen size will be enlarged to four times the normal size.

DVD-VIDEO/ DVD-RAM/-RW/-R	normal size → x2 → x4 → x2 → normal size
------------------------------	---



- When recording is done in the EP mode, the Zoom function will not be supported except when the recording has been done in V mode.

# Select Tray



- 1 Press the **ANYKEY** button during playback.



- 2 Press the **▲▼** buttons to select **Select Tray**, then press the **ENTER** or **▶** button.

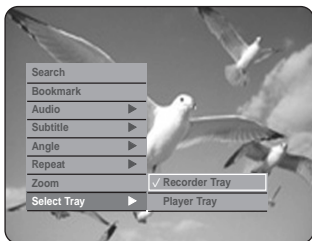

- 3 Press the **▲▼** buttons to select **Recorder Tray** or **Player Tray**, then press the **ENTER** or **▶** button.

# Playing an Audio CD/MP3



## Playing an Audio CD(CD-DA)

- 1 Insert an audio CD (CD-DA) into the disc tray.
  - The audio CD menu appears and the tracks (songs) are played automatically.

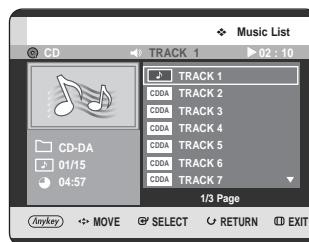

- 2 Press the **▲▼** buttons to select the track (song) you want to hear, and then press the **ENTER** button.

## Audio CD(CD-DA) Screen Elements

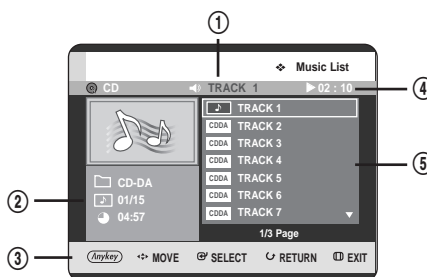

1. **Current track (song):** Displays the number of the track currently being played.
2. Displays the current play index, total track number.
3. Display available buttons.
4. This shows the operating state of a disc and a playback time corresponding to a portion that is currently played.
5. Displays the track list (song list).

## Buttons on the Remote Control used for Audio CD(CD-DA) playback

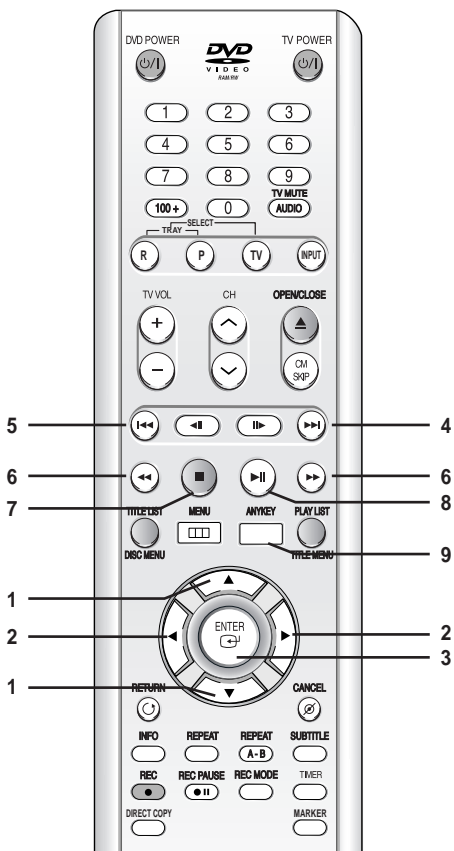

1. ▲▼: Selects a track (song).
2. ◀▶: Scrolls the page up/down.
3. **ENTER button**: Plays the selected track (song).
4. **SKIP (⏭) button**: Plays the next track.
5. **SKIP (⏮) button**: Returns to the beginning of the current track when pressed during playback. If pressed again, your TWIN TRAY DVD RECORDER moves to and plays the previous track. If you press the this button within three seconds after playback starts, the previous track will be played. If you press the this button after three seconds, the current track will be replayed from the beginning.
6. **Press the SEARCH (🔍) buttons**:  
Fast Play (X2, X4, X8)
7. **STOP (⏹) button**: Stops a track(song).
8. **PLAY (⏪) button**: Plays a track(song) or pauses playback.
9. **ANYKEY button**: The ANYKEY menu is displayed. (Play Mode, Go To Playlist, New Playlist or Select Tray).

## Playing an MP3 Disc

1. Insert an MP3 disc into the disc tray.
  - The MP3 menu is displayed and the tracks (songs) are played automatically.

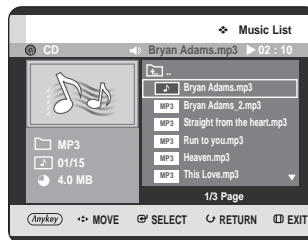

2. Press the ▲▼ buttons to select the track you want to hear, and then press the **ENTER** button.

## MP3 Screen Elements

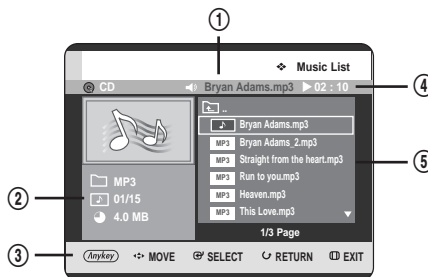

1. **Current track (song)**: Displays the name of the track being played.
2. Displays the current folder, play index and current track size.
3. Displays available buttons.
4. This shows the operating state of a disc and a playback time corresponding to a portion that is currently played.
5. Displays the information for the folder and its tracks.



NOTE

- If a disc contains only MP3 files or only JPEG files, the MP3 or JPEG screen appears after the disc is loaded.
- If a disc contains a mix of MP3 and JPEG files, you need to select Music for MP3 files or Photo for JPEG files.

## Buttons on the Remote Control used for MP3 playback

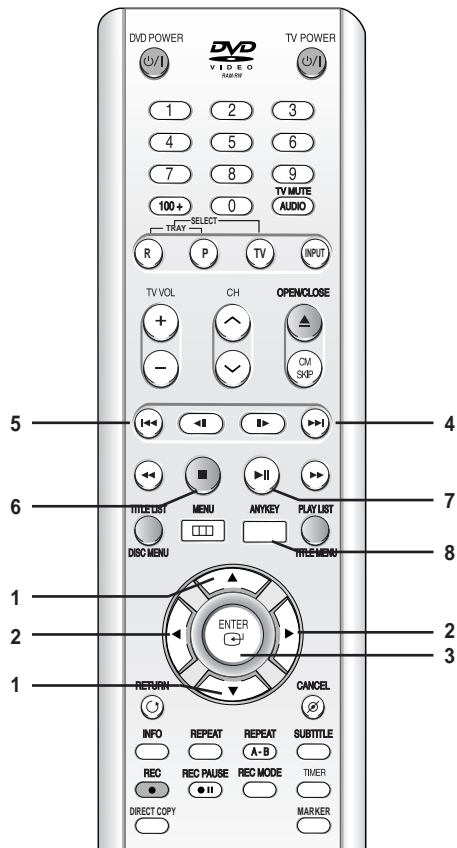

1. **▲▼**: Selects a track (song).
2. **◀▶**: Move the page up/down.
3. **ENTER button**: Plays the selected track (song).
4. **SKIP (⏮) button**: Plays the next track.
5. **SKIP (⏭) button**: Returns to the beginning of the current track when pressed during playback. If pressed again, your TWIN TRAY DVD RECORDER moves to and plays the previous track. If you press the this button within three seconds after playback starts, the previous track will be played. If you press the this button after three seconds, the current track will be replayed from the beginning.
6. **STOP (⏹) button**: Stops a track(song).
7. **PLAY (⏮) button**: Plays a track(song) or pauses playback.
8. **ANYKEY button**: The ANYKEY menu is displayed. (Play Mode, Go To Playlist, New Playlist or Select Tray).

## Repeat CD (CD-DA) & MP3



Using the REPEAT button.

- 1 Press the REPEAT button during playback.

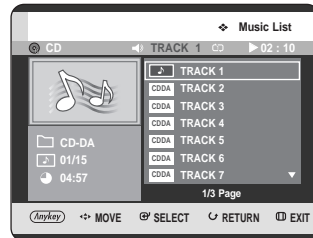

- 2 Press the REPEAT button repeatedly to select the repeat mode you want.

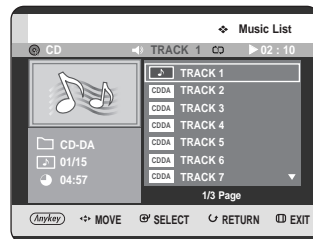

- **Repeat Track (CD (CD-DA)/MP3)**
- **Repeat Folder (MP3)**
- **Repeat All (CD (CD-DA)/MP3)**
- **Random (CD (CD-DA)/MP3)**: The random option plays a disc's track in random order.
- **Normal (CD (CD-DA)/MP3)**: Track on a disc are played in the order in which they were recorded on the disc.

- To return to normal playback -

- 3 Press the REPEAT or CANCEL button repeatedly to return to normal playback.



## Using the ANYKEY button.

- 1 Press the **ANYKEY** button during the Music List playback.

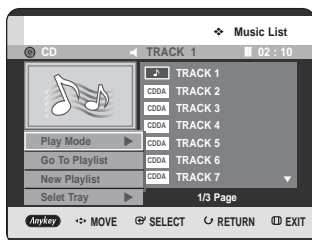

- 2 Press the **▲▼** buttons to select **Play Mode**, then press the **ENTER** or **▶** button.



- 3 Press the **▲▼** buttons to select desired play mode, then press the **ENTER** or **▶** button.

- **Normal (CD (CD-DA)/MP3):** Track on a disc are played in the order in which they were recorded on the disc.
- **Repeat Track (CD (CD-DA)/MP3)**
- **Repeat Folder (MP3)**
- **Repeat All (CD (CD-DA)/MP3)**
- **Random (CD (CD-DA)/MP3):** The random option plays a disc's track in random order.

## New Playlist

You can register a maximum 28 tracks in the playlist.

- 1 Press the **ANYKEY** button during the Music List playback.

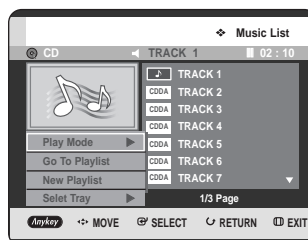

- 2 Press the **▲▼** buttons to select **New Playlist**, then press the **ENTER** or **▶** button.

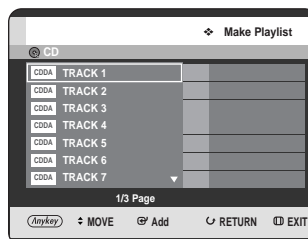

- 3 Press the **▲▼** buttons to select tracks in order in which you want them to play, then press the **ENTER** button.

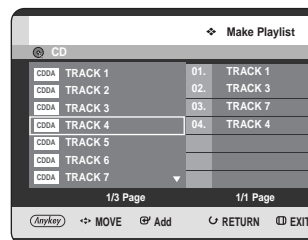



- 4 To remove a track from the Playlist, press the **▶▲▼** buttons to select the wrong track, then press the **ENTER** or **CANCEL** button. The selected track will be removed.

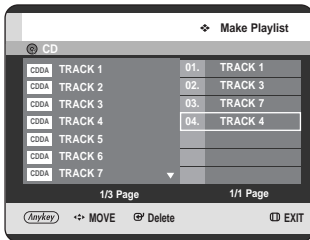

- 5 To store the playlist, press the **ANYKEY** button.

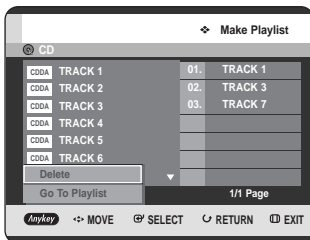

- 6 Press the **▲▼** buttons to select the **Go To Playlist**, then press the **ENTER** button. A new Playlist will be created.

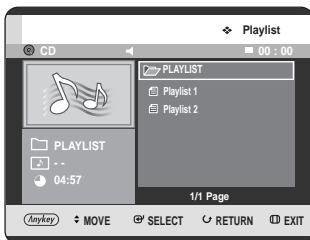

## Go To Playlist

- 1 Press the **ANYKEY** button during the Music List playback.

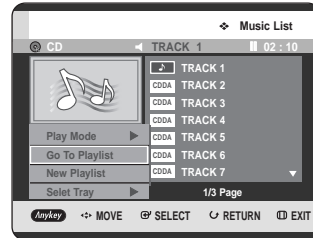

- 2 Press the **▲▼** buttons to select **Go To Playlist**, then press the **ENTER** or **▶** button.

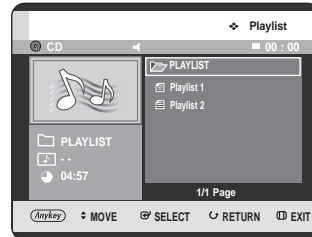

- 3 Press the **▲▼** buttons to select the desired playlist folder, then press the **ENTER** button. The selected tracks are played automatically.



NOTE

- After playback of selected playlist folder has finished, next playlist folder is played automatically.

## Delete the Playlist

- 1 Press the **ANYKEY** button during the Music List playback.

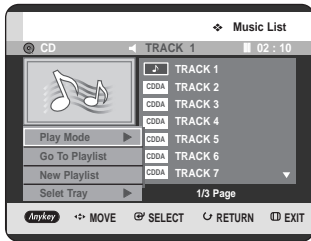

- 2 Press the **▲▼** buttons to select **Go To Playlist**, then press the **ENTER** or **▶** button.

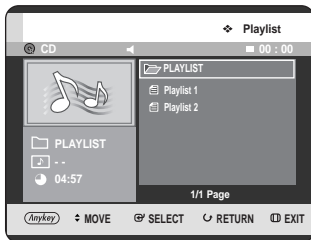

- 3 Press the **▲▼** buttons to select the Playlist you want to delete, then press the **ANYKEY** button.

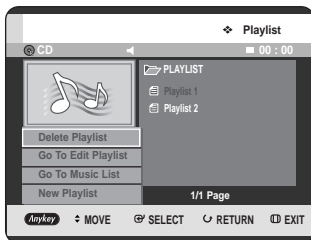

- 4 Press the **▲▼** buttons to select the **Delete Playlist**, then press the **ENTER** or **▶** button.

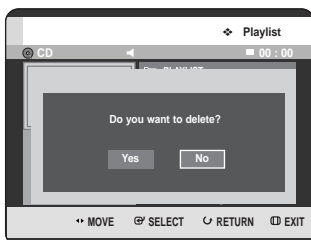

- 5 Press the **◀▶** buttons to select **Yes**, then press the **ENTER** button. The selected Playlist is deleted.

## Go To Edit Playlist

- 1 Press the **ANYKEY** button during the Music List playback.

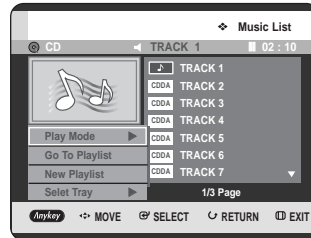

- 2 Press the **▲▼** buttons to select **Go To Playlist**, then press the **ENTER** or **▶** button.

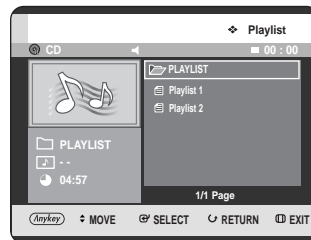

- 3 Press the **▲▼** buttons to select the Playlist you want to delete, then press the **ANYKEY** button.

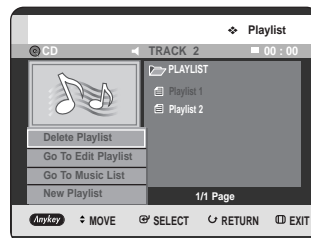

- 5 Press the ▲▼ buttons to select the **Go To Edit Playlist**, then press the **ENTER** or ► button.

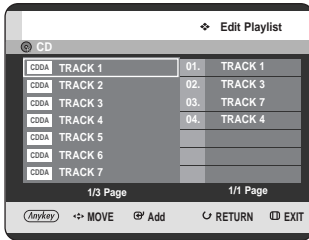

- 6 Press the ▲▼ buttons to select tracks in the order in which you want them to play, then press the **ENTER** button.

- 7 To remove a track from the Playlist, press the ►▲▼ buttons to select the track, then press the **ENTER** or **CANCEL** button.

- 8 To store the playlist, press the **ANYKEY** button.

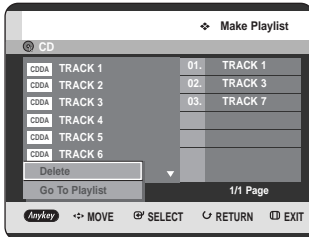

- 9 Press the ▲▼ buttons to select the **Go To Playlist**, then press the **ENTER** button. Playlist will be edited.

## Go To Music List

- 1 Press the **ANYKEY** button during the Playlist playback.

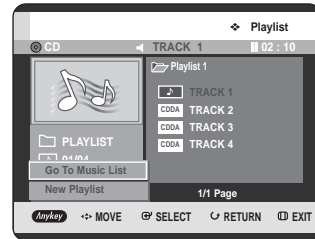

- 2 Press the ▲▼ buttons to select **Go To Music List**, then press the **ENTER** or ► button.

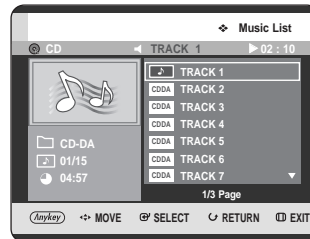

## Select Tray

- 1 Press the **ANYKEY** button.

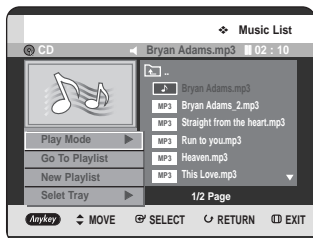

- 2 Press the **▲▼** buttons to select **Select Tray** then press the **ENTER** or **▶** button.

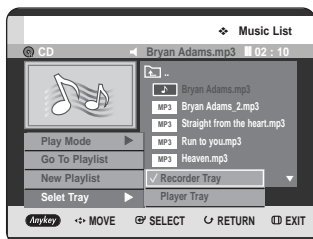

- 3 Press the **▲▼** buttons to select **Recorder Tray** or **Player Tray** then press the **ENTER** or **▶** button.

## Playing a Picture



- 1 Insert a JPEG disc or Mixed disc (JPEG + MP3) into the disc tray.

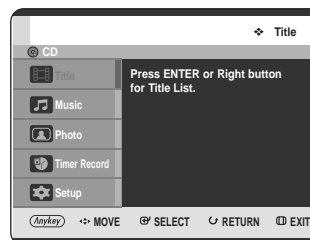

- 2 Press the **▲▼** buttons to select **Photo**, then press the **ENTER** or **▶** button.

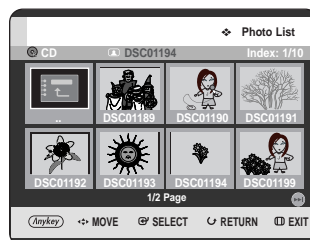

- 3 Press the **▲▼◀▶** buttons to select a picture.
  - To see the next 8 pictures, press the **SKIP(▶▶)** button.
  - To see the previous 8 pictures, press the **SKIP(◀◀)** button.



NOTE

- This unit can play JPEG files in CD-R/RW and DVD-R/-RW/-RAM.
- If a disc contains only MP3 files or only JPEG files, the MP3 or JPEG screen appears after the disc is loaded.
- If a disc contains a mix of MP3 and JPEG files, you need to select Music for MP3 files or Photo for JPEG files.

## Slide Show

To set up, follow steps 1~3 in page 68.

- 4 Press the **ANYKEY** button.



- 5 Press the **▲▼** buttons to select **Slide Show**, then press the **ENTER** or **▶** button.

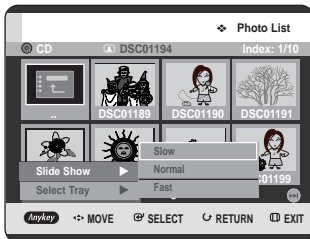

- 6 Press the **▲▼** buttons to select the slide show speed, then press the **ENTER** or **▶** button. The slide show starts.

### - To stop the Slide Show -

- 1 Press the **ANYKEY** button.

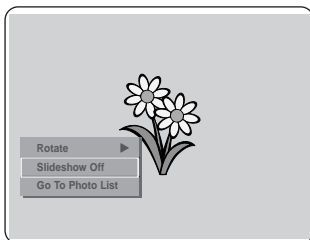

- 2 Press the **▲▼** buttons to select **Slideshow Off**, then press the **ENTER** or **▶** button.

## Rotate

To set up, follow steps 1~3 in page 68.

- 4 Press the **ENTER** button to select you want to see the picture, then press the **ANYKEY** button.

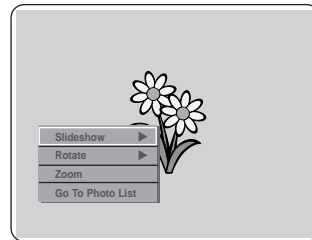

- 5 Press the **▲▼** buttons to select **Rotate**, then press the **ENTER** or **▶** button.

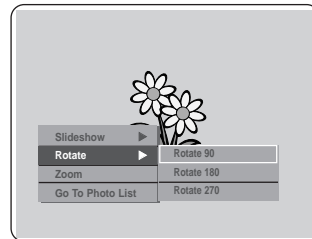

- 6 Press the **▲▼** buttons to select the rotate angle, then press the **ENTER** or **▶** button.

### - To stop the Rotate -

- 1 Press the **ANYKEY** button.

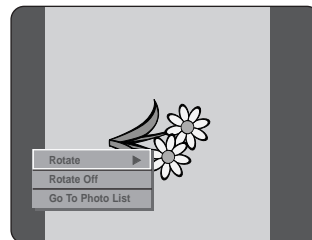

- 2 Press the **▲▼** buttons to select **Rotate Off**, then press the **ENTER** or **▶** button.

## Zoom

To set up, follow steps 1~3 in page 68.

- 4** Press the **ENTER** button to select you want to see the picture, then press the **ANYKEY** button.

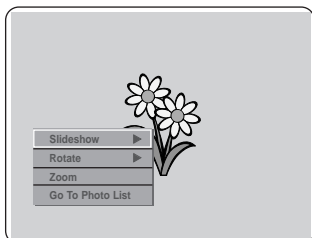

- 5** Press the **▲▼** buttons to select **Zoom**, then press the **ENTER** or **▶** button.

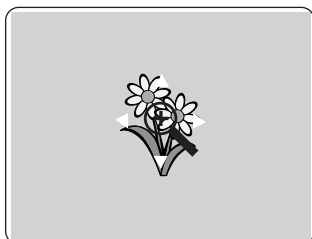

- 6** Each time the **ENTER** button is pressed, the picture is enlarged up to x4(four times the normal size).

→ X2 → X4 → X2 → Normal →

### - To stop the Zoom -

- 1** Press the **ANYKEY** button.



- 2** Press the **▲▼** buttons to select **Zoom Off**, then press the **ENTER** or **▶** button.

## Go To Photo List

To set up, follow steps 1~3 in page 68.

- 4** Press the **ENTER** button to select you want to see the picture, then press the **ANYKEY** button.

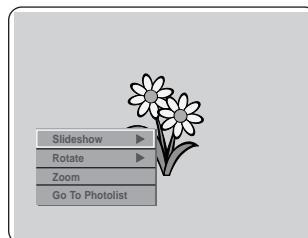

- 5** Press the **▲▼** buttons to select **Go To Photo List**, then press the **ENTER** or **▶** button.

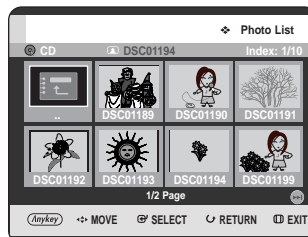

# Recording

This section shows various DVD Recording methods.

Before Recording .....	71
Recording the current TV program you are watching .....	73
Recording from external equipment you are watching .....	74
Copying from a Camcorder .....	75
Making an One Touch Recording (OTR) .....	76
Making a Timer Recording .....	77
Flexible Recording (for Timer recording only) ...	79
Editing the Timer Record List .....	79
Deleting a Timer Record List .....	80

## Before Recording

This unit can record on various types of discs. Before recording, read the following instructions and select the disc type according to your preference.

### Recordable Discs

This TWIN TRAY DVD RECORDER can record on the following discs.

DVD-RAM	DVD-RW	DVD-R
		

- DVD-RWs and DVD-RAMs are rewritable.
- DVD-Rs are non-rewritable

### Compatibility between Samsung and Other Company's Recorder

Disc Types	Recording format	Recording Device	Finalizing	Additional Recording in Samsung Recorder
DVD-RAM	VR Mode	Samsung	X	Recordable
		Other Company	X	Recordable
DVD-RW	VR Mode	Samsung	finalized not finalized	Not recordable Recordable
		Other Company	finalized not finalized	Not recordable Recordable
	V Mode	Samsung	finalized not finalized	Not recordable Recordable
		Other Company	finalized not finalized	Not recordable Not recordable
DVD-R	V Mode	Samsung	finalized not finalized	Not recordable Recordable
			Other Company	finalized not finalized



NOTE

- Finalize
  - This closes the DVD-RW/-R so no additional recording can be done.
- Unfinalize
  - This allows additional recording on a DVD-RW disc originally recorded on the TWIN TRAY DVD RECORDER.
  - A DVD-RW disc that has been recorded by DAO(Disc At Once) in a PC cannot be unfinalized.
  - A DVD-RW disc that has been recorded in Video Mode of a different maker's recorder cannot be unfinalized.
  - A DVD-R disc cannot be unfinalized.

## Recording Formats

When you insert a new, unused disc, the following message appears. Since available functions differ depending on the disc type, select a disc that best fits your preferences.

DVD-RAM: Use after formatting the disc.



DVD-RW: When a new, unused DVD-RW disc is first inserted, the message "Uninitialized Disc Do you want to initialize this disc?" will be displayed. If you select **Yes**, the disc will be initially formatted in VR mode.

If you want to change the mode later, refer to Formatting a Disc on page 105.



DVD-R: Formatting DVD is unnecessary and only Video Mode Recording is supported.

### DVD-RW(V mode)/-R

- Chapters will be created automatically when you finalize recording on DVD-RW/-R discs in Video mode. The chapter's length (interval between chapters) varies according to the recording mode.
- Simple editing (erasing titles/changing title name)

### DVD-RAM/-RW(VR mode)

- This mode allows multiple editing functions (such as deletion of the whole title, partial deletion of a title, etc.)
- Various editing options using a created Playlist.

## Recording Mode

Select one of four recording modes by pressing the **REC MODE** button repeatedly while the unit is in Stop mode for the desired recording time and picture quality. In general, picture quality improves as the recording time decreases. In FR mode, the most suitable record mode is adjusted automatically, according to remaining time on the disc and length of the timer recording. This function is selected only one mode in XP, SP, LP and EP modes and you can use this mode for timer recording.

Recording Mode	Characteristic	Recording Times
		DVD-RAM/-RW/-R
XP (high quality mode)	Select when the video quality is important.	Approx. 1 hour about 8.5 Mbps
SP (standard quality mode)	Select to record in standard quality.	Approx. 2 hours about 4.5 Mbps
LP (long recording mode)	Select when a long recording time is required.	Approx. 4 hours about 2 Mbps
EP (extended mode)	Select when a longer recording time is required.	Approx. 6 hours/ about 1.6 Mbps
		Approx. 8 hours/ about 1.2 Mbps
FR (Flexible Recording)	For timer recording only See page 79.	Approx 1-6 hours



NOTE

- Recording time may vary according to specific conditions.



## Unrecordable video

Video with copy protection cannot be recorded on this TWIN TRAY DVD RECORDER.

When the TWIN TRAY DVD RECORDER receives a copy guard signal while recording, recording stops and the following message appears on the screen.

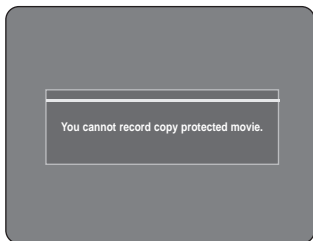

## Concerning Copy Control Signals

TV broadcasts that contain copy control signals may have one of the following three signal types, Copy-Free, Copy-Once and Copy-Never. If you want to record a copy-once type program, use DVD-RW with CPRM in VR Mode and DVD-RAM.

Media \ Signal type	Copy-Free	Copy-Once	Copy-Never
DVD-RW(Ver.1.1)	○	-	-
DVD-RW(Ver.1.1) with CPRM			
VR mode	○	○*	-
V mode	○		-
DVD-R	○		-
DVD-RAM(Ver.2.0)	○	○*	-

This \* marked parts are compatible with CPRM.

Once "Copy Once" has been recorded, recording cannot be done anymore.

### - Content Protection for Recordable Media (CPRM)

CPRM is a mechanism that ties a recording to the media on which it is recorded. It is supported by some DVD RECORDERS, but not by many DVD players. Each blank recordable DVD has a unique 64-bit media ID etched in the BCA. When protected content is recorded onto the disc, it can be encrypted with a 56-bit C2 (Cryptomeria) cipher derived from the media ID.

During playback, the ID is read from the BCA and used to generate a key to decrypt the contents of the disc. If the contents of the disc are copied to other media, the ID will be absent or wrong and the data will not be decryptable.

## Recording the current TV program you are watching



Check that the disc has enough available space for the recording. Adjust the recording mode.

- 1 Press the **RECORDER** button on the front panel or **R** button on the remote control. Press the **OPEN/CLOSE** button and place a recordable disc on the disc tray. Press the **OPEN/CLOSE** button to close the disc tray. Wait until **LOAD** disappears from the front panel display.

If an unused DVD-RAM disc is used, you will be prompted to format first. Make your selection using the ◀▶ buttons, then press **ENTER** button. (See page 72)



If an unused DVD-RW disc is used, whether to initialize or not will be asked first. Make your selection, using the ◀▶ buttons, then press the **ENTER** button. (See page 72)



- 2 Press the **CH** (⊖ ⊕) or number buttons to select the current program you want to record.

- 3** Press the **REC MODE** button repeatedly, (or press the **REC MODE** button and then press the **▲▼** buttons) to select the recording speed (quality).



→ **SP** → **LP** → **EP** → **XP**



- 4** Press the **REC** button. Information concerning the channel is displayed on the screen, then recording begins. Icon(  ) is displayed on the front panel.



#### - To pause recording -

- Press the **REC PAUSE** button to pause a recording in progress.
- Press the **REC PAUSE** button again during pause to resume recording.
- You can switch channels by pressing the **CH** (  ) (  ) buttons while recording pauses.

#### - To stop recording -

Press the **STOP** (  ) button to stop or finish a recording in progress.

- When using DVD-RAM/-RW/-R discs, the message "Updating the information of disc. Please wait for a moment" is displayed.



NOTE

- You cannot change the recording mode and the channel while recording.
- Recording will stop automatically if there is no free space left for recording.
- Up to 99 titles can be recorded onto a disc.(DVD-RAM/-RW/-R)
- Recording will stop automatically if a copy protected image is selected.
- DVD-RAM/-RW discs must be formatted before starting to record. Most new discs are sold unformatted.
- Do not use DVD-R authoring discs with this TWIN TRAY DVD RECORDER.

## Recording from external equipment you are watching



### Before you start

Check that the disc has enough available space for the recording. Adjust the recording mode.

- 1** Press the **RECORDER** button on the front panel or **R** button on the remote control. Press the **OPEN/CLOSE** button and place a recordable disc on the disc tray. Press the **OPEN/CLOSE** button to close the disc tray. Wait until **LOAD** disappears from the front panel display. If an unused DVD-RAM disc is used, whether to format or not will be asked first. (See page 72)  
If an unused DVD-RW disc is used, whether to initialize or not will be asked first. (See page 72)

- 2** Press the **INPUT** button to select the input source according to the connection you made. The front panel display changes in the following sequence:

→ **CH Number** → **AV 1** → **AV 2** → **DV**

If you connect a digital camcorder, press the **INPUT** button to select **DV**. (See pages 75~76)

- 
- 3** Press the **REC MODE** button repeatedly, (or press the **REC MODE** button, then press the **▲▼** buttons) to select the recording speed (quality).  
→ **SP** → **LP** → **EP** → **XP**



- 
- 4** Press the **REC** button. Information concerning the external input mode is displayed on the screen, then recording begins. Icon(○) is displayed on the front panel.

---

#### - To pause recording -

- Press the **REC PAUSE** button to pause a recording in progress.
- Press the **REC PAUSE** button again during pause to resume recording.
- You can switch channels by pressing the **CH** (☺ ☹) buttons while recording pauses.

---

#### - To stop recording -

Press the **STOP** (⊖) button to stop or finish a recording in progress.

- When using DVD-RAM/-RW/-R discs, the message "Updating the information of disc. Please wait for a moment" is displayed.

## Copying from a Camcorder

You may control the Camcorder using the IEEE1394 (DV) interface.



- 
- 1** Connect the DV output jack of your camcorder to the DV input jack on the front of your TWIN TRAY DVD RECORDER using a DV cable.

- 
- 2** Press the **RECORDER** button on the front panel or **R** button on the remote control. Press the **OPEN/CLOSE** button and place a recordable disc on the disc tray. Press the **OPEN/CLOSE** button to close the disc tray. Wait until **LOAD** disappears from the front panel display.

- 
- 3** Press the **REC MODE** button repeatedly to select the recording speed(quality).

→ **SP** → **LP** → **EP** → **XP**



- 4** Press the **INPUT** button to select **DV**.  
If the input is set to DV, a playback/record menu that enables camcorder control appears on the top of the screen.



- 5** Select the Play (▶) icon on the upper part of the screen to playback the camcorder and find the starting position to copy.  
You can press the **PLAY** (⏪) button of the remote control to play the camcorder.

- 6** To start recording, use the ◀▶ buttons to select Record (●) icon in the top side of the screen, then press the **ENTER** button.  
You can press the **REC** button of the remote control to start recording. To display playback related icons on the screen, press any direction button on the remote control.

### - To stop recording -

Press the **STOP** (⏹) button to stop or finish a recording in progress.

- When using DVD-RAM/-RW/-R discs, the message "Updating the information of disc. Please wait for a moment" is displayed

## Making a One Touch Recording (OTR)

You can set the TWIN TRAY DVD RECORDER to record in 30-minute increments up to 8 hours by pressing the **REC** button.



- 1** Press the **RECORDER** button on the front panel or **R** button on the remote control. Press the **OPEN/CLOSE** button and place a recordable disc on the disc tray. Press the **OPEN/CLOSE** button to close the disc tray. Wait until **LOAD** disappears from the front panel display.

- 2** If you want to record a TV channel, press the **CH** (⊖⊕) buttons or number buttons to select a desired channel. If you want to record through a connected external equipment, press the **INPUT** button to select an appropriate external input (AV 1, AV 2, DV or CH 01).

- 3** Press the **REC** button to start recording.



- 4** Press the **REC** button repeatedly to adjust the desired recording time.

→ 0:30 → 1:00 → ... 8:00 → Off →





NOTE

- The timer counter decreases by the minute from 8:00 to 0:00, then the TWIN TRAY DVD RECORDER stops recording.

### - To stop recording -

Press the **STOP** (⏏) button. The message "Do you want to stop recording?" is displayed.

- Press the ◀ ▶ buttons to select **Yes**, then press the **ENTER** button, or press the **STOP** (⏏) button again.

## About INFO button

During recording, press the **INFO** button once, Disc information screen appears.: Displays Total numbers of Titles and Playlists, Recordable Time, Available Space(Music/Photo).

DVD-RAM(VR) Disc Info	
Disc Name	MY VIED
Total Title	25
Total Playlist	2
Recordable Time	17:12 XP
Protection	Not Protected
JAN/01/2005 (SAT)	AM 12:00

Press the **INFO** button twice: Current recording information screen appears and displays recording Name, Title, Created Time and Recording Time information.

DVD-RAM(VR) Recording Info	
Name	JAN/01/2005 12:00 AM
	CH 11
Recording Title	4
Created Time	JAN/01/2005 12:00 AM
Recording Time	00:13:27
JAN/01/2005 (SAT)	AM 12:00

# Making a Timer Recording



1. Check the antenna cable is connected.
2. Check the remaining time of the disc.
3. Check the date and time are correct.  
Make sure the Clock (Setup-Clock Set) is set before you proceed with a timer recording. (See pages 26-28)



## Using the TIMER button

- 1 Press the **RECORDER** button on the front panel or R button on the remote control.  
With the unit in Stop mode/Playback mode, press the **TIMER** button.  
The **Timer Record List** screen is displayed.

DVD-RAM(VR) Timer Rec.List						
Current Time 11:00 AM						
No.	Source	Date	Start	End	Mode	
Add a list						
Available Time DVD 29:10 SP						
[Anykey] ← MOVE Ⓞ SELECT ↶ RETURN Ⓞ EXIT						

## Using the MENU button.

- With the unit in Stop mode/Playback mode, press the **MENU** button.
- Press the ▲ ▼ buttons to select **Timer Record**, then press the **ENTER** or ▶ button.

- 2 Press the **ENTER** button to select **Add a list**.  
The **Timer Record List** screen is displayed.

DVD-RAM(VR) Timer Rec.List						
Current Time 11:00 AM						
No.	Source	Date	Start	End	Mode	
Title No. 01						
	Source	Date	Start	End	Mode	
	AV2	01 JAN	11:00 AM	02:00 PM	SP	
Save						
Available Time DVD 29:10 SP						
← MOVE Ⓞ SELECT ↶ RETURN Ⓞ EXIT						

### Using the ANYKEY button.

- Press the **ANYKEY** button.
- Press the **▲▼** buttons to select **Add**, then press the **ENTER** or **▶** button.

## 3 Set timer recording option.

- Fill the input items using the **▲▼◀▶** buttons and number buttons.

**◀▶** : Moves to the previous/next item.

**▲▼ 0-9** : Sets a value.

- **Source** : The video input source (AV1, AV2), or the broadcasting channel you want to make a timer recording from.
- **Date** : Timer Recording allows setting the recording time within one month period. Set the recording day. (day/month)

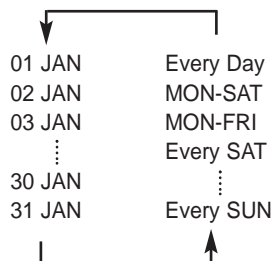

- **Start/End Time** : Start and end time of the timer recording.
- **Mode (Recording Mode)** :
  - FR (Flexible Recording) : Select when you want to set video quality automatically. In FR mode, the most suitable record mode is adjusted automatically, according to remaining time on the disc and length of the timer recording.
  - XP (high quality) : Select when video quality is important.
  - SP (standard quality) : Select to record in standard quality.
  - LP (low quality) : Select when a long recording time is required.
  - EP (extended) : Select when a longer recording time is required.



NOTE

- When you are recording at EP mode on a DVD-RW(V mode)-R disc, it may not record the full 6 or 8 hours because the unit uses the VBR(Variable Bit Rate) ENCODING system. For example, if you record a program with a lot of action, it uses a higher bit rate which in turn consumes more disc memory.

## 4 After selecting the set up value for each mode, press the **ENTER** button to select **Save**, and press the **ENTER** button again.

- will appear on the front panel. It means that a timer recording is registered.

### If the timer settings overlap;

The programs are recorded in order of priority. If timer recording is set for the first program and then again for the second program and both programs overlap, the following message will appear on the screen: "This setting is identical with 1." The message shows that the first program has priority. After recording of the first program is complete, the second program starts being recorded.

### To exit without saving the current setting

Press the **MENU** button.

### To return to the previous menu

Press the **RETURN** button if you don't want to set a timer recording.

## 5 Press the **MENU** button to finish the **Timer Recording** setting.



NOTE

- The timer recording time may differ from the set time depending on disc status and overall timer recording status (for example, recording times overlapping, or when the previous recording ends within 2 minutes before the start time of the next recording.)
- You can set up to 12 Timer Recordings.

## Flexible Recording (for Timer recording only)



In FR mode, the most suitable record mode is adjusted automatically, according to remaining time on the disc and length of the timer recording.

The FR mode recording setup is the same as Timer Recording. When setting the mode in step 4, set the FR mode.

## Editing the Timer Record List

Follow these directions to edit the timer record list.



### Using the TIMER button

- 1 Press the **RECORDER** button on the front panel or R button on the remote control.  
With the unit in Stop mode/Playback mode, press the **TIMER** button.  
The Timer Record List screen is displayed.

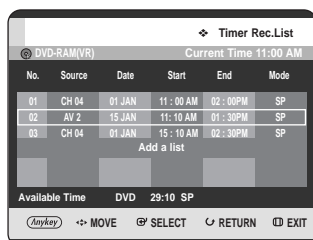

### Using the MENU button.

- With the unit in Stop mode/Playback mode, press the **MENU** button.
- Press the **▲▼** buttons to select **Timer Record**, then press the **ENTER** or **▶** button.

- 2 Press the **▲▼** buttons to select the number of the Timer Record List you want to edit, then press the **ANYKEY** button.
  - The **Add**, **Edit** and **Delete** items are displayed.

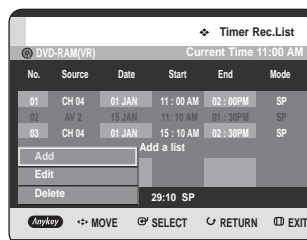

- 3 Press the **▲▼** buttons to select **Edit**, then press the **ENTER** or **▶** button.
  - The Timer Record Input item is displayed.  
Edit the items you want to modify. See the "Making a Timer Recording" section for more information on Timer Recording Input items. (See pages 77~78)

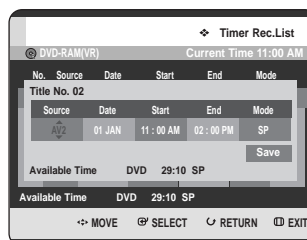

- 4 Press the **ENTER** button to select **Save**, then press the **ENTER** button to confirm the edited setting.
- 5 Press the **MENU** button after finishing the operation. The Timer Record List screen will disappear.

# Deleting a Timer Record List

Follow these directions to delete an entry from the timer record list.



## Using the TIMER button

- 1 Press the **RECORDER** button on the front panel or R button on the remote control. With the unit in Stop mode/Playback mode, press the **TIMER** button. The Timer Record List screen is displayed.

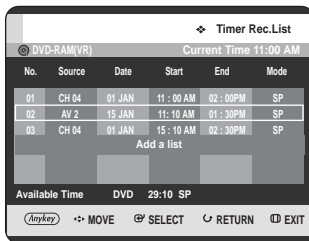

## Using the MENU button.

- With the unit in Stop mode/Playback mode, press the **MENU** button.
- Press the **▲▼** buttons to select **Timer Record**, then press the **ENTER** or **▶** button.

- 2 Press the **▲▼** buttons to select the number of the Timer Record List you want to delete, and then press the **ANYKEY** button.
  - The **Add**, **Edit** and **Delete** items are displayed.

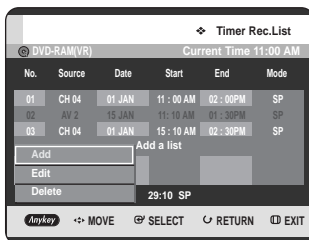

- 3 Press the **▲▼** buttons to select **Delete**, then press the **ENTER** or **▶** button.
  - You will be prompted with the delete confirm message such as “Do you want to delete No.02?”.

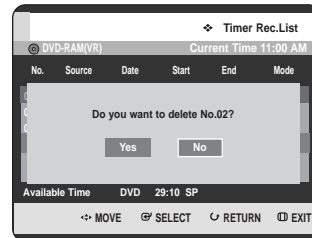

- 4 Press the **◀▶** buttons to select **Yes**, then press the **ENTER** button.
  - The selected entry will be deleted from the list.

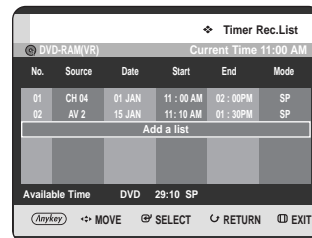

- 5 Press the **MENU** button after finishing the operation. The Timer Record List screen will disappear.





# Editing

This section introduces basic functions of editing and explains both edit functions for the recording on a disc and edit functions for the entire disc.

Basic Editing (Title List) . . . . .	.82
Advanced Editing (Playlist) . . . . .	.87
Title Copy . . . . .	.95
Copying Multiple Titles at One Time . . . . .	.99
Disc Copy . . . . .	.102
Disc Manager . . . . .	.103

## • Title List

A title is a section of recorded video and audio. Title List shows a list to help you select a title. Since the title consists of the information on stream that is actually recorded, if one title is deleted, that title cannot be played again.

## • Play List

This refers to a unit of playback, which is made by selecting a desired scene in the entire Title List. When one playlist is played, only the scene selected by the user will play and then stop. Since only the information necessary for playing a desired scene is included in a playlist, even if that playlist is deleted, the original stream will not be deleted.

***Recording or editing might not be completed if an error, such as a sudden power failure occurs. Please be aware that a title that has been damaged cannot be retrieved.***



- Edit functions of Title List and Play List are available only in the R Tray.

# Basic Editing (Title List)

## Renaming(Labeling) a Title

Follow these instructions to rename a title list entry, i.e., to edit the name of a recorded program.



### Using the TITLE LIST button

**1** Press the **RECORDER** button on the front panel or R button on the remote control.

**2** With the unit in Stop mode/Playback mode, press the **TITLE LIST** button. The Title List screen is displayed.

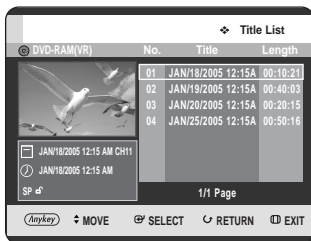

### Using the MENU button.

- With the unit in Stop mode/Playback mode, press the **MENU** button.
- Press the **▲▼** buttons to select **Title**, then press the **ENTER** or **▶** button.

**3** Press the **▲▼** buttons to select an entry you want to rename from the Title List, then press the **ANYKEY** button.

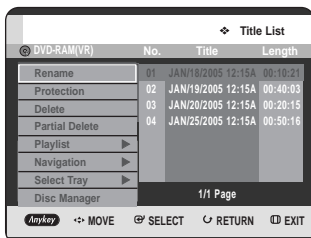

**4** Press the **▲▼** buttons to select **Rename**, then press the **ENTER** or **▶** button. The Rename screen is displayed.

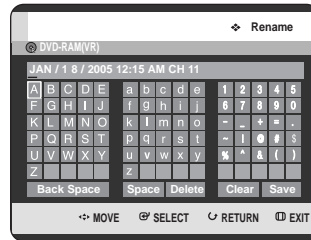

**5** Select the desired characters using the **▲▼◀▶** buttons, press the **ENTER** button to select the character.

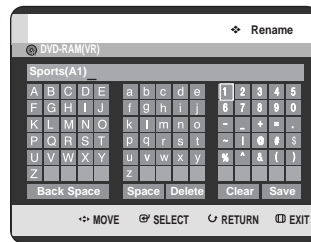

- **Back Space:** Deletes and moves the cursor backwards by one position.
- **Space:** Enters a blank and moves the cursor one forward (to the right).
- **Delete:** Deletes the character at the cursor position.
- **Clear:** Deletes all the character inputs.
- **Save:** Registers the character inputs.

**6** Press the **▲▼◀▶** buttons to select **Save**, and then press the **ENTER** button. The changed title name is displayed.

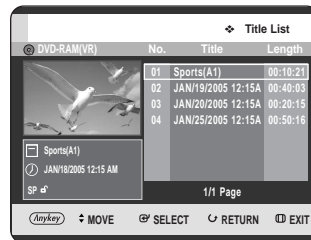

## Locking (Protecting) a Title

Follow these instructions to lock a Title to protect it from accidental deletion.



### Using the TITLE LIST button

- 1 Press the **RECORDER** button on the front panel or R button on the remote control.
- 2 With the unit in Stop mode/Playback mode, press the **TITLE LIST** button .  
The Title List screen is displayed.

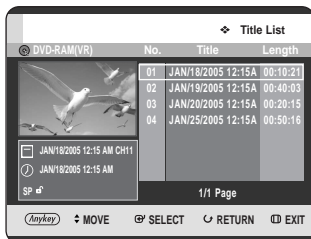

### Using the MENU button.

- With the unit in Stop mode/Playback mode, press the **MENU** button.
- Press the **▲▼** buttons to select **Title**, then press the **ENTER** or **▶** button.

- 3 Press the **▲▼** buttons to select a Title you want to protect from the Title List, then press the **ANYKEY** button.

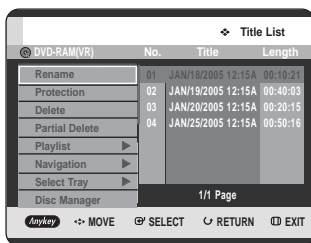

- 4 Press the **▲▼** buttons to select **Protection**, then press the **ENTER** or **▶** button.

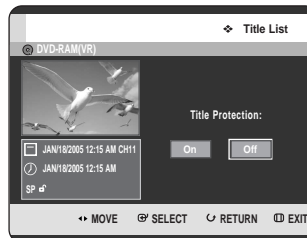

- 5 Press the **◀▶** buttons to select **On**, then press the **ENTER** button. The key icon on the information window for the selected entry changes to the locked status. (♣ → 🔒)

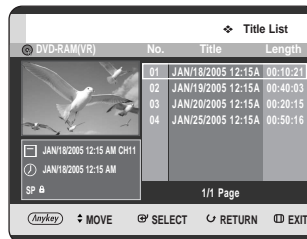

## Deleting a Title

Follow these instructions to delete a title from the Title List.



### Using the TITLE LIST button

- 1 Press the **RECORDER** button on the front panel or R button on the remote control.

- 2** With the unit in Stop mode/Playback mode, press the **TITLE LIST** button.  
The Title List screen is displayed.

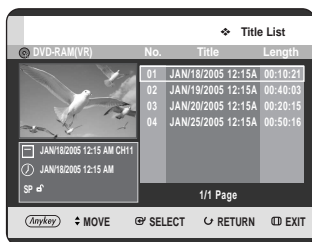

### Using the MENU button.

- With the unit in Stop mode/Playback mode, press the **MENU** button.
- Press the **▲▼** buttons to select **Title**, then press the **ENTER** or **▶** button.

- 3** Press the **▲▼** buttons to select a title that you want to delete in the Title List, then press the **ANYKEY** button.

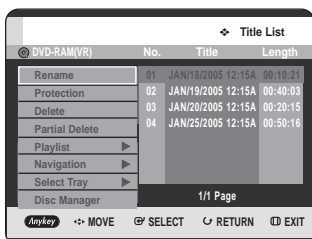

- 4** Press the **▲▼** buttons to select **Delete**, then press the **ENTER** or **▶** button.

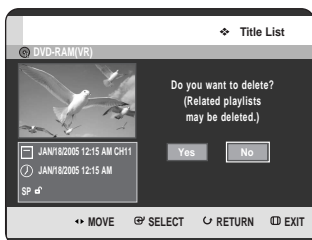

- The message may be different depending on the type of disc that you are using. You will be prompted with the confirmation message. DVD-RAM(VR mode), DVD-RW(VR mode): Since Playlist is present, the message "Do you want to delete? (Related playlists may be deleted.)" is displayed. DVD-RW(Video mode)/-R: Since Playlist is not present, the message "Do you want to delete?" is displayed.

- 5** Press the **◀▶** buttons to select **Yes**, then press the **ENTER** button.

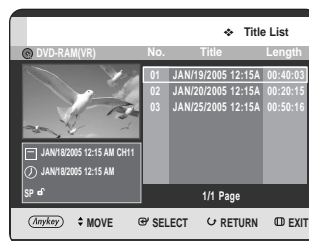

- You cannot delete a protected entry. If you want to delete a protected entry, select "Off" in the Title Protection menu. (See page 83)
- When the Cartridge Protection or Disc Protection has been set to Protected, you cannot delete titles. (See page 6 and 105)
- Once an entry is deleted from the Title List it cannot be recovered.
- Once DVD-RW/-R is finalized, it cannot be deleted.

## Deleting a Section of a Title (Partial Delete)

Follow these instructions to edit or delete a section of a Title List entry.



### Using the TITLE LIST button

- 1 Press the **RECORDER** button on the front panel or **R** button on the remote control.
- 2 With the unit in Stop mode/Playback mode, press the **TITLE LIST** button.  
The Title List screen is displayed.

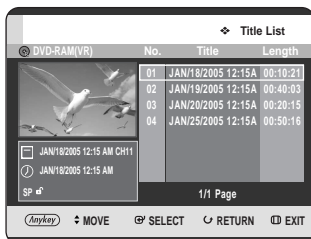

### Using the MENU button.

- With the unit in Stop mode/Playback mode, press the **MENU** button.
- Press the **▲▼** buttons to select **Title**, then press the **ENTER** or **▶** button.

- 3 Press the **▲▼** buttons to select an entry you want to edit from the Title List, then press the **ANYKEY** button.

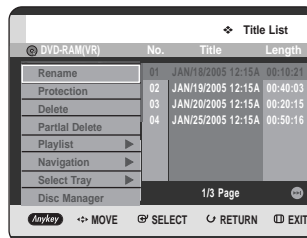

- 4 Press the **▲▼** buttons to select **Partial Delete**, then press the **ENTER** or **▶** button.

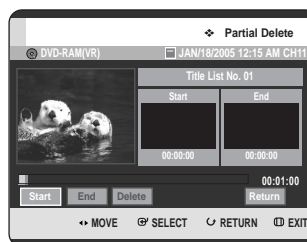

- 5** Press the **ENTER** button at the starting point. The image and starting point time are displayed in the section deletion starting point window.

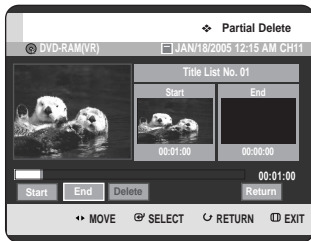

#### Edit Title List Screen Elements



- ① Playback bar
- ② Playtime
- ③ Section deletion starting point window and time
- ④ Section deletion end point window and time
  - Select the start and end points of the section you want to delete using the playback related buttons.
  - Playback related buttons :  
(PLAY (⏪), SEARCH (⏩ ⏪ ⏩))

- 6** Press the **ENTER** button at the end point. The image and end point time are displayed in the Section deletion ending point window.

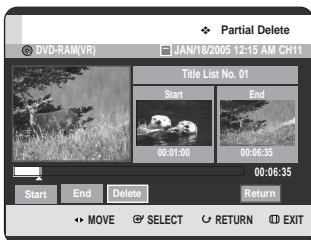

- 7** Press the **◀▶** buttons to select **Delete**, then press the **ENTER** button. You will be asked: "Do you want to delete?".

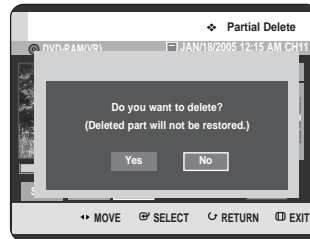

- 8** Press the **◀▶** buttons to select **Yes**, then press the **ENTER** button. The selected section has been deleted.

- 9** Press the **◀▶** buttons to select **Return**, then press the **ENTER** button to finish the operation.



- The length of the section to be deleted must be at least 5 seconds long.
- If the length of the section to be deleted is less than 5 seconds, you will be prompted with the message "The range is too short."
- If the end time precedes the starting time, you will be prompted with the message "End point cannot be marked earlier than start point".
- Press the **MENU** button after the operation has finished. The Title List screen will disappear.

# Advanced Editing (Playlist)

## Creating a Playlist

Follow these instructions to create a new playlist entry from a recorded title.



(VR mode)



## Using the TITLE LIST button

- 1 Press the **RECORDER** button on the front panel or R button on the remote control.
- 2 With the unit in Stop mode/Playback mode, press the **TITLE LIST** button. The Title List screen is displayed.

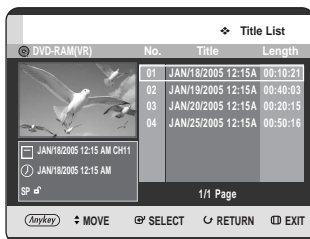

### Using the MENU button.

- With the unit in Stop mode/Playback mode, press the **MENU** button.
- Press the **▲▼** buttons to select **Title**, then press the **ENTER** or **▶** button.

- 3 Press the **ANYKEY** button. Press the **▲▼** buttons to select **Playlist**, then press the **ENTER** or **▶** button.

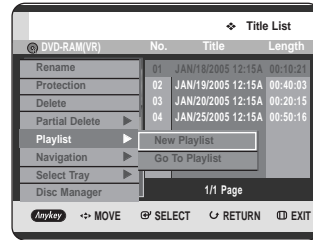

- 4 Press the **▲▼** buttons to select **New Playlist**, then press the **ENTER** or **▶** button. The Make Playlist screen is displayed.

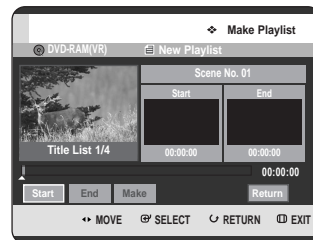

- 5 Press the **ENTER** button at the start point.

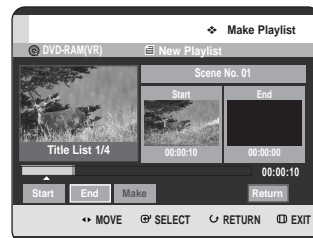

- The image and time at the start point are displayed on the Start window.
- The yellow-colored selection bar moves to the End item.
- Select the starting point of the section from which you want to create a new scene using the playback related buttons (**PLAY**(**⊕**), **SEARCH**(**⊖**)).

6 Press the **ENTER** button at the end point.

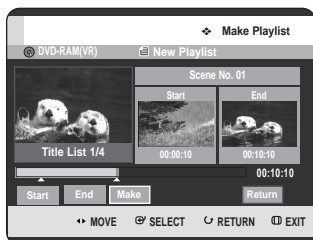

- The image and end point time are displayed in the End window.
- The yellow-colored selection bar moves to the Make item.

7 Press the ◀▶ buttons to select **Make**, then press the **ENTER** button.

- To make a scene for playlist.  
A new Make scene screen is displayed.  
Repeat steps 3–6 to make scene of playlist.  
A new scene will be added to the current playlist.  
You can check and view all the scenes on Edit playlist screen. (See page 90)
- To make a new playlist, repeat steps 1–6.

8 Press the ◀▶ button to select **Return**, then press the **ENTER** button to finish the operation.



NOTE

- You can create up to 99 playlist entries.
- Depending on the type of disc used, the displayed Make Playlist screen may appear different.

## Playing Entries in the Playlist

Follow these instructions to play the playlist entries.



(VR mode)



### Using the PLAY LIST button

1 Press the **RECORDER** button on the front panel or **R** button on the remote control.

2 With the unit in Stop mode, press the **PLAY LIST** button.  
The Playlist screen is displayed.

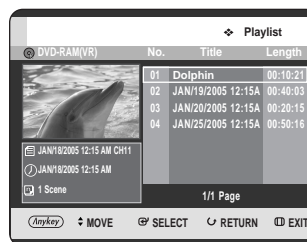

### Using the MENU button.

- With the unit in Stop mode, press the **MENU** button.
- Press the ▲▼ buttons to select **Title**, then press the **ENTER** or ▶ button. The Title List screen is displayed.
- Press the **ANYKEY** button.
- Press the ▲▼ buttons to select **Playlist**, then press the **ENTER** or ▶ button.
- Press the ▲▼ buttons to select **Go To Playlist**, then press the **ENTER** or ▶ button.

3 Press the ▲▼ buttons to select the playlist you want to play, then press the **ENTER** or **PLAY** (⊕) button.

4 Press the **STOP** (⊖) button to stop playing.  
The screen returns to the Playlist screen.



## Renaming a Playlist Entry

Follow these instructions to rename a playlist entry, i.e. to edit the name of a playlist entry.



### Using the PLAY LIST button

**1** Press the **RECORDER** button on the front panel or R button on the remote control.

**2** With the unit in Stop mode, press the **PLAY LIST** button. The Edit Playlist screen is displayed.

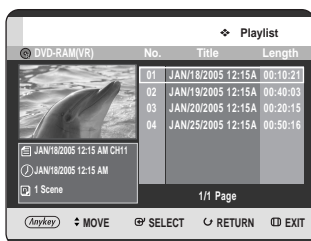

### Using the MENU button.

- With the unit in Stop mode, press the **MENU** button.
- Press the **▲▼** buttons to select **Title**, then press the **ENTER** or **▶** button. The Title List screen is displayed.
- Press the **ANYKEY** button.
- Press the **▲▼** buttons to select **Playlist**, then press the **ENTER** or **▶** button.
- Press the **▲▼** buttons to select **Go To Playlist**, then press the **ENTER** or **▶** button.

**3** Press the **▲▼** buttons to select the title you want to Rename from the Playlist, then press the **ANYKEY** button.

ANYKEY menu is displayed : **Rename, Delete, Edit Playlist, Go To Titlelist, Disc Manager**

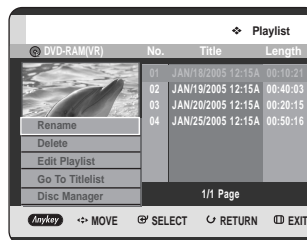

**4** Press the **▲▼** buttons to select **Rename**, then press the **ENTER** or **▶** button. The Rename screen is displayed.

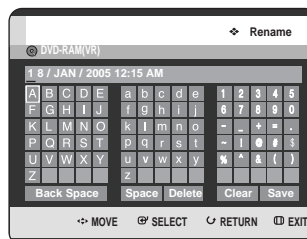

**5** Select the desired characters using the **▲▼◀▶** buttons, then press the **ENTER** button.

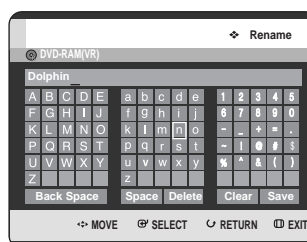

- This function is the same as the Rename function in the renaming the title. (See page 82)
- The maximum number of characters that can be entered is 31. All 31 characters can be displayed by pressing the **INFO** button.

- 6** Press the **▲▼◀▶** buttons to select **Save**, then press the **ENTER** button.  
The changed title is displayed in the title field of the selected playlist entry.

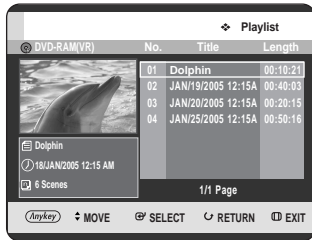

- 3** Press the **▲▼** buttons to select the title you want to edit from the Playlist, then press the **ANYKEY** button.  
The Edit Playlist menu is displayed: **Rename**, **Delete**, **Edit Playlist**, **Go To Titlelist**, **Disc Manager**.

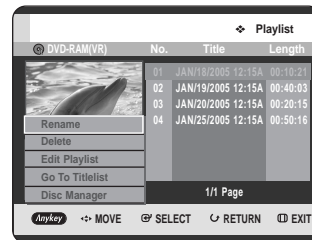

## Editing a Scene for the Playlist

Follow these instructions to edit scenes for a playlist.



### Using the PLAY LIST button

- 1** Press the **RECORDER** button on the front panel or **R** button on the remote control.
- 2** With the unit in Stop mode, press the **PLAY LIST** button.  
The Edit Playlist screen is displayed.

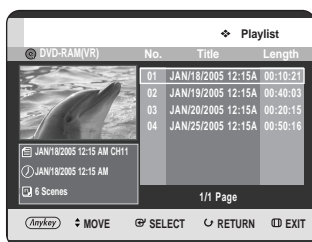

### Using the MENU button.

- With the unit in Stop mode, press the **MENU** button.
- Press the **▲▼** buttons to select **Title**, then press the **ENTER** or **▶** button.  
The Title List screen is displayed.
- Press the **ANYKEY** button.
- Press the **▲▼** buttons to select **Playlist**, then press the **ENTER** or **▶** button.
- Press the **▲▼** buttons to select **Go To Playlist**, then press the **ENTER** or **▶** button.

- 4** Press the **▲▼** buttons to select **Edit Playlist**, then press the **ENTER** or **▶** button.  
The Edit Playlist Scene screen is displayed.

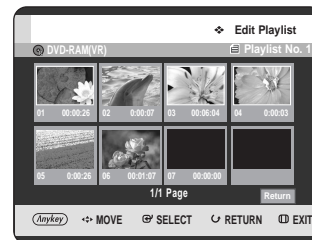

## Playing a Selected Scene

- 5** Press the **▲▼◀▶** buttons to select the scene you want to play, then press the **ANYKEY** button.  
The playlist entry to be played is selected.

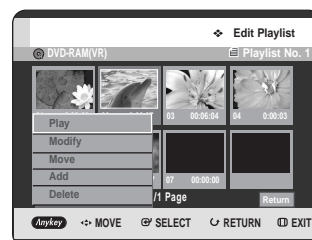

- 6** Press the **▲▼** buttons to select **Play**, then press the **ENTER** or **▶** button.  
The selected scene is played.

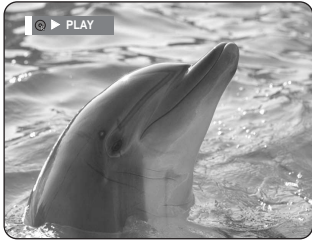

- To stop scene play, press the **STOP** (⏏) button.

### Modifying a Scene (Replacing a Scene)

To setup, follow steps 1 to 4 in page 90.

- 5** Press the **▲▼◀▶** buttons to select the scene you want to modify, then press the **ANYKEY** button.

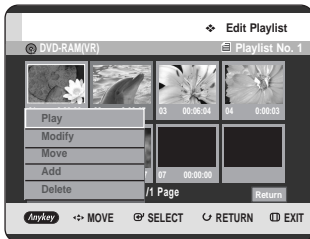

- 6** Press the **▲▼** buttons to select **Modify**, then press the **ENTER** or **▶** button.  
The Modify Scene screen is displayed.

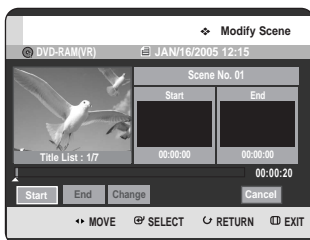

- 7** Press the **ENTER** button at the start point of the scene.

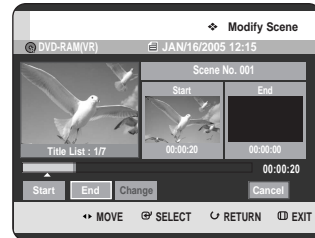

- The image and starting point time are displayed on the Start window.
- Select the starting or ending point of the section you want to modify using the playback related buttons (**PLAY**(▶), **SEARCH**(◀▶)).

- 8** Press the **ENTER** button at the end point of the scene.

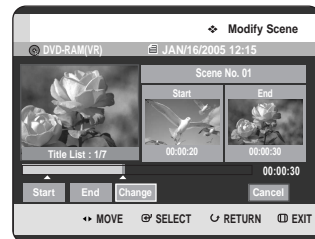

- The image and ending point time are displayed in the End window.
- The yellow-colored selection bar moves to the Change item.

- 9** Press the **◀▶** buttons to select **Change**, then press the **ENTER** button.

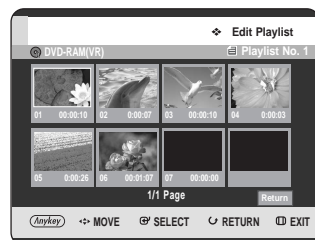

- The scene you want to modify is changed with the selected section.

## Moving a Scene (Changing the Position of a Scene)

To setup, follow steps 1 to 4 in page 90.

- 5 Press the **▲▼◀▶** buttons to select the scene you want to move (change the position), then press the **ANYKEY** button.

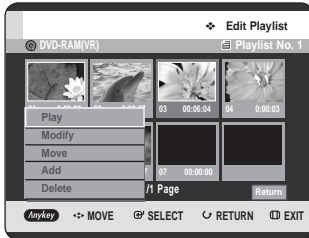

- 6 Press the **▲▼** buttons to select **Move**, then press the **ENTER** or **▶** button.

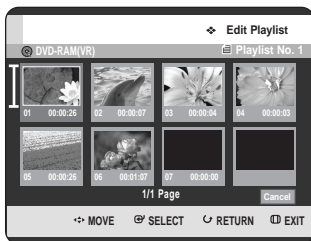

- A yellow outline is displayed around the scene to be moved.

- 7 Press the **▲▼◀▶** buttons to select the position to which you want to move the selected scene, then select the **ENTER** button.



- The selected scene is moved to the selected position.

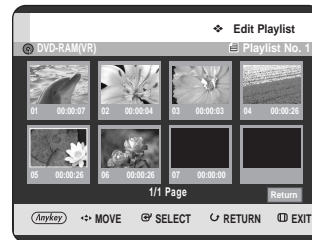

NOTE

- Depending on the type of disc you are using, the displayed screen may appear slightly different.

## Adding a Scene

To setup, follow steps 1 to 4 on page 90.

- 5** Press the **▲▼◀▶** buttons to select the scene that will have a new scene inserted before it, then press the **ANYKEY** button.

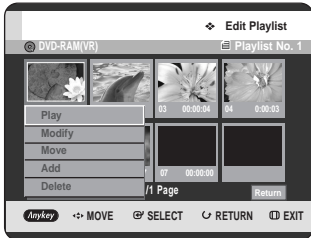

- 6** Press the **▲▼** buttons to select **Add**, then press the **ENTER** or **▶** button. The Add Scene screen is displayed.

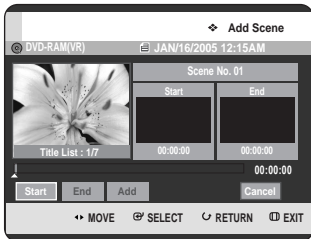

- 7** Press the **ENTER** button at the starting point of the scene.

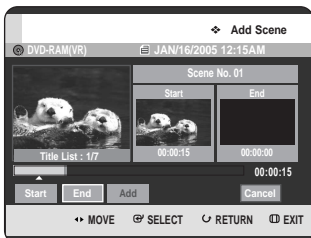

- The image and starting point time are displayed on the Start window.
- Select the starting or ending point of the section you want to modify using the playback related buttons (**PLAY** (▶), **SKIP** (◀▶)).

- 8** Press the **ENTER** button at the end point of the scene.

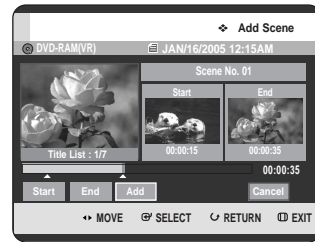

- The image and time of the end point are displayed in the End window.
- To cancel, press the **◀▶** buttons to select **Cancel**, then press the **ENTER** button.

- 9** Press the **◀▶** buttons to select **Add**, then press the **ENTER** button.

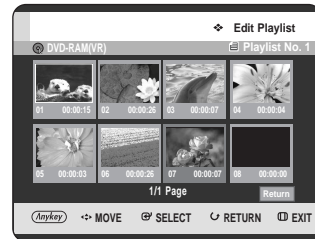

- The section you want to add is inserted prior to the scene selected in step 4 of Adding a Scene on the previous page.

## Deleting a Scene

To setup, follow steps 1 to 4 in page 90.

- 5** Press the **▲▼◀▶** buttons to select the scene you want to delete, then press the **ANYKEY** button.

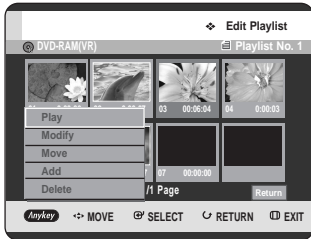

- 6** Press the **▲▼** buttons to select **Delete**, then press the **ENTER** or **▶** button.

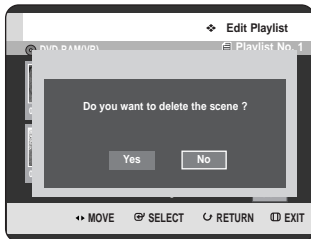

- The message "Do you want to delete the scene ?" is displayed.

- 7** Press the **◀▶** buttons to select **Yes**, then press the **ENTER** to delete the selected scene.

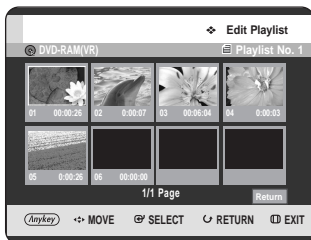

## Deleting a Playlist Entry from the Playlist



### Using the PLAY LIST button

- 1** Press the **RECORDER** button on the front panel or **R** button on the remote control.

- 2** With the unit in Stop mode, press the **PLAY LIST** button. The Edit Playlist screen is displayed.

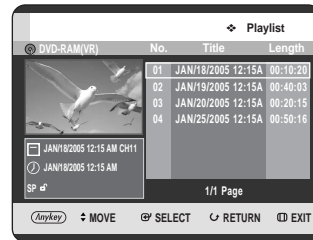

### Using the MENU button.

- With the unit in Stop mode, press the **MENU** button.
- Press the **▲▼** buttons to select **Title**, then press the **ENTER** or **▶** button. The Title List screen is displayed.
- Press the **ANYKEY** button.
- Press the **▲▼** buttons to select **Playlist**, then press the **ENTER** or **▶** button.
- Press the **▲▼** buttons to select **Go To Playlist**, then press the **ENTER** or **▶** button.

- 3** Press the **▲▼** buttons to select the title you want to delete from the Playlist, then press the **ANYKEY** button. The Edit Playlist menu is displayed: **Rename**, **Delete**, **Edit Playlist**, **Go To Titlelist**, **Disc Manager**.

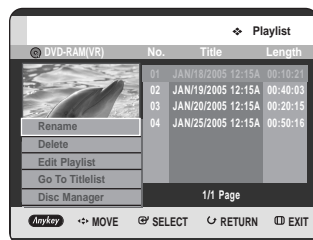

- 4** Press the ▲▼ buttons to select **Delete**, then press the **ENTER** or ► button.
- You will be prompted with the delete confirmation message “Do you want to delete?”.

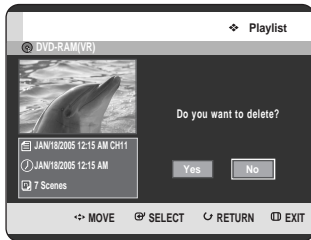

- 5** Press the ◀▶ buttons to select **Yes**, then press the **ENTER** button.
- You automatically returned to the Playlist screen after the delete operation has finished.

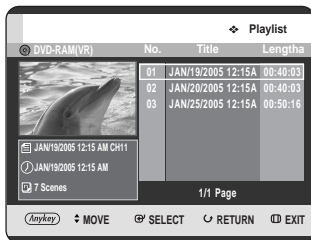
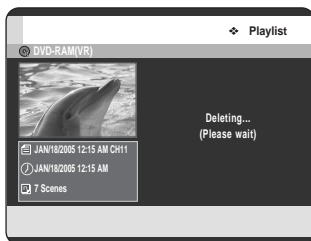

## About the Copy Screen

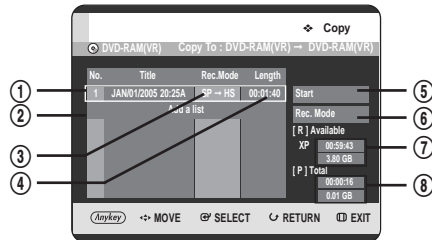

- Title to be copied
- Add titles to be copied (up to 7 titles can be copied at one time)
- Recording mode for copying
  - HS(high speed): you can copy more quickly than normal playback speed.
  - Copies in the same record mode as source title.
  - XP/SP/LP/EP : you can not use high speed copy.
- Record time of title to be copied
- Copy start button
- Record mode setup button
- Remaining time and space on the current disc in DVD Record mode
- Total record time and space of selected titles for copying

## Contents(Title) Copy Specifications

Contents(Title)	DVD-R	DVD-RW (VR mode)	DVD-RW (V mode)	DVD-RAM
Recorded Video Title	Yes	Yes	Yes	Yes
Copy Protected Title	No	No	No	No
Copy Once Title	No	No	No	No

Yes = Contents(Title) copying is possible.  
 No = Contents(Title) copying is not possible.

## Protection

This TWIN TRAY DVD RECORDER can allow you to protect the contents of your discs, as described below.

- Title Protection : See page 83 “Locking(Protecting) a Title”
- Disc Protection : See page 104 “Disc Protection”
- Title copy will function only if protection is cleared.

Player Tray		Recorder Tray					
		High speed Copy		Normal Copy			
Media	Copy contents	RAM	RW(VR)	RAM	RW(VR)	RW(V)	R(V)
DVD-RAM DVD-RW(VR)	Unedited Title	Yes	Yes	Yes	Yes	Yes	Yes
	Edited Title	No	No	Yes	Yes	Yes	Yes
	Playlist	No	No	Yes	Yes	Yes	Yes
DVD-RW(V) DVD-R(V)	Title copy	No	No	Yes	Yes	Yes	Yes

Yes = Contents(Title) copying is possible.  
No = Contents(Title) copying is not possible.

- **High speed copy** works only with the same Mode (VR → VR).
- Only Single-Layered Discs can be copied.
- When using **High speed Copy**, recording available time may differ depending on the amount of recorded data.
- **High speed copy** is done at the default speed of x2(DVD-RAM), x4(DVD-RW) or x8(DVD-R).
- **MP3, JPEG, DivX, VCD, CDDA** discs cannot be copied.
- Copy screen is not displayed during **High or Normal speed Copy**. The current Broadcast is displayed instead.



## Using the TITLE LIST button



- 1 Press the **PLAYER** button on the front panel or **P** button on the remote control.
- 2 Press the **OPEN/CLOSE** button and place a disc that contains a title you want to copy.
- 3 Press the **OPEN/CLOSE** button to close the disc tray. Wait until **LOAD** disappears from the front panel display and check that the recordable disc is in the **R** Tray.

- 4 With the unit in Stop mode/Playback mode, press the **TITLE LIST** button.  
The Title List screen is displayed.

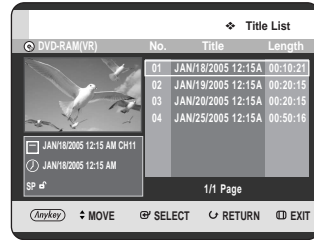

## Using the MENU button.

- With the unit in Stop mode/Playback mode, press the **MENU** button.
- Press the **▲▼** buttons to select **Title**, then press the **ENTER** or **▶** button.  
The Title List screen is displayed.

- 5 Press the **▲▼** buttons to select the title you want to copy.

To move to other pages, press the **SKIP**(◀▶) buttons.

**SKIP**(◀) : previous page of title list

**SKIP**(▶) : next page of title list

- 6 Press **ANYKEY** button, then press the **▲▼** buttons to select **COPY**, then press the **ENTER** or **▶** button.

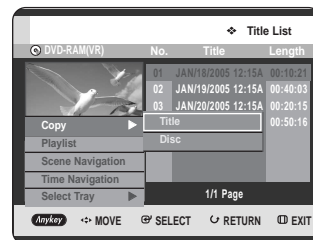



- 7** Press the ▲▼ buttons to select **Title**, then press the **ENTER** or ► button.  
The Copy screen is displayed.

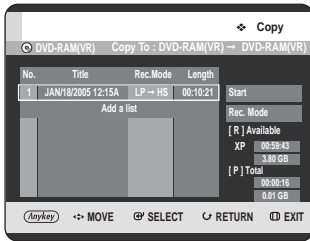

- If you want to change the record mode when copying, see page 98.

- 8** Press the **ENTER** or ► button to select **Start**, then press the **ENTER** button.

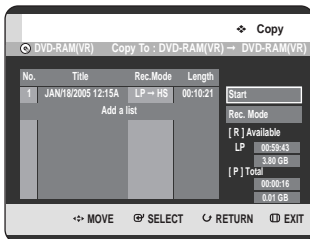

### - About Using DIRECT COPY button -

Press the ▲▼ buttons to select title that you want to copy from the title list and then press the **DIRECT COPY** button on the remote control. You will then be brought to the copy screen.

- During Playback, you can also copy the title by pressing the **DIRECT COPY** button. After select Copy Mode to title, you can go to copy screen.

### - Copying a Title that has been edited once before -

- 9** The "Do you want to view screen of copying title?" message is displayed.

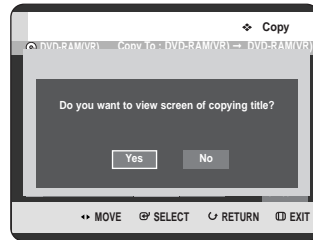

- 10** To copy a title while viewing the title on the copy screen, press the ◀▶ buttons to select **Yes**, then press the **ENTER** button.



- If **No** is selected, the title to be copied is not displayed on the screen. Copying begins while the current broadcast program is displayed on the screen.
- To cancel the copying in progress, press the **CANCEL** button.
- Press the **INFO** button to disappear the copy processing bar.

### - Copying an Unedited title -

- 9-1** The "Do you want to use high speed copy mode?" message is displayed.

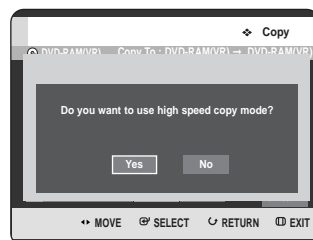



NOTE

- High speed copy : Copying can be performed at the maximum speed possible (4x).

**10**<sup>-1</sup> To begin high speed copy, press the ◀▶ buttons to select **Yes**, then press the **ENTER** button. High speed copy begins. The title being copied is not played back. The current broadcast program is displayed on the screen.



- If **No** is selected, the title to be copied is displayed at its playback speed while copying.
- To cancel the copying in progress, press the **CANCEL** button.
- Press the **INFO** button to disappear the copy processing bar.

**11**<sup>-1</sup> After a successful copy, "The title is successfully copied" message is displayed.



## Changing the Record Mode

To setup, follow steps 1 to 7 in page 96~97.

**8** Press the ▶ and ▼ buttons to select **Rec. Mode**, then press the **ENTER** button.

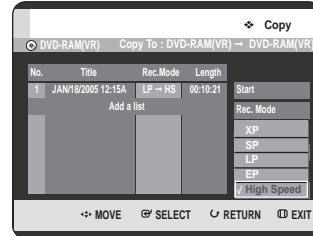

**9** Press the ▲▼ buttons to select the record mode you want to use, then press the **ENTER** button.

- HS(High Speed) : Copies in the same record mode the original disc was recorded in.
- XP/SP/LP/EP : You cannot copy a disc at a higher quality than it was originally recorded in. If the same record mode is selected, the title is copied at high speed.



NOTE

- This unit can not open the P tray and the R tray simultaneously.
- Using the same method, you can copy a Playlist.
- High speed copying is not available for a title list that has been deleted partially.
- During copying, timer recording is not available.
- High speed copying is not available when:
  - Copying a title that can only be copied once
  - Copying a playlist
  - Copying a partially-deleted title
- Regarding title lists that can be copied only once:
  - Only available for DVD discs that support CPRM.
  - If a playlist contains a scene that can only be copied once, it cannot be copied.
- The High Speed copying can be carried out at the maximum speed possible.

# Copying Multiple Titles at One Time



## Using the TITLE LIST button

- 1 Press the **PLAYER** button on the front panel or **P** button on the remote control.
- 2 Press the **OPEN/CLOSE** button and place a disc that contains a title you want to copy.
- 3 Press the **OPEN/CLOSE** button to close the disc tray. Wait until **LOAD** disappears from the front panel display and check that the recordable disc is in the **R** Tray.
- 4 With the unit in Stop mode/Playback mode, press the **TITLE LIST** button.  
The Title List screen is displayed.

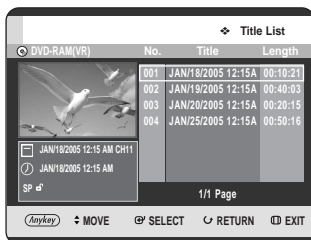

### Using the MENU button.

- With the unit in Stop mode/Playback mode, press the **MENU** button.
- Press the **▲▼** buttons to select **Title**, then press the **ENTER** or **▶** button.  
The Title List screen is displayed.

- 5 Press the **▲▼** buttons to select one of the title you want to copy.  
To move to other pages, press the **SKIP** (◀) (▶) buttons.  
**SKIP**(◀) : previous page of title list  
**SKIP**(▶) : next page of title list

- 6 Press the **ANYKEY** button.

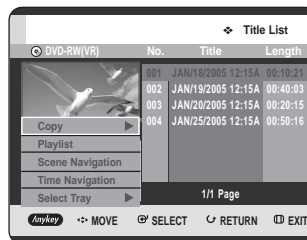

- 7 Press the **▲▼** buttons to select **Copy**, then press the **ENTER** or **▶** button and select **Title**.  
The Copy screen is displayed.

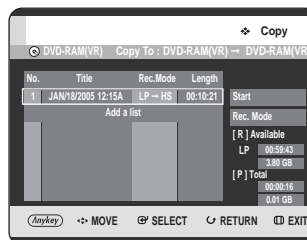

- 8 Press the **ANYKEY** button.

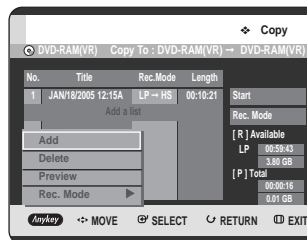

9 Press the ▲▼ buttons to select **Add**, then press the **ENTER** button.

The Add Copy List screen is displayed.

Press the ▲▼ buttons to select the title you want to copy, then press the **ENTER** button.

Other method: Press the ▲▼ buttons to select **Add a list**, then press the **ENTER** button.

Press the ▲▼ buttons to select the title you want to copy, then press the **ENTER** button.

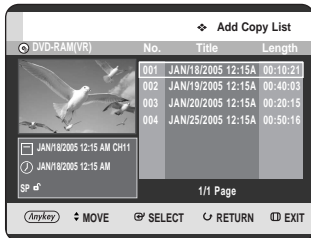

10 Repeat steps 8–9 to copy additional titles.

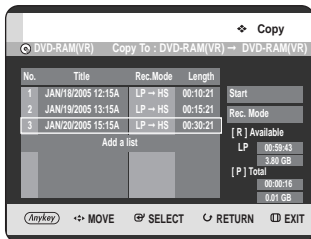

11 Press the **ENTER** or ► buttons to select **Start**, then press the **ENTER** button.

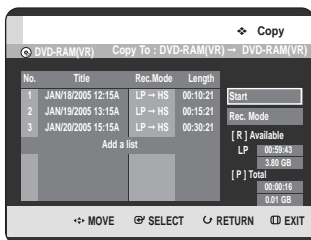

The added title lists are copied.

To cancel the copying in progress, press the **CANCEL** button.



- If copy list contains at least one title that cannot be copied at high speed, it performs step 9 described on page 97. Otherwise, it performs the step 9<sup>1</sup> described on page 97.

## Deleting an Undesired Title from the Copy List

To setup, follow steps 1 to 7 in page 99 and then continue with step 8 below.

8 Press the ▲▼ buttons to select a title you want to delete from the copy screen.

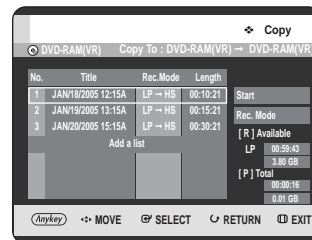

9 Press the **ANYKEY** button. Press the ▲▼ buttons to select **Delete**, then press the **ENTER** or ► button.

The message "Do you want to delete?" is displayed.

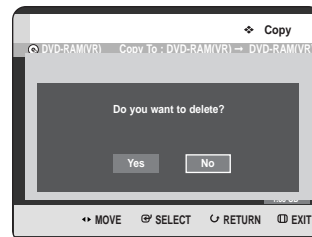

10 Press the ◀▶ buttons to select **Yes**, then press the **ENTER** button.

The selected title is deleted.

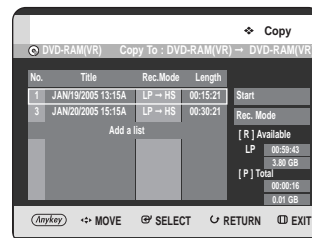

## Previewing a Selected Title from the Copy List

To setup, follow steps 1 to 7 in page 99 and then continue with step 8 below.

- 8 Press the ▲▼ buttons to select a title you want to preview in the copy screen.

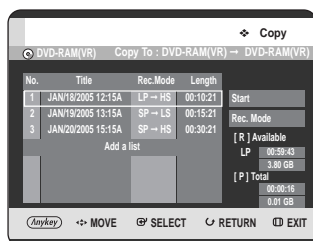

- 9 Press the ANYKEY button. Press the ▲▼ buttons to select **Preview**, then press the **ENTER** or ► button. You can preview the selected title through the display window located at the center of the screen.

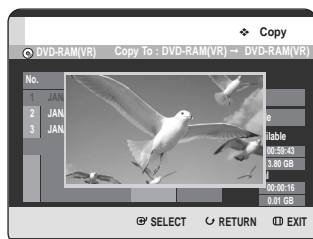

- 10 Press the **RETURN** button to exit the Preview mode.

## Selecting Record Mode of Each Title from the Copy List

You can copy multiple titles while setting different record modes for each title.

To setup, follow steps 1 to 7 in page 99 and then continue with step 8 below.

- 8 Press the ▲▼ buttons to select a title to change its record mode in the copy screen.

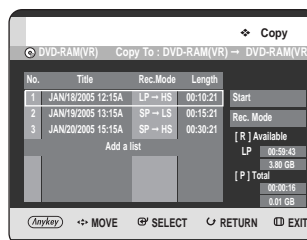

- 9 Press the ANYKEY button. Press the ▲▼ buttons to select **Rec. Mode**, then press the **ENTER** or ► button.

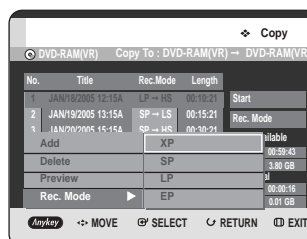

- 10 Press the ▲▼ buttons to select the record mode you want, then press the **ENTER** or ► button.

- 11 Repeat steps 9~11 to select a title to change its record mode. The rest of the copying process can be performed as described on pages 96 to 97.

## Changing Record Mode of All Titles from the Copy List

You can copy multiple titles while setting the same record mode for all titles.

To setup, follow steps 1 to 7 in page 99 and then continue with step 8 below.

- 8** Select the **Rec. Mode** on the right-hand side on the screen using the **▲▼◀▶** buttons, then press the **ENTER** button.

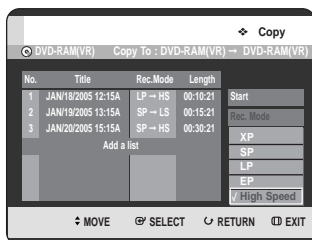

- 9** Press the **▲▼** buttons to select the record mode you want, then press the **ENTER** button. The rest of the copying process can be performed as described on pages 96 to 97.

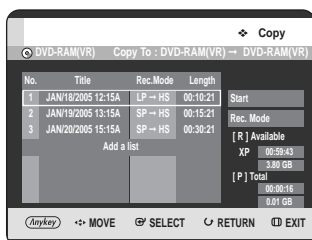

## Disc Copy



### Disc Copy Specifications

Recorder tray Player tray	DVD-R	DVD-RW (VR mode)	DVD-RW (V mode)	DVD-RAM
DVD-Dual Layer Disc	No	No	No	No
DVD-Single Layer, DVD-Video, without Copy Protection	Yes	No	Yes	No
Copy Protected Disc	No	No	No	No
Recorded Video Disc- DVD-RAM	No	No	No	Yes
Recorded Video Disc- DVD-RW (V Mode)	Yes	No	Yes	No
Recorded Video Disc- DVD-RW (VR Mode)	No	Yes	No	No
Recorded Video Disc- DVD-R	Yes	No	Yes	No

Yes = Disc copying is possible.  
No = Disc copying is not possible.

### Protection

This TWIN TRAY DVD RECORDER can allow you to protect the contents of your discs, as described below.

- Title Protection : See page 83 "Locking(Protecting) a Title"
- Disc Protection : See page 104 "Disc Protection"
- Cartridge protection : See page 6.  
Disc copy will operate only if these protection is cleared.

- 1** Press the **RECORDER** button on the front panel or **R** button on the remote control.
- 2** Press the **OPEN/CLOSE** button and insert a recordable disc in the R tray, then press the **PLAYER** button on the front panel or **P** button on the remote control.
- 3** Press the **OPEN/CLOSE** button and insert a non-copy protected disc that you want to copy into the P tray.

- 4** Press the **OPEN/CLOSE** button to close the disc tray. Wait until **LOAD** disappears from the front panel display and check that the recordable disc is in the **R** Tray.

- 5** With the unit in Stop mode/Playback mode, press the **DIRECT COPY** button. The “Do you want to start the Disc Copy?” message is displayed.

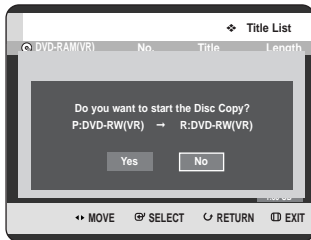

- 6** To perform **Disc Copy**, press the **◀▶** buttons to select **Yes**, then the “All data Recorder Tray’s Disc will be deleted. Do you want to continue?” message is displayed.

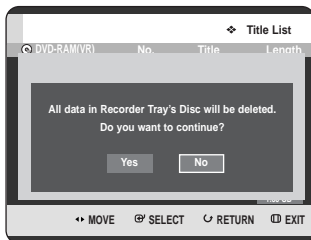

- 7** To begin **Disc Copy**, press the **◀▶** buttons to select **Yes**, then the Copy screen is displayed.

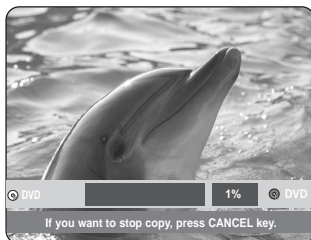

- To cancel the copying in progress, press the **CANCEL** button.
- Press the **INFO** button to disappear the copy processing bar.

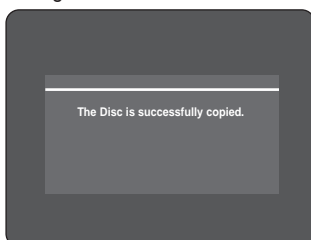

- MP3/JPEG/DivX file copy is not supported.
- This unit can not open the P tray and the R tray simultaneously.



- DVD-R discs are write-once media. Canceling in the middle of the writing process will make the DVD-R unusable.
- For DVD-RAM/RW discs, canceling in the middle of the writing process will erase the file which had been copied to the DVD-RAM/RW disc.

## Disc Manager

Disc manager functions are only available when a disc is inserted in the R tray.

### Editing the Disc Name

Follow these instructions to give a name to a disc.



- 1** With the unit in Stop mode / playback mode, press the **ANYKEY** button.

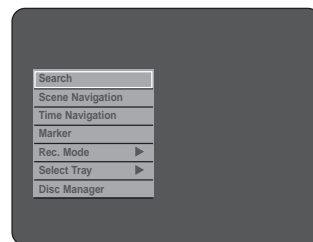

- 2** Press the **▲▼** buttons to select **Disc Manager**, then press the **ENTER** or **▶** button.

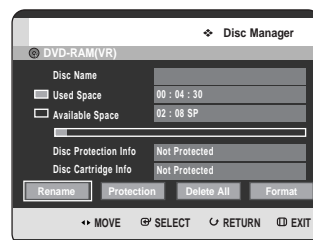

- 3** Press the ◀▶ buttons to select **Rename**, then press the **ENTER** button.  
The Rename screen is displayed.

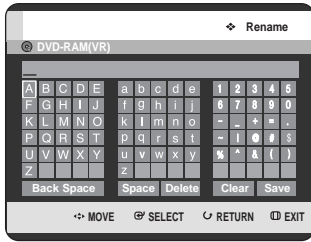

- 4** Select the desired characters using the ▲▼◀▶ buttons, then press the **ENTER** button.

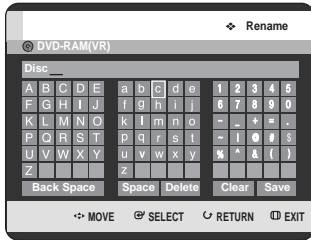

- 5** Press the ▲▼◀▶ buttons to select **Save**, then press the **ENTER** button.  
A disc name is given to the disc.

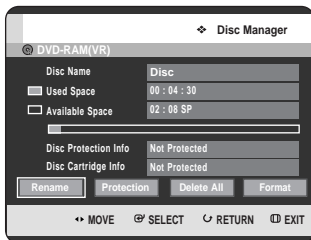

## Disc Protection

Disc Protection allows you to protect your discs from being formatted(erased) or deleted due to unintended operations.



- 1** With the unit in Stop mode / playback mode, press the **ANYKEY** button.

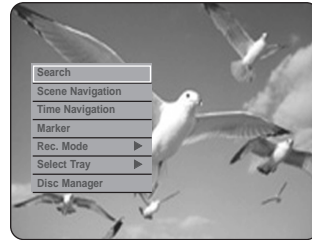

- 2** Press the ▲▼ buttons to select **Disc Manager**, then press the **ENTER** or ▶ button.

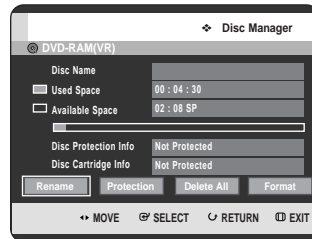

- 3** Press the ◀▶ buttons to select **Protection**, then press the **ENTER** button.

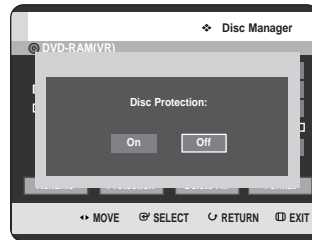

- 4** Press the ◀▶ buttons to select **On**, then press the **ENTER** button.



NOTE

- You may need to clear the disc protection before beginning editing.
- Depending on the disc type, the displayed screen may be different.
- You may need to clear cartridge protection (DVD-RAM) or unlock the protect before beginning editing.



NOTE

- Disc Protection will operate only if cartridge protect is cleared.



## Formatting a Disc

Use these instructions to format (erase) a disc. The cartridge write protect tab should be set to the unprotect position. The disc protect should also be cleared.



- 1 With the unit in Stop mode / playback mode, press the **ANYKEY** button.

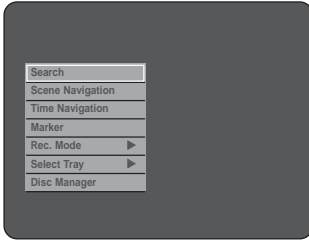

- 2 Press the **▲▼** buttons to select **Disc Manager**, then press the **ENTER** or **▶** button.

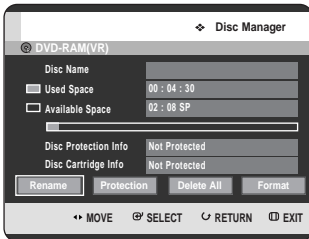

- 3 Press the **◀▶** buttons to select **Format**, then press the **ENTER** button.

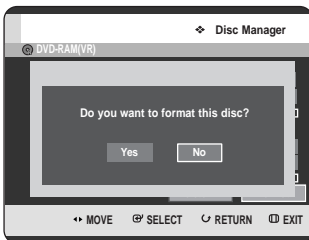

### DVD-RAM

- You will be prompted with the confirmation message "Do you want to format this disc?".
- If you select **Yes**, you will be prompted with the confirmation message "All data will be deleted. Do you want to continue?".

### DVD-RW

- You will be prompted with the confirmation message "Choose the recording format for DVD-RW."

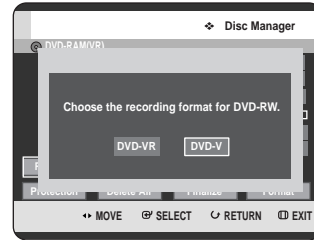

- 4 Press the **◀▶** buttons to select **Yes**, then press the **ENTER** button. The disc is formatted.

	DVD-VR	DVD-V
DISC	DVD-RAM DVD-RW	DVD-RW DVD-R

**DVD-VR and DVD-V are defined according to their recording format.**



NOTE

- Discs created in DVD-VR mode can only be played in DVD recorders. Discs created in DVD-V mode can be played on all standard DVD players.

## Delete All Title Lists



- 1 With the unit in Stop mode / playback mode, press the **ANYKEY** button.

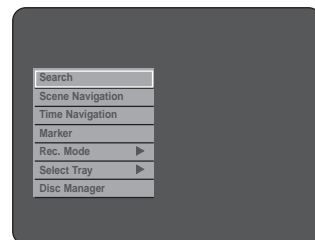

- 2** Press the ▲▼ buttons to select **Disc Manager**, then press the **ENTER** or ► button.

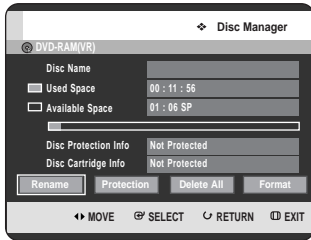

- 3** Press the ◀▶ buttons to select **Delete All**, then press the **ENTER** button.
- You will be prompted with the confirmation message "Do you want to delete all title lists?".

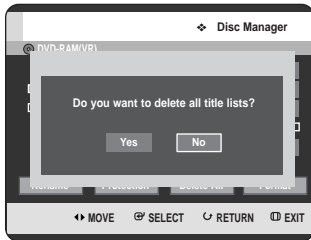

- When a Protected Entry exists: The Delete All Title List function will not operate. If you want to delete a protected entry, disable Protect for it on the Lock item.
- Disc Protection: When Disc Protection or Cartridge Protection has been set, data cannot be deleted from a disc.

- 4** Press the ◀▶ buttons to select **Yes**, then press the **ENTER** button. All title lists are deleted.

## Finalizing a Disc

After you record titles onto a DVD-RW/DVD-R disc with your TWIN TRAY DVD RECORDER, the disc needs to be finalized before it can be played back on external devices.



- 1** Press the **RECORDER** button on the front panel or **R** button on the remote control. With the unit in Stop mode, press the **ANYKEY** button.

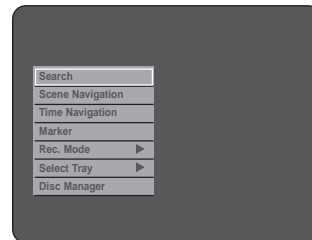

- 2** Press the ▲▼ buttons to select **Disc Manager**, then press the **ENTER** or ► button.

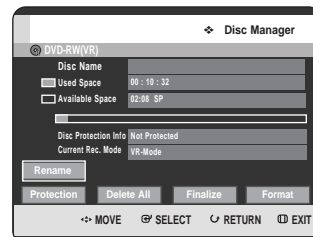

- 3** Press the ▲▼◀▶ buttons to select **Finalize**, then press the **ENTER** button. You will be prompted with the message "Do you want to finalize disc?".

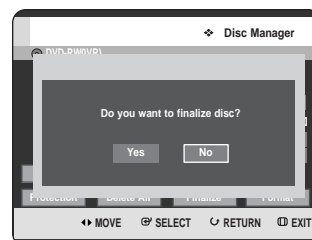

If you select **Yes**, you will be prompted again with the message “Disc will be finalized. Do you want to continue?”.



- 4** Press the ◀▶ buttons to select **Yes**, then press the **ENTER** button. The disc is finalized.



NOTE

- Once a disc is finalized, you cannot delete entries from the record list.
- After being finalized, the DVD-R/DVD-RW(video mode) operates in the same manner as a DVD-Video.
- Depending on the disc type, the displayed screen may be different.
- Finalizing time may be different depending on the amount of data recorded on the disc.
- Data on the disc will be damaged if the TWIN TRAY DVD RECORDER is powered off during finalize process.
- When the disc contains a music or JPEG files, you cannot finalize the disc.

## Unfinalizing a Disc (V/VR mode)



To add additional titles to a finalized disc, you must first unfinalize it.

- 1** Press the **RECORDER** button on the front panel or **R** button on the remote control. With the unit in Stop mode, press the **ANYKEY** button.

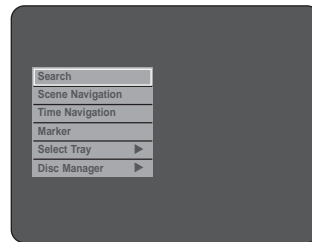

- 2** Press the ▲▼ buttons to select **Disc Manager**, then press the **ENTER** or ▶ button.

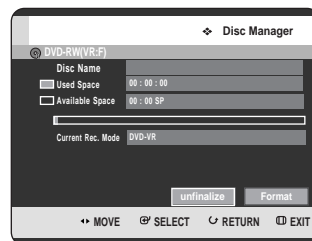

- 3** Press the ◀▶ buttons to select **Unfinalize**, then press the **ENTER** button. You will be prompted with the message “Do you want to unfinalize disc?”.

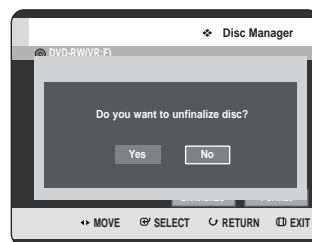

If you select **Yes**, you will be prompted again with the message “Disc will be unfinalized. Do you want to continue?”.

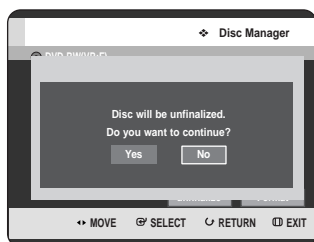

- 4** Press the ◀▶ buttons to select **Yes**, then press the **ENTER** button.  
The disc is unfinalized.



NOTE

- A DVD-RW can be finalized or unfinalized in Video mode.

	Finalize	Unfinalize
Mark	DVD-Video(RW)	DVD-RW(V)
Operation	Same as DVD-Video	Additional recording, protection and deletion are possible.

- A DVD-RW can be finalized or unfinalized in VR mode.

	Finalize	Unfinalize
Mark	DVD-RW(VR:F)	DVD-RW(VR)
Operation	Additional recording, deletion, editing, and protection are impossible.	Additional recording, deletion, editing, and protection are possible.

# Reference

Troubleshooting .....	109
Specifications .....	113
Warranty .....	114

## Troubleshooting

If your product malfunctions, go through the checkpoints below before contacting a Samsung authorized service center.

### Power

The input is displayed for a while when the power is turned on.



- Checkpoint 1** The TWIN TRAY DVD RECORDER requires some time to initialize and the input will be displayed for approx. 10 seconds after it is turned on.

### Recording

Cannot record TV programs.



- Checkpoint 1** Check whether the power cord is securely plugged into the power outlet.
- Checkpoint 2** Did you set the TWIN TRAY DVD RECORDER channel settings correctly?
- Checkpoint 3** Check the free space on your DVD-RAM/DVD-RW/DVD-R discs.
- Checkpoint 4** Is the DVD-RAM Cartridge protected?

I pressed the REC button but there is no response.



- Checkpoint 1** Recording is possible for DVD-RAM/DVD-RW/DVD-R discs only. If a program is copy protected, it cannot be recorded.

## Playback

Cannot play the disc.



- Checkpoint 1** Check whether the disc is inserted correctly with the label facing up.
- Checkpoint 2** Check the regional code of the DVD disc.
- Checkpoint 3** This TWIN TRAY DVD RECORDER cannot play some types of discs. (See page 6.)

⊘ icon appears on the screen.



- Checkpoint 1** You cannot use this operation or function due to one of the following reasons:
  - (1) Your DVD disc restricts it.
  - (2) Your DVD disc does not support this feature (for example: angles)
  - (3) The feature is not available at the moment.
  - (4) You've requested a title, chapter, or scan time that is out of range.

Play mode settings are different from the settings configured in the Settings menu.



- Checkpoint 1** The disc does not support all selected functions. In this case, some settings configured in the settings menu may not work properly.

Cannot change the aspect ratio.



- Checkpoint 1** The aspect ratio is fixed for some DVD discs. (See page 38.)

The angle operation does not work while playing a DVD disc.



- Checkpoint 1** The angle operation is available only when the disc contains images captured from different angles.

The selected audio and/or subtitle language is not played.



- Checkpoint 1** Audio and subtitle languages are disc-specific. Only the sound and subtitle languages contained on the DVD disc are available and displayed in the disc menu.

## Video

The disc revolves, but no image or bad quality images are displayed.



- Checkpoint 1** Check whether there is damage to or any foreign material on your disc.
- Checkpoint 2** Some low quality discs may not play properly.
- Checkpoint 3** If scenes change from dark to bright suddenly, the screen may shake vertically temporarily, but this is not a fault.

## Sound

No sound.



- Checkpoint 1** Are you watching a program in slow or skip mode?  
If you are playing a program at a speed other than normal speed, sound will not be heard.
- Checkpoint 2** Check the connections and settings.
- Checkpoint 3** Check whether the disc is damaged.  
Clean the disc, if necessary.
- Checkpoint 4** Check whether the disc is inserted correctly with the label facing up.

No audio output.



- Checkpoint 1** Check whether you have selected the correct digital output options in the Audio Output Options menu. (See page 36.)

## Timer Recording

Timer lamp flickers.



- Checkpoint 1** Check there is enough space in the disc for recording.
- Checkpoint 2** Check whether the current disc is recordable or not.  
Make sure to check before the start time of recording.

Timer recording does not work properly.



- Checkpoint 1** Re-check the recording time and the end time settings again.
- Checkpoint 2** Recording will be canceled if the power is interrupted due to a power failure or another similar reason while recording.

## Remote Control Unit

The remote control doesn't work.



**Checkpoint 1** Point the remote control at the remote control sensor on your TWIN TRAY DVD RECORDER. Allow for proper distance. Remove obstacles between your TWIN TRAY DVD RECORDER and the remote control.

**Checkpoint 2** Check the batteries.

**Checkpoint 3** Check for the DVD/TV selection button.

Other problems.



**Checkpoint 1** Read the table of contents and then find and read the section describing your problem, and follow the instructions given.

**Checkpoint 2** Turn your TWIN TRAY DVD RECORDER off and on.

**Checkpoint 3** If the problem still persists, contact a nearby Samsung service center or call 1-800-SAMSUNG to arrange service.

## Other

I forgot my password for parental supervision.



**Checkpoint 1** Press the (▶▶) buttons on your TWIN TRAY DVD RECORDER simultaneously when the power is on. All settings including the password will revert to the factory settings. Do not use this unless absolutely necessary. (Note that this function is possible only when no disc is inserted.)

Is it possible to change a subtitle and an audio signal on a recorded disc?



**Checkpoint 1** A recorded disc is played with only the subtitle and the audio signal which were selected during recording.



# Specifications



General	Power requirements	120V AC, 60Hz
	Power consumption	40 Watts
	Weight	10.47 lb
	Dimensions	16.9in(W) x 12.52in(D) x 3.11in(H)
	Operating temp.	+41°F to +95°F
	Other conditions	Keep level when operating. Less than 75% operating humidity
Input	Video (1,2)	1.0 V p-p at 75Ω load, sync negative
		S-Video input (Y: 1.0Vp-p, C: 0.286Vp-p at 75Ω load)
	Audio(1,2)	Max.Audio Input Level : 2Vrms
	DV Input	IEEE 1394(4p) compatible jack
Receivable Channels	Regular TV broadcasting: VHF (2-13), UHF (14-69)	
	Cable TV broadcasting: 1-125	
Output	Audio	Analog output jacks 1, 2
		Optical/Coaxial digital audio output
		Full scale Analog output level : 2Vrms
	Video	Video output jack 1
		S-Video output 1 (Y:1.0Vp-p, C:0.286Vp-p at 75Ω load)
		Component output 1 (Y: 1.0Vp-p, Pb: 0.70Vp-p, Pr: 0.70Vp-p at 75Ω load)
Recording	Picture Compression format	MPEG-II
	Audio Compression format	Dolby Digital 2ch/256kbps
	Recording Quality	XP (about 8.5 Mbps), SP (about 4.5 Mbps), LP (about 2 Mbps), EP (about 1.6 Mbps or about 1.2 Mbps)
	Audio Frequency Response	20 Hz ~ 20 kHz

## Audio Output

For DVD discs, audio signals recorded at 96kHz sampling frequency are converted into and output at 48kHz.

Disc Type	DVD	AUDIO CD(CD-DA)
Analog Audio Output	48 / 96kHz	44.1kHz
Digital Audio Output	48kHz	44.1kHz

# Warranty



## LIMITED WARRANTY TO ORIGINAL PURCHASER

This SAMSUNG brand product, as supplied and distributed by SAMSUNG ELECTRONICS AMERICA, INC. (SAMSUNG) and delivered new, in the original carton to the original consumer purchaser, is warranted by SAMSUNG against manufacturing defects in materials and workmanship for the following limited warranty period:

### **One (1) Year Parts / Ninety (90) Days Labor**

This limited warranty begins on the original date of purchase, and is valid only on products purchased and used in the United States, and does not include transportation, installation, removal or reinstallation. Warranty repairs must be performed by SAMSUNG's authorized service center. To receive warranty service, the original dated bill of sale must be presented upon request as proof of purchase to SAMSUNG or SAMSUNG's authorized service center. Transportation to and from the service center is the responsibility of the purchaser.

SAMSUNG will repair or replace this product, at our option and at no charge with new or reconditioned parts, if found to be defective during the limited warranty period specified above. The product must be returned during the warranty period with transportation charges prepaid to SAMSUNG's designated service center. Prior to returning any product for warranty service, the purchaser must contact SAMSUNG for problem determination and service procedures. SAMSUNG does not warrant uninterrupted or error-free operation of the product. All replaced parts and products become the property of SAMSUNG and must be returned to SAMSUNG. Replacement parts and products assume the remaining original warranty, or ninety (90) days, whichever is longer.

This limited warranty covers manufacturing defects in materials and workmanship encountered in normal, noncommercial use of this product and shall not apply to the following, including, but not limited to: damage which occurs in shipment; applications and uses for which this product was not intended; failures or problems which are caused by products or equipment not supplied by SAMSUNG; accidents, misuse, abuse, neglect, misapplication, fire, water, lightning or other acts of nature; incorrect electrical line voltage, fluctuations or surges; damage caused by improper or faulty installation; improper connection with any peripheral; product alteration or modification; improper or unauthorized repair; cosmetic damage or exterior finish; product with altered serial numbers; failure to follow operating instructions, customer adjustments, maintenance and environmental instructions that are covered and prescribed in the instruction book; use of non-SAMSUNG or unauthorized parts, supplies, accessories or equipment which damage this product or result in service problems; failures or problems due to incompatibility with other equipment.



**ELECTRONICS**

**SAMSUNG ELECTRONICS AMERICA, INC.**

**HEADQUARTERS**

105 Challenger Road, Ridgefield Park, N.J.  
07660-0511  
TEL: 1-800-SAMSUNG

**SERVICE DIVISION**

400 Valley Road, Suite 201, Mount Arlington, NJ 07856  
1-800-SAMSUNG (1-800-726-7864)  
[www.samsung.com](http://www.samsung.com)

AK68-00627D-01

## Free Manuals Download Website

<http://myh66.com>

<http://usermanuals.us>

<http://www.somanuals.com>

<http://www.4manuals.cc>

<http://www.manual-lib.com>

<http://www.404manual.com>

<http://www.luxmanual.com>

<http://aubethermostatmanual.com>

Golf course search by state

<http://golfingnear.com>

Email search by domain

<http://emailbydomain.com>

Auto manuals search

<http://auto.somanuals.com>

TV manuals search

<http://tv.somanuals.com>