

SAMSUNG

**MP3 PLAYER DOCKING
MICRO COMPONENT
CD/MP3/WMA-CD/CD-R/RW
PLAYBACK
MM-X5**

Instruction Manual

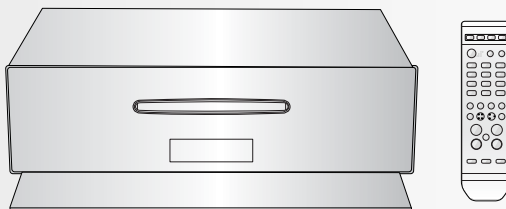

Safety Warnings

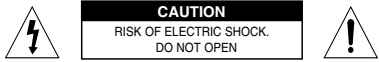

CAUTION: TO REDUCE THE RISK OF ELECTRIC SHOCK, DO NOT REMOVE COVER (OR BACK) NO USER-SERVICEABLE PARTS INSIDE REFER SERVICING TO QUALIFIED SERVICE PERSONNEL

This symbol indicates that dangerous voltage consisting a risk of electric shock is present within this unit.

This symbol indicates that there are important operating and maintenance instructions in the literature accompanying this unit.

CLASS 1 LASER PRODUCT

This Compact Disc player is classified as a CLASS 1 LASER product.

**CLASS 1 LASER PRODUCT
KLASSE 1 LASER PRODUKT
LUOKAN 1 LASER LAITE
CLASS 1 LASER APPARAT
PRODUCTO LASER CLASE 1**

Use of controls, adjustments or performance of procedures other than those specified herein may result in hazardous radiation exposure.

CAUTION : INVISIBLE LASER RADIATION WHEN OPEN AND INTERLOCKS DEFEATED, AVOID EXPOSURE TO BEAM.

This product satisfies FCC regulations when shielded cables and connectors are used to connect the unit to other equipment. To prevent electromagnetic interference with electric appliances, such as radios and televisions, use shielded cables and connectors for connections.

FCC NOTE (for U.S.A):

This equipment has been tested and found to comply with the limits for a Class B digital device, pursuant to Part 15 of the FCC Rules. These limits are designed to provide reasonable protection against harmful interference in a residential installation.

This equipment generates, uses and can radiate radio frequency energy and, if not installed and used in accordance with the instructions, may cause harmful interference to radio communications. However, there is no guarantee that interference will not occur in a particular installation.

If this equipment does cause harmful interference to radio or television reception, which can be determined by turning the equipment off and on, the user is encouraged to try to correct the interference by one or more of the following measures:

- Reorient or relocate the receiving antenna.
- Increase the separation between the equipment and receiver.
- Connect the equipment into an outlet on a circuit different from that to which the receiver is connected.
- Consult the dealer or an experienced radio/TV technician for help.

Caution: FCC regulations state that any unauthorized changes or modifications to this equipment may void the user's authority to operate it.



WARNING

- To reduce the risk of fire or electric shock, do not expose this appliance to rain or moisture.
- To prevent injury, this apparatus must be securely attached to the floor/wall in accordance with the installation instructions.

CAUTION

- Apparatus shall not be exposed to dripping or splashing and no objects filled with liquids, such as vases, shall be placed on the apparatus.

Important Safety Instructions

Read these operating instructions carefully before using the unit. Follow all the safety instructions listed below. Keep these operating instructions handy for future reference.

- 1) Read these instructions.
- 2) Keep these Instructions.
- 3) Heed all warnings.
- 4) Follow all instructions.
- 5) Do not use this apparatus near water.
- 6) Clean only with dry cloth.
- 7) Do not block any ventilation openings. Install in accordance with the manufacturer's instructions.
- 8) Do not install near any heat sources such as radiators, heat registers, stoves, or other apparatus (including amplifiers) that produce heat.
- 9) Do not defeat the safety purpose of the polarized or grounding-type plug. A polarized plug has two blades with one wider than the other. A grounding type plug has two blades and a third grounding prong. The wide blade or the third prong are provided for your safety. If the provided plug does not fit into your outlet, consult an electrician for replacement of the obsolete outlet.
- 10) Protect the power cord from being walked on or pinched particularly at plugs, convenience receptacles, and the point where they exit from the apparatus.
- 11) Only use attachment/accessories specified by the manufacturer.
- 12) Use only with the cart, stand, tripod, bracket, or table specified by the manufacturer, or sold with the apparatus. When a cart is used, use caution when moving the cart/apparatus combination to avoid injury from tip-over. 
- 13) Unplug this apparatus during lightning storms or when unused for long periods of time.
- 14) Refer all servicing to qualified service personnel. Servicing is required when the apparatus has been damaged in any way, such as power-supply cord or plug is damaged, liquid has been spilled or objects have fallen into the apparatus, the apparatus has been exposed to rain or moisture, does not operate normally, or has been dropped.

Contents

Thank you for buying this SAMSUNG micro component system. Please take time to read these instructions.

They will allow you to operate your system with ease and take full advantage of its features.

◆ SAFETY WARNINGS	2
◆ INSTALLING YOUR MICRO COMPONENT SYSTEM	
■ Top Panel View	4
■ Front Panel View	4
■ Remote Control	5
■ Rear Panel View	5
■ Where to Install Your Micro Component System	6
■ Connecting your System to the Power Supply	6
■ Inserting Remote Control Batteries	6
■ Connecting to an External Source	7
■ iPod Connection	7
■ Connecting the FM Antenna	8
■ Cooling Fan	8
■ DEMO Function	9
■ DIMMER Function	9
■ Setting the Clock	9
◆ MP3/WMA-CD/CD-PLAYER	
■ To play the CD/MP3/WMA-CD	10
■ Selecting a Track	11
■ Searching for a Specific Music Passage on a CD/MP3/WMA-CD	11
■ Repeating One or All Tracks on the CD	11
■ Repeating One or All Tracks on the MP3/WMA-CD Disc	11
◆ USING USB	
■ Playing USB	12
■ To use high speed search	13
■ To repeat	13
■ Selecting a Track from a USB Device	13
◆ TUNER	
■ Searching for and Storing Radio Stations	14
■ Selecting a Stored(preset) Station	14
■ Improving Radio Reception	14
◆ OTHER FUNCTIONS	
■ Timer Function	15
■ Cancelling the Timer	15
■ EQ Function	16
■ DNSe Function	16
■ ECO Mode Function	16
■ MUTE Function	17
■ Setting the System to Switch off Automatically	17
■ Connecting Headphones	17
◆ RECOMMENDATIONS FOR USE	
■ Safety Precautions	18
■ Cleaning Your Micro Component System	18
■ Precautions When Using Compact Discs	19
■ Troubleshooting	19
■ Technical Specifications	20
■ Supported USB Devices	21
■ Warranty	22

Symbols



Press



Push



Important



Note

TOP Panel View

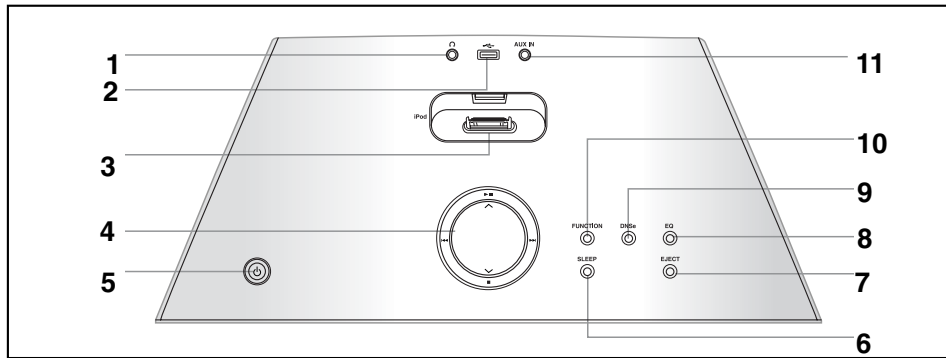

- | | |
|---|-------------------------------------|
| 1. HEADPHONE JACK CONNECTOR | 6. SLEEP |
| 2. USB | 7. EJECT |
| 3. iPod JACK | 8. EQ |
| 4. SEARCH FUNCTION /VOLUME CONTROL
BUTTONS | 9. DNSe |
| 5. STANDBY/ON/ECO | 10. FUNCTION
PLAY OR STOP BUTTON |
| | 11. AUX IN |

FRONT Panel View

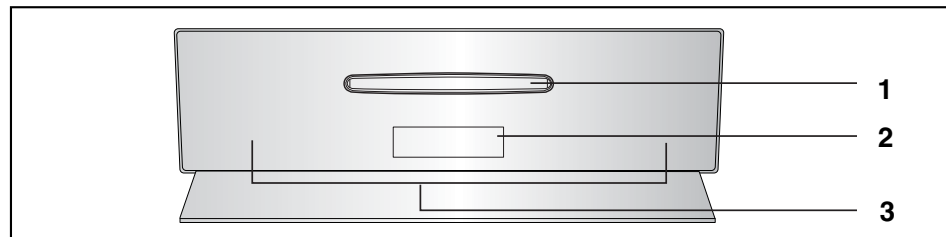

- | | |
|-------------------|----------------------|
| 1. CD DOOR | 3. BUILT IN SPEAKERS |
| 2. WINDOW DISPLAY | |

Accessories



Remote Control
(AH59-01787J)



FM Antenna
(AH42-00017A)

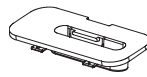

iPod cradle
(AH63-01529A,AH63-01530A,AH63-
01531A,AH63-01532A,AH63-01539A)



User Manual
(AH68-01952M)

> iPod cradle's feature

AH63-01529A	1-Generation NANO
AH63-01530A	2-Generation NANO
AH63-01531A	5-Generation:iPod 30G,60G
AH63-01532A	5-Generation:iPod 60G,80G
AH63-01539A	iPhone

Remote Control

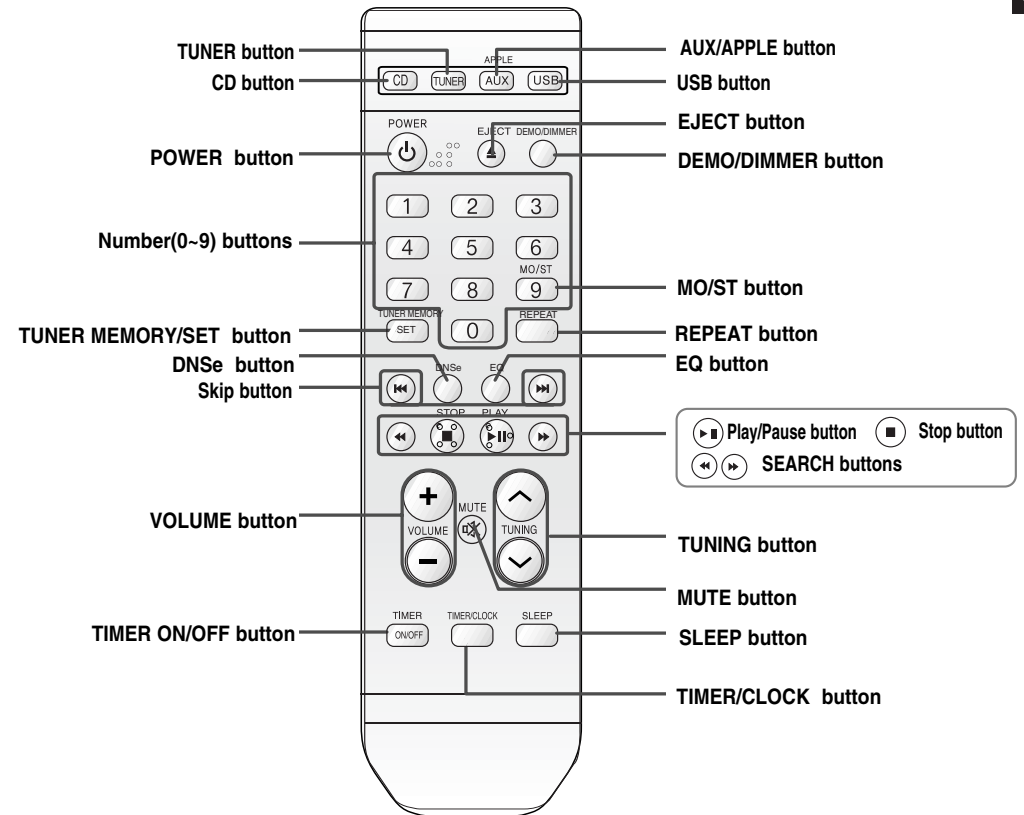

Rear Panel View

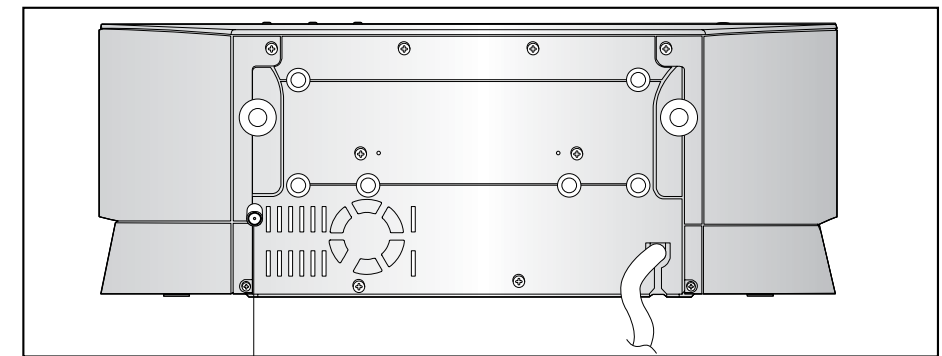

FM Antenna Connector Terminal

Where to Install Your Micro Component System

To take full advantage of your new micro component system, follow these installation instructions before connecting the unit.

- ◆ Install the system on a flat, stable surface.
- ◆ Never place this unit on carpeting.
- ◆ Never place this unit in an outdoor area.
- ◆ For ventilation purposes, maintain an open space of approximately 6 inches (15 cm) on the sides and rear of the system.
- ◆ Make sure that you have enough room to open the compact disc compartment easily.

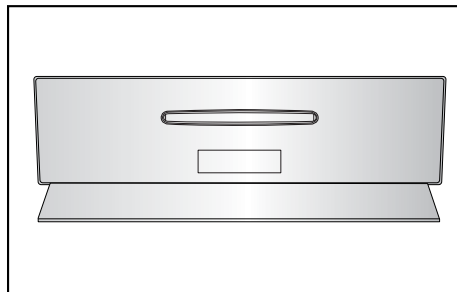

Connecting your System to the Power Supply

The power cord must be plugged into an 120V AC wall outlet.

- 1 Plug the power cord into an AC outlet.
- 2 Press the () button to switch your micro component system on.

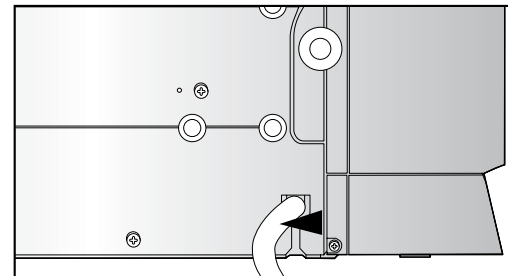

Inserting Remote Control Batteries

Insert or replace remote control batteries when you:

- ◆ Purchase the micro component system
- ◆ Find that the remote control is no longer operating correctly

➤ When replacing the batteries, use a new set of batteries and never mix alkaline and manganese batteries.

- 1 Place your thumb on the position marked  on the battery compartment cover (rear of the remote control) and pull the cover in the direction of the arrow.
- 2 Insert two AAA, LR03 or equivalent batteries, taking care to respect the polarities:
 - ◆ + on the battery against + in the battery compartment
 - ◆ - on the battery against - in the battery compartment
- 3 Replace the cover by sliding it back until it clicks into position.

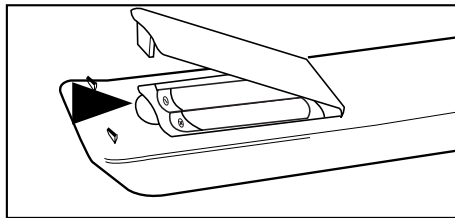

Connecting to an External Source

The auxiliary input can be used to take advantage of the sound quality of your micro component system when listening to other sources.

- Examples:
- ◆ A television
 - ◆ A DVD player
 - ◆ A VCR

➤ To connect to the external source, the source must have an audio output.

- 1 Set the system to standby mode and disconnect it and the external source from the AC outlet.
- 2 Connect the audio cable to the rear of the micro component system.
 - For optimum sound quality, do not invert the right and left channels.
- 3 Plug the system back into the AC outlet and press () to switch it on.
- 4 Select the AUX source by pressing **FUNCTION**.
Result: AUX is displayed.
- 5 Switch the external source on.

Example: You can watch a film on your DVD Player and take advantage of stereo sound this unit provides.

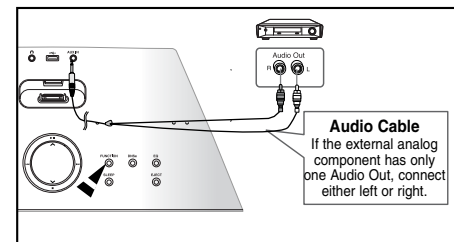

iPod Connection

You can listen to the audio from an iPod through the main unit.

- 1 Set the system to standby mode and disconnect it and the external source from the AC outlet.
- 2 Choose the appropriate iPod adapter and place into the micro component system. Place the iPod into the adapter and connect the iPod player to the top of the micro component system.
- 3 Plug the system back into the AC outlet and press () to switch it on.
- 4 Select the iPod source by pressing **FUNCTION**.
Result: Apple is displayed.
- 5 Switch the iPod on.

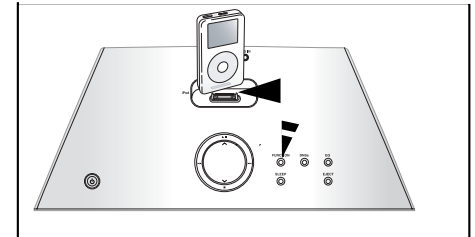

- When the unit is powered on and you connect an iPod MP3 player, the unit will charge your iPod's battery.
- iPod is registered trade mark of Apple Computer, Inc.

Connecting the FM Antenna

How to connect a COAXIAL TYPE antenna.

- ◆ Connect a 75Ω antenna to the FM antenna terminal.
- ◆ Plug the connector on the supplied FM antenna supplied into the coaxial socket (75Ω) marked FM on the rear of the system.
- ◆ Follow the instructions given on **Page 14** to tune into a radio station, and determine the best position for the antenna.
- ◆ If reception is poor, you may need to install an outdoor antenna.
To do so, connect an outdoor FM antenna to the FM socket on the rear of the system using a 75Ω coaxial cable (not supplied).

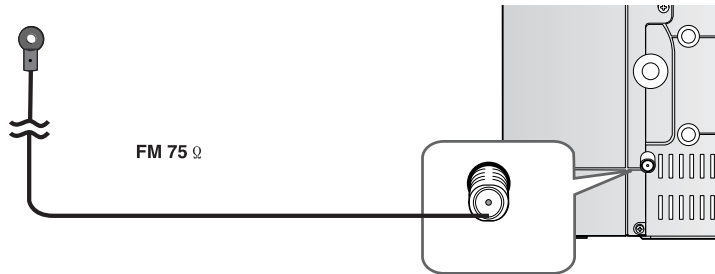

Cooling Fan

The cooling fan dissipates the heat generated inside the unit so that the unit can be operated normally. The cooling fan is activated automatically to supply cool air to the unit.

Please observe the following cautions for your safety.

- ◆ Make sure the unit is well-ventilated. If the unit has poor ventilation, the temperature inside the unit could rise and may damage it.
- ◆ Do not obstruct the cooling fan or ventilation holes. (If the cooling fan or ventilation holes are covered with a newspaper or cloth, heat may build up inside the unit and fire may result.)

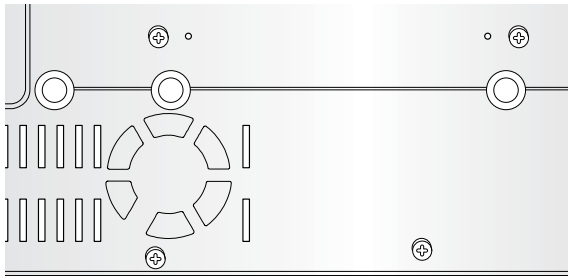

DEMO Function

You can view various functions available on your system.

- 1 Press the **DEMO/DIMMER** button.
Result: The available functions are listed in turn on the display.
- All these functions are described in detail in this booklet. For instructions on how to use them, refer to the appropriate sections.
- 2 To cancel this function, press **DEMO/DIMMER** again.

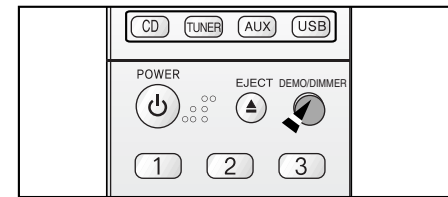

DIMMER Function

You can adjust the brightness of the display depending on the surrounding lighting conditions.

- 1 Press the **DEMO/DIMMER** button twice.
◆ Your selection switches each time the button is pressed: **DIMMER** → **DIMMER OFF**.



Setting the Clock

Your system is equipped with a clock which allows you to turn your system on and off automatically.

You should set the clock:

- ◆ When you first purchase the micro component system
 - ◆ After a power failure
 - ◆ After unplugging the unit
- For each step, you have a few seconds to set the required options. If you exceed this time, you must start again.

- 1 Switch the system on by pressing (**POWER**).
- 2 Press **TIMER/CLOCK** twice.
Result: **CLOCK** is displayed.
- 3 Press **SET**.
Result: The hour flashes.

- | 4 To... | Press... |
|--------------------|----------|
| Increase the hours | ↑ |
| Decrease the hours | ↓ |

- 5 When the correct hour is displayed, press **SET**.
Result: The minutes flash.

- | 6 To... | Press... |
|----------------------|----------|
| Increase the minutes | ↑ |
| Decrease the minutes | ↓ |

- 7 When the correct time is displayed, press **SET**.
Result: ◆ "TIMER" appears in the display.
◆ The current time is now set.

➤ You can display the time, even when you are using another function, by pressing **TIMER/CLOCK** once.

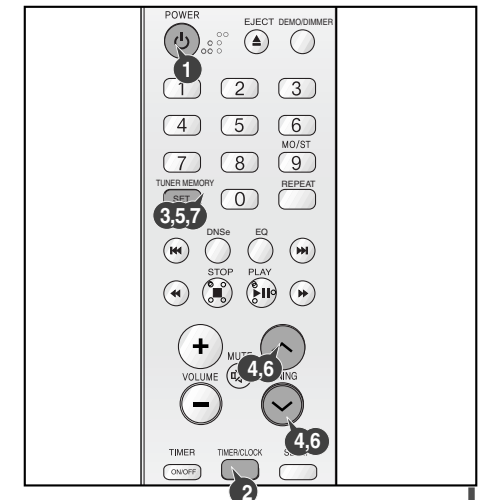

To play the CD/MP3/WMA-CD

You can play 5 or 3 1/2 Inch compact discs without an adapter.

This unit has been designed to playback the following CDs: Audio CD, CD-R, CD-RW and MP3/WMA-CD.

Continued use of irregular shape CDs (heart-shape, octagonal, etc.) can damage the unit.

- Load your disc in the compartment, with the label on the disc facing upwards.
- Select the MP3/CD function by pressing **FUNCTION** button.
 - Your CD Player will take a few minutes to scan through all the tracks recorded on a particular MP3/WMA-CD
 - The English name of the song may be indicated on the display only if directly downloaded from a PC or if the purchased MP3/WMA-CD is sorted according to titles(directory). (Other languages besides English may not be indicated.)
 - The English name of the track may not be indicated depending on the characteristics of the MP3/WMA-CD.
- Adjust the volume.
 - Press the **VOLUME +** or **-** button of the main unit.
 - The volume level can be adjusted as follows :VOL MIN,VOL 1- VOL 29,and VOL MAX.
- To pause playback temporarily, press **▶||** button. Press (**▶||**) again to continue playing the disc.
 - If the unit is paused for more than 3 minutes,it will automatically change for STOP.
- Press the **STOP** (■) button when you have finished.

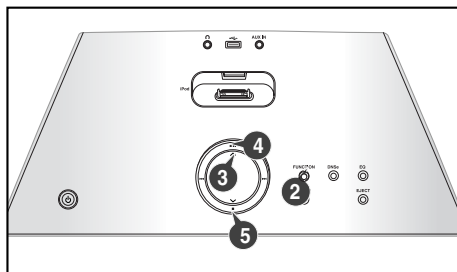

➤ When you press the EJECT button ,more than 1 minute later,the Disc will automatically load.

What is WMA?

WMA means Windows Media Audio, the global standard for audio signal compression technology.

What is MP3?

MP3 means MPEG1 Layer 3, the global standard for audio signal compression technology. It uses digital compression technology to compress original sound data by up to 12 times without sound quality degradation.

File Compatibility

- The unit will playback files created in MP3 format (Mpeg1.Layer3) with *.mp3 as their extension.
- Depending on the recording mode,some MP3/WMA-CDs may not play.
- Playback will be impossible for MP2 or 22KHz files.
- ID3*tags can be shown on the display in English.
- *An MP3 file can contain file information called "ID3 Tag " where its album name, performer, rack title, etc. are recorded.

How many MP3 files can be stored on a CD-R or CD-RW disc

The maximum capacity of one CD-R or CD-RW disc is 740MB. Normally, an MP3 file has a capacity of 4MB, therefore approximately 180 files can be stored on a single disc.

Regarding the playback of CD-R/RW

- If you have not recorded or edited a CD-R(Recordable) or CD-RW(Rewritable) properly,the disc may not play in this unit.
- The unit will take longer to read a CD-RW than a regular CD.

Selecting a Track

You can select the track you wish to listen to when a disc is playing.

To start playback at the beginning of the... Press...

Next track	▶▶ once
Current track	◀◀ once
Previous track	◀◀ twice
Track of your choice	◀◀ or ▶▶ the appropriate number of times.



- You also can use the number buttons to select the track.
 - Press the number buttons to choose the track that you want and then press **SET** button.

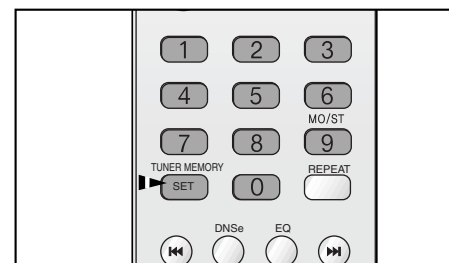

Searching for a Specific Music Passage on a CD/MP3/WMA-CD

When listening to a CD/MP3/WMA-CD, you can quickly search for a specific music passage within a track.

To search through the tracks... Press down...

- | | |
|-----------------|----|
| Forwards | ▶▶ |
| Backwards | ◀◀ |
- During Playback,you can select the playback speed for 2X,4X,8X and 32X times normal speed.
 - It is recommended that you turn the volume down before using this function.



Repeating One or All Tracks on the CD

You can repeat indefinitely:

- A specific track on a compact disc.
- All tracks on the compact disc selected.

- To repeat... Press Repeat on the remote control one or more times until...

The current track indefinitely ... REP ONE is displayed
All tracks REPEAT ALL is displayed

- To cancel this function, press **REPEAT** again.

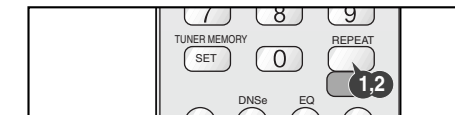

Repeating One or All Tracks on the MP3/WMA-CD Disc

You can repeat indefinitely:

- A specific track on a MP3/WMA-CD disc.
- All tracks on the MP3/WMA-CD disc selected.

- To repeat... Press Repeat on the remote control one or more times until...

The current track indefinitely...RPT ONE is displayed
All tracks RPT ALL is displayed
The folder..... RPT DIR is displayed
Play the tracks in random order RPT RDM is displayed

- To cancel this function, press **REPEAT** again.

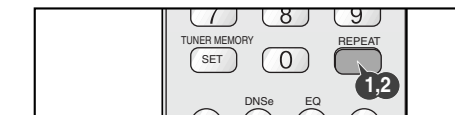

Playing USB

You can play MP3/WMA files by connecting to various external USB storage devices such as USB flash memory or HDD(Hard Disc drives).

- 1 Connect the external USB storage device to your player.
 - 2 Select USB function by pressing the **USB** button.
 - ◆ The first track of the first directory plays automatically.
- **To stop playing**
Press the Stop (■) button to stop playing.
- ◆ Press the Stop (■) button once to stop, and press the button twice to remove.

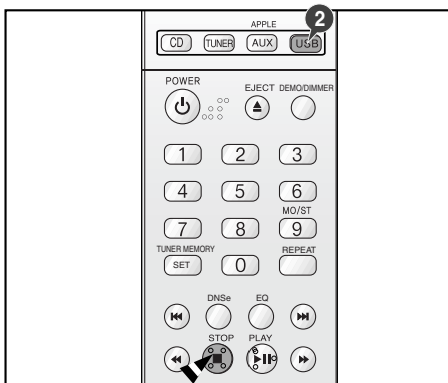
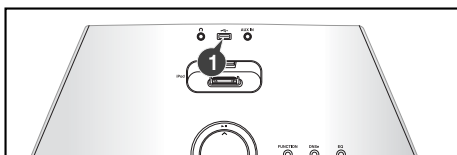

⚠ Do not connect a USB charging device to the USB connection port on the player, because it may cause damage to the product.

◆ The USB function of this product does not support all USB devices. For information on the supported devices, see page 21.

Please be aware of the following before using USB.

- ◆ Some external USB storage device may not be compatible with this player.
- ◆ With external HDD, FAT format can be played, however, the NTFS format can not.
- ◆ With USB 2.0 HDD, connect to a separate power source. If it's not connected to a separate power source, it may not work.
- ◆ If memory of an external USB storage device is segmented into several parts, MP3 files of only the first hard disk drive can be played.
- ◆ Up to four directories can be played.
- ◆ DRM applied files are not played.
Digital Rights Management: Technology and service that protect the profit and rights of copyright owners by disallowing unauthorized use of digital contents.
- ◆ Even if the file name ends with .mp3, the file does not play if actual file format is MPEG layer 1 or 2.
- ◆ Disconnect the external USB storage device only in safe removal mode("USB REMOVE" display ON/OFF). Otherwise, the internal file may be damaged.
Press the Stop (■) button more than 2 times to get into the safe removal mode.
If you want to play files in the safe removal mode, disconnect and reconnect the external USB storage device.
- ◆ Do not use a USB hub as it will not be recognized.
- ◆ Up to 20 letters of MP3/WMA file name will be shown.

Delay

- ◆ When selecting the USB function, file reading (READ-IN) may take several minutes.
- ◆ When playing a USB device, there may be a delay when advancing to the next track, especially with HDD.
- ◆ The operation time of external USB storage devices will vary; even when they are of the same capacity.
- ◆ If the external USB storage device supports only USB VER1.1 and the access speed is slow, the file may not property.

To use high speed search

Before you begin! ◆ Connect the external USB storage device to your player.
◆ Select the USB function by using the USB button.

You can search the desired section quickly during the play

- Press the ◀▶ button.
 - ◆ Whenever you press the button, you can search backward or forward 2X, 4X, 8X and 32X times normal speed.

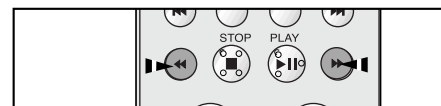

⚠ During fast playback, sound is heard only at 2X speed, and not at 4X, 8X, and 32X speeds.

To repeat

Before you begin! ◆ Connect the external USB storage device to your player.
◆ Select USB function by using the USB button.

- Press the **REPEAT** button during the play.
 - ◆ REPEAT ONE : repeat play one track only.
 - ◆ REPEAT DIR : repeat play the folder.
 - ◆ REPEAT RANDOM : play the tracks in random order. (A track that has already been played may be played again.)
 - ◆ REPEAT ALL : repeat play the entire directories.
 - ◆ REPEAT OFF : repeat play is turned off.

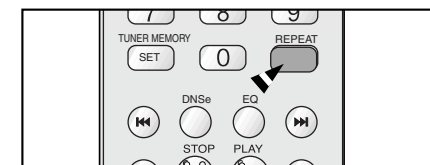

Selecting a Track from a USB Device

You can select an MP3 file during the play or when it stopped.

Before you begin! ◆ Connect the external USB storage device to your player.
◆ Select the USB function by using the USB button.

- If you want to move the next/previous(track), press the ◀▶ button.
 - ◆ It moves the next/previous file within the directory.
 - ◆ If you press the ◀▶ button more times than the number of the files in the directory, it will move over to the next directory.



- You also can use the number buttons to select the track.
 - ◆ Press the number buttons to choose the track that you want and then press the **SET** button.

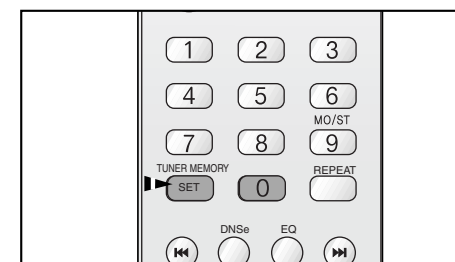

Searching for and Storing Radio Stations

You can store up to:

- ♦ 30 FM stations

- Switch the system on by pressing ().
- To listen to the Radio.
 - **Remote Control**
 - Press the **TUNER** button.
 - Tune in to the desired station.
 - ♦ Automatic Tuning 1: When the or button is pressed, stations you have preset are selected.
 - ♦ Automatic Tuning 2: Press and hold the or button to automatically search for active broadcasting stations.
 - ♦ Manual Tuning: Briefly press the or button to increase or decrease the frequency incrementally.
 - Main Unit**
 - Press the **Function** button to select the TUNER.
 - Select a broadcast station.
 - ♦ Automatic Tuning 1: Press the **STOP** () button to select <PRESET> and then press the or button to select a station you've preset.
 - ♦ Automatic Tuning 2: Press the **STOP** () button to select <MANUAL> and then press and hold the or button to automatically search the station.
 - ♦ Manual Tuning: Press the **STOP** () button to select <MANUAL> and then briefly press the or button to tune in to a lower or higher frequency.

- To store (Preset) stations in Memory.
 - Press the **TUNER** button.
 - Pressing or buttons on the top panel or or buttons on the remote control to increase or decrease the frequency respectively.
 - ♦ To scroll through the frequencies faster when searching manually, hold down the or buttons.
 - ♦ The automatic search procedure may stop on a frequency that does not correspond to a radio station. If this happens, use the manual search mode.
 - Press **TUNER MEMORY**.

Result: The current station NO is displayed for a few seconds.
 - Pressing or buttons on the remote control to assign a program number.
 - Press **TUNER MEMORY** to store the radio station.

Result: The current station NO is no longer displayed and the station is stored.
 - To store any other radio frequencies required, repeat Steps **b** to **e**.
 - ♦ The SET function can be used to assign a new station to an existing program number.

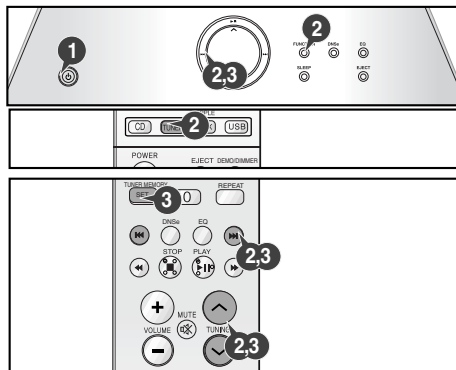

Selecting a Stored (preset) Station

You can listen to a stored radio station as follows:

- Switch the system on by pressing ().
- Press the TUNER button on the remote control.
- Select the radio station as follows.

To listen to ...	Press ...
Stored station	or button to select the desired preset section.

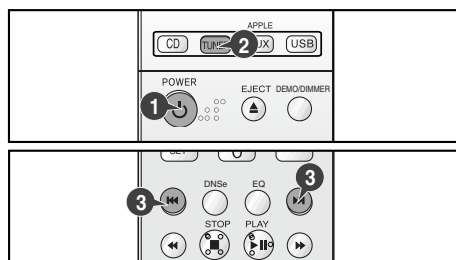

Improving Radio Reception

You can improve the quality of radio reception by:

- ♦ Rotating the FM antenna
- If reception from a specific FM radio station is poor, press **MONO/ST** to switch from stereo mode to mono. The quality of the sound will be improved.



Timer Function

The timer enables you to switch the system on or off at specific times.

Example: You wish to wake up to music every morning.

- If you no longer want the system to be switched on or off automatically, you must cancel the timer.

- ♦ Before setting the timer, check that the current time is correct.
- ♦ For each step, you have a few seconds to set the desired option. If you exceed the time, you must start again.

- Switch the system on by pressing ().
- Press **TIMER/CLOCK** until **TIMER** is displayed.
- Press **SET**.

Result: **ON TIME** is displayed (instead of the equalizer symbols) for a few seconds, followed by any switch-on time already set; you can set the timer switch-on time.
- Set the timer switch-on time.
 - Set the hour by pressing or button.
 - Press **SET**.

Result: The minutes flash.
 - Set the minutes by pressing or button.
 - Press **SET**.

Result: **OFF TIME** is displayed (instead of the equalizer symbols) for a few seconds, followed by any switch-off time already set; you can now set the timer switch-off time.
- Set the timer switch-off time.
 - Set the hour by pressing or button.
 - Press **SET**.

Result: The minutes flash.
 - Set the minutes by pressing or button.
 - Press **SET**.

Result: **VOL XX** is displayed, where XX corresponds to the volume already set.
- Press or button to adjust the volume level and press **SET**.

Result: The source to be selected is displayed.
- Press or button to select the source to be played when the system switches on.

If you select...

You must also...

- | | |
|-----------------------|--|
| TUNER (radio) | a Press SET . |
| | b Select a preset station by pressing or . |
| MP3/CD (compact disc) | Load a compact disc. |
| USB | connect usb. |

- Press **SET** to confirm the timer.
- Press () to set the system to standby mode.

Result: is displayed to the left of the time, indicating that the timer has been set. The system will switch on and off automatically at the required times.

 - ♦ If the timer switch on and off times are identical, the word **ERROR** is displayed.

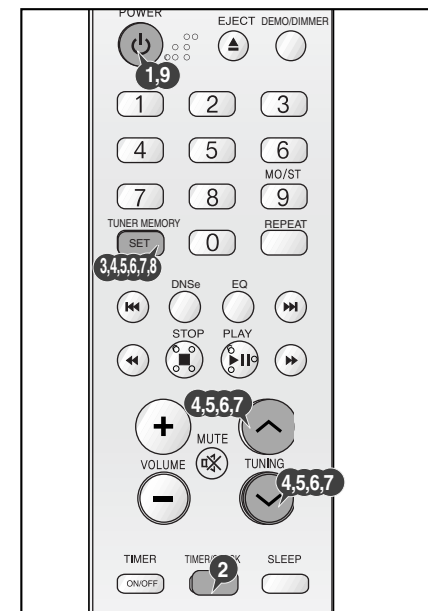

Cancelling the Timer

After having set the timer, it will start automatically as shown by the **TIMER** indication on the display. If you no longer wish to use the timer, you must cancel it.

- You can stop the timer at any time (system on or in standby mode).

To...	Press TIMER ON/OFF...
Cancel the timer	Once. Result: is no longer displayed.
Restart the timer	Twice. Result: is displayed again.

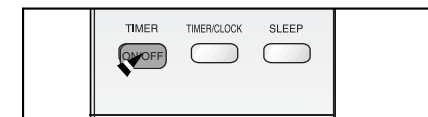

EQ Function

Your micro component system is equipped with a pre-set equalizer that allows you to choose the most appropriate balance between treble and bass frequencies, according to the type of music you are listening to.

Press **EQ** button until the required option is selected.
Result: Press the button repeatedly to select "PASS→POPS→JAZZ→CLASSIC→ROCK".

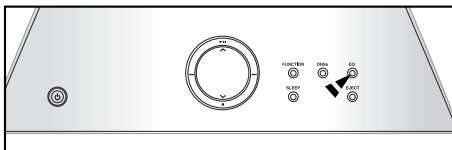

DNSe Function

Your compact system is equipped with the DNSe function. use this function you can select an appropriate sound effect for music.

Press **DNSe** button until the required option is selected.
Result: Press the button repeatedly to select "PASS→STUDIO→STAGE→CONCERT".

➤ What is DNSe?
Digital Natural Sound Engine(DNSe) is a sound effect function developed by Samsung.It provides various sound settings to enhance the type of music you're listening to.

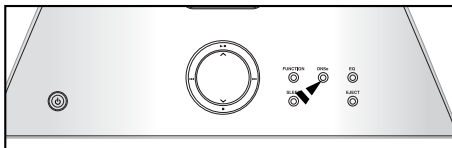

ECO Mode Function

You can save power consumption while the unit is turned off(on standby)

To activate the ECO mode,Press the **STANDBY/ON/ECO** button while the unit is turned off(on standby).

- ♦ When ECO is activated,the DEMO mode will not work.

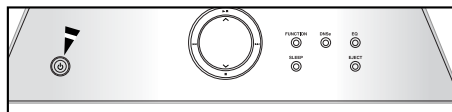

MUTE Function

You can turn the sound off temporarily on your system.

Example: You wish to answer a telephone call.

- 1 Press **MUTE** ().
- 2 To switch the sound back on (at the same volume as before), press **MUTE** again or the **VOLUME** buttons.

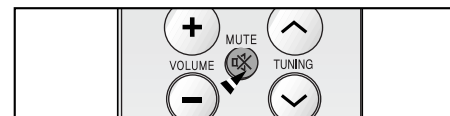

Setting the System to Switch off Automatically

While listening to a compact disc , you can set the system to switch off automatically

Example: You wish to go to sleep to music.

- 1 Press **SLEEP** button until the option is selected .
Result: The following indications are displayed:
90 MIN
- 2 Press **SLEEP** one or more times to indicate how long the system should continue playing before it switches off:

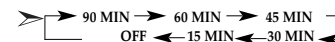

At any time, you can:

- ♦ Check the remaining time by pressing **SLEEP**.
- ♦ Change the remaining time by repeating Steps 1 and 2.

- 3 To cancel SLEEP function, press **SLEEP** more times until **OFF** is display.

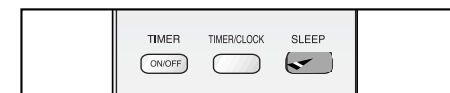

Connecting Headphones

You can connect a set of headphones to your micro component system so that you can listen to music without disturbing other people in the room. The headphones must have a 3.5ϕ plug or an appropriate adapter.

Connect the headphones to the **PHONES** jack on the top panel.
Result: The loudspeakers are no longer used to output the sound.

➤ Prolonged use of headphones at a high volume may damage your hearing.

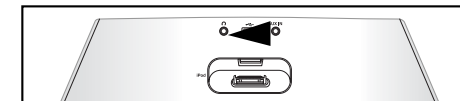

Safety Precautions



The following diagrams illustrate the precautions to be taken when using or moving your micro component system.

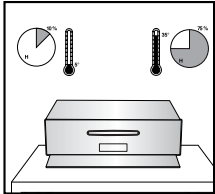

Ambient operating conditions:
Ambient temperature 41°F-95°F
Humidity 10-75%

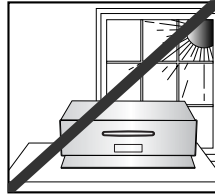

Do not expose the unit to direct sunlight or other heat sources. This could lead to overheating and malfunction of the unit.

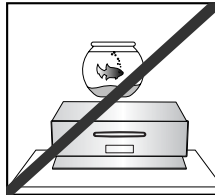

Do not place potted plants or vases on top of the unit. Moisture entering the unit could lead to dangerous electric shock and can cause equipment damage. In such events immediately disconnect the main plug from the outlet.

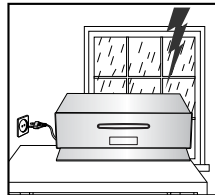

During thunderstorms, disconnect the main plug from the outlet voltage peaks due to lightning could damage the unit.

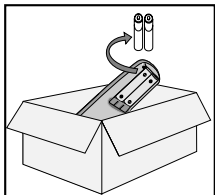

Remove the batteries from the remote control, if not used for any extended period. Leaking batteries can cause serious damage to the remote control.

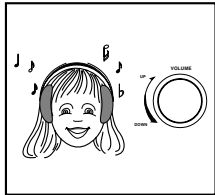

When using headphones, take care not to listen at excessive volumes. Extended use of headphones at high volumes may lead to hearing damage.

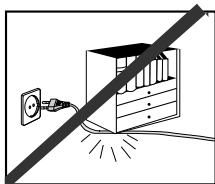

Do not place heavy items on the power cord. If the power cord is damaged it may lead to equipment damage (fire hazard) and may cause an electric shock.

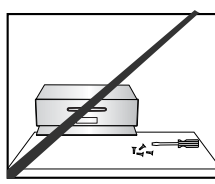

Do not remove any equipment panels. The inside of the unit contains live components, which cause electric shock.

Cleaning Your Micro Component System

To obtain the best possible results from your micro component system, you must clean the following elements regularly:

- ◆ The outer casing
- ◆ The compact disc player

Always unplug the system from the wall outlet:

- ◆ Before cleaning it
- ◆ If you are not going to be using it for a long time

Outer Casing

Clean the outer casing regularly using a soft cloth and a light detergent. Do not use abrasive powders, liquids or aerosol cleaners. Never let any liquids get into the system.

Compact Disc Player

- 1 Before playing a compact disc, clean it with a special CD cleaning agent. Do not use the same cleaning agents as for vinyl LP records. Carefully wipe the disc from the center outward.
- 2 Regularly clean the player with a special cleaning disc (available from your local dealer).

- ◆ If you will not be using the remote control for a long time, remove the batteries to prevent corrosion.
- ◆ Do not be use this system in an excessively dusty environment or subject it to shock or extreme heat (close to heating appliances or in direct sunlight ect).
- ◆ If the unit emits an unpleasant odor when in use, unplug it from the power supply and contact a Samsung authorized service center.

Precautions When Using Compact Discs

- ◆ Handle your compact discs with care. Always hold them by the edges to avoid leaving fingerprints on the shiny surface.
- ◆ When you have finished playing a compact disc, always put it back in its case.
- ◆ Do not fix paper or adhesive tape to the discs and do not write on the label.
- ◆ Clean them with a special-purpose cloth.
- ◆ Store your compact discs in a clean place, out of direct sunlight, where they will not be exposed to high temperatures.
- ◆ Always use compact discs marked

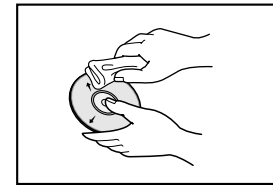

Troubleshooting

It always takes a little time to become familiar with a new player.

If you have any of the problems listed below, try the solutions given. They may save you the time and inconvenience of an unnecessary service call.

Problem	Checks/Explanation
The system does not work	<ul style="list-style-type: none"> ◆ The power cord is not correctly plugged into a wall socket or the wall socket is not switched on. ◆ The remote control batteries need replacing or the polarity is incorrect.. ◆ The button has not been pressed.
There is no sound	<ul style="list-style-type: none"> ◆ The volume has been completely turned down. ◆ The correct function (TUNER, MP3/WMA-CD/CD, AUX) has not been selected. ◆ You have connected a set of ear-phones. ◆ The MUTE button has been pressed.
The Timer does not work	<ul style="list-style-type: none"> ◆ The timer has been stopped by pressing TIMER ON/OFF.
The unit does not work, even after following the Troubleshooting steps above.	<ul style="list-style-type: none"> ◆ Press the STOP () button for 5 seconds to reset the unit. ◆ Press the STOP () button for 5 seconds with No disc in the unit to reset the unit.
The compact disc player does not start playing	<ul style="list-style-type: none"> ◆ The CD function has not been selected. ◆ The disc has been inserted face down or is either dirty or scratched. ◆ The laser sensor is dirty or dusty. ◆ The system has not been installed on a flat, horizontal surface. ◆ Condensation has formed in the player; leave the system in a warm, airy room for at least one hour.
Reception is poor or no radio stations are received at all	<ul style="list-style-type: none"> ◆ The TUNER function has not been selected. ◆ The radio frequency has not been correctly selected. ◆ The antenna has been disconnected or is not facing the right way. Turn it until you find the best orientation. ◆ You are in a building that blocks radio waves; you must use an outside antenna.

If the above guidelines do not allow you to solve the problem, take a note of:

- ◆ The model and serial numbers, normally printed on the rear of the system
- ◆ Your warranty details
- ◆ A clear description of the problem

Then contact your local dealer or SAMSUNG authorized service.

Technical Specifications

SAMSUNG strives to improve its products at all times. Both the design specifications and these user instructions are thus subject to change without notice.

RADIO

FM

Signal/noise ratio	55 dB
Usable sensitivity	10 dB
Total harmonic distortion	0.8 %

COMPACT DISC PLAYER

Frequency range	20 Hz - 20 KHz (± 1 dB)
Signal/noise ratio	70 dB (at 1 KHz) with filter
Distortion	0.2 % (at 1 KHz)
Channel separation	45 dB
Disc sizes	Diameter: 5 or 3 1/2 inches. Thickness: 0.05 inches

AMPLIFIER

Output power(4 Ω)	10 W/CH (total harmonic distortion : 10%)
Channel separation	45 dB
Signal/noise ratio	72 dB

GENERAL

Power Requirements	AC 120V ~ 60Hz
Power Consumption	30W
Weight	7.93 lbs
Dimensions	15.9 (W) x 7.0(H) x 5.8(D) inches

Supported USB Devices

Digital Camera

Product	Company	Type
Finepix-F810	Fuji	Digital Camera
Finepix-F610	Fuji	Digital Camera
Finepix-4450	Fuji	Digital Camera
Finepix S7000	Fuji	Digital Camera
Finepix A310	Fuji	Digital Camera
KD-310Z	Konica	Digital Camera
Finecam SL300R	Kyocera	Digital Camera
Finecam SL400R	Kyocera	Digital Camera
Finecam S5R	Kyocera	Digital Camera
Finecam Xt	Kyocera	Digital Camera
Dimage-Z1	Minolta	Digital Camera
Dimage Z1	Minolta	Digital Camera
Dimage X21	Minolta	Digital Camera
Coolpix4200	Nikon	Digital Camera
Coolpix4300	Nikon	Digital Camera
Coolpix 2200	Nikon	Digital Camera
Coolpix 3500	Nikon	Digital Camera
Coolpix 3700	Nikon	Digital Camera
Coolpix 4100	Nikon	Digital Camera
Coolpix 5200	Nikon	Digital Camera
Stylus 410 digital	Olympus	Digital Camera
300-digital	Olympus	Digital Camera
U300	Olympus	Digital Camera
X-350	Olympus	Digital Camera
C-760	Olympus	Digital Camera
C-5060	Olympus	Digital Camera
X1	Olympus	Digital Camera
U-mini	Olympus	Digital Camera
Lumix-FZ20	Panasonic	Digital Camera
DMC-FX7GD	Panasonic	Digital Camera
Lumix LC33	Panasonic	Digital Camera
LUMIX DMC-F1	Panasonic	Digital Camera
Optio-S40	Pentax	Digital Camera
Optio-S50	Pentax	Digital Camera
Optio 33LF	Pentax	Digital Camera
Optio MX	Pentax	Digital Camera
Digimax-420	Samsung	Digital Camera
Digimax-400	Samsung	Digital Camera
Sora PDR-T30	Toshiba	Digital Camera
Coolpix 5900	Nikon	Digital Camera
Coolpix S1	Nikon	Digital Camera
Coolpix 7600	Nikon	Digital Camera
DMC-FX7	Panasonic	Digital Camera
Dimage Xt	Minolta	Digital Camera
AZ-1	Olympus	Digital Camera

USB Flash Disk

Product	Company	Type
Cruzer Micro	Sandisk	USB 2.0 USB Flash Drive 128M
Cruzer Mini	Sandisk	USB 2.0 128M
Cruzer Mini	Sandisk	USB 2.0 256M
SONY Micro Vault	Sony	USB 2.0 64MB
FLEX DRIVE	Serotech	USB 2.0 32MB
AnyDrive	A.L tech	USB 2.0 128MB
XTICK	LG	USB 2.0 128M
Micro Mini	lomega	USB 2.0 128M
iFlash	Imation	USB 2.0 64M
LG	XTICK(M)	USB 2.0 64M
RiDATA	EZDrive	USB 2.0 64M

MP3 Player

Product	Company	Type
Creative MuVo NX128M	Creative	128 MB MP3 Player
Iriver H320	Iriver	20G HDD MP3 Player
YH-920	Samsung	20G HDD MP3 Player
YP-T7	Samsung	MP3 Player
YP-MT6	Samsung	MP3 Player
YP-T6	Samsung	MP3 Player
YP-53	Samsung	MP3 Player
YP-ST5	Samsung	MP3 Player
YP-T5	Samsung	MP3 Player
YP-60	Samsung	MP3 Player
YP-780	Samsung	MP3 Player
YP-35	Samsung	MP3 Player
YP-55	Samsung	MP3 Player
iAUDIO U2	Cowon	MP3 Player
iAUDIO G3	Cowon	MP3 Player
iAudio M3	Cowon	HDD MP3 Player
SI-M500L	Sharp	256MB MP3 Player
H10	Iriver	MP3 Player
YP-T5 VB	Samsung	MP3 Player
YP-53	Samsung	256MB MP3 Player

USB External HDD

Product	Company	Type
MOMOBAY UX-2	Dvico	USB 2.0

Warranty

LIMITED WARRANTY TO ORIGINAL PURCHASER

This SAMSUNG brand product, as supplied and distributed by Samsung Electronics America, Inc. (SAMSUNG) and delivered new, in the original carton to the original consumer purchaser, is warranted by SAMSUNG against manufacturing defects in materials and workmanship for a limited warranty period of:

One (1) Year Parts and Labor*
(*90 Days Parts and Labor for Commercial Use)

This limited warranty begins on the original date of purchase, and is valid only on products purchased and used in the United States. To receive warranty service, the purchaser must contact SAMSUNG for problem determination and service procedures. Warranty service can only be performed by a SAMSUNG authorized service center. The original dated bill of sale must be presented upon request as proof of purchase to SAMSUNG or SAMSUNG's authorized service center. Transportation of the product to and from the service center is the responsibility of the purchaser.

SAMSUNG will repair or replace this product, at our option and at no charge as stipulated herein, with new or reconditioned parts or products if found to be defective during the limited warranty period specified above. All replaced parts and products become the property of SAMSUNG and must be returned to SAMSUNG. Replacement parts and products assume the remaining original warranty, or ninety (90) days, whichever is longer.

SAMSUNG's obligations with respect to software products distributed by SAMSUNG under the SAMSUNG brand name are set forth in the applicable end user license agreement. Non-SAMSUNG hardware and software products, if provided, are on an "AS IS" basis. Non-SAMSUNG manufacturers, suppliers, publishers, and service providers may provide their own warranties.

This limited warranty covers manufacturing defects in materials and workmanship encountered in normal, and except to the extent otherwise expressly provided for in this statement, noncommercial use of this product, and shall not apply to the following, including, but not limited to: damage which occurs in shipment; delivery and installation; applications and uses for which this product was not intended; altered product or serial numbers; cosmetic damage or exterior finish; accidents, abuse, neglect, fire, water, lightning or other acts of nature; use of products, equipment, systems, utilities, services, parts, supplies, accessories, applications, installations, repairs, external wiring or connectors not supplied and authorized by SAMSUNG, or which damage this product or result in service problems; incorrect electrical line voltage, fluctuations and surges; customer adjustments and failure to follow operating instructions, cleaning, maintenance and environmental instructions that are covered and prescribed in the instruction book; product removal or reinstallation; reception problems and distortion related to noise, echo, interference or other signal transmission and delivery problems. SAMSUNG does not warrant uninterrupted or error-free operation of the product.

THERE ARE NO EXPRESS WARRANTIES OTHER THAN THOSE LISTED AND DESCRIBED ABOVE, AND NO WARRANTIES WHETHER EXPRESS OR IMPLIED, INCLUDING, BUT NOT LIMITED TO, ANY IMPLIED WARRANTIES OF MERCHANTABILITY OR FITNESS FOR A PARTICULAR PURPOSE, SHALL APPLY AFTER THE EXPRESS WARRANTY PERIODS STATED ABOVE, AND NO OTHER EXPRESS WARRANTY OR GUARANTY GIVEN BY ANY PERSON, FIRM OR CORPORATION WITH RESPECT TO THIS PRODUCT SHALL BE BINDING ON SAMSUNG. SAMSUNG SHALL NOT BE LIABLE FOR LOSS OF REVENUE OR PROFITS, FAILURE TO REALIZE SAVINGS OR OTHER BENEFITS, OR ANY OTHER SPECIAL, INCIDENTAL OR CONSEQUENTIAL DAMAGES CAUSED BY THE USE, MISUSE OR INABILITY TO USE THIS PRODUCT, REGARDLESS OF THE LEGAL THEORY ON WHICH THE CLAIM IS BASED, AND EVEN IF SAMSUNG HAS BEEN ADVISED OF THE POSSIBILITY OF SUCH DAMAGES. NOR SHALL RECOVERY OF ANY KIND AGAINST SAMSUNG BE GREATER IN AMOUNT THAN THE PURCHASE PRICE OF THE PRODUCT SOLD BY SAMSUNG AND CAUSING THE ALLEGED DAMAGE. WITHOUT LIMITING THE FOREGOING, PURCHASER ASSUMES ALL RISK AND LIABILITY FOR LOSS, DAMAGE OR INJURY TO PURCHASER AND PURCHASER'S PROPERTY AND TO OTHERS AND THEIR PROPERTY ARISING OUT OF THE USE, MISUSE OR INABILITY TO USE THIS PRODUCT SOLD BY SAMSUNG NOT CAUSED DIRECTLY BY THE NEGLIGENCE OF SAMSUNG. THIS LIMITED WARRANTY SHALL NOT EXTEND TO ANYONE OTHER THAN THE ORIGINAL PURCHASER OF THIS PRODUCT, IS NONTRANSFERABLE AND STATES YOUR EXCLUSIVE REMEDY.

Some states do not allow limitations on how long an implied warranty lasts, or the exclusion or limitation of incidental or consequential damages, so the above limitations or exclusions may not apply to you. This warranty gives you specific legal rights, and you may also have other rights which vary from state to state.

To obtain warranty hardware service, please contact SAMSUNG at:

Samsung Electronics America, Inc.
105 Challenger Road Ridgefield Park, NJ 07660-0511
1-800-SAMSUNG (726-7864) and www.samsung.com

Contact SAMSUNG WORLD WIDE

if you have any questions or comments relating to Samsung products, please contact the SAMSUNG customer care center.

Region	Country	Customer Care Center	Web Site
North America	CANADA	1-800-SAMSUNG (7267864)	www.samsung.com/ca
	MEXICO	01-800-SAMSUNG (7267864)	www.samsung.com/mx
	U.S.A	1-800-SAMSUNG (7267864)	www.samsung.com
Latin America	ARGENTINE	0800-333-3733	www.samsung.com/ar
	BRAZIL	0800-124-421 4004-0000	www.samsung.com/br
	CHILE	800-726-7864 (SAMSUNG)	www.samsung.com/cl
	COSTA RICA	0-800-507-7267	www.samsung.com/latin
	ECUADOR	1-800-10-7267	www.samsung.com/latin
	EL SALVADOR	800-6225	www.samsung.com/latin
	GUATEMALA	1-800-299-0013	www.samsung.com/latin
	JAMAICA	1-800-234-7267	www.samsung.com/latin
	PANAMA	800-7267	www.samsung.com/latin
	PUERTO RICO	1-800-682-3180	www.samsung.com/latin
	REP. DOMINICA	1-800-751-2676	www.samsung.com/latin
	TRINIDAD & TOBAGO	1-800-7267-864	www.samsung.com/latin
	VENEZUELA	0-800-100-5303	www.samsung.com/latin
	COLOMBIA	01-8000112112	www.samsung.com.co
Europe	BELGIUM	02 201 2418	www.samsung.com/be
	CZECH REPUBLIC	844 000 844 Distributor pro Českou republiku : Samsung Zrt., česká organizační složka Vyskočilova 4, 14000 Praha 4	www.samsung.com/cz
	DENMARK	38 322 887	www.samsung.com/dk
	FINLAND	09 693 79 554	www.samsung.com/fi
	FRANCE	3260 SAMSUNG or 08 25 08 65 65 (€ 0,15/Min)	www.samsung.com/fr
	GERMANY	01805 - 121213 (€ 0,14/Min)	www.samsung.de
	HUNGARY	06-80-SAMSUNG (7267864)	www.samsung.com/hu
	ITALIA	800-SAMSUNG (7267864)	www.samsung.com/it
	LUXEMBURG	0032 (0)2 201 24 18	www.samsung.lu
	NETHERLANDS	0900 20 200 88 (€ 0,10/Min)	www.samsung.com/nl
	NORWAY	231 627 22	www.samsung.com/no
	POLAND	0 801 801 881	www.samsung.com/pl
	PORTUGAL	80 8 200 128	www.samsung.com/pt
	SLOVAKIA	0800-SAMSUNG (726786)	www.samsung.com/sk
	SPAIN	902 10 11 30	www.samsung.com/es
	SWEDEN	08 585 367 87	www.samsung.com/se
	U.K	0870 SAMSUNG (7267864)	www.samsung.com/uk
Republic of Ireland	0818 717 100	www.samsung.com/uk	
Switzerland	0800-7267864	www.samsung.com/ch	
CIS	RUSSIA	8-800-200-0400	www.samsung.ru
	KAZAHSTAN	8-800-080-1188	www.samsung.kz
	UZBEKISTAN	8-800-120-0400	www.samsung.uz
	UKRAINE	8-800-502-0000	www.samsung.com/ur
	LITHUANIA	8-800-77777	www.samsung.lt
	LATVIA	800-7267	www.samsung.com/lv/index.htm
	ESTONIA	800-7267	www.samsung.ee
	AUSTRALIA	1300 362 603	www.samsung.com/au
	CHINA	800-810-5858, 010-6475 1880	www.samsung.com.cn
Asia Pacific	HONG KONG	3698 - 4698	www.samsung.com/hk
	INDIA	3030 8282 1800 110011	www.samsung.com/in
	INDONESIA	0800-112-8888	www.samsung.com/id
	JAPAN	0120-327-527	www.samsung.com/jp
	MALAYSIA	1800-88-9999	www.samsung.com/my
	PHILIPPINES	1800-10-SAMSUNG (7267864)	www.samsung.com/ph
	SINGAPORE	1800-SAMSUNG (7267864)	www.samsung.com/sg
	THAILAND	1800-29-3232 02-689-3232	www.samsung.com/th
	TAIWAN	0800-329-999	www.samsung.com/tw
	VIETNAM	1 800 588 889	www.samsung.com/vn
	Middle East & Africa	SOUTH AFRICA	0860 7267864 (SAMSUNG)
U.A.E		800SAMSUNG (7267864) 8000-4726	www.samsung.com/mea

THIS APPLIANCE IS MANUFACTURED BY:



If you have any questions or comments relating to Samsung products,
please contact the SAMSUNG customer care center.

Samsung Electronics America, Inc.
1-800-SAMSUNG (7267864)
www.samsung.com

Free Manuals Download Website

<http://myh66.com>

<http://usermanuals.us>

<http://www.somanuals.com>

<http://www.4manuals.cc>

<http://www.manual-lib.com>

<http://www.404manual.com>

<http://www.luxmanual.com>

<http://aubethermostatmanual.com>

Golf course search by state

<http://golfingnear.com>

Email search by domain

<http://emailbydomain.com>

Auto manuals search

<http://auto.somanuals.com>

TV manuals search

<http://tv.somanuals.com>