

Verizon Wireless Network Extender User Guide

Please read this manual before operating your device, and keep it for future reference.



SCS 26UC4



Download from Www.Somanuals.com. All Manuals Search And Download.

Verizon Wireless

N e t w o r k E x t e n d e r

User Manual

Please read this manual before operating your device, and keep it for future reference.



Intellectual Property

All Intellectual Property, as defined below, owned by or which is otherwise the property of Samsung or its respective suppliers relating to the SAMSUNG Device, including but not limited to, accessories, parts, or software relating there to (the “base station”), is proprietary to Samsung and protected under federal laws, state laws, and international treaty provisions. Intellectual Property includes, but is not limited to, inventions (patentable or unpatentable), patents, trade secrets, copyrights, software, computer programs, and related documentation and other works of authorship. You may not infringe or otherwise violate the rights secured by the Intellectual Property. Moreover, you agree that you will not (and will not attempt to) modify, prepare derivative works of, reverse engineer, decompile, disassemble, or otherwise attempt to create source code from the software. No title to or ownership in the Intellectual Property is transferred to you. All applicable rights of the Intellectual Property shall remain with SAMSUNG and its suppliers.

Samsung Telecommunications America (STA), LLC

Headquarters:	Customer Care Center:
1301 E. Lookout Drive	1000 Klein Rd.
Richardson, TX 75082	Plano, TX 75074
Toll Free Tel:	1.888.987.HELP (4357)

Internet Address: <http://www.samsungusa.com>

© 2008 Samsung Telecommunications America, Samsung LLC. Samsung is a registered trademark of Samsung Electronics America, Inc. and its related entities.

Do you have questions about your Samsung Device?

For 24 hour information and assistance, we offer a new FAQ/ARS System (Automated Response System) at:

www.samsungtelecom.com/support

EP68-00359A

Printed in Korea

Disclaimer of Warranties; Exclusion of Liability

For more information, refer to "*Warranty Information*" on page 25.

Table of Contents

Section 1: Getting Started2

Introduction	2
What's In the Box?	2
System Requirements	3
Quick Setup	3

Section 2: Using Your Device6

Additional Setup Information	6
Activating Your Verizon Wireless Network Extender	8
Getting Help	8
Verizon Wireless Network Extender Basics	9
Components - Front View	9
Components - Rear View	10
Features	12

Section 3: External GPS Antenna13

Antenna Installation	13
----------------------------	----

Section 4: Troubleshooting16

Section 5: Important Safety Information19

General Precautions	19
Using Your Base Station Near Other Electronic Devices	20
Radio Frequency (RF) Energy	20
Knowing Radio Frequency Safety	20
FCC Radio Frequency Emission	21
User Guide Proprietary Notice	24

Section 6: Warranty Information25

Standard Limited Warranty	25
---------------------------------	----

Index29

Section 1: Getting Started

Introduction

Congratulations on the purchase of your Verizon Wireless Network Extender.

Your purchase of this base station enhances the wireless telephone service that you and your family will receive while in your home or home office.

This User Guide introduces you to the Verizon Wireless Network Extender base station service and all the features of your new device. It includes the following sections:

- Getting Started
- Using Your Device
- External GPS Antenna
- Troubleshooting
- Important Safety Information
- Manufacturer's Warranty

Throughout this guide, you'll find tips and techniques that help you make the most of your new device and service.

It is important that you read each section and note any special requirements. However, if you'd like to get right to a specific feature, simply locate that section in the Table of Contents and go directly to that page. Follow the instructions in that section, and you'll be ready to use your base station in no time.

Note: Due to updates in software and procedure, this printed guide may not be the most current version for your base station. Visit www.verizonwireless.com/support to access the most recent version of this guide.

What's In the Box?

- Network Extender base station
- Ethernet Cable
- Power Supply and Power Cord
- External GPS and antenna cable
- User Guide
- Quick Start Guide

System Requirements

- An always-on broadband Internet connection with a minimum speed of 300 kbps.
- An available Ethernet port on either your broadband modem or a router connected to the modem.

Note: If you are connecting your Verizon Wireless Network Extender to a router, please ensure it supports Virtual Private Networking (VPN). Although most routers support this functionality, refer to your router's product documentation to confirm compatibility.

Quick Setup

Setting up service on your new Verizon Wireless Network Extender base station is fast and easy. This section outlines the procedures needed to quickly set up the base station.

1. Confirm your package contains all components.
2. Review the "Important Safety Information" on page 19 before installing the base station.
3. Make sure that both your router and your Internet broadband modem are functioning properly. Refer to your particular product's documentation for more information.

Note: A router with at least one free Ethernet port is required to connect the base station.

4. Place the base station near a window in a central location.
 - For best results, place the base station in an elevated location, such as the top of a bookshelf or tall cabinet.

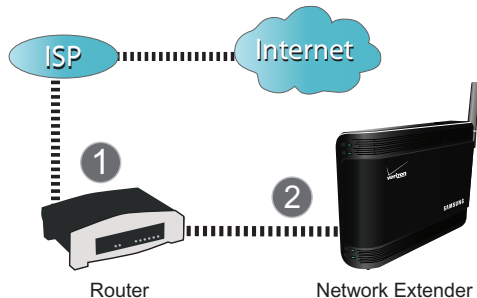

5. Connect one end of the included Ethernet cable to an open port on the router (1) and connect the other end to the WAN port located at the rear of the base station (2).

Note: Plug the Ethernet cable into the base station before connecting the power supply.

6. Plug the power supply connector into the DC 12V power port located at the rear of the base station (3).
7. Insert one end of the power cord into the power supply and then plug the other end into an available power outlet (4).

Warning! Insert the plug into the power outlet last. Failure to do so could cause an electrical short or power surge to the base station.

Note: The use of a surge protector is recommended for the Verizon Wireless Network Extender.

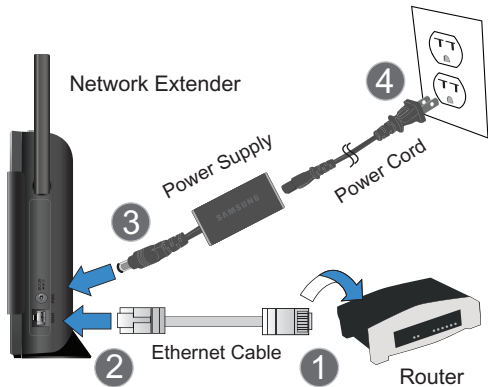

8. Confirm that the front LEDs are illuminated as indicated below:

- **Power LED:** should be a continuous blue light, indicating that the base station is receiving power. No illumination indicates there is an issue with the power supply or power connector.
- **System LED:** should be a continuous blue light, indicating that the base station is properly communicating with the Verizon Wireless network. Blinks red while establishing an initial network connection. Continuous red indicates an abnormal condition.
- **GPS LED:** should be a continuous blue light, indicating that the base station has locked onto a valid GPS signal. If the GPS LED is red, the internal antenna may not be able to detect a GPS signal, and installation of the external GPS antenna might be necessary.

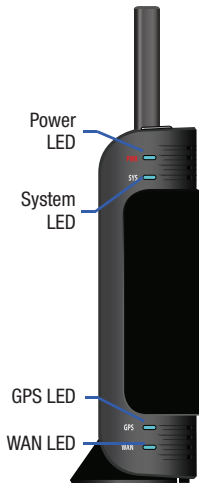

- **WAN LED:** should be a steady blue light, indicating that the base station has detected a valid Ethernet connection. A blinking blue LED indicates data communication.

Note: Allow 3 - 5 minutes for the base station to complete the startup sequence and detect both its connections and available communications. The first time the base station is used, it may take as long as one hour for the initial GPS acquisition. If the GPS LED is still red after one hour, relocate the GPS antenna to receive a stronger signal. See "Antenna Installation" on page 13.

Section 2: Using Your Device

Additional Setup Information

Getting started with your new Verizon Wireless Network Extender is easy. This section walks you through an overview of the product, package contents, activation, and how to contact Verizon Wireless for assistance with your service and your base station.

The Verizon Wireless Network Extender is used within your home or home office to extend your Verizon Wireless coverage area through an existing Internet broadband connection.

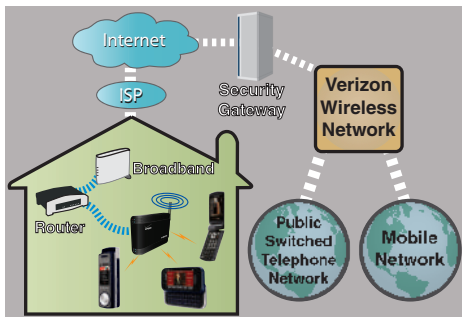

About the size of a traditional wireless access point (WAP), the base station facilitates the delivery of cellular traffic through the Internet to the Verizon Wireless network, which then routes the signal to the desired party.

- A maximum of three phones can connect to the Verizon Wireless Network Extender at any one time.
 - The first three callers to initiate or receive a call will connect to the base station. Additional users who make or receive a call, while all base station channels are in use, are redirected to the nearest compatible cell tower (if available).
 - As each caller ends a call, that channel then becomes available for another user to initiate (or receive) a new call.

Note: The base station can be managed to ensure Verizon Wireless phone numbers you authorize will always enjoy priority access to the Network Extender network. Up to 50 Verizon Wireless cell phones can be registered on a specific base station.

- Authorized account users can manage access settings for their Verizon Wireless Network Extender by logging into My Verizon at www.verizonwireless.com.
 - When the base station is set to managed access mode, unauthorized users are redirected to the nearest compatible cell tower wherever possible.

- If a handoff to the nearest compatible cell tower is not possible and all channels are not in use, one channel may be available for an unauthorized user to access. Callers on the managed access list are always given priority access to the Network Extender.
- Users can verify if they are on the Verizon Wireless Network Extender network by dialing #48 (and receiving an audio announcement).

Note: A fourth channel, open to all callers, is always reserved for emergency (E911) calls.

- You will hear a short double tone on your wireless phone when making or receiving a call while on the Network Extender network. The tone is played at the beginning of the call.
- In order to establish an initial connection to the Network Extender network, your Verizon Wireless mobile phone needs to move within close proximity of your Network Extender unit.
 - After connecting to the Network Extender network, you can move within a broader perimeter while remaining under Network Extender coverage. Refer to www.verizonwireless.com/support for additional details.
 - Both the coverage area required to establish an initial connection and the broader coverage area of the Network Extender cannot be guaranteed and may vary due to environmental factors; such as physical structures and the strength of the external cell tower coverage.

The table below outlines bandwidth requirements based on the number of active callers:

Simultaneous Callers	Download Speed Requirement	Upload Speed Requirement
1 caller	40 kbps	40 kbps
2 callers	80 kbps	80 kbps
3 callers	120 kbps	120 kbps

The base station maximizes wireless phone utility within a small area by not only providing better voice quality, but by also allowing you to use this new service without any enhancements to your existing Verizon Wireless mobile phones.

By utilizing a built-in GPS antenna, the base station is capable of maintaining exact network timing updates and providing E911 services with an accurate location.

- The current GPS location (provided by the internal antenna) is used to help the base station quickly locate GPS satellites for faster GPS acquisition.

- The external GPS antenna (provided with your Verizon Wireless Network Extender) allows you to place the Verizon Wireless Network Extender further from a window and run the antenna to an area with stronger GPS reception.

Warning! You may not be able to make 911 calls in the event of an electrical power outage, broadband connection failure, or other service disruption outside of the Verizon Wireless network coverage area. 911 services may be limited in areas outside of the Verizon Wireless network coverage area. Not all public safety answering points have location-based E911 technology. Always be prepared to report your location to the 911 operator when placing an emergency call. Mobile phones operate using radio signals which cannot guarantee connection in all conditions.

Activating Your Verizon Wireless Network Extender

Your base station should already be activated. If it is not activated, please call Verizon Wireless Customer Service at **(800) 922-0204** or ***611** from your Verizon Wireless mobile phone and select the option for technical support.

Note: The base station must be activated for use on the Verizon Wireless network before setup. It will not work unless it has been activated.

Should you need to activate your base station, you will be asked to provide the following information:

- Primary Wireless Phone Number or Verizon Wireless Account Number (located on your Verizon Wireless billing statement)
- Account Password
- MAC ID of the base station found on the sticker affixed to the device.

Getting Help

Note: In order to establish an initial connection to the Verizon Wireless Network Extender network, your mobile phone needs to move within a close proximity of your Network Extender unit. After connecting to the network, you can move within a broader perimeter while remaining under Network Extender coverage. Refer to www.verizonwireless.com/support for additional details.

Note: Both the coverage area required to establish an initial connection and the broader coverage area of the Network Extender cannot be guaranteed and may vary due to environmental factors; such as physical structures and the strength of external cell tower coverage.

Reaching Verizon Wireless Customer Service

You can reach Verizon Wireless Customer Service in a number of ways:

- Call us toll free at **(800) 922-0204** or ***611** from your Verizon Wireless mobile phone.
- Visit the support pages at www.verizonwireless.com/support.

Verizon Wireless Network Extender Basics

- Components (page 9)
- Features (page 12)
- Maintenance Notes (page 12)

Your base station is packed with features that expand your ability to stay connected to the people and information important to you. This section will guide you through the basic features and functions of your Verizon Wireless Network Extender base station.

Components - Front View

In addition to a wireless antenna, the base station has four LED lights that are used to indicate the device connectivity status.

- **Wireless Antenna** provides omnidirectional transmission and reception of signals between the base station and communicating Verizon Wireless mobile phones. The wireless antenna rotates 360 degrees.
- **Power LED (PWR)** indicates the power status.
- **System LED (SYS)** indicates the status of Network Extender connectivity to the Verizon Wireless network.
- **GPS LED** indicates the GPS connection status.

Note: If the unit's GPS signal strength is weak (due to location), it is recommended that you either move the base station near a window or install the external GPS antenna. For more details, see "External GPS Antenna" on page 13.

Note: GPS antenna receives signals from Global Positioning System satellites and uses them to obtain time and location information.

- **WAN LED** indicates the status of the Ethernet connection.

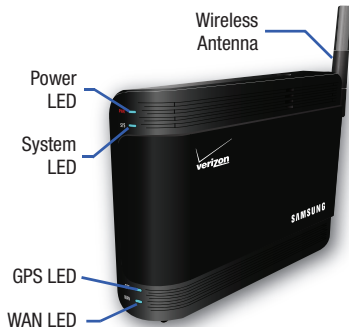

LED	Function	Description
PWR	Power	<ul style="list-style-type: none"> • Solid blue: normal • No light: abnormal
SYS	System connected	<ul style="list-style-type: none"> • Solid blue: normal • Solid red: abnormal
GPS	GPS signal	<ul style="list-style-type: none"> • Solid blue: normal (GPS is received) • Blinking blue or red: while searching for GPS • No light: abnormal (GPS signal cannot be received, the external GPS antenna is required)
WAN	WAN (Ethernet) connection	<ul style="list-style-type: none"> • Solid blue: normal • Blinking blue: data communication • No light: abnormal

Components - Rear View

The rear of the base station provides access to the WAN port, power port, and external GPS antenna.

1. **GPS Antenna Port** slides to provide access to the external GPS antenna for removal and relocation.
 - A red GPS LED indicates a GPS signal could not be detected using the internal GPS antenna. The external GPS antenna should be connected. See "External GPS Antenna" on page 13.
2. **Heat Vents** provide passive ventilation for the base station and allow for dissipation of internally generated heat.

Note: The base station needs to remain vertical and in a well-ventilated location. The vertical position allows proper air flow to the internal components.

3. **DC 12V Power Port** provides power to the base station when connected to the AC power supply and cord (included).

Warning! Only use the provided power cord and supply. Using any other power source may damage the base station.

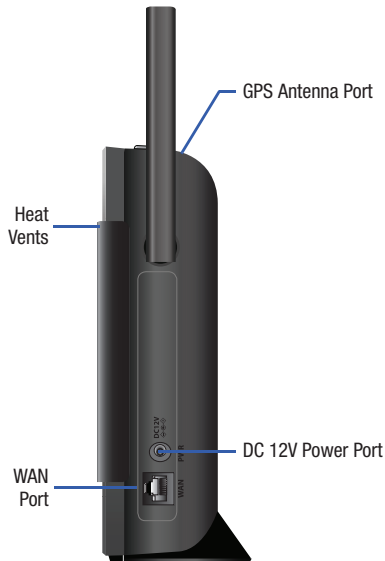

4. **WAN Port** allows you to connect the Ethernet cable provided to establish communication between the base station and your broadband router. This connection port is then used to transmit voice and data through the Internet to the Verizon Wireless network, which then authenticates the base station and allows communication with wireless phones.

- If the corresponding WAN LED does not illuminate, this indicates that although an Ethernet cable is connected, no communication is occurring through either your router or your ISP Internet connection (DSL, fiber optic, cable, etc.).
- Please make sure your broadband connection is active and functioning properly. Contact your Internet Service Provider if the problem persists.

Features

The following list highlights some of the base station's features:

- The base station enables users to easily install and configure the system by connecting to an existing broadband network.
- To prevent unauthorized users from accessing the base station and diminishing your available bandwidth, you have the option to restrict the use of your Network Extender by logging into My Verizon at www.verizonwireless.com.
- The base station is a Plug & Play device that can be installed to automatically provide enhanced wireless telephone service in a home or small office without having to change your existing mobile phone.
- The base station utilizes a GPS receiver to get both timing and unit location information. In case of a weak GPS signal, install the external GPS antenna and locate it near a window to receive a stronger signal.

Note: Certain Verizon Wireless services are not compatible with the Network Extender, refer to www.verizonwireless.com/support for details.

Maintenance Notes

These notes should be carefully reviewed before using the base station:

- See “General Precautions” on page 19.
- Only connect the base station's power plug to a 110–125 VAC outlet.

Note: The use of a surge protector is recommended.

- When cleaning the Network Extender, first unplug the connector from the power outlet. Do not clean the base station using chemical solvents or detergents, but with an anti-static cleaning pad.
- If the Verizon Wireless Network Extender is connected to a Wi-Fi router, ensure that the unit is placed at least 2 feet away from the router (to avoid interference).
- Do not obstruct the heat vents by blocking the openings or covering the base station.
- Remove the base station's power connector from the power outlet if the base station will not be used for an extended period of time.

Section 3: External GPS Antenna

If your Verizon Wireless Network Extender cannot receive a Global Positioning System (GPS) signal, it may be necessary to improve the reception by installing and then positioning the external GPS antenna. This section outlines the installation and relocation of this GPS antenna.

Antenna Installation

In some cases, you may find that because of its current location, the base station's GPS antenna may not be able to properly receive an active GPS signal. If a stable GPS signal is not detected, as indicated by the red GPS LED, you will need to install the GPS antenna cable as explained in this section.

Without a valid GPS signal, the base station cannot function properly, and calls will be redirected to the nearest compatible cell tower.

Warning: Use only the GPS antenna supplied with your Verizon Wireless Network Extender.

When positioning the GPS antenna, ensure that it is:

- Installed in a horizontal position.
- Adjacent to a window and in an open area. This ensures clear reception of the GPS signal.

Note: GPS signal strength is greatly reduced when passing through walls or other hard surfaces.

To connect the GPS antenna to the Network Extender base station, follow these steps:

1. Turn off the base station.
2. Rotate the antenna down to provide access to the GPS antenna's protective cover.

Note: The GPS antenna receives signals from Global Positioning System satellites and uses them to obtain time and location information.

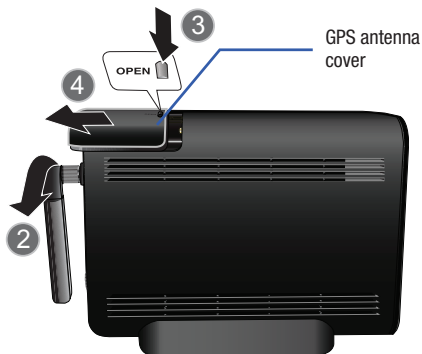

3. Firmly press down on the Open groove (top of station).
4. Slide the protective cover back to expose the rectangular GPS antenna.
5. Use a blunt tool (such as a coin) to carefully pry the GPS antenna away from the base station, in the same direction as shown in step 4.
6. Remove the GPS antenna from its compartment.

7. Connect and secure the GPS antenna to the end of the provided GPS cable labeled "Connect to GPS Antenna."
8. Connect and secure the terminal end of the same mini-coax cable to the port on the base station (within the GPS antenna compartment).

Warning! Do not force the connector into the GPS antenna port as this can damage the connector.

9. Replace the cover on the station. Verify the cable is threaded through the opening on the cover.

Tip: Place the antenna near a window where the GPS signal is strongest.

Warning! Do not use duct tape to secure the GPS antenna to its new location.

Tip: You can use double-sided tape to secure the bottom of the GPS antenna to its new location.

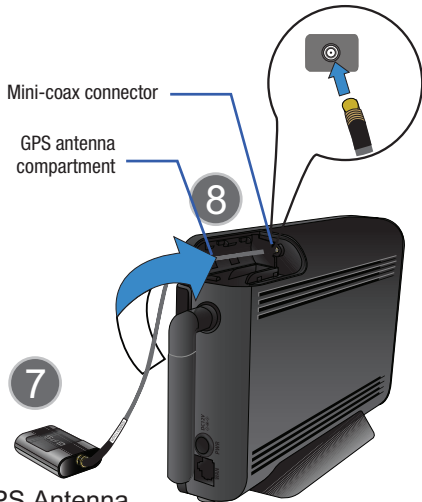

Note: If a GPS signal cannot be detected, remove the GPS antenna and place it in a new location to receive a stronger signal. This new location should be located close to a window.

10. Power on the base station to allow the detection of both the external antenna connection and an available GPS signal.

Section 4: Troubleshooting

Now that you've been given an overview of the Verizon Wireless Network Extender base station, some situations might arise where you'll need additional usage or connection help. This section provides some base station troubleshooting tips and techniques.

For more information, please visit us online at www.verizonwireless.com/support.

- **My Power LED is not Illuminating.**

- Make sure that one end of the power cord is securely connected to an active outlet and that the other end is properly connected to the power supply.
- Make sure the power connector is securely inserted into the rear DC 12V port on the back of the base station.

- **My GPS LED is not illuminating blue even after a few minutes.**

Note: The first time the base station is used after installation or after relocation, it can take up to one hour to acquire a GPS connection.

- The GPS antenna cannot obtain a signal.
- If possible, move the base station to a location with fewer surrounding obstructions. The new location should be in an open area and closer to a window, if possible.

- If the preceding fails, remove the power cord from the wall outlet for at least 10 seconds.
- Reconnect the power connector to the DC 12V port and plug the power cord into the wall outlet. This allows the base station to re-initiate its startup sequence where it detects the Ethernet connection, GPS signal, and communication with the Verizon Wireless network.
- If relocation does not produce a GPS signal, uninstall the GPS antenna from the base station and relocate it to receive a stronger signal.

- **My WAN LED is blue but I cannot place a call via my Verizon Wireless Network Extender.**

- Check that the router is communicating properly with your ISP. The Internet activity LED on your router should be blinking. For further router troubleshooting tips, please review the router manufacturer's printed or online documentation.

- **My System LED is solid red.**

- A red System LED indicates a system error was detected and is symptomatic of a communication problem with the Verizon Wireless network.
- Confirm your base station was activated at time of purchase. If your base station has not already been activated, call Verizon Wireless Customer Service at (800) 922-0204 or *611 from your Verizon Wireless mobile phone and select the option for technical support.
- Before contacting the Verizon Wireless Customer Service Center, confirm the following:
 - Is your WAN LED illuminating blue?
 - If it is not, then there may be a communication problem between your base station and the router.
 - If the WAN LED is illuminating blue, then check that the router is communicating properly with your ISP. The Internet activity LED on your router should be blinking. For further router troubleshooting tips, please review either the router manufacturer's printed or online documentation.
 - Is the GPS LED illuminating blue? If it is not, the base station might not be receiving a GPS signal. Inability to receive a GPS signal can result in the base station failing to validate your account information and network timing, which then prevents usage and reroutes you back to the nearest compatible cell tower. If this is the problem, install the external GPS antenna. See "External GPS Antenna" on page 13.

- **The Network Extender base station seems to be getting too hot.**

- Make sure there is nothing blocking the heat vents located along the side of the base station.
- It is recommended that the Network Extender be located in a well-ventilated open area at least 12 inches from any surrounding hot surfaces. It is not recommended that the base station be installed in a cabinet or other enclosed location.

- **How can I manage access to my base station?**

- You have the option to manage priority access settings for your Network Extender to specified numbers by logging into My Verizon at www.verizonwireless.com. A maximum of 50 authorized Verizon Wireless callers can be registered.
- When the base station is set to open access, the first three callers detected within the base station's area are given access to place or receive calls through the base station. Your Verizon Wireless Network Extender is set to open access by default.
- Anyone else who then initiates a call while all base station channels are occupied is redirected to the nearest compatible cell tower when available.
- When unauthorized callers (callers not on your managed access list) within range of the base station attempt to place a call, they are automatically redirected to the nearest compatible cell tower.
- If a handoff to the nearest compatible cell tower is not possible and all channels are not in use, one channel may be available for an

unauthorized user to access. Callers on the managed access list are always given priority access to the Network Extender.

Note: Both authorized and unauthorized callers may see more service bars on their Verizon Wireless handset due to their proximity to the Verizon Wireless Network Extender.

Note: A fourth channel is always reserved for emergency (E911) calls to any user within range of the Network Extender.

Section 5: Important Safety Information

This user guide contains important operational and safety information that will help you safely use your base station.

General Precautions

There are several simple guidelines to operating your base station properly and maintaining safe, satisfactory service.

- Avoid exposing your base station to rain or liquid spills. If your base station does get wet, immediately turn the power off and remove the power connector.
- Do not operate the base station in an extremely dusty or humid environment.
- Avoid placing the base station near radiators or other heating sources.
- Do not obstruct the heat vents by blocking the openings or covering the base station, and do not operate it in a confined space.
- Avoid locating the base station where it could be exposed to direct sunlight for prolonged periods.
- Do not connect the base station to a power strip containing an excessive number of other devices. Refer to the documentation that came with your power strip for capacity information.
- Do not disassemble the wireless antenna.

- Do not attempt to open the base station or power supply, or disassemble either component, or remove the wireless antenna. You run the risk of electrical shock and/or burn and voiding the limited warranty. No user-serviceable parts are located within the base station enclosure.
- If the base station will not be used for a prolonged period, remove the power cord from the AC outlet.
- Although your base station is quite sturdy, it is a complex piece of equipment and can be broken. Avoid dropping, hitting, bending, or sitting on it.
- Any changes or modifications to your base station not expressly approved in this document could void your warranty for this equipment and void your authority to operate this equipment.

Warning: You may not be able to make 911 calls in the event of an electrical power outage, broadband connection failure, or other service disruption. 911 services may be limited in areas outside of the Verizon Wireless network. Not all public safety answering points have location-based E911 technology. Always be prepared to report your location to the 911 operator when placing an emergency call. Mobile phones operate using radio signals which cannot guarantee connection in all conditions.

Using Your Base Station Near Other Electronic Devices

Most modern electronic equipment is shielded from radio frequency (RF) signals. However, RF signals from your base station may affect inadequately shielded electronic equipment.

Conversely, ensure the unit is placed at least 2 feet away from products which generate electromagnetic radiation, such as a computer monitor or microwave oven.

Note: For the best care of your base station, ensure that only authorized personnel service your device. Failure to do so may be dangerous and void your warranty. Consult the manufacturer of any personal medical devices, such as pacemakers and hearing aids, to determine if they are adequately shielded from external RF signals.

Radio Frequency (RF) Energy

Understanding How Your Base Station Operates

Your base station functions as a radio transmitter and receiver. When it is turned on, it receives and transmits radio frequency (RF) signals. When you use your base station, the system handling your call controls the power level. This power can range from 1 microwatt to 50 milliwatts.

Knowing Radio Frequency Safety

The design of your base station complies with updated NCRP standards described below:

In 1991–92, the Institute of Electrical and Electronics Engineers (IEEE) and the American National Standards Institute (ANSI) joined in updating ANSI's 1982 standard for safety levels with respect to human exposure to RF signals. More than 120 scientists, engineers and physicians from universities, government health agencies and industries developed this updated standard after reviewing the available body of research.

In 1993, the Federal Communications Commission (FCC) adopted this updated standard in a regulation. In August 1996, the FCC adopted a hybrid standard consisting of the existing ANSI/IEEE standard and the guidelines published by the National Council of Radiation Protection and Measurements (NCRP).

For more information about RF exposure, visit the FCC Web site at www.fcc.gov.

FCC Radio Frequency Emission

This device meets the FCC Radio Frequency Emission Guidelines.
FCC ID number: A3LSCS-26UC4.

FCC Statement

This product has been tested and complies with the specifications for a Class B digital device, pursuant to Part 15 of the FCC Rules. These limits are designed to provide reasonable protection against harmful interference in a residential installation. This equipment generates, uses, and can radiate radio frequency energy and, if not installed and used according to the instructions, may cause harmful interference to radio communications. However, there is no guarantee that interference will not occur in a particular installation. If this equipment does cause harmful interference to radio or television reception, which is found by turning the equipment off and on, the user is encouraged to try to correct the interference by one or more of the following measures:

- Reorient or relocate the receiving antenna.
- Increase the separation between the equipment and receiver.
- Connect the equipment into an outlet on a circuit different from that to which the receiver is connected.
- Consult the dealer or an experienced radio/TV technician for help.

This device complies with Part 15 of the FCC Rules. Operation is subject to the following two conditions: (1) This device may not cause harmful interference, and (2) This device must accept any interference received, including interference that may cause undesired operation.

FCC Caution: Any changes or modifications not expressly approved by the party responsible for compliance could void the user's authority to operate this equipment.

Important Note.

FCC Radiation Exposure Statement

To ensure the safety of users, the FCC has established criteria for the amount of radio frequency energy various products may produce depending on their intended usage. This product has been tested and found to comply with the FCC's exposure criteria.

This transmitter must not be co-located or operating in conjunction with any other antenna or transmitter.

The installation of the base unit should allow at least 20 centimeters between the base and persons to be in compliance with FCC RF exposure guidelines.

Please read the following important safety notices and instructions before installing or using the product.

- A DANGER warning refers to situations that could cause bodily injury.
 - A CAUTION warning refers to situations that could result in equipment malfunction or damage.
1. Follow all warnings and instructions marked on the product.
 2. Unplug this product from the wall outlet before cleaning. Do not use liquid cleaners or aerosol cleaners. Use an anti-static cleaning pad for cleaning.
 3. Do not use this product near water.
 4. Do not place this product on an unstable cart, stand or table. If the product falls, it could be seriously damaged.
 5. This product should be operated using the type of power indicated on the marking label. If you are not sure of the type of power available, consult your dealer or local power company.
 6. Do not allow anything to rest on the power cord. Do not locate this product where people will walk on the cord.

7. Never push objects of any kind into this product through cabinet slots as they may touch dangerous voltage points or short-out parts that could result in a fire or electric shock.
8. Never spill liquid of any kind into or onto the product.
9. Do not attempt to service this product yourself, as opening or removing covers may expose you to dangerous voltage points or other risks.
10. Refer all questions regarding servicing of this product to qualified service personnel.

Danger—Electric Shock and Fire

Electric current from power, telephone, and communication cables is hazardous, and could result in electric shock and/or fire.

To avoid electric shock, use caution when connecting cables. For example, do not connect safety extra-low voltage (SELV) circuits to telephone-network voltage (TNV) circuits. LAN ports contain SELV circuits, and WAN ports contain TNV circuits. Some LAN and WAN ports both use RJ-45 connectors.

To avoid electric shock, do not operate the product or connect or disconnect cables during electrical storms. To avoid electric shock, do not use this product in or near water.

To reduce the risk of fire or overheating, keep this product in well ventilated areas, away from radiators or other heat sources. Do not block cooling vents.

The plug-socket combination must be accessible at all times because it serves as the main power-disconnecting device.

Use only the manufacturer-provided AC adaptor approved for use with this product. Use of another AC adaptor may cause a fire or explosion.

This product relies on short-circuit (overcurrent) protection installed in your home or office. Ensure that a fuse or circuit breaker no larger than 120 VAC, 15A U.S. is used on the phase conductors (all current carrying conductors).

Unplug this product from the wall outlet and refer servicing to qualified service personnel under the following conditions:

- a. When the power cord or plug is damaged or frayed.
- b. If liquid has been spilled into the product.
- c. If the product has been exposed to rain or water.

- d. If the product does not operate normally when the operating instructions are followed. Adjust only those controls that are covered by the operating instructions, since improper adjustment of other controls may result in damage and will often require extensive work by a qualified technician to restore the product to normal condition.

Caution—Electromagnetic Interference

This product generates, uses, and can radiate radio frequency energy and, if not installed or used in accordance with the manufacturer's instruction manual, may cause interference with radio and television reception. This product has been tested and found to comply with the limits set forth in Part 15 of the Federal Communications Commission Rules.

Owner's Record

The model name, model number, regulatory number, and FCC ID are located on a label affixed to the bottom of the unit. The MSN and MAC ID are on a sticker affixed on the side of the unit. Record the MSN and the MAC ID in the space provided below. This will be helpful if you need to contact us about your base station in the future.

Model: Verizon Wireless Network Extender

MSN:

MAC ID:

User Guide Proprietary Notice

CDMA Technology is licensed by QUALCOMM Incorporated under one or more of the following patents:

4,901,307 5,109,390 5,267,262 5,416,797

5,506,865 5,544,196 5,657,420 5,101,501

5,267,261 5,414,796 5,504,773 5,535,239

5,600,754 5,778,338 5,228,054 5,337,338

5,710,784 5,056,109 5,568,483 5,659,569

5,490,165 5,511,073

Section 6: Warranty Information

Your Verizon Wireless Network Extender has been designed to provide reliable, worry-free service. If for any reason you have a problem with your equipment, please refer to the manufacturer's warranty in this section. For information regarding the terms and conditions of service for your base station, please visit www.verizonwireless.com or call Verizon Wireless Customer Service at (800) 922-0204 or *611 from your Verizon Wireless mobile phone.

Standard Limited Warranty

What is Covered and For How Long?

SAMSUNG TELECOMMUNICATIONS AMERICA, LLC ("SAMSUNG") warrants to the original purchaser ("Purchaser") that SAMSUNG's base station and accessories ("Products") included in this package are free from defects in material and workmanship under normal use and service for the period commencing upon the date of purchase and continuing for the following specified period of time after that date:

All components carry a one-year warranty.

What is Not Covered? This Limited Warranty is conditioned upon proper use of Product by Purchaser. This Limited Warranty does not cover: (a) defects or damage resulting from accident, misuse, abuse, neglect, unusual physical, electrical or electromechanical stress, or modification of any part of Product, including antenna, or cosmetic damage; (b) equipment that has the serial number removed or made illegible; (c) any plastic surfaces or other externally exposed parts that are scratched or damaged due to normal use; (d) malfunctions resulting from the use of Product in conjunction with accessories, products, or ancillary/peripheral equipment not furnished or approved by SAMSUNG; (e) defects or damage from improper testing, operation, maintenance, installation, or adjustment; (f) installation, maintenance, and service of Product, or (g) Product used or purchased outside the United States or Canada.

What are SAMSUNG's Obligations? During the applicable warranty period, SAMSUNG will repair or replace, at SAMSUNG's sole option, without charge to Purchaser, any defective component part of Product. To obtain service under this Limited Warranty, Purchaser must return Product to an authorized service facility in an adequate container for shipping, accompanied by Purchaser's sales receipt or comparable substitute proof of sale showing the date of purchase, the serial number of Product and the sellers'

name and address. To obtain assistance on where to deliver the Product, call Samsung Customer Care at 1-888-987-4357. Upon receipt, SAMSUNG will promptly repair or replace the defective Product.

SAMSUNG may, at SAMSUNG's sole option, use rebuilt, reconditioned, or new parts or components when repairing any Product or replace Product with a rebuilt, reconditioned or new Product. All other repaired/replaced Product will be warranted for a period equal to the remainder of the original Limited Warranty on the original Product or for 90 days, whichever is longer. All replaced parts, components, boards and equipment shall become the property of SAMSUNG. If SAMSUNG determines that any Product is not covered by this Limited Warranty, Purchaser must pay all parts, shipping, and labor charges for the repair or return of such Product.

WHAT ARE THE LIMITS ON SAMSUNG'S WARRANTY/LIABILITY?

EXCEPT AS SET FORTH IN THE EXPRESS WARRANTY CONTAINED HEREIN, PURCHASER TAKES THE PRODUCT "AS IS," AND SAMSUNG MAKES NO WARRANTY OR REPRESENTATION AND THERE ARE NO CONDITIONS, EXPRESS OR IMPLIED, STATUTORY OR OTHERWISE, OF ANY KIND WHATSOEVER WITH RESPECT TO THE PRODUCT, INCLUDING BUT NOT LIMITED TO:

"THE MERCHANTABILITY OF THE PRODUCT OR ITS FITNESS FOR ANY PARTICULAR PURPOSE OR USE;

"WARRANTIES OF TITLE OR NON-INFRINGEMENT;

"DESIGN, CONDITION, QUALITY, OR PERFORMANCE OF THE PRODUCT;

"THE WORKMANSHIP OF THE PRODUCT OR THE COMPONENTS CONTAINED THEREIN; OR

"COMPLIANCE OF THE PRODUCT WITH THE REQUIREMENTS OF ANY LAW, RULE, SPECIFICATION OR CONTRACT PERTAINING THERETO.

ALL IMPLIED WARRANTIES AND CONDITIONS THAT MAY ARISE BY OPERATION OF LAW, INCLUDING IF APPLICABLE THE IMPLIED WARRANTIES OF MERCHANTABILITY AND FITNESS FOR A PARTICULAR PURPOSE, ARE HEREBY LIMITED TO THE SAME DURATION OF TIME AS THE EXPRESS WRITTEN WARRANTY STATED HEREIN. SOME STATES/PROVINCES DO NOT ALLOW LIMITATIONS ON HOW LONG AN IMPLIED WARRANTY LASTS, SO THE ABOVE LIMITATION MAY NOT APPLY TO YOU. IN ADDITION, SAMSUNG SHALL NOT BE LIABLE FOR ANY DAMAGES OF ANY KIND RESULTING FROM THE PURCHASE, USE, OR MISUSE OF, OR INABILITY TO USE THE PRODUCT OR ARISING DIRECTLY OR INDIRECTLY FROM THE USE OR LOSS OF USE OF THE PRODUCT OR FROM THE BREACH OF THE EXPRESS WARRANTY, INCLUDING INCIDENTAL, SPECIAL, CONSEQUENTIAL OR SIMILAR DAMAGES, OR LOSS OF ANTICIPATED PROFITS OR BENEFITS, OR FOR DAMAGES ARISING FROM ANY TORT (INCLUDING NEGLIGENCE

OR GROSS NEGLIGENCE) OR FAULT COMMITTED BY SAMSUNG, ITS AGENTS OR EMPLOYEES, OR FOR ANY BREACH OF CONTRACT OR FOR ANY CLAIM BROUGHT AGAINST PURCHASER BY ANY OTHER PARTY. SOME STATES/PROVINCES DO NOT ALLOW THE EXCLUSION OR LIMITATION OF INCIDENTAL OR CONSEQUENTIAL DAMAGES, SO THE ABOVE LIMITATION OR EXCLUSION MAY NOT APPLY TO YOU. THIS WARRANTY GIVES YOU SPECIFIC LEGAL RIGHTS, AND YOU MAY ALSO HAVE OTHER RIGHTS, WHICH VARY FROM STATE TO STATE/PROVINCE TO PROVINCE. THIS LIMITED WARRANTY SHALL NOT EXTEND TO ANYONE OTHER THAN THE ORIGINAL PURCHASER OF THIS PRODUCT AND STATES PURCHASER'S EXCLUSIVE REMEDY. IF ANY PORTION OF THIS LIMITED WARRANTY IS HELD ILLEGAL OR UNENFORCEABLE BY REASON OF ANY LAW, SUCH PARTIAL ILLEGALITY OR UNENFORCEABILITY SHALL NOT AFFECT THE ENFORCEABILITY FOR THE REMAINDER OF THIS LIMITED WARRANTY WHICH PURCHASER ACKNOWLEDGES IS AND WILL ALWAYS BE CONSTRUED TO BE LIMITED BY ITS TERMS OR AS LIMITED AS THE LAW PERMITS. THE PARTIES UNDERSTAND THAT THE PURCHASER MAY USE THIRD-PARTY SOFTWARE OR EQUIPMENT IN CONJUNCTION WITH THE PRODUCT. SAMSUNG MAKES NO WARRANTIES OR REPRESENTATIONS AND THERE ARE NO CONDITIONS, EXPRESS OR IMPLIED, STATUTORY OR OTHERWISE, AS TO THE QUALITY, CAPABILITIES, OPERATIONS, PERFORMANCE OR SUITABILITY OF ANY THIRD-PARTY

SOFTWARE OR EQUIPMENT, WHETHER SUCH THIRD-PARTY SOFTWARE OR EQUIPMENT IS INCLUDED WITH THE PRODUCT DISTRIBUTED BY SAMSUNG OR OTHERWISE, INCLUDING THE ABILITY TO INTEGRATE ANY SUCH SOFTWARE OR EQUIPMENT WITH THE PRODUCT. THE QUALITY, CAPABILITIES, OPERATIONS, PERFORMANCE AND SUITABILITY OF ANY SUCH THIRD-PARTY SOFTWARE OR EQUIPMENT LIE SOLELY WITH THE PURCHASER AND THE DIRECT VENDOR, OWNER OR SUPPLIER OF SUCH THIRD-PARTY SOFTWARE OR EQUIPMENT, AS THE CASE MAY BE.

This Limited Warranty allocates risk of Product failure between Purchaser and SAMSUNG, and SAMSUNG's Product pricing reflects this allocation of risk and the limitations of liability contained in this Limited Warranty. The agents, employees, distributors, and dealers of SAMSUNG are not authorized to make modifications to this Limited Warranty, or make additional warranties binding on SAMSUNG.

Accordingly, additional statements such as dealer advertising or presentation, whether oral or written, do not constitute warranties by SAMSUNG and should not be relied upon.

Customer Care Center:

1000 Klein Rd.

Plano, TX 75074

Toll Free Tel: 1.888.987.HELP (4357)

Samsung Telecommunications America, LLC:

1301 East Lookout Drive

Richardson, Texas 75082

Phone: 1-800-SAMSUNG (726-7864)

Important! If you are using a handset other than a standard numeric keypad,
dial the numbers listed in brackets.

Phone: 1-888-987-HELP (4357)

©2008 Samsung Telecommunications America. All rights reserved.

No reproduction in whole or in part allowed without prior written approval. Specifications and availability subject to change without notice.

©2009 Verizon Wireless. All rights reserved. Verizon Wireless is a trademark of Verizon Trademark Services LLC.

Some software components of this product incorporate source code covered under GNU General Public License (GPL), GNU Lesser General Public License (LGPL), OpenSSL License, BSD License and other open source licenses. To obtain the source code covered under the open source licenses, please visit:

<http://www.samsungnetwork.com/Home/opensource> .

Index

- A**
- Activation** 8
- Antenna** 13
- C**
- Components**
 - Front View 9
 - Rear View 10
- E**
- E911** 7
- G**
- Getting Started** 2
 - Activating Your Device 3
- GPS Antenna**
 - Installation 13
 - Mini-coax Connector 14
 - Port 14
- H**
- Heat Vents** 10
- L**
- LED**
 - GPS 9
 - Power 9
 - System 9
 - WAN 9
- M**
- Maintenance Notes** 12
- N**
- Network Extender**
 - Basics 9
 - Features 12
 - Front View 9
 - Rear View 10
- P**
- Port**
 - DC 12V Power 10
 - GPS Antenna 10
 - WAN 11
- S**
- Standard Limited Warranty**
 - 25
- U**
- Understanding Your Device** 6
- W**
- Warranty Information** 25

Free Manuals Download Website

<http://myh66.com>

<http://usermanuals.us>

<http://www.somanuals.com>

<http://www.4manuals.cc>

<http://www.manual-lib.com>

<http://www.404manual.com>

<http://www.luxmanual.com>

<http://aubethermostatmanual.com>

Golf course search by state

<http://golfingnear.com>

Email search by domain

<http://emailbydomain.com>

Auto manuals search

<http://auto.somanuals.com>

TV manuals search

<http://tv.somanuals.com>