



Built-in Depth
Side by Side Refrigerator



ENGLISH

OWNER'S MANUAL AND INSTALLATION



Register your product at www.samsung.com/global/register

DA68-01453B REV(0.1)



OWNER'S MANUAL AND INSTALLATION

- Before operating the appliance, please read this manual thoroughly and retain for your reference.
- Because these following operating instructions cover various models, the characteristics of your refrigerator may differ slightly from those described in this manual.

CONTENTS

SAFETY INSTRUCTIONS	2
OPERATING INSTRUCTIONS	
SETTING UP THE REFRIGERATOR	5
MAJOR FEATURES.....	5
CONTROL PANEL	6
TEMPERATURE CONTROL	7
DIGITAL PANEL	8
ICE AND COLD WATER DISPENSER	9
SHELVES AND BINS	10
FOOD STORAGE GUIDE	11
CoolSelect Zone™ Drawer GUIDE(OPTIONAL).....	13
REMOVING FREEZER ACCESSORIES.....	15
REMOVING REFRIGERATOR ACCESSORIES.....	15
BEVERAGE STATION™	15
CLEANING ACCESSORIES.....	16
CHANGING THE INTERIOR LIGHT.....	17
WATER FILTER.....	18
DOORS.....	18
INSTALLATION INSTRUCTIONS	
INSTALLATION OF THE REFRIGERATOR	19
REMOVING THE FRONT LEG COVER	20
REMOVING THE REFRIGERATOR DOORS	21
REATTACHING THE REFRIGERATOR DOORS.....	23
ADJUSTING THE CLEARANCE BETWEEN THE DOORS.....	26
CHECKING THE WATER DISPENSER LINE	28
INSTALLING THE WATER DISPENSER LINE.....	29
BEFORE YOU CALL FOR SERVICE.....	32

SAFETY INSTRUCTIONS

IMPORTANT SAFETY INFORMATION. READ ALL INSTRUCTIONS BEFORE USING.



WARNING

- Use this appliance only for its intended purpose as described in this Owner's Manual. We strongly recommend that any servicing be performed by a qualified individual.

SAFETY PRECAUTIONS

- When using electrical appliances, basic safety precautions should be followed, including the following:

CAUTION/WARNING SYMBOLS USED

 WARNING	Indicates that a danger of death or serious injury exists.
 CAUTION	Indicates that a risk of personal injury or material damage exists.

OTHER SYMBOLS USED

	Represents something you must NOT.
	Represents something you must NOT disassemble.
	Represents something you must NOT touch.
	Represents something you must follow.
	Indicates that you must disconnect the power plug from the socket.
	Represents a ground is needed to prevent electric shock.
	It is recommended that this symbol be handled by service man.

- This refrigerator must be properly installed and located in accordance with the Installation Instructions before it is used.
- ⊘ Do not install the refrigerator in a damp place or a place where it may come in contact with water.
 - Deteriorated insulation of electrical parts may cause an electric shock or fire.
- Do not allow children to climb, stand or hang on the shelves or doors in the refrigerator. They could damage the refrigerator and seriously injure themselves.
- ⊘ The appliance is not intended for use by children or infirm persons without supervision. Children should be supervised to ensure that they do not play with the appliance.
- ⊘ If the refrigerator is not to be used for a long period of time, pull out the power plug.
- The incorporated ice-makers are to be installed only by the manufacturer or its service agent. Use only the ice-maker provided with the refrigerator. The water supply to this refrigerator must only be installed/connected by a suitably qualified person and connect to a potable water supply only.

Do not disassemble or repair the refrigerator by yourself. You run the risk of causing a fire, malfunctions and/or personal injury.

The appliance must be positioned so that the plug is accessible after installation.

Do not place this refrigerator in direct sunlight or expose to the heat from stoves, room heaters or other appliance.

If you smell pharmaceutical or smoke, pull out the power plug immediately and contact your Samsung Electronics service center.

R600a or R134a is used as a refrigerant. Check the Compressor label on the rear of the appliance and the rating label inside the fridge to see which refrigerant is used for your refrigerator.



This appliance contains a small amount of isobutane refrigerant (R600a), a natural gas with high environmental compatibility that is, however, also combustible. When transporting and installing the appliance, care should be taken to ensure that no parts of the refrigerating circuit are damaged.

Refrigerant squirting out of the pipes could ignite or cause an eye injury. If a leak is detected, avoid any naked flames or potential sources of ignition and air the room in which the appliance is standing for several minutes.

- In order to avoid the creation of a flammable gas-air mixture if a leak in the refrigerating circuit occurs, the size of the room in which the appliance may be sited depends on the amount of refrigerant used. The room must be 1m³ in size for every 8 g of R600a refrigerant inside the appliance. The amount of refrigerant in your particular appliance is shown on the identification plate inside the appliance.
- Never start up an appliance showing any signs of damage. If in doubt, consult your dealer.

SAFETY INSTRUCTIONS



WARNING

DANGER! RISK OF CHILD ENTRAPMENT

- Child entrapment and suffocation are not problems of the past. Junked or abandoned refrigerators are still dangerous...even if they will sit for "just a few days."
Do so in a way, that it is not possible for a child to remain trapped inside.
- If you are getting rid of your old refrigerator, please follow the instructions below to help prevent accidents.
Keep fingers out of the "pinch point" areas; Clearances between the doors and cabinet are necessarily small. Be careful while closing the doors when children are in the area.

PROPER DISPOSAL OF THE REFRIGERATOR

Before you throw away your old refrigerator or freezer

- When disposing of this or other refrigerators, remove the door/door seals, door latch so that small children or animals cannot get trapped inside.
- Leave the shelves in place so that children may not easily climb inside.
R600a or R134a is used as a refrigerant.
- Check the compressor label on the rear of the appliance or the rating label inside the fridge to see which refrigerant is used for your refrigerator. when this product contains flammable gas (Refrigerant R600a) contact your local authority in regard to safe disposal of this product.
- CycloPentane used as a insulation blowing gas.
The gases in the insulation material require special disposal procedure. Please dispose of the packaging material for this product in an environmentally friendly manner. Please contact your local authorities in regard to the environmentally safe disposal of this product. this product contains flammable insulation blowing gas.



CAUTIONS

- The refrigerant used in the refrigerator/freezer and the gases in the insulation material require special disposal procedures. Ensure that none of the pipes on the back of the appliance are damaged prior to disposal.



WARNING

HOW TO CONNECT ELECTRICITY

- The refrigerator should always be plugged into its own individual electrical outlet which has a voltage rating that matches the rating plate.
This provides the best performance and also prevents overloading house wiring circuits, which could cause a fire hazard from overheated wires.
- Never unplug your refrigerator by pulling the power cord. Always grip plug firmly and pull straight out from the outlet.
- Make sure that the power plug is not squashed or damaged by the back of the refrigerator.
Do not bend the power cord excessively or place heavy articles on it.
Repair or replace immediately all power cords that have become frayed or otherwise damaged. Do not use a cord that shows cracks or abrasion damage along its length or at either end. If the power cord is damaged, have it replaced immediately by the manufacturer or its service agent.
- When moving the refrigerator, be careful not to roll over or damage the power cord.
- Do not insert the power plug with wet hands.
- Unplug the refrigerator before cleaning and making repairs.
Do not use a wet or damp cloth when cleaning the plug. Remove any foreign matter or dust from the power plug pins.
 - Otherwise there is a risk of fire.
 - If the refrigerator is disconnected from the power supply, you should wait for at least five minutes before plugging it back.
- Pull the power plug out of the socket before changing the interior light of the refrigerator.
Otherwise, there is a risk of electric shock.
- If the wall socket is loose, do not insert the power plug.
There is a risk of electric shock or fire.

SAFETY INSTRUCTIONS

FOOD KEEPING & TREATMENT CAUTION

-  **Do not overfill the refrigerator with food.**
- When you open the door, an item may fall out and cause personal injury or material damage.

Do not put bottles or glass containers in the freezer.

- When the contents freeze, the glass may break and cause personal injury.

Do not spray inflammable gas near the refrigerator.

- There is a risk of explosion or fire.

Do not directly spray water inside or outside the refrigerator.

- There is a risk of fire or electric shock.

Do not store volatile or flammable substances in the refrigerator.

- The storage of benzene, thinner, alcohol, ether, LP gas and other such products may cause explosions.

Do not refreeze frozen foods that have thawed completely. Do not store pharmaceuticals products, scientific materials or temperature-sensitive products in the refrigerator.

- Products that require strict temperature controls must not be stored in the refrigerator.

Do not put a container filled with water on the refrigerator.

- If spilled, there is a risk of fire or electric shock.

This product is intended only for the storage of food in a domestic environment.

CLEANING CAUTION

-  **Do not insert your hands into the bottom area under the appliance.**
- Any sharp edges may cause personal injury.

Never put fingers or other objects into the dispenser hole and ice chute. It may cause personal injury or material damage

Do not use a wet or damp cloth when cleaning the plug, remove any foreign material or dust from the power plug pins.

- Otherwise there is a risk of fire.

INSTALLATION CAUTION

-  **Do not store articles on the top of the appliance.**
- When you open or close the door, the articles may fall and cause personal injury and/or material damage.

GROUNDING CAUTION

-  **The refrigerator must be grounded.**
- You must ground the refrigerator to prevent any power leak ages or electric shocks caused by current leakage from the refrigerator.

Never use gas pipes, telephone lines or other potential lightning rods as ground.

- Improper use of the ground plug can result in electric shock.



WARNING

- Keep ventilation openings in the appliance enclosure or mounting structure clear of obstruction.
- Do not use mechanical devices or any other means to accelerate the defrosting process, other than those recommended by the manufacturer.
- Do not damage the refrigerant circuit.
- Do not place or use electrical appliances inside the refrigerator/ freezer, unless they are of a type recommended by the manufacturer.

**READ AND FOLLOW THIS SAFETY INFORMATION CAREFULLY.
SAVE THESE INSTRUCTIONS**

INITIAL OPERATING CONDITION

Once you have performed the following steps, your refrigerator should be fully operational. If not, check the power supply and electricity source. If you have any questions, contact your SAMSUNG service center.

1

Place the refrigerator in an appropriate location with reasonable clearance between the wall and the refrigerator.
(refer to installation instructions in this manual)

2

When the refrigerator is plugged in, the interior light should come on when you open the doors.

3

Set the temperature control to the coldest temperature and wait for an hour. The freezer should get slightly chilled and the motor should run smoothly.

4

Once the refrigerator temperature is sufficiently low, you can store food in the refrigerator. After starting the refrigerator, it takes a few hours to reach the appropriate temperature.

MAJOR FEATURES

Twin Cooling System

- The refrigerator and the freezer have two evaporators. Given this independent system, the freezer and the refrigerator are cooled individually as required and are, therefore, more efficient. Food odor from the refrigerator does not affect food in the freezer due to separate air flow circulation.

Multi-Flow System

- Cool air circulates through multiple vents on every shelf level. This provides even distribution of cooling inside cabinets to keep your food fresh longer.

Door Alarm

- A beeper reminds you if the door is left open.

High humidity for fresher food

- You can keep food, fruit and vegetables fresh for longer because your refrigerator supplies highly humidified cold air. This can be up to four or five times more effective than a normal refrigerator.

Energy-saving fridge/freezer

- Power consumption is kept to a minimum by distributing cool air separately to the refrigerator and freezer.

Faster cooling times

- The power freeze function allow you to freeze food more quickly.

Abundant supply of ice and cold water

- The ice and water dispenser provides ice and cold water at any time.

Beverage Station (optional)

- You do not have to open the main door to access frequently used food in the extra refrigerating compartment. This saves time and money.

Deodorizer

- Reusable deodorizer keeps the refrigerator air fresh and odor free.

CoolSelect Zone™ Drawer (optional)

- User can select Soft Freeze, 0 Zone, Quick Cool, Cool, Thaw items.

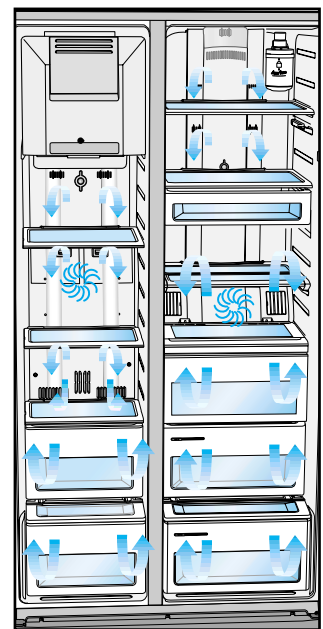

This operation instruction covers various models. The characteristics of your appliance may differ slightly from those described in this manual.

CONTROL PANEL

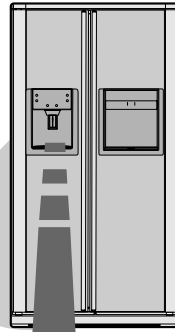
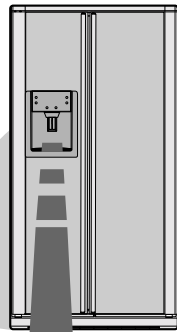

Dispenser Without CoolSelect Zone Model (RSE8D Model)

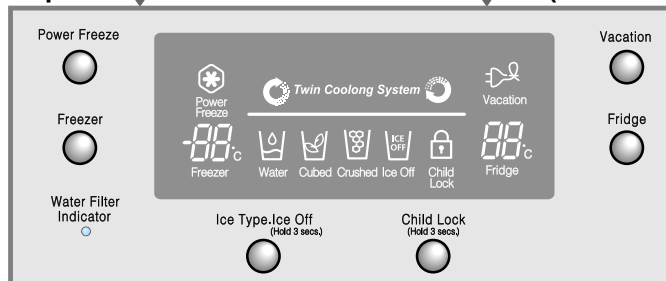

Dispenser With CoolSelect Zone Model (RSE8K/J/V/T Model)

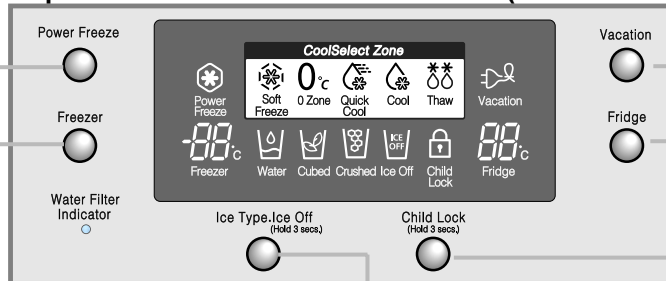

FREEZER TEMP. BUTTON

To set the freezer temperature, press this button repeatedly to change the set temperature in sequence between -14°C and -25°C

FRIDGE TEMP. BUTTON

To set the fridge temperature, press this button repeatedly to change the set temperature in sequence between 7°C and 1°C.

POWER FREEZE BUTTON

Speeds up the freezing process in the freezer.

VACATION BUTTON

Turns the refrigerator off but not the freezer.

ICE TYPE BUTTON

Use this button to choose Water, Cubed or Crushed Ice or Ice off. Also, this button has another function. When this button is pressed for 3 seconds Ice Off function will be off.

CHILD LOCK BUTTON

When the child lock button is pressed for 3 seconds, the child lock indicator is on with an audible tone. When it is locked, all keys can not be modified except the ice type button, and all lamps turn off. This function will prevent accidental setting that may be caused by children or pets. To unlock the setting functions, press this button for 3 seconds.

TEMPERATURE CONTROL

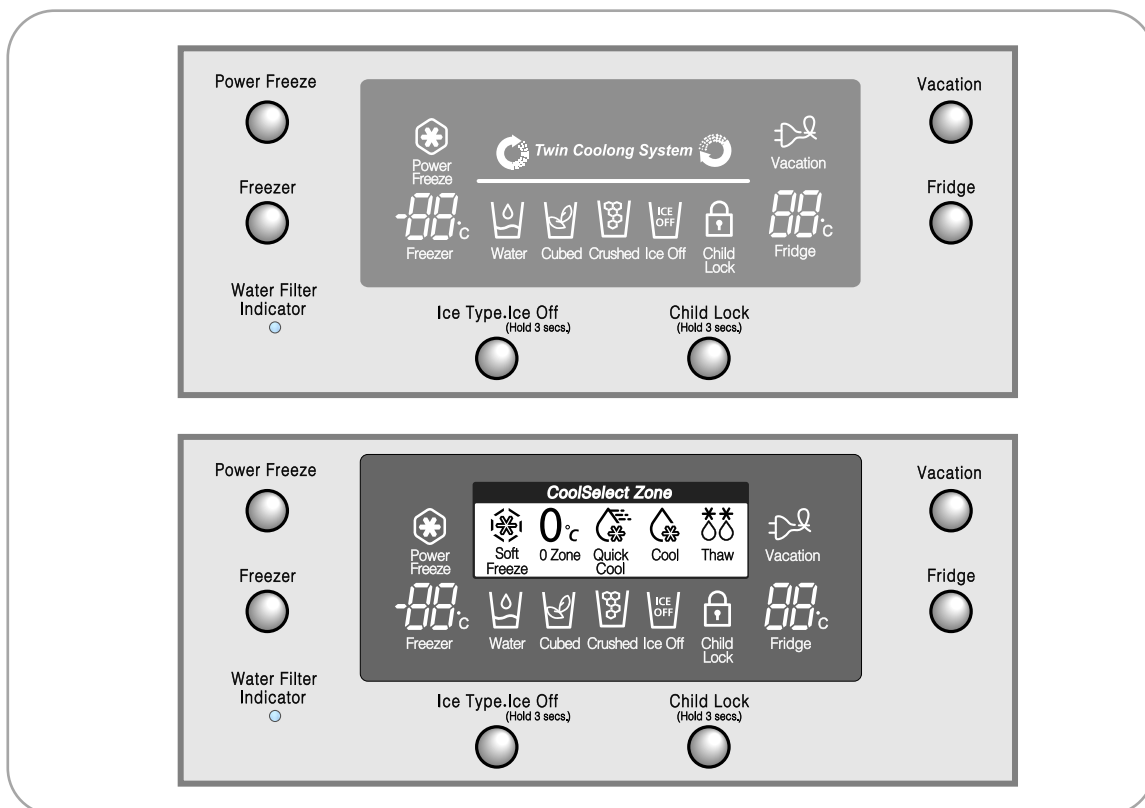

Temperature setting

- The temperature controls are in the factory at 3°C for the refrigerator compartment and -18°C for the freezer compartment. Allow 24 hours for the temperature to stabilize to the preset recommended settings.
- The temperature controls can display both the set temperature as well as the actual temperature in the refrigerator and freezer. The actual temperature may vary slightly from the set temperature based on usage and operating environment.



WARNING

- When ice cream is stored above -15°C in freezer, it may melt.
- The temperature of the freezer or the refrigerator rises from frequent openings, when sweeping and from warm food. This may cause the digital display to blink. The digital display will stop blinking when the freezer and refrigerator return to the normal temperature.

How to change the temperature

- Press and release the button. Set will illuminate in the display, as well as the set temperature. To change the temperature, tap either the button (while set is illuminated) until the desired temperature is displayed. Refrigerator temperature can be adjusted between 1°C and 7°C and freezer temperature can be adjusted between -14°C and -25 °C. Once the desired temperature has been set, the temperature display will clear after 10 seconds. To display the setting temperature, the temperature control button may be tapped.

DIGITAL PANEL

Without CoolSelect Zone Model

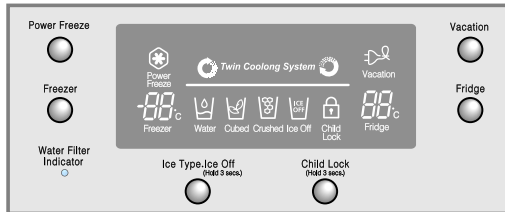

With CoolSelect Zone Model

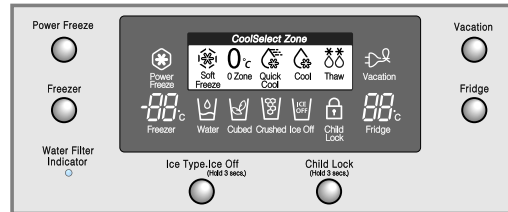

Water, Cubed Ice, Crushed Ice

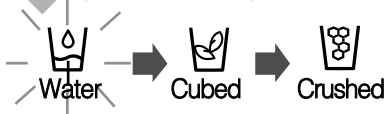

- Press the Ice Type button in sequence to choose water, cubed ice, crushed ice.
- Bright icon indicates the ice state currently in operation.

Ice Off



- Press the Ice Off button for 3 seconds to stop making ice.
- Ice type selection is available during ice off selection.

Power Freeze



- This light is on when you press the Power Freeze button.
- Press this button to quickly return the freezer to the set temperature.
- If you need much ice, you can get ice faster.
- Press the button again to cancel the Power Freezer mode.

Filter Indicator



- When the Green light changes to Orange, it is time to replace the water filter. If indicator is red, quick replacement is strongly recommended.
- When the water filter is replaced, reset the indicator by pressing the ice type button and child lock button simultaneously for 3 seconds.
- To return this indicator off, press the ice type and child lock buttons simultaneously for 3 seconds.

Vacation Button



Vacation



- Press the vacation button not to use fresh-food compartment. But it still operates freezer compartment during this function.
- When you select vacation button for fridge compartment off, display LED will be moved from fridge to vacation automatically.
- It is strongly requested to remove foods in the fresh-food compartment and do not leave the door open when you select Vacation function.

Ice Off & Child Lock Button



- When the Ice Off button and Child Lock button are pressed simultaneously for 3 seconds, the heater for sweat is off.
- If sweat appears around the cover dispenser or beverage station with this function, press these buttons for 3 seconds again. Then, the light will turn off and the sweat control function will be performed.

DIGITAL PANEL

Cool Select Zone Display LED



- Bright lamp indicates the state currently in operation in the cool select zone.
- Any display LED will not be displayed when you select the vacation function.
- Do not keep any food when you select the vacation function.

Child Lock Button



Child Lock

- When the child lock button is pressed for 3 seconds, the child lock indicator is on with an audible tone. When it is locked, all keys can not be modified and all lamps turned off except the child lock indication lamp. This function will prevent accidental setting that may be caused by children or pets. To unlock the setting functions, press this button for 3 seconds again.

ICE and COLD WATER DISPENSER

Ice Dispenser

The ice maker produces 8 cubes at a time and about 130 cubes a day automatically. This quantity may be influenced by factors such as the freezer temperature, the Power Freeze function and the number of times the door is opened. When your refrigerator is plugged in, the Cubed Ice mode is automatically selected.

Press the Ice Type button to select the type of ice:

- Cubed Ice

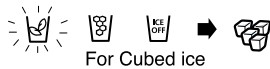

For Cubed ice

- Crushed Ice



For Crushed ice

- No Ice



For ice off



NOTE

If the Ice remains in the Ice bucket, the cubed ice is obtained.

Push the ice dispenser lever with a cup.

- Place a cup in line with the dispenser lever to prevent the ice from jumping out.

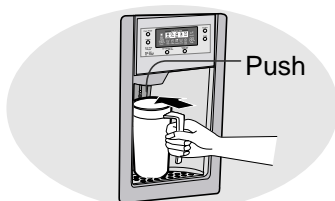

Water Dispenser

The capacity of the water tank is approximately 0.8 l.

Cold Water

- **Press the Ice type button to select Water.**
- Push the water dispenser lever with a cup.
- If you have just installed the refrigerator, throw away the first four full glasses of water to flush out impurities in the water supply system.

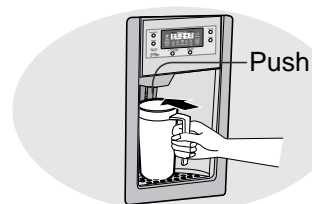

CAUTION

If you have a long vacation or business trip and won't use the water or ice dispensers, close the water valve. Otherwise, water leakage may occur.



WARNING

Never put fingers or any other objects in the dispenser opening. It may cause injury.

SHELVES AND BINS



FREEZER

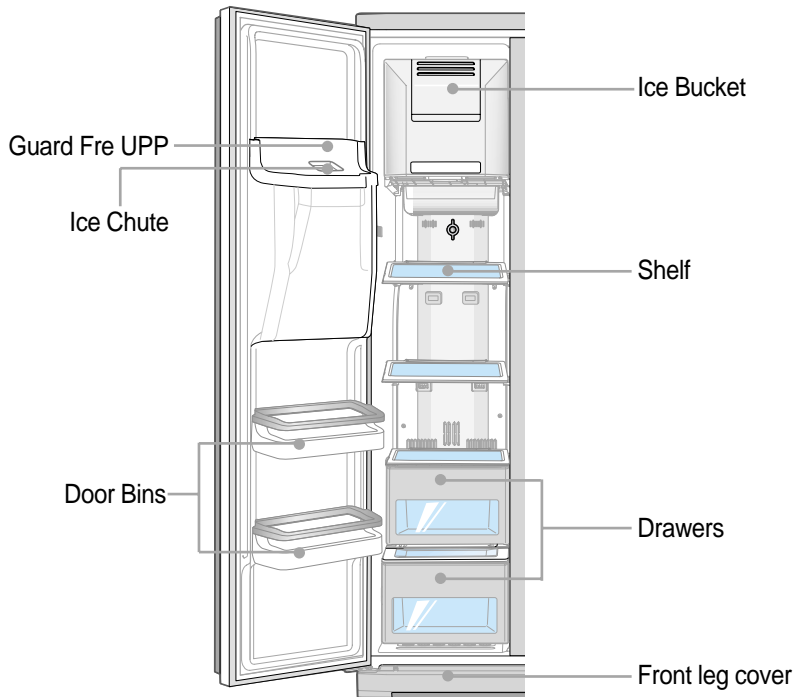

REFRIGERATOR

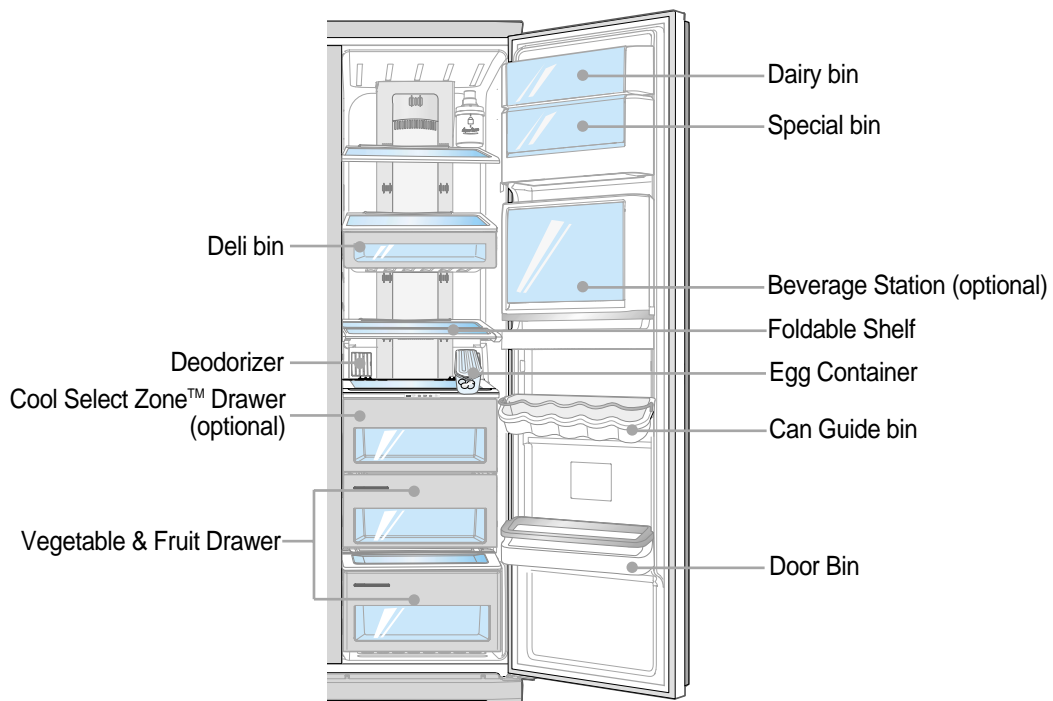

FOOD STORAGE GUIDE

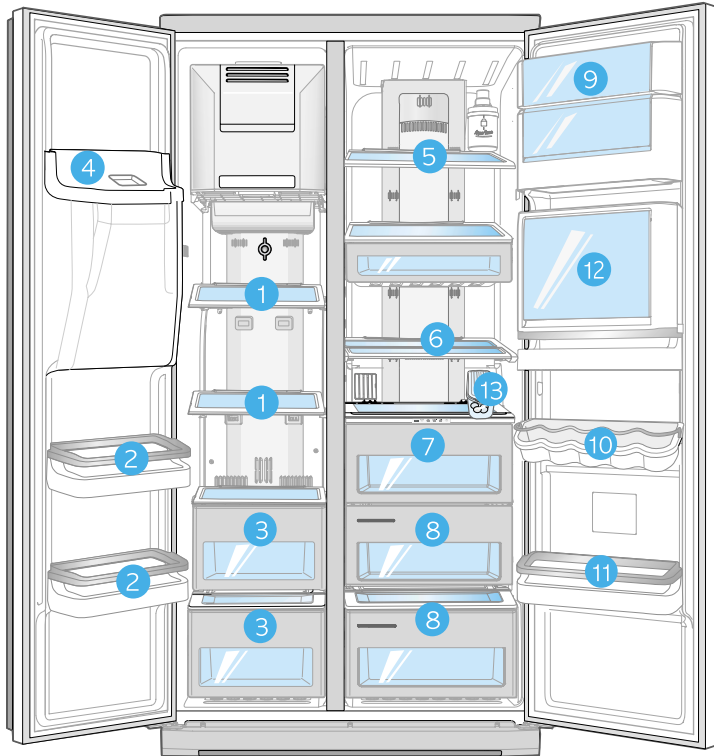

For more space, you can store food with drawers and ice bucket removed.

FROZEN FOOD STORAGE IN FREEZER

- 1 Tempered Glass Shelf**
 - Can be used to store all types of frozen food.
- 2 Door Bin**
 - Can be used for small packages of frozen food.
- 3 Plastic Drawer**
 - Can be used to store meat and dry foods. Stored food should be wrapped securely using foil or other suitable wrapping materials or containers.
- 4 Guard Fre UPP**

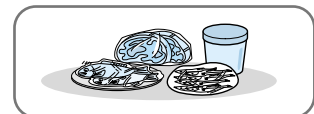
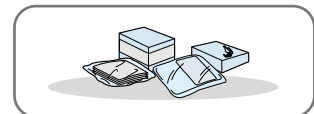

Remove the "Guard Fre UPP" and keep it another place when you use the Ice dispenser



Do not put your fingers, hands or any other insuitable objects in the chute or ice-maker bucket. It may result in personal injury or material damage.

FOOD STORAGE GUIDE

CHILLED FOOD STORAGE IN REFRIGERATOR

5

Tempered Spill Proof Glass Shelf

- Can be used to store all types of chilled food.
- Safe and hard to be broken.
- Circular marks on the glass surface are a normal phenomenon.



6

Foldable shelf

- If you need more taller space for tall items. Raise the front of shelf slightly and push it back to make it half. You can use the shelf in this position to allow taller items to be stored.



7

CoolSelect Zone™ Drawer (optional)

- Helps to preserve the taste of food and prolongs its freshness. Use to store cheese, meat, poultry, fish or any other foods used quickly.



8

Fruit & Vegetable Drawer (Upper and Lower)

- Is used to store fruits and vegetables.
- This drawer is airtight. Optimized humidity control design helps to preserve the freshness of the stored vegetables and fruits.

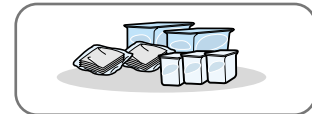

9

Dairy Compartment

- Can be used to store butter or margarine.

10

Can Guide Bin

- Can be used to store beverage can or bottle.



11

Door Bin

- Can be used to store foods in small packages, such as milk and yogurt.

12

Beverage Station (optional)

- Can be used to store the frequently used items, such as canned beverages and snacks and allows access to these items without opening the refrigerator door.



CAUTION

Bottles should be stored tightly together so that they do not fall out.

13

Egg Container

- Put eggs in the container and place them on the shelf.

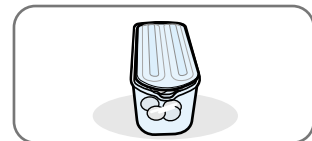

WARNING

- If you have a long vacation planned, you must empty the refrigerator and turn it off. Wipe excess moisture from the inside and leave the doors open. Otherwise, odor and mold may develop.
- In case the model has CoolSelect zone™, do not insert a shelf to this rail, or the shelf can collide with beverage station cover and the beverage station cover can be broken.

The Rail that should not be used for CoolSelect zone model

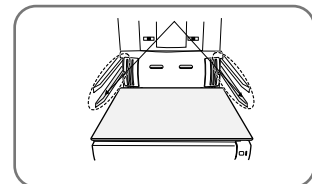

CoolSelect Zone™ Drawer GUIDE (Optional)

1 Soft Freeze

- When “Soft Freeze” is chosen, the temperature on the digital panel displays -5°C regardless of the set temperature of the refrigerator.
- “Soft-Freeze” temperature helps keep meats and fishes fresh longer.
- Can cut meat easily without drips.

2 Zero Zone (0°C)

- When “Zero Zone” is chosen, the temperature of the CoolSelect Zone™ Drawer is kept at 0°C regardless of the set refrigerator temperature.
- “Zero Zone” temperature helps keep meat or fish fresh longer.

3 Quick Cool

- You can use the Quick Cool feature with the CoolSelect Zone™.
- “Quick Cool” allows 1–3 canned beverages to cool within 60 min.
- To cancel this function, press the “Quick Cool” button again. CoolSelect Zone™ returns to the previous temperature.
- When “Quick Cool” ends, it returns to the “Cool” temperature setting.

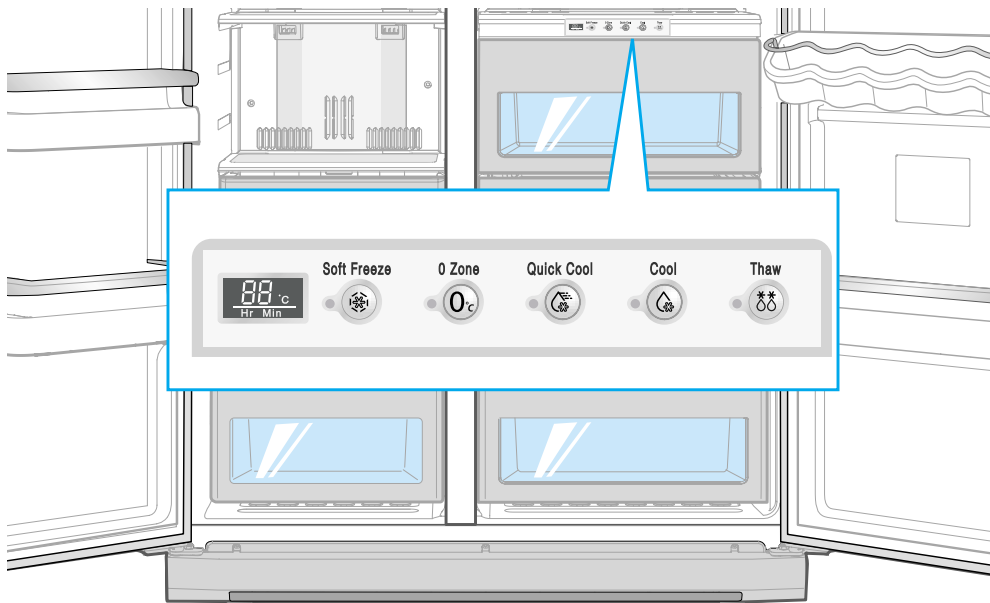

4 Cool

- When “Cool” is chosen, the temperature will be the same as the set temperature of the refrigerator. The digital panel shows the same temperature as that of the display panel.
- The CoolSelect Zone™ Drawer allows extra refrigerator space.



NOTE

Depending on the beverages, the cool-down time may vary.



WARNING

• For “Quick Cool” option, food stored in the CoolSelect Zone™ Drawer should be removed.

CoolSelect Zone™ Drawer GUIDE (Optional)

5 Thaw

- Drips loss and quality deterioration of meats reduces the freshness of foods.
- After "Thaw" is selected, warm and cold air is alternately supplied into the CoolSelect Zone™ Drawer .
- Depending on the weight of meat, thawing time can be selected for 4 hrs, 6 hrs, 10 hrs, and 12 hrs sequentially.
- When "Thaw" ends, CoolSelect Zone™ display returns to "Zero Zone" condition.
- When "Thaw " ends, there are no juice in the meats and they are half-frozen condition so it is easy to cut them for cooking.
- To cancel this option, press any button except "Thaw".
- The approximate thawing time of meat and fish are shown below. (Based on 1inch thickness)

Thaw Time	4 hours	6hours	10 hours	12 hours
Weight	400 g	600 g	800 g	1000g







Depending on the size and thickness of meat and fish, the thawing time may vary.
 The above weight represents the total weight of food in the CoolSelect Zone™ Drawer.
 Ex) The total thawing time for 400g frozen beef and 600g frozen chicken will be 10 hours.



WARNING

- With the "Thaw" option, food which is not needed to thaw in the CoolSelect Zone™ Drawer should be removed.

Classification	Temp. (°C)	Foodstuff	
 Soft Freeze	-5 °C	butter, cheese, processed foodstuffs....	
 0 Zone	0 °C	beef, pork(hogmeat), mutton, veal, chicken, fowl, egg....	asparagus, cabbage, carrot, garlic, salad, onion, spinach, fruits...
 Cool	Fridge setting Temp.	dry milk, ham sausage, sausage, smoked fish, salt fish, alcoholic drink, soft drink...	
 Quick Cool	Refer to page 13	water, alcoholic drink, soft drink...	
 Thaw	-	Refer To Table Page14	

REMOVING THE FREEZER ACCESSORIES

1

Tempered glass shelf

- Pull the shelf out as far as it goes. Then lift it up and remove it.

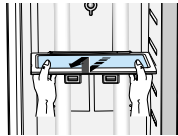

2

Door bins

- Hold the door bin with both hands and then lift it up.

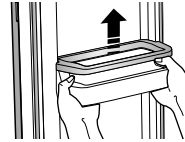

3

Drawers

- Remove the drawer by pulling it out and lifting it up slightly.

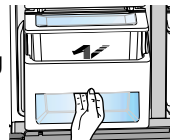

4

Ice storage bucket

- Remove the bucket lifting up and pulling out.

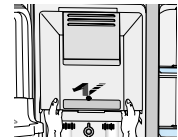

5

Front Leg cover

- Open the freezer and refrigerator doors, remove the three screws and detach the cover.
- To reassemble the leg cover, put it back into position and tighten the three screws.

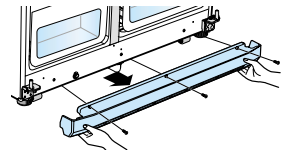

* Only remove the leg cover if strictly necessary.



NOTE

- Do not use excessive force when disassembling the cover; otherwise, you may cause damage.

REMOVING THE REFRIGERATOR ACCESSORIES

Before you remove the drawers, covers and shelves please remove the door bins and beverage station.

1

Tempered glass shelf

- Pull the shelf out as far as it will go. Then lift it up and remove it.

2

Door bins

- Hold the door bin with both hands and remove it by lifting it up.

3

Fresh fruit & vegetable drawer and cover

- Remove the compartment by holding the handle, pulling the compartment towards you and lifting it up slightly.
- Remove the cover by pulling it towards you.

4

COVER DRAWERS

- Remove the cover drawer by pressing the stopper and pulling it out slightly.

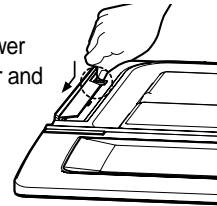

BEVERAGE STATION™ (Optional)

To access the extra refrigerating compartment, hold the compartment door handle and pull it downwards.

- The extra refrigerating compartment gives you added convenience because you do not need to open the main refrigerator door. In addition, this saves energy.

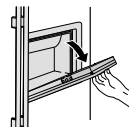

It is recommended that you use the extra refrigerating compartment for frequently used foods like beverages.

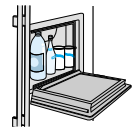

When the door is opened, it can be used as a tray to support items, such as beverage bottles and glasses.

- Do not scratch the surface of the door.

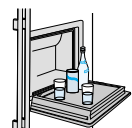

WARNING

- Before removing the freezer and refrigerator accessories, please move the stored foods to other space.
- The door of the Beverage Station should never be removed.
- The Beverage Station™ cannot function if its door is missing.
- When you close the door of beverage station, be careful not to put your hands or fingers in a position where those can be caught or injured.
- If you use the opened door as a tray do not place heavy objects on it.
- Do not allow children to hang on the door, because there is a risk of personal injury or material damage.

CLEANING THE ACCESSORIES

Inside

- Clean the accessories using a mild detergent. Then wipe with a dry cloth.
- After washing the accessories, make sure that they are dry before using them again.

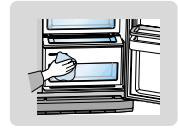

Exterior

- Wipe the front control panel with a clean cloth.
- The doors and door handles should be cleaned with a mild detergent and cloth. Dry them with a clean cloth.
- The exterior should be polished once or twice a year.



Rear

- Use a vacuum cleaner to remove dust once or twice a year.

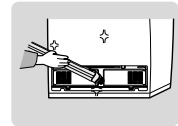

Ice and water dispenser and drainage grid

- Use a damp cloth to clean the ice and water dispenser. Then wipe it with a dry cloth.
- Keep the ice and water dispenser and drainage grid dry.



Beverage station (optional)

- Use a damp cloth to clean the extra refrigerating compartment. Then wipe it with a dry cloth.

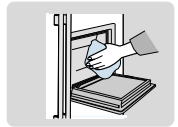

Rubber door seals

- If the rubber door seals are dirty, the door will not close properly and the refrigerator and freezer will be unable to function efficiently. Clean them with a mild detergent and damp cloth. Then wipe them with a dry cloth.



NOTE

- When cleaning the appliance or if you are not going to use it for a long time, remove the power plug, leave the doors open and keep the appliance dry.
- Do not clean it by spraying it directly with water.
- Do not clean it with benzene, thinner or car detergent.

CLEANING THE ACCESSORIES

Deodorizer

- Remove the cover with a flat blade screw driver as shown.
- Take out the cartridge from the cover and soak it in clean, warm water for at least 4 hrs. Completely dry out the cartridge with sunlight for at least 8 hrs in an open area.
- Repeat this process once or twice a year.

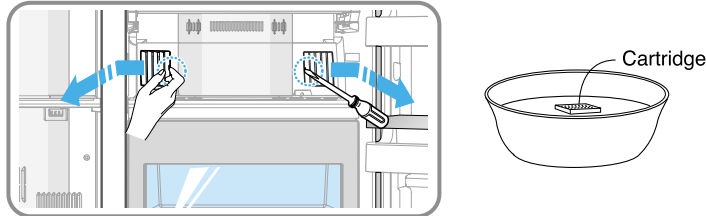

- If it is dried in a confined area, odor may be spread to that area.
- Keep the children away from yellow water. **DO NOT** drink water.

CHANGING THE INTERIOR LIGHT



Before changing the interior light, unplug the appliance from the power supply. If you experience difficulty when changing the light, contact your service centre.

WARNING



INTERIOR LIGHT IN THE REFRIGERATOR

- 1** Place a flat screwdriver under the light cover hooks and push in the direction of the arrow.
- 2** Pull the cover in the direction of the arrow.
- 3** After changing the bulb, replace the light cover.

Interior Light Up

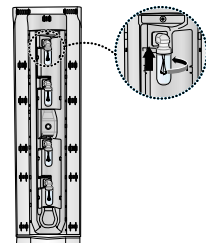
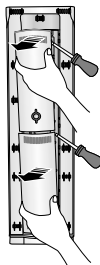
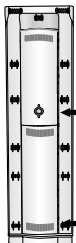

Interior Light Low

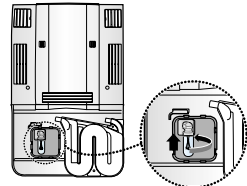
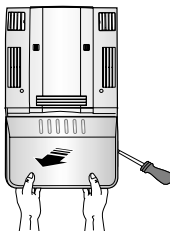
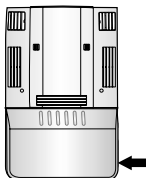

CHANGING THE INTERIOR LIGHT



INTERIOR LIGHT IN THE FREEZER (MODEL WITH ICE AND WATER DISPENSER)

- 1** Lift and pull out the ice bucket (①).
- 2** Use a screwdriver to remove the light cover (②).
- 3** Replace the bulb with a new one (③), and then secure the light cover back into place.
- 4** Relocate the ice bucket.

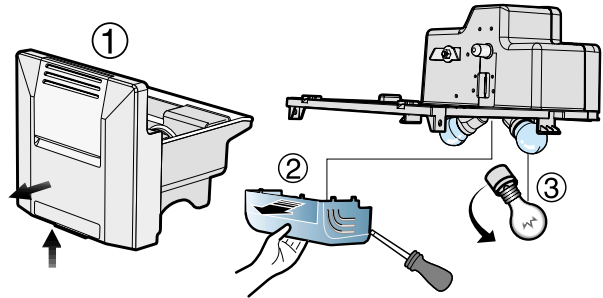

WATER FILTER

The water “Filter Indicator” light

- “Filter Indicator” light lets you know when it is time to change your water filter cartridge. The light will change from green to orange. This tells you that it is almost time to change the current cartridge.

It is recommended that you replace the cartridge when the light changes to red.
(see “Install the water filter” section for more information)

Using the dispenser without the water filter

- You can not use the water and ice dispenser without a water filter cartridge because of the water line block at the water supply.

Ordering replacement filters

- To order more water filter cartridges, contact your authorized Samsung dealer or SVC agent.

DOORS

The refrigerator doors have a special door opening and closing feature to make sure that the doors close all the way and are securely sealed.

When opening the door, it will remain open only after reaching a certain point.

When the door is partially open, it will close automatically .

INSTALLATION OF THE REFRIGERATOR



Checking the Dimensions of your Entrance Door



NOTE

- Check the dimensions of your entrance door to determine whether the refrigerator can pass through it.
- Moving refrigerator through door if depth or width of refrigerator is bigger than door's, removes refrigerator doors.



Selecting the Location for the Refrigerator

- Select a location with easy access to the water supply.
- Select a location with enough space for the refrigerator.
- Select a location without direct exposure to sunlight.



CAUTION

- Before disassembling the freezer door, the water supply line needs to be disconnected. (If not, the water supply line can be damaged.)
- See "Separating the water supply line from the refrigerator" on the next page.

Allow sufficient space to install the refrigerator on a flat surface.

- If your refrigerator is not level, the internal cooling system may not work correctly.

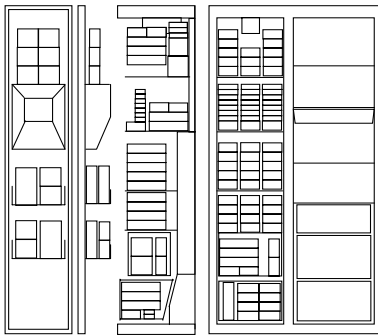

Loading Plan



NOTE

When you install the refrigerator, it is recommended that the clearance be maintained as much as specified below. To get the sufficient Energy efficiency, keep the clearance of the back side more than 10Cm and follow the Loading Plan. To get more space remove the upper box in the freezer and all boxes in the fresh food compartment since it does not effect satisfactory thermal and mechanical characteristics.



CAUTION

- Be careful when you open the door in full swing. It might come in contact with its adjacent units.

For fitting proud of adjacent units

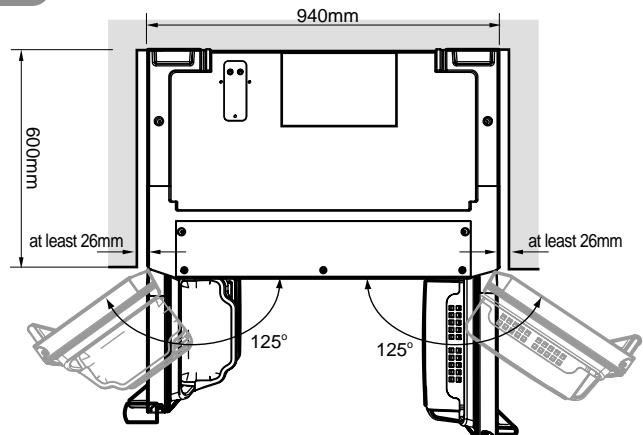
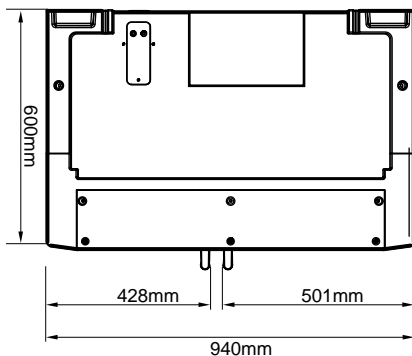

INSTALLATION INSTRUCTIONS

REMOVING THE FRONT LEG COVER



Removing the Front Leg Cover

Open the freezer and refrigerator doors, and then take off the front leg cover assembly by turning the three screws counter-clockwise.

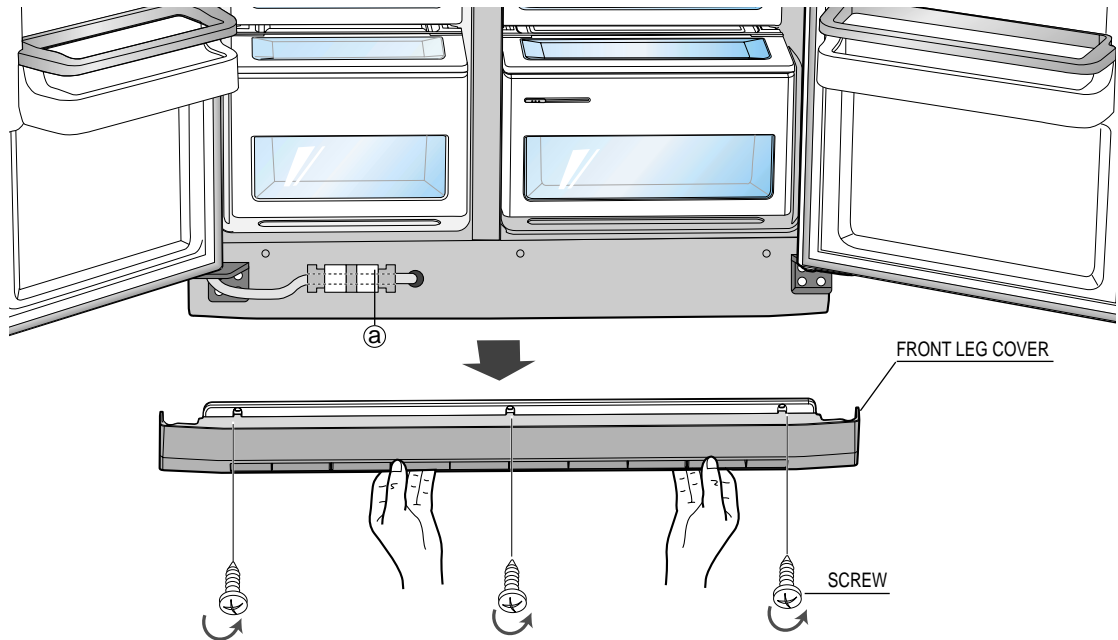

Separating the water supply line from the refrigerator

1) Remove the water tube by pressing the coupler (2) and pulling the water tube (1) away.

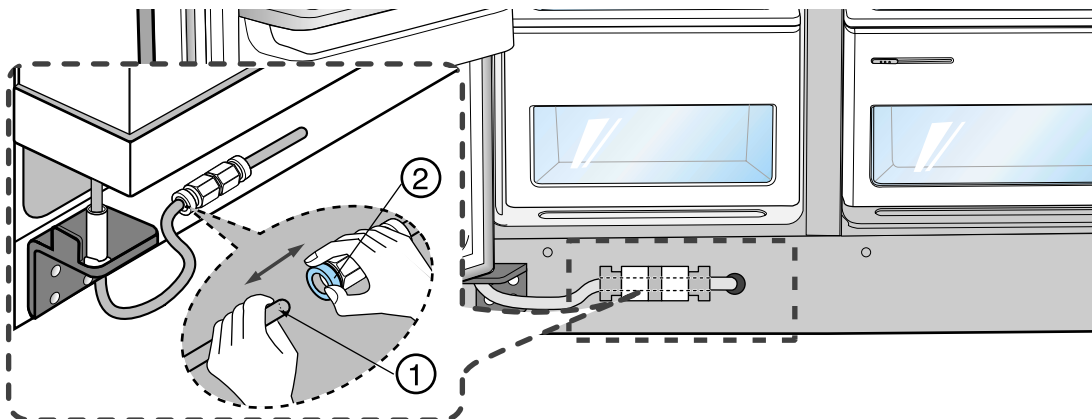

WARNING

Do not cut the water tube but separate it from the coupler.

REMOVING THE REFRIGERATOR DOORS



- Lift the door straight up.
- Be careful not to pinch the water tubing and wire harness on the door.
- Place doors on a protected surface.



Removing the Freezer Door

- 1) With the door closed, remove the Top table (①) using a screwdriver, and then disconnect the wires (②).

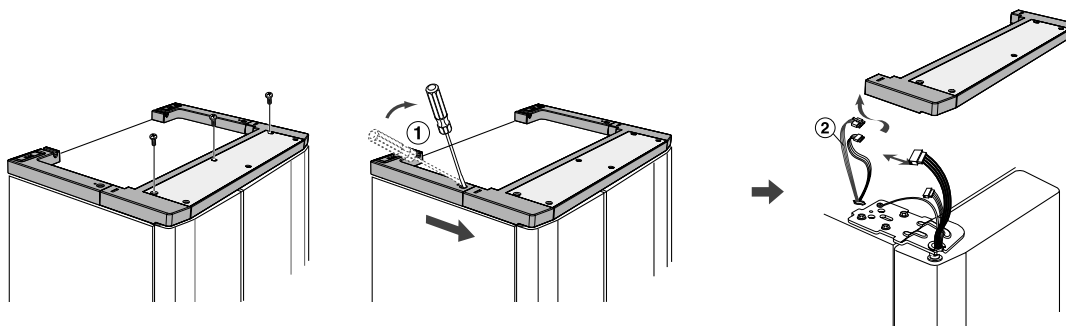

- 2) Remove hinge screws (③) and ground screw (④) counter-clockwise, and take off the upper hinge (⑤) along the arrow (⑥). Take care when removing the door to ensure that it does not fall on you.

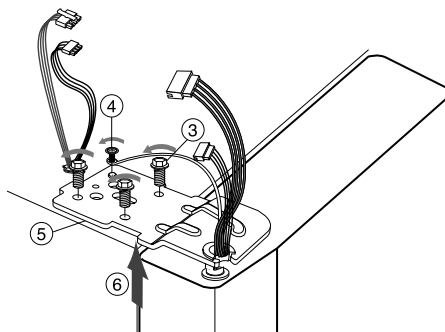

- 3) Remove the door from the lower hinge (⑦) by carefully lifting the door (⑧).

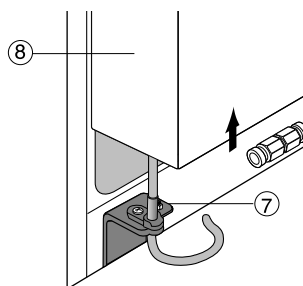

REMOVING THE REFRIGERATOR DOORS



Removing the Refrigerator Door

1) Disconnect the wires (①).

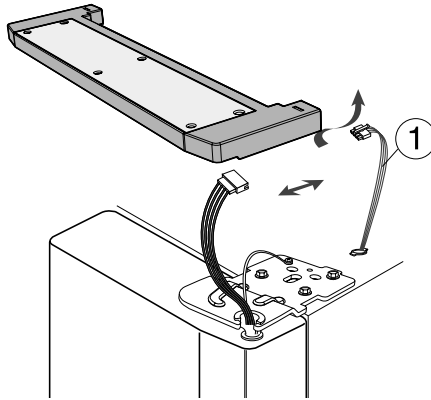

2) Remove hinge screws (②) and ground screw (③) counter-clockwise, and take off the upper hinge (④) in the direction of the arrow (⑤). Take care when removing the door to ensure that it does not fall on you.

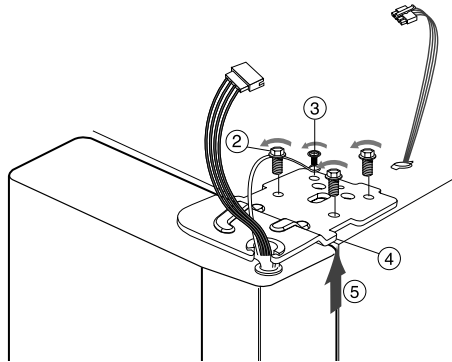

3) Remove the door from the lower hinge (⑥) by lifting the door (⑦).

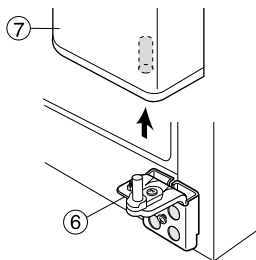

4) Remove the lower hinge (⑧) from the bracket lower hinge (⑨) by lifting the lower hinge (⑧) in the direction of the arrow.

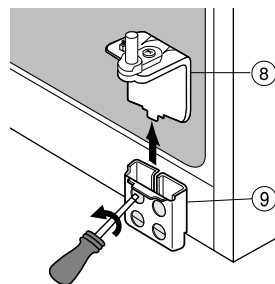

• After disassembling the freezer / refrigerator door, move it to the appropriate location. you must reassemble it.

REATTACHING THE REFRIGERATOR DOORS



Reattaching the Freezer Door

- 1) Reattach the freezer door by inserting the hose (1) in the lower side of the door into the hole in the lower hinge (2) and pull the hose down.

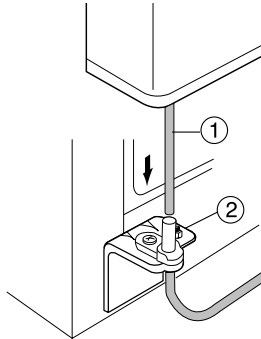

- 2) Insert the upper hinge shaft (3) into the hole (4). After levelling the upper hinge hole (5) with the hole of the cabinet (6). Fasten bolts (7) and screw (8) in a clockwise direction.

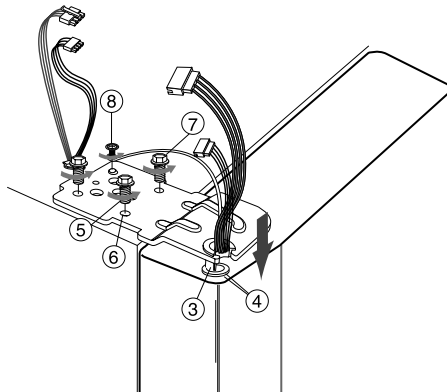

- 3) Connect the wires.

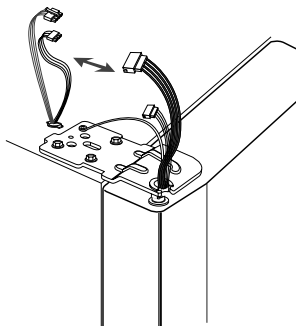

- 4) Put the front part of the Top table (9) on the front part of the upper hinge (10) and reattach from the front part of the Top table first.

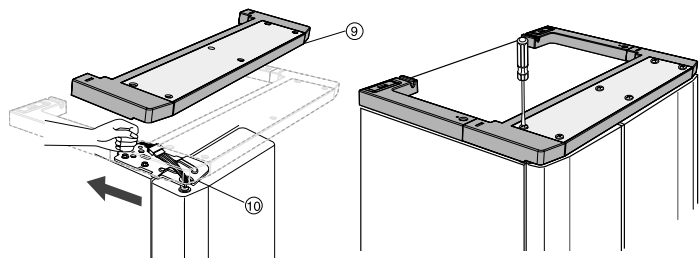

REATTACHING THE REFRIGERATOR DOORS



Reattaching the Refrigerator Door

1) Insert the lower hinge (①) in the bracket lower hinge (②).

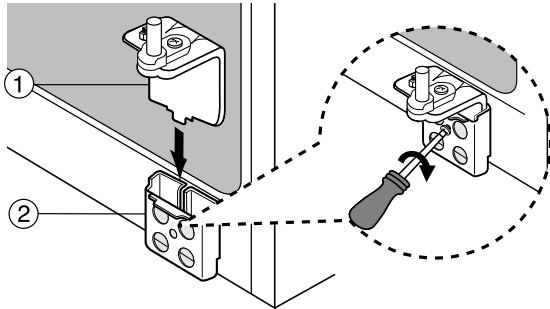

2) Place the hole in the refrigerator door (③) over the lower hinge (④).

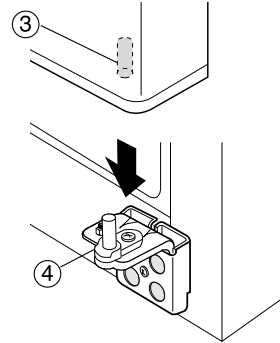

3) Insert the upper hinge shaft (⑤) into the hole (⑥). After levelling the upper hinge hole (⑦) with the hole of the cabinet (⑧). Fasten hinge screws (⑨) and screw (⑩) in the clockwise direction.

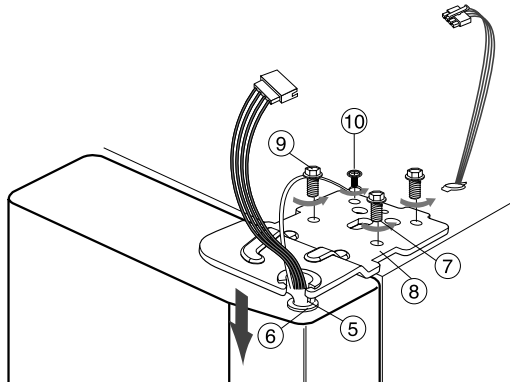

4) Connect the wires.

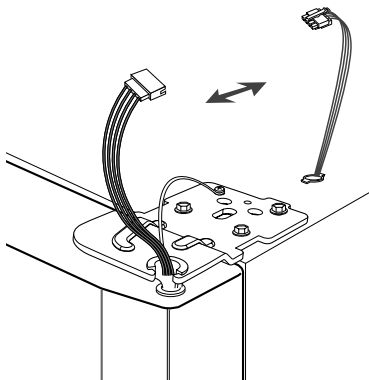

5) Put the front part of the Top table (⑪) on the front part of the upper hinge (⑫) and reattach it from the front part of the Top table first.

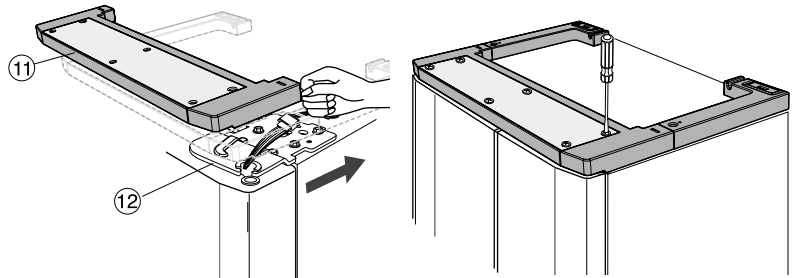

REATTACHING THE REFRIGERATOR DOORS



Reattaching the Water Tube

1) While pressing the front face of coupler (②), insert the water line (①) in the coupler.

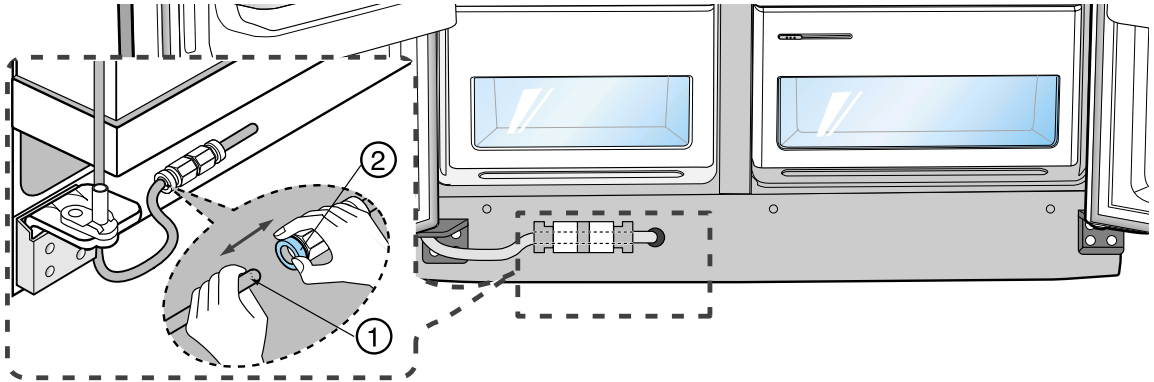

Reattaching the Front Leg Cover (Optional)

Put on the front leg cover by turning the three screws clockwise, as shown in the figure.

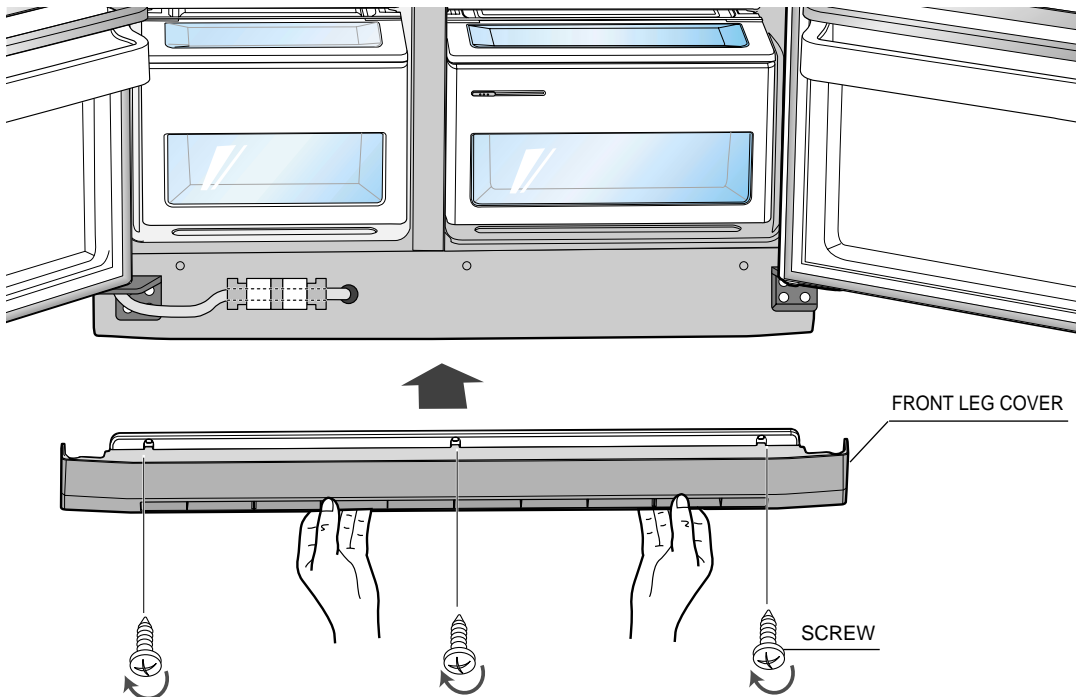

ADJUSTING THE CLEARANCE BETWEEN THE DOORS



Please level the refrigerator first.

The doors will be uneven if the refrigerator is not level.

Case 1) Freezer door is lower than that of the refrigerator

Insert a straight screwdriver (-) (①) into a slot of the control lever (②), turn it clockwise and level the refrigerator.

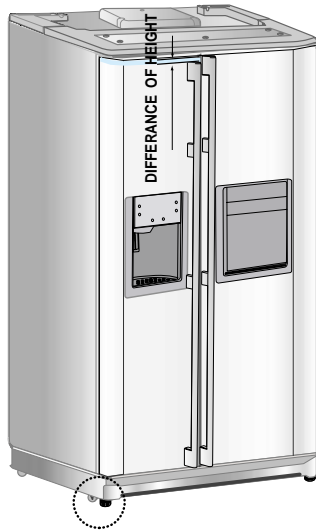

① DRIVER(-)

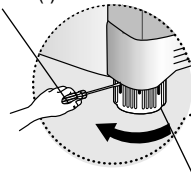

② CONTROL LEVER

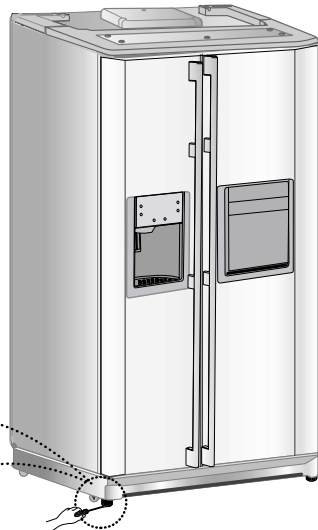

Case 2) Freezer door is higher than that of the refrigerator

Insert a straight screwdriver (-) (①) into a slot of the control lever (②), turn it clockwise and level the refrigerator.

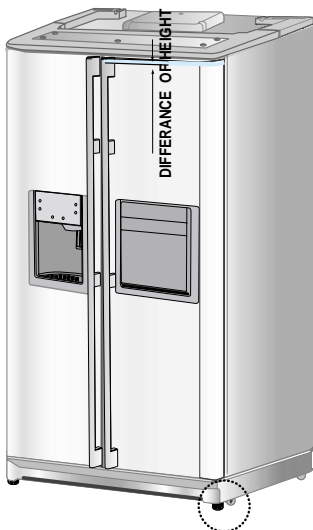

① DRIVER(-)

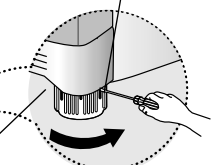

② CONTROL LEVER



Do not make small adjustment by turning the control lever, Please refer to the next page.

ADJUST THE CLEARANCE BETWEEN THE DOORS



Making small adjustments between doors.

If the door of freezer is higher or lower than that of the refrigerator.



Please open the doors and adjust the doors as follows:

- 1) Release the nut (①) on the lower hinge until the upper end of the bolt (②).



NOTE

When you release the nut (①), use enclosed hex wrench (③) to turn the bolt (②) a little counter clockwise. Loosen the nut (①) with your finger.

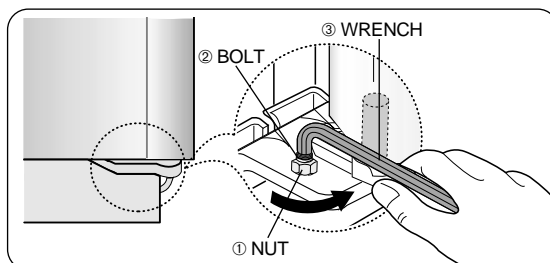

- 2) Please adjust the height difference between the doors turning the bolt (②) clockwise (↻) or counter clockwise (↺).



NOTE

When you turn clockwise (↻), the door goes up.

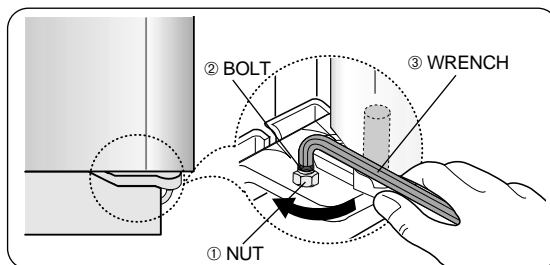

- 3) After adjusting the doors, turn the nut (①) clockwise (↻) until the lower end of the bolt, then tighten the bolt again with the wrench (③) to fix the nut (①).

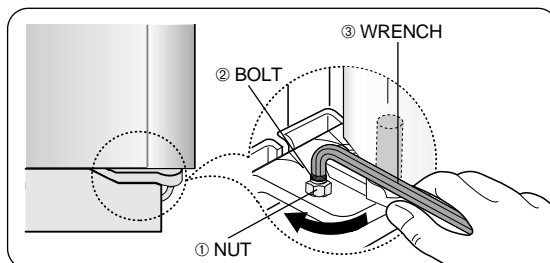

NOTE

If you do not fix the nut (①) firmly, the bolt (②) may be released.

CHECKING THE WATER DISPENSER LINE (OPTIONAL)

- 1) In order to operate the ice maker properly, water pressure of 1.4 ~ 10 kgf/cm² (0.14 ~ 9.8Mpa, 19.9 ~ 142.2 psi, 1.37 ~ 9.8 bars) is required.
In this range a 100 cc paper cup can be filled in 10 seconds.
- 2) The water filter removes particles. It does not sterilize or destroy any micro-organisms.
- 3) If the refrigerator is installed in an area with low water pressure (below 1.4kgf/cm², 0.14 Mpa, 19.9 psi,1.37bars), you should install a booster pump to compensate for the low pressure.
- 4) Ensure the water storage tank inside the refrigerator is properly filled initially. Push the water dispenser lever until the water runs from the outlet.



A universal water supply kit is available at extra cost from your dealer. The refrigerator manufacturer recommends using a water supply kit containing copper tubing.



Checking the Parts

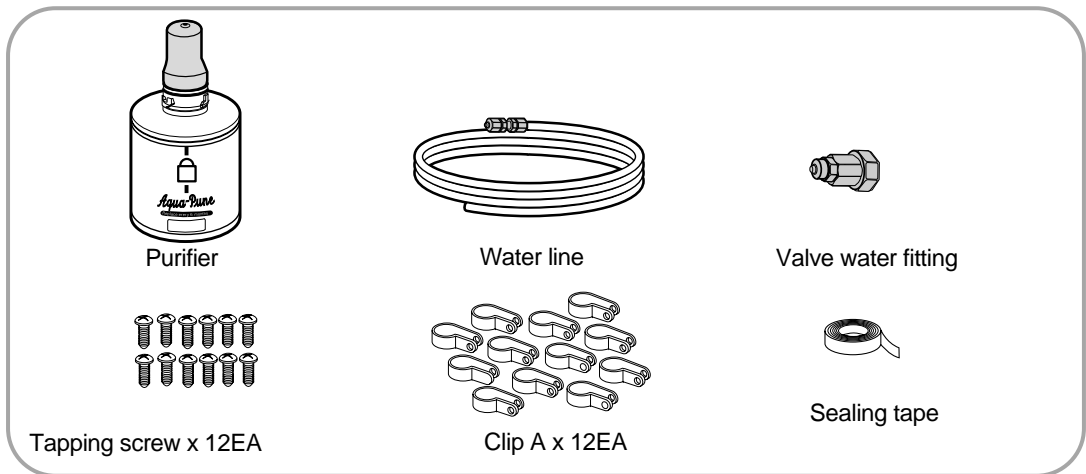

(Connector Water Filter Assy)

INSTALLING OF THE WATER DISPENSER LINE

(Case 1)



Connecting to water supply line

- Shut off the main water supply line and turn the Ice maker to the off position.
- Locate the nearest cold drinking water line.
- Follow the instructions in the ice maker installation kit.

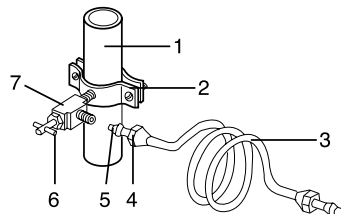

1. Cold Water line
2. Pipe Clamp.
3. Copper (or Plastic) line
4. Compression Nut
5. Compression Sleeve
6. Shut Off Valve
7. Packing Nut.

INSTALLING OF THE WATER DISPENSER LINE



Connect the water line to the refrigerator

- Slip the compression nut and plastic ferrule through the plastic tube.
- After inserting the sleeve, tighten the compression nut onto 1/4" compression fitting(union).

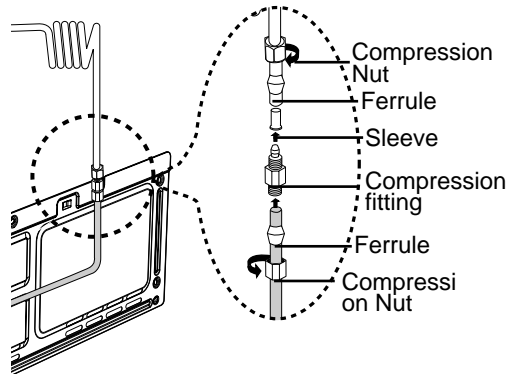

Do not overtighten the compression nut.

NOTE

- Slip the compression ferrule and nut on copper(or plastic) tubing as shown.
- Tighten the compression nut onto the compression fitting(union).
- Turn water on and check for any leakage.



Waterline must be connected to drinkable water only

NOTE

(Case 2)



Check the water supply line

- Connect the water pipe with coupler and tap.
- Close the main water tap.
 - Connect coupler "A" to the tap.
 - Every join should be protected with sealing tape.

CAUTION

The water line must be connected to the cold water pipe. If it is connected to the hot water pipe, it may cause the purifier to malfunction.

WARRANTY INFORMATION

This water line installation is not covered by the refrigerator or ice maker manufacturer's warranty. Follow these instructions carefully to minimise the risk of expensive water damage.

Note:

If the coupler does not fit on the current tap, go to the nearest authorised service dealer and purchase the right coupler fittings.

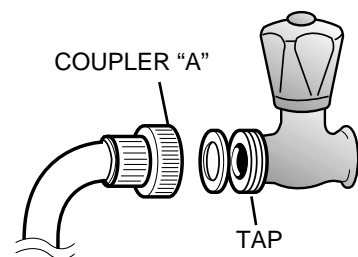

INSTALLING THE WATER DISPENSER LINE



Connect the water line to the refrigerator.

- Remove the compressor cover of the refrigerator.
- Connect the water line to the valve, as shown in the figure.
- When connected, check if there is any leakage.
If any, repeat the connection.
- Reattach the compressor cover of the refrigerator.

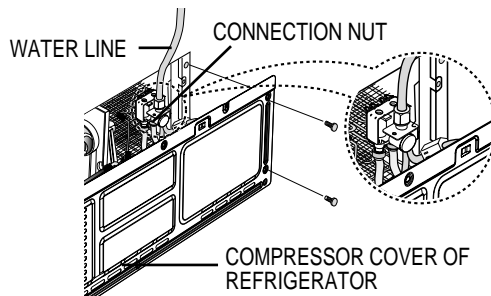

Secure the water line.

- Using clip "A", fix the water line to the wall (the back of refrigerator).
- When the water line is secure, make sure whether the water line is not excessively bent, pinched or squashed.
Complete the installation of the water supply line.
- Power on the refrigerator and press the lever on the right of the dispenser until water runs out through the water line and all air has been empty.
- At this time, check for any possible leakages at the join point in the water line.
After securing the water line, move the refrigerator to the required location.
Once the refrigerator is in position, do not move possibly.

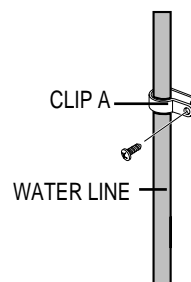

Install the water filter.

- As shown, separate the fixed cap in the refrigerator by rotating it counterclockwise.
Remove the water filter from the box and put a month indicator sticker on the filter as shown.
- Write the month you installed the filter on the label.
EX) If the water filter was installed in March, put "MAR"
- Remove the protective cap then position and insert the filter as shown,
- Slowly turn the water filter clockwise 90° to align the indication mark on the cover, locking the filter in position. Do not overtighten.

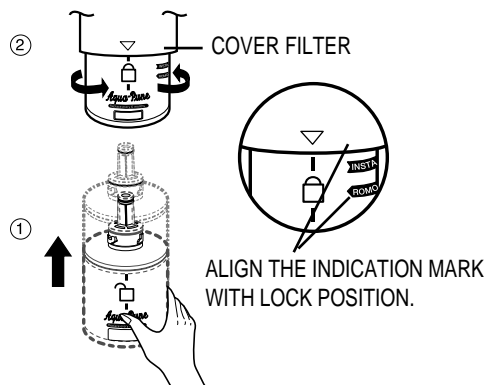
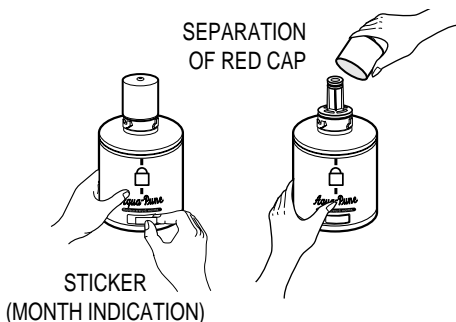
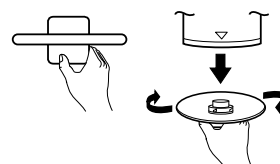

CAUTION

Please check if the indication line aligns with the lock position.

INSTALLING THE WATER DISPENSER LINE



Remove any residual matter inside the water supply line

- 1) Turn on the main water supply & shut-off valve of the water supply line.
- 2) Run water through the dispenser until the water runs clear (6-7 minutes). This will clean the water supply system and clear air from the lines.
- 3) Additional flushing may be required in some households.
- 4) Open the refrigerator door and check if water leaks around the water filter.

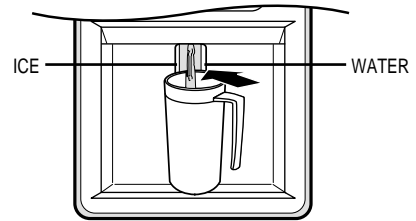

NOTE

- A newly-installed water filter cartridge may cause water to briefly spurt from the dispenser.



Check the amount of water supplied to the ice tray.

- 1) Lift up (1) and pull out (2) the ice maker bucket in the freezer.

2) When you press the test button, the ice cube container is

filled with water from the water supply tap.

Check the amount of water (see the illustration below).

If the water level is too low, the ice cubes will be small.

This is not a problem with the ice maker but of the water pressure in the pipe, and occurs frequently.

When this problem occurs, contact the dealer service center to check the amount of water supplied.

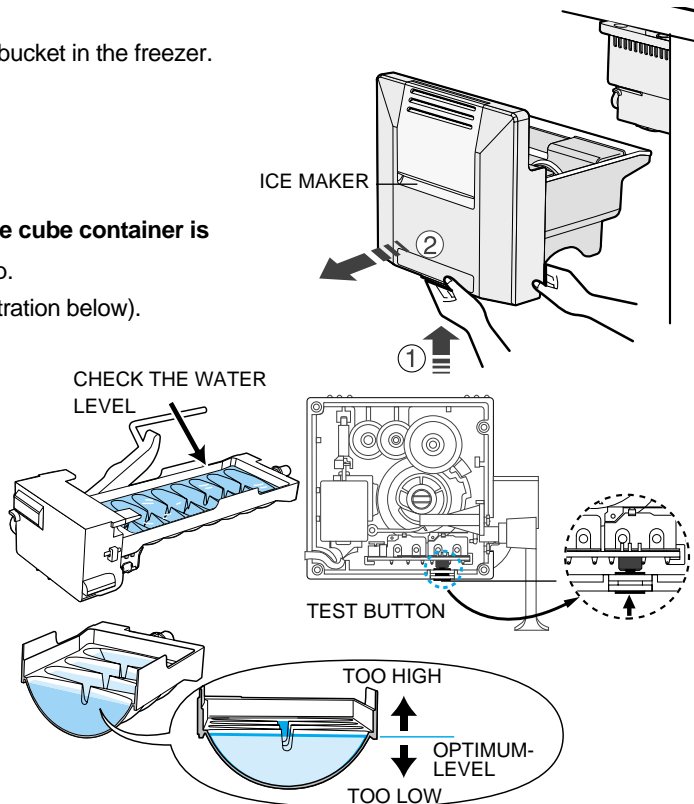

BEFORE YOU CALL FOR SERVICE...

Problem	Possible Causes	What To Do
The refrigerator does not work sufficiently or at all	• Disconnected power plug	• Check that the power plug is properly connected.
	• Is the temperature control on the display panel set to the correct temperature?	• Try setting it to a lower temperature.
	• Is the refrigerator in direct sunlight or located near a heat source?	• Move the refrigerator to the proper location.
	• Is the back of the refrigerator too close to the wall?	
The food in the refrigerator is frozen	• Is the temperature control on the display panel set to the correct temperature?	• Try setting it to a warmer temperature.
	• Is the temperature in the room too low?	
	• Did you store the food with a high water content in the coldest part of the refrigerator.	
Unusual noises or sounds are heard	• Is the back of the refrigerator too near to the wall?	• Check that the floor is levelled and stable. • Move the refrigerator to the proper location.
	• Was anything dropped behind or under the refrigerator?	• Remove the foreign thing.
	• A “ticking” sound may be heard from inside the refrigerator. This is normal and occurs because various accessories contract or expand.	
The front corners and sides of the cabinet are hot; condensation occurs	• HOT-PIPE is installed in the front corners of refrigerator. That makes refrigerator’s temperature low quickly and save the power consumption.	• Normal state
	• Condensation can occur when you leave the door open for a long time.	• Normal state
Ice is not dispensed	• Did you stop the ice making function?	• See the control panel.
	• Is there any ice in the storage unit?	• See the ice container.
	• Is the water pipe connected and the shut-off valve open?	• See the valve.
	• Is the freezer temperature too warm?	• Set the temperature lower.
	• Did you wait for 12 hours after installation of the water supply line before making ice?	
You can hear water bubbling in the refrigerator	• The bubbling comes from the refrigerant circulating in the refrigerator and is normal.	• Normal state
There is a bad smell in the refrigerator	• Wrap strong smelling food so that it is airtight. Throw away any rotten food.	
Frost forms on the wall of the freezer		• Allow sufficient space between stored food for efficient air circulation.
	• Is the air vent blocked?	
	• Is the door closed properly?	
No water is supplied	• Is the water pipe connected and the shut-off valve open?	
	• Is the water supply pipe crushed?	
	• Is the water tank frozen because the refrigerator temperature is too low? Select a warmer setting on the display panel.	

BEFORE YOU CALL FOR SERVICE...

Problem	Possible Causes	What To Do
Small or hollow cubes	Water filter clogged.	• Replace filter cartridge with new cartridge or with plug.
	Door left open.	• Check to see if package is holding door open.
Slow ice cube freezing	Temperature control not set cold enough.	• See about the controls.
	Defrost heater is on.	• This is normal.
Cube dispenser does not work(on some models)	Icemaker turned off or water supply turned off.	• Turn on icemaker or water supply.
	Ice cubes are frozen to icemaker feeler arm.	• Remove cubes and move the feeler arm to the ON position.
	Irregular ice clumps in storage container.	• Break up with fingertip pressure and discard remaining clumps. • Freezer may be too warm. Adjust the freezer control to a colder setting, one position at a time, until clumps do not form.
	Dispenser is LOCKED.	• Press and hold the CHILD LOCK for 3 seconds.
Water has poor taste/odor (on some models)	Water dispenser has not been used for a long time.	• Dispense water until all water in system is replenished.
Water in first glass is warm (on some models)	Normal when refrigerator is first installed.	• Wait 24 hours for the refrigerator to completely cool down.
	Water dispenser has not been used for a long time.	• Dispense water until all water in system is replenished.
	Water system has been drained.	• Allow several hours for replenished supply to chill.
Water dispenser does not work(on some models)	Water supply line turned off or not connected.	• See Installing the water line.
	Water filter clogged.	• Replace filter cartridge or remove filter and install plug.
	Air may be trapped in the water system.	• Press the dispenser arm for at least two minutes.
	Dispenser is LOCKED.	• Press and hold the CHILD LOCK pad for 3 seconds.
Water spurting from dispenser (on some models)	Newly-installed filter cartridge.	• Run water from the dispenser for 3 minutes (about one and a half gallons).
Water is not dispensed (on some models) but icemaker is working	Water in reservoir is frozen.	• Call for service.
	Refrigerator control setting is too cold.	• Set to a warmer setting.
	Ice cubes stuck in icemaker. (Green power light on icemaker blinking).	• Turn off the icemaker, remove cubes, and turn the icemaker back on.
Water on kitchen floor or on bottom of freezer	Drain in the bottom of the freezer clogged.	• See Care and cleaning. • Check the lock of filter.
	Cubes jammed in chute.	• Poke ice through with a wooden spoon.
No water or ice cube production	Supply line or shutoff valve is clogged.	• Call a plumber.
	Water filter clogged.	• Replace filter cartridge or remove filter and install plug.
	Dispenser is LOCKED.	• Press and hold the CHILD LOCK pad for 3 seconds.

Ambient Room Temperature Limits

This fridge/freezer is designed to operate in ambient temperatures specified by its temperature class marked on the rating plate.

Temperature Class	Symbol	Ambient Temperature	
		Maximum	Minimum
Extended Temperate	SN	32°C (90°F)	10°C (50°F)
Temperate	N	32°C (90°F)	16°C (61°F)
Subtropical	ST	38°C (100°F)	18°C (64°F)
Tropical	T	43°C (109°F)	18°C (64°F)

NOTE: Internal temperatures may be affected by such factors as the location of the fridge/freezer, ambient temperature and the frequency with which you open the door. Adjust the temperature as required to compensate for these factors.

English

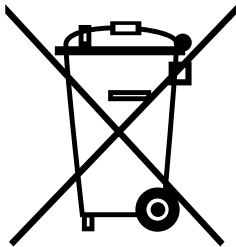

Correct Disposal of This Product (Waste Electrical & Electronic Equipment)

(Applicable in the European Union and other European countries with separate collection systems)

This marking shown on the product or its literature, indicates that it should not be disposed with other household wastes at the end of its working life. To prevent possible harm to the environment or human health from uncontrolled waste disposal, please separate this from other types of wastes and recycle it responsibly to promote the sustainable reuse of material resources.

Household users should contact either the retailer where they purchased this product, or their local government office, for details of where and how they can take this item for environmentally safe recycling.

Business users should contact their supplier and check the terms and conditions of the purchase contract. This product should not be mixed with other commercial wastes for disposal.

MEMO

SAMSUNG

MEMO

The Samsung logo, consisting of the word "SAMSUNG" in a bold, white, sans-serif font, is centered within a gray, horizontally-oriented oval shape.



Free Manuals Download Website

<http://myh66.com>

<http://usermanuals.us>

<http://www.somanuals.com>

<http://www.4manuals.cc>

<http://www.manual-lib.com>

<http://www.404manual.com>

<http://www.luxmanual.com>

<http://aubethermostatmanual.com>

Golf course search by state

<http://golfingnear.com>

Email search by domain

<http://emailbydomain.com>

Auto manuals search

<http://auto.somanuals.com>

TV manuals search

<http://tv.somanuals.com>